

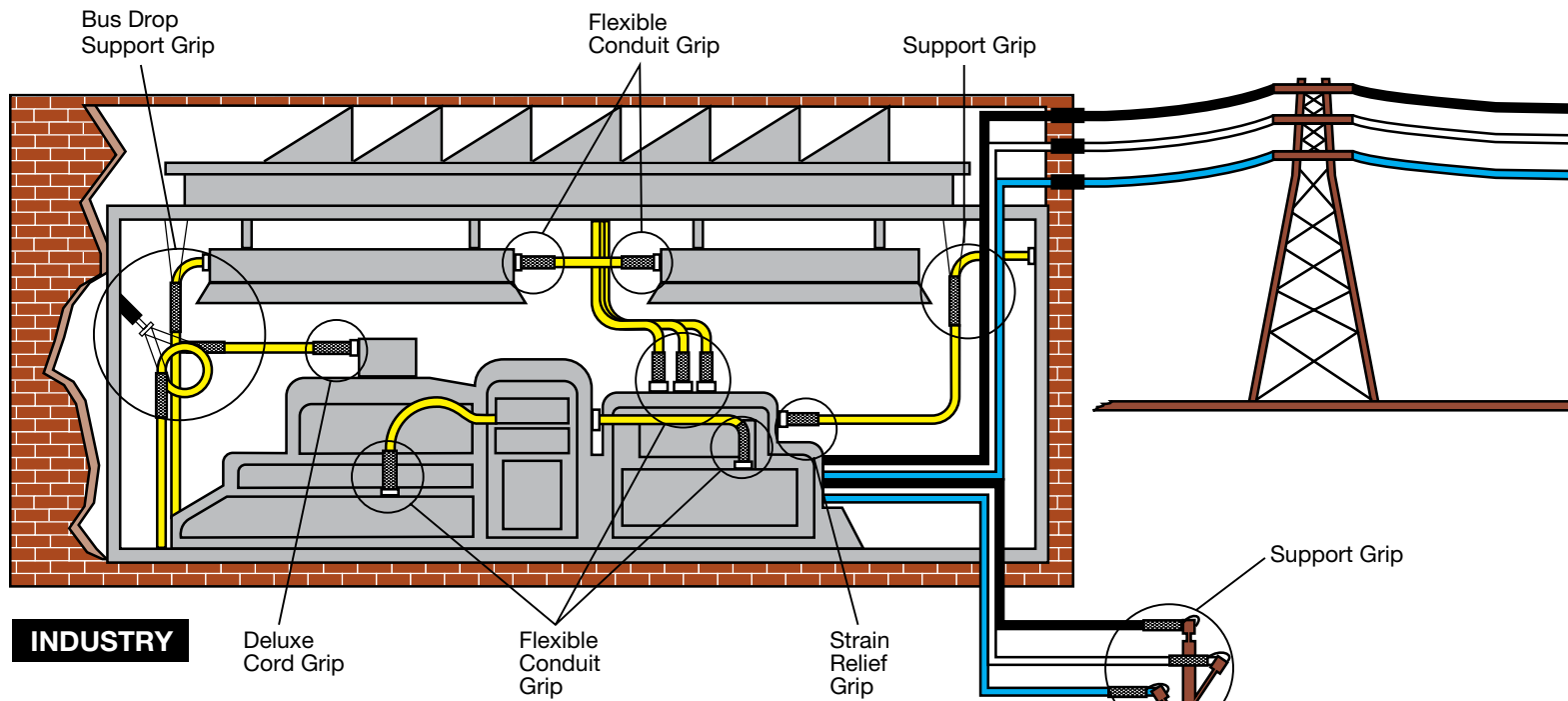

## Index

Product	Page
<b>Kellems® Wire Mesh Grips Diagram</b> . . . . .	V-2
<b>Quick Reference Selection Guide for Grip Applications</b> . . . . .	V-4
<b>Pulling Grips</b> . . . . .	V-5
Overhead DUA-PULL® Pulling Grips . . . . .	V-6
Overhead Multiple Strength Pulling Grips . . . . .	V-7
Underground K-Type Pulling Grips . . . . .	V-8
Underground T-Type Pulling Grips . . . . .	V-9
Special Purpose Pulling Grips . . . . .	V-10
Low Tension Pulling Grips . . . . .	V-12
Wire Rope Splicing Grips . . . . .	V-13
Cable Splicing Grips . . . . .	V-14
Tools, Bands, and Swivels . . . . .	V-15
Technical Information . . . . .	V-17
<b>Support Grips</b> . . . . .	V-27
Standard Duty Support Grips . . . . .	V-30
Heavy Support Grips . . . . .	V-34
Service Drop Grips . . . . .	V-36
Bus Drop Support Grips . . . . .	V-38
Conduit Riser Grips . . . . .	V-39
Technical Information . . . . .	V-41
<b>Fiber Optic Cable Grips</b> . . . . .	V-46
Pulling Grips . . . . .	V-47
Support Grips . . . . .	V-50
Technical Information . . . . .	V-51
<b>Hose Containment Grips</b> . . . . .	V-55
<b>Strain Relief System Selection Chart</b> . . . . .	V-56
Strain Relief Grips for Flexible Cords . . . . .	V-57
Deluxe Cord Grips . . . . .	V-58
PG and Metric Threaded Deluxe Cord Grips . . . . .	V-62
Dust-Tight Strain Relief Grips . . . . .	V-63
I-Grips . . . . .	V-64
Thread Adapters for Multi-Pin Connectors . . . . .	V-65
Strain Relief Grips for Liquidtight Conduit . . . . .	V-66
Technical Information . . . . .	V-69
<b>Cord Connectors</b> . . . . .	V-77
Straight Male Cord Connectors . . . . .	V-78
45° and 90° Male Cord Connectors . . . . .	V-81
Straight Female and Underground Feeder . . . . .	V-82
Low Profile NPT, PG and Metric Thread Connectors . . . . .	V-83
Accessories . . . . .	V-84
Hubbell Juniors® Miniature Nylon Cord Connectors . . . . .	V-85
Technical Information . . . . .	V-87
<b>PolyTuff® Non-Metallic Liquidtight Conduit and Tubing</b> . . . . .	V-98
PolyTuff® Non-Metallic Liquidtight Fittings . . . . .	V-100
Metallic Liquidtight Conduit Fittings . . . . .	V-101
Technical Information . . . . .	V-102





**INDUSTRY**

To help you fully visualize the variety of uses available to you through Hubbell-Kellems Mesh Grips, we have prepared this diagram of common applications. It follows the typical pattern of usage you would find traveling from utility to industrial, commercial and residential environments.

**Pulling Grips** are instrumental in the installations of transmission lines, service lines and cabling for construction and maintenance.

**Support Grips** provide holding management for indoor and outdoor permanent cable installations.

**Strain Relief Grips** are most often used to provide maximum reliability and minimum maintenance in areas where cords on machinery or equipment is impacted by motion or vibration or at risk of damage from cable pullout.

Beyond the electrical applications illustrated here, Hubbell-Kellems Mesh Grips can be used for wire management on radio and microwave communications towers, crane and hoist wire rope maintenance, elevator cable management and more.

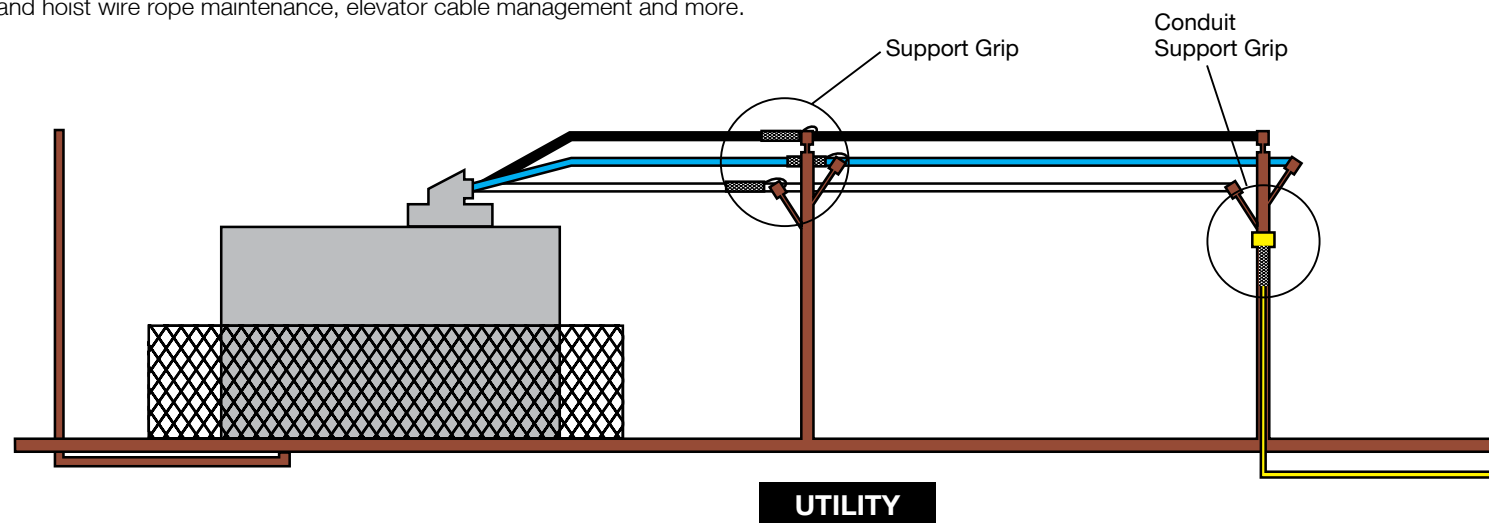
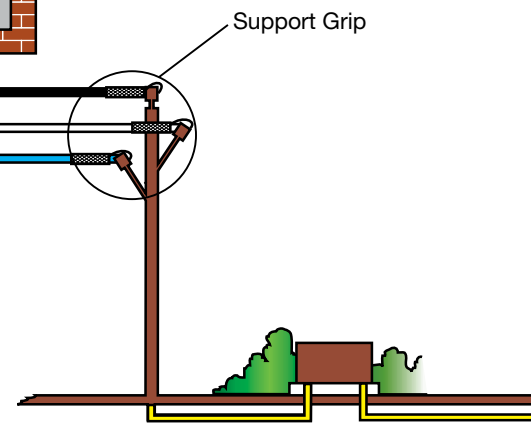

**UTILITY**

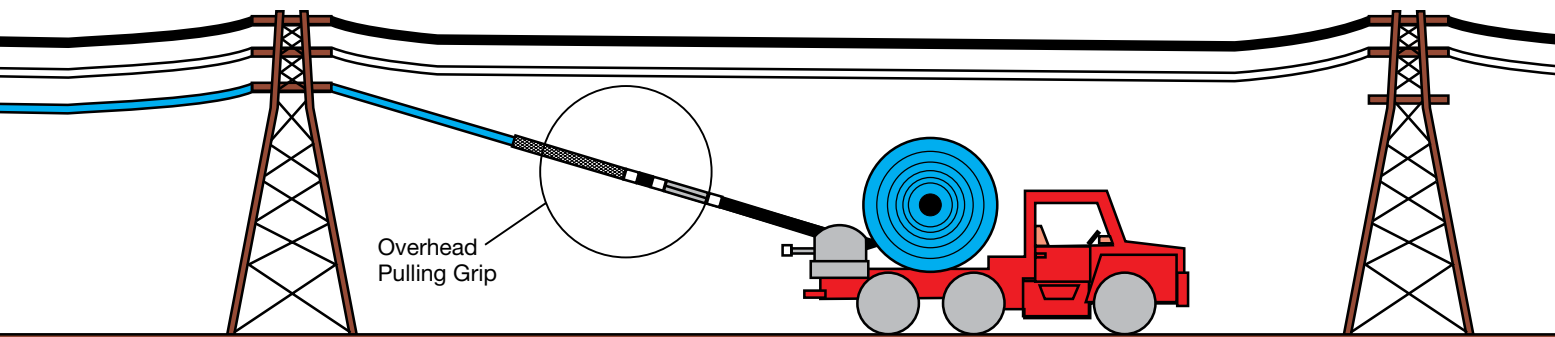

**UTILITY**

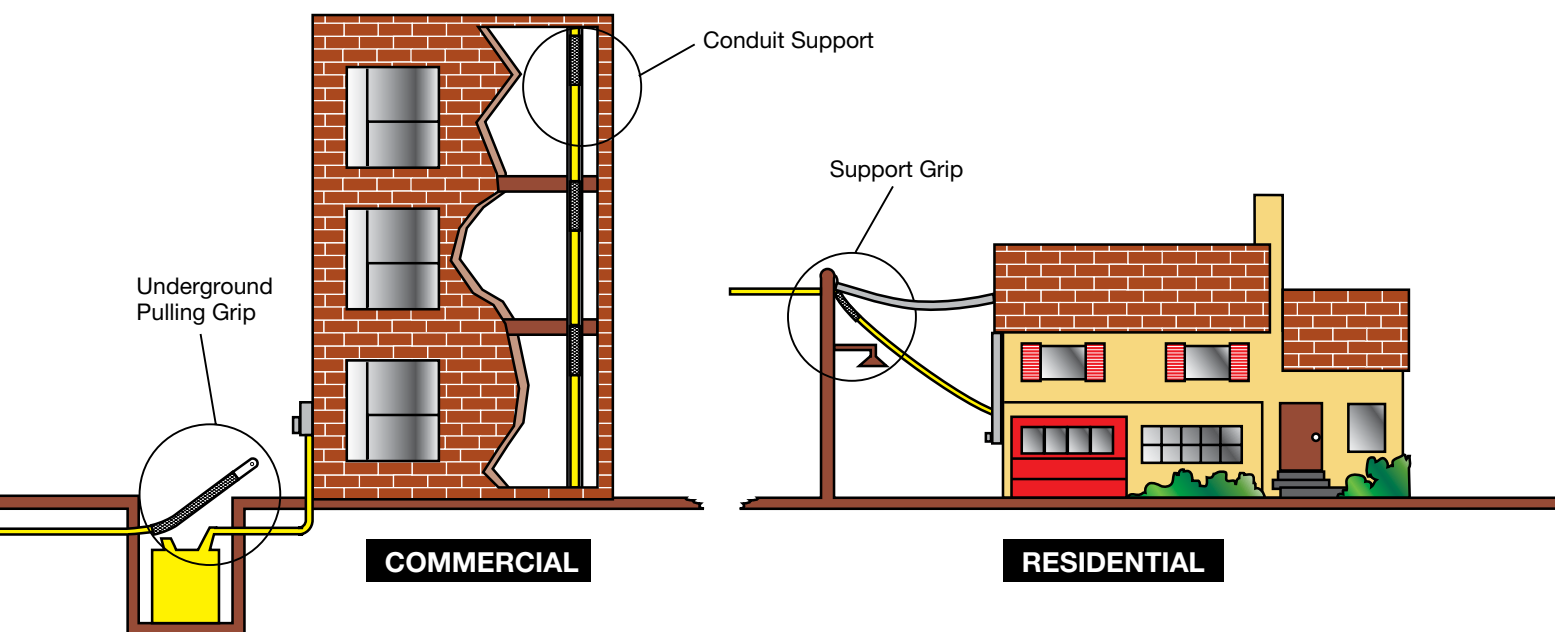
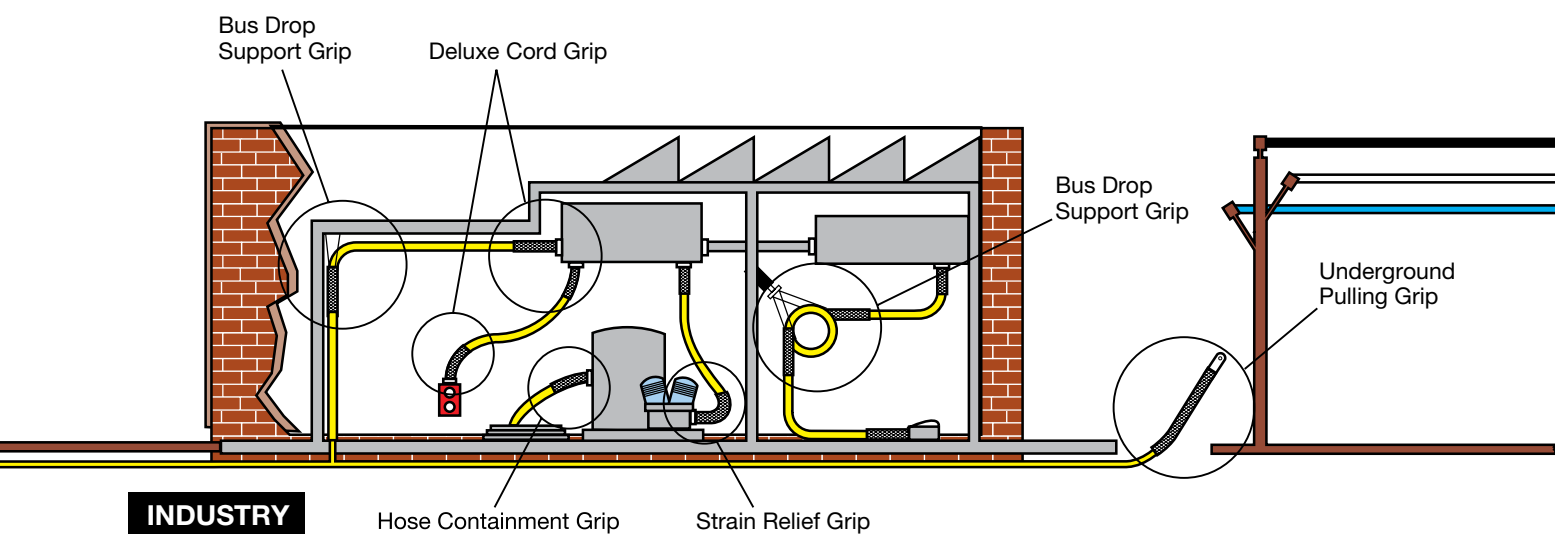



## Pulling Grips

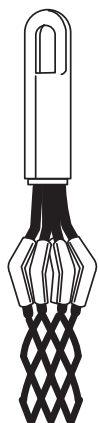

### Heavy-Duty Rotating Eye

For underground wiring and overhead heavy-duty pulling of service lines and new construction cable. See pages V-7 and V-8.

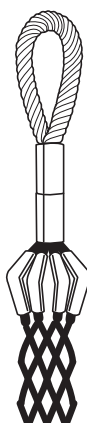

### Heavy-Duty Flexible Eye

For overhead transmission and distribution line stringing. See pages V-6, V-7, and V-9.



### Slack Grips

For removing underground cable and pulling slack in existing cable and new installations and when end of cable is not available. See pages V-10 and V-11.



### Light-Duty Flexible Eye

For light industrial pulling of electrical cable and for underground and industrial plant wiring and re-wiring. See page V-12.

## Support Grips

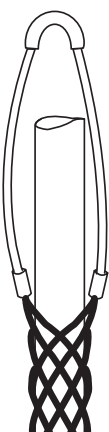

### Single Eye

For single hook attachment of permanent indoor/outdoor cable. Available on heavy-duty, standard duty, and service drop grips. See pages V-28, V-32, and V-34.

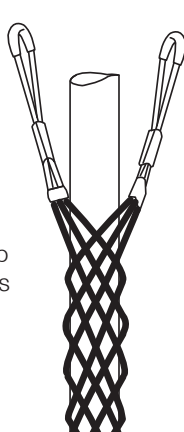

### Double Eye

For double hook attachment of permanent indoor/outdoor cable. Available on heavy-duty and standard duty grips. See pages V-29 and V-33.



### Single Offset Eye

For offset hook attachment of permanent indoor/outdoor cable. Available on standard duty and light-duty support grips. See page V-30.

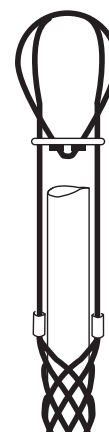

### Universal Eye

Used to fasten around a structure or closed loop. Available on standard duty support and light or heavy duty service drop grips. See pages V-31 and V-35.

## Support Grips



### Wide Range Bus Drop

Used indoors for cable support where flexible cable connects electrical equipment to bus duct. Support air hose and water hose. See page V-36.

## Strain Relief Grips



### Dust-Tight Strain Relief

Indoor use only for wiring of electrical enclosures, machine tools, portable power tools, bus drop cable systems. See page V-63.

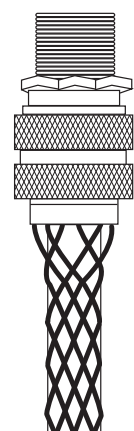

### Deluxe Cord

Indoor or outdoor use where subject to moisture, splash, or washdown. Examples are enclosures, crane hoist and pendant drop stations, hand tools, pumps, and processing equipment. Available in straight, 90°, or 45° configurations. See pages V-58 to V-61.



### Liquid-Tight, Flexible Metal Conduit

Wiring of machine tools, electrical enclosures, motors, and systems subjected to vibration, flexure, motion, or strain. Available in straight, 90°, or 45° configurations. See pages V-66 to V-68.

## Other Specialty Grips

### Splicing Grips

Used as temporary splice for cable and wire rope, or as reinforcement to protect cables and hoses. See pages V-13 and V-14.

### Conduit Riser Grips

Ideal for supporting electrical wires inside rigid conduit via a supporting ring. See pages V-38 to V-40.

### Hose Containment Grips

Used on flexible hose lines to prevent violent whipping of hose in the event of failure at the fitting. See page V-55.

*Specifications are subject to change without notice.*



Flexible or rotating eyes will mate easily with line stringing swivels for attachment to pulling lines; they have great strength for trouble free pulling jobs

Shoulder protectors contain the cable inside the grip and smooth the passage of the grip over line stringing blocks or conduit bends; they protect the leading edge of the grip from abrasion

The galvanized steel mesh grip provides strength for secure pulling jobs and a slim profile with little build-up; it has flexibility to follow cable path

The multiweave styles available add strength for big pulling jobs and provide positive gripping power

Endless weave allows easy installation onto cable. It has a snag-free low profile; designed to be a reusable tool





### DUA-PULL® Grips, Flexible Eye, Double Weave Mesh

DUA-PULL Pulling Grips are the highest strength pulling grips manufactured for overhead transmission line stringing applications. They have a dual function, not provided by any other grip, of working with both bare and insulated conductors and synthetic rope.

**IMPORTANT**  
 Read all breaking strength, safety and technical data relating to this product. Pages V-17 to V-26.

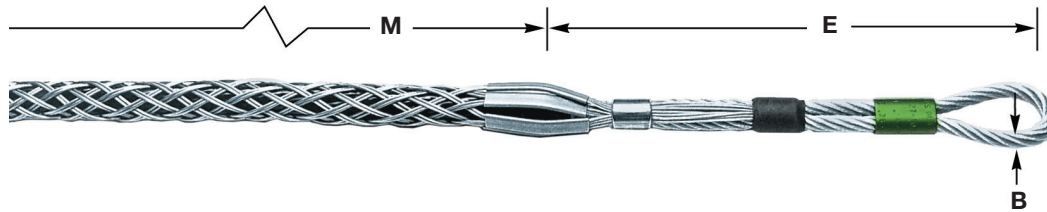

### DUA-PULL® Grips

Diameter Range		Approx. Breaking Strength Lbs. (N)	E Inches (cm)	M Inches (cm)	Eye B Diameter Inches (cm)	Over Cable and Grip** Inches (cm)	Color Code	Catalog Number
Conductor Inches (cm)	Rope* Inches (cm)							
.19"-.37" (48-.94)	.25"-.65" (.63-1.65)	6,500 (28,912)	10" (25.40)	24" (60.96)	.220" (.56)	.200" (.51)	Black	<b>033271037</b>
.38"-.62" (.97-1.57)	.50"-.90" (1.27-2.29)	14,000 (62,272)	12" (30.48)	36" (91.44)	.375" (.95)	.280" (.71)	Dk Green	<b>033271038</b>
.63"-.87" (1.60-2.21)	.75"-1.10" (1.90-2.79)	20,000 (88,960)	13" (33.02)	48" (121.92)	.437" (1.11)	.360" (.91)	Red	<b>033271039</b>
.88"-1.12" (2.24-2.84)	1.00"-1.50" (2.54-3.81)	30,600 (136,109)	15" (38.10)	60" (152.40)	.500" (1.27)	.500" (1.27)	Dk Blue	<b>033271040</b>
1.13"-1.37" (2.87-3.48)	1.25"-1.70" (3.17-4.32)	46,800 (208,166)	18" (45.72)	76" (193.04)	.625" (1.59)	.625" (1.59)	Yellow	<b>033271041</b>
1.38"-1.90" (3.51-4.38)	1.50"-2.10" (3.81-5.33)	66,500 (295,792)	24" (60.96)	89" (226.06)	.750" (1.90)	.750" (1.90)	Aluminum	<b>033271042</b>

Note: E = Eye length. M = Mesh length at nominal diameter.

\*For rope, select smallest size grip which meets required work load.

\*\*Add to cable or rope diameter.

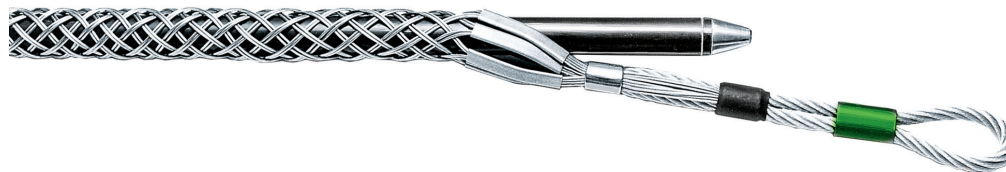

### DUA-PULL® Feed Tube

For Use with DUA- PULL Grip	Rope Diameter Inches (cm)	Feed Tube Length Inches (cm)	Catalog Number
033271037	.25"-.65" (.63-1.65)	28" (71.12)	<b>091061043</b>
033271038	.50"-.90" (1.27-2.29)	40" (101.60)	<b>091061044</b>
033271039	.75"-1.10" (1.90-2.79)	52" (132.08)	<b>091061045</b>
033271040	1.00"-1.50" (2.54-3.81)	67" (170.18)	<b>091061046</b>
033271041	1.25"-1.70" (3.17-4.32)	83" (210.82)	<b>091061047</b>
033271042	1.50"-2.10" (3.81-5.33)	96" (243.84)	<b>091061048</b>



### Multiple Strength Style Grips

Multiple Strength Pulling Grips are designed for pulling aluminum or copper bare conductor, ground wires, messenger strands, wire rope and insulated cables.

### IMPORTANT

Read all breaking strength, safety and technical data relating to this product. Pages V-17 to V-26.



### Multiple Strength Grip-Rotating Eye

Cable Diameter Range Inches (cm)	Approx. Breaking Strength Lbs. (N)	E Inches (cm)	M Inches (cm)	Rotating Eye Dia. Inches (cm)	Color Code	Catalog Number
.25"-.49" (.63-1.24)	6,800 (30,246)	5" (12.70)	26" (66.04)	7/8" (2.22)	Dark Green	<b>03302016</b>
.50"-.74" (1.27-1.88)	10,000 (44,480)	6" (15.24)	32" (81.28)	1" (2.54)	Brown	<b>03302018</b>
.75"-.99" (1.90-2.51)	14,400 (64,051)	6" (15.24)	41" (104.14)	1" (2.54)	Light Blue	<b>03302020</b>
1.00"-1.24" (2.54-3.15)	24,600 (109,420)	8" (20.32)	52" (132.08)	1 1/8" (3.49)	Gold	<b>03302022</b>
1.25"-1.49" (3.17-3.78)	30,600 (136,109)	8" (20.32)	56" (142.24)	1 1/8" (4.13)	Black	<b>03302024</b>
1.50"-1.74" (3.81-4.42)	30,600 (136,109)	9" (22.86)	60" (152.40)	1 1/8" (4.76)	Red	<b>03302026</b>
1.75"-2.24" (4.44-5.69)	48,000 (213,504)	10" (25.40)	70" (177.80)	1 1/8" (4.76)	Dark Blue	<b>03302028</b>
2.00"-2.49" (5.08-6.32)	48,000 (213,504)	10" (25.40)	50" (127.00)	1 1/8" (4.76)	Yellow	<b>03302066</b>
2.50"-2.99" (6.35-7.59)	48,000 (213,504)	10" (25.40)	52" (132.08)	1 1/8" (4.76)	Orange	<b>03302097</b>
3.00"-3.49" (7.62-8.86)	48,000 (213,504)	10" (25.40)	50" (127.00)	1 1/8" (4.76)	Aluminum	<b>033021030</b>
3.50"-3.99" (8.89-10.13)	48,000 (213,504)	10" (25.40)	53" (134.62)	1 1/8" (4.76)	Light Green	<b>033021031</b>

Note: E- Eye length M-Mesh length at nominal diameter.

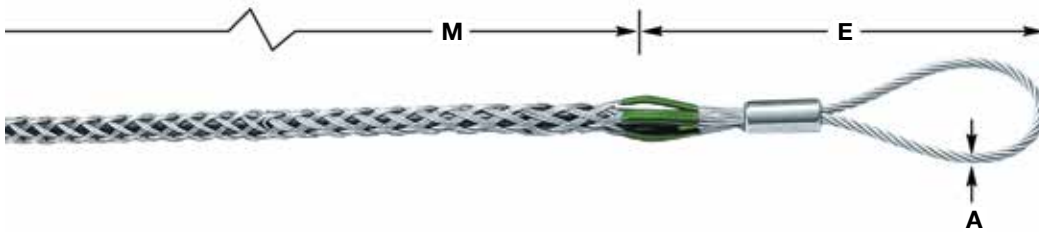

### Multiple Strength Grip-Flexible Eye

Cable Diameter Range Inches (cm)	Approx. Breaking Strength Lbs. (N)	E Inches (cm)	M Inches (cm)	Eye A Dia. Inches (cm)	Color Code	Catalog Number
.25"-.49" (.63-1.24)	6,800 (30,246)	9" (22.86)	26" (66.04)	1/4" (.63)	Dark Green	<b>03302044</b>
.50"-.74" (1.27-1.88)	10,000 (44,480)	9" (22.86)	32" (81.28)	5/16" (.79)	Brown	<b>03302046</b>
.75"-.99" (1.90-2.51)	14,400 (64,051)	11" (27.94)	41" (104.14)	3/8" (.95)	Light Blue	<b>03302048</b>
1.00"-1.24" (2.54-3.15)	24,600 (109,420)	12" (30.48)	52" (132.08)	1/2" (1.27)	Gold	<b>03302050</b>
1.25"-1.49" (3.17-3.78)	30,600 (136,109)	12" (30.48)	56" (142.24)	1/2" (1.27)	Black	<b>03302052</b>
1.50"-1.74" (3.81-4.42)	30,600 (136,109)	12" (30.48)	60" (152.40)	1/2" (1.27)	Red	<b>03302054</b>
1.75"-2.24" (4.44-5.69)	48,000 (213,504)	18" (45.72)	70" (177.80)	5/8" (1.59)	Dark Blue	<b>03302056</b>
2.00"-2.49" (5.08-6.32)	48,000 (213,504)	18" (45.72)	50" (127.00)	5/8" (1.59)	Yellow	<b>033021078</b>
2.50"-2.99" (6.35-7.59)	48,000 (213,504)	18" (45.72)	52" (132.08)	5/8" (1.59)	Orange	<b>033021079</b>
3.00"-3.49" (7.62-8.86)	48,000 (213,504)	18" (45.72)	50" (127.00)	5/8" (1.59)	Aluminum	<b>033021080</b>
3.50"-3.99" (8.89-10.13)	48,000 (213,504)	18" (45.72)	53" (134.62)	5/8" (1.59)	Light Green	<b>033021081</b>

Note: E- Eye length. M-Mesh length at nominal diameter.



## K-Type Grips

Kellems® Rotating Eye, K-Type Pulling Grips are made of high strength galvanized steel strand. All Grips feature double weave mesh for greater strength and added mesh contact on the table, to handle longer or heavier pulling jobs. The forged eye mates easily with a swivel or shackle.

**IMPORTANT**  
 Read all breaking strength, safety and technical data relating to this product. Pages V-17 to V-26.



## K-Type Grips

Cable Diameter Range Inches (cm)	Approx. Breaking Strength Lbs. (N)	E Inches (cm)	M Inches (cm)	Rotating Eye Dia. Inches (cm)	Catalog Number
<b>Short</b>					
.50"-.62" (1.27-1.57)	5,600 (24,909)	5" (12.70)	11" (27.94)	7/8" (2.22)	<b>03301001</b>
.63"-.74" (1.60-1.88)	6,800 (30,246)	5" (12.70)	11" (27.94)	7/8" (2.22)	<b>03301002</b>
.75"-.99" (1.90-2.51)	6,800 (30,246)	6" (15.24)	20" (50.80)	1" (2.54)	<b>03301013</b>
1.00"-1.24" (2.54-3.15)	12,800 (56,934)	7" (17.78)	20" (50.80)	1 1/8" (3.49)	<b>03301014</b>
1.25"-1.49" (3.17-3.78)	12,800 (56,934)	7" (17.78)	21" (53.34)	1 1/8" (3.49)	<b>03301016</b>
1.50"-1.99" (3.81-5.05)	16,400 (72,941)	7" (17.78)	25" (63.50)	1 1/8" (3.49)	<b>03301017</b>
2.00"-2.49" (5.08-6.32)	27,200 (120,986)	8" (20.32)	26" (66.04)	1 5/8" (4.13)	<b>03301018</b>
2.50"-2.99" (6.35-7.59)	33,000 (146,784)	10" (25.40)	28" (71.12)	1 7/8" (4.76)	<b>03301019</b>
3.00"-3.49" (7.62-8.86)	41,000 (182,368)	10" (25.40)	30" (76.20)	1 7/8" (4.76)	<b>03301020</b>
3.50"-3.99" (8.89-10.13)	48,000 (213,504)	10" (25.40)	32" (81.28)	1 7/8" (4.76)	<b>03301021</b>
4.00"-4.49" (10.16-11.40)	48,000 (213,504)	10" (25.40)	33" (83.82)	1 7/8" (4.76)	<b>033011017</b>
<b>Standard</b>					
.50"-.62" (1.27-1.57)	5,600 (24,909)	5" (12.70)	16" (40.64)	7/8" (2.22)	<b>03301011</b>
.63"-.74" (1.60-1.88)	6,800 (30,246)	5" (12.70)	16" (40.64)	7/8" (2.22)	<b>03301012</b>
.75"-.99" (1.90-2.51)	9,600 (42,701)	6" (15.24)	32" (81.28)	1" (2.54)	<b>03301024</b>
1.00"-1.49" (2.54-3.78)	16,400 (72,947)	7" (17.78)	33" (83.82)	1 1/8" (3.49)	<b>03301025</b>
1.50"-1.99" (3.81-5.05)	16,400 (72,947)	7" (17.78)	34" (86.36)	1 1/8" (3.49)	<b>03301026</b>
2.00"-2.49" (5.08-6.32)	27,200 (120,986)	9" (22.86)	36" (91.44)	1 5/8" (4.13)	<b>03301027</b>
2.50"-2.99" (6.35-7.59)	33,000 (146,784)	10" (25.40)	38" (96.52)	1 7/8" (4.76)	<b>03301028</b>
3.00"-3.49" (7.62-8.86)	41,000 (182,368)	10" (25.40)	39" (99.06)	1 7/8" (4.76)	<b>03301029</b>
3.50"-3.99" (8.89-10.13)	48,000 (213,504)	10" (25.40)	41" (104.14)	1 7/8" (4.76)	<b>03301030</b>
4.00"-4.49" (10.16-11.40)	48,000 (213,504)	10" (25.40)	42" (106.68)	1 7/8" (4.76)	<b>03301031</b>
4.50"-4.99" (11.43-12.67)	48,000 (213,504)	10" (25.40)	58" (147.32)	1 7/8" (4.76)	<b>03301039</b>
5.00"-5.99" (12.70-15.21)	40,000 (177,920)	10" (25.40)	60" (152.40)	1 7/8" (4.76)	<b>03301047</b>
6.00"-6.99" (15.24-17.75)	48,000 (213,504)	10" (25.40)	66" (167.64)	1 7/8" (4.76)	<b>03301045</b>

Note: E- Eye length. M-Mesh length at nominal diameter.  
 See page V-25 for multiple cables in a single pulling grip.





### T-Type Grips

Kellems® Flexible T-Type Pulling Grips are made of high strength galvanized steel strand. They feature double weave mesh for positive holding power in medium to heavy pulling jobs. The grip eye will easily attach to a swivel.

### IMPORTANT

Read all breaking strength, safety and technical data relating to this product. Pages V-17 to V-26.

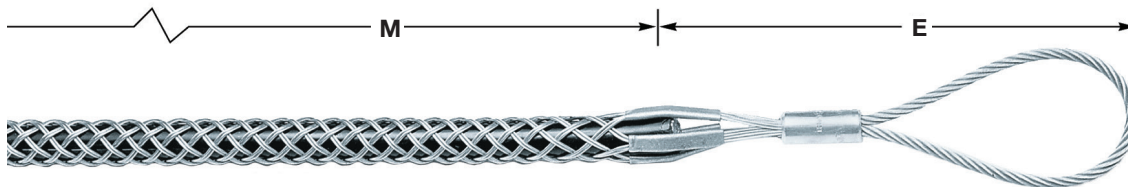

### T-Type Grips

Cable Diameter Range Inches (cm)	Approx. Breaking Strength Lbs. (N)	E Inches (cm)	M Inches (cm)	Catalog Number
<b>Short</b>				
.50"-.62" (1.27-1.57)	4,500 (20,016)	8" (20.32)	21" (53.34)	<b>033041082</b>
.63"-.74" (1.60-1.88)	5,600 (24,909)	8" (20.32)	24" (60.96)	<b>033041083</b>
.75"-.99" (1.90-2.51)	6,800 (30,246)	9" (22.86)	24" (60.96)	<b>033041084</b>
1.00"-1.49" (2.54-3.78)	9,600 (42,701)	9" (22.86)	24" (60.96)	<b>033041085</b>
1.50"-1.99" (3.81-5.05)	16,400 (72,947)	11" (27.94)	24" (60.96)	<b>033041086</b>
2.00"-2.49" (5.08-6.32)	18,500 (82,288)	12" (30.48)	24" (60.96)	<b>033041087</b>
2.50"-2.99" (6.35-7.59)	24,500 (108,976)	12" (30.48)	24" (60.96)	<b>033041088</b>
3.00"-3.49" (7.62-8.86)	24,500 (108,976)	14" (35.56)	24" (60.96)	<b>033041089</b>
3.50"-3.99" (8.89-10.13)	31,000 (137,888)	14" (35.56)	26" (66.04)	<b>033041090</b>
<b>Standard</b>				
.75"-.99" (1.90-2.51)	6,800 (30,246)	9" (22.86)	36" (91.44)	<b>033041091</b>
1.00"-1.49" (2.54-3.78)	9,600 (42,701)	9" (22.86)	36" (91.44)	<b>033041092</b>
1.50"-1.99" (3.81-5.05)	16,400 (72,947)	11" (27.94)	36" (91.44)	<b>033041093</b>
2.00"-2.49" (5.08-6.32)	18,500 (82,288)	12" (30.48)	36" (91.44)	<b>033041094</b>
2.50"-2.99" (6.35-7.59)	24,500 (108,976)	12" (30.48)	36" (91.44)	<b>033041095</b>
3.00"-3.49" (7.62-8.86)	24,500 (108,976)	14" (35.56)	36" (91.44)	<b>033041096</b>
3.50"-3.99" (8.89-10.13)	31,000 (137,888)	14" (35.56)	40" (101.60)	<b>033041097</b>

Note: E- Eye length. M-Mesh length at nominal diameter.  
 See page V-25 for multiple cables in a single pulling grip.



### Non-Conductive Grips

Kellems® Non-Conductive Pulling Grips, made of a high strength, non-conductive aramid fiber, are available for pulling single cable or cable bundles. Their braided double weave design adds strength and positive holding power.

**IMPORTANT**  
 Read all breaking strength, safety and technical data relating to this product. Pages V-17 to V-26.

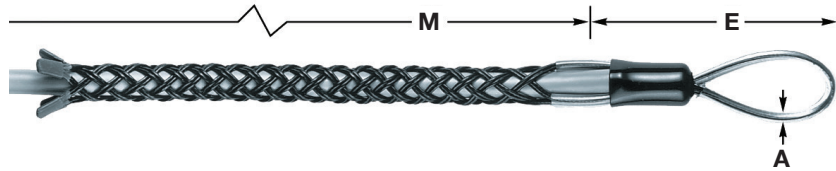

### Non-Conductive Grips, Single Eye, Double Weave, Non-Metallic

Cable Diameter Range Inches (cm)	Approx. Breaking Strength Lbs. (N)	E Inches (cm)	M Inches (cm)	A Inches (cm)	Color Code	Catalog Number
.50"-.62" (1.27-1.57)	4,000 (17,792)	5.5" (13.97)	24" (60.96)	.44" (1.12)	Green	<b>03628001</b>
.63"-.74" (1.60-1.88)	5,000 (22,240)	5.5" (13.97)	26" (66.04)	.44" (1.12)	Yellow	<b>03628002</b>
.75"-.99" (1.90-2.51)	6,000 (26,688)	6.0" (15.24)	31" (78.74)	.63" (1.60)	Red	<b>03628003</b>
1.00"-1.24" (2.54-3.15)	6,000 (26,688)	6.5" (16.51)	36" (91.44)	.63" (1.60)	Blue	<b>03628004</b>
1.25"-1.49" (3.17-3.78)	6,000 (26,688)	6.7" (17.02)	41.5" (105.41)	.63" (1.60)	White	<b>03628005</b>
1.50"-1.99" (3.815-05)	6,000 (26,688)	8.0" (20.32)	44.0" (121.76)	.63" (1.60)	Pink	<b>03628006</b>

### Slack Pulling Grips

Slack Pulling Grips are offered in three styles made of galvanized steel. The closed type is used when the cable end is accessible. When not accessible, there are split lace and split rod closing styles. All grips feature a single offset eye for easy attachment to a pulling line.

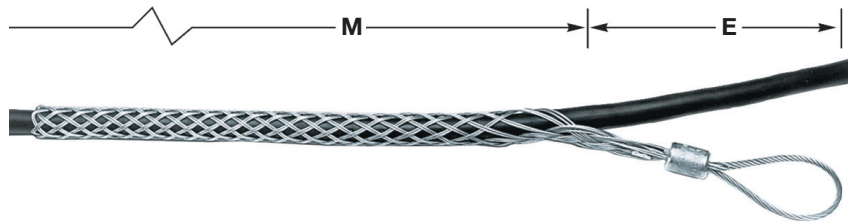

### Slack Grip-Closed Mesh, Offset Eye, Double Weave, Galvanized Steel

Cable Diameter Range Inches (cm)	Approx. Breaking Strength Lbs. (N)	E Inches (cm)	M Inches (cm)	Catalog Number
<b>Standard</b>				
.75"-.99" (1.90-2.51)	2,600 (11,565)	7" (17.78)	12" (30.48)	<b>03308003</b>
1.00"-1.24" (2.54-3.15)	4,000 (17,792)	8" (20.32)	15" (38.10)	<b>03308004</b>
1.25"-1.49" (3.17-3.78)	5,400 (24,019)	8" (20.32)	16" (40.64)	<b>03308005</b>
1.50"-1.74" (3.81-4.42)	6,600 (29,357)	8" (20.32)	20" (50.80)	<b>03308006</b>
1.75"-1.99" (4.44-5.05)	10,000 (44,480)	10" (25.40)	18" (45.72)	<b>03308007</b>
2.00"-2.49" (5.08-6.32)	11,000 (48,928)	10" (25.40)	19" (48.26)	<b>03308008</b>
2.50"-2.99" (6.35-7.59)	11,000 (48,928)	10" (25.40)	20" (50.80)	<b>03308009</b>
3.00"-3.49" (7.62-8.86)	14,500 (64,496)	12" (30.48)	21" (53.34)	<b>03308010</b>
3.50"-3.99" (8.89-10.13)	14,500 (64,496)	12" (30.48)	22" (55.88)	<b>03308011</b>

Note: E- Eye length. M-Mesh length at nominal diameter.  
 See page V-25 for multiple cables in a single pulling grip.

### Slack Pulling Grips

Slack Pulling Grips are offered in three styles made of galvanized steel. The closed type is used when the cable end is accessible. When not accessible, there are split lace and split rod closing styles. All grips feature a single offset eye for easy attachment to a pulling line.

**IMPORTANT**  
 Read all breaking strength, safety and technical data relating to this product. Pages V-17 to V-26.

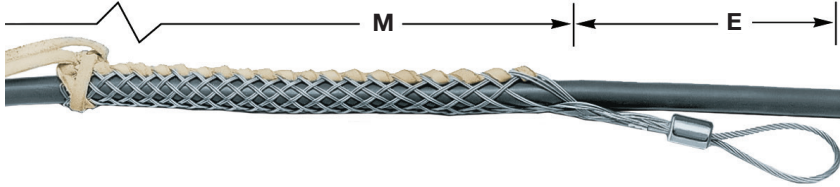

#### Slack Grip-Split Mesh, Rawhide Lace Closing, Offset Eye, Double Weave, Galvanized Steel

Cable Diameter Range Inches (cm)	Approx. Breaking Strength Lbs. (N)	E Inches (cm)	M Inches (cm)	Catalog Number
<b>Standard</b>				
.75"-1.99" (1.90-2.51)	2,500 (11,120)	7" (17.78)	12" (30.48)	<b>03309003</b>
1.00"-1.24" (2.54-3.15)	3,500 (15,568)	8" (20.32)	15" (38.10)	<b>03309004</b>
1.25"-1.49" (3.17-3.78)	4,000 (17,792)	8" (20.32)	16" (40.64)	<b>03309005</b>
1.50"-1.74" (3.81-4.42)	4,000 (17,792)	9" (22.86)	17" (43.18)	<b>03309006</b>
1.75"-1.99" (4.44-5.05)	4,000 (17,792)	10" (25.40)	18" (45.72)	<b>03309007</b>
2.00"-2.49" (5.08-6.32)	4,000 (17,792)	10" (25.40)	19" (48.26)	<b>03309008</b>
2.50"-2.99" (6.35-7.59)	4,000 (17,792)	10" (25.40)	20" (50.80)	<b>03309009</b>
<b>Long</b>				
1.50"-1.99" (3.81-5.05)	4,000 (17,792)	9" (22.86)	25" (63.50)	<b>03309015</b>
2.00"-2.49" (5.08-6.32)	4,000 (17,792)	10" (25.40)	26" (66.04)	<b>03309016</b>
2.50"-2.99" (6.35-7.59)	4,000 (17,792)	10" (25.40)	29" (73.66)	<b>03309017</b>
3.00"-3.49" (7.62-8.86)	4,000 (17,792)	12" (30.48)	32" (81.28)	<b>03309018</b>
3.50"-3.99" (8.89-10.13)	4,000 (17,792)	12" (30.48)	35" (88.90)	<b>03309019</b>

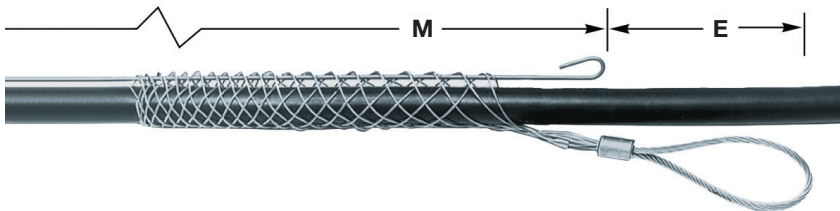

#### Slack Grip-Split Mesh, Rod Closing, Offset Eye, Single Weave, Galvanized Steel

Cable Diameter Range Inches (cm)	Approx. Breaking Strength Lbs. (N)	E Inches (cm)	M Inches (cm)	Catalog Number
.50"-1.61" (1.27-1.55)	1,500 (6,672)	7" (17.78)	6" (15.24)	<b>03310001</b>
.62"-1.74" (1.57-1.88)	1,800 (8,006)	7" (17.78)	8" (20.32)	<b>03310002</b>
.75"-1.99" (1.90-2.51)	2,200 (9,786)	7" (17.78)	10" (25.40)	<b>03310003</b>
1.00"-1.24" (2.54-3.15)	3,400 (15,123)	8" (20.32)	12" (30.48)	<b>03310004</b>
1.25"-1.49" (3.17-3.78)	4,500 (20,016)	8" (20.32)	14" (35.56)	<b>03310005</b>
1.50"-1.74" (3.81-4.42)	5,800 (25,798)	9" (22.86)	15" (38.10)	<b>03310006</b>
1.75"-1.99" (4.44-5.05)	7,600 (33,805)	10" (25.40)	16" (40.64)	<b>03310007</b>
2.00"-2.49" (5.08-6.32)	9,000 (40,032)	10" (25.40)	19" (48.26)	<b>03310008</b>
2.50"-2.99" (6.35-7.59)	11,000 (48,928)	10" (25.40)	20" (50.80)	<b>03310009</b>
3.00"-3.49" (7.62-8.86)	12,000 (53,376)	12" (30.48)	21" (53.34)	<b>03310010</b>
3.50"-3.99" (8.89-10.13)	12,000 (53,376)	12" (30.48)	24" (60.96)	<b>03310011</b>

Note: E- Eye length. M-Mesh length at nominal diameter.  
 See page V-25 for multiple cables in a single pulling grip.



**Light Duty Grips**

Light Duty Grips are made of galvanized steel in a single weave construction. They feature a flexible eye for easy attachment to a pulling line.

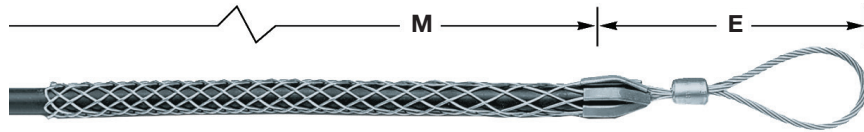

**IMPORTANT**

Read all breaking strength, safety and technical data relating to this product. Pages V-17 to V-26.

**Light Duty Grips**

Cable Diameter Range Inches (cm)	Approx. Breaking Strength Lbs. (N)	E Inches (cm)	M Inches (cm)	Catalog Number
<b>Short</b>				
.50"-.62" (1.27-1.57)	2,800 (12,454)	5" (12.70)	11" (27.94)	<b>03303001</b>
.63"-.74" (1.60-1.88)	2,800 (12,454)	5" (12.70)	11" (27.94)	<b>03303002</b>
.75"-.99" (1.90-2.51)	4,000 (17,792)	6" (15.24)	12" (30.48)	<b>03303003</b>
1.00"-1.24" (2.54-3.15)	5,300 (23,574)	7" (17.78)	13" (33.02)	<b>03303004</b>
1.25"-1.49" (3.17-3.78)	5,300 (23,574)	7" (17.78)	14" (35.56)	<b>03303005</b>
1.50"-1.74" (3.81-4.42)	6,800 (30,246)	8" (20.32)	15" (38.10)	<b>03303006</b>
1.75"-1.99" (4.44-5.05)	8,500 (37,808)	9" (22.86)	17" (43.18)	<b>03303007</b>
2.00"-2.49" (5.08-6.32)	8,500 (37,808)	9" (22.86)	18" (45.72)	<b>03303008</b>
<b>Standard</b>				
.50"-.62" (1.27-1.57)	2,800 (12,454)	5" (12.70)	16" (40.64)	<b>03303010</b>
.63"-.74" (1.60-1.88)	2,800 (12,454)	5" (12.70)	16" (40.64)	<b>03303011</b>
.75"-.99" (1.90-2.51)	4,000 (17,792)	6" (15.24)	20" (50.80)	<b>03303012</b>
1.00"-1.24" (2.54-3.15)	6,800 (30,246)	7" (17.78)	20" (50.80)	<b>03303013</b>
1.25"-1.49" (3.17-3.78)	6,800 (30,246)	7" (17.78)	21" (53.34)	<b>03303015</b>
1.50"-1.99" (3.81-5.05)	6,800 (30,246)	8" (20.32)	23" (58.42)	<b>03303016</b>
2.00"-2.49" (5.08-6.32)	8,500 (37,808)	9" (22.86)	25" (63.50)	<b>03303017</b>
2.50"-2.99" (6.35-7.59)	10,600 (47,149)	9" (22.86)	27" (68.58)	<b>03303018</b>
3.00"-3.49" (7.62-8.86)	14,700 (65,386)	10" (25.40)	30" (76.20)	<b>03303019</b>
3.50"-3.99" (8.89-10.13)	14,700 (65,386)	10" (25.40)	32" (81.28)	<b>03303029</b>

**Junior Pulling Grips**

Junior Pulling Grips feature a strong galvanized steel, single weave mesh. A flexible eye easily attaches to a pulling line, snake or fish tape.

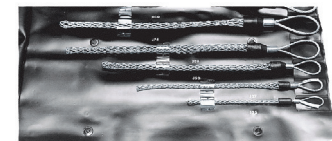
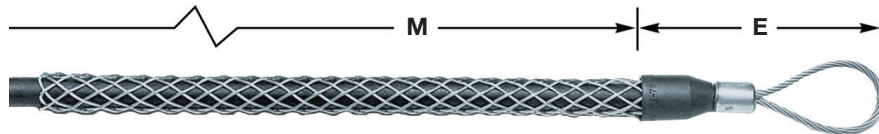

**033051114**

**Junior Pulling Grips**

Cable Diameter Range Inches (cm)	Approx. Breaking Strength Lbs. (N)	E Inches (cm)	M Inches (cm)	Model	Catalog Number
.19"-.24" (.48-.61)	400 (1,779)	3¼" (8.25)	4¼" (10.79)	J19	<b>03305011*</b>
.25"-.37" (.63-.94)	450 (2,002)	3¼" (8.25)	4¼" (10.79)	J25	<b>03305001</b>
.38"-.49" (.97-1.24)	900 (4,003)	3¾" (9.52)	7" (17.78)	J37	<b>03305002</b>
.50"-.62" (1.27-1.57)	1,300 (5,782)	4¼" (10.79)	8½" (21.59)	J50	<b>03305003</b>
.63"-.74" (1.60-1.88)	1,950 (8,674)	5" (12.70)	10" (25.40)	J62	<b>03305004</b>
.75"-.99" (1.90-2.51)	2,800 (12,454)	5¾" (14.60)	10" (25.40)	J75	<b>03305005</b>
1.00"-1.24" (2.54-3.15)	3,900 (17,347)	6½" (16.51)	11½" (29.21)	J100	<b>03305006</b>
Junior Grip Kit contains 6 grips, one of each size above, except 03305011.					<b>033051114</b>

Note: E- Eye length. M-Mesh length at nominal diameter.

\*Not included in Junior Grip Kit, 033051114.

Note: See page V-25 for multiple cables in a single pulling grip.

See page V-26 for building wire selection chart.



**Kellems® Wire Rope Grips**

Wire Rope Grips are made of high strength galvanized steel strand in a construction of triple, double and single weave for superior gripping ability. They are available with or without a rotating barrel which will help eliminate twist in the old rope from being transferred to the new rope.

**IMPORTANT**  
Read all breaking strength, safety and technical data relating to this product. Pages V-17 to V-26.



**Regular Wire Rope Grips**

Cable Diameter Range Inches (cm)	Approx. Breaking Strength Lbs. (N)	Approx. Strength of Grip Feet (m)	Catalog Number
5/16" - 5/8" (1.43-1.59)	7,500 (33,360)	5.75 (1.75)	<b>03316001</b>
3/4" - 7/8" (1.90-2.22)	12,500 (55,600)	6.75 (1.90)	<b>03316002</b>
1" - 1 1/8" (2.54-2.86)	16,000 (71,168)	7.00 (2.13)	<b>03316003</b>
1 1/4" - 1 3/8" (3.17-3.49)	20,000 (88,960)	8.00 (2.44)	<b>03316004</b>
1 5/8" - 1 1/2" (3.49-3.81)	20,000 (88,960)	8.00 (2.44)	<b>03316006</b>



**Rotating Wire Rope Grips**

Cable Diameter Range Inches (cm)	Approx. Breaking Strength Lbs. (N)	Approx. Strength of Grip Feet (m)	Barrel Dimensions Length. x O.D. In. (cm)	Catalog Number
7/16" - 1/2" (1.11-1.27)	5,000 (22,240)	5.33 (1.63)	3.00" (7.62) x .87" (2.21)	<b>03317001</b>
5/16" - 5/8" (1.43-1.59)	7,500 (33,360)	5.83 (1.78)	4.25" (10.79) x 1.00" (2.54)	<b>03317002</b>
3/4" - 7/8" (1.90-2.22)	12,500 (55,600)	6.50 (1.98)	4.25" (10.79) x 1.00" (2.54)	<b>03317003</b>
1" - 1 1/8" (2.54-2.86)	16,000 (71,168)	8.67 (2.64)	5.50" (13.97) x 1.37" (3.48)	<b>03317004</b>
1 1/4" - 1 3/8" (3.17-3.49)	20,000 (88,960)	9.00 (2.74)	5.50" (13.97) x 1.37" (3.48)	<b>03317005</b>
1 1/2" - 1 3/4" (3.81-4.44)	20,000 (88,960)	11.00 (3.35)	5.50" (13.97) x 1.37" (3.48)	<b>03317006</b>



**Splicing Grips**

Splicing Grips are made of galvanized steel in double weave mesh construction. They are available in various lengths and sizes to suit most applications.

**IMPORTANT**  
Read all breaking strength, safety and technical data relating to this product. Pages V-17 to V-26.



**Double Weave Tube**

Cable Diameter Range Inches (cm)	.37"-.49" (.94-1.24)	.50"-.61" (1.27-1.55)	.62"-.74" (1.57-1.88)	.75"-.99" (1.90-2.51)	1.00"-1.49" (2.54-3.78)
Approx. Breaking Strength Lbs. (N)	3,500 (15,568)	3,500 (15,568)	4,400 (19,571)	7,500 (33,360)	10,000 (44,480)
Mesh Length Inches (cm)	Catalog Number				
18" (45.72)	<b>013041330</b>	<b>01304064</b>	<b>01304009</b>	—	—
24" (60.96)	—	<b>01304011</b>	<b>01304013</b>	<b>01304010</b>	<b>01304015</b>
36" (91.44)	—	—	<b>013041234</b>	<b>01304054</b>	<b>01304055</b>
48" (121.92)	—	—	—	<b>01304017</b>	<b>01304029</b>
72" (182.88)	—	—	—	<b>01304037</b>	<b>013041333</b>

**Junior Splicing Grips, Single Weave**

Junior Splicing Grips are made of galvanized steel and are designed for use in very light duty and small splicing jobs.

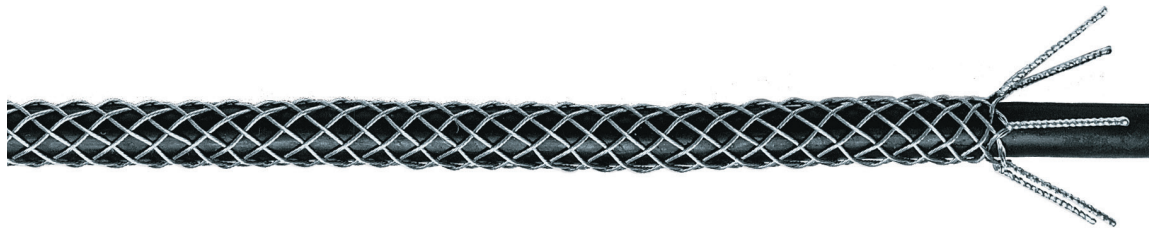

**Junior Tube**

Cable Diameter Range Inches (cm)	Approx. Breaking Strength Lbs. (N)	Length @ Nom Diameter Inches (cm)	Catalog Number
.18"-.24" (.46-.61)	400 (1,779)	7" (17.78)	<b>01301008</b>
.25"-.36" (.63-.91)	400 (1,779)	8" (20.32)	<b>01301013</b>

## Punch-Lok® Bands

Punch-Lok Bands are applied over the tail of a grip to prevent the mesh from being tripped or pulled loose. Also, they assure full gripping action by locking the mesh of the tail in tight contact with the cable or rope.

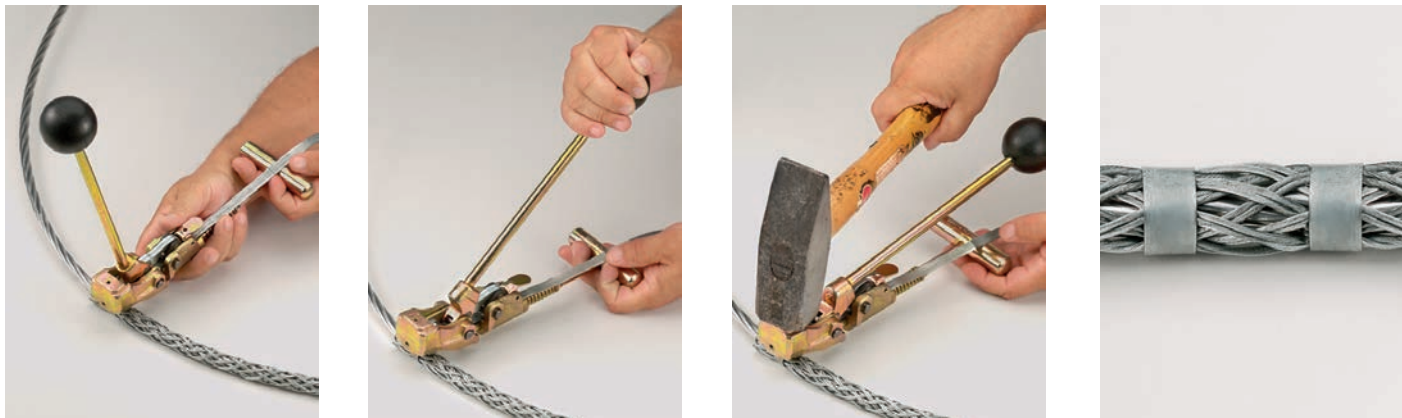

When the tail of a grip is the leading end, the bands are particularly important to prevent accidental release caused by tripping on obstructions. A conductor-to-conductor (double-socking) pulling operation is a good example: where two grips connect two conductors to form a temporary splice. Bands should be applied to the ends of the grips as illustrated herein. It is also common practice to tape over the banded tail area to assure smooth passage through the sheaves.

The conductor should be installed in the grip up to the elbows of the aluminum shoulders in order to assure full and complete gripping action as illustrated above.

## Punch-Lok® Bands

Grip Banding Range Inches (cm)	Band Width Inches (cm)	Band Inside Diameter Inches (cm)	Model	Catalog Number
¼"-1½" (.63-2.86)	¾" (.95)	1¾" (3.49)	0-311	<b>20320050</b>
1½"-1½" (2.86-4.13)	¾" (.95)	2" (5.08)	0-316	<b>20320051</b>
1½"-2¼" (4.13-5.71)	¾" (1.59)	2½" (6.35)	0-10	<b>20320052</b>
2¼"-3½" (5.71-8.89)	¾" (1.59)	4" (10.16)	0-16	<b>20320053</b>
3½"-5" (8.89-12.70)	¾" (1.59)	6" (15.24)	0-24	<b>20320054</b>



## Accessories

### Punch-Lok Tools

	Catalog Number
P-1000 for use with ¾" width Banding tool.	<b>20320048</b>
P-38 for use with ¾" and ¾" width Banding tool for tight spaces.	<b>20320047</b>

*Note: In all cases two Punch-Lok Bands should be double wrapped approximately one inch to two inches (2.54cm to 5.08cm) from the grip's tail. Banding is required to ensure maximum reliability and guard against accidental release.*





**Stainless Steel Swivels**

Swivels are essential to the efficiency and safety of any high tension application. They are particularly important where continuous pulls develop higher and higher torque levels. Torque is intensified by the pull-resistance of the cable itself and the resistance of the high tension controlling equipment regulating line sag.

Ball bearing swivels release torque and prevent it from reaching dangerous levels that can damage the cable and obstruct the lines.

**IMPORTANT**  
Read all breaking strength, safety and technical data relating to this product. Pages V-17 to V-26.



20308001A

**Stainless Steel Swivels**

Maximum Safe Working Load Lbs. (N)	Dimensions in Inches (cm)							Model	Catalog Number
	A	B	C	D	E	F	G		
2,250 (10,000)	7/8" (2.22)	2 1/2" (6.35)	3 3/8" (8.57)	7/16" (1.11)	3/8" (0.95)	5/16" (0.79)	3 1/32" (2.46)	A-13L	<b>20308001A</b>
5,000 (22,240)	1 1/4" (3.17)	3 1/16" (9.37)	4 3/4" (12.06)	1 7/32" (1.35)	1 7/32" (1.35)	1 3/32" (1.03)	1 9/32" (3.25)	BB-13L	<b>20308002A</b>
9,000 (40,030)	1 1/2" (3.81)	4 1/4" (10.79)	5 5/8" (14.29)	1 1/16" (1.75)	1 3/32" (1.51)	1/2" (1.27)	1 9/16" (3.97)	B-13L	<b>20308003A</b>
10,000 (44,480)	1 5/8" (4.13)	4 1/2" (11.43)	6" (15.24)	3/4" (1.90)	1 1/16" (1.75)	5/8" (1.59)	1 23/32" (4.36)	C-13L	<b>20308004A</b>
30,000 (133,440)	2 3/8" (6.03)	7 5/8" (19.37)	10" (25.40)	1 3/16" (3.02)	1 1/32" (2.62)	7/8" (2.22)	2 25/32" (7.06)	D-13L	<b>20308005A</b>

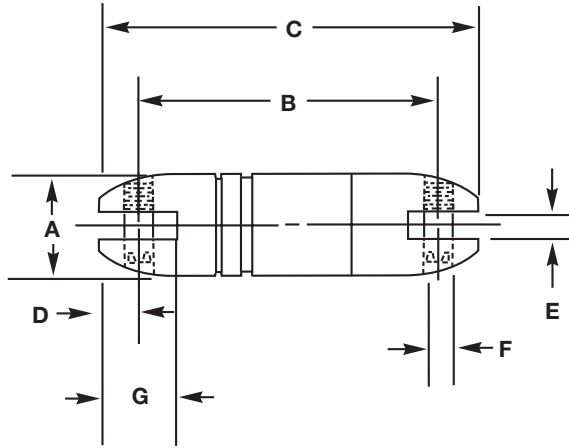





Kellems Pulling Grips are reusable tools for pulling electrical cable, bare conductor or rope. They are easy and fast to install, providing the user with a smooth, slim profile that allows for easy passage through ducts and conduit. Kellems Pulling Grips are made of the highest quality galvanized steel strand which assures the user of a long lasting grip. There is a Kellems Pulling Grip for every pulling job.

**CAUTION:** It is very important to comply with all of the following precautions. Failure to do so may result in property damage, personal injury or death.

1. Pulling grips are to be installed by a qualified individual in accordance with all applicable national and local safety, electrical and rigging codes.
2. Ensure that the correct grip is selected for your specific needs.
3. Do not use a pulling grip for any application other than pulling cable.
4. Thoroughly examine the grip for damage. Do not use a damaged grip.
5. Ensure that the recommended work load of the grip is suitable for the application. Never use grips at their approximated rated breaking strength. A safety factor of 5 is recommended for pulling grips.
6. Do not alter grips in any way. For example, do not modify pulling eyes, shoulders, fittings or lugs.
7. Do not attach any type of pulling hardware to any point on the grip other than the pulling eye. The pulling eye is the only acceptable means of attachment to external hardware.
8. Always apply 2 bands at 1" and 2" respectively, from the tail end of the mesh to guard against accidental release of the grip. Accidental release can occur if an object contracts and pushes against the tail end of the mesh, thereby expanding and releasing its hold.

### Select The Correct Pulling Grip

Each Kellems Grip is designed to work on a specific range of cable diameters.

**Step 1** Refer to the chart below to determine the style of grip best suited for your application.

**Step 2** Determine your cable outside diameter.

**Step 3** Find the grip size that encompasses your cable diameter.

**Step 4** Estimate the tension to be put on the grip, establish the working load you require and compare this to the listed approximate breaking strength of the grip to insure that the grip will be strong enough. Refer to page V-18 for safety and working load factors.

### Pulling Grip Selection Chart

Grip Style	Application	Page Number
DUA-PULL®, flexible eye	Extra high strength overhead transmission line stringing for bare or insulated conductor and synthetic rope.	V-6
Multiple strength, flexible eye	Normal overhead transmission and distribution line stringing for bare or insulated conductor.	V-7
Multiple strength, rotating eye	Normal overhead transmission and distribution line stringing for bare or insulated conductor.	V-7
K-type grip, rotating eye	Underground power cables and communication lines. Service lines into factories.	V-8
T-type grip, flexible eye	Underground power cables and communication lines. Service lines into factories.	V-9
Non-conductive, flexible eye	Pull insulated distribution cable into place.	V-10
Slack pulling, closed mesh	Remove underground cable. For pulling slack in final placement of new cable when end of cable is available.	V-10
Slack pulling, split mesh,	Remove underground cable. For pulling slack in final placement of new cable rawhide lace closing when end of cable is not available.	V-11
Slack pulling, split mesh,	Remove underground cable. For pulling slack in final placement of new cable rod closing when end of cable is not available, with rod closing for quick installation.	V-11
Light duty, flexible eye	Light pulling, underground electrical construction. Industrial plant wiring and rewiring jobs.	V-12
Junior, flexible eye	Connect bundled insulated building wire to a pulling tape. Pull wire through conduit.	V-12
Regular and rotating wire rope	Restraining wire rope in cranes and oil rigs.	V-13
Splicing	Temporary splice for cable or wire rope.	V-14
Pulling Grip Accessories	Tools, bands, swivels.	V-15, V-16
Fiber Optic Cable Pulling Grips	Pull fiber optic cable into place overhead, underground or through duct and conduit.	V-47, V-48, V-49



## Safety And Working Load Factors For Wire Mesh Grips

The broad application of Kellems grips on a wide variety of objects requires that adequate safety factors be used to establish working loads. The approximate breaking strength of a Kellems grip represents an average calculation based on data established from actual direct tension testing done in our engineering laboratories.

It is impossible to catalog or guarantee a safety factor suitable for all applications as operating conditions are never the same. The tension, diameter, movement, number of objects gripped, gripping surface, and the attachments used are just some of the factors which vary with each application. These factors, together with the effects of abrasion, corrosion, prior use or abuse and any other variables of a specific application, must be considered by the user and

the grip replaced as appropriate. Where the conditions of the application are not well defined or known, or where risk of injury to persons or property is involved, a greater safety factor should be utilized.

**Under normal conditions, Kellems' recommended factor of safety is five for catalog listed pulling grips, and ten for catalog listed support grips.**

Any warranty as to quality, performance or fitness for use of grips is always premised on the condition that the published breaking strengths apply only to new, unused grips, and that such products are properly stored, handled, used, maintained and inspected by the user at a frequency appropriate for the use and condition of the grip.

## Examples

Grip Style	Approx. Breaking Strength Lbs. (N)	Safety Factor	Max. Recommended Load Lbs. (N)	Catalog Number
Pulling Grips	27,200 (120,986)	5	5,440 (24,197)	<b>03301027</b>
Support Grips	1,610 (7,161)	10	161 (716)	<b>02201018</b>

The maximum recommended working load then is the tension to be exerted on the grip in application with a margin of safety to take care of unforeseen and unusual circumstances.

It is the end-user's decision to determine how much of a safety factor is acceptable for the application.

The metric unit of measure (force) for breaking strength and load is newtons (N). To convert from newtons to the metric unit of weight (kilograms) the conversion factor is 9.808 newtons/kilogram.

## Pulling Grip Materials

Material	Features	Product Group
Galvanized steel wire	<ul style="list-style-type: none"> <li>• High strength</li> <li>• Not subject to continuous outside environment</li> </ul>	<ul style="list-style-type: none"> <li>• Pulling grips</li> <li>• Wire rope grips</li> <li>• Splicing grips</li> </ul>
Non-metallic strand	<ul style="list-style-type: none"> <li>• Superior flex life</li> <li>• Non-conductive</li> <li>• Corrosion resistant</li> <li>• Moderate strength</li> </ul>	<ul style="list-style-type: none"> <li>• Non-conductive pulling grips</li> </ul>

## Approvals

UL and CSA Certification is indicated on appropriate product catalog pages.



## Overhead Pulling DUA-PULL® Grips

DUA-PULL Pulling Grips are the highest strength pulling grips manufactured for overhead transmission line stringing applications. They have a dual function of working with both bare and insulated conductors and synthetic rope, not provided by any other grip. Kellems' patented two-over, two-under weave design gives exceptional strength and gripping ability by putting more steel mesh in contact with the cable or rope surfaces.

**THIS IS THE ONLY PULLING GRIP RECOMMENDED FOR USE ON SYNTHETIC ROPE.**

## Application

The DUA-PULL Grips are primarily used in overhead transmission line construction where loads and safety considerations require an extra high strength grip. They are most commonly used for attaching pulling lines to conductors, conductors to running boards and "double socking" for conductor-to-conductor connections. The DUA-PULL line accommodates ACSR, ACAR, all aluminum and copper conductors. Also, the grips accommodate ground wires, messenger strands, wire ropes and synthetic ropes.

## Benefits

- Made of high strength galvanized steel strand.
- Recommended for pulling bare or insulated conductor, wire rope and synthetic rope.
- DUA-PULL mesh design offers the greatest holding power for all pulling applications.
- Each grip size is color coded for fast and accurate identification and selection.
- Will mate with swivels. See page V-16.

## Feed Tubes

The Kellems Feed Tube is used when assembling synthetic rope into the DUA-PULL Grip. It is required on the largest two sizes of DUA-PULL Grips. Feed Tubes are available for use on all size DUA-PULL Grips.

## Benefits

- Saves time, allowing fast, easy assembly.
- Can be reused if not damaged.

*Note: 1. Do not run grips or swivels over bullwheels while under tension.*

*2. Two Punch-Lok® bands should be firmly attached approximately 1" and 2" (2.54cm and 5.08cm) from the grip's tail.*

*Banding is required to ensure maximum reliability and guard against accidental release. See page V-15.*

*3. Double braided rope, such as 2-in-1 type, should be back spliced for approximately 2/3 of the mesh length for best gripping results.*

*Grip size should be selected by diameter of back splice.*

## Components

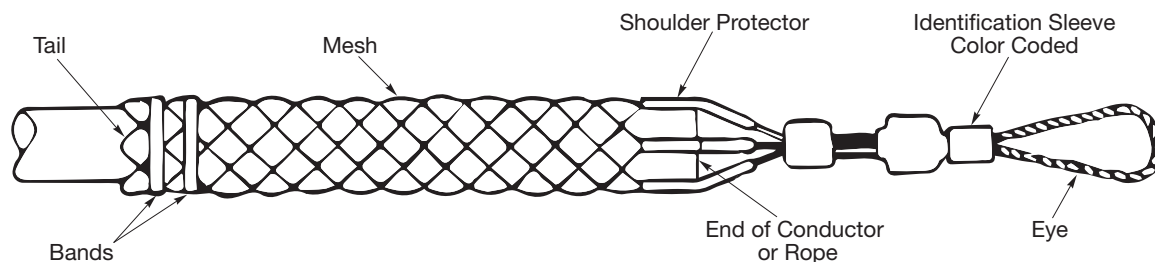



## Overhead Pulling Multiple Strength Grips

Multiple Strength Pulling Grips are designed for pulling aluminum or copper bare conductor, ground wires, messenger strands, wire rope and insulated cables. They are made of high strength galvanized steel strand and feature a multi-weave mesh construction of single, double and triple weave for firm holding power.

## Application

Kellems Multiple Strength Grips are ideal for overhead transmission and distribution line stringing where moderate loading is anticipated. They are economical tools for attaching conductors to pulling lines and double socking for conductor-to-conductor connections.

## Rotating Eye Feature

Multiple Strength Grips are available with a forged steel rotating eye which can be attached to a swivel. The forged eye is durable, compact and streamlined and will thread through blocks and sheaves without binding. The rotating eye is not a swivel and will not turn while under tension; it can turn to relieve pulling torque when tension is relaxed. If constant swivel action is required, a swivel should be used. For swivel dimensions, see page V-16. For rotating eye dimensions, see page V-21.

## Flexible Eye Feature

Multiple Strength Grips are also available with a flexible, patented wire rope eye. This compact eye will mate with a swivel, and pass through blocks and sheaves without binding.

## Benefits

- Economical, high strength pulling tool.
- Multi-weave construction provides greater strength and holding power.
- Endless Weave Grip end lies flat on the cable and will not snag.

*Note: 1. Do not run grips or swivels over bullwheels while under tension.*

*2. Two Punch-Lok® bands should be firmly attached approximately 1" and 2" (2.54cm and 5.08cm) from the grip's tail. Banding is required to ensure maximum reliability and guard against accidental release. See page V-15.*

## Components

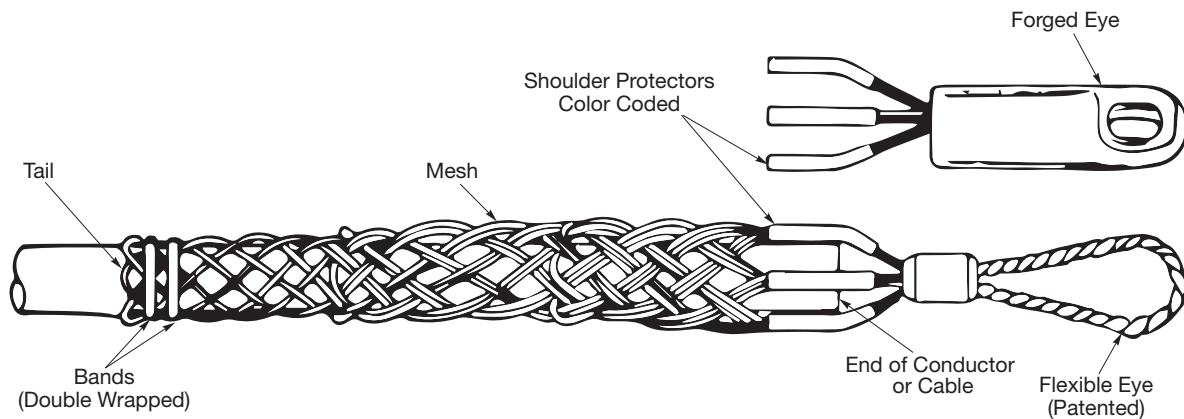



## Underground Pulling K-Type and T-Type Grips

### K-Type Application

Rotating Eye, K-Type Pulling Grips are specially designed for use in the installation of underground power cables, communication lines and service lines into factories, shopping centers, construction projects and general underground electrical construction.

### Rotating Eye Feature

K-Type Grips come equipped with a forged steel rotating eye which can be attached to a swivel. The forged eye is durable, compact and streamlined, and will thread through blocks and sheaves without binding.

**The rotating eye is not a swivel and will not turn while under tension;** it can turn to relieve pulling torque when the tension is relaxed. If constant swivel action is required, a swivel should be used. For swivel dimensions, see page V-16.

### Benefits

- An economical tool for pulling cable.
- Safe, rugged and dependable.
- Equipped with a rotating eye for spin out of pulling torque after load release.
- Easily installed and removed.

### Rotating Eye Dimensions

Rotating Eye Dimensions Inches (cm)	A	B	C	D	F
7/8" (2.22)	7/8" (2.22)	9/32" (.71)	1/2" (1.27)	7/8" (2.22)	2 5/8" (6.67)
1" (2.54)	1" (2.54)	1/2" (1.27)	9/16" (1.43)	1 3/16" (2.06)	3 1/2" (8.89)
1 1/8" (3.49)	1 1/8" (3.49)	1/2" (1.27)	1 1/16" (1.75)	1" (2.54)	4 1/2" (11.43)
1 5/8" (4.13)	1 5/8" (4.13)	5/8" (1.59)	7/8" (2.22)	1 3/16" (3.02)	5 5/16" (13.49)
1 7/8" (4.76)	1 7/8" (4.76)	2 1/32" (1.67)	1" (2.54)	1 3/8" (3.49)	6 1/8" (15.56)

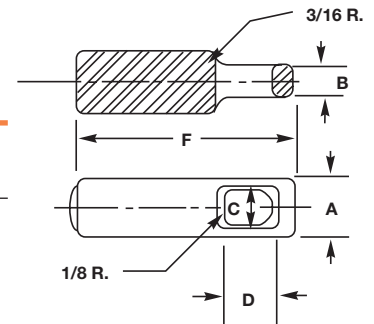

### T-Type

Kellems Flexible T-Type Pulling Grips are made of high strength galvanized steel strand. They feature double weave mesh for positive holding power in medium to heavy pulling jobs. The grip eye will easily attach to a swivel.

### Application

T-Type Pulling Grips are used for the installation of underground power cables, communication lines and service lines into factories, construction projects and for general underground electrical construction. Available in two mesh lengths, short for medium pulls, and standard for general purpose pulling.

### Benefits

- Will pull a single cable or cable bundles.
- Patented flexible eye design provides flexibility to follow line of pull.
- A dependable, reusable pulling tool.
- Easily installed and removed.
- Mates easily with a swivel. See page V-16.



## Special Purpose Grips

### Non-Conductive Pulling Grips

---

Kellems Non-Conductive Pulling Grips, made of a high strength, non-conductive aramid fiber, are available for pulling single cable or cable bundles. Their braided double weave design adds strength and positive holding power.

### Application

---

Kellems Non-Conductive Pulling Grips were developed for use by utilities for pulling overhead distribution lines in close proximity to energized lines and hardware.

### Benefits

---

- Color coded for fast on-site selection.
- Extra flexibility for easy installation.
- Non-metallic mesh provides for safe pulls over "hot" areas.
- Pellethane jacketed aramid fiber mesh resists abrasion.
- Grips are corrosion resistant.

*Note: Taping is required to guard against accidental release and to insure maximum reliability. Apply vinyl plastic electrical tape starting 2" to 3" (5.08cm to 7.62cm) from the tail of the grip onto 2" to 3" (5.08cm to 7.62cm) of cable.*

### Slack Pulling Grips

---

Slack Pulling Grips are offered in three styles made of galvanized steel. The closed type is used when the cable end is accessible. When not, there are split lace and split rod closing styles. All grips feature single offset eye for easy attachment to a pulling line.

### Application

---

Slack Grips are widely used in pulling slack for final placement of under ground cable after it has been pulled in. They are also used for removing cable. Standard mesh lengths are generally used in restricted space for short pulls. Longer lengths are used for higher pulling loads where space is not restricted.

### Benefits

---

- Easy attachment to pulling lines.
- Reusable rawhide lace for lace closure.
- Galvanized steel for strength.

*Note: 1. Replacement rawhide lace. Catalog number 20920002.  
2. See page V-43 for lace and rod closing instructions.*



## Commercial Construction/Light Duty Grips

### Light Duty Pulling Grips

---

Light Duty Pulling Grips are made of galvanized steel in a single weave construction. They feature a flexible eye for easy attachment to a pulling line.

### Application

---

Light Duty Grips are used in general underground electrical construction where pulling tensions are low. They are easy tools to use in wiring industrial plants and commercial buildings.

### Benefits

---

- Perfect tools for light pulling jobs.
- Installs easily on cable.
- Strong, galvanized steel construction.

### Junior Duty Pulling Grips

---

Junior Pulling Grips feature a strong galvanized steel, single weave mesh. A flexible eye easily attaches to a pulling line, snake or fish tape.

### Application

---

Designed to pull building wire, Junior grips are safe tools to use in pulling wire at low tension through conduit during electrical construction.

### Benefits

---

- Installs easily over building wire.
- Strong secure grip.
- Reusable.
- Pulls single cable or cable bundles.

### Junior Grip Kit

---

Junior Grip Kit contains 6 grips, one of each size. Catalog number **033051114**. See page V-12.

*Note: See page V-26 for building wire selection chart.*



## Splicing Grips

### Wire Rope Splicing

---

Kellems Wire Rope Grips are made of high strength galvanized steel strand in a construction of triple, double and single weave for superior gripping ability. They are available with or without a rotating barrel which will help eliminate twist in the old rope from being transferred to the new rope.

### Application

---

Wire Rope Grips are used for changing wire rope on oil derricks, large cranes, overhead cranes and drag lines. It provides a quick, safe, inexpensive temporary splice. By installing the used wire rope in one end and the new rope in the other, the new wire rope can be pulled in as the old one is pulled out.

### Benefits

---

- High strength for secure pulling.
- Easy installation.
- Flexible to pass through sheaves and blocks.

*Note: 1. During installation each end of the grip should be banded and taped down securely over the rope to insure smooth passage through sheaves and to guard against accidental release. See page V-15 for end bands.*

*2. The rotating barrel is not a swivel and will not turn while under tension. It can turn to relieve pulling torque when tension is relaxed.*

### Cable Splicing

---

Splicing Grips are made of galvanized steel in double or single weave mesh construction. They are available in various lengths and sizes to suit most applications.

### Application

---

Splicing Grips are used as a temporary splice for rope, cable or wire rope. They can also be used as cable reinforcement, and can act as a shield to protect cables and hoses from abrasion.

### Benefits

---

- Easily installed or removed.
- Galvanized steel construction for strength.
- Flexible to follow cable path.

*Note: 1. During installation, each end of the splicing grip should be banded and taped down securely to the cable to insure smooth passage with the cable and guard against accidental release.*

*2. See page V-15 for end bands.*





## Multiple Cable Selection Charts for Cables and Wires of Unequal Diameters

### How to choose the correct grip size:

1. Find the Grip Circumference Range by measuring the circumference of the bundle of different diameter cables to be gripped (see illustration).
2. Divide the bundle circumference by 3.14 to determine the diameter.
3. Choose a grip offering a range of cable diameters the same as the cable diameter.

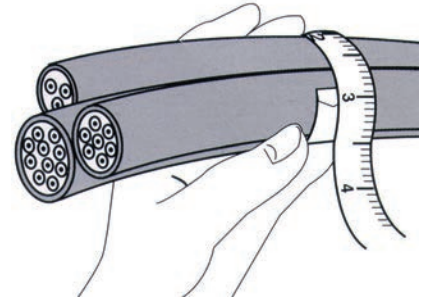

### For Pulling Grips\*

**CAUTION:** When a grip is used on multiple cables, the tail end of the grip should be banded after positioning on the cables.

### For Cables of Equal Diameters

Under "Number of Cables in One Grip", find the diameter of your single cable in vertical column. Read the grip diameter range to the right.

If your diameter is the maximum of the range shown, go to the next larger size for Split Grips, stay with the same size for Closed Grips.

**Example:** Three cables, each with .89" (2.26cm) diameter, for a Closed Grip select the 1.50"-1.74" (3.81cm-4.42cm) range, for a Split Grip select the 1.75"-1.99" (4.44cm-5.05cm) range.

### Number of Cables in One Grip

2	3	4	5	6 and 7	8	9	Grip Dia. Range Inches (cm)
.30-.38 (.76-.97)	.25-.31 (.63-.79)	.22-.27 (.56-.69)	.19-.24 (.48-.60)	.17-.22 (.43-.56)	.15-.19 (.38-.48)	.14-.18 (.36-.46)	.50-.61 (1.27-1.55)
.38-.44 (.97-1.12)	.31-.36 (.79-.91)	.27-.31 (.69-.79)	.24-.29 (.61-.74)	.22-.26 (.56-.66)	.19-.23 (.48-.58)	.18-.21 (.46-.53)	.62-.74 (1.57-1.88)
.44-.59 (1.12-1.50)	.36-.49 (.91-1.24)	.31-.42 (.79-1.07)	.29-.38 (.74-.97)	.26-.34 (.66-.86)	.23-.31 (.58-.79)	.21-.28 (.53-.71)	.75-.99 (1.90-2.51)
.59-.75 (1.50-1.90)	.49-.63 (1.24-1.60)	.42-.54 (1.07-1.37)	.38-.48 (.97-1.22)	.34-.43 (.86-1.09)	.31-.39 (.79-.99)	.28-.35 (.71-.89)	1.00-1.24 (2.54-3.15)
.75-.90 (1.90-2.29)	.63-.76 (1.60-1.93)	.54-.65 (1.37-1.65)	.48-.58 (1.22-1.47)	.43-.52 (1.09-1.32)	.39-.46 (.99-1.17)	.35-.42 (.89-1.07)	1.25-1.49 (3.17-3.78)
.90-1.07 (2.29-2.72)	.76-.89 (1.93-2.26)	.65-.77 (1.65-1.96)	.58-.67 (1.47-1.70)	.52-.60 (1.32-1.52)	.46-.54 (1.17-1.37)	.42-.49 (1.07-1.24)	1.50-1.74 (3.81-4.42)
1.07-1.22 (2.72-3.10)	.89-1.02 (2.26-2.59)	.77-.88 (1.96-2.24)	.67-.77 (1.70-1.96)	.60-.69 (1.52-1.75)	.54-.62 (1.37-1.57)	.49-.56 (1.24-1.42)	1.75-1.99 (4.44-5.05)
1.22-1.53 (3.10-3.89)	1.02-1.28 (2.59-3.25)	.88-1.10 (2.24-2.79)	.77-.96 (1.96-2.44)	.69-.86 (1.75-2.18)	.62-.77 (1.57-1.96)	.56-.71 (1.42-1.80)	2.00-2.49 (5.08-6.32)
1.53-1.83 (3.89-4.65)	1.28-1.53 (3.25-3.89)	1.10-1.32 (2.79-3.35)	.96-1.16 (2.44-2.95)	.86-1.03 (2.18-2.62)	.77-.93 (1.96-2.36)	.71-.85 (1.80-2.16)	2.50-2.99 (6.35-7.59)
1.83-2.14 (4.65-5.44)	1.53-1.79 (3.89-4.55)	1.32-1.54 (3.35-3.91)	1.16-1.35 (2.95-3.43)	1.03-1.20 (2.62-3.05)	.93-1.08 (2.36-2.74)	.85-.99 (2.16-2.51)	3.00-3.49 (7.62-8.86)
2.14-2.44 (5.44-6.20)	1.79-2.05 (4.55-5.21)	1.54-1.76 (3.91-4.47)	1.35-1.54 (3.43-3.91)	1.20-1.37 (3.05-3.48)	1.08-1.24 (2.74-3.15)	.99-1.13 (2.51-2.87)	3.50-3.99 (8.89-10.13)
2.44-2.75 (6.20-6.98)	2.05-2.30 (5.21-5.84)	1.76-1.98 (4.47-5.03)	1.54-1.74 (3.91-4.42)	1.37-1.55 (3.48-3.94)	1.24-1.39 (3.15-3.53)	1.13-1.27 (2.87-3.23)	4.00-4.49 (10.16-11.40)
2.75-3.06 (6.98-7.77)	2.30-2.56 (5.84-6.50)	1.98-2.20 (5.03-5.59)	1.74-1.93 (4.42-4.90)	1.55-1.72 (3.94-4.37)	1.39-1.55 (3.53-3.94)	1.27-1.41 (3.23-3.58)	4.50-4.99 (11.43-12.67)

Note: \*This chart is not to be used for Conduit Riser Grips. Refer to the chart for Conduit Riser multiple cable section. It is always recommended that, when multiple cables are installed in a pulling grip, the tail end be banded and tightly taped after installation on the cable bundle. See page V-15 for end bands.



## Junior Pulling Grip Selection Chart

These charts are a general guide to assist in the selection of the correct Junior Pulling Grip for pulling various groupings of building wire. It is not intended to be restrictive inasmuch as the use of "dummy" wires (short pieces of wire used to fill out the Grip) or the tight taping of the wires into a compact bundle may increase or decrease the number of wires per Grip.

### T.H.W.N., T.H.H.N. and X.H.H.W. Building Wire

Cable Diameter Range In. (cm)	Approx. Breaking Strength Lbs. (N)	Approximate Number Of Wires In One Grip											Model	Catalog Number
		#14 19 Strand	#12 19 Strand	#10 19 Strand	#8 19 Strand	#6 19 Strand	#4 19 Strand	#3 19 Strand	#2 19 Strand	#1 37 Strand	#1/0 37 Strand			
.25-.36 (.63-.91)	450 (2,002)	4-8	3-6	2-3	2	1	1	1	—	—	—	J 25	<b>03305001</b>	
.37-.49 (.94-1.24)	900 (4,003)	9-16	6-11	4-6	3	2	—	—	1	1	1	J 37	<b>03305002</b>	
.50-.61 (1.27-1.55)	1,300 (5,782)	16-25	11-17	7-10	4-5	3-4	2	2	—	—	—	J 50	<b>03305003</b>	
.62-.74 (1.57-1.88)	1,950 (8,674)	26-37	18-25	11-14	6-8	5-6	3	3	2	2	—	J 62	<b>03305004</b>	
.75-.99 (1.90-2.51)	2,800 (12,454)	37-66	26-47	15-27	9-16	6-11	4-7	4-5	3-4	3	2-3	J 75	<b>03305005</b>	
1.00-1.24 (2.54-3.15)	3,900 (17,347)	66-104	47-74	28-43	16-24	11-17	8-10	6-8	5-7	4-5	4	J 100	<b>03305006</b>	

### R.H.H., R.H., R.W. and R.H.W. Building Wire

Cable Diameter Range In. (cm)	Approx. Breaking Strength Lbs. (N)	Approximate Number Of Wires In One Grip										Model	Catalog Number
		#14 7 Strand	#12 7 Strand	#10 7 Strand	#8 7 Strand	#6 7 Strand	#4 7 Strand	#2 7 Strand	#1 7 Strand	#1/0 19 Strand			
.25-.36 (.63-.91)	450 (2,002)	2	2	1	1	—	—	—	—	—	J 25	<b>03305001</b>	
.37-.49 (.94-1.24)	900 (4,003)	3	2-3	2	—	1	1	1	—	—	J 37	<b>03305002</b>	
.50-.61 (1.27-1.55)	1,300 (5,782)	4-5	4-5	3-4	2	—	—	—	1	—	J 50	<b>03305003</b>	
.62-.74 (1.57-1.88)	1,950 (8,674)	6-8	6-7	4-5	3	2	2	—	—	1	J 62	<b>03305004</b>	
.75-.99 (1.90-2.51)	2,800 (12,454)	9-16	8-14	6-10	4-6	3-4	3-4	2-3	2	—	J 75	<b>03305005</b>	
1.00-1.24 (2.54-3.15)	3,900 (17,347)	16-24	15-22	11-16	7-10	5-7	4-6	4	3	2-3	J 100	<b>03305006</b>	

### T.H.W. Building Wire

Cable Diameter Range In. (cm)	Approx. Breaking Strength Lbs. (N)	Approximate Number Of Wires In One Grip										Model	Catalog Number
		#14 7 Strand	#12 7 Strand	#10 7 Strand	#8 7 Strand	#6 7 Strand	#4 7 Strand	#2 7 Strand	#1 7 Strand	#1/0 19 Strand			
.25-.36 (.63-.91)	450 (2,002)	2-4	2-3	2	1	1	1	—	—	—	J 25	<b>03305001</b>	
.37-.49 (.94-1.24)	900 (4,003)	5-7	4-5	3-4	2	—	—	1	—	—	J 37	<b>03305002</b>	
.50-.61 (1.27-1.55)	1,300 (5,782)	8-11	6-8	5-7	3-4	2	2	—	1	1	J 50	<b>03305003</b>	
.62-.74 (1.57-1.88)	1,950 (8,674)	12-16	9-12	8-10	5-6	3-4	3	2	—	—	J 62	<b>03305004</b>	
.75-.99 (1.90-2.51)	2,800 (12,454)	17-30	13-24	11-19	7-10	5-7	4-5	3-4	2	2	J 75	<b>03305005</b>	
1.00-1.24 (2.54-3.15)	3,900 (17,347)	31-48	25-37	20-30	11-17	8-11	6-8	5-6	3-4	3	J 100	<b>03305006</b>	

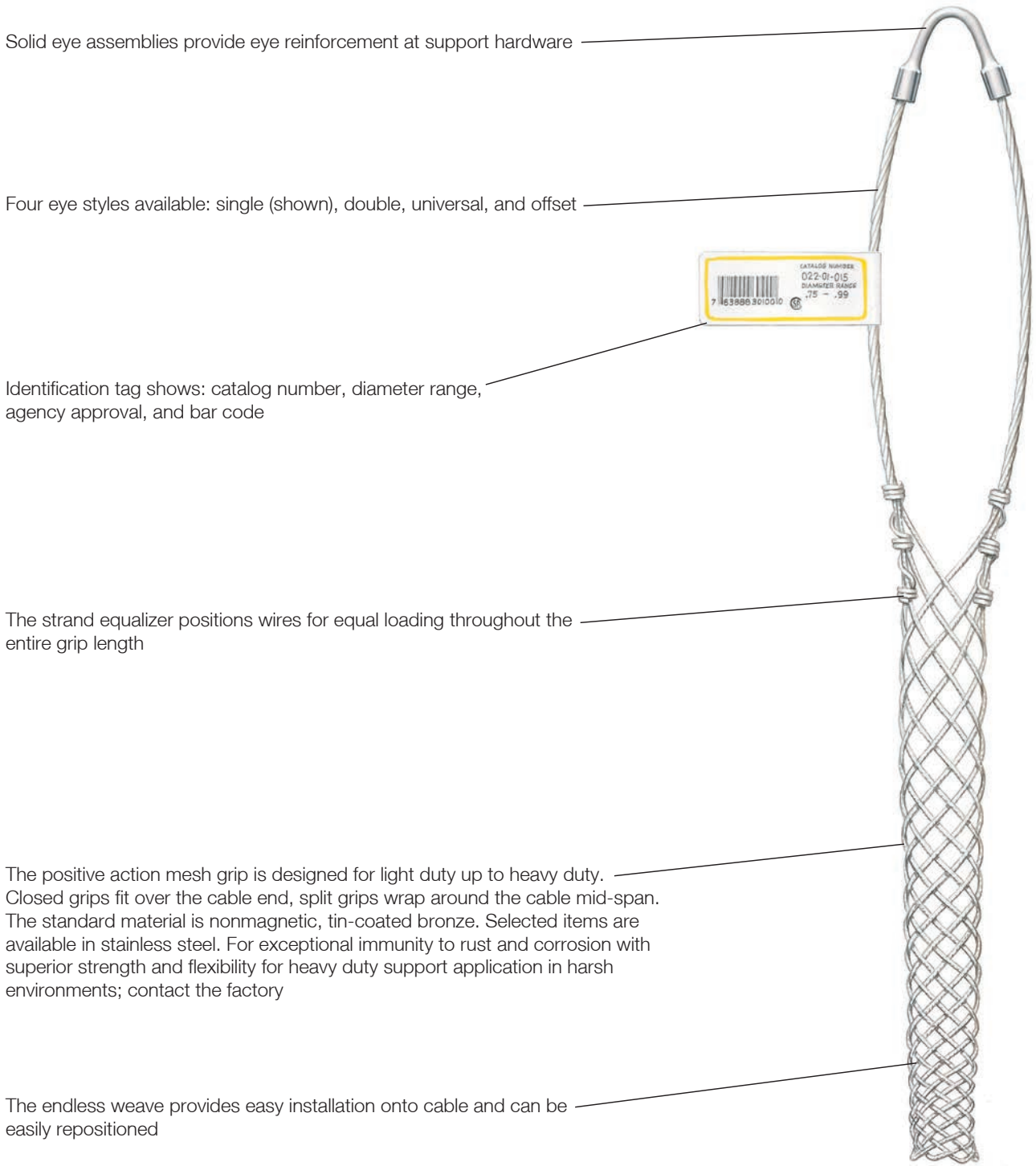

Solid eye assemblies provide eye reinforcement at support hardware

Four eye styles available: single (shown), double, universal, and offset

Identification tag shows: catalog number, diameter range, agency approval, and bar code

The strand equalizer positions wires for equal loading throughout the entire grip length

The positive action mesh grip is designed for light duty up to heavy duty. Closed grips fit over the cable end, split grips wrap around the cable mid-span. The standard material is nonmagnetic, tin-coated bronze. Selected items are available in stainless steel. For exceptional immunity to rust and corrosion with superior strength and flexibility for heavy duty support application in harsh environments; contact the factory

The endless weave provides easy installation onto cable and can be easily repositioned



**IMPORTANT**  
 Read all breaking strength, safety and technical data relating to this product. Pages V-41 to V-45.

**Single Eye, Closed Mesh**

For permanent support when cable end is available to be installed through grip.

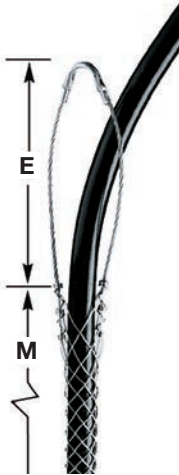

Cable Diameter Range Inches (cm)	Approx. Breaking Strength Lbs. (N)		E Inches (cm)	M Inches (cm)	Tin-Coated Bronze	Stainless Steel
	Tin-Coated Bronze	Stainless Steel				
.50"-.62" (1.27-1.57)	530 (2,357)	1,370 (6,094)	7" (17.78)	10" (25.40)	<b>02201013</b>	<b>02401013</b>
.63"-.74" (1.60-1.88)	790 (3,514)	2,060 (9,163)	8" (20.32)	10" (25.40)	<b>02201014</b>	<b>02401014</b>
.75"-.99" (1.90-2.51)	1,020 (4,537)	2,060 (9,163)	8" (20.32)	13" (33.02)	<b>02201015</b>	<b>02401015</b>
1.00"-1.24" (2.54-3.15)	1,610 (7,161)	2,678 (11,912)	9" (22.86)	14" (35.56)	<b>02201017</b>	<b>02401017</b>
1.25"-1.49" (3.17-3.78)	1,610 (7,161)	4,490 (19,972)	10" (25.40)	15" (38.10)	<b>02201018</b>	<b>02401018</b>
1.50"-1.74" (3.81-4.42)	1,610 (7,161)	4,492 (19,981)	12" (30.48)	17" (43.18)	<b>02201019</b>	<b>02401019</b>
1.75"-1.99" (4.44-5.05)	2,150 (9,563)	5,000 (22,241)	14" (35.56)	19" (48.26)	<b>02201020</b>	<b>02401020</b>
2.00"-2.49" (5.08-6.32)	3,260 (14,500)	8,940 (39,767)	16" (40.64)	21" (53.34)	<b>02201021</b>	<b>02401021</b>
2.50"-2.99" (6.35-7.59)	3,260 (14,500)	8,947 (39,798)	18" (45.72)	23" (58.42)	<b>02201022</b>	<b>02401022</b>
3.00"-3.49" (7.62-8.86)	4,900 (21,795)	13,420 (59,695)	21" (53.34)	25" (63.50)	<b>02201023</b>	<b>02401023</b>
3.50"-3.99" (8.89-10.13)	4,900 (21,795)	—	24" (60.96)	27" (68.58)	<b>02201024</b>	—

**Single Eye, Split Mesh, Lace Closing**

For permanent support when cable end is not available.

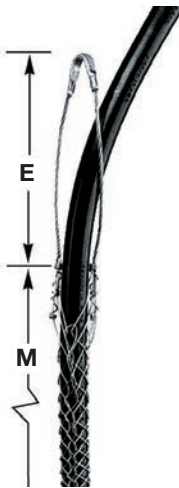

Cable Diameter Range Inches (cm)	Approx. Breaking Strength Lbs. (N)		E Inches (cm)	M Inches (cm)	Tin-Coated Bronze	Stainless Steel
	Tin-Coated Bronze	Stainless Steel				
.50"-.62" (1.27-1.57)	530 (2,357)	1,370 (6,094)	7" (17.78)	10" (25.40)	<b>02202013</b>	<b>02402013</b>
.63"-.74" (1.60-1.88)	790 (3,514)	2,066 (9,190)	8" (20.32)	10" (25.40)	<b>02202014</b>	<b>02402014</b>
.75"-.99" (1.90-2.51)	1,020 (4,537)	2,060 (9,163)	8" (20.32)	13" (33.02)	<b>02202015</b>	<b>02402015</b>
1.00"-1.24" (2.54-3.15)	1,610 (7,161)	2,670 (11,876)	9" (22.86)	14" (35.56)	<b>02202017</b>	<b>02402017</b>
1.25"-1.49" (3.17-3.78)	1,610 (7,161)	4,490 (19,972)	10" (25.40)	15" (38.10)	<b>02202018</b>	<b>02402018</b>
1.50"-1.74" (3.81-4.42)	1,610 (7,161)	4,490 (19,972)	12" (30.48)	17" (43.18)	<b>02202019</b>	<b>02402019</b>
1.75"-1.99" (4.44-5.05)	2,150 (9,563)	4,375 (19,461)	14" (35.56)	19" (48.26)	<b>02202020</b>	<b>02402020</b>
2.00"-2.49" (5.08-6.32)	3,260 (14,500)	8,947 (39,798)	16" (40.64)	21" (53.34)	<b>02202021</b>	<b>02402021</b>
2.50"-2.99" (6.35-7.59)	3,260 (14,500)	8,940 (39,767)	18" (45.72)	23" (58.42)	<b>02202022</b>	<b>02402022</b>
3.00"-3.49" (7.62-8.86)	4,900 (21,795)	13,420 (59,695)	21" (53.34)	25" (63.50)	<b>02202023</b>	<b>02402023</b>
3.50"-3.99" (8.89-10.13)	4,900 (21,795)	13,420 (59,695)	24" (60.96)	27" (68.58)	<b>02202024</b>	<b>02402024</b>

**Single Eye, Split Mesh, Rod Closing**

For support when cable end is not available.

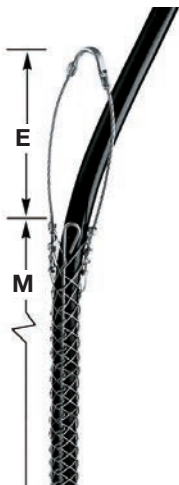

Cable Diameter Range Inches (cm)	Approx. Breaking Strength Lbs. (N)		E Inches (cm)	M Inches (cm)	Tin-Coated Bronze	Stainless Steel
	Tin-Coated Bronze	Stainless Steel				
.50"-.62" (1.27-1.57)	790 (3,514)	1,050 (4,670)	7" (17.78)	8.5" (21.59)	<b>02203013</b>	<b>02403013</b>
.63"-.74" (1.60-1.88)	790 (3,514)	2,050 (9,119)	8" (20.32)	8.5" (21.59)	<b>02203014</b>	<b>02403014</b>
.75"-.99" (1.90-2.51)	1,020 (4,537)	2,050 (9,119)	8" (20.32)	10.5" (26.67)	<b>02203015</b>	<b>02403015</b>
1.00"-1.24" (2.54-3.15)	1,610 (7,161)	2,650 (11,788)	9" (22.86)	12.5" (31.75)	<b>02203017</b>	<b>02403017</b>
1.25"-1.49" (3.17-3.78)	1,610 (7,161)	4,500 (20,017)	10" (25.40)	14.5" (36.83)	<b>02203018</b>	<b>02403018</b>
1.50"-1.74" (3.81-4.42)	1,610 (7,161)	4,500 (20,017)	12" (30.48)	15.5" (39.37)	<b>02203019</b>	<b>02403019</b>
1.75"-1.99" (4.44-5.05)	2,150 (9,563)	6,000 (26,689)	14" (35.56)	16.5" (41.91)	<b>02203020</b>	<b>02403020</b>
2.00"-2.49" (5.08-6.32)	3,260 (14,500)	8,950 (39,812)	16" (40.64)	19.5" (49.53)	<b>02203021</b>	<b>02403021</b>
2.50"-2.99" (6.35-7.59)	3,260 (14,500)	7,750 (34,474)	18" (45.72)	21.5" (54.61)	<b>02203022</b>	<b>02403022</b>
3.00"-3.49" (7.62-8.86)	5,750 (25,576)	8,500 (37,810)	21" (53.34)	23.5" (59.69)	<b>02203023</b>	<b>02403023</b>
3.50"-3.99" (8.89-10.13)	5,750 (25,576)	—	24" (60.96)	25.5" (64.77)	<b>02203024</b>	—

Note: E-Eye length. M-Mesh length at nominal diameter.



**IMPORTANT**

Read all breaking strength, safety and technical data relating to this product. Pages V-41 to V-45.

**Double Eye, Closed Mesh**

For permanent support when cable end is available to be installed through grip.

Cable Diameter Range Inches (cm)	Approx. Breaking Strength Lbs. (N)		E Inches (cm)	M Inches (cm)	Tin-Coated Bronze	Stainless Steel
	Tin-Coated Bronze	Stainless Steel				
.50"-.62" (1.27-1.57)	530 (2,357)	1,370 (6,094)	4" (10.16)	10" (25.40)	<b>02201001</b>	<b>02401001</b>
.63"-.74" (1.60-1.88)	790 (3,514)	2,060 (9,163)	4" (10.16)	10" (25.40)	<b>02201002</b>	<b>02401002</b>
.75"-.99" (1.90-2.51)	1,020 (4,537)	2,060 (9,163)	4" (10.16)	13" (33.02)	<b>02201003</b>	<b>02401003</b>
1.00"-1.24" (2.54-3.15)	1,610 (7,161)	2,670 (11,877)	5" (12.70)	14" (35.56)	<b>02201005</b>	<b>02401005</b>
1.25"-1.49" (3.17-3.78)	1,610 (7,161)	4,490 (19,972)	5" (12.70)	15" (38.10)	<b>02201006</b>	<b>02401006</b>
1.50"-1.74" (3.81-4.42)	1,610 (7,161)	4,490 (19,972)	5" (12.70)	17" (43.18)	<b>02201007</b>	<b>02401007</b>
1.75"-1.99" (4.44-5.05)	2,150 (9,563)	5,000 (22,241)	6" (15.24)	19" (48.26)	<b>02201008</b>	<b>02401008</b>
2.00"-2.49" (5.08-6.32)	3,260 (14,500)	8,940 (39,767)	6" (15.24)	21" (53.34)	<b>02201009</b>	<b>02401009</b>
2.50"-2.99" (6.35-7.59)	3,260 (14,500)	8,940 (39,767)	6" (15.24)	23" (58.42)	<b>02201010</b>	<b>02401010</b>
3.00"-3.49" (7.62-8.86)	4,900 (21,795)	12,000 (53,379)	8" (20.32)	25" (63.50)	<b>02201011</b>	<b>02401011</b>
3.50"-3.99" (8.89-10.13)	4,900 (21,795)	12,000 (53,379)	8" (20.32)	27" (68.58)	<b>02201012</b>	<b>02401012</b>

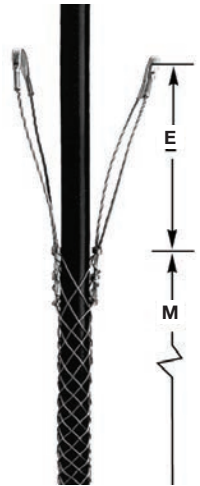

**Double Eye, Split Mesh, Lace Closing**

For permanent support when cable end is not available.

Cable Diameter Range Inches (cm)	Approx. Breaking Strength Lbs. (N)		E Inches (cm)	M Inches (cm)	Tin-Coated Bronze	Stainless Steel
	Tin-Coated Bronze	Stainless Steel				
.50"-.62" (1.27-1.57)	530 (2,357)	—	4" (10.16)	10" (25.40)	<b>02202001</b>	—
.63"-.74" (1.60-1.88)	790 (3,514)	2,066 (9,190)	4" (10.16)	10" (25.40)	<b>02202002</b>	<b>02402002</b>
.75"-.99" (1.90-2.51)	1,020 (4,537)	2,060 (9,163)	4" (10.16)	13" (33.02)	<b>02202003</b>	<b>02402003</b>
1.00"-1.24" (2.54-3.15)	1,610 (7,161)	2,678 (11,912)	5" (12.70)	14" (35.56)	<b>02202005</b>	<b>02402005</b>
1.25"-1.49" (3.17-3.78)	1,610 (7,161)	4,490 (19,972)	5" (12.70)	15" (38.10)	<b>02202006</b>	<b>02402006</b>
1.50"-1.74" (3.81-4.42)	1,610 (7,161)	3,750 (16,681)	5" (12.70)	17" (43.18)	<b>02202007</b>	<b>02402007</b>
1.75"-1.99" (4.44-5.05)	2,150 (9,563)	5,000 (22,241)	6" (15.24)	19" (48.26)	<b>02202008</b>	<b>02402008</b>
2.00"-2.49" (5.08-6.32)	3,260 (14,500)	8,940 (39,767)	6" (15.24)	21" (53.34)	<b>02202009</b>	<b>02402009</b>
2.50"-2.99" (6.35-7.59)	3,260 (14,500)	—	6" (15.24)	23" (58.42)	<b>02202010</b>	—
3.00"-3.49" (7.62-8.86)	4,900 (21,795)	—	8" (20.32)	25" (63.50)	<b>02202011</b>	—
3.50"-3.99" (8.89-10.13)	4,900 (21,795)	—	8" (20.32)	27" (68.58)	<b>02202012</b>	—

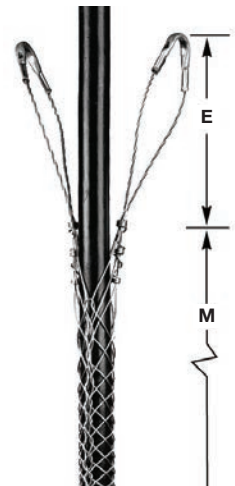

**Double Eye, Split Mesh, Rod Closing**

For support when cable end is not available.

Cable Diameter Range Inches (cm)	Approx. Breaking Strength Lbs. (N)		E Inches (cm)	M Inches (cm)	Tin-Coated Bronze	Stainless Steel
	Tin-Coated Bronze	Stainless Steel				
.50"-.62" (1.27-1.57)	790 (3,514)	—	4" (10.16)	6.5"	<b>02203001</b>	—
.63"-.74" (1.60-1.88)	790 (3,514)	2,050 (9,119)	4" (10.16)	8.5" (21.59)	<b>02203002</b>	<b>02403002</b>
.75"-.99" (1.90-2.51)	1,020 (4,537)	2,050 (9,119)	4" (10.16)	10.5" (26.67)	<b>02203003</b>	<b>02403003</b>
1.00"-1.24" (2.54-3.15)	1,610 (7,161)	2,650 (11,788)	5" (12.70)	12.5" (31.75)	<b>02203005</b>	<b>02403005</b>
1.25"-1.49" (3.17-3.78)	1,610 (7,161)	3,750 (16,681)	5" (12.70)	14.5" (36.83)	<b>02203006</b>	<b>02403006</b>
1.50"-1.74" (3.81-4.42)	1,610 (7,161)	3,750 (16,681)	5" (12.70)	15.5" (39.37)	<b>02203007</b>	<b>02403007</b>
1.75"-1.99" (4.44-5.05)	2,150 (9,563)	5,000 (22,241)	6" (15.24)	16.5" (41.91)	<b>02203008</b>	<b>02403008</b>
2.00"-2.49" (5.08-6.32)	3,260 (14,500)	8,950 (39,812)	6" (15.24)	19.5" (49.53)	<b>02203009</b>	<b>02403009</b>
2.50"-2.99" (6.35-7.59)	3,260 (14,500)	8,950 (39,812)	6" (15.24)	21.5" (54.61)	<b>02203010</b>	<b>02403010</b>
3.00"-3.49" (7.62-8.86)	5,750 (25,576)	11,150 (49,598)	8" (20.32)	23.5" (59.69)	<b>02203011</b>	<b>02403011</b>
3.50"-3.99" (8.89-10.13)	5,750 (25,576)	—	8" (20.32)	25.5" (64.77)	<b>02203012</b>	—

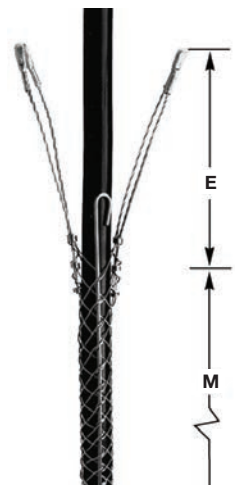

Note: E-Eye length. M-Mesh length at nominal diameter.



**IMPORTANT**  
 Read all breaking strength, safety and technical data relating to this product. Pages V-41 to V-45.

**Offset Eye, Closed Mesh**

For permanent support when cable end is available to be installed through grip.

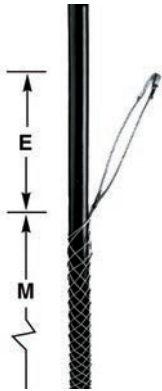

Cable Diameter Range Inches (cm)	Approx. Breaking Strength Lbs. (N)		E Inches (cm)	M Inches (cm)	Tin-Coated Bronze	Stainless Steel
	Tin-Coated Bronze	Stainless Steel				
.50"--.62" (1.27-1.57)	530 (2,357)	1,370 (6,094)	4" (10.16)	10" (25.40)	<b>02201037</b>	<b>02401037</b>
.63"--.74" (1.60-1.88)	750 (3,336)	1,950 (8,674)	4" (10.16)	10" (25.40)	<b>02201038</b>	<b>02401038</b>
.75"--.99" (1.90-2.51)	950 (4,226)	2,060 (9,163)	4" (10.16)	13" (33.02)	<b>02201039</b>	<b>02401039</b>
1.00"-1.24" (2.54-3.15)	1,500 (6,672)	2,678 (11,912)	5" (12.70)	14" (35.56)	<b>02201041</b>	<b>02401041</b>
1.25"-1.49" (3.17-3.78)	1,500 (6,672)	4,490 (19,972)	5" (12.70)	15" (38.10)	<b>02201042</b>	<b>02401042</b>
1.50"-1.74" (3.81-4.42)	1,500 (6,672)	3,700 (16,458)	5" (12.70)	17" (43.18)	<b>02201043</b>	<b>02401043</b>
1.75"-1.99" (4.44-5.05)	2,000 (8,896)	4,375 (19,461)	6" (15.24)	19" (48.26)	<b>02201044</b>	<b>02401044</b>
2.00"-2.49" (5.08-6.32)	3,100 (13,789)	5,500 (24,465)	9" (22.86)	21" (53.34)	<b>02201045</b>	<b>02401045</b>
2.50"-2.99" (6.35-7.59)	3,100 (13,789)	—	9" (22.86)	23" (58.42)	<b>02201046</b>	—
3.00"-3.49" (7.62-8.86)	3,800 (16,902)	—	11" (27.94)	25" (63.50)	<b>02201047</b>	—
3.50"-3.99" (8.89-10.13)	3,250 (14,480)	—	11" (27.94)	27" (68.58)	<b>02201048</b>	—

**Offset Eye, Split Mesh, Lace Closing**

For permanent support when cable end is not available.



Cable Diameter Range Inches (cm)	Approx. Breaking Strength Lbs. (N)		E Inches (cm)	M Inches (cm)	Tin-Coated Bronze	Stainless Steel
	Tin-Coated Bronze	Stainless Steel				
.50"--.62" (1.27-1.57)	500 (2,224)	1,370 (6,094)	4" (10.16)	10" (25.40)	<b>02202037</b>	<b>02402037</b>
.63"--.74" (1.60-1.88)	750 (3,336)	1,952 (8,683)	4" (10.16)	10" (25.40)	<b>02202038</b>	<b>02402038</b>
.75"--.99" (1.90-2.51)	950 (4,226)	2,060 (9,163)	4" (10.16)	13" (33.02)	<b>02202039</b>	<b>02402039</b>
1.00"-1.24" (2.54-3.15)	1,500 (6,672)	2,670 (11,877)	5" (12.70)	14" (35.56)	<b>02202041</b>	<b>02402041</b>
1.25"-1.49" (3.17-3.78)	1,500 (6,672)	4,490 (19,972)	5" (12.70)	15" (38.10)	<b>02202042</b>	<b>02402042</b>
1.50"-1.74" (3.81-4.42)	1,500 (6,672)	4,490 (19,972)	5" (12.70)	17" (43.18)	<b>02202043</b>	<b>02402043</b>
1.75"-1.99" (4.44-5.05)	1,800 (8,006)	4,375 (19,461)	6" (15.24)	19" (48.26)	<b>02202044</b>	<b>02402044</b>
2.00"-2.49" (5.08-6.32)	2,150 (9,563)	5,500 (24,465)	9" (22.86)	21" (53.34)	<b>02202045</b>	<b>02402045</b>
2.50"-2.99" (6.35-7.59)	2,150 (9,563)	5,500 (24,465)	9" (22.86)	23" (58.42)	<b>02202046</b>	<b>02402046</b>
3.00"-3.49" (7.62-8.86)	3,250 (14,480)	10,190 (45,327)	11" (27.94)	25" (63.50)	<b>02202047</b>	<b>02402047</b>
3.50"-3.99" (8.89-10.13)	3,250 (14,480)	—	11" (27.94)	27" (68.58)	<b>02202048</b>	—

**Offset Eye, Split Mesh, Rod Closing**

For support when cable end is not available.

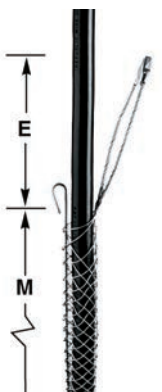

Cable Diameter Range Inches (cm)	Approx. Breaking Strength Lbs. (N)		E Inches (cm)	M Inches (cm)	Tin-Coated Bronze	Stainless Steel
	Tin-Coated Bronze	Stainless Steel				
.50"--.62" (1.27-1.57)	500 (2,224)	1,000 (4,448)	4" (10.16)	7" (17.78)	<b>02203037</b>	<b>02403037</b>
.63"--.74" (1.60-1.88)	750 (3,336)	1,950 (8,674)	4" (10.16)	9" (22.86)	<b>02203038</b>	<b>02403038</b>
.75"--.99" (1.90-2.51)	950 (4,226)	1,950 (8,674)	4" (10.16)	10" (25.40)	<b>02203039</b>	<b>02403039</b>
1.00"-1.24" (2.54-3.15)	1,500 (6,672)	2,500 (11,121)	5" (12.70)	12" (30.48)	<b>02203041</b>	<b>02403041</b>
1.25"-1.49" (3.17-3.78)	1,500 (6,672)	4,200 (18,683)	5" (12.70)	14" (35.56)	<b>02203042</b>	<b>02403042</b>
1.50"-1.74" (3.81-4.42)	1,500 (6,672)	4,500 (20,017)	5" (12.70)	15" (38.10)	<b>02203043</b>	<b>02403043</b>
1.75"-1.99" (4.44-5.05)	2,000 (8,896)	4,375 (19,461)	6" (15.24)	16" (40.64)	<b>02203044</b>	<b>02403044</b>
2.00"-2.49" (5.08-6.32)	3,100 (13,789)	8,350 (37,143)	9" (22.86)	19" (48.26)	<b>02203045</b>	<b>02403045</b>
2.50"-2.99" (6.35-7.59)	3,100 (13,789)	—	9" (22.86)	20" (50.80)	<b>02203046</b>	—
3.00"-3.49" (7.62-8.86)	4,300 (19,126)	8,400 (37,365)	11" (27.94)	21" (53.34)	<b>02203047</b>	<b>02403047</b>
3.50"-3.99" (8.89-10.13)	4,900 (21,795)	—	11" (27.94)	21" (53.34)	<b>02203048</b>	—

Note: E-Eye length. M-Mesh length at nominal diameter.



**IMPORTANT**  
 Read all breaking strength, safety and technical data relating to this product. Pages V-41 to V-45.

**Universal Eye, Closed Mesh**

For permanent support when cable end is available to be installed through grip.

Cable Diameter Range Inches (cm)	Approx. Breaking Strength Lbs. (N)		E Inches (cm)	M Inches (cm)	Tin-Coated Bronze	Stainless Steel
	Tin-Coated Bronze	Stainless Steel				
.50"-1.62" (1.27-1.57)	530 (2,357)	1,370 (6,094)	18" (45.72)	10" (25.40)	<b>02201051</b>	<b>02401051</b>
.63"-1.74" (1.60-1.88)	790 (3,514)	2,060 (9,163)	18" (45.72)	10" (25.40)	<b>02201052</b>	<b>02401052</b>
.75"-1.99" (1.90-2.51)	1,020 (4,537)	2,066 (9,190)	18" (45.72)	13" (33.02)	<b>02201053</b>	<b>02401053</b>
1.00"-1.24" (2.54-3.15)	1,610 (7,161)	—	18" (45.72)	14" (35.56)	<b>02201050</b>	—
1.25"-1.49" (3.17-3.78)	1,610 (7,161)	4,490 (19,972)	18" (45.72)	15" (38.10)	<b>02201054</b>	<b>02401054</b>
1.50"-1.74" (3.81-4.42)	1,610 (7,161)	4,490 (19,972)	18" (45.72)	17" (43.18)	<b>02201055</b>	<b>02401055</b>
1.75"-1.99" (4.44-5.05)	2,150 (9,563)	—	18" (45.72)	19" (48.26)	<b>02201056</b>	<b>02401056</b>
2.00"-2.49" (5.08-6.32)	3,260 (14,500)	—	18" (45.72)	21" (53.34)	<b>02201057</b>	<b>02401057</b>
2.50"-2.99" (6.35-7.59)	3,260 (14,500)	—	18" (45.72)	23" (58.42)	<b>02201058</b>	<b>02401058</b>



**Universal Eye, Split Mesh, Lace Closing**

For permanent support when cable end is not available.

Cable Diameter Range Inches (cm)	Approx. Breaking Strength Lbs. (N)		E Inches (cm)	M Inches (cm)	Tin-Coated Bronze	Stainless Steel
	Tin-Coated Bronze	Stainless Steel				
.50"-1.62" (1.27-1.57)	530 (2,357)	—	18" (45.72)	10" (25.40)	<b>02202050</b>	—
.63"-1.74" (1.60-1.88)	790 (3,514)	2,060 (9,163)	18" (45.72)	10" (25.40)	<b>02202051</b>	<b>02402051</b>
.75"-1.99" (1.90-2.51)	1,020 (4,537)	—	18" (45.72)	13" (33.02)	<b>02202052</b>	—
1.00"-1.24" (2.54-3.15)	1,610 (7,161)	—	18" (45.72)	14" (35.56)	<b>02202054</b>	—
1.25"-1.49" (3.17-3.78)	1,610 (7,161)	—	18" (45.72)	15" (38.10)	<b>02202055</b>	—
1.50"-1.74" (3.81-4.42)	1,610 (7,161)	—	18" (45.72)	17" (43.18)	<b>02202056</b>	—
1.75"-1.99" (4.44-5.05)	2,150 (9,563)	—	18" (45.72)	19" (48.26)	<b>02202057</b>	—
2.00"-2.49" (5.08-6.32)	3,260 (14,500)	—	18" (45.72)	21" (53.34)	<b>02202058</b>	—
2.50"-2.99" (6.35-7.59)	3,260 (14,500)	—	18" (45.72)	23" (58.42)	<b>02202059</b>	—
3.50"-3.99" (8.89-10.13)	4,900 (21,795)	—	18" (45.72)	27" (68.58)	<b>02202061</b>	—



**Universal Eye, Split Mesh, Rod Closing**

For support when cable end is not available.

Cable Diameter Range Inches (cm)	Approx. Breaking Strength Lbs. (N)		E Inches (cm)	M Inches (cm)	Tin-Coated Bronze	Stainless Steel
	Tin-Coated Bronze	Stainless Steel				
.50"-1.62" (1.27-1.57)	790 (3,514)	—	18" (45.72)	8.5" (21.59)	<b>02203064</b>	—
.63"-1.74" (1.60-1.88)	790 (3,514)	2,050 (9,119)	18" (45.72)	8.5" (21.59)	<b>02203065</b>	<b>02403065</b>
.75"-1.99" (1.90-2.51)	1,020 (4,537)	2,050 (9,119)	18" (45.72)	10.5" (26.67)	<b>02203066</b>	<b>02403066</b>
1.00"-1.24" (2.54-3.15)	1,610 (7,161)	2,650 (11,788)	18" (45.72)	12.5" (31.75)	<b>02203068</b>	<b>02403068</b>
1.25"-1.49" (3.17-3.78)	1,610 (7,161)	4,500 (20,017)	18" (45.72)	14.5" (36.83)	<b>02203069</b>	<b>02403069</b>
1.50"-1.74" (3.81-4.42)	1,610 (7,161)	4,500 (20,017)	18" (45.72)	15.5" (39.37)	<b>02203070</b>	<b>02403070</b>
1.75"-1.99" (4.44-5.05)	2,150 (9,563)	—	18" (45.72)	16.5" (41.91)	<b>02203071</b>	—
2.00"-2.49" (5.08-6.32)	3,260 (14,500)	—	18" (45.72)	19.5" (49.53)	<b>02203072</b>	—
2.50"-2.99" (6.35-7.59)	3,260 (14,500)	—	18" (45.72)	21.5" (54.61)	<b>02203073</b>	—
3.00"-3.49" (7.62-8.86)	5,750 (25,576)	—	18" (45.72)	23.5" (59.69)	<b>02203074</b>	—



Note: E-Eye length. M-Mesh length at nominal diameter.



**IMPORTANT**  
 Read all breaking strength, safety and technical data relating to this product. Pages V-41 to V-45.

### Heavy Duty, Single Eye, Closed Mesh

For heavy duty permanent support when cable end is available to be installed through grip.

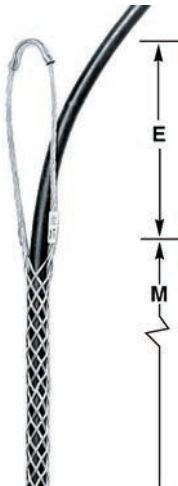

Cable Diameter Range Inches (cm)	Approx. Breaking Strength Lbs. (N)		E Inches (cm)	M Inches (cm)	Tin-Coated Bronze	Stainless Steel
	Tin-Coated Bronze	Stainless Steel				
.75"- .99" (1.90-2.51)	2,820 (12,543)	4,200 (18,683)	10" (25.40)	25" (63.50)	<b>02206010</b>	<b>02406010</b>
1.00"-1.24" (2.54-3.15)	4,280 (19,037)	7,300 (32,472)	12" (30.48)	28" (71.12)	<b>02206011</b>	<b>02406011</b>
1.25"-1.49" (3.17-3.78)	4,280 (19,037)	7,300 (32,472)	12" (30.48)	30" (76.20)	<b>02206012</b>	<b>02406012</b>
1.50"-1.99" (3.81-5.05)	4,280 (19,037)	11,150 (49,598)	12" (30.48)	34" (86.36)	<b>02206013</b>	<b>02406013</b>

### Single Eye, Split Mesh, Lace Closing

For permanent support when cable end is not available to be installed through grip.

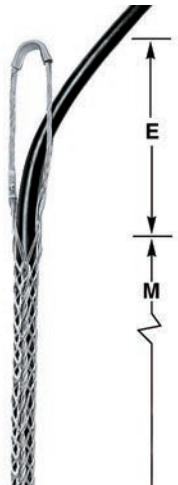

Cable Diameter Range Inches (cm)	Approx. Breaking Strength Lbs. (N)		E Inches (cm)	M Inches (cm)	Tin-Coated Bronze	Stainless Steel
	Tin-Coated Bronze	Stainless Steel				
.75"- .99" (1.90-2.51)	2,820 (12,543)	4,200 (18,683)	10" (25.40)	25" (63.50)	<b>02207010</b>	<b>02407010</b>
1.00"-1.24" (2.54-3.15)	4,280 (19,037)	7,300 (32,472)	12" (30.48)	28" (71.12)	<b>02207011</b>	<b>02407011</b>
1.25"-1.49" (3.17-3.78)	4,280 (19,037)	7,300 (32,472)	12" (30.48)	30" (76.20)	<b>02207012</b>	<b>02407012</b>
1.50"-1.99" (3.81-5.05)	4,280 (19,037)	11,150 (49,598)	12" (30.48)	34" (86.36)	<b>02207013</b>	<b>02407013</b>

Note: E-Eye length. M-Mesh length at nominal diameter.





**IMPORTANT**

Read all breaking strength, safety and technical data relating to this product. Pages V-41 to V-45.

**Double Eye, Closed Mesh**

For permanent support when cable end is available to be installed through grip.

Cable Diameter Range Inches (cm)	Approx. Breaking Strength Lbs. (N)		E Inches (cm)	M Inches (cm)	Tin-Coated Bronze	Stainless Steel
	Tin-Coated Bronze	Stainless Steel				
.75"- .99" (1.90-2.51)	2,820 (12,543)	4,250 (18,905)	10" (25.40)	25" (63.50)	<b>02206001</b>	<b>02406001</b>
1.00"-1.24" (2.54-3.15)	4,280 (19,037)	7,300 (32,472)	10" (25.40)	28" (71.12)	<b>02206002</b>	<b>02406002</b>
1.25"-1.49" (3.17-3.78)	4,280 (19,037)	7,300 (32,472)	10" (25.40)	30" (76.20)	<b>02206003</b>	<b>02406003</b>
1.50"-1.99" (3.81-5.05)	4,280 (19,037)	11,100 (49,375)	10" (25.40)	34" (86.36)	<b>02206004</b>	<b>02406004</b>
2.00"-2.49" (5.08-6.32)	8,050 (35,806)	20,100 (89,409)	12" (30.48)	36" (91.44)	<b>02206005</b>	<b>02406005</b>
2.50"-2.99" (6.35-7.59)	8,050 (35,806)	20,100 (89,409)	12" (30.48)	38" (96.52)	<b>02206006</b>	<b>02406006</b>
3.00"-3.49" (7.62-8.86)	10,060 (44,747)	25,200 (112,095)	12" (30.48)	40" (101.60)	<b>02206007</b>	<b>02406007</b>
3.50"-3.99" (8.89-10.13)	12,070 (53,687)	—	12" (30.48)	44" (111.76)	<b>02206008</b>	—
4.00"-4.49" (10.16-11.40)	12,070 (53,687)	—	12" (30.48)	46" (116.84)	<b>02206009</b>	—
4.50"-4.99" (11.43-12.67)	12,070 (53,687)	—	12" (30.48)	68" (172.72)	<b>02208009</b>	—

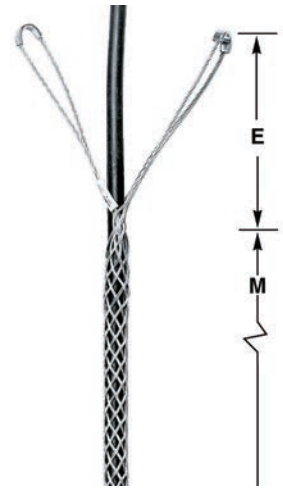

**Double Eye, Split Mesh, Lace Closing**

For support when cable end is not available.

Cable Diameter Range Inches (cm)	Approx. Breaking Strength Lbs. (N)		E Inches (cm)	M Inches (cm)	Tin-Coated Bronze	Stainless Steel
	Tin-Coated Bronze	Stainless Steel				
.75"- .99" (1.90-2.51)	2,820 (12,543)	4,250 (18,905)	10" (25.40)	25" (63.50)	<b>02207001</b>	<b>02407001</b>
1.00"-1.24" (2.54-3.15)	4,280 (19,037)	7,300 (32,472)	10" (25.40)	28" (71.12)	<b>02207002</b>	<b>02407002</b>
1.25"-1.49" (3.17-3.78)	4,280 (19,037)	7,300 (32,472)	10" (25.40)	30" (76.20)	<b>02207003</b>	<b>02407003</b>
1.50"-1.99" (3.81-5.05)	4,280 (19,037)	11,150 (49,598)	10" (25.40)	34" (86.36)	<b>02207004</b>	<b>02407004</b>
2.00"-2.49" (5.08-6.32)	8,050 (35,806)	20,150 (89,632)	12" (30.48)	36" (91.44)	<b>02207005</b>	<b>02407005</b>
2.50"-2.99" (6.35-7.59)	8,050 (35,806)	20,150 (89,632)	12" (30.48)	38" (96.52)	<b>02207006</b>	<b>02407006</b>
3.00"-3.49" (7.62-8.86)	10,060 (44,747)	25,200 (112,095)	12" (30.48)	40" (101.60)	<b>02207007</b>	<b>02407007</b>
3.50"-3.99" (8.89-10.13)	12,070 (53,687)	30,200 (134,336)	12" (30.48)	44" (111.76)	<b>02207008</b>	<b>02407008</b>
4.00"-4.49" (10.16-11.40)	12,070 (53,687)	30,200 (134,336)	12" (30.48)	46" (116.84)	<b>02207009</b>	<b>02407009</b>
4.50"-4.99" (11.43-12.67)	12,070 (53,687)	—	12" (30.48)	68" (172.72)	<b>02209009</b>	—

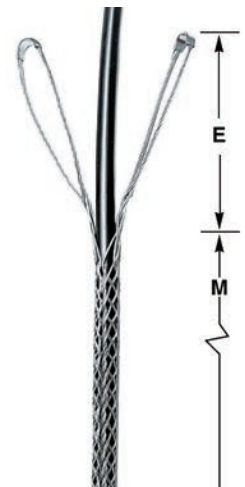

Note: E-Eye length. M-Mesh length at nominal diameter.



**IMPORTANT**

Read all breaking strength, safety and technical data relating to this product. Pages V-41 to V-45.

**Light Duty, Single Eye, Closed Mesh, Single Weave**

For permanent support when cable end is available to be installed.

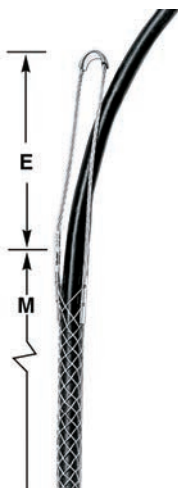

Cable Diameter Range Inches (cm)	Approx. Breaking Strength Lbs. (N)		E Inches (cm)	M Inches (cm)	Tin-Coated Bronze	Stainless Steel
	Tin-Coated Bronze	Stainless Steel				
.23"-.31" (.58-.79)	290 (1,290)	700 (3,114)	3" (7.62)	3.75" (9.52)	<b>02216001</b>	<b>02416001</b>
.29"-.37" (.74-.94)	290 (1,290)	700 (3,114)	5" (12.70)	4.25" (10.79)	<b>02216002</b>	<b>02416002</b>
.35"-.44" (.89-1.12)	500 (2,224)	850 (3,781)	5.5" (13.97)	4.75" (12.06)	<b>02216003</b>	<b>02416003</b>
.41"-.50" (1.04-1.27)	500 (2,224)	850 (3,781)	5.5" (13.97)	5" (12.70)	<b>02216004</b>	<b>02416004</b>
.46"-.56" (1.17-1.42)	660 (2,936)	850 (3,781)	6" (15.24)	5.25" (13.33)	<b>02216005</b>	<b>02416005</b>
.52"-.62" (1.32-1.57)	790 (3,514)	1,050 (4,670)	7" (17.78)	6.25" (15.87)	<b>02216006</b>	<b>02416006</b>
.58"-.68" (1.47-1.73)	790 (3,514)	1,050 (4,670)	7" (17.78)	6" (15.24)	<b>02216007</b>	<b>02416007</b>
.64"-.75" (1.63-1.90)	790 (3,514)	1,050 (4,670)	7" (17.78)	6.75" (17.14)	<b>02216008</b>	<b>02416008</b>
.70"-.81" (1.78-2.06)	790 (3,514)	2,050 (9,119)	7" (17.78)	7.25" (18.41)	<b>02216009</b>	<b>02416009</b>
.75"-.87" (1.90-2.21)	1,020 (4,537)	2,050 (9,119)	8" (20.32)	8" (20.32)	<b>02216010</b>	<b>02416010</b>
.81"-.94" (2.06-2.39)	1,020 (4,537)	2,050 (9,119)	8" (20.32)	8.25" (20.95)	<b>02216011</b>	<b>02416011</b>
.87"-1.00" (2.21-2.54)	1,020 (4,537)	—	8" (20.32)	8.75" (22.22)	<b>02216012</b>	—
.94"-1.06" (2.39-2.69)	1,020 (4,537)	2,050 (9,119)	9" (22.86)	9" (22.86)	<b>02216013</b>	<b>02416013</b>
1.00"-1.18" (2.54-3.00)	1,020 (4,537)	2,050 (9,119)	9" (22.86)	9.5" (24.13)	<b>02216014</b>	<b>02416014</b>
1.06"-1.25" (2.69-3.17)	1,020 (4,537)	2,050 (9,119)	9" (22.86)	9.5" (24.13)	<b>02216015</b>	<b>02416015</b>

**Heavy Duty, Single Eye, Closed Mesh, Multi-Weave**

For permanent support when cable end is available to be installed.

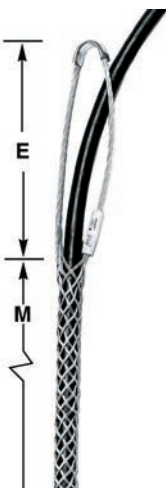

Cable Diameter Range Inches (cm)	Approx. Breaking Strength Lbs. (N)		E Inches (cm)	M Inches (cm)	Tin-Coated Bronze	Stainless Steel
	Tin-Coated Bronze	Stainless Steel				
.23"-.31" (.58-.79)	500 (2,224)	1,400 (6,228)	5" (12.70)	4.5" (11.43)	<b>02217001</b>	<b>02417001</b>
.29"-.37" (.74-.94)	500 (2,224)	1,150 (5,115)	5" (12.70)	5.5" (13.97)	<b>02217002</b>	<b>02417002</b>
.35"-.44" (.89-1.12)	870 (3,870)	1,700 (7,562)	6" (15.24)	6.5" (16.51)	<b>02217003</b>	<b>02417003</b>
.41"-.50" (1.04-1.27)	870 (3,870)	1,700 (7,562)	6" (15.24)	7.5" (19.05)	<b>02217004</b>	<b>02417004</b>
.46"-.56" (1.17-1.42)	1,050 (4,670)	2,100 (9,341)	6" (15.24)	8" (20.32)	<b>02217005</b>	<b>02417005</b>
.52"-.62" (1.32-1.57)	1,050 (4,670)	2,100 (9,341)	7" (17.78)	8.5" (21.59)	<b>02217006</b>	<b>02417006</b>
.58"-.68" (1.47-1.73)	1,050 (4,670)	2,100 (9,341)	7" (17.78)	9.5" (24.13)	<b>02217007</b>	<b>02417007</b>
.64"-.75" (1.63-1.90)	1,390 (6,183)	4,161 (18,509)	7" (17.78)	9.5" (24.13)	<b>02217008</b>	<b>02417008</b>
.70"-.81" (1.78-2.06)	1,390 (6,183)	4,100 (18,238)	8" (20.32)	10.5" (26.67)	<b>02217009</b>	<b>02417009</b>
.75"-.87" (1.90-2.21)	1,390 (6,183)	—	8" (20.32)	10.5" (26.67)	<b>02217010</b>	—
.81"-.94" (2.06-2.39)	1,390 (6,183)	—	8" (20.32)	10.5" (26.67)	<b>02217011</b>	—
.87"-1.00" (2.21-2.54)	1,790 (7,962)	5,350 (23,798)	8" (20.32)	11.5" (29.21)	<b>02217012</b>	<b>02417012</b>
.94"-1.06" (2.39-2.69)	1,790 (7,962)	5,300 (23,576)	9" (22.86)	12.5" (31.75)	<b>02217013</b>	<b>02417013</b>
1.00"-1.18" (2.54-3.00)	1,790 (7,962)	5,300 (23,576)	9" (22.86)	13.5" (34.29)	<b>02217014</b>	<b>02417014</b>
1.06"-1.25" (2.69-3.17)	1,790 (7,962)	5,350 (23,798)	9" (22.86)	14.5" (36.83)	<b>02217015</b>	<b>02417015</b>

Note: E-Eye length. M-Mesh length at nominal diameter.

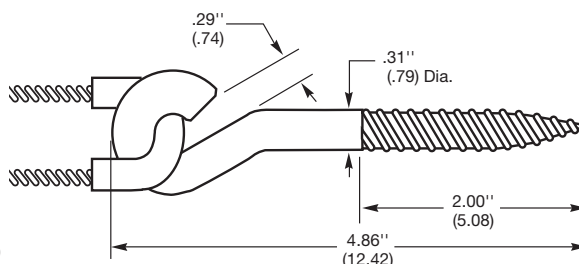

Screw Hook  
Catalog Number **20303001**  
Yield Strength 900 lbs (4003 N)

**IMPORTANT**

Read all breaking strength, safety and technical data relating to this product. Pages V-41 to V-45.

**Light Duty, Universal Eye, Closed Mesh, Single Weave**

For permanent support when cable end is available to be installed.

Cable Diameter Range Inches (cm)	Approx. Breaking Strength Lbs. (N)	E Inches (cm)	M Inches (cm)	Catalog Number
.23"-.31" (.58-.79)	290 (1,290)	9" (22.86)	3.75" (9.52)	<b>02216016</b>
.29"-.37" (.74-.94)	290 (1,290)	10" (25.40)	4.25" (10.79)	<b>02216017</b>
.35"-.44" (.89-1.12)	500 (2,224)	10" (25.40)	4.75" (12.06)	<b>02216018</b>
.41"-.50" (1.04-1.27)	500 (2,224)	11" (27.94)	5" (12.70)	<b>02216019</b>
.46"-.56" (1.17-1.42)	660 (2,936)	12" (30.48)	5.25" (13.33)	<b>02216020</b>
.52"-.62" (1.32-1.57)	790 (3,514)	13" (33.02)	6.25" (15.87)	<b>02216021</b>
.58"-.68" (1.47-1.73)	790 (3,514)	13" (33.02)	6.5" (16.51)	<b>02216022</b>
.64"-.75" (1.63-1.90)	790 (3,514)	13" (33.02)	6.75" (17.14)	<b>02216023</b>
.70"-.81" (1.78-2.06)	790 (3,514)	13" (33.02)	7.25" (18.41)	<b>02216024</b>
.75"-.87" (1.90-2.21)	1,020 (4,537)	14" (35.56)	8" (20.32)	<b>02216025</b>
.81"-.94" (2.06-2.39)	1,020 (4,537)	14" (35.56)	8.25" (20.95)	<b>02216026</b>
.87"-1.00" (2.21-2.54)	1,020 (4,537)	14" (35.56)	8.75" (22.22)	<b>02216027</b>
.94"-1.06" (2.39-2.69)	1,020 (4,537)	15" (38.10)	9" (22.86)	<b>02216028</b>
1.00"-1.18" (2.54-3.00)	1,020 (4,537)	15" (38.10)	9.5" (24.13)	<b>02216029</b>
1.06"-1.25" (2.69-3.17)	1,020 (4,537)	15" (38.10)	9.5" (24.13)	<b>02216030</b>



**Heavy Duty, Universal Eye, Closed Mesh, Multi-Weave**

For permanent support when cable end is available to be installed.

Cable Diameter Range Inches (cm)	Approx. Breaking Strength Lbs. (N)	E Inches (cm)	M Inches (cm)	Catalog Number
.23"-.31" (.58-.79)	500 (2,224)	11" (27.94)	4.5" (11.43)	<b>02217016</b>
.28"-.37" (.74-.94)	500 (2,224)	11" (27.94)	5.5" (13.97)	<b>02217017</b>
.35"-.44" (.89-1.12)	870 (3,870)	12" (30.48)	6.5" (16.51)	<b>02217018</b>
.41"-.50" (1.04-1.27)	870 (3,870)	12" (30.48)	7.5" (19.05)	<b>02217019</b>
.46"-.56" (1.17-1.42)	1,050 (4,670)	12" (30.48)	8" (20.32)	<b>02217020</b>
.52"-.62" (1.32-1.57)	1,050 (4,670)	13" (33.02)	8.5" (21.59)	<b>02217021</b>
.58"-.68" (1.47-1.73)	1,050 (4,670)	13" (33.02)	9.5" (24.13)	<b>02217022</b>
.64"-.75" (1.63-1.90)	1,390 (6,183)	13" (33.02)	9.5" (24.13)	<b>02217023</b>
.70"-.81" (1.78-2.06)	1,390 (6,183)	14" (35.56)	10.5" (26.67)	<b>02217024</b>
.75"-.87" (1.90-2.21)	1,390 (6,183)	14" (35.56)	10.5" (26.67)	<b>02217025</b>
.81"-.94" (2.06-2.39)	1,390 (6,183)	14" (35.56)	10.5" (26.67)	<b>02217026</b>
.87"-1.00" (2.21-2.54)	1,790 (7,962)	14" (35.56)	11.5" (29.21)	<b>02217027</b>
.94"-1.06" (2.39-2.69)	1,790 (7,962)	15" (38.10)	12.5" (31.75)	<b>02217028</b>
1.00"-1.18" (2.54-3.00)	1,790 (7,962)	15" (38.10)	13.5" (34.29)	<b>02217029</b>
1.06"-1.25" (2.69-3.17)	1,790 (7,962)	15" (38.10)	14.5" (36.83)	<b>02217030</b>



Note: E-Eye length. M-Mesh length at nominal diameter.



**IMPORTANT**  
Read all breaking strength, safety and technical data relating to this product. Pages V-41 to V-45.



**Safety Spring**

Maximum Deflection Inches/Lbs (cm/N)	Approx. Breaking Strength Lbs. (N)	Length* Inches (cm)	Diameter Inches (cm)	Model Lbs. (N)	Catalog Number
2¾" at 40 lbs. (6.98 at 178)	500 (2,224)	8.25" (20.95)	.75" (1.90)	40 lb. spring (178)	<b>20302001</b>
3½" at 80 lbs. (7.94 at 356)	850 (3,781)	8.25" (20.95)	1" (2.54)	80 lb. spring (356)	<b>20302002</b>

*Note: Springs can be used with single eye grips by disassembling drawbar from coil, placing through eye and replacing drawbar. \*No load.*



**Single Eye, Wide Range**

Cable Diameter Range Inches (cm)	Approx. Breaking Strength Lbs. (N)	E Inches (cm)	M Inches (cm)	Catalog Number
.24"- .32" (.61-.81)	350 (1,557)	3" (7.62)	3.5" (8.89)	<b>073041276**</b>
.32"- .43" (.81-1.09)	450 (2,002)	4" (10.16)	4" (10.16)	<b>073041277</b>
.43"- .56" (1.09-1.42)	550 (2,446)	6" (15.24)	4.75" (12.06)	<b>073041278</b>
.56"- .73" (1.42-1.85)	1,000 (4,448)	7" (17.78)	6" (15.24)	<b>073041279</b>
.73"- .85" (1.85-2.16)	1,400 (6,227)	7" (17.78)	6.75" (17.14)	<b>073041280</b>
.85"-1.00" (2.16-2.54)	1,400 (6,227)	8" (20.32)	8" (20.32)	<b>073041281</b>
1.00"-1.25" (2.54-3.17)	1,500 (6,672)	9" (22.86)	9.5" (24.13)	<b>073041282</b>

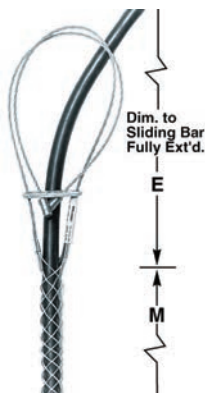

**Universal Eye, Wide Range**

Cable Diameter Range Inches (cm)	Approx. Breaking Strength Lbs. (N)	E Inches (cm)	M Inches (cm)	Catalog Number
.32"- .43" (.81-1.09)	450 (2,002)	10" (25.40)	4" (10.16)	<b>073041284</b>
.43"- .56" (1.09-1.42)	550 (2,446)	12" (30.48)	4.75" (12.06)	<b>073041285</b>
.56"- .73" (1.42-1.85)	1,000 (4,448)	13" (33.02)	6" (15.24)	<b>073041286</b>
.73"- .85" (1.85-2.16)	1,400 (6,227)	13" (33.02)	6.75" (17.14)	<b>073041287</b>
.85"-1.00" (2.16-2.54)	1,400 (6,227)	14" (35.56)	8" (20.32)	<b>073041288</b>
1.00"-1.25" (2.54-3.17)	1,500 (6,672)	15" (38.10)	9.5" (24.13)	<b>073041289</b>

*Note: E-Eye length. M-Mesh length at nominal diameter. \*\*Item indicated is not UL listed.*

**Bus Drop Grips and Safety Springs**

Kellems Bus Drop Grips are offered with either a single eye or universal bale attachment. The mesh is single weave galvanized steel with the patented wide range construction. They are suitable for indoor use only. Consult Technical Service for Stainless Steel Grips.

**Application**

Bus Drop Grips provide a safe, easy and economical method to support flexible cord or bus drop cable at bus duct and other industrial areas.

**Benefits**

- Easily installed.
- Absorb tension, vibration and pull with no cable damage.
- Patented mesh construction.

**Safety Spring**

Springs can be used with single eye grips by disassembling drawbar from coil, placing through eye and replacing drawbar.

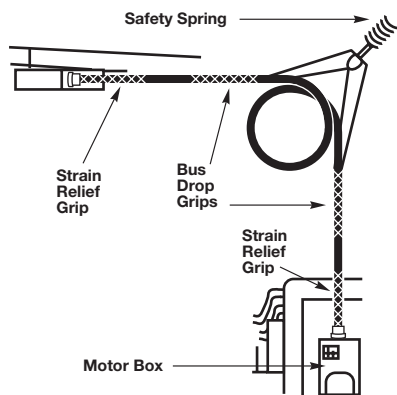



**Single Weave, Closed Mesh**

Kellems® Conduit Riser Support Grips are available in closed mesh and in split mesh with lace or rod closures, to cover all applications including single cable or multiple wire support. Refer to page V-45 for grip selection assistance for cable bundles. The standard material is tin-coated bronze strand. The grip is permanently fastened to a support ring, resulting in a one piece unit which will allow air ventilation within the conduit. The ring will fit standard electrical rigid metal conduit and schedule 40 rigid PVC conduit only. See page V-40 for ring dimensions. For permanent support when cable end is available to be installed through the grip.

**IMPORTANT**  
Read all breaking strength, safety and technical data relating to this product. Pages V-41 and V-45.



**Suitable For Standard Electrical Rigid Metal Conduit and Schedule 40 Rigid PVC Conduit Only**

Cable Sizes In. (cm)	.50"-.62" (1.27-1.57)	.63"-.74" (1.60-1.88)	.75"-.99" (1.90-2.51)	1.00"- 1.24" (2.54-3.15)	1.25"- 1.49" (3.17-3.78)	1.50"-1.74" (3.81-4.42)	1.75"-1.99" (4.44-5.05)	2.00"- 2.49" (5.08-6.32)	2.50" -2.99" (6.35-7.59)	3.00"- 3.49" (7.62-8.86)	3.50"- 3.99" (8.89-10.13)
Model	<b>R050</b>	<b>R062</b>	<b>R075</b>	<b>R100</b>	<b>R125</b>	<b>R150</b>	<b>R175</b>	<b>R200</b>	<b>R250</b>	<b>R300</b>	<b>R350</b>
Length In. (cm)	8" (20.32)	9" (22.86)	11" (27.94)	12" (30.48)	12" (30.48)	14" (35.56)	15" (38.10)	17" (43.18)	18" (45.72)	20" (50.80)	21" (53.34)
<b>Conduit Sizes</b>											
Inches	Catalog Number Approx. Breaking Strength Lbs. (N)										
¾	<b>02211106</b> 530 (2,357)	-	-	-	-	-	-	-	-	-	-
1	<b>02211100</b> 490 (2,179)	<b>02211101</b> 790 (3,514)	-	-	-	-	-	-	-	-	-
1¼	<b>02211001</b> 450 (2,002)	<b>02211002</b> 740 (3,292)	<b>02211003</b> 1,030 (4,581)	-	-	-	-	-	-	-	-
1½	-	<b>02211006</b> 690 (3,069)	<b>02211007</b> 970 (4,315)	<b>02211009</b> 1,610 (7,161)	-	-	-	-	-	-	-
2	-	<b>02211107</b> 640 (2,847)	<b>02211010</b> 920 (4,092)	<b>02211012</b> 1,520 (6,761)	<b>02211013</b> 1,610 (7,161)	-	-	-	-	-	-
2½	-	-	-	-	<b>02211017</b> 1,510 (6,716)	<b>02211018</b> 1,610 (7,161)	<b>02211019</b> 2,150 (9,563)	-	-	-	-
3	-	-	-	<b>02211022</b> 1,340 (5,960)	<b>02211023</b> 1,400 (6,227)	<b>02211024</b> 1,490 (6,627)	<b>02211025</b> 1,990 (8,851)	<b>02211026</b> 3,260 (14,500)	-	-	-
3½	-	-	-	-	-	-	-	<b>02211033</b> 2,970 (13,211)	<b>02211034</b> 3,260 (14,500)	-	-
4	-	-	-	-	-	-	<b>02211040</b> 1,670 (7,248)	<b>02211041</b> 2,680 (11,921)	<b>02211042</b> 2,890 (12,855)	<b>02211043</b> 4,080 (18,148)	-
5	-	-	-	-	-	-	-	-	<b>02211061</b> 2,150 (9,563)	<b>02211062</b> 2,860 (12,721)	<b>02211063</b> 3,130 (13,922)
6	-	-	-	-	-	-	-	-	-	<b>02211072</b> 2,245 (9,986)	<b>02211073</b> 2,245 (9,986)

Note: See page V-45 for multiple cables in a single conduit riser grip.



**Double Weave, Split Mesh, Lace Closing**

Kellems® Conduit Riser Support Grips will support cable runs in vertical or sloping standard rigid conduit. The grip is fastened to a support ring which seats on the rim of the conduit. The entire grip is supported by the conduit itself and no other hardware is required. See page V-40 for ring dimensions. The rings will fit schedule 40 rigid PVC conduit and standard electrical rigid metal conduit only. For permanent support when cable end is not available.

**IMPORTANT**

Read all breaking strength, safety and technical data relating to this product. Pages V-41 and V-45.



**Suitable For Standard Electrical Rigid Metal Conduit and Schedule 40 Rigid PVC Conduit Only**

Cable Sizes In. (cm)	.75" - .99" (1.90-2.51)	1.00" - 1.24" (2.54-3.15)	1.25" - 1.49" (3.17-3.78)	1.50" - 1.74" (3.81-4.42)	1.75" - 1.99" (4.44-5.05)	2.00" - 2.49" (5.08-6.32)	2.50" - 2.99" (6.35-7.59)	3.00" - 3.49" (7.62-8.86)	3.50" - 3.99" (8.89-10.13)
Model	RS075	RS100	RS125	RS150	RS175	RS200	RS250	RS300	RS350
Length In. (cm)	11" (27.94)	12" (30.48)	12" (30.48)	14" (35.56)	15" (38.10)	17" (43.18)	18" (45.72)	20" (50.80)	21" (53.34)
Conduit Sizes Inches	Catalog Number Approx. Breaking Strength Lbs. (N)								
1¼	<b>02212003</b> 1,580 (7,028)	—	—	—	—	—	—	—	—
1½	<b>02212007</b> 1,500 (6,672)	—	—	—	—	—	—	—	—
2	<b>02212010</b> 1,430 (6,361)	<b>02212012</b> 1,930 (8,585)	<b>02212013</b> 2,040 (9,074)	—	—	—	—	—	—
2½	—	—	<b>02212017</b> 1,910 (8,496)	<b>02212018</b> 2,040 (9,074)	—	—	—	—	—
3	—	—	<b>02212023</b> 1,780 (7,917)	<b>02212024</b> 1,890 (8,407)	<b>02212025</b> 2,520 (11,209)	<b>02212026</b> 4,300 (19,126)	—	—	—
3½	—	—	—	—	—	<b>02212033</b> 3,910 (17,392)	<b>02212034</b> 4,300 (19,126)	—	—
4	—	—	—	—	<b>02212040</b> 2,110 (9,385)	<b>02212041</b> 3,530 (15,701)	<b>02212042</b> 3,820 (16,991)	<b>02212043</b> 5,380 (23,930)	—
5	—	—	—	—	—	—	<b>02212061</b> 2,860 (12,721)	—	—
6	—	—	—	—	—	—	—	—	<b>02212073</b> 2,955 (13,144)

Note: See page V-45 for multiple cables in a single conduit riser grip.



**Single Weave, Split Mesh, Rod Closing Benefits**

- Easy and fast to install.
- Will not damage electrical cable.
- Allows cable to expand or contract.
- Ideal way to hold cable in vertical conduit.
- Prevents cable creep in conduit.
- Helps prevent cable pullouts.
- The rings will fit schedule 40 rigid PVC conduit and standard electrical rigid metal conduit only.
- For support when cable end is not available.

**IMPORTANT**  
Read all breaking strength, safety and technical data relating to this product. Pages V-41 and V-45.



**Suitable For Standard Electrical Rigid Metal Conduit and Schedule 40 Rigid PVC Conduit Only**

Cable Sizes In. (cm)	.75" - .99" (1.90-2.51)	1.00" - 1.24" (2.54-3.15)	1.25" - 1.49" (3.17-3.78)	1.50" - 1.74" (3.81-4.42)	1.75" - 1.99" (4.44-5.05)	2.00" - 2.49" (5.08-6.32)	2.50" - 2.99" (6.35-7.59)	3.00" - 3.49" (7.62-8.86)	3.50" - 3.99" (8.89-10.13)	
Model	RR075	RR100	RR125	RR150	RR175	RR200	RR250	RR300	RR350	
Length In. (cm)	11" (27.94)	12" (30.48)	12" (30.48)	14" (35.56)	15" (38.10)	17" (43.18)	18" (45.72)	20" (50.80)	21" (53.34)	
Conduit Sizes Inches	Catalog Number		Approx. Breaking Strength Lbs. (N)							
1¼	<b>02213003</b> 1,020 (4,537)	—	—	—	—	—	—	—	—	
1½	<b>02213007</b> 970 (4,315)	<b>02213009</b> 1,610 (7,161)	—	—	—	—	—	—	—	
2	—	<b>02213012</b> 1,520 (6,761)	<b>02213013</b> 1,610 (7,161)	—	—	—	—	—	—	
2½	—	—	<b>02213017</b> 1,510 (6,716)	<b>02213018</b> 1,610 (7,161)	—	—	—	—	—	
3	—	—	<b>02213023</b> 1,400 (6,227)	<b>02213024</b> 1,490 (6,627)	<b>02213025</b> 1,990 (8,851)	<b>02213026</b> 3,260 (14,500)	—	—	—	
3½	—	—	—	—	—	<b>02213033</b> 2,970 (13,211)	—	—	—	
4	—	—	—	—	—	<b>02213041</b> 2,670 (11,876)	<b>02213042</b> 2,890 (12,855)	—	—	

Note: See page V-45 for multiple cables in a single conduit riser grip.



**Conduit Ring Dimensions**

Ring dimensions are found in the chart below. The ring material is corrosion resistant. These rings will fit schedule 40 rigid PVC conduit and standard electrical rigid metal conduit only.

**IMPORTANT**  
Read all breaking strength, safety and technical data relating to this product. Pages V-41 to V-45.

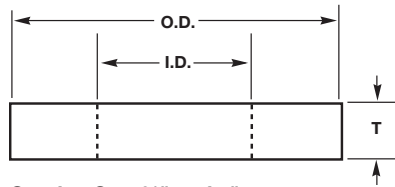

**Conduit Size 3/4" and 1"**

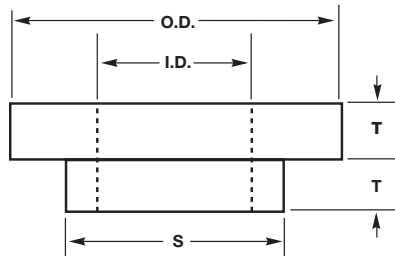

**Conduit Size 1 1/4" to 6"**

Conduit Size Inches	Ring Number	O.D. Inches (cm)	I.D. Inches (cm)	S Inches (cm)	T Inches (cm)
3/4	C-3/4	.94" (2.39)	.62" (1.57)	—	.19" (.48)
1	C-1	1.17" (2.97)	.80" (2.03)	—	.19" (.48)
1 1/4	C-1 1/4	1.50" (3.81)	1.03" (2.62)	1.31" (3.33)	.16" (.41)
1 1/2	C-1 1/2	1.76" (4.47)	1.23" (3.12)	1.52" (3.86)	.16" (.41)
2	C-2	2.23" (5.66)	1.55" (3.94)	1.97" (5.00)	.16" (.41)
2 1/2	C-2 1/2	2.67" (6.78)	2.05" (5.21)	2.40" (6.10)	.16" (.41)
3	C-3	3.20" (8.13)	2.55" (6.48)	2.97" (7.54)	.22" (.56)
3 1/2	C-3 1/2	3.80" (9.65)	3.05" (7.75)	3.47" (8.81)	.22" (.56)
4	C-4	4.30" (10.92)	3.55" (9.02)	3.94" (10.01)	.22" (.56)
4 1/2	C-4 1/2	4.80" (12.19)	4.03" (10.24)	4.45" (11.30)	.22" (.56)
5	C-5	5.30" (13.46)	4.46" (11.33)	4.96" (12.60)	.22" (.56)
6	C-6	6.30" (16.00)	5.36" (13.61)	5.96" (15.14)	.25" (.63)





## Kellems® Support Grips

Kellems Support Grips are used to hold the weight of electrical cable as it hangs in a vertical, sloping or horizontal position. Electrical cable must be supported, or its dead weight can cause excessive strain or pullout at the connections resulting in power failure. Support grips also absorb additional strain from flexure, vibration, expansion and contraction. Kellems Support Grips listed in this catalog are made of high grade, non-magnetic tin-coated bronze strand. Stainless steel grips, made of alloy 302-304 SST for severe service or unusual environmental conditions, are available on request.

### Select the Correct Support Grip

Each Kellems grip is designed to work on a specific range of cable diameters.

- Step 1** Refer to the Kellems chart below to determine the grip style best suited for your application.
- Step 2** Determine your cable outside diameter.
- Step 3** Find the grip size that encompasses your cable diameter.
- Step 4** Whenever possible, use a closed mesh that assembles over the cable end. If the cable end is not available, use a split mesh.
- Step 5** Where available, select an eye style that suits your needs.
- Step 6** Select the proper material—tinned bronze or stainless steel\*.
- Step 7** Estimate the tension to be put on the grip, establish the working load you require and compare this to the listed approximate breaking strength of the grip to insure that the grip will be strong enough. Refer to page V-42 for safety and working load considerations.

**CAUTION:** It is very important to comply with all of the following precautions.

1. Support grips are to be installed by a qualified individual in accordance with all applicable national and local safety, electrical and rigging codes.
2. Ensure that the correct grip is selected for your specific needs.
3. Do not use a support grip for any application other than supporting cable.
4. Thoroughly examine the grip for damage. Do not use a damaged grip.
5. Ensure that the recommended work load of the grip is suitable for the application. Never use grips at their approximated rated breaking strength. A safety factor of 10 is recommended for support grips.
6. Do not alter grips in any way. For example, do not flatten, straighten, bend or otherwise modify eye tubes, hooks, and strand equalizers.
7. Do not attach any type of hook, clamp or other hardware directly to the stranded bale of a “U” eye support grip. The formed eye tube is the only acceptable means of attachment to external hardware.
8. Always apply 2 bands at 1" and 2" respectively, from the tail end of the mesh to guard against accidental release of the grip. Accidental release can occur if an object contracts and pushes against the tail end of the mesh, thereby expanding and releasing it's hold.

### Support Grip Selection Chart

Grip Styles	Application	Page
Closed mesh	Standard, permanent support, cable end available.	V-28 to V-36
Split lace closing	Standard, permanent support, cable end unavailable.	V-28 to V-33
Split rod closing	Standard, temporary support, cable end unavailable. Tape or band tail end of wire mesh grip after positioning for permanent support.	V-28 to V-31
Material*	Tin-coated bronze standard or stainless steel by special request.	V-28 to V-34
Standard support grips	Support vertical runs to 99 ft. loads to 600 lbs.	V-28 to V-31
Heavy duty grips	Support vertical runs over 100 ft. loads over 600 lbs.	V-32, V-33
Service drop	Light duty to support service entrance cable.	V-34, V-35
Bus drop	Light duty support, indoors only, on Bus drop cable.	V-36
Conduit riser	Support cable runs in rigid (Schedule 40) conduit.	V-37 to V-39
Fiber optic cable support grips	Support fiber optic cable.	V-50

*Note: \*Most catalog listed support grips are made of tin-coated bronze strand. To order stainless steel support grips, change the first three catalog number digits from 022-0x-xxx to 024-0x-xxx. Consult Technical Service for details.*

### Eye Styles



Single

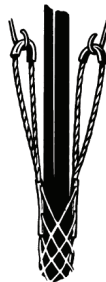

Double



Universal



Offset



**Safety And Working Load Factors For Wire Mesh Grips**

The broad application of Kellems grips on a wide variety of objects requires that adequate safety factors be used to establish working loads. The approximate breaking strength of a Kellems grip represents an average calculation based on data established from actual direct tension testing done in our engineering laboratories.

It is impossible to catalog or guarantee a safety factor suitable for all applications as operating conditions are never the same. The tension, diameter, movement, number of objects gripped, gripping surface, and the attachments used are just some of the factors which vary with each application. These factors, together with the effects of abrasion, corrosion, prior use or abuse and any other variables of a specific application, must be considered by the user and

the grip replaced as appropriate. Where the conditions of the application are not well defined or known, or where risk of injury to persons or property is involved, a greater safety factor should be utilized.

**Under normal conditions, Kellems' recommended factor of safety is five for catalog listed pulling grips, and ten for catalog listed support grips.**

Any warranty as to quality, performance or fitness for use of grips is always premised on the condition that the published breaking strengths apply only to new, unused grips, and that such products are properly stored, handled, used, maintained, and inspected by the user at a frequency appropriate for the use and condition of the grip.

**Examples**

Grip Style	Approx. Breaking Strength Lbs. (N)	Safety Factor	Max. Recommended Load Lbs. (N)	Catalog Number
Pulling Grips	27,200 (120,986)	5	5,440 (24,197)	<b>03301027</b>
Support Grips	1,610 (7,161)	10	161 (716)	<b>02202019</b>

The maximum recommended working load is the tension to be exerted on the grip in application with a margin of safety to take care of unforeseen and unusual circumstances.

It is the end-user's decision to determine how much of a safety factor is acceptable for the application.

The metric unit of measure (force) for breaking strength and load is newtons (N). To convert from newtons to the metric unit of weight (kilograms) the conversion factor is 9.808 newtons/kilogram.

**Support Grip Materials**

Material	Features	Grip Type
Tin-coated bronze wire	<ul style="list-style-type: none"> <li>• Corrosion resistant for normal outside areas</li> <li>• Non-magnetic</li> <li>• Moderate strength</li> </ul>	<ul style="list-style-type: none"> <li>• Support grips</li> <li>• Service drop grips</li> <li>• Conduit riser grips</li> </ul>
Stainless steel wire (302-304)	<ul style="list-style-type: none"> <li>• High strength</li> <li>• Corrosion resistant</li> </ul>	<ul style="list-style-type: none"> <li>• Support grips</li> <li>• Hose containment grips</li> </ul>
Galvanized steel wire	<ul style="list-style-type: none"> <li>• Slightly magnetic</li> <li>• Not subject to continuous outside environment</li> </ul>	<ul style="list-style-type: none"> <li>• Bus drop grips</li> </ul>

**Approvals**

CSA Certifications are indicated on appropriate product catalog pages.

*Note: It is always recommended that the tail end of the grip be banded after the installation on the cable to prevent accidental release of the mesh. See page V-15 for end bands.*



### Split Support Grip Lace Closing Instructions

Single Weave Grips should be laced with single strand lacing; double weave with double strand. Lacing strands should be the same material as the grip. Kellems supplies the appropriate lacing with each grip.

1. Start the lacing at the lead or anchoring end of the grip. Thread the lacings through the first two loops of the split and pull through until the lacings are centered at this point. Lace as you would your shoe, crossing the lacings before lacing the next two loops.
2. Don't pull lacing too tight. Leave a space between adjoining loops approximately equal to the width of one diamond of the mesh.
3. Twist the lacing strands tightly together at the tail end of the grip.
4. Wrap the ends of the lacings once or twice tightly around the tail of the grip, twisting the ends together securely. Excess lace can be cut off.



### Split Support Grip Rod Closing Instructions

The stainless steel rod is a precise built-in feature which makes threading easy and fast. The strands of the mesh pass around the rod and match up with the strands from the opposite direction. The rod does not touch the cable at any point and therefore cannot cut the cable. Rod Closing Grips are reusable. They may be removed and reused as many times as desired.

#### 1. Fast to install

Wrap the grip around the cable and thread the rod through the pre-formed loops with a corkscrew motion, using the curved end of the rod to engage the loops.

2. The action required is a steady push and twist simultaneously. The fingers of the left hand are used to bring the loops together just ahead of the hook on the end of the rod.
3. To remove, simply pull the rod out.





## For Support Grips Only\*

### Multiple Cable Selection Charts for Cables and Wires of Unequal Diameters

#### How to choose the correct grip size:

1. Find the Grip Circumference Range by measuring the circumference of the bundle of different diameter cables to be gripped (see illustration).
2. Divide the bundle circumference by 3.14 to determine the diameter.
3. Choose a grip offering a range of cable diameters the same as the cable diameter.

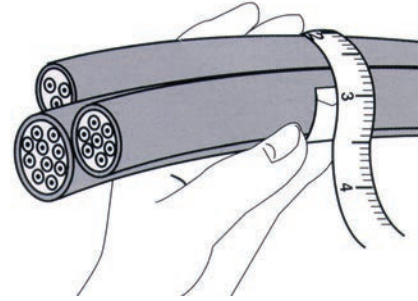

### For Cables of Equal Diameters

Under "Number of Cables in One Grip", find the diameter of your single cable in vertical column. Read the grip diameter range to the right.

If your diameter is the maximum of the range shown, go to the next larger size for Split Grips, stay with the same size for Closed Grips.

**Example:** 3 cables, each with .89" (2.26) diameter, for a Closed Grip select the 1.50"-1.74" (3.81-4.42) range, for a Split Grip select the 1.75"-1.99" (4.44-5.05) range.

### Number of Cables in One Grip

2	3	4	5	6 and 7	8	9	Grip Dia. Range Inches (cm)
.30-.38 (.76-.97)	.25-.31 (.63-.79)	.22-.27 (.56-.69)	.19-.24 (.48-.61)	.17-.22 (.43-.56)	.15-.19 (.38-.48)	.14-.18 (.36-.46)	.50-.61 (1.27-1.55)
.38-.44 (.97-1.12)	.31-.36 (.79-.91)	.27-.31 (.69-.79)	.24-.29 (.61-.74)	.22-.26 (.56-.66)	.19-.23 (.48-.58)	.18-.21 (.46-.53)	.62-.74 (1.57-1.88)
.44-.59 (1.12-1.50)	.36-.49 (.91-1.24)	.31-.42 (.79-1.07)	.29-.38 (.74-.97)	.26-.34 (.66-.86)	.23-.31 (.58-.79)	.21-.28 (.53-.71)	.75-.99 (1.90-2.51)
.59-.75 (1.50-1.90)	.49-.63 (1.24-1.60)	.42-.54 (1.07-1.37)	.38-.48 (.97-1.22)	.34-.43 (.86-1.09)	.31-.39 (.79-.99)	.28-.35 (.71-.89)	1.00-1.24 (2.54-3.15)
.75-.90 (1.90-2.29)	.63-.76 (1.60-1.93)	.54-.65 (1.37-1.65)	.48-.58 (1.22-1.47)	.43-.52 (1.09-1.32)	.39-.46 (.99-1.17)	.35-.42 (.89-1.07)	1.25-1.49 (3.17-3.78)
.90-1.07 (2.29-2.72)	.76-.89 (1.93-2.26)	.65-.77 (1.65-1.96)	.58-.67 (1.47-1.70)	.52-.60 (1.32-1.52)	.46-.54 (1.17-1.37)	.42-.49 (1.07-1.24)	1.50-1.74 (3.81-4.42)
1.07-1.22 (2.72-3.10)	.89-1.02 (2.26-2.59)	.77-.88 (1.96-2.24)	.67-.77 (1.70-1.96)	.60-.69 (1.52-1.75)	.54-.62 (1.37-1.57)	.49-.56 (1.24-1.42)	1.75-1.99 (4.44-5.05)
1.22-1.53 (3.10-3.89)	1.02-1.28 (2.59-3.25)	.88-1.10 (2.24-2.79)	.77-.96 (1.96-2.44)	.69-.86 (1.75-2.18)	.62-.77 (1.57-1.96)	.56-.71 (1.42-1.80)	2.00-2.49 (5.08-6.32)
1.53-1.83 (3.89-4.65)	1.28-1.53 (3.25-3.89)	1.10-1.32 (2.79-3.35)	.96-1.16 (2.44-2.95)	.86-1.03 (2.18-2.62)	.77-.93 (1.96-2.36)	.71-.85 (1.80-2.16)	2.50-2.99 (6.35-7.59)
1.83-2.14 (4.65-5.44)	1.53-1.79 (3.89-4.55)	1.32-1.54 (3.35-3.91)	1.16-1.35 (2.95-3.43)	1.03-1.20 (2.62-3.05)	.93-1.08 (2.36-2.74)	.85-.99 (2.16-2.51)	3.00-3.49 (7.62-8.86)
2.14-2.44 (5.44-6.20)	1.79-2.05 (4.55-5.21)	1.54-1.76 (3.91-4.47)	1.35-1.54 (3.43-3.91)	1.20-1.37 (3.05-3.48)	1.08-1.24 (2.74-3.15)	.99-1.13 (2.51-2.87)	3.50-3.99 (8.89-10.13)
2.44-2.75 (6.20-6.98)	2.05-2.30 (5.21-5.84)	1.76-1.98 (4.47-5.03)	1.54-1.74 (3.91-4.42)	1.37-1.55 (3.48-3.94)	1.24-1.39 (3.15-3.53)	1.13-1.27 (2.87-3.23)	4.00-4.49 (10.16-11.40)
2.75-3.06 (6.98-7.77)	2.30-2.56 (5.84-6.50)	1.98-2.20 (5.03-5.59)	1.74-1.93 (4.42-4.90)	1.55-1.72 (3.94-4.37)	1.39-1.55 (3.53-3.94)	1.27-1.41 (3.23-3.58)	4.50-4.99 (11.43-12.67)

Note: \*This chart is to be used for determining grip size when multiple cables are held in a single Support Grip. For Conduit Riser multiple cable selection, see page V-45. It is always recommended that, when multiple cables are installed in a Support Grip, the tail end of the grip be banded after installation on the cable bundle. See page Tech-23 for cable and wire charts.



## For Conduit Riser Grips Only\*

### Multiple Cable Selection Charts for Cables and Wires of Unequal Diameters

#### How to choose the correct grip size:

1. Find the Grip Circumference Range by measuring the circumference of the bundle of different diameter cables to be gripped (see illustration).
2. Divide the bundle circumference by 3.14 to determine the diameter.
3. Choose a grip offering a range of cable diameters the same as the cable diameter.

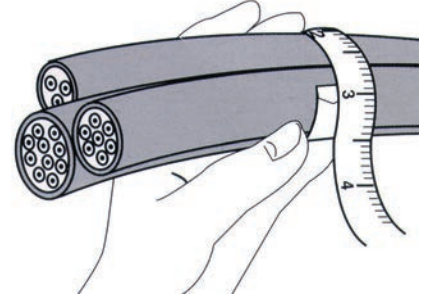

#### For Cables of Equal Diameters

Under "Number of Cables in One Grip", find the diameter of your single cable in vertical column. Read the grip diameter range to the right.

If your diameter is the maximum of the range shown, go to the next larger size for Split Grips, stay with the same size for Closed Grips.

**Example:** 3 cables, each with .85" (2.16) diameter, for a Closed Grip select the 1.50"-1.74" (3.81-4.42) range, for a Split Grip select the 1.75"-1.99" (4.44-5.05) range.

#### Number of Equal Diameter Cables in One Grip

2	3	4	5	6 and 7	8	9	Grip Dia. Range Inches (cm)
.29-.36 (.74-.91)	.24-.30 (.61-.76)	.21-.25 (.53-.63)	.18-.22 (.46-.56)	.16-.20 (.41-.51)	.15-.18 (.38-.46)	.14-.17 (.36-.43)	.50-.62 (1.27-1.57)
.37-.43 (.94-1.09)	.31-.36 (.79-.91)	.26-.30 (.66-.76)	.23-.27 (.58-.69)	.21-.24 (.53-.61)	.19-.22 (.48-.56)	.18-.20 (.46-.51)	.63-.74 (1.60-1.88)
.44-.58 (1.12-1.47)	.37-.48 (.94-1.22)	.31-.41 (.79-1.04)	.28-.36 (.71-.91)	.25-.32 (.63-.81)	.23-.29 (.58-.74)	.21-.27 (.53-.69)	.75-.99 (1.90-2.51)
.59-.72 (1.50-1.83)	.49-.60 (1.24-1.52)	.42-.51 (1.07-1.30)	.37-.45 (.94-1.14)	.33-.40 (.84-1.02)	.30-.36 (.76-.91)	.28-.34 (.71-.86)	1.00-1.24 (2.54-3.15)
.73-.87 (1.85-2.21)	.61-.72 (1.55-1.83)	.52-.61 (1.32-1.55)	.46-.54 (1.17-1.37)	.41-.48 (1.04-1.22)	.37-.43 (.94-1.09)	.35-.40 (.89-1.02)	1.25-1.49 (3.17-3.78)
.88-1.01 (2.24-2.57)	.73-.85 (1.85-2.16)	.62-.71 (1.57-1.80)	.55-.63 (1.40-1.60)	.49-.56 (1.24-1.42)	.44-.51 (1.12-1.30)	.41-.47 (1.04-1.19)	1.50-1.74 (3.81-4.42)
1.02-1.16 (2.59-2.95)	.86-.96 (2.18-2.44)	.72-.81 (1.83-2.06)	.64-.72 (1.63-1.83)	.57-.64 (1.45-1.63)	.52-.58 (1.32-1.49)	.48-.54 (1.22-1.37)	1.75-1.99 (4.44-5.05)
1.17-1.44 (2.97-3.66)	.97-1.20 (2.46-3.05)	.82-1.02 (2.08-2.59)	.73-.90 (1.85-2.29)	.65-.80 (1.65-2.03)	.59-.72 (1.50-1.83)	.55-.67 (1.40-1.70)	2.00-2.49 (5.08-6.32)
1.45-1.73 (3.68-4.39)	1.21-1.45 (3.07-3.68)	1.03-1.22 (2.62-3.10)	.91-1.08 (2.31-2.74)	.81-.96 (2.06-2.44)	.73-.87 (1.85-2.21)	.68-.81 (1.73-2.06)	2.50-2.99 (6.35-7.59)
1.74-2.02 (4.42-5.13)	1.46-1.69 (3.71-4.29)	1.23-1.43 (3.12-3.63)	1.09-1.26 (2.77-3.20)	.97-1.11 (2.46-2.82)	.83-1.01 (2.11-2.57)	.82-.94 (2.08-2.39)	3.00-3.49 (7.62-8.86)
2.03-2.31 (5.16-5.87)	1.70-1.93 (4.32-4.90)	1.44-1.63 (3.66-4.14)	1.27-1.44 (3.23-3.66)	1.12-1.27 (2.84-3.23)	1.02-1.15 (2.59-2.92)	.95-1.08 (2.41-2.74)	3.50-3.99 (8.89-10.13)

Note: \*This chart is to be used for determining grip size when multiple cables are held in a single Conduit Riser Grip. For Support Grip multiple cable selection, see page V-44. It is always recommended that, when multiple cables are installed in a Conduit Riser Grip, the tail end of the grip be banded after installation on the cable bundle. See page Tech-23 for cable and wire charts.

# Fiber Optic Cable Grips

Pulling and Support Grips



OPTISOK® Grip is a revolutionary tool to pull preterminated fiber optic cables. They will protect the connectors and guide the bundle through the pulling environment



Pulling Grips are used for outside plant cable. They are easy to install and remove, reusable, and have a slim profile for small build up



Grips for cable support are easy to install or position. They come in a closed style when the cable end is available, and a split rod style for mid-span installation. Will support the cable's weight as it hangs in vertical, sloping or horizontal position





**OPTISOK® Non-metallic Fiber Optic Pulling Tool For Preterminated, Inside Plant Fiber Optic Cables and Bundles of Twisted Pair**

**IMPORTANT**  
 Read all breaking strength, safety and technical data relating to this product. Pages V-51 to V-54.



**OPTISOK® Non-Metallic Fiber Optic Pulling Tool**

Bundle/Size Range Inches (cm)	Approx. O/A Length Inches (cm)	Ring O.D. Inches (cm)	Ring Thickness Inches (cm)	Maximum Work Load Lbs. (N)	Catalog Number
.125"-.562" (.318-1.427)	28" (71.12)	.71" (1.803)	.10" (.254)	30 (133)	<b>CCPS1</b>
.250"-.750" (.635-1.905)	31" (78.74)	.71" (1.803)	.10" (.254)	40 (178)	<b>CCPS2</b>
.750"-1.750" (1.905-4.445)	33" (83.82)	1.57" (3.988)	.16" (.406)	50 (222)	<b>CCPS3</b>

**Pulling Grip For Loose Tube Fiber Optic Cable, Galvanized Steel**

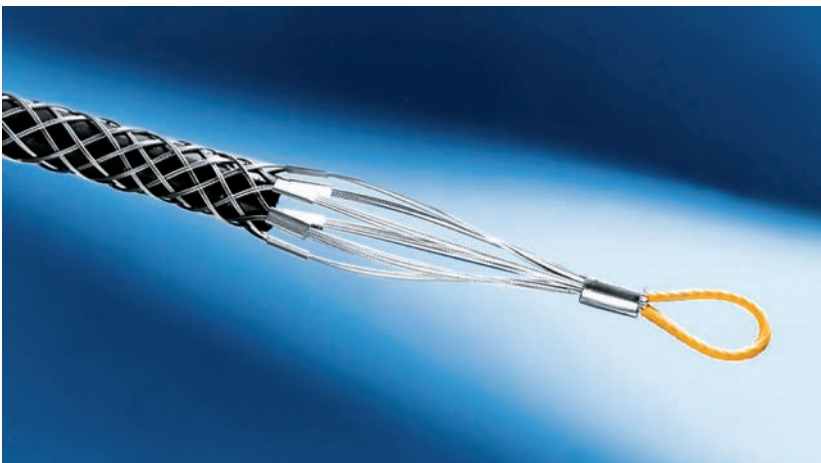

**Pulling Grip For Loose Tube Fiber Optic Cable, Galvanized Steel**

Diameter Range Inches (cm)	Mesh Length Inches (cm)	Eye Length Inches (cm)	Eye Diameter Inches (cm)	Lug Diameter Inches (cm)	Maximum Breaking Strength Lbs. (N)	Catalog Number
.312"-.625" (.79-1.59)	22.5" (57.15)	6.3" (16.00)	.20" (.51)	.51" (1.30)	3,000 (13,344)	<b>PFOLT312</b>



**IMPORTANT**  
 Read all breaking strength, safety and technical data relating to this product. Pages V-51 to V-54.

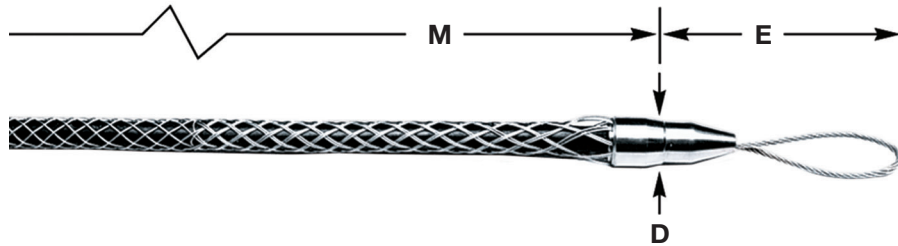

**Fiber Optic Pulling Grip, Flexible Eye**

Cable Diameter Range Inches (cm)	Approx. Breaking Strength Lbs. (N)	E Approx. Inches (cm)	M Approx. Inches (cm)	D Approx. Inches (cm)	Catalog Number
.10"-.22" (.25-.56)	1,000 (4,448)	5.5" (14)	9" (23)	0.8" (2)	<b>033291000</b>
.21"-.35" (.53-.89)	1,500 (6,672)	5.5" (14)	14" (36)	0.8" (2)	<b>033291001</b>
.32"-.48" (.81-1.22)	2,200 (9,786)	6.0" (15)	18" (46)	0.9" (2.29)	<b>033291002</b>
.42"-.61" (1.07-1.55)	2,800 (12,454)	6.0" (15)	21" (53)	0.9" (2.29)	<b>033291003</b>
.53"-.74" (1.35-1.88)	3,300 (14,678)	6.5" (17)	24" (61)	1.3" (3.30)	<b>033291004</b>
.64"-.87" (1.63-2.21)	4,700 (20,906)	6.5" (17)	27" (69)	1.3" (3.30)	<b>033291005</b>

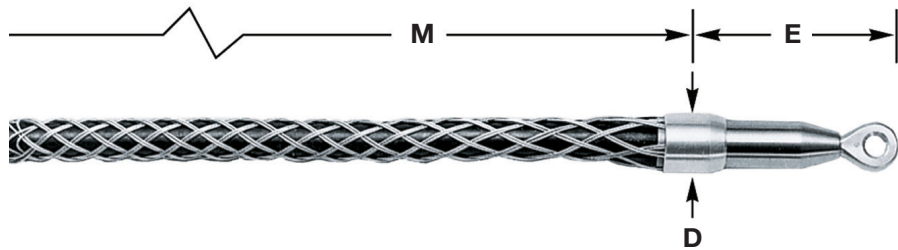

**Fiber Optic Pulling Grip, Swivel Eye**

Cable Diameter Range Inches (cm)	Approx. Breaking Strength Lbs. (N)	E Approx. Inches (cm)	M Approx. Inches (cm)	D Approx. Inches (cm)	Catalog Number
.21"-.35" (.53-.89)	1,500 (6,672)	4.0" (10.16)	14" (35.56)	0.9" (2.29)	<b>033291008</b>
.32"-.48" (.81-1.22)	2,200 (9,786)	4.0" (10.16)	18" (45.72)	0.9" (2.29)	<b>033291009</b>
.42"-.61" (1.07-1.55)	2,800 (12,454)	4.0" (10.16)	21" (53.34)	0.9" (2.29)	<b>033291010</b>
.53"-.74" (1.35-1.88)	3,250 (14,457)	4.8" (12.19)	24" (60.96)	1.3" (3.30)	<b>033291011</b>
.64"-.87" (1.63-2.21)	4,700 (20,906)	4.8" (12.19)	27" (68.58)	1.3" (3.30)	<b>033291012</b>

Note: E-Eye length. M-Mesh length at nominal diameter.



**IMPORTANT**

Read all breaking strength, safety and technical data relating to this product. Pages V-51 to V-54.

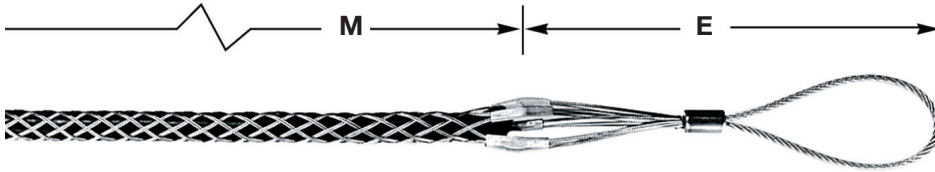

**Fiber Optic Pulling Grip, Flexible Eye, Low Profile, Double/Single Weave Mesh**

Cable Diameter Range Inches (cm)	Approx. Breaking Strength Lbs. (N)	E Approx. Inches (cm)	M Approx. Inches (cm)	Catalog Number
.10"-.22 (.25-.56)	900 (4,003)	7.5" (19)	10" (25)	<b>033291193</b>
.21"-.35" (.53-.89)	1,400 (6,227)	7.5" (19)	14" (36)	<b>033291194</b>
.32"-.48" (.81-1.22)	2,000 (8,896)	8.5" (22)	19" (48)	<b>033291195</b>
.42"-.61" (1.07-1.55)	2,500 (11,120)	8.5" (22)	21" (53)	<b>033291196</b>
.53"-.74" (1.35-1.88)	3,000 (13,344)	8.5" (22)	23" (58)	<b>033291197</b>
.64"-.87" (1.63-2.21)	4,200 (18,682)	8.5" (22)	25" (64)	<b>033291198</b>
.75"-1.00" (1.90-2.54)	4,200 (18,682)	8.5" (22)	28" (71)	<b>033291199</b>

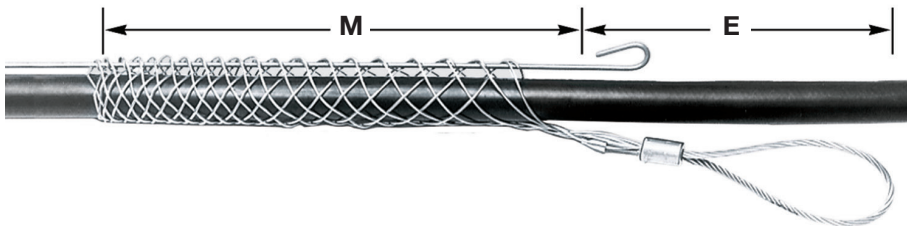

**Fiber Optic Slack Pulling Grip, Split Mesh Rod Closing, Single Weave**

Cable Diameter Range Inches (cm)	Approx. Breaking Strength Lbs. (N)	E Approx. Inches (cm)	M Approx. Inches (cm)	Catalog Number
.25"-.37" (.63-.94)	300 (1,334)	3" (7.6)	4.7" (12)	<b>033291015</b>
.38"-.49" (.97-1.24)	800 (3,558)	3" (7.6)	5" (13)	<b>033291016</b>
.50"-.61" (1.27-1.55)	800 (3,558)	3" (7.6)	7.5" (19)	<b>033291017</b>
.62"-.74" (1.57-1.88)	1,200 (5,338)	3" (7.6)	8" (20)	<b>033291018</b>

Note: E-Eye length. M-Mesh length at nominal diameter.



**IMPORTANT**  
 Read all breaking strength, safety and technical data relating to this product. Pages V-51 to V-54.

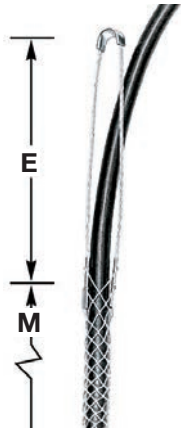

**Fiber Optic Single Eye Cable Support Grip, Closed Mesh, Single Weave**

For permanent support when cable end is available to be installed through grip.

Cable Diameter Range Inches (cm)	Approx. Breaking Strength Lbs. (N)	E Approx. Inches (cm)	M Approx. Inches (cm)	Catalog Number
.18"-.25" (.46-.63)	300 (1,334)	3" (7.6)	1.7" (4.3)	<b>022291000</b>
.23"-.32" (.58-.81)	300 (1,334)	3" (7.6)	2.5" (6.4)	<b>022291001</b>
.30"-.39" (.76-.99)	300 (1,334)	4" (10)	2.5" (6.4)	<b>022291002</b>
.37"-.48" (.94-1.22)	300 (1,334)	5" (13)	4" (10)	<b>022291003</b>
.46"-.58" (1.17-1.47)	400 (1,779)	6" (15)	4" (10)	<b>022291004</b>
.56"-.71" (1.42-1.80)	600 (2,669)	7" (18)	5.5" (14)	<b>022291005</b>
.69"-.88" (1.75-2.24)	800 (3,558)	8" (20)	6" (15)	<b>022291006</b>

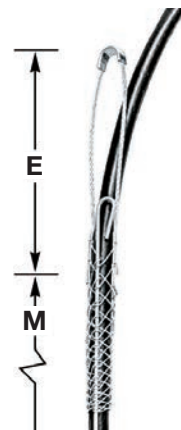

**Fiber Optic Single Eye Cable Support Grip, Split Mesh, Rod Closing, Single Weave**

For support when cable end not available.

Cable Diameter Range Inches (cm)	Approx. Breaking Strength Lbs. (N)	E Approx. Inches (cm)	M Approx. Inches (cm)	Catalog Number
.18"-.25" (.46-.63)	300 (1,334)	3" (7.6)	2.5" (6.4)	<b>022291016</b>
.23"-.32" (.58-.81)	300 (1,334)	3" (7.6)	2.5" (6.4)	<b>022291017</b>
.30"-.39" (.76-.99)	300 (1,334)	4" (10)	2.5" (6.4)	<b>022291018</b>
.37"-.48" (.94-1.22)	300 (1,334)	5" (13)	4" (10)	<b>022291019</b>
.46"-.58" (1.17-1.47)	400 (1,779)	6" (15)	5" (13)	<b>022291020</b>
.56"-.71" (1.42-1.80)	600 (2,669)	7" (18)	5" (13)	<b>022291021</b>
.69"-.88" (1.75-2.24)	800 (3,558)	8" (20)	6" (15)	<b>022291022</b>

Note: E-Eye length. M-Mesh length at nominal diameter.



Kellems has wide experience with grips for use with fiber optic cable. As the industry leader in producing wire mesh grips for the stringent requirements of fiber optic applications, Kellems has developed several series of grips for use with fiber optic communications cable.

These grips include pulling grips with built in swivels, grips with steel ends to protect fragile cable ends, grips with low profiles to pull cables in tight places and the OPTISOK® an effective tool to place preterminated cables. Also available are grips to support fiber optic cable.

### Safety And Working Load Factors For Wire Mesh Grips

The broad application of Kellems grips on a wide variety of objects requires that adequate safety factors be used to establish working loads. The approximate breaking strength of a Kellems grip represents an average calculation based on data established from actual direct tension testing done in our engineering laboratories.

It is impossible to catalog or guarantee a safety factor suitable for all applications as operating conditions are never the same. The tension, diameter, movement, number of objects gripped, gripping surface, and the attachments used are just some of the factors which vary with each application. These factors, together with the effects of abrasion, corrosion, prior use or abuse and any other variables of a specific application, must be considered by the user and the grip replaced as appropriate. Where the conditions of

### Select the Correct Fiber Optic Grip

Each Kellems grip is designed to work on a specific range of cable diameters.

- Step 1** Determine your cable outside diameter.
- Step 2** Find the grip size that encompasses your cable diameter.
- Step 3** Whenever possible, use a closed mesh that assembles over the cable end. If the cable end is not available, use a split mesh.
- Step 4** Where available, select an eye style that suits your needs.
- Step 5** Estimate the tension to be put on the grip, establish the working load you require and compare this to the listed approximate breaking strength of the grip to insure that the grip will be strong enough.

the application are not well defined or known or where risk of injury to persons or property is involved, a greater safety factor should be utilized.

**Under normal conditions, Kellems' recommended factor of safety is five for catalog listed pulling grips, and ten for catalog listed support grips.**

Any warranty as to quality, performance or fitness for use of grips is always premised on the condition that the published breaking strengths apply only to new, unused grips, and that such products are properly stored, handled, used, maintained and inspected by the user at a frequency appropriate for the use and condition of the grip.

For grip applications on materials other than those that the grips have been specifically designed for, consult the factory.

### Examples

Grip Style	Approx. Breaking Strength Lbs. (N)	Safety Factor	Max. Recommended Load Lbs. (N)	Catalog Number
Pulling Grips	2,500 (11,120)	5	500 (2,224)	<b>033291196</b>
Support Grips	400 (1,779)	10	40 (178)	<b>022291004</b>

The maximum recommended working load is the tension to be exerted on the grip in application with a margin of safety to take care of unforeseen and unusual circumstances.

It is the end-user's decision to determine how much of a safety factor is acceptable to for the application.

### Fiber Optic Grip Materials

Material	Features	Product Group
Galvanized steel wire	<ul style="list-style-type: none"> <li>• High strength</li> <li>• Not subject to continuous outside environment</li> </ul>	<ul style="list-style-type: none"> <li>• Pulling grips</li> </ul>
Tin-coated bronze wire	<ul style="list-style-type: none"> <li>• Corrosion resistant for normal outside areas</li> <li>• Non-magnetic</li> <li>• Moderate strength</li> </ul>	<ul style="list-style-type: none"> <li>• Support grips</li> </ul>
Non-metallic braid	<ul style="list-style-type: none"> <li>• Superior flex life</li> <li>• Non-conductive</li> <li>• Corrosion resistant</li> <li>• Moderate strength</li> </ul>	<ul style="list-style-type: none"> <li>• OPTISOK®</li> </ul>

### Approvals

CSA Certification is indicated on appropriate product catalog pages.



Kellems offers a unique and simple to use tool for the installation of preconnectorized fiber optic cables, jumpers and bundles of twisted pair communication cables - the OPTISOK®.

The OPTISOK® is a highly flexible and expandable nonmetallic sleeve open on one end and with a pulling ring on the other. It will expand to enclose the larger group of fiber optic connectors and grab the cable below the connector bundle by wrapping and taping to provide a gripping tool that will grab the cable(s) below the connectors. The pulling ring can be attached to a pulling line or fish tape and the OPTISOK® will act as the pulling tool.

OPTISOK® will contain and protect the connector bundle and save time and labor by making the pulling job easier, protecting the connectors from possible damage during the pull and facilitating the passage of the connector bundle through cramped and tight spaces. The OPTISOK® can be used to pull cables through plenums, underfloor duct, office partitions, raised access floors and conduits. Three sizes are available for all applications.

### How to Select OPTISOK®

- Identify connector bundle diameter to be inserted into the OPTISOK®.
- Choose appropriate catalog number based on size range.

### Installation Information

**Step 1** Expand open end of OPTISOK® and gently work in fiber optic connector bundle.

**Step 2** Still gently, work connector bundle up to the forward section of the OPTISOK®.

**Step 3** Starting at approximately 6" (15.2cm) from tail end of OPTISOK®, tightly fold over the OPTISOK® around cables and tape wrapped section 3" (7.62cm) past tail end onto the bundle.

**Step 4** Securely attach pulling line or tape to pulling ring.

*Note: To remove OPTISOK® carefully unwrap tape and slide out cables and connectors or cut OPTISOK® away without damaging connectors or cables.*

#### Step 1

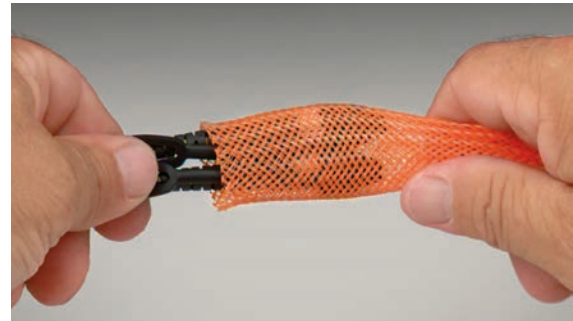

#### Step 2



#### Step 3



#### Step 4





## **Pulling Grip for Loose Tube Fiber Optic Cable**

---

Kellems offers a wire mesh specifically designed to pull loose tube fiber optic cable and meet the special pulling requirements recommended by fiber optic cable manufacturers.

Many fiber optic cable manufacturers require special cable preparation prior to pulling where a short section of the outer jacket is stripped off exposing the aramid strength member. This creates two cable diameters, one including the jacket and a second smaller diameter at the strength member. Kellems fiber grip with its special weave will accommodate and securely grab both diameters, at the outside jacket and the internal aramid strength member.

Additionally, this galvanized steel mesh grip has longer leads at the pulling eye to facilitate pulling the cable up through the top, a very low profile lug and eye to slip through tight areas, and short shoulders to protect the cable while maintaining the slim profile.

The grip can be used to pull cable overhead as well as underground through conduit and duct. It easily mates with a swivel and has the necessary strength to securely make pulls.

## **Application Information**

---

- Prior to pulling cable, follow cable manufacturers' cable preparation recommendations.
- Never exceed cable manufacturers' pulling tension recommendations.
- Never use grips to approximate breaking strength safety factor of 5 recommended.

## **Pulling Grips for Other Outside Plant Cables, Swivel Eye, Flexible Eye, Split Style, Low Profile**

---

Kellems Pulling Grips for fiber optic cable are made of high strength galvanized steel strand. They feature a multiweave mesh, with one-half the mesh length double weave, and the second half single weave. This special weave provides positive holding power while allowing the grip to remain flexible with no damage to the cable jacket. Added features include a steel nose cone which protects the cable end and allows the grip to pass easily through conduit and enclosures. The eye connects easily to a swivel or a pulling line. Several grip sizes are available to accommodate all diameters of fiber optic cable.

## **Application**

---

Kellems Flexible Eye Pulling Grips for fiber optic cable are used for the installation of fiber optic communication lines either underground, overhead, through conduit or through enclosures. They will fit single cables or cable bundles, are easily installed on the cable, and are reusable.

## **Benefits**

---

- High strength multiweave mesh for positive holding power.
- Highly flexible mesh to follow the pulling path of the cable.
- Steel nose cone reduces snags and hang-ups and protects cable end.
- Easily installed and removed.
- A dependable, reusable pulling tool.



## Support Grips for Fiber Optic Cable

---

Kellems Support Grips for fiber optic cable are specially designed to hold the cable weight as it hangs in a vertical or horizontal position. Fiber optic cable must be supported and Kellems Grips provide the support easily and economically.

These grips are made of high grade, non-magnetic tin-coated bronze strand. They are offered in universal bale or single eye configurations and are available in either closed mesh (for use where the cable end is available) or in split mesh, rod closing (for installation on existing cable runs or at specific locations).

## Split Support Grip Rod Closing Instructions

---

The stainless steel rod is a precise built-in feature which makes threading easy and fast. The strands of the mesh pass around the rod and match up with the strands from the opposite direction. The rod does not touch the cable at any point and therefore cannot cut the cable. Rod Closing Grips are reusable. They may be removed and reused as many times as desired.

## Fast to Install

---

**Step 1** Wrap the grip around the cable and thread the rod through the preformed loops with a corkscrew motion, using the curved end of the rod to engage the loops.

---

**Step 2** The action required is a steady push and twist simultaneously. The fingers of the left hand are used to bring the loops together just ahead of the hook on the end of the rod.

---

**Step 3** To remove, simply pull the rod out.

---





## Types of Attachment

The five attachment methods shown below provide unlimited flexibility of attachment to meet any condition.

### Type E

Double Eye Grip, used where fastening is made with eyebolts or similar anchor terminations.

### Type A

Single Eye Grip, used where fastening MUST be made from one point.

### Type U

Universal Bale Grip, used to fasten around a structure or closed eye.

### Type Y

Threaded bolt ( $\frac{5}{16}$ -18 x 1 $\frac{1}{2}$ " long), used to fasten through drilled holes in plate.

### Type F

Split fitting to fit AN-818 nuts. Fitting is positioned over nut and located with internal flange. A hose clamp is furnished and required to hold the fitting in correct position.

## IMPORTANT

Read all breaking strength, safety and technical data relating to this product. Pages V-41 to V-42.

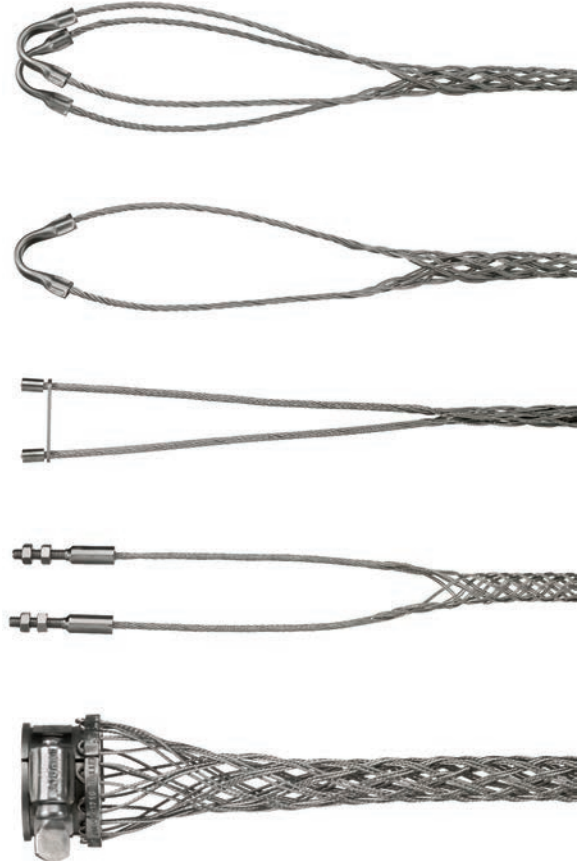

*Note: It should be emphasized that Kellems® Hose Containment Grips are not to be used as a pressure reinforcing device for hose systems. These grips are custom made. Consult Technical Services for details.*

Kellems Hose Containment Grips are used on high pressure, flexible hose lines to prevent the hose from whipping violently in the event of hose failure at the fitting. These grips will prevent serious injury to personnel and damage to equipment by holding the hose in place in the event of hose failure.

Kellems patented Hose Containment Grips are made of stainless steel with double weave mesh construction for high strength and come complete with hose clamps.

Kellems Hose Containment Grips are supplied in diameters, length and attachments to meet individual requirements. Contact the Wiring Device-Kellems factory for specific information. These grips help meet OSHA Federal Register 1926-302 (b), 1926-603 (9), (10), JIC H-1-1973 (H13.11) and JIC P-1-1975 (P11.34) requirements.



Kellems Strain Relief Grips are designed to prevent tension from being transmitted to joints and terminals on electrical cord, cable and conduit. In most applications, a Kellems grip for strain relief is stronger than the cable itself and gives much greater security than the use of a fitting alone. Kellems Grips for strain relief help make electrical systems safer, and save money by minimizing downtime from costly electrical failure due to cable pull-out. Kellems Grips also aid in compliance with the National Electric Code's terminal tension protection requirements.

**Select the Correct Grip for Strain Relief**

Kellems Grips for strain relief are designed to fit on electrical cord, cable or flexible conduit.

**Step 1** Refer to the chart below to determine the grip style best suited for your application.







**Step 2** Determine your cable outside diameter or conduit size.

**Step 3** Locate environment—indoors or outdoors.

**Step 4** Decide if a liquidtight seal is required.

**Step 5** Select NPT size and fitting style.

**Strain Relief System Selection Chart**

Grip Type	Application	Features	Cord or Conduit Range Inches (cm)	Type Fitting or Attachment	Page Number
<b>Deluxe Cord Aluminum Fitting/ Stainless Steel Grip</b> 	Outdoors or indoors where subjected to moisture or splash. Examples are crane and hoist pendant drop stations, hand tools, pumps and processing equipment.	Aluminum fittings, stainless steel mesh, neoprene oil-and-watertight bushing. Double-single weave.	.187"-3.250" (.47-8.25)	NPT, PG, and metric aluminum, male straight, 45° male, 90° male, female straight. Thread sizes 3/8"-3".	V-58, V-59, V-62
<b>Deluxe Cord Nylon Fitting/ Stainless Steel Grip</b> 	Outdoors or indoors where subjected to moisture or splash. Examples are marine and food processing equipment.	Nylon fitting, stainless steel mesh, double-single weave, neoprene oil-and-watertight bushing.	.187"-1.125" (.47-2.86)	NPT nylon, male straight, 90° male. Thread sizes 1/2"-1".	V-60
<b>Deluxe Cord Nylon Fitting/ Non-metallic Grip</b> 	Indoor or outdoors. Provides liquidtight seal, where exposed to moisture. Excellent for oil refining and chemical processing.	Non-metallic grip is corrosion resistant, nonconductive and provides superior gripping and flexing benefits. Neoprene liquidtight bushing. Nylon fitting.	.187"-1.000" (.47-2.54)	NPT nylon, straight male, thread sizes 3/8"-1" 90° male, thread sizes 1/2"-1".	V-61
<b>Deluxe Cord Stainless Steel Fitting And Grip</b> 	Indoor or outdoor use where exposed to moisture. Very strong for heavy abuse areas such as drilling platforms, steel mills and mines.	Stainless steel fitting and grip for strength. Neoprene liquidtight bushing. Double/single weave grip.	.187"-1.000" (.47-2.54)	Straight male Only with NPT Thread sizes 1/2"-1".	V-61
<b>Dust-Tight Strain Relief</b> 	Indoor use only for wiring of electrical enclosures, machine tools, portable power tools, bus drop cable systems.	Neoprene gasket—seals out chips, dirt, dust. One piece design with galvanized steel mesh. Insulating bushing available. Zinc-plated steel locknut.	.240"-2.450" (.61-6.22)	Straight male NPS or NPT	V-63
<b>Liquidtight Flexible Conduit Grip (Metal and Non-Metallic)</b> 	Wiring of machine tools, electrical enclosures, motors and systems where metallic liquidtight flexible conduit is subjected to vibration, flexure, motion or strain.	Stainless steel mesh, liquidtight fittings. Sealing "O" rings (optional). Choice of fittings.	.375"-4.000" trade sizes	NPT 1/2"-4", Hubbell fittings, Male straight, 45° male, 90° male, female straight.	V-66, V-67
<b>Liquidtight Flexible Conduit Grip (UL Type A)</b> 	Wiring or machine tools, electrical enclosures, motors and systems where conduit is subject to vibration and strain.	Stainless steel mesh, liquidtight fittings with "O" ring and locknut.	.375"-2.008" trade size male	NPT steel, Hubbell fittings, straight male, 90° Thread sizes 1/2"-2".	V-68





Endless weave provides easy cable/flexible conduit installation

Stainless steel mesh is corrosion resistant. Can be used inside or outside. It eliminates cable or flexible conduit pull out and reduces costly downtime

Multiweave grip gives cable arc-of-bend control minimizing cable damage and extending cable life. It is the strongest strain relief device available. Meets and exceeds all code requirements; prevents cable/conduit pull-out

A liquidtight fitting is available with both cable and conduit fittings; prevents liquids from running through the fitting into the enclosure

An NPT and PG threaded body allows easy attachment to either threaded hub or knock-out in box

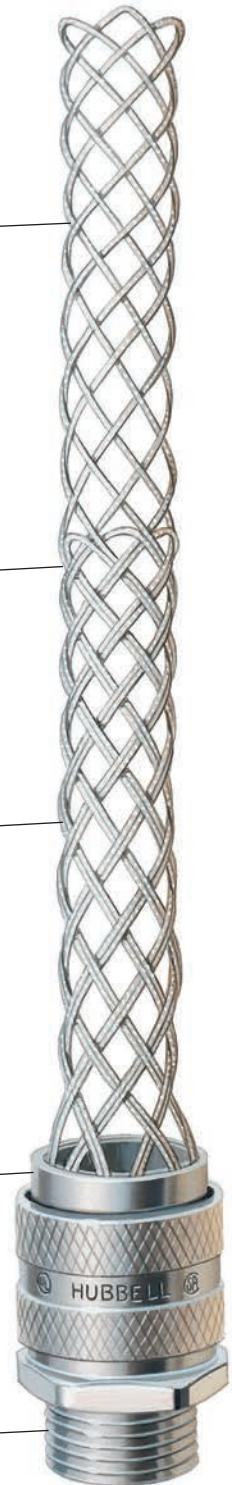



**IMPORTANT**

Read all breaking strength, safety and technical data relating to this product. Pages V-69 to V-76.

**Straight Male Thread**

NPT Thread Size Inches	Grip Diameter Range		Form Size	Catalog Number
	Inches	(cm)		
3/8	.250"-.312"	(.63-.79)	F1	<b>07401001</b>
	.312"-.375"	(.79-.95)		<b>07401002</b>
	.375"-.437"	(.95-1.11)		<b>07401003</b>
1/2	.187"-.250"	(.47-.63)	F2	<b>07401004</b>
	.250"-.375"	(.63-.95)		<b>07401006</b>
	.375"-.500"	(.95-1.27)		<b>07401008</b>
1/2	.500"-.625"	(1.27-1.59)	F3	<b>07401010</b>
	.625"-.750"	(1.59-1.90)		<b>074011247*</b>
	.750"-.875"	(1.90-2.22)		<b>074011248*</b>
3/4	.187"-.250"	(.47-.63)	F2	<b>07401011</b>
	.250"-.375"	(.63-.95)		<b>07401013</b>
	.375"-.500"	(.95-1.27)		<b>07401015</b>
3/4	.500"-.625"	(1.27-1.59)	F3	<b>07401017</b>
	.625"-.750"	(1.59-1.90)		<b>07401018</b>
	.750"-.875"	(1.90-2.22)		<b>074011249*</b>
1	.375"-.500"	(.95-1.27)	F4	<b>074011195</b>
	.500"-.625"	(1.27-1.59)		<b>07401019</b>
	.625"-.750"	(1.59-1.90)		<b>07401021</b>
1	.750"-.875"	(1.90-2.22)	F5	<b>07401023</b>
	.875"-.1.000"	(2.22-2.54)		<b>07401025</b>
	1.000"-.1.125"	(2.54-2.86)		<b>074011250*</b>
1	1.125"-.1.250"	(2.86-3.17)	F5	<b>074011028*</b>
	1.250"-.1.375"	(3.17-3.49)		<b>074011029*</b>
	.750"-.875"	(1.90-2.22)		<b>074011251</b>
1 1/4	.875"-.1.000"	(2.22-2.54)	F5	<b>07401026</b>
	1.000"-.1.125"	(2.54-2.86)		<b>07401027</b>
	1.125"-.1.250"	(2.86-3.17)		<b>07401028</b>
1 1/4	1.250"-.1.375"	(3.17-3.49)	F5	<b>074011178*</b>
	.750"-.875"	(1.90-2.22)		<b>074011252</b>
	.875"-.1.000"	(2.22-2.54)		<b>07401029</b>
1 1/2	1.000"-.1.125"	(2.54-2.86)	F5	<b>07401030</b>
	1.125"-.1.250"	(2.86-3.17)		<b>07401031</b>
	1.250"-.1.375"	(3.17-3.49)		<b>07401032</b>
1 1/2	1.312"-.1.437"	(3.33-3.65)	F6	<b>074011253</b>
	1.437"-.1.562"	(3.65-3.97)		<b>074011254*</b>
	1.562"-.1.687"	(3.97-4.28)		<b>074011255*</b>
1 1/2	1.687"-.1.812"	(4.28-4.60)	F6	<b>074011256*</b>
	1.750"-.1.875"	(4.44-4.76)		<b>074011257*</b>
	1.250"-.1.375"	(3.17-3.49)		<b>074011258</b>
2	1.312"-.1.437"	(3.33-3.65)	F6	<b>074011259</b>
	1.437"-.1.562"	(3.65-3.97)		<b>07401033</b>
	1.562"-.1.687"	(3.97-4.28)		<b>07401034</b>
2	1.687"-.1.812"	(4.28-4.60)	F7	<b>07401035</b>
	1.750"-.1.875"	(4.44-4.76)		<b>074011260</b>
	1.812"-.1.937"	(4.60-4.92)		<b>074011261</b>
2	1.937"-.2.062"	(4.92-5.24)	F7	<b>074011262*</b>
	2.062"-.2.187"	(5.24-5.55)		<b>074011263*</b>
	2.187"-.2.312"	(5.55-5.87)		<b>074011264*</b>
2	2.312"-.2.437"	(5.87-6.19)	F7	<b>074011265*</b>
	1.688"-.1.812"	(4.29-4.60)		<b>074011030</b>
	1.812"-.1.937"	(4.60-4.92)		<b>074011031</b>
2 1/2	1.937"-.2.062"	(4.92-5.24)	F7	<b>074011032</b>
	2.062"-.2.187"	(5.24-5.55)		<b>074011033</b>
	2.187"-.2.312"	(5.55-5.87)		<b>074011034</b>
2 1/2	2.312"-.2.437"	(5.87-6.19)	F7	<b>074011266*</b>
	1.937"-.2.062"	(4.92-5.24)		<b>074011036</b>
	2.062"-.2.187"	(5.24-5.55)		<b>074011037</b>
3	2.187"-.2.312"	(5.55-5.87)	F7	<b>074011038</b>
	2.312"-.2.437"	(5.87-6.19)		<b>074011039</b>
	2.437"-.2.625"	(6.19-6.67)		<b>074011186</b>
3	2.625"-.2.812"	(6.67-7.14)	F8	<b>074011187</b>
	2.812"-.3.000"	(7.14-7.62)		<b>074011188</b>
	3.000"-.3.250"	(7.62-8.25)		<b>074011189*</b>

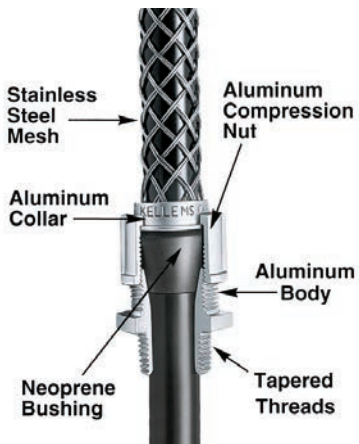

Note: Kellems® Deluxe Cord Grips are suitable for use in hazardous locations per Class I Div. 2, Class II Div. 1 & 2, Class III Div. 1 & 2 of the National Electric Code Sections 501.10(b)(2), 502.10(a)(2), 502.10(b)(2), 503.10(a)(2) and 503.10(b).  
\*Cable jacket may have to be stripped to pass through connector body.



**IMPORTANT**

Read all breaking strength, safety and technical data relating to this product. Pages V-69 to V-76.

**Straight Female Thread**

NPT Thread Size Inches	Grip Diameter Range		Form Size	Catalog Number
	Inches	(cm)		
1/2	.375"-.500"	(.95-1.27)	F2	<b>07401043</b> <b>07401045</b>
	.500"-.625"	(1.27-1.59)		
3/4	.500"-.625"	(1.27-1.59)	F2	<b>07401052</b>
3/4	.625"-.750"	(1.59-1.90)	F4	<b>07401053</b>

**90° Male Thread**

NPT Thread Size Inches	Grip Diameter Range		Form Size	Catalog Number
	Inches	(cm)		
3/8	.250"-.312"	(.63-.79)	F1	<b>07401071</b> <b>07401072</b> <b>07401073</b>
	.312"-.375"	(.79-.95)		
	.375"-.437"	(.95-1.11)		
1/2	.187"-.250"	(.47-.63)	F2	<b>07401074</b> <b>07401076</b> <b>07401078</b> <b>07401080*</b>
	.250"-.375"	(.63-.95)		
	.375"-.500"	(.95-1.27)		
3/4	.500"-.625"	(1.27-1.59)	F3	<b>07401081</b> <b>07401083</b> <b>07401084*</b> <b>074011275*</b>
	.625"-.750"	(1.59-1.90)		
	.750"-.875"	(1.90-2.22)		
	.500"-.625"	(1.27-1.59)		
1	.625"-.750"	(1.59-1.90)	F4	<b>07401085</b> <b>07401087</b> <b>07401089</b> <b>07401091*</b> <b>074011229*</b>
	.750"-.875"	(1.90-2.22)		
	.875"-.1.000"	(2.22-2.54)		
	1.000"-.1.125"	(2.54-2.86)		
1 1/4	.750"-.875"	(1.90-2.22)	F5	<b>074011230</b> <b>07401137</b> <b>07401108</b> <b>074011042*</b>
	.875"-.1.000"	(2.22-2.54)		
	1.000"-.1.125"	(2.54-2.86)		
	1.125"-.1.250"	(2.86-3.17)		
1 1/2	1.000"-.1.125"	(2.54-2.86)	F5	<b>074011045</b> <b>074011046</b> <b>074011047</b>
	1.125"-.1.250"	(2.86-3.17)		
	1.250"-.1.375"	(3.17-3.49)		
2	1.312"-.1.437"	(3.33-3.65)	F6	<b>074011233</b> <b>074011244</b> <b>074011246</b> <b>074011234*</b>
	1.437"-.1.562"	(3.65-3.97)		
	1.687"-.1.812"	(4.28-4.60)		
	1.750"-.1.875"	(4.44-4.76)		

**45° Male Thread**

NPT Thread Size Inches	Grip Diameter Range		Form Size	Catalog Number
	Inches	(cm)		
1/2	.250"-.375"	(.63-.95)	F2	<b>074011236</b> <b>074011021</b> <b>074011237*</b>
	.375"-.500"	(.95-1.27)		
	.500"-.625"	(1.27-1.59)		
3/4	.500"-.625"	(1.27-1.59)	F3	<b>074011049</b> <b>074011051*</b> <b>074011239*</b>
	.625"-.750"	(1.59-1.90)		
	.750"-.875"	(1.90-2.22)		
1	.625"-.750"	(1.59-1.90)	F4	<b>074011055</b> <b>074011057</b> <b>074011199*</b>
	.750"-.875"	(1.90-2.22)		
	.875"-.1.000"	(2.22-2.54)		
1 1/4	1.000"-.1.125"	(2.54-2.86)	F5	<b>074011059</b> <b>074011060</b>
	1.125"-.1.250"	(2.86-3.17)		

Note: Kellems® Deluxe Cord Grips are suitable for use in hazardous locations per Class I Div. 2, Class II Div. 1 & 2, Class III Div. 1 & 2 of the National Electric Code Sections 501.10(b)(2), 502.10(a)(2), 502.10(b)(2), 503.10(a)(2) and 503.10(b).

\*Cable jacket may have to be stripped to pass through connector body.





**IMPORTANT**  
 Read all breaking strength, safety and technical data relating to this product. Pages V-69 to V-76.



**Straight Male Thread**

NPT Thread Size Inches	Grip Diameter Range Inches	(cm)	Form Size	Catalog Number
1/2	.187"-.250"	(.47-.63)	F2	<b>074011331</b>
	.250"-.375"	(.63-.95)		<b>074011332</b>
	.375"-.500"	(.95-1.27)		<b>074011333</b>
	.500"-.625"	(1.27-1.59)		<b>074011334*</b>
3/4	.375"-.500"	(.95-1.27)	F3	<b>074011335</b>
	.500"-.625"	(1.27-1.59)		<b>074011336</b>
	.625"-.750"	(1.59-1.90)		<b>074011337</b>
	.750"-.875"	(1.90-2.22)		<b>074011338*</b>
1	.625"-.750"	(1.59-1.90)	F4	<b>074011341</b>
	.750"-.875"	(1.90-2.22)		<b>074011342</b>
	.875"-1.000"	(2.22-2.54)		<b>074011343</b>
	1.000"-1.125"	(2.54-2.86)		<b>074011344*</b>



**90° Male Thread**

NPT Thread Size Inches	Grip Diameter Range Inches	(cm)	Form Size	Catalog Number
1/2	.250"-.375"	(.63-.95)	F2	<b>074011346</b>
	.375"-.500"	(.95-1.27)		<b>074011347</b>
	.500"-.625"	(1.27-1.59)		<b>074011348*</b>
3/4	.375"-.500"	(.95-1.27)	F3	<b>074011349</b>
	.500"-.625"	(1.27-1.59)		<b>074011350</b>
	.625"-.750"	(1.59-1.90)		<b>074011351*</b>

Note: Kellems® Deluxe Cord Grips are suitable for use in hazardous locations per Class I Div. 2, Class II Div. 1 & 2, Class III Div. 1 & 2 of the National Electric Code Sections 501.10(b)(2), 502.10(a)(2), 502.10(b)(2), 503.10(a)(2) and 503.10(b).

\*Cable jacket may have to be stripped to pass through connector body.

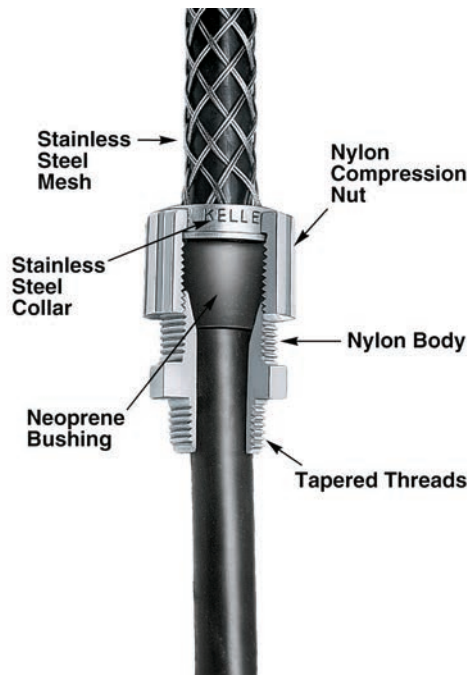



**IMPORTANT**

Read all breaking strength, safety and technical data relating to this product. Pages V-69 to V-76.

**Nylon Fittings Non-metallic Mesh, Liquidtight for Insulated Cables  
Straight Male Thread**

NPT Thread Size Inches	Grip Diameter Range Inches	(cm)	Form Size	Catalog Number
3/8	.187"-.250"	(.47-.63)	F1	<b>CG304NM</b>
	.250"-.312"	(.63-.79)		<b>CG305NM</b>
	.312"-.375"	(.79-.95)		<b>CG306NM</b>
1/2	.187"-.250"	(.47-.63)	F2	<b>CG404NM</b>
	.250"-.375"	(.63-.95)		<b>CG406NM</b>
	.375"-.500"	(.95-1.27)		<b>CG408NM</b>
3/4	.375"-.500"	(.95-1.27)	F3	<b>CG608NM</b>
	.500"-.625"	(1.27-1.59)		<b>CG610NM</b>
	.625"-.750"	(1.59-1.90)		<b>CG612NM</b>
1	.500"-.625"	(1.27-1.59)	F4	<b>CG810NM</b>
	.625"-.750"	(1.59-1.90)		<b>CG812NM</b>
	.750"-.875"	(1.90-2.22)		<b>CG814NM</b>
	.875"-.1.000"	(2.22-2.54)		<b>CG816NM</b>



**90° Male Thread**

NPT Thread Size Inches	Grip Diameter Range Inches	(cm)	Form Size	Catalog Number
1/2	.250"-.375"	(.63-.95)	F2	<b>CG40690NM</b>
	.375"-.500"	(.95-1.27)		<b>CG40890NM</b>
3/4	.375"-.500"	(.95-1.27)	F3	<b>CG60890NM</b>
	.500"-.625"	(1.27-1.59)		<b>CG61090NM</b>
	.625"-.750"	(1.59-1.90)		<b>CG61290NM*</b>
1	.625"-.750"	(1.59-1.90)	F4	<b>CG81290NM</b>
	.750"-.875"	(1.90-2.22)		<b>CG81490NM</b>



**Stainless Steel Fittings, Stainless Steel Mesh, Liquidtight for Insulated Cables  
Straight Male Thread**

NPT Thread Size Inches	Grip Diameter Range Inches	(cm)	Form Size	Catalog Number
1/2	.187"-.250"	(.47-.63)	F2	<b>CG404SST</b>
	.250"-.375"	(.63-.95)		<b>CG406SST</b>
	.375"-.500"	(.95-1.27)		<b>CG408SST</b>
	.500"-.625"	(1.27-1.59)		<b>CG410SST</b>
3/4	.375"-.500"	(.95-1.27)	F2	<b>CG608SST</b>
	.500"-.625"	(1.27-1.59)		<b>CG610SST</b>
3/4	.625"-.750"	(1.59-1.90)	F3	<b>CG612SST</b>
	.750"-.875"	(1.90-2.22)		<b>CG614SST</b>
1	.500"-.625"	(1.27-1.59)	F4	<b>CG810SST</b>
	.625"-.750"	(1.59-1.90)		<b>CG812SST</b>
	.750"-.875"	(1.90-2.22)		<b>CG814SST</b>
	.875"-.1.000"	(2.22-2.54)		<b>CG816SST</b>



Note: Kellems® Deluxe Cord Grips are suitable for use in hazardous locations per Class I Div. 2, Class II Div. 1 & 2, Class III Div. 1 & 2 of the National Electric Code Sections 501.10(b)(2), 502.10(a)(2), 502.10(b)(2), 503.10(a)(2) and 503.10(b).  
\*Cable jacket may have to be stripped to pass through connector body.



**IMPORTANT**  
 Read all breaking strength, safety and technical data relating to this product. Pages V-69 to V-76.



### Straight PG\* Male Thread

Hub Size	Cord Diameter Range		Form Size	Catalog Number
	Inches	(cm)		
PG16	.500"-.625"	(1.27-1.59)	F2	<b>074PG16010</b>
PG21	.500"-.625"	(1.27-1.59)	F2	<b>074PG21010</b>
PG21	.625"-.750"	(1.59-1.90)	F3	<b>074PG211247</b>
	.750"-.875"	(1.90-2.22)		<b>074PG211248</b>
PG29	.625"-.750"	(1.59-1.90)	F4	<b>074PG29021</b>
	.750"-.875"	(1.90-2.22)		<b>074PG29023</b>
	.875"-1.000"	(2.22-2.54)		<b>074PG29025</b>
PG29	1.125"-1.250"	(2.86-3.17)	F5	<b>074PG291028*</b>
PG36	1.125"-1.250"	(2.86-3.17)	F5	<b>074PG36028*</b>

Note: \*Panzergerwinde.



### Straight Metric Male Thread

Hub Size	Cord Diameter Range		Form Size	Catalog Number
	Inches	(cm)		
M20	.500"-.625"	(1.27-1.59)	F2	<b>074M20010</b>
M25	.625"-.750"	(1.59-1.90)	F3	<b>074M251247</b>
	.750"-.875"	(1.90-2.22)		<b>074M251248</b>
M25	.500"-.625"	(1.27-1.59)	F2	<b>074M25017</b>
	.625"-.750"	(1.59-1.90)		<b>074M32021</b>
M32	.750"-.875"	(1.90-2.22)	F4	<b>074M32023</b>
	.875"-1.000"	(2.24-2.54)		<b>074M32025</b>
M32	1.000"-1.125"	(2.54-2.86)	F5	<b>074M321250</b>
	1.125"-1.250"	(2.86-3.17)		<b>074M321028</b>

Note: Kellems® Deluxe Cord Grips are suitable for use in hazardous locations per Class I Div. 2, Class II Div. 1 & 2, Class III Div. 1 & 2 of the National Electric Code Sections 501.10(b)(2), 502.10(a)(2), 502.10(b)(2), 503.10(a)(2) and 503.10(b).  
 \*Cable jacket may have to be stripped to pass through connector body.

### Specifications

Material	Temperature Range
Aluminum (Body)	-30°F to +240°F (-34°C to +115°C).
Stainless Steel (Mesh)	-30°F to +240°F (-34°C to +115°C).
Neoprene (Bushings)	-30°F to +240°F (-34°C to +115°C).
Hazardous Locations	Suitable for use in hazardous locations per Class I Div. 2, Class II Div. 1 & 2, Class III Div. 1 & 2 N.E.C. Reference 501.10(b)(2), 502.10(a)(2), 502.10(b)(2), 503.10(a)(2) and 503.10(b).
Approvals	
Deluxe Cord Grips	UL Listed in accordance with Standard 514B for indoor/outdoor use. UL Control numbers 898D and 899D.
Wet Locations	Suitable for use in wet locations when used with a listed sealing ring between box and fitting.

**IMPORTANT**

Read all breaking strength, safety and technical data relating to this product. Pages V-69 to V-76.

**Non-Insulated, Wide Range Strain Relief**

Thread Size	Cable Diameter Range Inches (cm)	Mesh Length @ Nom. Dia. Inches (cm)	Catalog Number
½ NPT	.24"-.32" (.61-.81)	3.25" (8.25)	<b>073031200</b>
½ NPT	.32"-.43" (.81-1.09)	3.75" (9.52)	<b>073031201</b>
½ NPT	.43"-.54" (1.09-1.37)	4.75" (12.06)	<b>073031202</b>
¾ NPT	.54"-.73" (1.37-1.85)	6.5" (16.51)	<b>073031203</b>
1 NPT	.73"-.97" (1.85-2.46)	7" (17.78)	<b>073031204</b>
1¼ NPT	.97"-1.25" (2.46-3.17)	9" (22.86)	<b>073031205</b>
PG29*	.73"-.97" (1.85-2.46)	7" (17.78)	<b>073PG291204</b>

Note: \*Panzergewinde.



**Insulated, Wide Range Strain Relief with Insulating Bushing**

Thread Size	Cable Diameter Range Inches (cm)	Mesh Length @ Nom. Dia. Inches (cm)	Dim. A Inches (cm)	Min. Space Between Grips Inches (cm)	Catalog Number
½ NPS	.24"-.32" (.61-.81)	3.25" (8.25)	1" (2.54)	1.25" (3.17)	<b>073031206</b>
½ NPS	.32"-.43" (.81-1.09)	3.75" (9.52)	1" (2.54)	1.25" (3.17)	<b>073031207</b>
½ NPS	.43"-.54" (1.09-1.37)	4.75" (12.06)	1" (2.54)	1.25" (3.17)	<b>073031208</b>
¾ NPS	.54"-.73" (1.37-1.85)	6.5" (16.51)	1" (2.54)	1.5" (3.81)	<b>073031209</b>
1 NPS	.73"-.97" (1.85-2.46)	7" (17.78)	1.313" (3.02)	1.75" (4.44)	<b>073031210</b>
1¼ NPS	.97"-1.25" (2.46-3.17)	9" (22.86)	1.313" (3.02)	2.25" (5.71)	<b>073031211</b>
1½ NPT	1.25"-1.50" (3.17-3.81)	11.75" (29.84)	1.313" (3.02)	2.5" (6.35)	<b>073031212</b>
2 NPT	1.50"-1.70" (3.81-4.32)	13.25" (33.65)	1.375" (3.49)	3.25" (8.25)	<b>073031213</b>
2½ NPT	1.70"-2.00" (4.32-5.08)	13.5" (34.29)	1.5" (3.81)	3.625" (9.21)	<b>073031214</b>
2½ NPT	2.00"-2.45" (5.08-6.22)	13.75" (34.92)	1.5" (3.81)	3.625" (9.21)	<b>073031215</b>





**IMPORTANT**

Read all breaking strength, safety and technical data relating to this product. Pages V-69 to V-76.



**Application**

Kellems® I-Grips will fit 2, 3, 4 and 5 wire Hubbell Insulgrip® plugs and connector bodies. The eye tabs fit under the nylon cord clamp and the screws slide through the eyelets, securing the grip in place.

These grips are for indoor use only.

**Benefits**

- Easily attached to Insulgrip plugs and connector bodies.
- Controls cable arc-of-bend.
- Provides heavy-duty strain relief.
- Fits all sizes.



**I-Grips**

Cable Diameter Range Inches (cm)	E Inches (cm)	M Inches (cm)	Catalog Number
.32"-.43" (.81-1.09)	1.25" (3.17)	4" (10.16)	<b>07310001</b>
.43"-.56" (1.09-1.42)	1.25" (3.17)	4.75" (12.06)	<b>07310002</b>
.56"-.73" (1.42-1.85)	1.50" (3.81)	6" (15.24)	<b>07310003</b>
.73"-.85" (1.85-2.16)	1.50" (3.81)	6.5" (16.51)	<b>07310004</b>
.85"-1.00" (2.16-2.54)	1.50" (3.81)	8" (20.32)	<b>07310005</b>
1.00"-1.25" (2.54-3.17)	1.50" (3.81)	10" (25.40)	<b>07310006</b>

Note: E-Eye length. M-Mesh length at nominal diameter.

Eyelet hole diameter .203" (.52cm).

I-Grips should not be used on Insulgrip devices when "Seal-Tite®" weatherproof covers are to be installed.





### Thread Adapters for Multi-Pin Connectors

Kellems® Thread Adapters are devices formatting AN-MS connectors and other multi-pin connectors to Kellems grips with NPT threaded fittings. They are made of aluminum with internal threads and replace the connector cord clamp. These adapters permit the installation of Kellems Grips, to prevent cable or conduit pull-out and control arc-of-bend.

### Applications

Thread adapters allow the installation of Kellems® Grips on multi-pin connectors at electrical consoles, mobile equipment, control switches, assembly equipment and testing machines.

### Benefits

- Easy installation.
- Allows the use of Kellems grips.
- Extends connector and cable life.

### Thread Adapters for Multi-Pin Connectors

Thread Adapters					Deluxe Cord Grips		Strain Relief Grips		Liquidtight Conduit Grips (Insulated Throat)
AN-MS Connector Size**	AN-MS Cable Clamp Number***	Thread Size A Inch	NPT Thread Size B	Catalog Number	Cable Diameter Range Inches (cm)	Catalog Number	Cable Diameter Range Inches (cm)	Catalog Number	Catalog Number
8S, 10S	3057-3	½" x 28"	⅜	<b>091041000</b>	.250"-.312" (.63-.79)	07401001	—	—	—
10SL, 12, 12S	3057-4	⅝" x 24"		<b>091041001</b>	.312"-.375" (.79-.95)	07401002			
14, 14S	3057-6	¾" x 20"		<b>091041002</b>	.375"-.437" (.95-1.11)	07401003			
14, 14S	3057-6	¾" x 20"	½	<b>091041003</b>	.187"-.250" (.47-.63)	07401004	.24"-.32" (.61-.81)	073031200	—
16, 16S	3057-8	⅞" x 20"		<b>091041004</b>	.250"-.375" (.63-.95)	07401006	.32"-.43" (.81-1.09)	073031201	074093512
18	3057-10	1" x 20"		<b>091041006</b>	.375"-.500" (.95-1.27)	07401008	.43"-.54" (1.09-1.37)	073031202	—
16, 16S	3057-8	⅞" x 20"	¾	<b>091041005</b>	.187"-.250" (.47-.63)	07401011	.54"-.74" (1.37-1.85)	073031203	074093513
18	3057-10	1" x 20"		<b>091041007</b>	.250"-.375" (.63-.95)	07401013			
20, 22	3057-12	1¼" x 18"		<b>091041008</b>	.375"-.500" (.95-1.27)	07401015			
					.500"-.625" (1.27-1.59)	07401017			
				.625"-.750" (1.59-1.90)	07401018				
20, 22	3057-12	1¼" x 18"	1	<b>091041009</b>	.375"-.500" (.95-1.27)	074011195	.73"-.97" (1.85-2.46)	073031204	074093514
24, 28	3057-16	1⅞" x 18"		<b>091041010</b>	.500"-.625" (1.27-1.59)	07401019			
32	3057-20	1¾" x 18"		<b>091041012</b>	.625"-.750" (1.59-1.90)	07401021			
36	3057-24	2" x 18"		<b>091041015</b>	.750"-.875" (1.90-2.22)	07401023			
					.875"-1.000" (2.22-2.54)	07401025			
24, 28	3057-16	1⅞" x 18"	1¼	<b>091041011</b>	.750"-.875" (1.90-2.22)	074011251	.97"-1.25" (2.46-3.17)	073031205	074093515
32	3057-20	1¾" x 18"		<b>091041013</b>	.875"-1.000" (2.22-2.54)	07401026			
36	3057-24	2" x 18"		<b>091041016</b>	1.000"-1.125" (2.54-2.86)	07401027			
					1.125"-1.375" (2.86-3.17)	07401028			
32	3057-20	1¾" x 18"	1½	<b>091041014</b>	.875"-1.000" (2.22-2.54)	07401029	—	—	074093516
36	3057-24	2" x 18"		<b>091041017</b>	1.000"-1.125" (2.54-2.86)	07401030			
40	3057-28	2¼" x 16"		<b>091041019</b>	1.125"-1.250" (2.86-3.17)	07401031			
				1.250"-1.375" (3.17-3.49)	07401032				

Note: \*Cable jacket may have to be stripped to pass through connector body.

\*\*Number stamped on connector shell.

\*\*\*Number stamped on clamp shell.

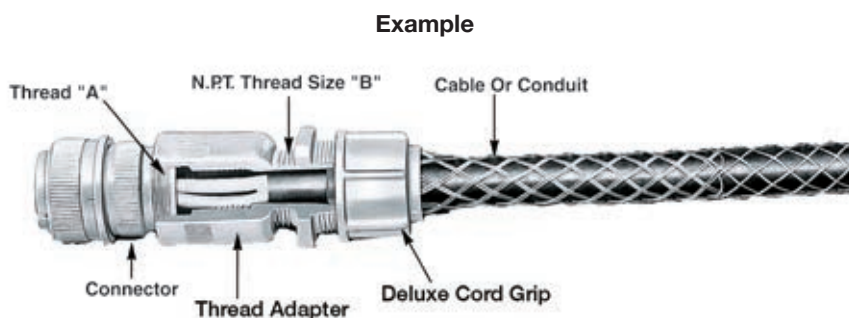

091041006



## Benefits

- Helps prevent conduit pull-out and damage at the fitting.
- Reduces equipment downtime.

## IMPORTANT

Read all breaking strength, safety and technical data relating to this product. Pages V-74 to V-76.



### Straight With Male Fitting

Conduit Trade Size Inches	NPT Fitting Size Inches	Mesh Length Inches (cm)	Catalog Number (Insulated)	Catalog Number (Non-insulated)
3/8	1/2	3" (7.62)	<b>074093511</b>	<b>074093401</b>
1/2	1/2	3.5" (8.89)	<b>074093512</b>	<b>074093402</b>
3/4	3/4	4" (10.16)	<b>074093513</b>	<b>074093403</b>
1	1	5" (12.70)	<b>074093514</b>	<b>074093404</b>
1 1/4	1 1/4	6" (15.24)	<b>074093515</b>	<b>074093405</b>
1 1/2	1 1/2	6.75" (17.14)	<b>074093516</b>	<b>074093406</b>
2	2	8" (20.32)	<b>074093518</b>	<b>074093408</b>
2 1/2	2 1/2	9.75" (24.76)	<b>074093520</b>	<b>074093410</b>
3	3	11" (27.94)	<b>074093522</b>	<b>074093412</b>
4	4	14" (35.56)	<b>074093526</b>	—



### 90° Angle With Male Fitting

Conduit Trade Size Inches	NPT Fitting Size Inches	Mesh Length Inches (cm)	Catalog Number (Insulated)	Catalog Number (Non-insulated)
3/8	1/2	3" (7.62)	<b>074093541</b>	<b>074093421</b>
1/2	1/2	3.5" (8.89)	<b>074093542</b>	<b>074093422</b>
3/4	3/4	4" (10.16)	<b>074093543</b>	<b>074093423</b>
1	1	5" (12.70)	<b>074093544</b>	<b>074093424</b>
1 1/4	1 1/4	6" (15.24)	<b>074093545</b>	<b>074093425</b>
1 1/2	1 1/2	6.75" (17.14)	<b>074093546</b>	<b>074093426</b>
2	2	8" (20.32)	<b>074093548</b>	<b>074093428</b>
2 1/2	2 1/2	9.75" (24.76)	<b>074093550</b>	—
3	3	11" (27.94)	<b>074093552</b>	—

Note: For use with Liquidtight Metal conduit and PolyTuff® I Non-Metallic conduit.



**IMPORTANT**

Read all breaking strength, safety and technical data relating to this product. Pages V-74 to V-76.

**Straight With Chase Fitting**

Conduit Trade Size Inches	NPT Fitting Size Inches	Mesh Length Inches (cm)	Catalog Number
1/2	1/2	3.5" (8.89)	<b>07406079</b>
3/4	3/4	4" (10.16)	<b>07406080</b>
1	1	5" (12.70)	<b>07406081</b>
1 1/4	1 1/4	6" (15.24)	<b>07406082</b>
1 1/2	1 1/2	6.75" (17.14)	<b>07406083</b>



**45° Angle With Male Fitting**

Conduit Trade Size Inches	NPT Fitting Size Inches	Mesh Length Inches (cm)	Catalog Number (Insulated)	Catalog Number (Non-insulated)
3/8	1/2	3" (7.62)	<b>074093561</b>	<b>074093441</b>
1/2	1/2	3.5" (8.89)	<b>074093562</b>	<b>074093442</b>
3/4	3/4	4" (10.16)	<b>074093563</b>	<b>074093443</b>
1	1	5" (12.70)	<b>074093564</b>	<b>074093444</b>
1 1/4	1 1/4	6" (15.24)	<b>074093565</b>	<b>074093445</b>
1 1/2	1 1/2	6.75" (17.14)	<b>074093566</b>	<b>074093446</b>
2	2	8" (20.32)	<b>074093568</b>	<b>074093448</b>

Note: For use with Liquidtight Metal conduit and PolyTuff® I Non-Metallic conduit.





**IMPORTANT**  
 Read all breaking strength, safety and technical data relating to this product.  
 Page V-76



**Straight Male Hubbell Fitting**

Conduit Trade Size Inches	NPT Fitting Size Inches	Mesh Length Inches (cm)	Catalog Number
3/8	1/2	3.75" (9.52)	<b>H038CNK</b>
1/2	1/2	4.5" (11.43)	<b>H050CNK</b>
3/4	3/4	6.25" (15.87)	<b>H075CNK</b>
1	1	7.5" (19.05)	<b>H100CNK</b>
1 1/4	1 1/4	9" (22.86)	<b>H125CNK</b>
1 1/2	1 1/2	13.5" (34.29)	<b>H150CNK</b>
2	2	14.5" (36.83)	<b>H200CNK</b>



**90° Male Hubbell Fitting**

Conduit Trade Size Inches	NPT Fitting Size Inches	Mesh Length Inches (cm)	Catalog Number
3/8	1/2	3.75" (9.52)	<b>H0389CNK</b>
1/2	1/2	4.5" (11.43)	<b>H0509CNK</b>
3/4	3/4	6.25" (15.87)	<b>H0759CNK</b>
1	1	7.5" (19.05)	<b>H1009CNK</b>
1 1/4	1 1/4	9" (22.86)	<b>H1259CNK</b>
1 1/2	1 1/2	13.5" (34.29)	<b>H1509CNK</b>
2	2	14.5" (36.83)	<b>H2009CNK</b>



## Wire Mesh Grip Materials

Material	Features	Product Group
Galvanized steel wire	<ul style="list-style-type: none"> <li>• High strength</li> <li>• Not subject to continuous outside environment</li> </ul>	<ul style="list-style-type: none"> <li>• Strain relief grips</li> <li>• I-Grips</li> </ul>
Stainless steel wire (302/304)	<ul style="list-style-type: none"> <li>• High strength</li> <li>• Corrosion resistant</li> <li>• Slightly magnetic</li> </ul>	<ul style="list-style-type: none"> <li>• Deluxe cord grips</li> <li>• Liquidtight, flexible, metal conduit grips</li> <li>• UL type A conduit grips</li> </ul>
Non-metallic strand	<ul style="list-style-type: none"> <li>• Superior flex life</li> <li>• Non-conductive</li> <li>• Corrosion resistant</li> <li>• Moderate strength</li> </ul>	<ul style="list-style-type: none"> <li>• Non-metallic deluxe cord grips</li> </ul>

## Operating Temperatures

Material	Temperature Range
Aluminum	-40°F to +300°F (-40°C to +149°C).
Aluminum Deluxe Cord Grips	-30°F to +240°F (-34°C to +115°C).
Non-Metallic Deluxe Cord Grips	-30°F to +225°F (-34°C to +107°C).
Nylon	-40°F to +225°F (-40°C to +107°C).
Nylon Fitting with Stainless Steel Mesh	-40°F to +225°F (-40°C to +107°C).
Stainless Steel	-60°F to +1000°F (-51°C to +537°C).
Stainless Steel Deluxe Cord Grips	-30°F to +240°F (-34°C to +115°C).
Neoprene (Bushings)	-30°F to +240°F (-34°C to +115°C).

## Hazardous Locations

	Product Categories
The product categories listed to the right are suitable for use in hazardous locations per Class I Div. 2, Class II Div. 1 & 2, Class III Div. 1 & 2.	Deluxe cord grip, aluminum fitting; Deluxe cord grip, nylon fitting; Deluxe cord grip, non-metallic; Sealtite conduit grips; Dusttight strain relief grips.

## Flammability

Non-metallic deluxe cord grips will not support combustion. Listed below are the ratings.

Component	Rating
Mesh grip	UL 94HB.
Fitting	UL 94V-2.

## Approvals

UL Listing and CSA Certification are indicated on appropriate product catalog pages.

Agency	UL Control Number
Underwriters Laboratories Inc.	898D and 899D.
	UL Listed in accordance with Standard 514B for indoor/outdoor use.

## Wet Locations

	Product Categories
The products noted to the right are suitable for use in wet locations when a listed sealing ring is used between box and fitting.	Deluxe cord grip, aluminum fitting; Deluxe sealing ring cord grip; Deluxe cord grip, non-metallic; Sealtite conduit grips; Hubbell non-metallic conduit grips; Cord connectors; Hubbell Juniors; PolyTuff® connectors; Hubbell sealtite conduit connectors.



## Form Size Definition

The term "Form Size" refers to the physical mass or overall dimensions of a cord connector. Form 1 is the smallest size, Form 8 is the largest size.

## Knockout Holes

NPT Hub Size Inches	Knockout Hole Recommended Min. to Max. Inches (cm)	
¼	.540"	.570" (1.37-1.45)
⅜	.671"	.701" (1.70-1.78)
½	.859"	.906" (2.18-2.30)
¾	1.094"	1.141" (2.78-2.90)
1	1.359"	1.406" (3.45-3.57)
1¼	1.719"	1.766" (4.37-4.49)
1½	1.969"	2.016" (5.00-5.12)
2	2.453"	2.500" (6.23-6.35)
2½	2.953"	3.000" (7.50-7.62)
3	3.578"	3.625" (9.09-9.21)

## Product Data

### Deluxe Cord Grips, Liquidtight for Insulated Cables

Deluxe Cord Grips helps to alleviate pull tension on terminals, control cable arc-of-bend, prevent cord pull-out, and provide a liquidtight seal. They are offered with either aluminum, stainless steel or nylon fittings in a variety of configurations and NPT thread sizes. Additionally, a completely non-metallic product is offered on page V-61.

## Application

Deluxe Cord Grips are used indoors or outdoors to help prevent cord pull-out, and where cables are subjected to moisture, splash or submersion. Specific uses are: wiring enclosures, pendant stations, hand tools, construction, processing and material handling equipment, pumps, motors and machine tools.

## Benefits

- Helps to prevent cable pull-out.
- Controls cable arc-of-bend.
- Provides a liquidtight seal.
- Corrosion resistant stainless steel mesh with aluminum collar.



## Deluxe Cord Grips Fitting Dimensions

### Straight Hubbell Connectors

F NPT Inches	Aluminum, Inches (cm)					Nylon, Inches (cm)					Stainless Steel, Inches (cm)								
	A Form Dia.	B Ref.	C	D Throat Dia.	E A/C* A/F*	A Dia.	B Ref.	C	D Throat Dia.	E A/C* A/F*	A A/C* A/F*	B Ref.	C	D Throat Dia.	E A/C* A/F*				
3/8-18	1 .88" (2.24)	.90" (2.29)	.46" (1.17)	.44" (1.12)	.99" (2.51)	.88" (2.24)	1.00" (2.54)	1.10" (2.79)	.43" (1.09)	.45" (1.14)	1.00" (2.54)	.93" (2.36)	1.01" (2.57)	.88" (2.24)	.90" (2.29)	.46" (1.17)	.45" (1.14)	.87" (2.21)	.75" (1.90)
1/2-14	1 .88" (2.24)	.90" (2.29)	.46" (1.17)	.44" (1.12)	.99" (2.51)	.88" (2.24)	1.00" (2.54)	1.10" (2.79)	.43" (1.09)	.45" (1.14)	1.00" (2.54)	.93" (2.36)	—	—	—	—	—	—	—
1/2-14	2 1.13" (2.87)	1.10" (2.79)	.55" (1.40)	.64" (1.63)	1.11" (2.82)	1.00" (2.54)	1.32" (3.35)	1.50" (3.81)	.53" (1.35)	.58" (1.47)	1.25" (3.17)	1.12" (2.84)	1.30" (3.30)	1.13" (2.87)	1.10" (2.79)	.54" (1.37)	.63" (1.60)	1.16" (2.95)	1.00" (2.54)
1/2-14	3 1.38" (3.51)	1.50" (3.81)	.55" (1.40)	.64" (1.63)	1.40" (3.56)	1.25" (3.17)	—	—	—	—	—	—	—	—	—	—	—	—	—
3/4-14	2 1.13" (2.87)	1.10" (2.79)	.55" (1.40)	.64" (1.63)	1.29" (3.28)	1.13" (2.87)	—	—	—	—	—	—	—	—	—	—	—	—	—
3/4-14	3 1.38" (3.51)	1.50" (3.81)	.55" (1.40)	.82" (2.08)	1.40" (3.56)	1.25" (3.17)	1.56" (3.96)	1.60" (4.06)	.55" (1.40)	.77" (1.96)	1.44" (3.66)	1.31" (3.33)	1.59" (4.04)	1.38" (3.51)	1.30" (3.30)	.56" (1.42)	.81" (2.06)	1.44" (3.66)	1.25" (3.17)
1-11½	3 —	—	—	—	—	—	—	—	—	—	—	—	—	—	—	—	—	—	—
1-11½	4 1.75" (4.44)	1.60" (4.06)	.71" (1.80)	1.02" (2.59)	1.81" (4.60)	1.62" (4.11)	1.88" (4.78)	1.75" (4.44)	.70" (1.78)	1.01" (2.57)	1.84" (4.67)	1.63" (4.14)	2.02" (5.13)	1.75" (4.44)	1.40" (3.56)	.70" (1.78)	1.03" (2.62)	1.88" (4.78)	1.63" (4.14)
1-11½	5 2.31" (5.87)	1.70" (4.32)	.66" (1.68)	1.01" (2.57)	2.28" (5.79)	2.00" (5.08)	—	—	—	—	—	—	—	—	—	—	—	—	—
1¼-11½	5 2.31" (5.87)	1.70" (4.32)	.74" (1.88)	1.26" (3.20)	2.28" (5.79)	2.12" (5.38)	—	—	—	—	—	—	—	—	—	—	—	—	—
1½-11	5 2.31" (5.87)	1.70" (4.32)	.74" (1.88)	1.38" (3.51)	2.28" (5.79)	2.12" (5.38)	—	—	—	—	—	—	—	—	—	—	—	—	—
1½-11½	6 3.00" (7.62)	2.20" (5.59)	.75" (1.90)	1.50" (3.81)	2.97" (7.54)	2.75" (6.98)	—	—	—	—	—	—	—	—	—	—	—	—	—
2-11½	6 3.00" (7.62)	2.20" (5.59)	.80" (2.03)	1.92" (4.88)	3.24" (8.24)	3.00" (7.62)	—	—	—	—	—	—	—	—	—	—	—	—	—
2-11½	7 3.85" (9.78)	2.70" (6.86)	.88" (2.24)	1.94" (4.93)	4.05" (10.29)	3.75" (9.52)	—	—	—	—	—	—	—	—	—	—	—	—	—
2½-8	7 3.85" (9.78)	2.70" (6.86)	1.30" (3.30)	2.32" (5.89)	4.34" (11.02)	4.02" (10.21)	—	—	—	—	—	—	—	—	—	—	—	—	—
2½-8	8 4.75" (12.06)	2.70" (6.86)	1.25" (3.17)	2.38" (6.05)	4.86" (12.34)	4.50" (11.43)	—	—	—	—	—	—	—	—	—	—	—	—	—
3-8	7 3.85" (9.78)	2.70" (6.86)	1.30" (3.30)	2.54" (6.45)	4.34" (11.02)	4.01" (10.21)	—	—	—	—	—	—	—	—	—	—	—	—	—
3-8	8 4.50" (11.43)	2.70" (6.86)	1.38" (3.51)	3.00" (7.62)	4.86" (12.34)	4.50" (11.43)	—	—	—	—	—	—	—	—	—	—	—	—	—

Note: \*A/C— Across Corners; A/F— Across Flats.

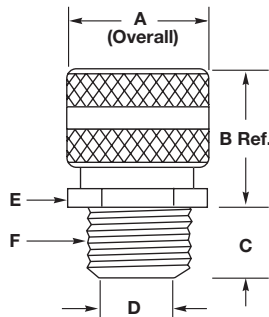

Dimensions shown are approximate and are subject to change without notice.



**Deluxe Cord Grips Fitting Dimensions**

**45° Hubbell Connectors**

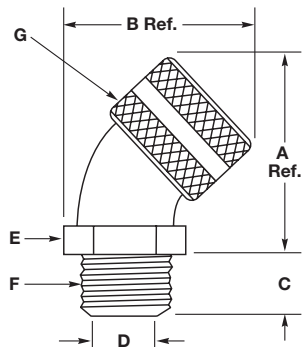

Aluminum, Inches (cm)								
F NPT Inches	Form	A Ref.	B Ref.	C	D Throat Dia.	E		G Dia.
						Across Comers	Across Flats	
½-14	2	2.00" (5.08)	1.90" (4.83)	.550" (1.40)	.560" (1.42)	1.270" (3.23)	1.110" (2.79)	1.125" (2.86)
¾-14	3	2.30" (5.84)	2.50" (6.53)	.560" (1.42)	.750" (1.90)	1.480" (3.76)	1.281" (3.25)	1.375" (3.49)
1-11½	4	2.60" (6.60)	2.80" (7.11)	.700" (1.78)	1.000" (2.54)	1.690" (4.29)	1.500" (3.81)	1.750" (4.44)
1¼-11½	5	3.90" (9.91)	3.90" (9.91)	.740" (1.88)	1.250" (3.17)	2.45" (6.22)	2.125" (5.40)	2.310" (5.87)
1½-11½	5	3.90" (9.91)	3.90" (9.91)	.740" (1.88)	1.500" (3.81)	2.45" (6.22)	2.125" (5.40)	2.310" (5.87)

**90° Hubbell Connectors**

Aluminum, Inches (cm)								Nylon, Inches (cm)							
F NPT Inches	Form	A	B Ref.	C	D Throat Dia.	E		G Dia.	A	B Ref.	C	D Throat Dia.	E		G Dia.
						A/C*	A/F*						A/C*	A/F*	
¾-18	1	1.27" (3.23)	2.00" (5.08)	.460" (1.17)	.440" (1.12)	1.15" (2.92)	1.10" (2.79)	.875" (2.22)	—	—	—	—	—	—	—
½-14	2	1.56" (3.96)	2.30" (5.84)	.500" (1.27)	.546" (1.39)	1.30" (3.30)	1.13" (2.87)	1.125" (2.86)	1.41" (3.58)	2.50" (6.35)	.550" (1.40)	.575" (1.46)	1.23" (3.12)	1.12" (2.82)	1.315" (3.34)
¾-14	3	1.79" (4.55)	2.80" (7.11)	.560" (1.42)	.765" (1.94)	1.49" (3.78)	1.31" (3.33)	1.375" (3.49)	1.65" (4.19)	2.81" (7.14)	.560" (1.42)	.765" (1.94)	1.42" (3.61)	1.29" (3.28)	1.560" (3.96)
1-11½	4	2.08" (5.28)	3.20" (8.13)	.700" (1.78)	1.000" (2.54)	1.70" (4.32)	1.50" (3.81)	1.750" (4.44)	1.99" (5.05)	3.30" (8.38)	.700" (1.78)	1.010" (2.57)	1.82" (4.62)	1.60" (4.06)	1.875" (4.76)
1¼-11½	5	3.18" (8.08)	4.30" (10.92)	.730" (1.85)	1.260" (3.20)	2.47" (6.27)	2.15" (5.46)	2.310" (5.87)	—	—	—	—	—	—	—
1½-11½	5	3.18" (8.08)	4.30" (10.92)	.750" (1.92)	1.500" (3.81)	2.47" (6.27)	2.15" (5.46)	2.310" (5.87)	—	—	—	—	—	—	—
2-11½	6	3.51" (8.92)	5.50" (13.97)	.800" (2.03)	1.920" (4.88)	2.98" (7.57)	2.78" (7.06)	3.000" (7.62)	—	—	—	—	—	—	—

Note: \*A/C - Across Corners; A/F - Across Flats.

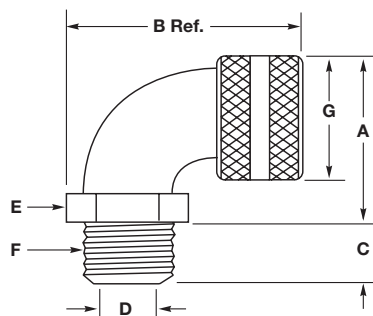

Dimensions shown are approximate and are subject to change without notice.





## Deluxe Cord Grips Fitting Dimensions

### Female Hubbell Connectors

Aluminum, Inches (cm)							
F NPT Inches	A Form	B Dia. Ref.	C	D Throat Dia.	E		
					Across Corners	Across Flats	
3/8-18	1	.88" (2.24)	1.40" (3.56)	.560" (1.42)	.44" (1.12)	.94" (2.39)	.81" (2.06)
1/2-14	2	1.13" (2.87)	1.80" (4.57)	.560" (1.42)	.63" (1.60)	1.15" (2.92)	1.00" (2.54)
3/4-14	2	1.13" (2.87)	2.10" (5.33)	.750" (1.90)	.63" (1.60)	1.44" (3.66)	1.25" (3.17)
1-11½	4	1.75" (4.44)	2.30" (5.84)	.880" (2.24)	1.10" (2.79)	1.88" (4.78)	1.63" (4.14)
1¼-11½	5	2.31" (5.87)	2.80" (7.11)	.950" (2.41)	1.43" (3.63)	2.64" (6.71)	2.29" (5.82)
1½-11½	5	2.31" (5.87)	2.80" (7.11)	.950" (2.41)	1.43" (3.63)	2.64" (6.71)	2.29" (5.82)

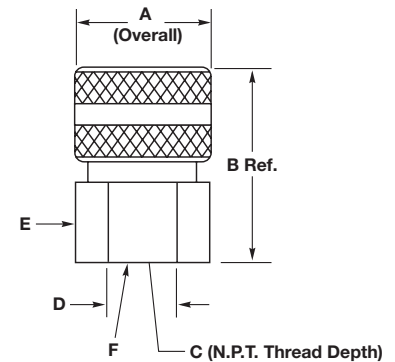

## Product Data

### Dust-Tight Strain Relief Grips for Insulated Cables

Kellems® Strain Relief Grips connect flexible cord or bus drop cable to electrical enclosures. For indoor use only, they are available with either insulated or non-insulated aluminum fittings, and feature single weave, galvanized steel mesh grips with patented wide range mesh construction. They come with a locknut and a neoprene gasket that provides a dust tight seal.

### Application

Used to connect electrical cable to power boxes, cabinets, panel boards, power centers, machine tools and with bus drop systems.

### Benefits

- Helps prevent cord or cable pull-out.
- Provides a dust tight seal.
- Easy installation.
- Patented mesh construction.
- One piece design.

### I-Grips for Insulated Cables

Kellems I-Grips are made of high strength, plastic coated galvanized steel strand. They are offered in six sizes to fit all cable diameters used with Hubbell Insulgrip®. Kellems I-Grips will control cable arc-of-bend and reduce high pull tensions from being transmitted to the wiring terminals.

### Application

Kellems I-Grips will fit 2, 3, 4 and 5 wire Hubbell Insulgrip plugs and connector bodies. The eye tabs fit under the nylon cord clamp and the screws slide through the eyelets, securing the grip in place.

I-Grips can be used on any Insulgrip cord set which requires cable, arc-of-bend control or heavy duty strain relief. Cord sets used at in-door construction sites or for plant maintenance jobs are examples.

These grips are for indoor use only.

### Benefits

- Easily attached to Insulgrip plugs and connector bodies.
- Fits all sizes.
- Provides heavy duty strain relief.
- Controls cable arc-of-bend.

Note: I-Grips should not be used on Insulgrip devices when "Seal-Tite®" weatherproof covers are to be installed.

Dimensions shown are approximate and are subject to change without notice.



**Strain Relief Grips for Liquidtight Flexible Metal and PolyTuff® I Non-Metallic Conduit**

Kellems Liquidtight, Flexible Metal Conduit Grips are offered with high quality Hubbell plated steel fittings in a wide variety of NPT sizes and configurations, either insulated or non-insulated. The addition of a stainless steel mesh to these fittings makes them stronger than the conduit itself. Kellems Conduit Grips helps prevent conduit pull-out from the connecting fitting that is subject to stress, pull tension, vibration, motion or strain. They promote safe electrical systems and reduce equipment downtime.

**Application**

Kellems Conduit Grips are used in the wiring of machine tools, motors, molding equipment, transformers, weaving and paper machines, fans, lighting, bakeries, breweries, food processing, chemical plants, dairies, mines and any application that requires Liquidtight Conduit.

**Benefits**

- Helps prevent conduit pull-out and damage at the fitting.
- Reduces equipment downtime.
- Liquidtight fittings.
- Easily installed.
- Stainless steel grip resists corrosion.

Kellems Conduit Grips are suitable for use in hazardous locations per Class I Div. 2, Class II Div. 1 & 2, Class III Div. 1 & 2 of the National Electric Code.

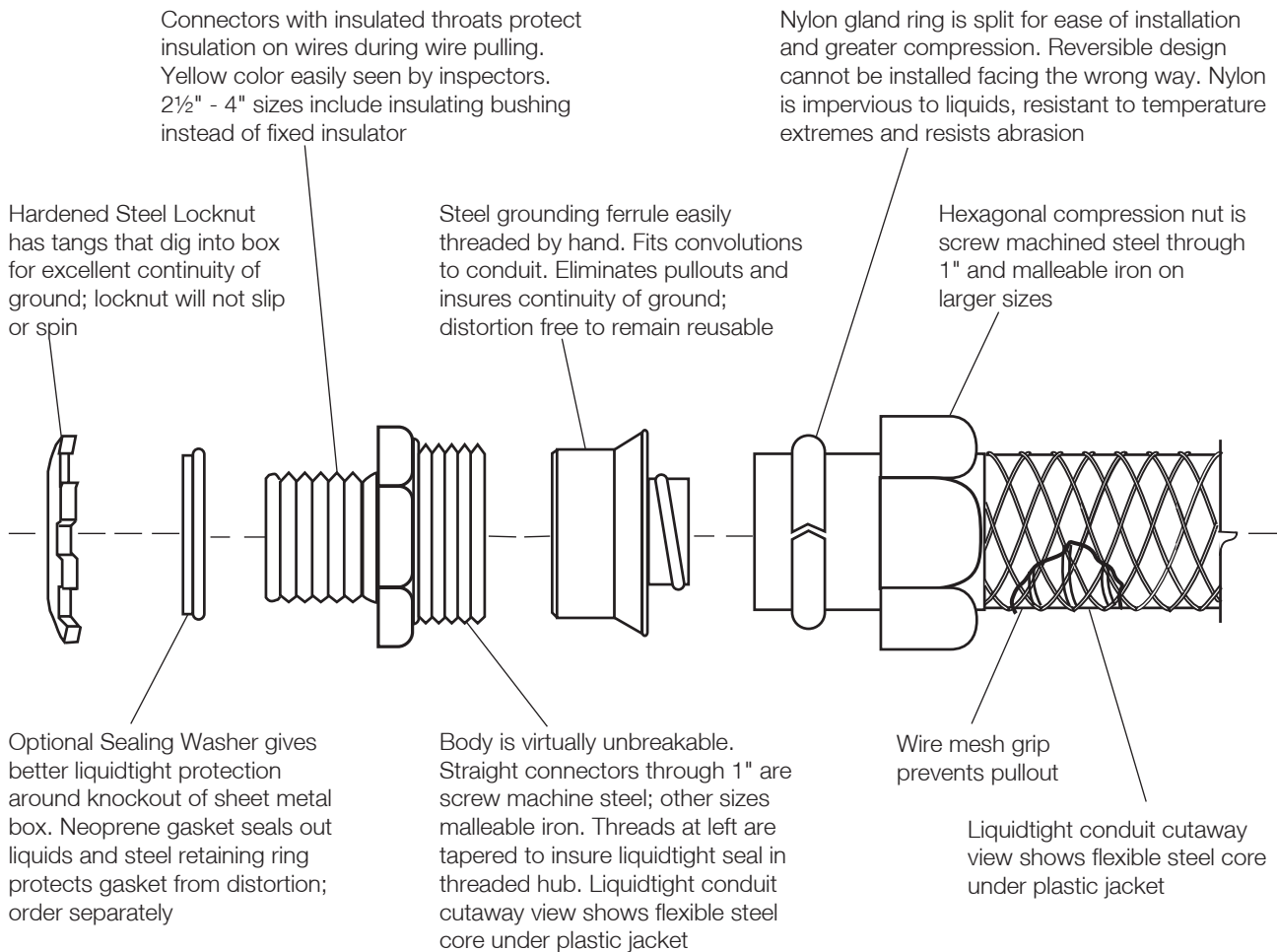



## Liquidtight Conduit Grip Fitting Dimensions, Inches

### Straight with Male Fitting

Dimensions, Inches

Trade Size Inches	A Ref.	B Ref.	C		D Throat Dia.	E		Catalog Number
			A/C*	A/F*		A/C*	A/F*	
3/8	1.43"	.59"	1.20"	1.06"	.61"	1.07"	.93"	<b>074093401</b>
1/2	1.43"	.59"	1.34"	1.19"	.61"	1.22"	1.06"	<b>074093402</b>
3/4	1.56"	.59"	1.55"	1.37"	.84"	1.43"	1.25"	<b>074093403</b>
1	1.68"	.66"	1.95"	1.69"	1.06"	1.73"	1.56"	<b>074093404</b>
1 1/4	2.03"	.63"	2.39"	2.06"	1.37"	2.36"	2.08"	<b>074093405</b>
1 1/2	2.21"	.63"	2.72"	2.38"	1.53"	2.79"	2.48"	<b>074093406</b>
2	2.28"	.69"	3.08"	2.87"	2.06"	3.32"	2.90"	<b>074093408</b>

### Straight with Male Fitting with Insulated Throat

Dimensions, Inches

Trade Size Inches	A Ref.	B Ref.	C		D Throat Dia.	E		Catalog Number
			A/C*	A/F*		A/C*	A/F*	
3/8	1.50"	.66"	1.20"	1.06"	.57"	1.07"	.93"	<b>074093511</b>
1/2	1.50"	.66"	1.34"	1.19"	.57"	1.22"	1.06"	<b>074093512</b>
3/4	1.62"	.66"	1.55"	1.38"	.78"	1.43"	1.25"	<b>074093513</b>
1	1.75"	.72"	1.95"	1.69"	.98"	1.73"	1.56"	<b>074093514</b>
1 1/4	2.09"	.69"	2.39"	2.06"	1.29"	2.36"	2.08"	<b>074093515</b>
1 1/2	2.28"	.69"	2.72"	2.37"	1.53"	2.79"	2.48"	<b>074093516</b>
2	2.34"	.75"	3.08"	2.87"	1.95"	3.32"	2.90"	<b>074093518</b>
2 1/2	3.56"	1.06"	3.92"	3.62"	2.42"	3.85"	3.60"	<b>074093520</b>
3	3.81"	1.06"	4.70"	4.31"	3.01"	4.65"	4.33"	<b>074093522</b>
4	3.81"	1.06"	5.75"	5.31"	3.96"	5.75"	5.39"	<b>074093526</b>

### 45° Angle with Male Fitting

Dimensions, Inches

Trade Size Inches	H Ref.	J Ref.	K Ref.	L		M Throat Dia.	N		Catalog Number
				A/C*	A/F*		A/C*	A/F*	
3/8	1.19"	1.28"	.59"	1.20"	1.06"	.60"	1.16"	1.02"	<b>074093441</b>
1/2	1.19"	1.28"	.59"	1.34"	1.19"	.61"	1.21"	1.06"	<b>074093442</b>
3/4	1.19"	1.43"	.59"	1.55"	1.45"	.84"	1.50"	1.32"	<b>074093443</b>
1	1.38"	1.53"	.66"	1.95"	1.69"	1.05"	1.82"	1.59"	<b>074093444</b>
1 1/4	1.42"	1.69"	.63"	2.39"	2.06"	1.37"	2.32"	2.03"	<b>074093445</b>
1 1/2	1.66"	2.00"	.66"	2.72"	2.38"	1.60"	2.62"	2.29"	<b>074093446</b>
2	1.69"	2.25"	.66"	3.08"	2.88"	2.05"	3.21"	2.80"	<b>074093448</b>

### 45° Angle with Male Fitting with Insulated Throat

Dimensions, Inches

Trade Size Inches	H Ref.	J Ref.	K Ref.	L		M Throat Dia.	N		Catalog Number
				A/C*	A/F*		A/C*	A/F*	
3/8	1.25"	1.28"	.66"	1.20"	1.06"	.57"	1.16"	1.02"	<b>074093561</b>
1/2	1.25"	1.28"	.66"	1.34"	1.19"	.57"	1.21"	1.06"	<b>074093562</b>
3/4	1.25"	1.44"	.66"	1.55"	1.45"	.78"	1.50"	1.32"	<b>074093563</b>
1	1.44"	1.53"	.72"	1.95"	1.69"	.98"	1.82"	1.59"	<b>074093564</b>
1 1/4	1.48"	1.69"	.69"	2.39"	2.06"	1.29"	2.32"	2.03"	<b>074093565</b>
1 1/2	1.72"	2.00"	.72"	2.72"	2.38"	1.53"	2.62"	2.29"	<b>074093566</b>
2	1.75"	2.25"	.72"	3.08"	2.87"	1.95"	3.21"	2.80"	<b>074093568</b>

### 90° Angle with Male Fitting

Dimensions, Inches

Trade Size Inches	D Ref.	E Ref.	F		G Ref.	O Throat Dia.	P		Catalog Number
			A/C*	A/F*			A/C*	A/F*	
3/8	1.31"	.59"	1.20"	1.06"	1.44"	.60"	1.13"	.99"	<b>074093421</b>
1/2	1.31"	.59"	1.34"	1.12"	1.44"	.61"	1.21"	1.00"	<b>074093422</b>
3/4	1.44"	.59"	1.55"	1.45"	1.63"	.83"	1.48"	1.29"	<b>074093423</b>
1	1.78"	.66"	1.95"	1.60"	2.19"	1.05"	1.80"	1.57"	<b>074093424</b>
1 1/4	1.97"	.63"	2.39"	2.06"	2.50"	1.37"	2.32"	2.02"	<b>074093425</b>
1 1/2	2.19"	.66"	2.72"	2.38"	2.69"	1.61"	2.58"	2.25"	<b>074093426</b>
2	2.53"	.66"	3.08"	2.87"	3.25"	2.05"	3.14"	2.75"	<b>074093428</b>

### 90° Angle with Male Fitting with Insulated Throat

Dimensions, Inches

Trade Size Inches	D Ref.	E Ref.	F		G Ref.	O Throat Dia.	P		Catalog Number
			A/C*	A/F*			A/C*	A/F*	
3/8	1.38"	.66"	1.20"	1.06"	1.44"	.60"	1.13"	.99"	<b>074093541</b>
1/2	1.38"	.66"	1.34"	1.12"	1.44"	.57"	1.21"	1.00"	<b>074093542</b>
3/4	1.50"	.66"	1.55"	1.45"	1.63"	.78"	1.48"	1.29"	<b>074093543</b>
1	1.84"	.66"	1.95"	1.60"	2.19"	.98"	1.80"	1.57"	<b>074093544</b>
1 1/4	2.03"	.69"	2.39"	2.06"	2.50"	1.29"	2.32"	2.02"	<b>074093545</b>
1 1/2	2.25"	.69"	2.72"	2.38"	2.69"	1.53"	2.58"	2.20"	<b>074093546</b>
2	2.59"	.72"	3.08"	2.87"	3.25"	1.95"	3.14"	2.75"	<b>074093548</b>
2 1/2	3.44"	1.00"	3.92"	3.63"	4.25"	2.42"	3.78"	3.50"	<b>074093550</b>
3	3.75"	1.00"	4.70"	4.31"	4.87"	3.01"	4.64"	4.30"	<b>074093552</b>

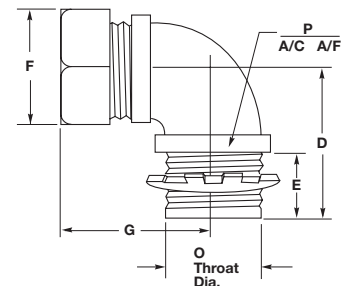
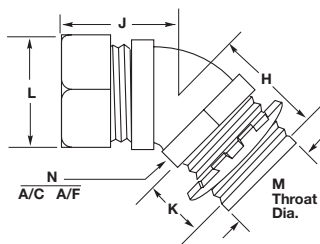
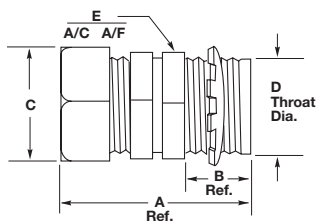

Note: \*A/C - Across Corners; A/F - Across Flats.

Dimensions shown are approximate and are subject to change without notice.



**Strain Relief for UL Type A, Flexible, Liquidtight Conduit**

Kellems Grips for UL Type A, non-metallic, flexible, liquidtight conduit are available in straight and 90° male and feature a high quality Hubbell plated steel or malleable iron fitting, complete with a sealing O-ring, lock nut and stainless steel mesh. These grips increase the retention of the conduit in the fitting, control its arc-of-bend and provide a liquidtight seal.

**Application**

These grips are used on UL Type A non-metallic conduit connections at limit switches, motor boxes, panel boards, control stations and on all types of machinery and machine tools.

Steel Locknut has tangs that dig into box for excellent continuity of ground; locknut will not slip or spin

Neoprene O-ring is factory assembled into the body to seal out liquids to seal out liquids

Insulated throat protects insulation on wires during pulling; yellow color easily seen by inspectors

Yellow nylon ferrule fits inside non-metallic conduit to hold the shape; barb in designed to assure liquidtight seal even with non-square cut; ferrule is keyed to fit into body to prevent conduit twisting

**Benefits**

- Provides a liquidtight seal.
- Helps prevent conduit pull-out.
- Reduces conduit cutting, kinking, fraying and splitting at the fitting.
- Easily installed.

Body is virtually unbreakable. Straight connectors through 1" are screw machine steel; other sizes are malleable iron. Threads are tapered to insure liquidtight seal when used in threaded hub; octagonal shape inside holds the ferrule to prevent conduit from twisting during installation

Wire mesh grip prevents pullout

Hexagonal compression nut is machine steel through 1" malleable iron on larger sizes; tapered interior compresses sleeve over conduit sealing out liquids and preventing pullout

Yellow nylon sleeve installs over conduit; six slits in sleeve permit tight compression onto conduit as compression nut is tightened

**Dimensional Charts For UL Type A, Liquidtight Conduit Grip Fittings**

**Straight with Male Fitting with Insulated Throat**

Dimensions Inches (cm)

Trade Size NPT Inches	A	B	C	D	Catalog Number
3/8	1.922" (4.88)	.594" (1.51)	1.156" (2.94)	3.75" (9.52)	<b>H038CNK</b>
1/2	1.922" (4.88)	.594" (1.51)	1.250" (3.17)	4.50" (11.43)	<b>H050CNK</b>
3/4	2.016" (5.12)	.594" (1.51)	1.500" (3.81)	6.25" (15.87)	<b>H075CNK</b>
1	2.157" (5.48)	.719" (1.83)	1.844" (4.68)	7.50" (19.05)	<b>H100CNK</b>
1 1/4	2.219" (5.64)	.750" (1.91)	2.312" (5.87)	9.00" (22.86)	<b>H125CNK</b>
1 1/2	2.344" (5.95)	.750" (1.91)	2.578" (6.55)	13.50" (34.29)	<b>H150CNK</b>
2	2.406" (6.11)	.750" (1.91)	3.187" (8.09)	14.50" (36.83)	<b>H200CNK</b>

**90° Angle with Male Fitting with Insulated Throat**

Dimensions Inches (cm)

Trade Size NPT Inches	E	F	G	H	I	Catalog Number
3/8	1.250" (3.18)	.594" (1.51)	1.156" (2.94)	1.453" (3.69)	3.75" (9.52)	<b>H0389CNK</b>
1/2	1.281" (3.25)	.594" (1.51)	1.250" (3.17)	1.453" (3.69)	4.50" (11.43)	<b>H0509CNK</b>
3/4	1.438" (3.65)	.594" (1.51)	1.500" (3.81)	1.000" (2.54)	6.25" (15.87)	<b>H0759CNK</b>
1	1.750" (4.44)	.719" (1.83)	1.844" (4.68)	2.125" (5.40)	7.50" (19.05)	<b>H1009CNK</b>
1 1/4	1.969" (5.00)	.750" (1.91)	2.312" (5.87)	2.344" (5.95)	9.00" (22.86)	<b>H1259CNK</b>
1 1/2	2.250" (5.71)	.750" (1.91)	2.578" (6.55)	2.500" (6.35)	13.50" (34.29)	<b>H1509CNK</b>
2	2.531" (6.43)	.750" (1.91)	3.187" (8.09)	2.781" (7.06)	14.50" (36.83)	<b>H2009CNK</b>

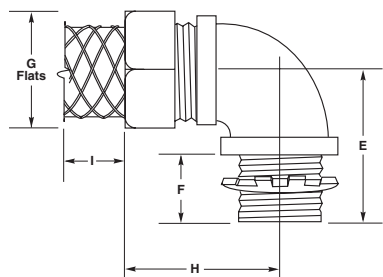
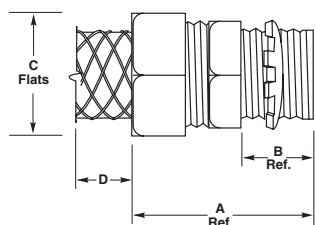
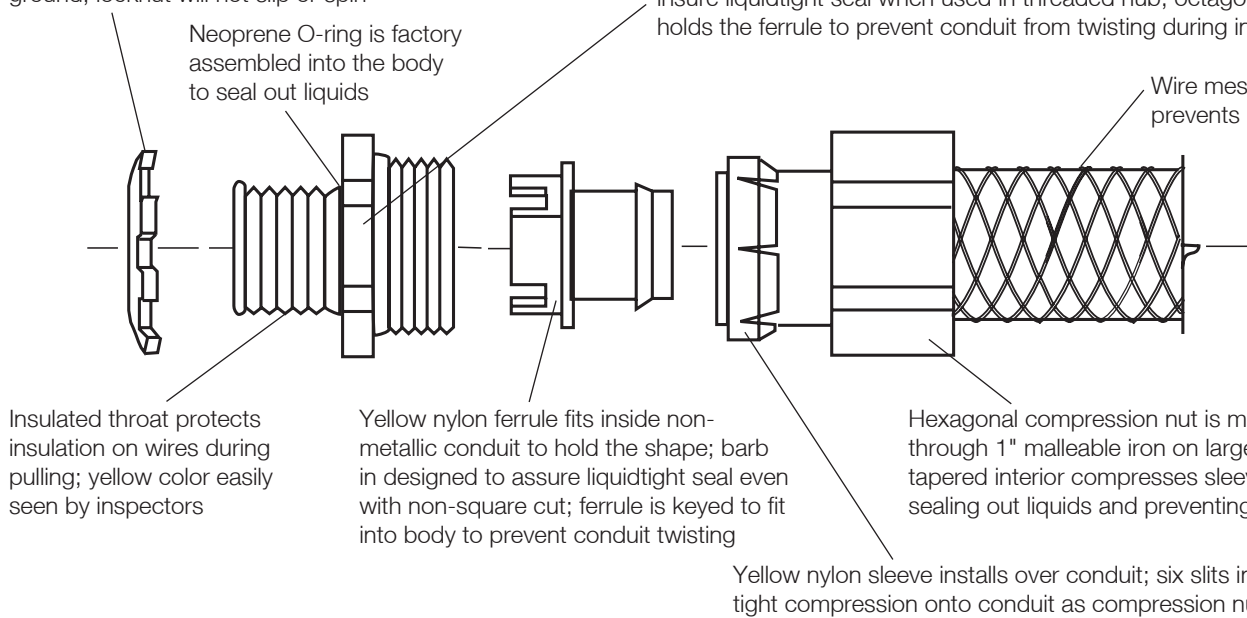

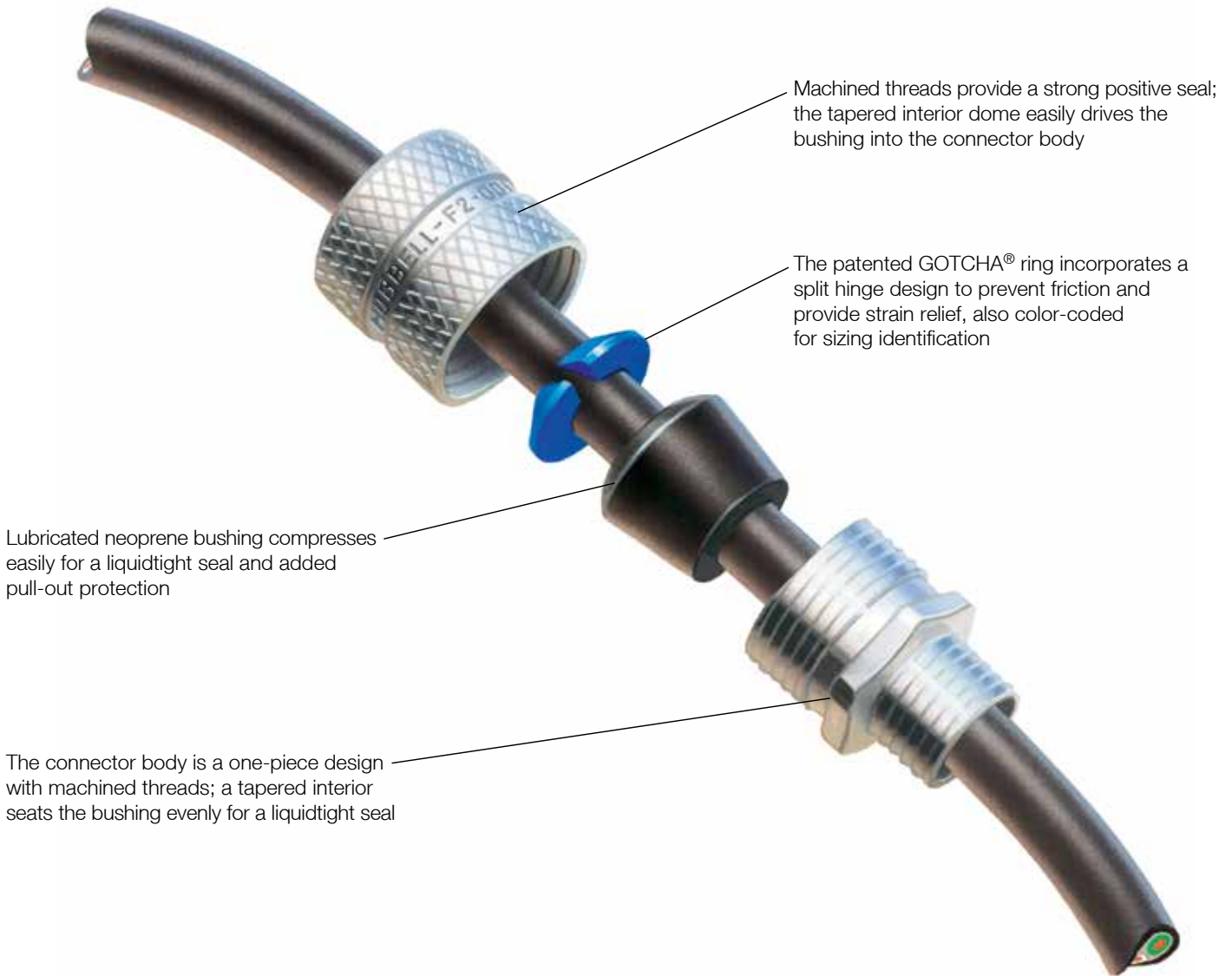

Machined threads provide a strong positive seal; the tapered interior dome easily drives the bushing into the connector body

The patented GOTCHA® ring incorporates a split hinge design to prevent friction and provide strain relief, also color-coded for sizing identification

Lubricated neoprene bushing compresses easily for a liquidtight seal and added pull-out protection

The connector body is a one-piece design with machined threads; a tapered interior seats the bushing evenly for a liquidtight seal

Hubbell has the broadest line and the widest choice of materials in the industry. NPT hub sizes from 1/4" to 3" in straight male end, 90°, 45°, female and underground feed connectors. They are available in your choice of aluminum, plated steel, nylon and stainless steel.

Hubbell offers a full line of machined aluminum cord connectors in NPT hub sizes 1/4" through 1" and cast aluminum 1" to 3". They provide durable performance and a clean attractive look without adding unwanted weight. NPT hub sizes 1/4" to 1" feature an attractive knurled finish which makes them easy to handle and maintain a U.L. listing by hand tightening.

The zinc-plated steel cord connectors offers the strength of steel and the corrosion resistance of zinc-plating. These heavy-duty connectors hold up to most manufacturing chemicals including acid solutions, solvents and other corrosive materials.

Their machined steel nut and body allows for tightening the compression nut and NPT hub without worrying about stripping the threads. For larger size cord, NPT hub sizes 1" to 2", Hubbell utilizes malleable iron connectors which provide excellent holding and liquidtight performance.

Hubbell's nylon cord connectors resist most common industrial corrosives and provide highly effective pullout protection in a lightweight design. They are ideal for any application where weight, conductivity or corrosion may be an issue. They're available in NPT hub sizes from 1/4" to 1".

Stainless steel cord connectors provide superior strength and corrosion resistance for industrial and military applications. They are machined from 300 series stainless steel and come in 1/4" to 1", NPT hub sizes.

**IP66\***  
 SUITABILITY

**Straight Male**



**Machined Aluminum**



**Machined Zinc-Plated Steel**



**Stainless Steel**



**Gray Nylon**



**Black Nylon**

NPT Hub Size	Cord Dia. Inches (mm)	Form Size	Color Code	Machined Aluminum	Machined Zinc-Plated Steel	Stainless Steel	Nylon Gray	Nylon Black
¼	.06"-.13" (1.6-3.2)	F1	Green	—	—	—	<b>SHC1001CR</b>	—
	.13"-.19" (3.2-4.7)		Orange	<b>SHC1002</b>	—	—	<b>SHC1002CR</b>	—
	.19"-.25" (4.7-6.3)		Red	<b>SHC1003</b>	—	<b>SHC1003SS</b>	<b>SHC1003CR</b>	—
	.25"-.31" (6.3-7.9)		Black	<b>SHC1004</b>	—	<b>SHC1004SS</b>	<b>SHC1004CR</b>	—
	.31"-.38" (7.9-9.5)		White	<b>SHC1005**</b>	—	—	<b>SHC1005CR</b>	<b>SHC2005CR</b>
	.38"-.44" (9.5-11)		Blue	—	—	—	<b>SHC1006CR</b>	—
⅜	.06"-.13" (1.6-3.2)	F1	Green	<b>SHC1007</b>	—	—	—	—
	.13"-.19" (3.2-4.7)		Orange	<b>SHC1008</b>	<b>SHC1008ZP</b>	—	<b>SHC1008CR</b>	<b>SHC2008CR</b>
	.19"-.25" (4.7-6.3)		Red	<b>SHC1009</b>	—	<b>SHC1009SS</b>	<b>SHC1009CR</b>	—
	.25"-.31" (6.3-7.9)		Black	<b>SHC1010</b>	<b>SHC1010ZP</b>	—	<b>SHC1010CR</b>	<b>SHC2010CR</b>
	.31"-.38" (7.9-9.5)		White	<b>SHC1011</b>	—	<b>SHC1011SS</b>	<b>SHC1011CR</b>	<b>SHC2011CR</b>
	.38"-.44" (9.5-11.0)		Blue	<b>SHC1012</b>	<b>SHC1012ZP</b>	<b>SHC1012SS</b>	<b>SHC1012CR</b>	<b>SHC2012CR</b>
½	.19"-.25" (4.7-6.3)	F1	Red	<b>SHC1015</b>	—	—	—	—
	.25"-.31" (6.3-7.9)		Black	<b>SHC1016</b>	—	—	—	—
	.31"-.38" (7.9-9.5)		White	<b>SHC1017</b>	—	—	—	—
	.38"-.44" (9.5-11.0)		Blue	<b>SHC1018</b>	—	—	—	—
½	.06"-.13" (1.6-3.2)	F2	Green	<b>SHC1019</b>	—	—	<b>SHC1019CR</b>	—
	.13"-.19" (3.2-4.7)		Orange	<b>SHC1020</b>	<b>SHC1020ZP</b>	<b>SHC1020SS</b>	<b>SHC1020CR</b>	—
	.19"-.25" (4.7-6.3)		Red	<b>SHC1021</b>	<b>SHC1021ZP</b>	<b>SHC1021SS</b>	<b>SHC1021CR</b>	<b>SHC2021CR</b>
	.25"-.38" (6.3-9.7)		White	<b>SHC1022</b>	<b>SHC1022ZP</b>	<b>SHC1022SS</b>	<b>SHC1022CR</b>	<b>SHC2022CR</b>
	.38"-.50" (9.7-12.7)		Blue	<b>SHC1023</b>	<b>SHC1023ZP</b>	<b>SHC1023SS</b>	<b>SHC1023CR</b>	<b>SHC2023CR</b>
	.50"-.63" (12.7-15.9)		Brown	<b>SHC1024</b>	<b>SHC1024ZP</b>	<b>SHC1024SS</b>	<b>SHC1024CR**</b>	<b>SHC2024CR**</b>
½	.38"-.50" (9.7-12.7)	F3	Blue	<b>SHC1025</b>	—	—	—	—
	.50"-.63" (12.7-15.9)		Brown	<b>SHC1026</b>	—	—	—	—
	.63"-.75" (15.9-19.0)		Yellow	<b>SHC1027**</b>	<b>SHC1027ZP**</b>	—	—	—
	.75"-.88" (19.0-22.2)		Orchid	<b>SHC1028**</b>	<b>SHC1028ZP**</b>	—	—	—

Note: See pages V-87 to V-95 for technical information and dimensional drawings.  
 \*IP66 Suitability when used with optional metal clad O-ring, see page V-84 for additional information.  
 \*\*Cable jacket may have to be stripped to pass through connector body.  
 Locknuts sold separately. See page V-84 for additional information.

**IP66\***  
 SUITABILITY

**Straight Male**

NPT Hub Size	Cord Dia. Inches (mm)	Form Size	Color Code	Machined Aluminum	Machined Zinc-Plated Steel	Stainless Steel	Nylon Gray	Nylon Black
3/4	.06"-.13" (1.6-3.2)	F2	Green	<b>SHC1029</b>	—	—	—	—
	.13"-.19" (3.2-4.7)		Orange	<b>SHC1030</b>	<b>SHC1030ZP</b>	—	—	—
	.19"-.25" (4.7-6.3)		Red	<b>SHC1031</b>	<b>SHC1031ZP</b>	—	—	—
	.25"-.38" (6.3-9.7)		White	<b>SHC1032</b>	<b>SHC1032ZP</b>	—	—	—
	.38"-.50" (9.7-12.7)		Blue	<b>SHC1033</b>	<b>SHC1033ZP</b>	—	—	—
	.50"-.63" (12.7-15.9)		Brown	<b>SHC1034</b>	<b>SHC1034ZP</b>	—	—	—
3/4	.38"-.50" (9.5-12.7)	F3	Blue	—	<b>SHC1035ZP</b>	<b>SHC1035SS</b>	<b>SHC1035CR</b>	<b>SHC2035CR</b>
	.50"-.63" (12.7-15.9)		Brown	<b>SHC1036</b>	—	<b>SHC1036SS</b>	<b>SHC1036CR</b>	<b>SHC2036CR</b>
	.63"-.75" (15.9-19.0)		Yellow	<b>SHC1037</b>	<b>SHC1037ZP</b>	<b>SHC1037SS</b>	<b>SHC1037CR</b>	<b>SHC2037CR</b>
	.75"-.88" (19.0-22.2)		Orchid	<b>SHC1038**</b>	<b>SHC1038ZP**</b>	<b>SHC1038SS**</b>	<b>SHC1038CR**</b>	<b>SHC2038CR**</b>
1	.50"-.63" (12.7-15.9)	F3	Brown	—	<b>SHC1097ZP</b>	—	—	—
	.63"-.75" (15.9-19.0)		Yellow	—	<b>SHC1098ZP</b>	—	—	—
	.75"-.88" (19.0-22.2)		Orchid	—	<b>SHC1099ZP</b>	—	—	—
1	.38"-.50" (9.7-12.7)	F4	Blue	<b>SHC1039</b>	—	—	<b>SHC1039CR</b>	—
	.50"-.63" (12.7-15.9)		Brown	<b>SHC1040</b>	—	—	<b>SHC1040CR</b>	<b>SHC2040CR</b>
	.63"-.75" (15.9-19.0)		Yellow	<b>SHC1041</b>	—	<b>SHC1041SS</b>	<b>SHC1041CR</b>	<b>SHC2041CR</b>
	.75"-.88" (19.0-22.2)		Orchid	<b>SHC1042</b>	—	<b>SHC1042SS</b>	<b>SHC1042CR</b>	<b>SHC2042CR</b>
	.88"-.1.00" (22.2-25.4)		Gray	<b>SHC1043</b>	<b>SHC1043ZP</b>	<b>SHC1043SS</b>	<b>SHC1043CR</b>	<b>SHC2043CR</b>
	1.00"-.1.13" (25.4-28.6)		Pink	<b>SHC1044**</b>	—	<b>SHC1044SS**</b>	<b>SHC1044CR**</b>	<b>SHC2044CR**</b>



**Machined Aluminum**



**Machined Zinc-Plated Steel**



**Stainless Steel**



**Gray Nylon**



**Black Nylon**

Note: See pages V-87 to V-95 for technical information and dimensional drawings.  
 \*IP66 Suitability when used with optional metal clad O-ring, see page V-84 for additional information.  
 \*\*Cable jacket may have to be stripped to pass through connector body.  
 Form 4 aluminum and plated steel nuts are machined, bodies are cast aluminum.  
 Locknuts sold separately. See page V-84 for additional information.

**IP66\***  
 SUITABILITY

**Straight Male**



Cast Aluminum



Cast Aluminum  
 Malleable Iron

NPT Hub Size	Cord Diameter Inches	(mm)	Form Size	Cast Aluminum	Malleable Iron
1	.88"-1.00"	(22.2-25.4)	F5	<b>SHC1046</b>	—
	1.00"-1.13"	(25.4-28.6)		<b>SHC1047**</b>	—
	1.13"-1.25"	(28.6-31.7)		<b>SHC1048**</b>	—
	1.25"-1.38"	(31.7-34.9)		<b>SHC1049**</b>	—
1¼	.75"- .88"	(19.0-22.2)	F5	<b>SHC1050</b>	—
	.88"-1.00"	(22.2-25.4)		<b>SHC1051</b>	—
	1.00"-1.13"	(25.4-28.6)		<b>SHC1052</b>	<b>SHC1052ZP</b>
	1.13"-1.25"	(28.6-31.7)		<b>SHC1053</b>	<b>SHC1053ZP</b>
1½	1.25"-1.38"	(31.7-34.9)	F5	<b>SHC1054**</b>	<b>SHC1054ZP</b>
	.75"- .88"	(19.0-22.2)		<b>SHC1055</b>	—
	.88"-1.00"	(22.2-25.4)		<b>SHC1056</b>	—
	1.00"-1.13"	(25.4-28.6)		<b>SHC1057</b>	<b>SHC1057ZP</b>
1½	1.13"-1.25"	(28.6-31.7)	F5	<b>SHC1058</b>	<b>SHC1058ZP</b>
	1.25"-1.38"	(31.7-34.9)		<b>SHC1059</b>	<b>SHC1059ZP</b>
	1.38"-1.50"	(34.9-38.1)		<b>SHC1061</b>	—
	1.50"-1.63"	(38.1-41.3)		<b>SHC1062**</b>	—
2	1.63"-1.75"	(41.3-44.4)	F6	<b>SHC1063**</b>	—
	1.75"-1.88"	(44.4-47.6)		<b>SHC1064**</b>	—
	1.25"-1.38"	(31.7-34.9)		<b>SHC1065</b>	—
	1.38"-1.50"	(34.9-38.1)		<b>SHC1066</b>	—
2	1.50"-1.63"	(38.1-41.3)	F6	<b>SHC1067</b>	—
	1.63"-1.75"	(41.3-44.4)		<b>SHC1068</b>	—
	1.75"-1.88"	(44.4-47.6)		<b>SHC1069</b>	—
	1.69"-1.81"	(42.9-46.0)		<b>SHC1070</b>	—
2	1.81"-1.94"	(46.0-49.2)	F7	<b>SHC1071</b>	—
	1.94"-2.06"	(49.2-52.4)		<b>SHC1072**</b>	—
	2.06"-2.19"	(52.4-55.6)		<b>SHC1073**</b>	—
	2.19"-2.31"	(55.6-58.7)		<b>SHC1074**</b>	—
2½	1.69"-1.81"	(42.9-46.0)	F7	<b>SHC1076</b>	—
	1.81"-1.94"	(46.0-49.2)		<b>SHC1077</b>	—
	1.94"-2.06"	(49.2-52.4)		<b>SHC1078</b>	—
	2.06"-2.19"	(52.4-55.6)		<b>SHC1079</b>	—
3	2.19"-2.31"	(55.6-58.7)	F7	<b>SHC1080</b>	—
	2.31"-2.44"	(58.7-61.9)		<b>SHC1081**</b>	—
	1.69"-1.81"	(42.9-46.0)		<b>SHC1086</b>	—
	1.94"-2.06"	(49.2-52.4)		<b>SHC1088</b>	—
3	2.06"-2.19"	(52.4-55.6)	F7	<b>SHC1089</b>	—
	2.19"-2.31"	(55.6-58.7)		<b>SHC1090</b>	—
	2.31"-2.44"	(58.7-61.9)		<b>SHC1091</b>	—
	2.44"-2.63"	(61.9-66.7)		<b>SHC1092</b>	—
3	2.63"-2.81"	(66.7-71.4)	F8	<b>SHC1093</b>	—
	2.81"-3.00"	(71.4-76.2)		<b>SHC1094</b>	—
	3.00"-3.25"	(76.2-82.5)		<b>SHC1095**</b>	—

Note: See pages V-87 to V-95 for technical information and dimensional drawings.  
 \*IP66 Suitability when used with optional metal clad O-ring, see page V-84 for additional information.  
 \*\*Cable jacket may have to be stripped to pass through connector body.  
 Form 4 aluminum and plated steel nuts are machined, bodies are cast aluminum.  
 F5 and larger will not be color coded.  
 Locknuts sold separately. See page V-84 for additional information.



**IP66\***  
 SUITABILITY



**45° Male**

NPT Hub Size	Cord Diameter Inches	(mm)	Form Size	Color Code	Machined Aluminum†	Machined Zinc-Plated SteelΔ	Cast Aluminum
½	.19"-.25"	(4.7-6.3)	F2	Red	<b>VHC1021</b>	—	—
	.25"-.38"	(6.3-9.7)		White	<b>VHC1022</b>	<b>VHC1022ZP</b>	—
	.38"-.50"	(9.7-12.7)		Blue	<b>VHC1023</b>	<b>VHC1023ZP</b>	—
	.50"-.63"	(12.7-15.9)		Brown	<b>VHC1024**</b>	<b>VHC1024ZP**</b>	—
¾	.38"-.50"	(9.7-12.7)	F3	Blue	<b>VHC1035</b>	—	—
	.50"-.63"	(12.7-15.9)		Brown	<b>VHC1036</b>	—	—
	.63"-.75"	(15.9-19.0)		Yellow	<b>VHC1037**</b>	—	—
1	.63"-.75"	(15.9-19.0)	F4	Yellow	<b>VHC1041</b>	—	—
	.75"-.88"	(19.0-22.2)		Orchid	<b>VHC1042</b>	—	—
1¼	1.00"-1.13"	(25.4-28.6)	F5	—	—	—	<b>VHC1052</b>
	1.13"-1.25"	(28.6-31.7)		—	—	—	<b>VHC1053**</b>



**90° Male**

NPT Hub Size	Cord Diameter Inches	(mm)	Form Size	Color Code	Machined Aluminum†	Machined Zinc-Plated SteelΔ	Nylon Gray	Nylon Black	Cast Aluminum
¾	.25"-.31"	(6.3-7.9)	F1	Black	<b>NHC1010</b>	—	—	—	—
	.31"-.38"	(7.9-9.5)		White	<b>NHC1011</b>	—	—	—	—
	.38"-.44"	(9.5-11.0)		Blue	<b>NHC1012</b>	—	—	—	—
½	.06"-.13"	(1.6-3.2)	F2	Green	—	—	—	—	—
	.13"-.19"	(3.2-4.7)		Orange	<b>NHC1020</b>	—	<b>NHC1020CR</b>	—	—
	.19"-.25"	(4.7-6.3)		Red	<b>NHC1021</b>	<b>NHC1021ZP</b>	<b>NHC1021CR</b>	—	—
	.25"-.38"	(6.3-9.7)		White	<b>NHC1022</b>	<b>NHC1022ZP</b>	<b>NHC1022CR</b>	<b>NHC2022CR</b>	—
	.38"-.50"	(9.7-12.7)		Blue	<b>NHC1023</b>	<b>NHC1023ZP</b>	<b>NHC1023CR</b>	<b>NHC2023CR</b>	—
	.50"-.63"	(12.7-15.9)		Brown	<b>NHC1024**</b>	<b>NHC1024ZP**</b>	<b>NHC1024CR**</b>	<b>NHC2024CR**</b>	—
¾	.38"-.50"	(9.7-12.7)	F3	Blue	<b>NHC1035</b>	<b>NHC1035ZP</b>	<b>NHC1035CR</b>	—	—
	.50"-.63"	(12.7-15.9)		Brown	<b>NHC1036</b>	<b>NHC1036ZP</b>	<b>NHC1036CR</b>	—	—
	.63"-.75"	(15.9-19.0)		Yellow	<b>NHC1037</b>	<b>NHC1037ZP</b>	<b>NHC1037CR</b>	—	—
	.75"-.88"	(19.0-22.2)		Orchid	<b>NHC1038</b>	<b>NHC1038ZP</b>	<b>NHC1038CR</b>	—	—
1	.50"-.63"	(12.7-15.9)	F4	Brown	<b>NHC1040</b>	—	—	—	—
	.63"-.75"	(15.9-19.0)		Yellow	<b>NHC1041</b>	<b>NHC1041ZP</b>	<b>NHC1041CR</b>	<b>NHC2041CR</b>	—
	.75"-.88"	(19.0-22.2)		Orchid	<b>NHC1042</b>	—	<b>NHC1042CR</b>	<b>NHC2042CR**</b>	—
	.88"-1.00"	(22.2-25.4)		Gray	<b>NHC1043**</b>	—	<b>NHC1043CR</b>	<b>NHC2043CR**</b>	—
	1.00"-1.13"	(25.4-28.7)		Pink	<b>NHC1044**</b>	—	—	—	—
1¼	.88"-1.00"	(22.2-25.4)	F5	—	—	—	—	—	<b>NHC1051</b>
	1.00"-1.13"	(25.4-28.6)		—	—	—	—	—	<b>NHC1052</b>
	1.13"-1.25"	(28.6-31.7)		—	—	—	—	—	<b>NHC1053**</b>
	1.25"-1.38"	(31.7-34.9)		—	—	—	—	—	<b>NHC1054**</b>
1½	1.00"-1.13"	(25.4-28.6)	F5	—	—	—	—	—	<b>NHC1057</b>
	1.13"-1.25"	(28.6-31.7)		—	—	—	—	—	—
	1.25"-1.38"	(31.7-34.9)		—	—	—	—	—	<b>NHC1059</b>
2	1.38"-1.50"	(34.9-38.1)	F6	—	—	—	—	<b>NHC1066</b>	

Note: See pages V-87 to V-95 for technical information and dimensional drawings.  
 \*IP66 Suitability when used with optional metal clad O-ring, see page V-84 for additional information.  
 \*\*Cable jacket may have to be stripped to pass through connector body.  
 †Nuts are machined aluminum and bodies are cast aluminum.  
 ΔCompression nuts are machined zinc-plated steel and bodies are zinc-plated malleable iron.  
 Locknuts sold separately. See page V-84 for additional information.



**Machined Aluminum**

**Straight Female**

NPT Hub Size	Cord Diameter		Form Size	Color Code	Machined Aluminum
	Inches	(mm)			
1/2	.25"-.38"	(6.3-9.7)	F2	White	<b>FHC1022</b>
	.38"-.50"	(9.7-12.7)		Blue	<b>FHC1023</b>
3/4	.38"-.50"	(9.7-12.7)	F2	Blue	<b>FHC1033</b>
	.50"-.63"	(12.7-15.9)		Brown	<b>FHC1034</b>
1	.75"-.88"	(19.0-22.2)	F4	Orchid	<b>FHC1042†</b>
	.88"-1.00"	(22.2-25.4)		Gray	<b>FHC1043†</b>

Note: See pages V-87 to V-95 for technical information and dimensional drawings.

\*Cable jacket may have to be stripped to pass through connector body.

†Nuts are machined aluminum and bodies are cast aluminum.



**Machined Aluminum**

**IP66\***  
SUITABILITY



**Underground Feeder Connectors**

NPT Hub Size	Cord Diameter		Wire Size	UF** Machined Aluminum	Machined Zinc-Plated Steel	Nylon Gray	Nylon Black
	Inches	(mm)					
1/2	.2"x.4" min	(5.1 x 10.2)	2 # 14,	<b>UFC0001</b>	<b>UFC0001ZP</b>	<b>UFC0001CR</b>	<b>UFC2001CR</b>
	.25"-.55" max	(6.3 x 14.0)	2 # 12, 2 # 10.				
3/4	.2"x.4" min	(5.1x10.2)	2 # 14,	<b>UFC0002</b>	-	-	-
	.25"-.55" max	(6.3x14.0)	2 # 12, 2 # 10.				
3/4	.2"x.6" min	(5.1x15.2)	3 # 14,	<b>UFC0003</b>	-	<b>UFC0003CR</b>	<b>UFC2003CR</b>
			3 # 12,				
			3 # 10.				

Note: See pages V-87 to V-95 for technical information and dimensional drawings.

\*IP66 Suitability when used with optional metal clad O-ring, see page V-84 for additional information.

\*\*Wire sizes vary among manufacturers.

Locknuts sold separately, see page V-84 for additional information.



**Gray Nylon**

**UL** UL Listed to Type 4, 4X, 12 and Type 13†

**Metric Aluminum Cord Connectors**

Metric Hub Size	Cord Diameter		Form Size	Catalog Number
	Inches	(mm)		
M16	.31"-.38"	(7.9-9.7)	F1	<b>SHCM161011</b>
M20	.31"-.38"	(7.9-9.7)	F1	<b>SHCM201017</b>
	.25"-.38"	(6.3-9.7)		<b>SHCM201022</b>
M20	.38"-.50"	(9.7-12.7)	F2	<b>SHCM201023</b>
	.50"-.62"	(12.7-15.8)		<b>SHCM201024</b>
M25	.38"-.50"	(9.7-12.7)	F2	<b>SHCM251033</b>
	.50"-.62"	(12.7-15.8)		<b>SHCM251034</b>
M30	.63"-75"	(15.9-19.0)	F3	<b>SHCM301037</b>

Note: †When used with metal clad O-ring, see page V-84 for additional information.

Non-metallic Locknuts sold separately, see page V-84 for additional information.



**Machined Aluminum**



**IP66\***  
 SUITABILITY

**Low Profile NPT Cord Connectors**

NPT Hub Size	Cord Diameter Inches	(mm)	Color	Catalog Number	Non-metallic Locknuts
3/8	.18"-.31"	(4.6-7.9)	Gray	<b>SEC38GA*</b>	<b>31622002LPK50</b>
3/8	.18"-.31"	(4.6-7.9)	Black	<b>SEC38BA*</b>	<b>31622002LPK50</b>
1/2	.17"-.45"	(4.3-11.4)	Gray	<b>SEC50GA</b>	<b>31622003LPK50</b>
1/2	.17"-.45"	(4.3-11.4)	Black	<b>SEC50BA</b>	<b>31622003LPK50</b>
3/4	.45"-.71"	(11.4-18.0)	Gray	<b>SEC75GA</b>	<b>31622007LPK50</b>
3/4	.45"-.71"	(11.4-18.0)	Black	<b>SEC75BA</b>	<b>31622007LPK50</b>
1	.59"-1.00"	(15-25.4)	Gray	<b>SEC100GA</b>	<b>31622008LPK50</b>
1	.59"-1.00"	(15-25.4)	Black	<b>SEC100BA</b>	<b>31622008LPK50</b>



**SEC100BA**

Note: See pages V-87 to V-95 for technical information and dimensional drawings.  
 Catalog numbers with "PK50" suffix are bulk packed 50 pieces.

**Low Profile PG<sup>Δ</sup> Cord Connectors**

Hub Size	Cord Diameter Inches	(mm)	Color	Catalog Number	Non-metallic Locknuts
PG7	.11"-.25"	(2.9-6.4)	Gray	<b>SECP7GA*</b>	<b>LNP7BPK100</b>
PG7	.11"-.25"	(2.9-6.4)	Black	<b>SECP7BA*</b>	<b>LNP7BPK100</b>
PG9	.18"-.31"	(4.6-7.9)	Gray	<b>SECP9GA*</b>	<b>LNP9BPK100</b>
PG9	.18"-.31"	(4.6-7.9)	Black	<b>SECP9BA*</b>	<b>LNP9BPK100</b>
PG11	.23"-.40"	(5.8-10.0)	Gray	<b>SECP11GA*</b>	<b>LNP11BPK100</b>
PG11	.23"-.40"	(5.8-10.0)	Black	<b>SECP11BA*</b>	<b>LNP11BPK100</b>
PG13.5	.17"-.47"	(4.3-11.9)	Gray	<b>SECP13GA</b>	<b>LNP13BPK100</b>
PG13.5	.17"-.47"	(4.3-11.9)	Black	<b>SECP13BA</b>	<b>LNP13BPK100</b>
PG16	.23"-.53"	(5.8-13.5)	Gray	<b>SECP16GA</b>	<b>LNP16BPK100</b>
PG16	.23"-.53"	(5.8-13.5)	Black	<b>SECP16BA</b>	<b>LNP16BPK100</b>
PG21	.45"-.71"	(11.4-17.9)	Gray	<b>SECP21GA</b>	<b>LNP21BPK100</b>
PG21	.45"-.71"	(11.4-17.9)	Black	<b>SECP21BA</b>	<b>LNP21BPK100</b>
PG29	.59"-.99"	(15-25.2)	Gray	<b>SECP29GA</b>	<b>LNP29BPK25</b>
PG29	.59"-.99"	(15-25.2)	Black	<b>SECP29BA</b>	<b>LNP29BPK25</b>
PG36	.88"-1.30"	(22.2-32.0)	Gray	<b>SECP36GA</b>	<b>LNP36BPK25</b>
PG36	.88"-1.30"	(22.2-32.0)	Black	<b>SECP36BA</b>	<b>LNP36BPK25</b>



**SECP29GA**

**Low Profile Metric Cord Connectors**

Hub Size	Cord Diameter Inches	(mm)	Color	Catalog Number	Non-metallic Locknuts
M12	.12"-.25"	(2.9-6.4)	Gray	<b>SECM12G</b>	<b>LNM12BPK100</b>
M12	.12"-.25"	(2.9-6.4)	Black	<b>SECM12B</b>	<b>LNM12BPK100</b>
M16	.11"-.31"	(2.7-7.9)	Gray	<b>SECM16G</b>	<b>LNM16BPK100</b>
M16	.11"-.31"	(2.7-7.9)	Black	<b>SECM16B</b>	<b>LNM16BPK100</b>
M20	.17"-.45"	(4.3-11.4)	Gray	<b>SECM20G*</b>	<b>LNM20BPK100</b>
M20	.17"-.45"	(4.3-11.4)	Black	<b>SECM20B*</b>	<b>LNM20BPK100</b>
M25	.49"-.71"	(12.3-18.0)	Gray	<b>SECM25G*</b>	<b>LNM25BPK100</b>
M25	.49"-.71"	(12.3-18.0)	Black	<b>SECM25B*</b>	<b>LNM25BPK100</b>
M32	.59"-1.00"	(15.0-25.4)	Gray	<b>SECM32G*</b>	<b>LNM32BPK100</b>
M32	.59"-1.00"	(15.0-25.4)	Black	<b>SECM32B*</b>	<b>LNM32BPK100</b>
M40	.87"-1.30"	(22.0-32.0)	Gray	<b>SECM40G</b>	<b>LNM40BPK100</b>
M40	.87"-1.30"	(22.0-32.0)	Black	<b>SECM40B</b>	<b>LNM40BPK100</b>



**LNP29BPK25**

Note: See pages V-87 to V-96 for technical information and dimensional drawings.  
 Catalog numbers above with "PK100" suffix, i.e. LNP7BPK100, are bulk packed 100 per carton.  
 Catalog numbers above with "PK25" suffix, i.e. LNP29BPK25, are bulk packed 25 per carton.  
 \*Items indicated are UL recognized components.  
 ΔPanzergewinde.



SEC100BSMH9

### Multi-Hole Cord Grip Connectors

NPT Hub Size	Cord Diameter Inches (mm)	Color	Holes	Catalog Number
½	.205" (5.2mm)	Black	2	<b>SEC50B252</b>
¾	.205" (5.2mm)	Black	3	<b>SEC75B352</b>
¾	.205" (5.2mm)	Black	4	<b>SEC75B452</b>
½	.220" (5.6mm)	Black	3	<b>SEC50B356</b>
1	.215" (5.5mm)	Black	9*	<b>SEC100BSMH9</b>
1¼	.215" (5.5mm)	Black	13*	<b>SEC125BSMH13</b>

Note: \*Skinned bushings, field configurable.



### Cord Connector Parts

NPT Hub Size	Cord Diameter Inches (mm)	Form Size	Bushing Catalog Number	Color Code	GOTCHA® Ring Catalog Number
¼, ⅜, ½	.062"-.125" (1.58-3.17)	F1	<b>31518101BPK100</b>	Green	<b>31648035GPK100</b>
	.125"-.187" (3.17-4.76)		<b>31518102BPK100</b>	Orange	<b>31648036GPK100</b>
	.187"-.250" (4.76-6.35)		<b>31518103BPK100</b>	Red	<b>31648037GPK100</b>
	.250"-.312" (6.35-7.93)		<b>31518104BPK100</b>	Black	<b>31648038GPK100</b>
	.312"-.375" (7.93-9.50)		<b>31518105BPK100</b>	White	<b>31605010GPK100</b>
	.375"-.437" (9.50-11.1)		<b>31518106BPK100</b>	Blue	<b>31648039GPK100</b>
½, ¾	.187"-.250" (4.76-6.35)	F2	<b>31518110BPK100</b>	Red	<b>31648042GPK100</b>
	.250"-.375" (6.35-9.50)		<b>31518111BPK100</b>	White	<b>31605015GPK100</b>
	.375"-.500" (9.50-12.7)		<b>31518112BPK100</b>	Blue	<b>31648043GPK100</b>
	.500"-.625" (12.7-15.8)		<b>31518113BPK100</b>	Brown	<b>31648044GPK100</b>
½, ¾	.375"-.500" (9.50-12.7)	F3	<b>31518116BPK100</b>	Blue	<b>31648045GPK100</b>
	.500"-.625" (12.7-15.8)		<b>31518117BPK100</b>	Brown	<b>31648046GPK100</b>
	.625"-.750" (15.8-19.0)		<b>31518118BPK100</b>	Yellow	<b>31648047GPK100</b>
	.750"-.875" (19.0-22.2)		<b>31518119BPK100</b>	Orchid	<b>31648048GPK100</b>
1	.500"-.625" (12.7-15.8)	F4	<b>31518123BPK100</b>	Brown	<b>31648050GPK100</b>
	.625"-.750" (15.8-19.0)		<b>31518124BPK100</b>	Yellow	<b>31648051GPK100</b>
	.750"-.875" (19.0-22.2)		<b>31518125BPK100</b>	Orchid	<b>31648052GPK100</b>
	.875"-.1.00" (22.2-25.4)		<b>31518126BPK100</b>	Gray	<b>31648053GPK100</b>
	1.00"-.1.125" (25.4-28.5)		<b>31518127BPK100</b>	Pink	<b>31648054GPK100</b>

Note: Catalog numbers above with "PK100" suffix, i.e. 31518101BPK100, are bulk packed 100 per carton

### Locknuts and Metal Clad Sealing O-Rings



NPT Hub Size	Zinc-Plated Steel Locknuts	Non-Metallic Locknuts	Metal Clad Sealing O-Rings*
¼	—	<b>31622001LPK50</b>	—
⅜	—	<b>31622002LPK50</b>	—
½	<b>00322001LPK50</b>	<b>31622003LPK50</b>	<b>20509001</b>
¾	<b>00322002LPK50</b>	<b>31622007LPK50</b>	<b>20509002</b>
1	<b>00322003LPK50</b>	<b>31622008LPK50</b>	<b>20509003</b>
1¼	<b>00322004LPK50</b>	—	<b>20509004</b>
1½	<b>00322005LPK50</b>	—	<b>20509005</b>
2	—	—	<b>20509006</b>
2½	—	—	<b>20509007</b>
3	—	—	<b>20509008</b>

Note: Catalog numbers above with "PK50" suffix, i.e. 00322001LPK50, are bulk packed 50 per carton.

See page V-96 for technical information and dimensional drawings.

\*UL listed and CSA certified.

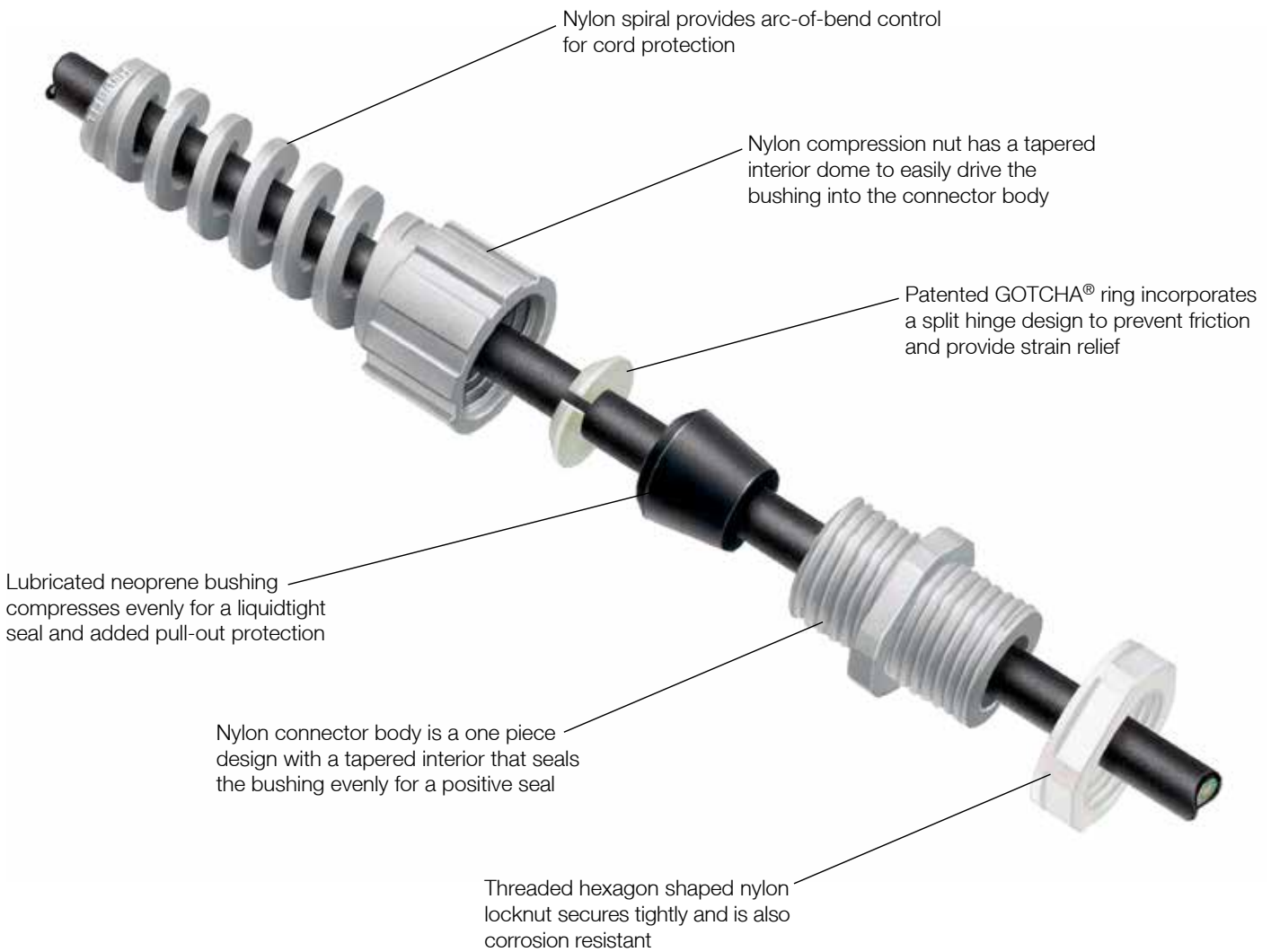

Hubbell Juniors are a miniature liquidtight version of the full-sized Hubbell cord connectors. They feature the same GOTCHA® ring technology and neoprene bushings.

They also come with or without a nylon spiral for arc-of-bend control and longer cord life. They are available in ¼", ⅜", and ½" NPT sizes in both gray and black.



Gray Cord Connector



Black Cord Connector



Gray Cord Connector with Spiral



Black Cord Connector with Spiral



Gray Snap-In Cord Connector



Black Snap-In Cord Connector

### Miniature Nylon Cord Connector

NPT Hub Size	Cord Diameter Range		Gray	Black
	Inches	(mm)		
¼	.08"-.14"	(1.9-3.4)	<b>HJ1001GPK25</b>	<b>HJ1001BPK25</b>
	.14"-.20"	(3.4-5.1)	<b>HJ1002GPK25</b>	<b>HJ1002BPK25</b>
	.20"-.27"	(5.1-6.7)	<b>HJ1003GPK25</b>	<b>HJ1003BPK25</b>
⅜	.15"-.21"	(3.7-5.3)	<b>HJ1004GPK25</b>	<b>HJ1004BPK25</b>
	.21"-.28"	(5.3-7.0)	<b>HJ1005GPK25</b>	<b>HJ1005BPK25</b>
	.28"-.34"	(7.0-8.6)	<b>HJ1006GPK25</b>	<b>HJ1006BPK25</b>
½	.06"-.13"	(1.6-3.2)	<b>HJ1055GPK25</b>	<b>HJ1055BPK25</b>
	.13"-.19"	(3.2-4.7)	<b>HJ1056GPK25</b>	<b>HJ1056BPK25</b>
	.19"-.25"	(4.7-6.3)	<b>HJ1057GPK25</b>	<b>HJ1057BPK25</b>
	.25"-.31"	(6.3-7.9)	<b>HJ1058GPK25</b>	<b>HJ1058BPK25</b>
	.31"-.38"	(7.9-9.5)	<b>HJ1059GPK25</b>	<b>HJ1059BPK25</b>
	.38"-.44"	(9.5-11.1)	<b>HJ1060GPK25</b>	<b>HJ1060BPK25</b>

### Miniature Nylon Cord Connector with Spiral

NPT Hub Size	Cord Diameter Range		Gray	Black
	Inches	(mm)		
¼	.08"-.14"	(1.9-3.4)	<b>HJ1010GPK25</b>	<b>HJ1010BPK25</b>
	.14"-.20"	(3.4-5.1)	<b>HJ1011GPK25</b>	<b>HJ1011BPK25</b>
	.20"-.27"	(5.1-6.7)	<b>HJ1012GPK25</b>	<b>HJ1012BPK25</b>
⅜	.15"-.21"	(3.7-5.3)	<b>HJ1013GPK25</b>	<b>HJ1013BPK25</b>
	.21"-.28"	(5.3-7.0)	<b>HJ1014GPK25</b>	<b>HJ1014BPK25</b>
	.28"-.34"	(7.0-8.6)	<b>HJ1015GPK25</b>	<b>HJ1015BPK25</b>
½	.13"-.19"	(3.2-4.7)	<b>HJ1038GPK25</b>	<b>HJ1038BPK25</b>
	.19"-.25"	(4.7-6.3)	<b>HJ1039GPK25</b>	<b>HJ1039BPK25</b>
	.25"-.31"	(6.3-7.9)	<b>HJ1040GPK25</b>	<b>HJ1040BPK25</b>
	.31"-.38"	(7.9-9.5)	<b>HJ1041GPK25</b>	<b>HJ1041BPK25</b>
	.38"-.44"	(9.5-11.1)	<b>HJ1042GPK25</b>	<b>HJ1042BPK25</b>
¾	.25"-.49"	(6.4-12.3)	<b>HJ1043GPK25*</b>	<b>HJ1043BPK25*</b>
	.45"-.71"	(11.4-18.0)	<b>HJ1044GPK25*</b>	<b>HJ1044BPK25*</b>

Note: \*Locknuts sold separately, see page V-84 for additional information.

### Miniature Nylon Snap-In Cord Connector with Spiral

Cord Diameter Range	Inches	(mm)	For Chassis Thickness	Gray	Black
.28"-.32"	(7.1-8.1)	.10" (2.5) Max	<b>HS1002GPK25</b>	<b>HS1002BPK25</b>	
.30"-.36"	(7.6-9.1)	.13" (3.2) Max	<b>HS1003GPK25</b>	<b>HS1003BPK25</b>	
.32"-.43"	(8.1-10.9)	.13" (3.2) Max	<b>HS1004GPK25</b>	<b>HS1004BPK25</b>	

Note: Catalog numbers above with "PK25" suffix, i.e. HJ1001GPK25, are bulk packed 25 per carton. See page V-97 for technical information and dimensional drawings.



## Operating Temperatures

Material	Temperature Range	
Aluminum	-40°F to +300°F	(-40°C to +149°C)
Nylon (connectors and GOTCHA® rings)	-40°F to +225°F	(-40°C to +107°C)
Plated steel*	-60°F to +1000°F	(-51°C to +537°C)
Stainless steel*	-60°F to +1000°F	(-51°C to +537°C)
Neoprene (bushings)	-30°F to +240°F	(-34°C to +115°C)

Note: \*Due to the limiting factors of nylon and neoprene, any complete cord connector with a GOTCHA ring, Form 1-5, will continuously perform in the range of -30°F to +225°F (-34°C to +107°C).  
 Cord connectors without GOTCHA rings, Form 6-8, will continuously operate in the range -30°F to +240°F (-34°C to +115°C) due to the limiting factor of neoprene.

## Hazardous Locations

Hubbell cord connectors are suitable for use in hazardous locations per Class I Div. 2, Class II Div. 1 & 2, Class III Div. 1 & 2 in accordance with the NEC.

## Flammability

Hubbell nylon cord connectors have a UL 94-V2 rating.

## Approvals

### Agency

UL Listed in accordance with Standard 514B for indoor/outdoor use.

CSA Certified.

United States Coast Guard Approved, Title 46-Part 111.

## Form Size Definition

The term "Form Size" refers to the physical overall size of a cord connector.

Form 1 is the smallest size.

Form 8 is the largest size.

## Knockout Holes

NPT Hub Size	Knockout Hole Recommended		PG Hub Size	Knockout Hole Recommended		Metric Hub Size	Knockout Hole Recommended	
	Min.	Max.		Inches	(mm)		Inches	(mm)
¼	.54"	.57"	PG7	.492"	(12.5)	M12	.472"	(12)
⅜	.67"	.70"	PG9	.599"	(15.2)	M16	.629"	(16)
½	.86"	.91"	PG11	.733"	(18.6)	M20	.787"	(20)
¾	1.04"	1.09"	PG13.5	.804"	(20.4)	M25	.984"	(25)
1	1.36"	1.41"	PG16	.888"	(22.5)	M32	1.25"	(32)
1¼	1.72"	1.77"	PG21	1.15"	(28.3)	M40	1.57"	(40)
1½	1.97"	2.02"	PG29	1.47"	(34.3)			
2	2.45"	2.50"	PG36	1.85"	(47.0)			
2½	2.95"	3.00"						
3	3.58"	3.63"						

## NPT, PG and Metric Thread Low Profile Connectors

### Specifications

Material	6/6 Nylon.
Gland	Buna N.
Temperature Range	-22°F to 225°F (-30°C to 107°C). Cord Connectors are Halogen and Silicon free.
Protection Class	IP66 Suitability.
Flammability	UL 94V-2.
Listings/Certifications	UL Listing File E-41567, UL Recognition File E-41567. CSA File LR27378C, VDE Marks Licence #136681.



SECP29G



**Straight Hubbell Connectors**

F NPT Inches	Aluminum Inches (mm)						Nylon Inches (mm)						
	Form	A Dia.	B Ref.	C	D Throat Dia.	E		A Dia.	B Ref.	C	D Throat Dia.	E	
						A/C*	A/F*					A/C*	A/F*
¼-18	1	.88" (22.4)	.90" (22.9)	.46" (11.7)	.32" (8.1)	.99" (25.1)	.88" (22.4)	1.00" (25.4)	1.10" (27.9)	.43" (10.9)	.33" (8.4)	.100" (25.4)	.93" (23.6)
¾-18	1	.88" (22.4)	.90" (22.9)	.46" (11.7)	.44" (11.2)	.99" (25.1)	.88" (22.4)	1.00" (25.4)	1.10" (27.9)	.43" (10.9)	.45" (11.4)	.100" (25.4)	.93" (23.6)
½-14	1	.88" (22.4)	.90" (22.9)	.46" (11.7)	.44" (11.2)	1.00" (25.4)	.88" (22.4)	1.00" (25.4)	1.10" (27.9)	.46" (11.7)	.45" (11.4)	.100" (25.4)	.93" (23.6)
½-14	2	1.13" (28.7)	1.10" (27.9)	.55" (14.0)	.64" (16.3)	1.11" (28.2)	1.00" (25.4)	1.32" (33.5)	1.50" (38.1)	.53" (13.5)	.58" (14.7)	1.25" (31.7)	1.12" (28.4)
½-14	3	1.38" (35.1)	1.50" (38.1)	.55" (14.0)	.64" (16.3)	1.40" (35.6)	1.25" (31.7)	—	—	—	—	—	—
¾-14	2	1.13" (28.7)	1.10" (27.9)	.55" (14.0)	.64" (16.3)	1.29" (32.8)	1.13" (28.7)	—	—	—	—	—	—
¾-14	3	1.38" (35.1)	1.50" (38.1)	.55" (14.0)	.82" (20.8)	1.40" (35.6)	1.25" (31.7)	1.56" (39.6)	1.60" (40.6)	.55" (14.0)	.77" (19.6)	1.44" (36.6)	1.31" (33.3)
1-11½	4	1.75" (44.4)	1.60" (40.6)	.71" (18.0)	1.02" (25.9)	1.81" (46.0)	1.62" (41.1)	1.88" (47.8)	1.75" (44.4)	.70" (17.8)	1.01" (25.7)	1.84" (46.7)	1.63" (41.4)
1-11½	5	2.31" (58.7)	1.70" (43.2)	.66" (16.8)	1.01" (25.7)	2.28" (57.9)	2.00" (50.8)	—	—	—	—	—	—
1¼-11½	5	2.31" (58.7)	1.70" (43.2)	.74" (18.8)	1.26" (32.0)	2.28" (57.9)	2.12" (53.8)	—	—	—	—	—	—
1½-11½	5	2.31" (58.7)	1.70" (43.2)	.74" (18.8)	1.38" (35.1)	2.28" (57.9)	2.12" (53.8)	—	—	—	—	—	—
1½-11½	6	3.00" (76.2)	2.20" (55.9)	.75" (19.0)	1.50" (38.1)	2.97" (75.4)	2.75" (69.8)	—	—	—	—	—	—
2-11½	6	3.00" (76.2)	2.20" (55.9)	.80" (20.3)	1.92" (48.8)	3.24" (82.4)	3.00" (76.2)	—	—	—	—	—	—
2-11½	7	3.85" (97.8)	2.70" (68.6)	.88" (22.4)	1.94" (49.3)	4.05" (102.9)	3.75" (95.2)	—	—	—	—	—	—
2½-8	7	3.85" (97.8)	2.70" (68.6)	1.30" (33.0)	2.32" (58.9)	4.34" (110.2)	4.02" (102.1)	—	—	—	—	—	—
2½-8	8	4.75" (120.6)	2.70" (68.6)	1.25" (31.7)	2.38" (60.5)	4.86" (123.4)	4.50" (114.3)	—	—	—	—	—	—
3-8	7	3.85" (97.8)	2.70" (68.6)	1.30" (33.0)	2.54" (64.5)	4.34" (110.2)	4.02" (102.1)	—	—	—	—	—	—
3-8	8	4.50" (114.3)	2.70" (68.6)	1.38" (35.1)	3.00" (76.2)	4.86" (123.4)	4.50" (114.3)	—	—	—	—	—	—

Note: \*A/C— Across Corners; A/F—Across Flats.

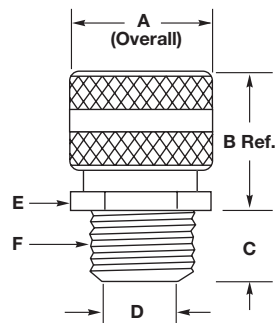

Dimensions shown are approximate and are subject to change without notice.





### Straight Hubbell Connectors

F NPT Inches	Form	Zinc-Plated Steel Inches (mm)						Stainless Steel Inches (mm)							
		A		B	C	D Throat Dia.	E		A		B	C	D Throat Dia.	E	
		A/C*	A/F*	Ref.			A/C*	A/F*	A/C*	A/F*	Ref.		A/C*	A/F*	
¼-18	1	—	—	—	—	—	—	—	1.01" (25.7)	.88" (22.4)	.90" (22.9)	.46" (11.7)	.38" (9.7)	.87" (22.1)	.75" (19.0)
¾-18	1	.98" (24.9)	.88" (22.4)	.90" (22.9)	.42" (10.7)	.45" (11.4)	.99" (25.1)	.88" (22.4)	1.01" (25.7)	.88" (22.4)	.90" (22.9)	.46" (11.7)	.45" (11.4)	.87" (22.1)	.75" (19.0)
½-14	1	.98" (24.9)	.88" (22.4)	.90" (22.9)	.55" (14.0)	.45" (11.4)	1.00" (25.4)	.88" (22.4)	—	—	—	—	—	—	—
½-14	2	1.27" (32.3)	1.13" (28.7)	1.20" (30.5)	.55" (14.0)	.64" (16.3)	1.10" (28.2)	1.00" (25.4)	1.30" (33.0)	1.13" (28.7)	1.10" (27.9)	.54" (13.7)	.63" (16.0)	1.16" (29.5)	1.00" (25.4)
½-14	3	1.55" (39.4)	1.38" (35.1)	1.50" (38.1)	.55" (14.0)	.64" (16.3)	1.40" (35.6)	1.25" (31.7)	—	—	—	—	—	—	—
¾-14	2	1.27" (32.3)	1.13" (28.7)	1.20" (30.5)	.55" (14.0)	.64" (16.3)	1.29" (32.8)	1.13" (28.7)	—	—	—	—	—	—	—
¾-14	3	1.55" (39.4)	1.38" (35.1)	1.40" (35.6)	.55" (14.0)	.82" (20.8)	1.40" (35.6)	1.25" (31.7)	1.59" (40.4)	1.38" (35.1)	1.30" (33.0)	.56" (14.2)	.81" (20.6)	1.44" (36.6)	1.25" (31.7)
1-11½	3	1.55" (39.4)	1.38" (35.1)	1.40" (35.6)	.70" (17.8)	.89" (22.6)	1.54" (39.1)	1.38" (35.1)	—	—	—	—	—	—	—
1-11½	4	1.92" (48.8)	1.69" (42.9)	1.60" (40.6)	.70" (17.8)	1.02" (25.9)	1.95" (49.5)	1.69" (42.9)	2.02" (51.3)	1.75" (44.4)	1.40" (35.6)	.70" (17.8)	1.03" (26.2)	1.88" (47.8)	1.63" (41.4)
1-11½	5	2.40" (61.0)	—	1.70" (43.2)	.70" (17.8)	1.02" (25.9)	2.46" (62.5)	2.15" (54.6)	—	—	—	—	—	—	—
1¼-11½	5	2.40" (61.0)	—	1.70" (43.2)	.73" (18.5)	1.27" (32.3)	2.48" (63.0)	2.19" (55.6)	—	—	—	—	—	—	—
1½-11½	5	2.40" (61.0)	—	1.70" (43.2)	.74" (18.8)	1.39" (35.3)	2.48" (63.0)	2.19" (55.6)	—	—	—	—	—	—	—
1½-11½	6	3.06" (77.7)	—	2.20" (55.9)	.75" (19.0)	1.52" (38.6)	3.04" (77.2)	2.83" (71.9)	—	—	—	—	—	—	—
2-11½	6	3.06" (77.7)	—	2.20" (55.9)	.78" (19.8)	1.92" (48.8)	3.32" (84.3)	3.07" (78.0)	—	—	—	—	—	—	—
2-11½	7	3.95" (100.3)	—	2.70" (68.6)	.78" (19.8)	1.99" (50.5)	4.18" (106.2)	3.89" (98.8)	—	—	—	—	—	—	—

Note: \*A/C— Across Corners; A/F—Across Flats.

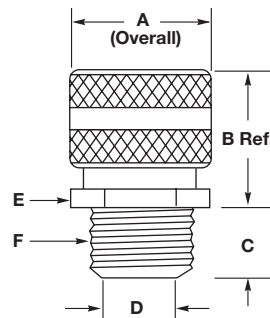

Dimensions shown are approximate and are subject to change without notice.



**45° Hubbell Connectors**

F NPT Inches	Aluminum Inches (mm)								Zinc Plated Steel Inches (mm)							
	Form	A Dia.	B Ref.	C	D Throat Dia.	E		G Dia.	A Dia.	B Ref.	C	D Throat Dia.	E		G	
						Across Corners	Across Flats						Across Corners	Across Flats	Across Corners	Across Flats
1/2-14	2	2.00" (50.8)	1.90" (48.3)	.55" (14.0)	.56" (14.2)	1.27" (32.3)	1.10" (27.9)	1.13" (28.6)	1.97" (50.0)	1.90" (48.3)	.55" (14.0)	.57" (14.4)	1.24" (31.5)	1.06" (26.9)	1.27" (32.3)	1.13" (28.6)
3/4-14	3	2.30" (58.4)	2.50" (65.3)	.56" (14.2)	.75" (19.0)	1.48" (37.6)	1.28" (32.5)	1.38" (34.9)	—	—	—	—	—	—	—	—
1-11½	4	2.60" (66.0)	2.80" (71.1)	.70" (17.8)	1.00" (25.4)	1.69" (42.9)	1.50" (38.1)	1.75" (44.4)	—	—	—	—	—	—	—	—
1½-11½	5	3.90" (99.1)	3.90" (99.1)	.74" (18.8)	1.25" (31.7)	2.45" (62.2)	2.13" (54.0)	2.31" (58.7)	—	—	—	—	—	—	—	—
1½-11½	5	3.90" (99.1)	3.90" (99.1)	.74" (18.8)	1.50" (38.1)	2.45" (62.2)	2.13" (54.0)	2.31" (58.7)	—	—	—	—	—	—	—	—

**90° Hubbell Connectors**

F NPT Inches	Aluminum Inches (mm)								Zinc Plated Steel Inches (mm)							
	Form	A Dia.	B Ref.	C	D Throat Dia.	E		G Dia.	A Dia.	B Ref.	C	D Throat Dia.	E		G	
						Across Corners	Across Flats						Across Corners	Across Flats	Across Corners	Across Flats
3/8-18	1	1.27" (32.3)	2.00" (50.8)	.46" (11.7)	.44" (11.2)	1.15" (29.2)	1.10" (27.9)	.88" (22.2)	—	—	—	—	—	—	—	—
1/2-14	2	1.56" (39.6)	2.30" (58.4)	.50" (12.7)	.55" (13.9)	1.30" (33.0)	1.13" (28.7)	1.13" (28.6)	1.65" (41.9)	2.38" (60.5)	.55" (14.0)	.55" (13.8)	1.29" (32.8)	1.13" (28.7)	1.27" (32.3)	1.13" (28.6)
3/4-14	3	1.79" (45.5)	2.80" (71.1)	.56" (14.2)	.77" (19.4)	1.49" (37.8)	1.31" (33.3)	1.38" (34.9)	1.88" (47.8)	2.90" (73.7)	.56" (14.2)	.77" (19.4)	1.52" (38.6)	1.33" (33.8)	1.55" (39.2)	1.38" (34.9)
1-11½	4	2.08" (52.8)	3.20" (81.3)	.70" (17.8)	1.00" (25.4)	1.70" (43.2)	1.50" (38.1)	1.75" (44.4)	2.16" (54.9)	3.20" (81.3)	.70" (17.8)	1.00" (25.4)	1.72" (43.7)	1.50" (38.1)	1.92" (48.8)	1.69" (42.8)
1¼-11½	5	3.18" (80.8)	4.30" (109.2)	.73" (18.5)	1.26" (32.0)	2.47" (62.7)	2.15" (54.6)	2.31" (58.7)	—	—	—	—	—	—	—	—
1½-11½	5	3.18" (80.8)	4.30" (109.2)	.75" (19.2)	1.50" (38.1)	2.47" (62.7)	2.15" (54.6)	2.31" (58.7)	—	—	—	—	—	—	—	—
2-11½	6	3.51" (89.2)	5.50" (139.7)	.80" (20.3)	1.92" (48.8)	2.98" (75.7)	2.78" (70.6)	3.00" (76.2)	—	—	—	—	—	—	—	—

**90° Hubbell Connectors**

Nylon Inches (mm)								
F NPT Inches	Form	A Dia.	B Ref.	C	D Throat Dia.	E		G Dia.
						Across Corners	Across Flats	
3/8-18	1	—	—	—	—	—	—	—
1/2-14	2	1.41" (35.8)	2.50" (63.5)	.55" (14.0)	.58" (14.6)	1.23" (31.2)	1.12" (28.2)	1.32" (33.4)
3/4-14	3	1.65" (41.9)	2.81" (71.4)	.56" (14.2)	.77" (19.4)	1.42" (36.1)	1.29" (32.8)	1.56" (39.6)
1-11½	4	1.99" (50.5)	3.30" (83.8)	.70" (17.8)	1.01" (25.7)	1.82" (46.2)	1.60" (40.6)	1.88" (47.6)

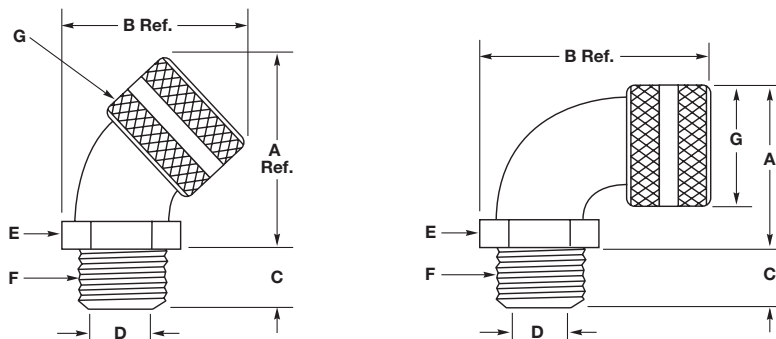

Dimensions shown are approximate and are subject to change without notice.



### Female Hubbell Connectors

Aluminum Inches (mm)							
F NPT Inches	Form	A Dia.	B Ref.	C	D Throat Dia.	E	
						Across Corners	Across Flats
3/8-18	1	.88" (22.4)	1.40" (35.6)	.56" (14.2)	.44" (11.2)	.94" (23.9)	.81" (20.6)
1/2-14	2	1.13" (28.7)	1.80" (45.7)	.56" (14.2)	.63" (16.0)	1.15" (29.2)	1.00" (25.4)
3/4-14	2	1.13" (28.7)	2.10" (53.3)	.75" (19.0)	.63" (16.0)	1.44" (36.6)	1.25" (31.7)
1-11½	4	1.75" (44.5)	2.30" (58.4)	.88" (22.4)	1.10" (27.9)	1.88" (47.8)	1.63" (41.4)
1¼-11½	5	2.31" (58.7)	2.80" (71.1)	.95" (24.1)	1.43" (36.3)	2.64" (67.1)	2.29" (58.2)
1½-11½	5	2.31" (58.7)	2.80" (71.1)	.95" (24.1)	1.43" (36.3)	2.64" (67.1)	2.29" (58.2)

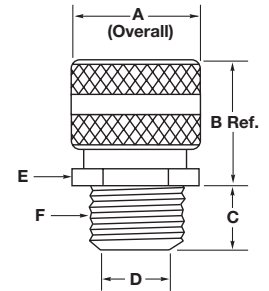
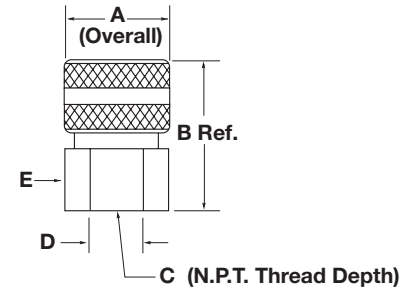

### Underground Feeder Connectors

F NPT Inches	Form	Aluminum Inches (mm)				Zinc-Plated Steel Inches (mm)						Nylon Inches (mm)								
		A Dia.	B Ref.	C	D Throat Dia.	E		A	B	C	D Throat Dia.	E		A	B	C	D Throat Dia.	E		
						A/C*	A/F*					A/C*	A/F*					A/C*	A/F*	A/C*
1/2-14	2	1.13" (28.7)	1.10" (27.9)	.55" (14.0)	.64" (16.3)	1.10" (27.9)	1.00" (25.4)	1.27" (32.3)	1.13" (28.7)	1.20" (30.5)	.55" (14.0)	.64" (16.3)	1.11" (28.2)	1.00" (25.4)	1.32" (33.5)	1.50" (38.1)	.55" (14.0)	.58" (14.7)	1.25" (31.7)	1.13" (28.7)
3/4-14	2	1.13" (28.7)	1.10" (27.9)	.55" (14.0)	.64" (16.3)	1.29" (32.8)	1.13" (28.7)	1.27" (32.3)	1.13" (28.7)	1.20" (30.5)	.55" (14.0)	.64" (16.3)	1.29" (32.8)	1.13" (28.7)	—	—	—	—	—	—
3/4-14	3	1.13" (28.7)	1.50" (38.1)	.55" (14.0)	.82" (20.8)	1.40" (35.6)	1.25" (31.7)	1.55" (39.4)	1.38" (35.1)	1.40" (35.6)	.56" (14.2)	.82" (20.8)	1.40" (35.6)	1.25" (31.7)	1.56" (39.6)	1.60" (40.6)	.56" (14.2)	.77" (19.6)	1.44" (36.6)	1.31" (33.3)

Note: \*A/C - Across Corners; A/F - Across Flats.

### Low Profile Non-Metallic NPT, PG and Metric Thread Connectors

Nylon Inches (mm)						
Hub Size	A	B	C	D	E	F
3/8 NPT	0.670" (17.0)	1.41" (35.8)	0.48" (12.4)	0.21" (5.3)	0.83" (21.0)	0.55" (14.0)
1/2 NPT	0.875" (22.2)	1.70" (43.2)	0.61" (15.5)	0.21" (5.3)	0.88" (24.8)	0.66" (16.8)
3/4 NPT	1.068" (27.1)	2.00" (50.8)	0.62" (15.7)	0.25" (6.3)	1.30" (33.0)	0.85" (21.6)
1 NPT	1.375" (35.0)	2.41" (61.2)	0.76" (19.3)	0.30" (7.6)	1.73" (43.9)	1.05" (26.7)
PG7	0.492" (12.5)	1.16" (29.5)	0.32" (8.1)	0.21" (5.3)	0.63" (16.0)	0.48" (12.4)
PG9	0.599" (15.2)	1.25" (31.8)	0.32" (8.1)	0.21" (5.3)	0.83" (21.0)	0.55" (14.0)
PG11	0.733" (18.6)	1.48" (37.6)	0.38" (9.7)	0.21" (5.3)	0.94" (23.9)	0.70" (17.8)
PG13.5	0.804" (20.4)	1.53" (38.9)	0.41" (10.4)	0.21" (5.3)	0.98" (24.9)	0.66" (16.8)
PG16	0.888" (22.5)	1.68" (42.7)	0.44" (11.2)	0.25" (6.4)	1.06" (27.0)	0.76" (19.3)
PG21	1.15" (28.3)	1.89" (48.0)	0.52" (13.2)	0.25" (6.4)	1.30" (33.0)	.085" (21.6)
PG29	1.47" (37.30)	2.23" (56.6)	0.58" (14.7)	0.30" (7.6)	1.73" (43.9)	1.05" (26.7)
PG36	1.85" (47.0)	2.39" (60.7)	0.47" (11.9)	0.31" (7.9)	2.05" (52.7)	1.19" (30.2)
M12	0.473" (12.0)	1.16" (29.5)	0.32" (8.1)	0.21" (5.3)	0.63" (16.0)	0.49" (12.4)
M16	0.630" (16.0)	1.25" (31.8)	0.32" (8.1)	0.21" (5.3)	0.83" (21.0)	0.55" (14.0)
M20	0.787" (20.0)	1.53" (38.9)	0.41" (10.4)	0.21" (5.3)	0.98" (24.9)	0.66" (16.8)
M25	0.985" (25.0)	1.89" (48.0)	0.52" (13.2)	0.25" (6.3)	1.30" (33.0)	0.85" (21.6)
M32	1.260" (32.0)	2.23" (56.6)	0.58" (14.7)	0.30" (7.6)	1.73" (43.9)	1.05" (26.7)
M40	1.575" (40.0)	2.39" (60.7)	0.48" (12.2)	0.30" (7.6)	2.05" (52.1)	1.19" (30.2)

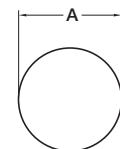
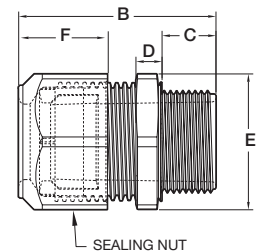

Recommended knockout size

Dimensions shown are approximate and are subject to change without notice.



## 2 Conductors

Cord Type		SVO, SV, SVT	SJ, SJO, SJT, SJTO			S, SO, ST, STO					
Cord Size		#18	#18	#16	#14	#18	#16	#14	#12	#10	#8
Approx. Dia. Inches (mm)		.25" (6.2)	.31" (7.8)	.33" (8.4)	.37" (9.3)	.38" (9.7)	.40" (10.2)	.54" (13.7)	.62" (15.6)	.68" (17.1)	.81" (20.6)
Color		Black	Black	White	White	Blue	Blue	Brown	Brown	Yellow	Orchid
NPT	Form	Catalog Number*									
¼	1	HC1004	HC1004	HC1005	HC1005	HC1006	HC1006	—	—	—	—
¾	1	HC1010	HC1010	HC1011	HC1011	HC1012	HC1012	—	—	—	—
½	1	HC1016	HC1016	HC1017	HC1017	HC1018	HC1018	—	—	—	—
½	2	HC1022	HC1022	HC1022	HC1022	HC1023	HC1023	HC1024	HC1024	—	—
½	3	—	—	—	—	HC1025	HC1025	HC1026	HC1026	HC1027	HC1028
¾	2	HC1032	HC1032	HC1032	HC1032	HC1033	HC1033	HC1034	HC1034	—	—
¾	3	—	—	—	—	HC1035	HC1035	HC1036	HC1036	HC1037	HC1038
1	4	—	—	—	—	HC1039	HC1039	HC1040	HC1040	HC1041	HC1042
1	5	—	—	—	—	—	—	—	—	—	HC1045
1¼	5	—	—	—	—	—	—	—	—	—	HC1050
1½	5	—	—	—	—	—	—	—	—	—	HC1055
1½	6	—	—	—	—	—	—	—	—	—	—
2	6	—	—	—	—	—	—	—	—	—	—
2	7	—	—	—	—	—	—	—	—	—	—
2½	7	—	—	—	—	—	—	—	—	—	—
3	7	—	—	—	—	—	—	—	—	—	—

Note: \*Must add prefix, see Note 1; suffix, see Note 2, on page V-95.  
 †F5 and larger will not be color coded.

## 3 Conductors

Cord Type		SVO, SV, SVT	SJ, SJO, SJT, SJTO			S, SO, ST, STO					
Cord Size		#18	#18	#16	#14	#18	#16	#14	#12	#10	#8
Approx. Dia. Inches (mm)		.26" (6.5)	.33" (8.3)	.35" (8.9)	.39" (9.8)	.39" (9.9)	.42" (10.7)	.57" (14.4)	.65" (16.4)	.71" (18.0)	.85" (21.5)
Color		Black	White	White	Blue	Blue	Blue	Brown	Yellow	Yellow	Orchid
NPT	Form	Catalog Number*									
¼	1	HC1004	HC1005	HC1005	HC1006	HC1006	HC1006	—	—	—	—
¾	1	HC1010	HC1011	HC1011	HC1012	HC1012	HC1012	—	—	—	—
½	1	HC1016	HC1017	HC1017	HC1018	HC1018	HC1018	—	—	—	—
½	2	HC1022	HC1022	HC1022	HC1023	HC1023	HC1023	HC1024	—	—	—
½	3	—	—	—	HC1025	HC1025	HC1025	HC1026	HC1027	HC1027	HC1028
¾	2	HC1032	HC1032	HC1032	HC1033	HC1033	HC1033	HC1034	—	—	—
¾	3	—	—	—	HC1035	HC1035	HC1035	HC1036	HC1037	HC1037	HC1038
1	4	—	—	—	HC1039	HC1039	HC1039	HC1040	HC1041	HC1041	HC1042
1	5	—	—	—	—	—	—	—	—	—	HC1045
1¼	5	—	—	—	—	—	—	—	—	—	HC1050
1½	5	—	—	—	—	—	—	—	—	—	HC1055
1½	6	—	—	—	—	—	—	—	—	—	—
2	6	—	—	—	—	—	—	—	—	—	—
2	7	—	—	—	—	—	—	—	—	—	—
2½	7	—	—	—	—	—	—	—	—	—	—
3	7	—	—	—	—	—	—	—	—	—	—

Note: \*Must add prefix, see Note 1; suffix, see Note 2, on page V-95.  
 †F5 and larger will not be color coded.



### 2 Conductors

Cord Type	SVO, SV, SVT	SJ, SJO, SJT, SJTO	S, SO, ST, STO							
Cord Size	#6	#4	#3	#2	#1	#1/0	#2/0	#3/0	#4/0	#250
Approx. Diameter Inches (mm)	.94" (23.8)	1.08" (27.4)	1.17" (29.7)	1.27" (33.3)	1.44" (36.6)	1.52" (38.6)	1.65" (41.9)	1.77" (45.0)	1.92" (48.8)	2.16" (51.9)
Color	Gray‡	Pink‡	‡	‡	‡	‡	‡	‡	‡	‡
NPT	Form	Catalog Number*								
¼	1	—	—	—	—	—	—	—	—	—
⅜	1	—	—	—	—	—	—	—	—	—
½	1	—	—	—	—	—	—	—	—	—
½	2	—	—	—	—	—	—	—	—	—
½	3	—	—	—	—	—	—	—	—	—
¾	2	—	—	—	—	—	—	—	—	—
¾	3	—	—	—	—	—	—	—	—	—
1	4	<b>HC1043</b>	<b>HC1044</b>	—	—	—	—	—	—	—
1	5	<b>HC1046</b>	<b>HC1047</b>	<b>HC1048</b>	<b>HC1049</b>	—	—	—	—	—
1¼	5	<b>HC1051</b>	<b>HC1052</b>	<b>HC1053</b>	<b>HC1054</b>	—	—	—	—	—
1½	5	<b>HC1056</b>	<b>HC1057</b>	<b>HC1058</b>	<b>HC1059</b>	—	—	—	—	—
1½	6	—	—	—	<b>HC1060</b>	<b>HC1061</b>	<b>HC1062</b>	<b>HC1063</b>	<b>HC1064</b>	—
2	6	—	—	—	<b>HC1065</b>	<b>HC1066</b>	<b>HC1067</b>	<b>HC1068</b>	<b>HC1069</b>	—
2	7	—	—	—	—	—	—	—	<b>HC1070</b>	<b>HC1071</b>
2½	7	—	—	—	—	—	—	—	<b>HC1076</b>	<b>HC1077</b>
3	7	—	—	—	—	—	—	—	<b>HC1086</b>	<b>HC1087</b>

Note: \*Must add prefix, see Note 1; suffix, see Note 2, on page V-95.  
 ‡F5 and larger will not be color coded.

### 3 Conductors

Cord Type	SVO, SV, SVT	SJ, SJO, SJT, SJTO	S, SO, ST, STO							
Cord Size	#6	#4	#3	#2	#1	#1/0	#2/0	#3/0	#4/0	#250
Approx. Diameter Inches (mm)	1.00" (25.4)	1.17" (29.7)	1.24" (31.5)	1.34" (34.0)	1.51" (38.4)	1.65" (41.9)	1.75" (44.5)	1.80" (48.0)	2.07" (52.6)	2.39" (60.7)
Color	Gray‡	‡	‡	‡	‡	‡	‡	‡	‡	‡
NPT	Form	Catalog Number*								
¼	1	—	—	—	—	—	—	—	—	—
⅜	1	—	—	—	—	—	—	—	—	—
½	1	—	—	—	—	—	—	—	—	—
½	2	—	—	—	—	—	—	—	—	—
½	3	—	—	—	—	—	—	—	—	—
¾	2	—	—	—	—	—	—	—	—	—
¾	3	—	—	—	—	—	—	—	—	—
1	4	<b>HC1044</b>	—	—	—	—	—	—	—	—
1	5	<b>HC1047</b>	<b>HC1048</b>	<b>HC1048</b>	<b>HC1049</b>	—	—	—	—	—
1¼	5	<b>HC1052</b>	<b>HC1053</b>	<b>HC1053</b>	<b>HC1054</b>	—	—	—	—	—
1½	5	<b>HC1057</b>	<b>HC1058</b>	<b>HC1058</b>	<b>HC1059</b>	—	—	—	—	—
1½	6	—	—	—	<b>HC1060</b>	<b>HC1062</b>	<b>HC1063</b>	<b>HC1064</b>	—	—
2	6	—	—	—	<b>HC1065</b>	<b>HC1067</b>	<b>HC1068</b>	<b>HC1069</b>	—	—
2	7	—	—	—	—	—	—	<b>HC1070</b>	<b>HC1071</b>	<b>HC1073</b>
2½	7	—	—	—	—	—	—	<b>HC1076</b>	<b>HC1077</b>	<b>HC1079</b>
3	7	—	—	—	—	—	—	<b>HC1086</b>	<b>HC1087</b>	<b>HC1089</b>

Note: \*Must add prefix, see Note 1; suffix, see Note 2, on page V-95.  
 ‡F5 and larger will not be color coded.



### 4 Conductors

Cord Type	SJ, SJO, SJT, SJTO			S, SO, ST, STO						
Cord Size	#18	#16	#14	#18	#16	#14	#12	#10	#8	
Approx. Diameter Inches (mm)	.36" (9.0)	.39" (9.8)	.43" (10.8)	.42" (10.7)	.45" (11.4)	.61" (15.5)	.70" (17.8)	.77" (19.4)	.97" (24.6)	
Color	White	Blue	Blue	Blue	Blue	Brown	Yellow	Orchid	Gray‡	
NPT	Form	Catalog Number*								
¼	1	<b>HC1005</b>	<b>HC1006</b>	<b>HC1006</b>	<b>HC1006</b>	—	—	—	—	—
¾	1	<b>HC1011</b>	<b>HC1012</b>	<b>HC1012</b>	<b>HC1012</b>	—	—	—	—	—
½	1	<b>HC1017</b>	<b>HC1018</b>	<b>HC1018</b>	<b>HC1018</b>	—	—	—	—	—
½	2	<b>HC1022</b>	<b>HC1023</b>	<b>HC1023</b>	<b>HC1023</b>	<b>HC1023</b>	<b>HC1024</b>	—	—	—
½	3	—	<b>HC1025</b>	<b>HC1025</b>	<b>HC1025</b>	<b>HC1025</b>	<b>HC1026</b>	<b>HC1027</b>	<b>HC1028</b>	—
¾	2	—	<b>HC1033</b>	<b>HC1033</b>	<b>HC1033</b>	<b>HC1033</b>	<b>HC1034</b>	—	—	—
¾	3	—	<b>HC1035</b>	<b>HC1035</b>	<b>HC1035</b>	<b>HC1035</b>	<b>HC1036</b>	<b>HC1037</b>	<b>HC1038</b>	—
1	4	—	<b>HC1039</b>	<b>HC1039</b>	<b>HC1039</b>	<b>HC1039</b>	<b>HC1040</b>	<b>HC1041</b>	<b>HC1042</b>	<b>HC1043</b>
1	5	—	—	—	—	—	—	—	—	<b>HC1046</b>
1¼	5	—	—	—	—	—	—	—	—	<b>HC1051</b>
1½	5	—	—	—	—	—	—	—	—	<b>HC1056</b>
1½	6	—	—	—	—	—	—	—	—	—
2	6	—	—	—	—	—	—	—	—	—
2	7	—	—	—	—	—	—	—	—	—
2½	7	—	—	—	—	—	—	—	—	—
3	7	—	—	—	—	—	—	—	—	—

Note: \*Must add prefix, see Note 1; suffix, see Note 2, on page V-95.  
‡F5 and larger will not be color coded.

### 5 Conductors

Cord Type	S, SO, ST, STO							
Cord Size	#18	#16	#14	#12	#10	#8	#6	
Approx. Dia. Inches (mm)	.50" (12.7)	.54" (13.7)	.70" (17.7)	.76" (19.3)	.83" (21.1)	1.06" (26.9)	1.18" (30.0)	
Color	Blue	Brown	Yellow	Orchid‡	Orchid‡	Pink‡	‡	
NPT	Form	Catalog Number*						
½	2	<b>HC1023</b>	<b>HC1024</b>	—	—	—	—	—
½	3	<b>HC1025</b>	<b>HC1026</b>	<b>HC1027</b>	<b>HC1028</b>	<b>HC1028</b>	—	—
¾	2	<b>HC1033</b>	<b>HC1034</b>	—	—	—	—	—
¾	3	<b>HC1035</b>	<b>HC1036</b>	<b>HC1037</b>	<b>HC1038</b>	<b>HC1038</b>	—	—
1	4	<b>HC1039</b>	<b>HC1040</b>	<b>HC1041</b>	<b>HC1042</b>	<b>HC1042</b>	<b>HC1044</b>	—
1	5	—	—	—	<b>HC1045</b>	<b>HC1045</b>	<b>HC1047</b>	<b>HC1048</b>
1¼	5	—	—	—	<b>HC1050</b>	<b>HC1050</b>	<b>HC1052</b>	<b>HC1053</b>
1½	5	—	—	—	<b>HC1055</b>	<b>HC1055</b>	<b>HC1057</b>	<b>HC1058</b>

Note: \*Must add prefix, see Note 1; suffix, see Note 2, on page V-95.  
‡F5 and larger will not be color coded.



## 4 Conductors

Cord Type	SJ, SJO, SJT, SJTO				S, SO, ST, STO					
Cord Size	#6	#4	#3	#2	#1	#1/0	#2/0	#3/0	#4/0	
Approx. Diameter Inches (mm)	.94" (23.8)	1.08" (27.4)	1.17" (29.7)	1.27" (33.3)	1.44" (36.6)	1.52" (38.6)	1.65" (41.9)	1.77" (45.0)	1.92" (48.8)	
Color	Pink‡	‡	‡	‡	‡	‡	‡	‡	‡	
NPT	Form	Catalog Number*								
¼	1	—	—	—	—	—	—	—	—	—
¾	1	—	—	—	—	—	—	—	—	—
½	1	—	—	—	—	—	—	—	—	—
½	2	—	—	—	—	—	—	—	—	—
½	3	—	—	—	—	—	—	—	—	—
¾	2	—	—	—	—	—	—	—	—	—
¾	3	—	—	—	—	—	—	—	—	—
1	4	<b>HC1044</b>	—	—	—	—	—	—	—	—
1	5	<b>HC1047</b>	<b>HC1049</b>	<b>HC1049</b>	—	—	—	—	—	—
1¼	5	<b>HC1052</b>	<b>HC1054</b>	<b>HC1054</b>	—	—	—	—	—	—
1½	5	<b>HC1057</b>	<b>HC1059</b>	<b>HC1059</b>	—	—	—	—	—	—
1½	6	—	<b>HC1060</b>	<b>HC1060</b>	<b>HC1061</b>	<b>HC1063</b>	<b>HC1064</b>	—	—	—
2	6	—	<b>HC1064</b>	<b>HC1065</b>	<b>HC1066</b>	<b>HC1068</b>	<b>HC1069</b>	—	—	—
2	7	—	—	—	—	—	<b>HC1070</b>	<b>HC1071</b>	<b>HC1073</b>	<b>HC1074</b>
2½	7	—	—	—	—	—	<b>HC1076</b>	<b>HC1077</b>	<b>HC1079</b>	<b>HC1080</b>
3	7	—	—	—	—	—	<b>HC1086</b>	<b>HC1087</b>	<b>HC1089</b>	<b>HC1090</b>

Note: \*Must add prefix, see Note 1; suffix, see Note 2, below.  
 ‡F5 and larger will not be color coded.

### Note:

- Add the proper prefix to the HC number to identify the type of connector desired:  
 SHC = Straight Hubbell Connector  
 NHC = 90° Hubbell Connector  
 FHC = Female Hubbell Connector  
 VHC = 45° Hubbell Connector
- Add the proper suffix to identify material desired:  
 Aluminum = No suffix  
 Zinc-Plated Steel = ZP  
 Corrosion Resistant Nylon = CR  
 Stainless Steel = SS

- This chart is a general guide to assist in the selection of Hubbell Cord Connectors for various cord sizes. The Hubbell Cord Connector catalog numbers selected, have been inserted into spaces which in our judgment represent the best cord connector which will fit the listed cord size. The diameters of the cords are approximate and may vary depending on the manufacturer. It is suggested that the appropriate cord manufacturer's dimension chart be consulted for exact dimensions.
- Cable jacket may have to be stripped to allow conductors to pass through connector body.



### NPT Thread Locknuts

#### Zinc-Plated Steel

NPT Hub Size	A Inside Diameter Inches	B Outside Dia. Inches (mm)	C Thickness Inches (mm)	Steel Catalog Number
1/2	1/2"-14	1.14" (29.0)	.09" (2.3)	<b>00322001LPK50</b>
3/4	3/4"-14	1.43" (36.3)	.11" (2.8)	<b>00322002LPK50</b>
1	1"-11 1/2	1.77" (45.0)	.13" (3.3)	<b>00322003LPK50</b>
1 1/4	1 1/4"-11 1/2	2.28" (57.9)	.13" (3.3)	<b>00322004LPK50</b>
1 1/2	1 1/2"-11 1/2	2.60" (66.0)	.13" (3.3)	<b>00322005LPK50</b>

### Metal Clad Sealing O-Rings – Sizes 1/2 - 4

#### Zinc-Plated Steel with Neoprene Ring

NPT Hub Size	A Inside Diameter Inches (mm)	B Outside Dia. Inches (mm)	C Thickness Inches (mm)	Catalog Number
1/2	.80" (20.3)	1.08" (27.4)	.16" (3.2)	<b>20509001</b>
3/4	1.00" (25.4)	1.34" (34.0)	.16" (3.2)	<b>20509002</b>
1	1.25" (31.6)	1.63" (41.4)	.16" (3.2)	<b>20509003</b>
1 1/4	1.61" (40.9)	2.00" (50.8)	.16" (3.2)	<b>20509004</b>
1 1/2	1.84" (46.7)	2.36" (59.9)	.16" (3.2)	<b>20509005</b>
2	2.31" (58.7)	2.83" (71.9)	.16" (3.2)	<b>20509006</b>

#### Chrome Plated Steel with Neoprene Ring

2 1/2	2.91" (73.9)	3.44" (87.4)	.24" (6.1)	<b>20509007</b>
3	3.52" (89.4)	4.08" (103.6)	.24" (6.1)	<b>20509008</b>

### Nylon PG Thread Locknuts

PG Thread Size	A Inches (mm)	B Inches (mm)	C Inches (mm)	Catalog Number
PG7	.75" (19.1)	.80" (20.3)	.22" (5.6)	<b>LNP7BPK100</b>
PG9	.86" (21.8)	.91" (23.2)	.22" (5.6)	<b>LNP9BPK100</b>
PG11	.94" (23.9)	1.03" (26.2)	.22" (5.6)	<b>LNP11BPK100</b>
PG13.5	1.06" (26.9)	1.14" (29.0)	.24" (6.1)	<b>LNP13BPK100</b>
PG16	1.18" (30.0)	1.30" (33.0)	.25" (6.1)	<b>LNP16BPK100</b>
PG21	1.41" (35.8)	1.54" (39.1)	.25" (6.1)	<b>LNP21BPK100</b>
PG29	1.81" (46.0)	2.00" (50.8)	.25" (6.1)	<b>LNP29BPK25</b>
PG36	2.24" (56.9)	2.50" (63.5)	.25" (6.1)	<b>LNP36BPK25</b>

### Nylon Metric Thread Locknuts

PG Thread Size	A Inches (mm)	B Inches (mm)	C Inches (mm)	Catalog Number
M12	.75" (19.1)	.82" (20.8)	.22" (5.6)	<b>LNLM12BPK100</b>
M16	.87" (22.09)	.98" (25.0)	.22" (5.6)	<b>LNLM16BPK100</b>
M20	1.06" (27.0)	1.18" (30.0)	.25" (6.4)	<b>LNLM20BPK100</b>
M25	1.38" (35.1)	1.54" (39.1)	.28" (7.1)	<b>LNLM25BPK100</b>
M32	1.61" (40.9)	1.80" (45.7)	.28" (7.1)	<b>LNLM32BPK100</b>
M40	1.97" (50.0)	2.18" (55.4)	.28" (7.1)	<b>LNLM40BPK100</b>

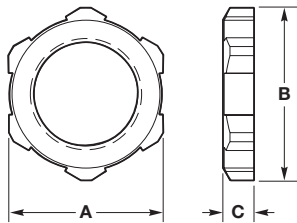
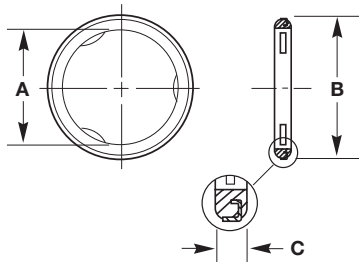
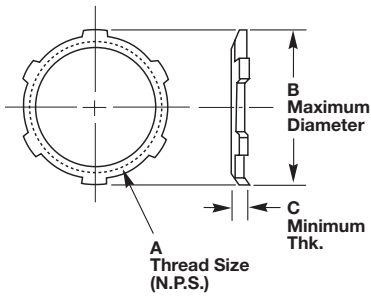

Dimensions shown are approximate and are subject to change without notice.





### Hubbell Juniors®

Material	Operating Temperature Range
Nylon (connectors and GOTCHA® rings)	-40°F to +225°F (-40°C to +107°C)
Neoprene (bushings)	-30°F to +240°F (-34°C to +115°C)

Due to the limiting factors of nylon and neoprene, any complete liquidtight Hubbell Junior will continuously perform in the range of -30°F to +225°F (-34°C to +107°C).

Snap-In continuously performs -40°F to +225°F (-40°C to +107°C).

#### Flammability

Hubbell Juniors have a UL 94V-2 rating.

#### Certifications

Product	Agency
Liquidtight and Liquidtight with Spiral	UL Listed. CSA Certified.
Snap-In	UL Recognized. CSA Certified.

### Knockout Holes

NPT Hub Size	Knockout Hole Recommended Min. to Max.	
	inches	(mm)
¼	.54"-.57"	(13.7-14.5)
⅜	.67"-.70"	(17.0-17.8)
½	.86"-.91"	(21.8-23.1)

### Snap-In

Diameter Range Inches (mm)	For Chassis Thickness (Max.) Inches (mm)	Required Hole Size A Inches (mm)	B Inches (mm)	Dimensional Specifications					G Inches (mm)
				C Inches (mm)	D Inches (mm)	E Inches (mm)	F Inches (mm)		
.22"-.27" (5.6-6.9)	.10" (2.5)	.50" (12.7)	.45" (11.4)	.28" (7.1)	.28" (7.1)	.54" (13.7)	.12" (3.0)	1.84" (44.2)	
.28"-.32" (7.1-8.1)	.10" (2.5)	.50" (12.7)	.47" (11.9)	.28" (7.1)	.33" (8.4)	.59" (15.0)	.12" (3.0)	1.84" (44.2)	
.30"-.36" (7.6-9.1)	.13" (3.3)	.63" (16.0)	.55" (14.0)	.36" (9.1)	.37" (9.4)	.65" (16.5)	.14" (3.6)	2.18" (55.4)	
.32"-.43" (8.1-10.9)	.13" (3.3)	.75" (19.0)	.66" (16.8)	.45" (11.4)	.44" (11.2)	.75" (19.1)	.14" (3.6)	2.60" (66.0)	

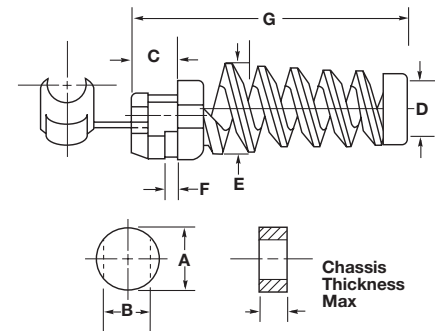

### Liquidtight

F NPT Inches	A Dia. Inches (mm)	B Ref. Inches (mm)	C Inches (mm)	D Throat Dia. Inches (mm)	E	
					Across Corners Inches (mm)	Across Flats Inches (mm)
¼-18	.65" (16.5)	1.30" (33.0)	.40" (10.2)	.29" (7.4)	.65" (16.5)	.60" (15.2)
⅜-18	.81" (20.6)	1.44" (36.6)	.41" (10.4)	.36" (9.1)	.81" (20.6)	.75" (19.1)
½-14	1.00" (25.4)	1.56" (39.6)	.46" (11.7)	.45" (11.4)	.99" (25.1)	.92" (23.4)

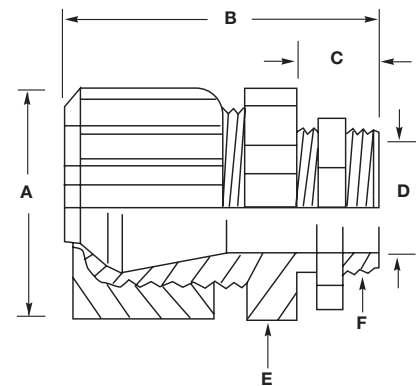

### Liquidtight with Spiral

G NPT Inches	A Dia. Inches (mm)	B Ref. Inches (mm)	C Inches (mm)	D Throat Dia. Inches (mm)	E Inches (mm)	F	
						Across Corners Inches (mm)	Across Flats Inches (mm)
¼-18	.65" (16.5)	2.55" (64.8)	.40" (10.2)	.29" (7.4)	.27" (6.9)	.65" (16.5)	.60" (15.2)
⅜-18	.81" (20.6)	3.10" (78.7)	.41" (10.4)	.36" (9.1)	.35" (8.9)	.81" (20.6)	.75" (19.1)
½-14	1.00" (25.4)	3.72" (94.5)	.46" (11.7)	.45" (11.4)	.45" (11.4)	.99" (25.1)	.92" (23.4)

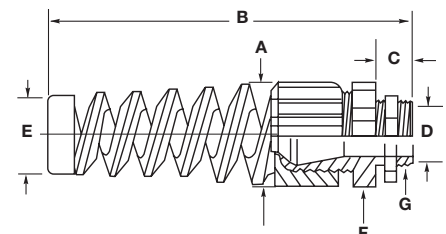

Dimensions shown are approximate and are subject to change without notice.



**PolyTuff® I Conduit, Gray or Black**

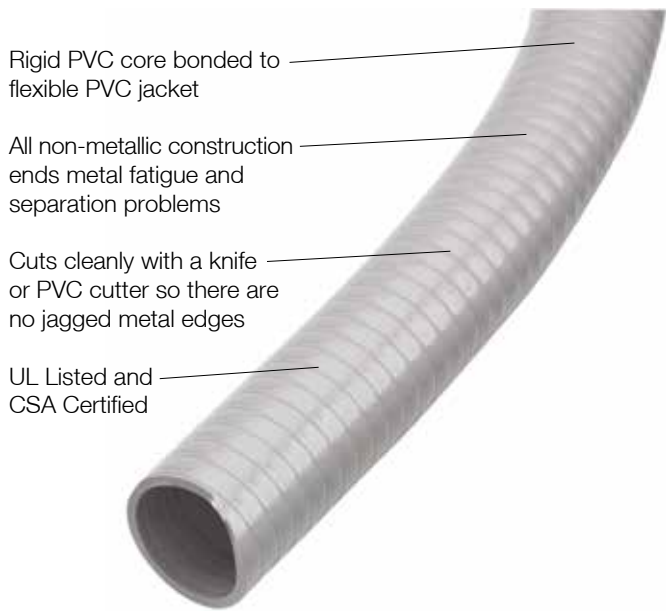

Rigid PVC core bonded to flexible PVC jacket

All non-metallic construction ends metal fatigue and separation problems

Cuts cleanly with a knife or PVC cutter so there are no jagged metal edges

UL Listed and CSA Certified

**PolyTuff® II Tubing, Black**



PVC core with corrugated walls bonded to PVC jacket

Handles twists, turns, bends, switchbacks and straightaways with ease

All non-metallic construction ends fatigue and separation problems

Can be cut with a knife or PVC cutters

UL Recognized and CSA Certified



**G1100**



**G1100M1**

**IP66**  
SUITABILITY



**PolyTuff® I Conduit**

Trade Size (metric designator)	Feet (m)	Gray Catalog Number	Black Catalog Number
3/8 (12)	100 (30.5)	<b>G1038</b>	<b>G1038M1</b>
1/2 (16)	100 (30.5)	<b>G1050</b>	<b>G1050M1</b>
3/4 (21)	100 (30.5)	<b>G1075</b>	<b>G1075M1</b>
1 (27)	100 (30.5)	<b>G1100</b>	<b>G1100M1</b>
1 1/4 (35)	100 (30.5)	<b>G1125</b>	<b>G1125M1</b>
1 1/2 (41)	50 (15.2)	<b>G1150</b>	<b>G1150M1</b>
2 (53)	50 (15.2)	<b>G1200</b>	<b>G1200M1</b>

Note: See pages V-66 and V-67, V-100 and V-101 for approved fittings.  
See pages V-102 and V-103 for technical information and dimensional drawings.



**B2100**

**IP66**  
SUITABILITY



**PolyTuff® II Tubing**

Trade Size (metric designator)	Feet (m)	Catalog Number
1/4 (10)	100 (30.5)	<b>B2025</b>
3/8 (12)	100 (30.5)	<b>B2038</b>
1/2 (16)	100 (30.5)	<b>B2050</b>
3/4 (21)	100 (30.5)	<b>B2075</b>
1 (27)	100 (30.5)	<b>B2100</b>
1 1/4 (35)	100 (30.5)	<b>B2125</b>
1 1/2 (41)	50 (15.2)	<b>B2150</b>
2 (53)	50 (15.2)	<b>B2200</b>

Note: See page V-100 for approved fittings.  
See pages V-102 and V-103 for technical information and dimensional drawings.

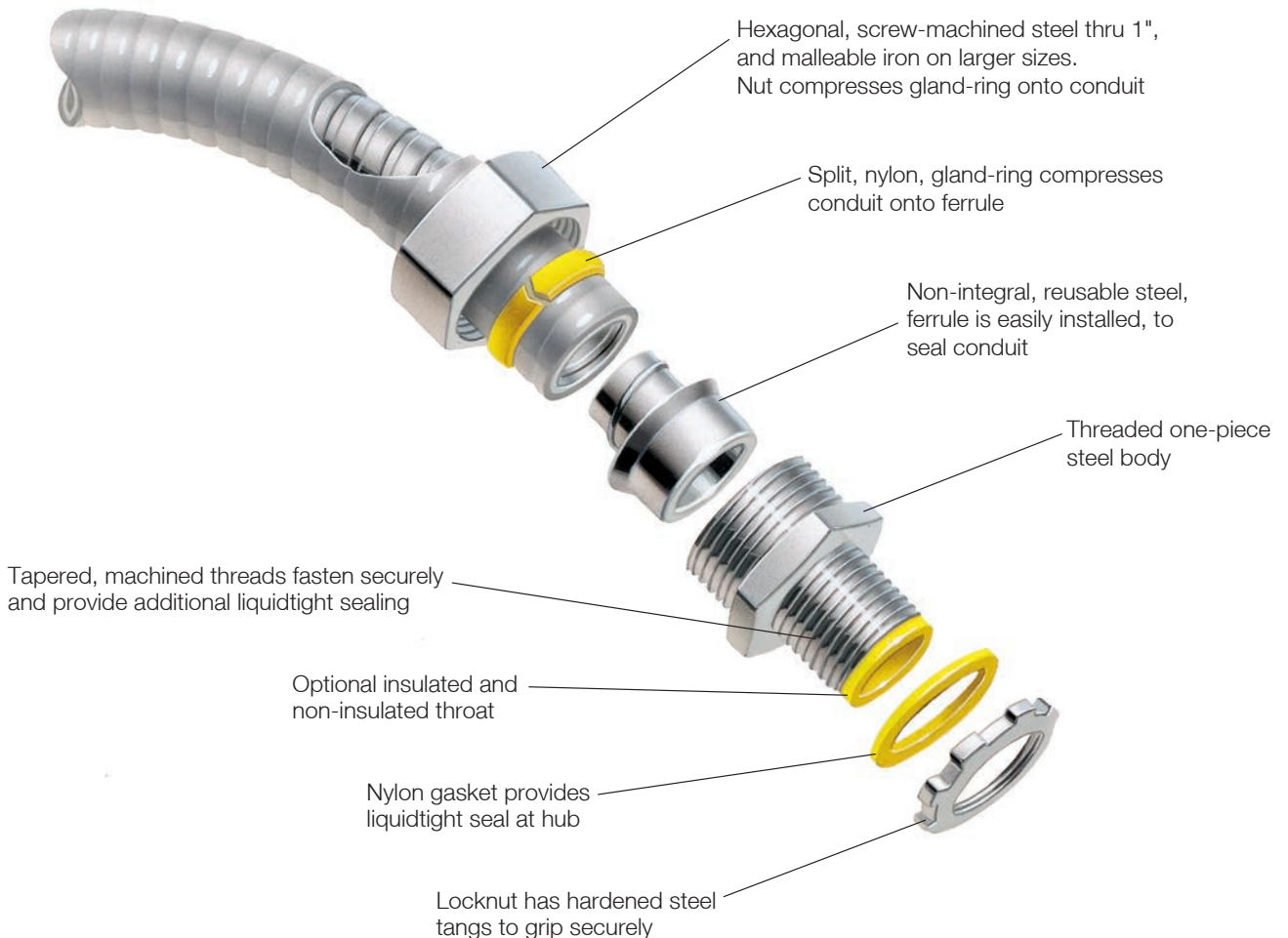
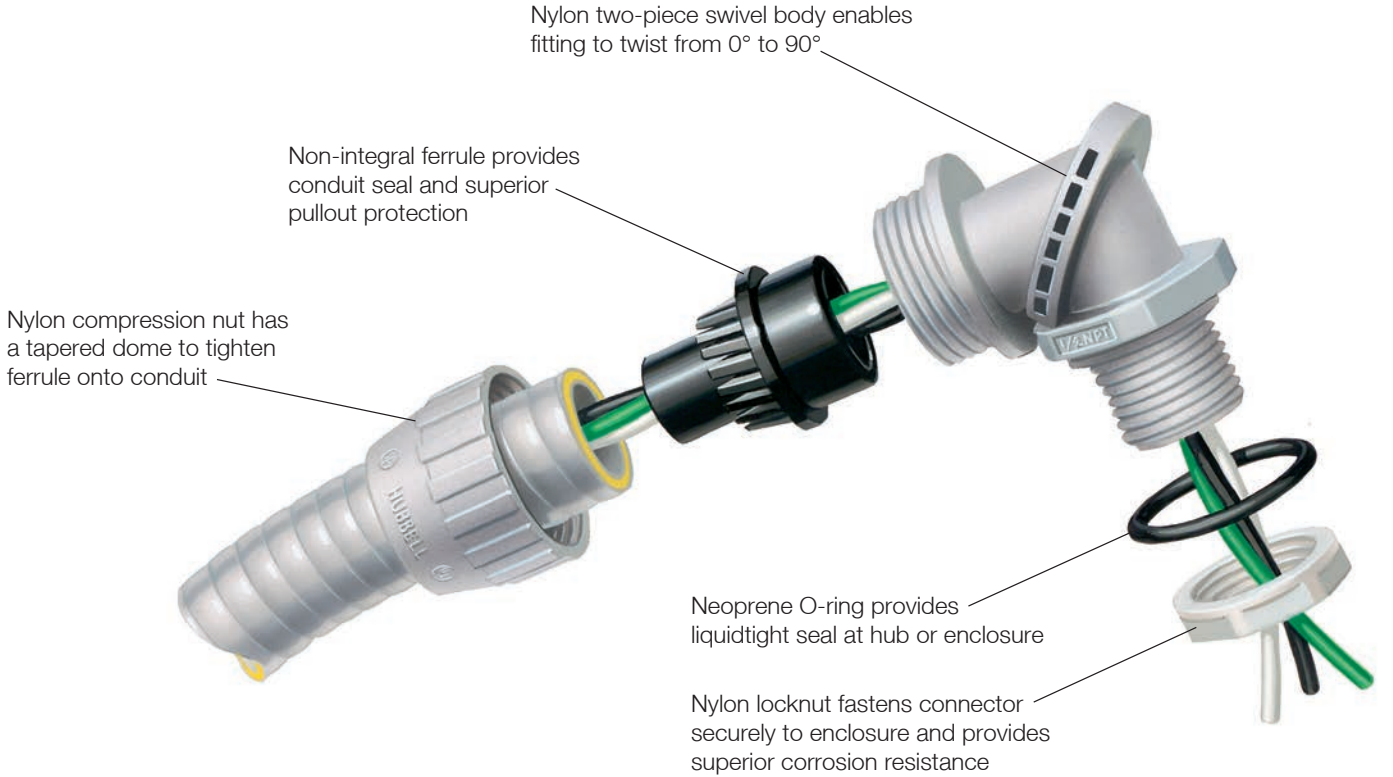



**P075NGYA**



**P125NGY**



**PS0509NGY**  
 SwivelLok® Multi-Position



**P0759NGY**



**PS05GYKIT**

### Straight with Male Non-Metallic Liquidtight Fittings

Trade Size (metric designator)	Black Catalog Number	Gray Catalog Number
¼ (10)	<b>F2025</b>	—
⅜ (12)	<b>P038NBKA</b>	<b>P038NGYA</b>
½ (16)	<b>P050NBKA</b>	<b>P050NGYA</b>
¾ (21)	<b>P075NBKA</b>	<b>P075NGYA</b>
1 (27)	<b>P100NBKA</b>	<b>P100NGYA</b>
1¼ (35)	<b>P125NBK</b>	<b>P125NGY</b>
1½ (41)	<b>P150NBK</b>	<b>P150NGY</b>
2 (53)	<b>P200NBK</b>	<b>P200NGY</b>

Note: Fittings are to be used with PolyTuff I and PolyTuff II.  
 See pages V-104 and V-105 for technical information and dimensional drawings.  
 ¾" Liquidtight conduit fitting have ½ NPT male threads.

### SwivelLok® Multi-Position with Male Non-Metallic Liquidtight Fittings

Trade Size (metric designator)	Black Catalog Number	Gray Catalog Number
⅜ (12)	<b>PS0389NBK</b>	<b>PS0389NGY</b>
½ (16)	<b>PS0509NBK</b>	<b>PS0509NGY</b>
¾ (21)	<b>PS0759NBK</b>	<b>PS0759NGY</b>
1 (27)	<b>PS1009NBK</b>	<b>PS1009NGY</b>

Note: Fittings are to be used with PolyTuff I and PolyTuff II.  
 See pages V-104 and V-105 for technical information and dimensional drawings.  
 ¾" Liquidtight conduit fitting have ½ NPT male threads.

### Fixed 90° Fittings for Non-Metallic Conduit

Trade Size (metric designator)	Black Catalog Number	Gray Catalog Number
⅜ (12)	<b>P0389NBK</b>	<b>P0389NGY</b>
½ (16)	<b>P0509NBK</b>	<b>P0509NGY</b>
¾ (21)	<b>P0759NBK</b>	<b>P0759NGY</b>
1 (27)	<b>P1009NBK</b>	<b>P1009NGY</b>
1¼ (35)	<b>P1259NBK</b>	<b>P1259NGY</b>

Note: Fittings are to be used with PolyTuff I and PolyTuff II.  
 See pages V-104 and V-105 for technical information and dimensional drawings.  
 ¾" Liquidtight conduit fitting have ½ NPT male threads.

### SwivelLok® Flexible Conduit Kit

Trade Size (metric designator)	Fitting and Conduit	Catalog Number
½ (16)	2 PS0509NGY, 6' G1050	<b>PS05GYKIT</b>
¾ (21)	2 PS0759NGY, 6' G1075	<b>PS07GYKIT</b>

Note: See pages V-104 and V-105 for technical information and dimensional drawings.



### Straight Conduit Fitting

Trade Size (metric designator)	Insulated	Non-Insulated
3/8 (12)	<b>H0381</b>	<b>H038</b>
1/2 (16)	<b>H0501</b>	<b>H050</b>
3/4 (21)	<b>H0751</b>	<b>H075</b>
1 (27)	<b>H1001</b>	<b>H100</b>
1 1/4 (35)	<b>H1251</b>	<b>H125</b>
1 1/2 (41)	<b>H1501</b>	<b>H150</b>
2 (53)	<b>H2001</b>	<b>H200</b>
2 1/2 (63)	<b>H2501</b>	<b>H250</b>
3 (78)	<b>H3001</b>	<b>H300</b>
3 1/2 (91)	<b>H3501</b>	<b>H350</b>
4 (103)	<b>H4001</b>	<b>H400</b>

Note: 3/8" Liquidtight conduit fitting have 1/2 NPT male threads.  
 For use with Liquidtight Metal conduit and PolyTuff I Non-Metallic conduit.  
 See page V-106 for technical information.



**H050**  
 Straight with Male  
 Hubbell Conduit Fitting

### 45° Conduit Fitting

Trade Size (metric designator)	Insulated	Non-Insulated
3/8 (12)	<b>H03841</b>	<b>H0384</b>
1/2 (16)	<b>H05041</b>	<b>H0504</b>
3/4 (21)	<b>H07541</b>	<b>H0754</b>
1 (27)	<b>H10041</b>	<b>H1004</b>
1 1/4 (35)	<b>H12541</b>	<b>H1254</b>
1 1/2 (41)	<b>H15041</b>	<b>H1504</b>
2 (53)	<b>H20041</b>	<b>H2004</b>

Note: 3/8" Liquidtight conduit fitting have 1/2 NPT male threads.  
 For use with Liquidtight Metal conduit and PolyTuff I Non-Metallic conduit.  
 See page V-106 for technical information.



**H0504**  
 45° Angle with Male  
 Hubbell Conduit Fitting

### 90° Conduit Fitting

Trade Size (metric designator)	Insulated	Non-Insulated
3/8 (12)	<b>H03891</b>	<b>H0389</b>
1/2 (16)	<b>H05091</b>	<b>H0509</b>
3/4 (21)	<b>H07591</b>	<b>H0759</b>
1 (27)	<b>H10091</b>	<b>H1009</b>
1 1/4 (35)	<b>H12591</b>	<b>H1259</b>
1 1/2 (41)	<b>H15091</b>	<b>H1509</b>
2 (53)	<b>H20091</b>	<b>H2009</b>
2 1/2 (63)	<b>H25091</b>	<b>H2509</b>
3 (78)	<b>H30091</b>	<b>H3009</b>
4 (103)	<b>H40091</b>	<b>H4009</b>

Note: 3/8" Liquidtight conduit fitting have 1/2 NPT male threads.  
 For use with Liquidtight Metal conduit and PolyTuff I Non-Metallic conduit.  
 See page V-106 for technical information.



**H0509**  
 90° Angle with Male  
 Hubbell Conduit Fitting

**PolyTuff® I Conduit**

## Operating Temperature Range

Wet environment	0°F to +140°F (-18°C to +60°C).
Oil environment	0°F to +158°F (-18°C to +70°C).
Dry environment	0°F to +176°F (-18°C to +80°C).

## Certifications

UL Listed	UL Standard 1660. Sunlight resistant approved for outdoor use, direct burial.
CSA Certified	Meets requirements of NEC.

## Voltage Rating

Maximum	600V.
---------	-------

## Material

Conduit	Co-extruded rigid and flexible PVC.
---------	-------------------------------------

**PolyTuff® II Tubing**

## Operating Temperature Range

Operating environment	0°F to +140°F (-18°C to +60°C).
-----------------------	---------------------------------

## Certifications

UL Recognized
CSA Certified

## Voltage Rating

Maximum	Same as wire insulation rating.
---------	---------------------------------

## Material

Tubing	Co-extruded rigid and flexible PVC.
--------	-------------------------------------

**PolyTuff® I Conduit**

Trade Size (metric designator)	Conduit ID/OD		Bend Radius	
	Inches	(mm)	Inches	(mm)
¾ (12)	.49"/.70"	(12.6/17.8)	2.00"	(50.8)
½ (16)	.63"/.83"	(16.1/21.1)	3.00"	(76.2)
¾ (21)	.83"/1.04"	(21.1/26.4)	4.00"	(101.6)
1 (27)	1.05"/1.30"	(26.0/33.1)	5.00"	(127.0)
1¼ (35)	1.40"/1.65"	(35.4/41.8)	6.30"	(158.8)
1½ (41)	1.59"/1.88"	(40.3/47.8)	7.50"	(190.5)
2 (53)	2.03"/2.36"	(51.6/59.9)	10.00"	(254.0)

**PolyTuff® II Tubing**

Trade Size (metric designator)	Conduit ID/OD		Bend Radius	
	Inches	(mm)	Inches	(mm)
¼ (10)	.36"/.57"	(9.3/14.5)	1.50"	(38.1)
¾ (12)	.49"/.70"	(12.6/17.8)	2.00"	(50.8)
½ (16)	.63"/.83"	(16.1/21.1)	2.00"	(50.8)
¾ (21)	.83"/1.04"	(21.1/26.4)	3.00"	(76.2)
1 (27)	1.05"/1.30"	(26.0/33.1)	3.00"	(76.2)
1¼ (35)	1.40"/1.65"	(35.4/41.8)	5.00"	(127.0)
1½ (41)	1.59"/1.88"	(40.3/47.8)	5.00"	(127.0)
2 (53)	2.03"/2.36"	(51.6/59.9)	5.00"	(127.0)



**PolyTuff® I and II Conduit/Tubing; PVC Chemical Resistance**

Chemical	Conc.*	Temp.		Chemical	Conc.*	Temp.		Chemical	Conc.*	Temp.	
		70°F 21°C	150°F 66°C			70°F 21°C	150°F 66°C			70°F 21°C	150°F 66°C
Acetate Solvents		D	D	Coconut Oil		C	D	Lubricating Oils		A	A
Acetic Acid		B	C	Corn Oil		A	B	Magnesium Chloride		A	A
Acetic Acid (Glacial)		C	D	Cottonseed Oil		C	D	Magnesium Hydroxide		A	A
Acetone		D	D	Creosote		D	D	Magnesium Sulfate		A	A
Acrylonitrile		A	B	Cresol		C	D	Malathion 50 in Aromatics		D	D
Alcohols (Aliphatic)		C	C	Crysylic Acid		D	D	Malic Acid		A	A
Aluminum Chloride		A	A	Cyclohexane		B	C	Methyl Acetate		D	D
Aluminum Sulfate (Alums)		A	A	DDT Weed Killer		A	C	Methyl Alcohol		C	C
Ammonia (Anhydrous Liquids)		D	D	Dibutyl Phthalate		D	D	Methyl Bromide		D	D
Ammonia (Aqueous)		A	A	Diesel Oils		C	D	Methyl Ethyl Ketone		D	D
Ammoniated Latex		A	C	Diethylene Glycol		B	C	Methylene Chloride		D	D
Ammonium Chloride		A	A	Diethyl Ether		A	C	Mineral Oil			
Ammonium Hydroxide		A	A	Di-isodecyl Phthalate		D	D	Monochlorobenzene		A	A
Amyl Acetate		D	D	Diocyl Phthalate		D	D	Muriatic Acid (see Hydrochloric Acid)			
Aniline Oils		D	D	Dow General Weed Killer (Phenol)		D	D	Naphtha		C	D
Aromatic Hydrocarbons		D	D	Dow General Weed Killer (H2O)		B	C	Naphthalene		D	D
Asphalt		D	D	Ethyl Alcohol		C	C	Nitric Acid	10%	A	B
ASTM Fuel A		C	C	Ethylene Dichloride		D	D	Nitric Acid	35%	A	C
ASTM Fuel B		D	D	Ethylene Glycol		B	C	Nitric Acid	70%	D	D
ASTM #1 Oil		B	C	Ferric Chloride		A	A	Oleic Acid		A	C
ASTM #3 Oil		C	D	Ferric Sulfate		A	A	Oleum		D	D
Barium Chloride		A	A	Ferrous Chloride		A	A	Oxalic Acid		A	A
Barium Sulfide		A	A	Ferrous Sulfate		A	A	Pentachlorophenol in Oil		B	C
Barium Hydroxide		A	A	Formaldehyde		D	D	Pentane		C	D
Benzene (Benzol)		D	D	Fuel Oil		B	C	Perchloroethylene		B	C
Benzine (Petroleum Ether)		C	C	Furfural		C	C	Petroleum Ether		C	C
Black Liquor		A	A	Gallic Acid		A	A	Phenol		A	A
Bordeaux Mixture		A	A	Gasoline (Hi Test)		C	D	Phosphoric Acid	10%	A	A
Boric Acid		A	A	Glycerine		A	A	Pitch	50%	A	B
Butyl Acetate		D	D	Grease		A	C	Potassium Hydroxide		C	D
Butyl Alcohol		B	C	Green Sulfate Liquor		A	A	Sodium Cyanide		A	A
Calcium Hydroxide		A	A	Heptachlor in Petroleum Solvents		A	C	Stoddard Solvent		D	D
Calcium Hypochlorite		A	A	Heptane		C	D	Styrene		D	D
Carbolic Acid (Phenol)		B	C	Hexane		C	D	Sulfur Dioxide (liquid)		D	D
Carbon Dioxide		A	A	Hydrobromic Acid		A	A	Sulfuric Acid	50%	A	B
Carbon Disulfide		D	D	Hydrochloric Acid	10%	A	A	Sulfuric Acid	98%	D	D
Carbon Tetrachloride		D	D	Hydrochloric Acid	40%	C	C	Sulfurous Acid		B	C
Carbonic Acid		A	A	Hydrofluoric Acid	70%	D	D	Tall Oil		D	D
Casein		A	C	Hydrofluorosilicic Acid		A	A	Tannic Acid		A	A
Caustic Soda		A	B	Hydrofluorosilicic Acid	10%	A	A	Toluene		D	D
Chlorine Gas (wet)		D	D	Hydrogen Peroxide		A	B	Trichlorethylene		D	D
Chlorine Gas (dry)		D	D	Iso-Octane		C	C	Triethanol Amine		C	D
Chlorine (water solution)		C	D	Isopropyl Acetate		D	D	Tricresyl Phosphate (Skydrol)		D	D
Chlorobenzene		D	D	Isopropyl Acid		B	C	Turpentine		C	D
Chlorinated Hydrocarbons		D	D	Jet Fuels (JP-3, and 5)		C	D	Vinegar		A	B
Chromic Acid		B	C	Kerosene		C	C	Vinyl Chloride		D	D
Citric Acid		A	A	Ketones		D	D	Water		A	A
Coal Tar		D	D	Linseed Oil		A	A	White Liquor		A	A
								Xylene		D	D
								Zinc Chloride		A	A
								Zinc Sulfate		A	A

Note: \*Conc. = Concentration.  
 (All ratings apply to concentrated or saturated solutions unless otherwise specified.)  
 Chemical resistance ratings are based upon information supplied by the raw material manufacturers.  
 Use as a general guide only – samples should be tested by user under actual conditions.

**Rating Code**

**A-Excellent service**

No harmful effect to reduce service life. Suitable for continuous service.

**B-Good service life.**

Moderate to minor effect. Good for intermittent service. Generally suitable for continuous service.

**C-Fair or limited service.**

Depends on operating conditions. Generally suitable for intermittent service. Not recommended for continuous service.

**D-Unsatisfactory service.**

Not recommended.

**PolyTuff® Fittings****Operating Temperature\***

Nylon (Body, Nut, Gripping Ring and Locknut)	-40°F to +225°F (-40°C to +107°C).
Neoprene (Sealing Ring)	-30°F to +240°F (-34°C to +116°C).

**Flammability**

Fire Gas Toxicity Product Testing	Nylon PolyTuff Fittings have a UL 94V-2 rating.
-----------------------------------	-------------------------------------------------

**Certifications**

UL Listed	UL50 Type 4X, 12 and 13.
CSA Certified	PolyTuff I Fittings, PolyTuff II Fittings.

**Liquidtight Fittings****Operating Temperature\*\***

Steel/Malleable Iron (Nut, Body, Ferrule)	-60°F to +1000°F (-51°C to +538°C).
Nylon (Gland Ring)	-40°F to +225°F (-40°C to +107°C).

**Hazardous Locations - NEC Reference**

Class I, Div. 2 - 501-10(A)(3)B  
 Class II, Div. 1 - 502-10(A)(2)  
 Class II, Div. 2 - 502-10(A)(3)  
 Class III, Div. 1 - 503-10(A)(2)  
 Class III, Div. 2 - 503-10(B)

**Certifications**

UL Listed to UL 514B  
 CSA Certified

Note: \*Due to the limiting factors of nylon and neoprene, PolyTuff Fittings will continuously perform in the range -30°F to +225°F (-34°C to +107°C).

\*\*Due to the limiting factors of nylon, metallic liquidtight flexible conduit fittings will continuously perform in the range of -40°F to +225°F (-40°C to +107°C).





**Straight with Male Non-Metallic Liquidtight Fittings**

Trade Size (md**)	A	B	C	D Throat Dia.	E	
					Across Corners	Across Flats
¼ (10)	.93" (23.6)	1.45" (36.8)	.39" (9.9)	.32" (8.1)	.86" (Dia.) (21.8)	
¾ (12)	1.14" (29.0)	1.63" (41.4)	.57" (14.5)	.42" (10.7)	1.41" (35.8)	1.30" (33.0)
½ (16)	1.30" (33.0)	2.14" (54.4)	.57" (14.5)	.55" (14.0)	1.41" (35.8)	1.30" (33.0)
¾ (21)	1.53" (38.9)	2.22" (56.4)	.58" (14.7)	.74" (18.8)	1.85" (47.0)	1.53" (38.9)
1 (27)	1.80" (45.7)	2.32" (58.9)	.72" (18.3)	.96" (24.4)	1.94" (49.3)	1.80" (45.7)
1¼ (35)	2.20" (55.9)	2.15" (54.6)	.74" (18.8)	1.30" (33.0)	2.38" (60.5)	2.18" (55.4)
1½ (41)	2.49" (63.2)	2.35" (59.7)	.76" (19.3)	1.46" (37.1)	2.63" (66.8)	2.43" (61.7)
2 (53)	3.05" (77.4)	2.51" (63.6)	.79" (20.1)	1.90" (48.3)	3.13" (79.5)	2.93" (74.4)

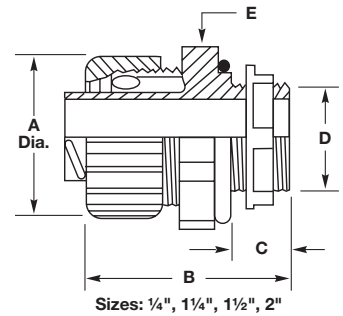

**90° with Male Non-Metallic Liquidtight Fittings**

Trade Size (md**)	A	B	C	D Throat Dia.	E	
					Across Corners	Across Flats
¼ (10)	.93" (23.6)	1.88" (47.8)	.39" (9.9)	.32" (8.1)	.86" (Dia.) (21.8)	
1¼ (35)	2.21" (56.1)	3.57" (90.7)	.74" (18.9)	1.30" (33.0)	2.38" (60.5)	2.18" (55.4)

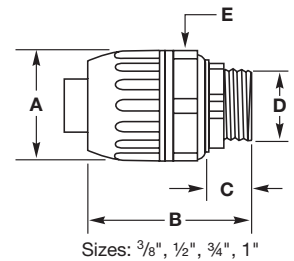

**SwivelLok® Multi-Position Liquidtight Fittings**

Trade Size (md**)	A	B	C	D	E	F	G	
							Across Corners	Across Flats
¾ (12)	1.30" (33.0)	3.27" (83.1)	.57" (14.5)	.55" (14.0)	1.43" (36.3)	2.00" (50.8)	1.41" (35.8)	1.30" (33.0)
½ (16)	1.30" (33.0)	3.27" (83.1)	.57" (14.5)	.55" (14.0)	1.43" (36.3)	2.00" (50.8)	1.41" (35.8)	1.30" (33.0)
¾ (21)	1.53" (38.9)	3.66" (93.0)	.58" (15.7)	.74" (18.8)	1.59" (40.4)	2.23" (56.6)	1.65" (41.9)	1.53" (38.9)
1 (27)	1.80" (45.7)	4.00" (101.6)	.72" (18.3)	.96" (24.4)	1.84" (46.7)	2.30" (58.4)	1.94" (49.3)	1.80" (45.7)

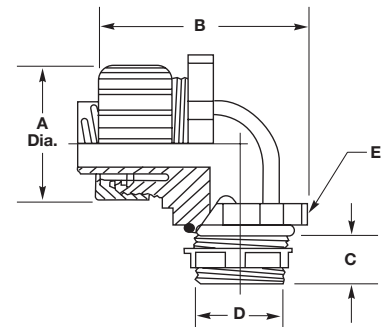

Note: \*A/C = Across Corners, A/F = Across Flats.  
 \*\*md = metric designator.

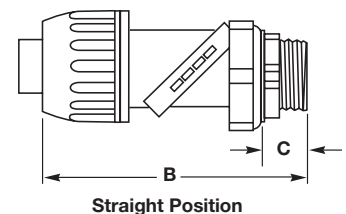
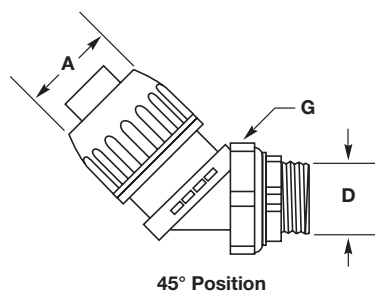
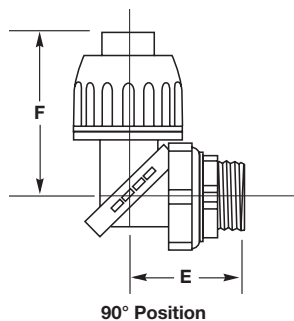

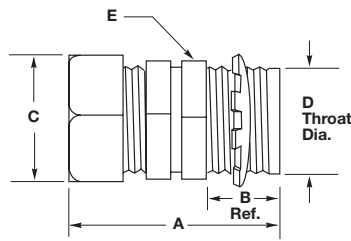

**Straight with Male Metallic Metal Fitting**

Trade Size (md**)	A Ref.	B	C		D Throat Dia.	E	
			A/C*	A/F*		A/C*	A/F*
3/8 (12)	1.43" (36.3)	.59" (15.0)	1.20" (30.0)	1.06" (26.9)	.61" (15.5)	1.07" (27.2)	.93" (23.6)
1/2 (16)	1.43" (36.3)	.59" (15.0)	1.34" (34.0)	1.19" (30.2)	.61" (15.5)	1.22" (31.0)	1.06" (26.9)
3/4 (21)	1.56" (39.6)	.59" (15.0)	1.55" (39.0)	1.37" (34.8)	.84" (21.3)	1.43" (36.3)	1.25" (31.8)
1 (27)	1.68" (42.7)	.66" (16.8)	1.95" (50.0)	1.69" (42.9)	1.06" (26.9)	1.73" (43.9)	1.56" (39.6)
1 1/4 (35)	2.03" (51.6)	.63" (16.8)	2.39" (61.0)	2.06" (52.3)	1.37" (34.8)	2.36" (59.9)	2.08" (52.8)
1 1/2 (41)	2.21" (56.1)	.63" (16.8)	2.72" (69.0)	2.38" (60.5)	1.53" (38.9)	2.79" (70.9)	2.48" (63.0)
2 (53)	2.28" (57.9)	.69" (17.5)	3.08" (78.0)	2.87" (72.9)	2.06" (52.3)	3.32" (84.3)	2.90" (73.7)
2 1/2 (63)	3.56" (90.4)	1.06" (26.9)	3.92" (100.0)	3.62" (91.9)	2.42" (61.5)	3.85" (97.8)	3.60" (91.4)
3 (78)	3.81" (96.8)	1.06" (26.9)	4.70" (119.0)	4.31" (109.5)	3.01" (76.5)	4.65" (118.1)	4.33" (110.0)
3 1/2 (91)	3.81" (96.8)	1.06" (26.9)	5.29" (134.0)	4.81" (122.2)	3.49" (88.6)	5.18" (131.6)	4.82" (122.4)
4 (103)	3.81" (96.8)	1.06" (26.9)	5.75" (146.0)	5.31" (134.9)	3.96" (100.6)	5.75" (146.1)	5.39" (136.9)

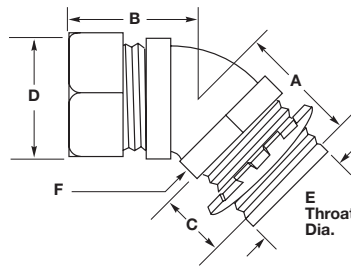

**45° with Male Metallic Metal Fitting**

Trade Size (md**)	A	B	C	D		E Throat Dia.	F	
				A/C*	A/F*		A/C*	A/F*
3/8 (12)	1.19" (30.2)	1.28" (32.5)	.59" (15.0)	1.20" (30.5)	1.06" (26.9)	.60" (15.2)	1.16" (29.5)	1.02" (25.9)
1/2 (16)	1.19" (30.2)	1.28" (32.5)	.59" (15.0)	1.34" (34.0)	1.19" (30.2)	.61" (15.2)	1.21" (30.7)	1.06" (26.9)
3/4 (21)	1.19" (30.2)	1.43" (36.3)	.59" (15.0)	1.55" (39.4)	1.45" (36.8)	.84" (21.3)	1.50" (38.1)	1.32" (33.5)
1 (27)	1.38" (35.1)	1.53" (38.9)	.66" (16.8)	1.95" (49.5)	1.69" (42.9)	1.05" (26.7)	1.82" (46.2)	1.59" (40.4)
1 1/4 (35)	1.42" (36.1)	1.69" (42.9)	.63" (16.0)	2.39" (60.7)	2.06" (52.3)	1.37" (34.8)	2.32" (58.9)	2.03" (51.6)
1 1/2 (41)	1.66" (42.2)	2.00" (50.8)	.66" (16.8)	2.72" (69.1)	2.38" (60.5)	1.60" (40.6)	2.62" (66.5)	2.29" (58.2)
2 (53)	1.69" (42.9)	2.25" (57.2)	.66" (16.8)	3.08" (78.2)	2.88" (73.2)	2.05" (52.1)	3.21" (81.5)	2.80" (71.1)

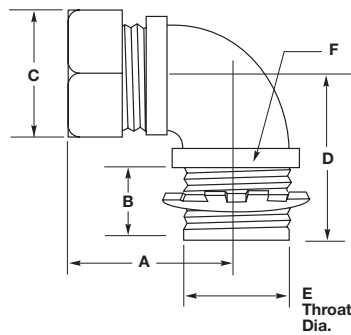

**90° with Male Metallic Metal Fitting**

Trade Size (md**)	A	B	C		D Ref.	E Throat Dia.	F	
			A/C*	A/F*			A/C*	A/F*
3/8 (12)	1.31" (33.3)	.59" (15.0)	1.20" (30.5)	1.06" (26.9)	1.44" (36.6)	.60" (15.2)	1.13" (29.0)	.99" (25.1)
1/2 (16)	1.31" (33.3)	.59" (15.0)	1.34" (34.0)	1.12" (28.4)	1.44" (36.6)	.61" (15.5)	1.12" (28.0)	1.00" (25.4)
3/4 (21)	1.44" (36.6)	.59" (15.0)	1.55" (39.4)	1.45" (36.8)	1.63" (41.4)	.83" (21.1)	1.48" (38.0)	1.29" (32.8)
1 (27)	1.78" (45.2)	.59" (15.0)	1.95" (49.5)	1.60" (40.6)	2.19" (55.6)	1.05" (26.7)	1.80" (46.0)	1.57" (39.9)
1 1/4 (35)	1.97" (50.0)	.63" (16.0)	2.39" (60.7)	2.06" (52.3)	2.50" (63.5)	1.36" (34.5)	2.32" (59.0)	2.02" (51.3)
1 1/2 (41)	2.19" (55.6)	.63" (16.0)	2.72" (69.1)	2.38" (60.5)	2.69" (68.3)	1.61" (40.9)	2.58" (66.0)	2.25" (57.2)
2 (53)	2.53" (64.3)	.66" (16.8)	3.08" (78.2)	2.87" (72.9)	3.25" (82.6)	2.05" (52.1)	3.14" (80.0)	2.75" (69.9)
2 1/2 (63)	3.44" (87.4)	1.00" (25.4)	3.92" (99.6)	3.63" (92.2)	4.25" (108.0)	2.42" (61.5)	3.78" (96.0)	3.50" (88.9)
3 (78)	3.75" (95.3)	1.00" (25.4)	4.70" (119.4)	4.31" (109.5)	4.87" (123.7)	3.01" (76.5)	4.64" (118.0)	4.30" (109.2)
4 (103)	4.25" (108.0)	1.00" (25.4)	5.75" (146.1)	5.31" (134.9)	5.63" (143.0)	3.96" (100.6)	5.76" (146.0)	5.38" (136.7)

Note: \*A/C = Across Corners, A/F = Across Flats.

\*\*md = metric designator.