

Straight Blade Devices
20A, 125V, 2 Pole, 3 Wire Grounding
Elastogrip® Plug

HUBBELL

Features

- Thermoplastic elastomer housing
- Dust and moisture seal around cord

Ordering Information

Description	Cord Diameter	UPC	Catalog Number
Yellow elastomer, dust tight	.300"-.655"(7.6-16.6)	783585013336	HBL1433

Listings

UL Listed to UL498 File E1706
CSA Certified to C22.2 No. 42 File 280
NEMA® WD-6 Compliant

Specifications

Housing	PVC
Blade Holder	Nylon
Terminal Retainer	Clear Polycarbonate
Blades	.060" (1.5) Brass
Terminal Screws	#8-32 Brass , multiple drive
Terminal Clamp	Nickel plated steel
Assembly Screws	Plated steel

Performance

Electrical

Current Interrupting Certified for current interrupting at full rated current
Dielectric Voltage Withstands 2,000V minimum

Mechanical

Product Identification Ratings are a permanent part of the device
Terminal Accommodation #18-#12 AWG. Stranded copper wire only.
Terminal Identification Terminals identified in accordance with UL 498 and CSA

Environmental

Flammability UL 94 V-2
IP Suitability IP20
Operating Temperatures Maximum continuous 75°C; minimum -40°C (w/o impact)

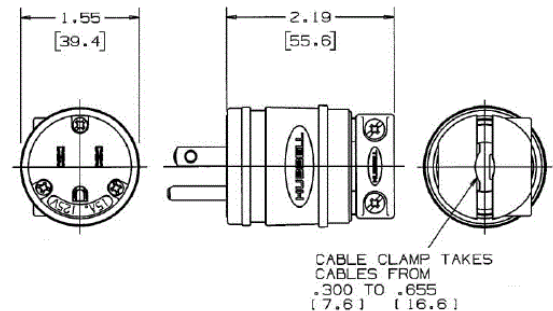

Resources

Customer Use Drawing
eCatalog

Dimensions in Inches (mm)

Hubbell Wiring Device-Kellems • Hubbell Incorporated (Delaware) • 40 Waterview Drive • Shelton, CT 06484

Phone (800) 288-6000 • Fax (800) 255-1031 • Specifications subject to change without notice.

