

**IEC Pin and Sleeve  
20A, 480V, 2 Pole, 3 Wire  
Watertight Plug**

**HUBBELL®**

**Features**

- UL Type 4X, 12 and IP69k environmental ratings
- One piece non-metallic housing provides impact and chemical resistance in an insulated body
- Watertight neoprene gland seal to prevent water ingress from entering at cable entrance
- Solid one-piece pins for reliable electrical contact
- Sequential contact engagement to prevent a momentary over-voltage



**Ordering Information**

Description	UPC Number	Catalog Number
Watertight IEC Pin and Sleeve Mating Plug	783585403410	HBL320P7W

**Listings**

UL Listed, File E146033  
 CSA Certified File LR280C  
 UL Classified to IEC 60309-1 IEC 60309-2

**Specifications**

Housing	PBT
Locking Ring	PBT
Sealing Gasket	Solid Neoprene
Contact Carrier	High-Impact Thermoset
Glands	Santoprene
Terminal Screws	Stainless Steel
Cord Clamps	PBT

**Performance**

Electrical	
Current Interrupting	Certified for current interrupting at full rated current
Dielectric Voltage	Withstands 3,000V AC
Max. Working Voltage	600V AC RMS

Mechanical	
Impact Resistance	Per CSA C22.2, No. 182.1, UL 1682
Product Identification	Identification and ratings are permanently fastened to the device housing
Terminal Identification	Terminals identified in accordance with North American and IEC conventions

Environmental	
Flammability	V-0
Ingress Protection	Type 3R, 3RX, 4X and IP68, IP69K
Moisture Resistance	IEC 60309-1
Operating Temperature	Maximum Continuous 75°C; Minimum - 40°C w/o impact

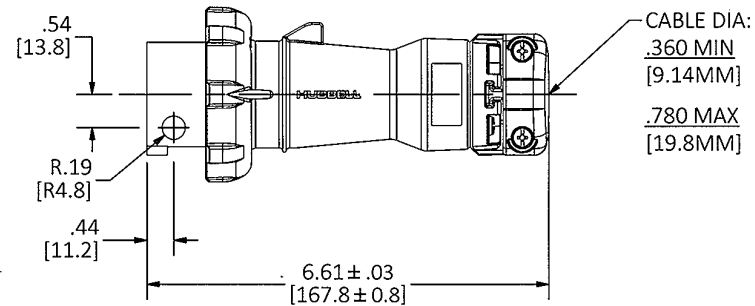

**Complementary Products**

- Closure Cap
- Cord Clamp and Locking Ring
- Liquidtight Adapters

**Online Resources**

- Customer Drawing
- Installation Instructions