

Straight Blade Devices 20A, 125V, 2 Pole, 3 Wire Grounding Valise Plug

HUBBELL

Features

- Hinged one piece body design for easy assembly
- Powerful, offsetting cord grips clamp on individual conductors
- Assembly screws are captive and will not fall out while wiring

Ordering Information

Description	Cord Diameter	UPC	Catalog Number
Yellow nylon	.220"-.660"(5.6-16.8)	783585013169	HBL5364VY



Listings

UL Listed to UL498 File E1706
CSA Certified to C22.2 No 42 File 280C
NEMA® WD-6 Compliant

Specifications

Housing	Nylon
Blades	Brass
Assembly Screws	Plated Steel
Cable Inserts	PPO
Terminal Screws	#8-32 Brass , multiple drive
Terminal Clamp	Nickel plated steel
Assembly Screws	Plated steel

Performance

Electrical	
Current Interrupting	Certified for current interrupting at full rated current
Dielectric Voltage	Withstands 2,000V minimum

Mechanical	
Product Identification	Ratings are a permanent part of the device
Terminal Accommodation	#18-#12 AWG stranded copper wire only
Terminal Identification	Terminals identified in accordance with UL 498 and CSA

Environmental	
Flammability	UL 94 HB or better
IP Suitability	IP20
Operating Temperatures	Maximum continuous 75°C; minimum -40°C (w/o impact)

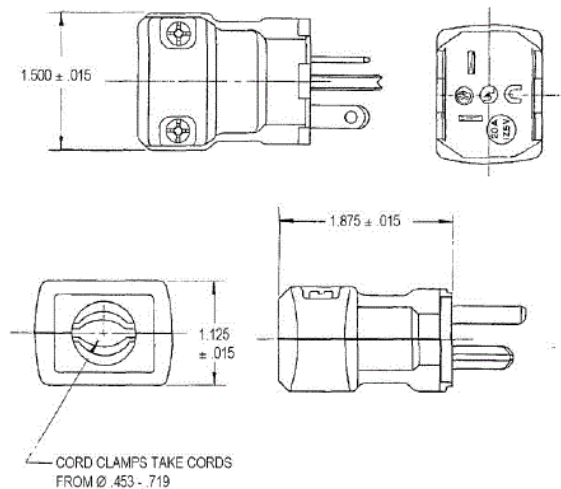

Resources

Customer Use Drawing
eCatalog

Dimensions in Inches (mm)

Hubbell Wiring Device-Kellems • Hubbell Incorporated (Delaware) • 40 Waterview Drive • Shelton, CT 06484

Phone (800) 288-6000 • Fax (800) 255-1031 • Specifications subject to change without notice.

