

Switched Disconnects and Enclosures

85A 600V AC Manual Motor Controllers, Three Pole

HUBBELL

Features

- Thermoset body provides high resistance to electrical arc tracking
- Strong ON/OFF action with quick-make, slow break operation
- Optional Side Finger Guards for close wall applications and finger safe environments
- Four large silver alloy contacts per pole has excellent conductivity with maximum longevity
- Lubrication-free controller with continued ON/OFF cycling even in harsh, dust and high heat environments

Ordering Information

Description	UPC Number	Catalog Number
85A, three pole, single throw, AC manual motor controller, black nylon handle, back wired	783585202938	HBL7883D

Listings

UL 508
CSA-C22.2 No.14

Specifications

Toggle Type	Standard
Housing	Thermoset
Terminal Screw	Brass
Contacts	Silver Alloy

Performance

Electrical	
Dielectric Voltage	2,200V AC minimum for 1 minute
Electrical Life	Min. 6,000 Cycles at rated switch load
Max. Working Voltage	600V AC RMS
Short Circuit Current Ratings (SCCR): (Motor Disconnect)	80A max. when protected by J fuses

Mechanical	
Mechanical Life	10,000 minimum cycles
Terminal Accommodations	#4 AWG Max.
Wire Type	Solid and stranded copper wire only

Environmental	
Flammability	UL94HB/VO
Operating Temperature	Max. Continuous: 75°C; Min. Continuous: -40°C without impact

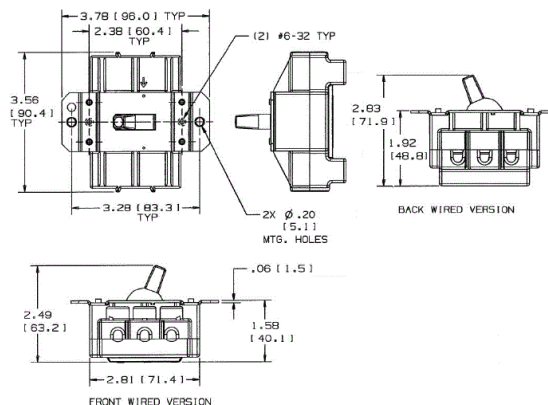

Online Resources

Customer Use Drawing
eCatalog
Installation Instructions

Dimensions in Inches (mm)

Hubbell Wiring Device-Kellems • Hubbell Incorporated (Delaware) • 40 Waterview Drive • Shelton, CT 06484

Phone (800) 288-6000 • Fax (800) 255-1031 • Specifications subject to change without notice.

