

Straight Blade Devices
 15A, 125V, 2 Pole, 3 Wire Grounding
 HBL® Extra Heavy Duty Hospital Grade
 Duplex Receptacles

HUBBELL

Features

- Unique tamper-resistant contact mechanism prevents injury
- Integral wire leads for fast installation and no exposed live parts
- One-piece nickel-plated brass ground strap
- I.D. marking surface helps in quick circuit identification

Ordering Information

Description	Device Color	UPC	Catalog Number
Tamper-resistant receptacle with wire leads	Ivory	783585152233	HBL8200SGIA

Listings

UL Listed to UL498 File No. E2186
 Certified to CSA 22.2, No. 42 File 285
 Fed. Spec. W-C-596
 NEMA® WD-6 Compliant

Specifications

Face	PBT
Base	PBT
Contacts	.037 in. (.9) Nickel plated brass
Lead Wires	6 in. (15.24), #12 AWG 65/30 stranded copper wire
Mounting Strap	.050 in. (1.3) Nickel plated brass
Automatic Self-Grounding Clip	Stainless steel
Mounting Screws	Zinc plated

Performance

Electrical	
Current Interrupting	Certified for current interrupting at full rated current
Dielectric Voltage	Withstands 2,000V minimum
Mechanical	
Ground Terminal Accommodation	#12-#10 AWG stranded or solid copper wire only
Product Identification	Ratings are a permanent part of the device
Terminal Identification	Terminals identified in accordance with UL 498 and CSA
Environmental	
Flammability	UL 94V-0 and UL 94-5 VA
IP Suitability	IP20
Operating Temperatures	Maximum continuous 75°C; minimum -40°C (w/o impact)

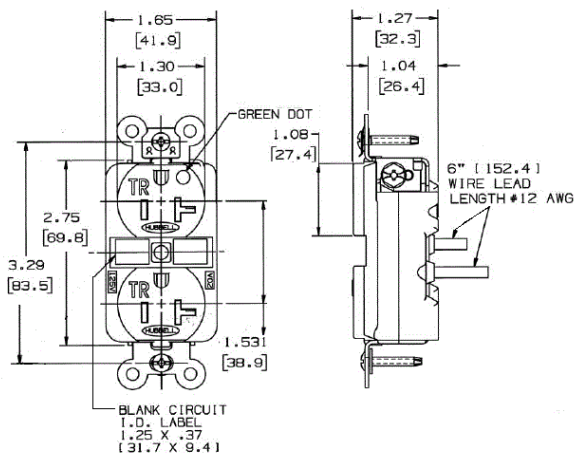

Accessories

Wallplate or Weatherproof Cover Duplex Opening

Resources

Customer Use Drawing
 eCatalog

Dimensions in Inches (mm)

Hubbell Wiring Device-Kellems • Hubbell Incorporated (Delaware) • 40 Waterview Drive • Shelton, CT 06484

Phone (800) 288-6000 • Fax (800) 255-1031 • Specifications subject to change without notice.

