

Straight Blade Devices 50A, 125V, 2 Pole, 3 Wire Grounding Single Receptacle

HUBBELL

Features

- Sequenced contacts assure protection
- Catalog number, ratings and certifications molded in face
- One piece design power and ground contacts

Ordering Information

Description	Device Color	UPC	Catalog Number
Receptacle, black RTP	Black	783585015262	HBL9360

Listings

UL Listed File E2186
CSA Certified
NEMA® WD-6 Compliant

Specifications

Housing	Reinforced Thermoplastic Polyester
Mounting Plate	.062 in. (1.5) Pre-Plated Steel
Brass	Ground Shunt
Brass	Box Terminals

Performance

Electrical	
Current Interrupting	Certified for current interrupting at full rated current
Dielectric Voltage	Withstands 2,000V minimum
Mechanical	
Product Identification	Ratings are a permanent part of the device
Terminal Accommodation	#12 AWG through #4 AWG copper wire only
Terminal Identification	Terminals identified in accordance with UL 498 and CSA
Environmental	
Flammability	UL 94 V-0
IP Suitability	IP20
Operating Temperatures	Maximum continuous 75°C; minimum -40°C (w/o impact)

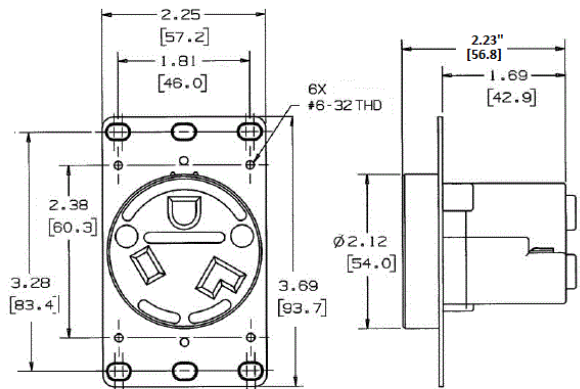

Accessories

Wallplate or Weatherproof Cover 2.16" Opening

Resources

Customer Use Drawing
eCatalog

Dimensions in Inches (mm)

Hubbell Wiring Device-Kellems • Hubbell Incorporated (Delaware) • 40 Waterview Drive • Shelton, CT 06484

Phone (800) 288-6000 • Fax (800) 255-1031 • Specifications subject to change without notice.

