

Clamps

Three Segment Clamps - 13MHMM-3P

Tube OD	Service Pressure Rating @ 70°F ¹	Service Pressure Rating @ 250°F ¹	Dimension A	Stainless Steel	
				Part #	Price/E
1" - 1½"	600	300	2.122"	13MHMM-3P100150	\$27.90
2"	550	275	2.654"	13MHMM-3P200	31.80
2½"	450	225	3.185"	13MHMM-3P250	38.15
3"	350	175	3.717"	13MHMM-3P300	43.15
4"	300	150	4.820"	13MHMM-3P400	54.10
12"	75	50	12.740"	13MHMM-3P1200	647.00

¹ wing nut should be tightened to 25 in. lb. of torque



Bolted Clamps - 13MHP

Tube OD	Service Pressure Rating @ 70°F ¹	Service Pressure Rating @ 250°F ¹	Dimension A	Stainless Steel	
				Part #	Price/E
½" - ¾"	1500	1200	1.062"	13MHP75	\$28.55
1" - 1½"	1500	1200	2.046"	13MHP100-150	31.20
2"	1000	800	2.578"	13MHP200	38.85
2½"	1000	800	3.110"	13MHP250	42.40
3"	1000	800	3.640"	13MHP300	51.60
4"	800	600	4.744"	13MHP400	58.30
6"	300	200	6.632"	13MHP600	94.80
8"	250	150	8.638"	13MHP800	257.40
10"	200	125	10.740"	13MHP1000	394.50
12"	150	100	12.740"	13MHP1200	444.85

¹ nuts should be tightened to 20 ft. lbs. of torque

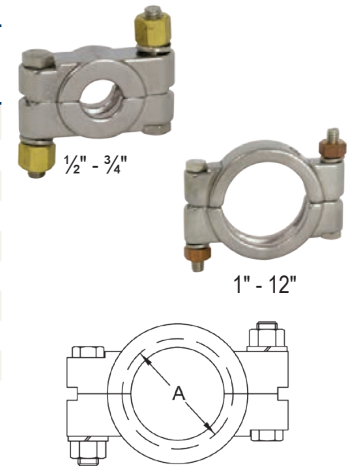

Toggle Clamps - 13MHLA

Tube OD	Service Pressure Rating @ 70°F ¹	Service Pressure Rating @ 250°F ¹	Dimension A	304 Stainless Steel	
				Part #	Price/E
1" - 1½"	150	125	2.122"	13MHLA100-150	\$52.15
2"	150	125	2.654"	13MHLA200	54.60
2½"	150	125	3.185"	13MHLA250	58.70
3"	150	125	3.717"	13MHLA300	93.25
4"	100	75	4.820"	13MHLA400	99.10

¹ screw tightened to maximum



N

T-bolt Clamps - 13MO

Tube OD	Service Pressure Rating @ 70°F ²	Service Pressure Rating @ 250°F ²	Dimension A	304 Stainless Steel	
				Part #	Price/E
1" - 1½"	500	250	2.080"	13MO100-150	\$34.30
2"	350	200	2.610"	13MO200	37.70
2½"	300	150	3.140"	13MO250	46.25
3"	200	100	3.670"	13MO300	47.15
4"	100	75	4.780"	13MO400	66.10
6"	75	50	6.690"	13MO600	91.50
8" ¹	50	40	8.690"	13MO800	136.40
10" ¹	40	30	10.690"	13MO1000	172.40
12" ¹	30	25	12.690"	13MO1200	229.40

¹ 2 bolt configuration

² 1" - 3" nuts tightened to 20 in. lb., 4" nut tightened to 30 in. lb., 6" nut tightened to 40 in. lb. and 8" - 12" nuts tightened to 50 in. lb. of torque

