

IEC Pin and Sleeve

30A, 3 Phase 250V AC, 3 Pole, 4 Wire

Low Profile Receptacle

Features

- Compact Design
- Molded in non-conductive durable nylon
- Color coded by voltage

Ordering Information

Description Low Profile IEC Pin and Sleeve Receptacle	UPC 783585888101	Catalog Number L430R9
---	----------------------------	---------------------------------

Device Color
Blue

Listings

UL Listed, File E146032

Specifications

Housing	Nylon
Contact Carrier	Nylon

Performance

Electrical	
Current Interrupting	Certified for current interruption at full rated current

Dielectric Voltage	Withstands 3,000V AC
Max Working Voltage	250V RMS

Mechanical

Impact Resistance	Per CSA C22.2 No. 182.1 / UL1682
Product Identification	Identification and ratings are a permanent part of the device housing

Terminal Identification	Terminals identified in accordance with North American and IEC conventions
-------------------------	--

Environmental

Flammability	HB or better
Ingress Protection	IP22
Operating Temperatures	Maximum Continuous 75°C; Minimum - 40°C w/o impact

HUBBELL

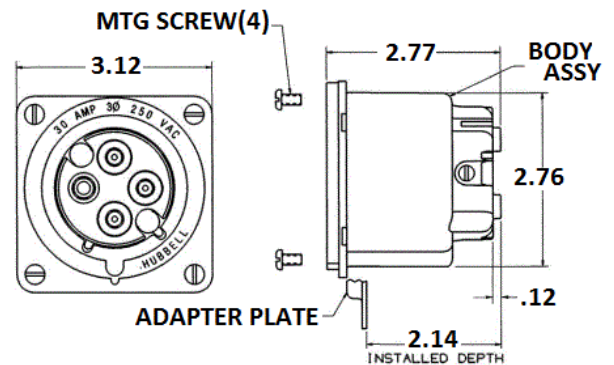

Dimensions in Inches (mm)

Hubbell Wiring Device-Kellems • Hubbell Incorporated (Delaware) • 40 Waterview Drive • Shelton, CT 06484

Phone (800) 288-6000 • Fax (800) 255-1031 • Specifications subject to change without notice.

