

**TOP VIEW**

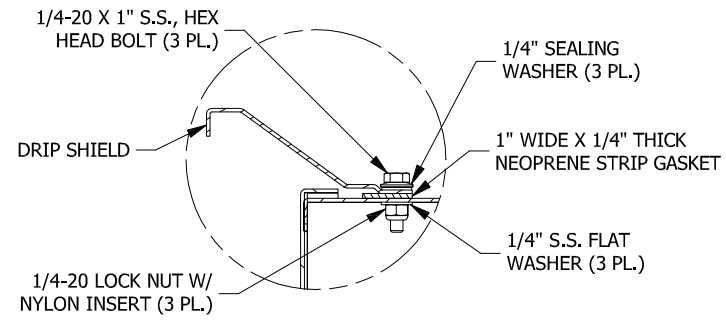

**DETAIL A  
(DRIP SHIELD INSTALL DETAIL)**

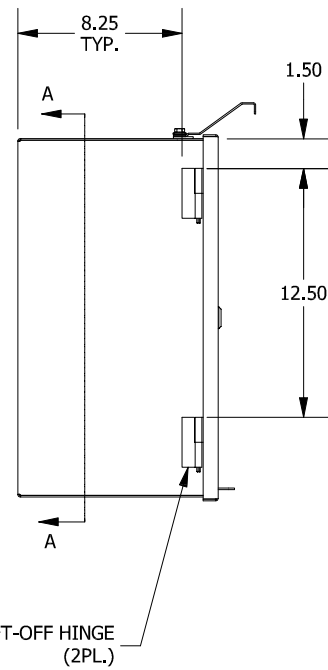
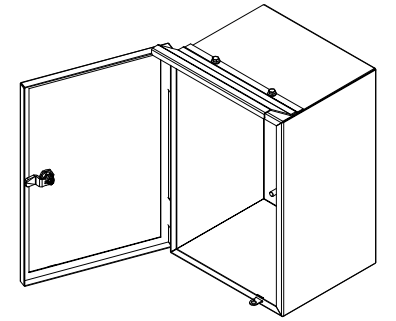

**LEFT SIDE VIEW**

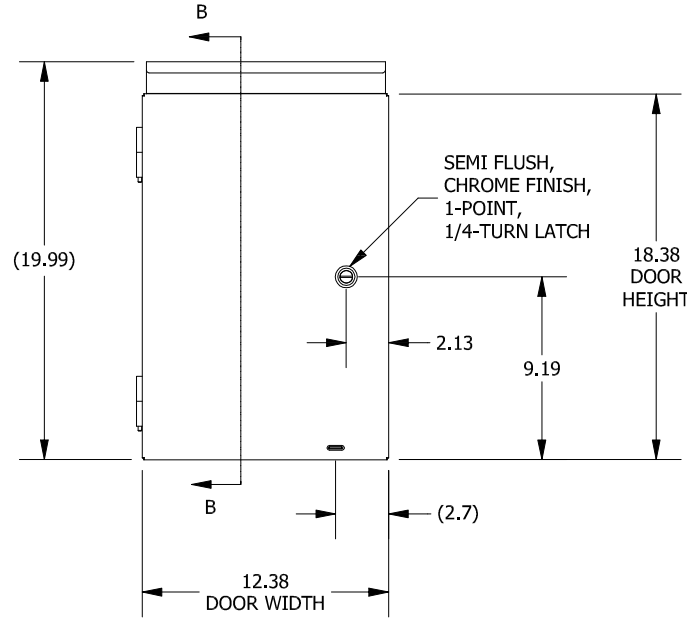

**FRONT VIEW**

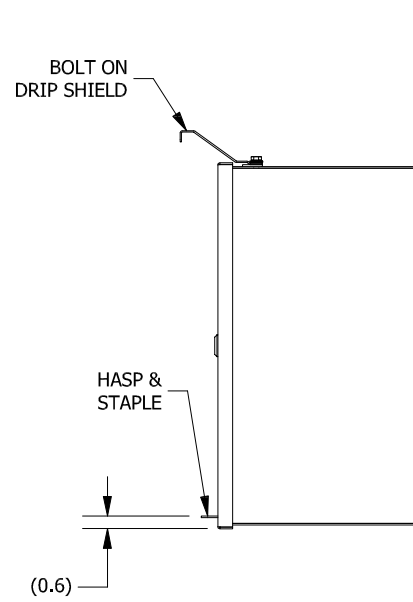

**RIGHT SIDE VIEW**

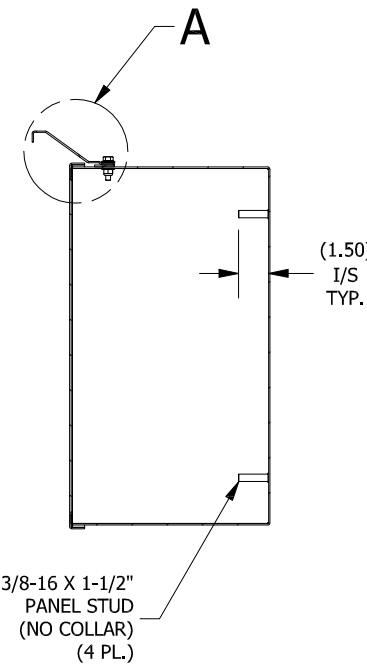

**SECTION B-B  
(INSIDE LEFT OF ENCL.)**

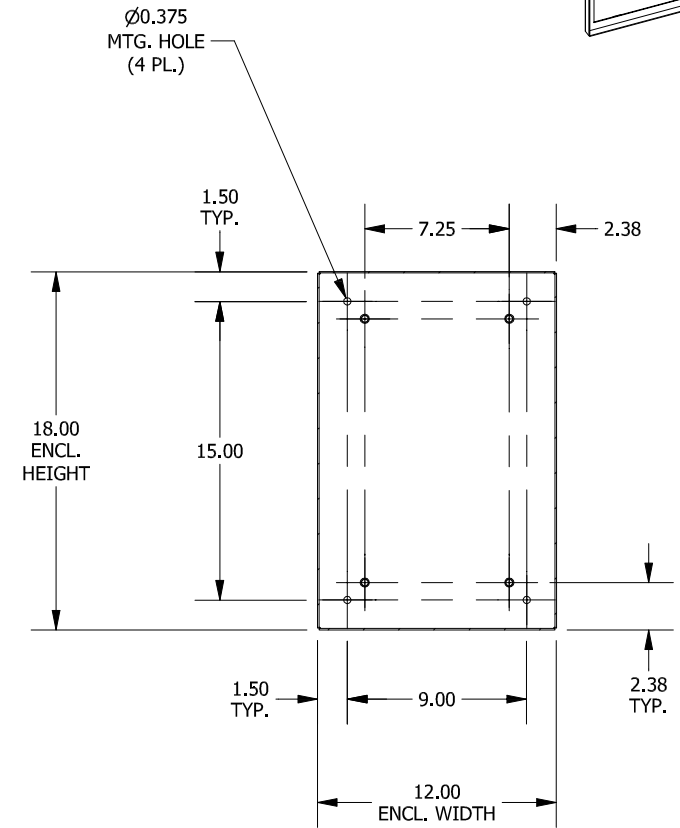

**SECTION A-A  
(INSIDE BACK OF ENCL.)**

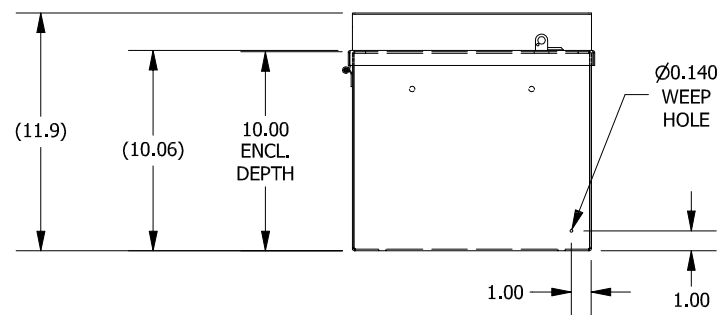

**BOTTOM VIEW**

PART#: CTSD121810  
 (DATA SUBJECT TO CHANGE WITHOUT NOTICE)

THIS DRAWING IS PROPERTY OF HUBBELL INC. WIEGMANN  
 ALL INFORMATION IS PROPRIETARY AND NOT TO BE DUPLICATED