

**TOP VIEW**

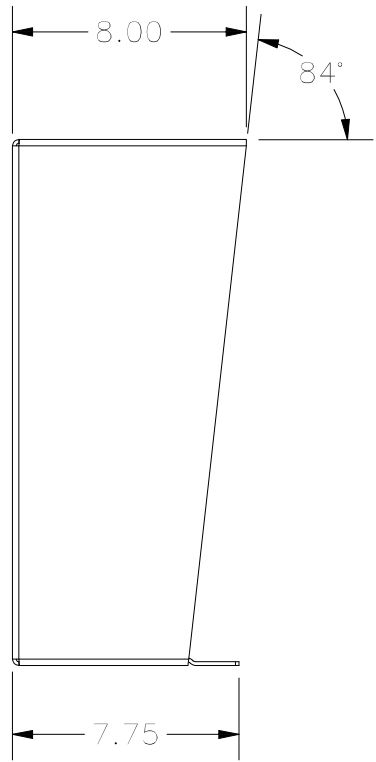

**LEFT VIEW**

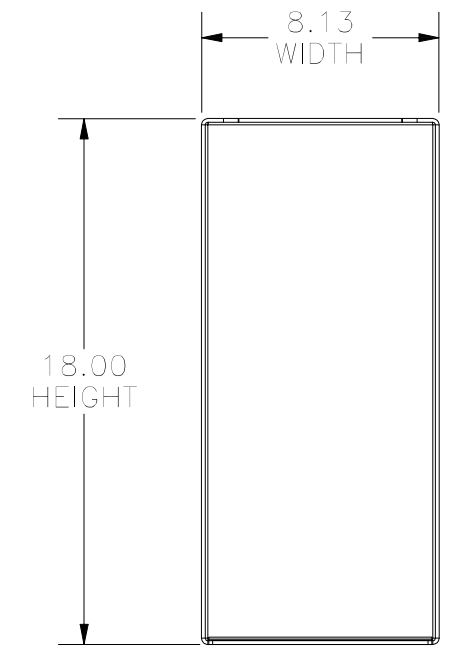

**FRONT VIEW**

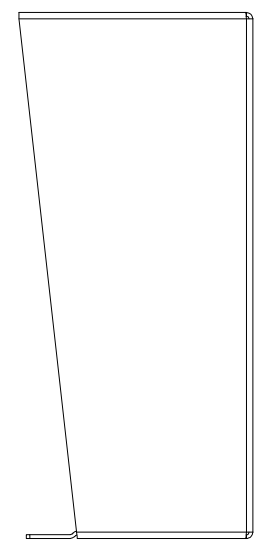

**RIGHT VIEW**

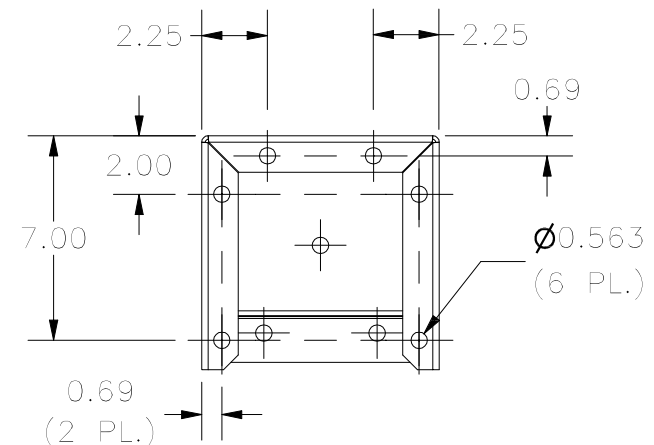
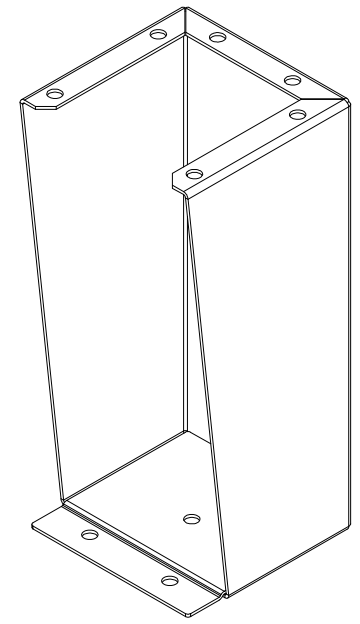

**BOTTOM VIEW**

PART#: FK1808  
(DATA SUBJECT TO CHANGE WITHOUT NOTICE)

THIS DRAWING IS PROPERTY OF HUBBELL INC. WIEGMANN  
ALL INFORMATION IS PROPRIETARY AND NOT TO BE DUPLICATED