

TOP VIEW

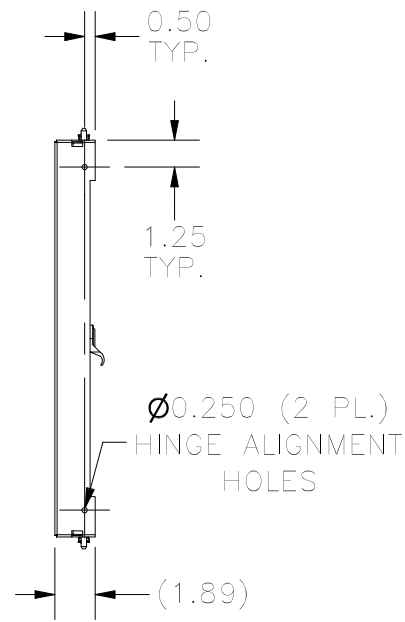

LEFT SIDE VIEW

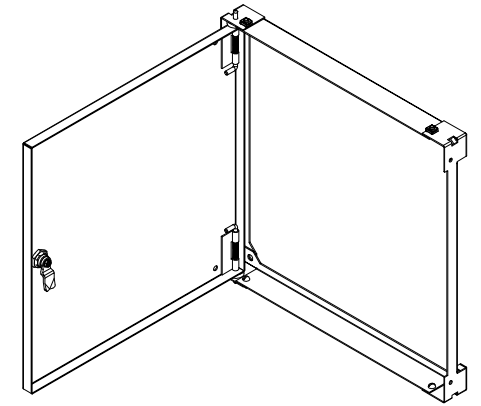
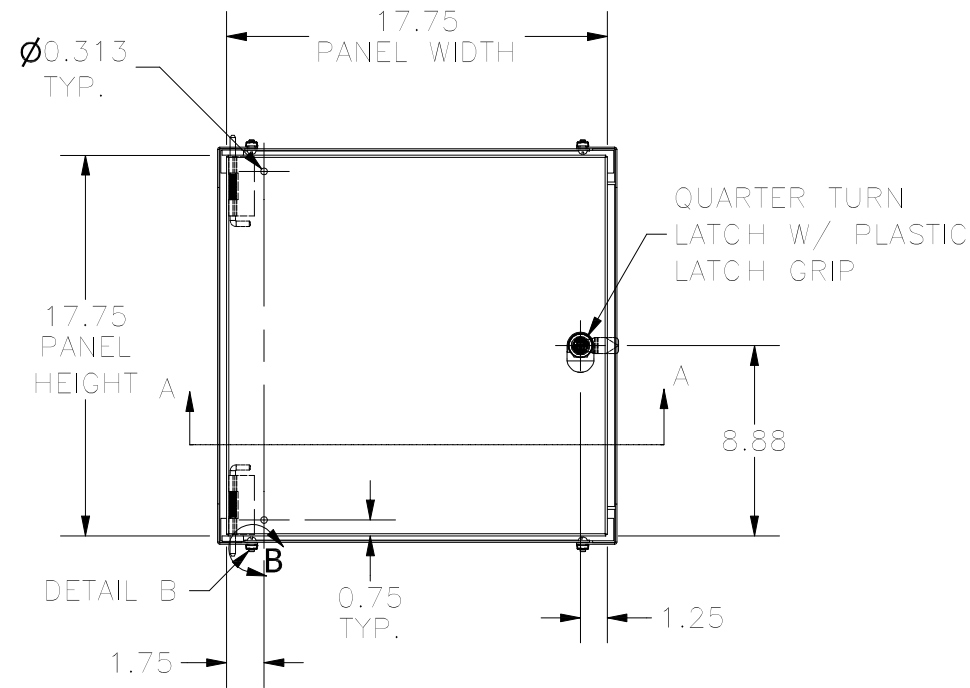

FRONT VIEW

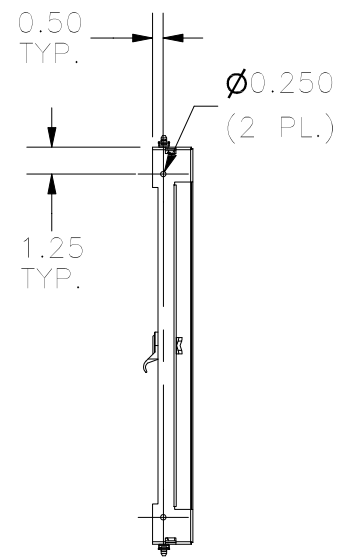

RIGHT SIDE VIEW

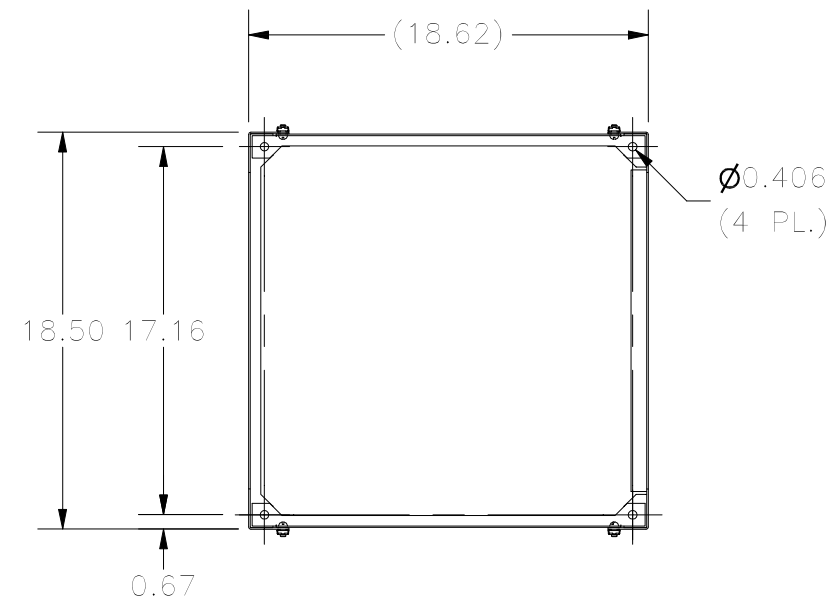

FRONT VIEW (SWING PANEL REMOVED)

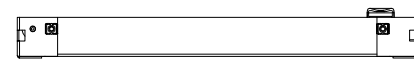

BOTTOM VIEW

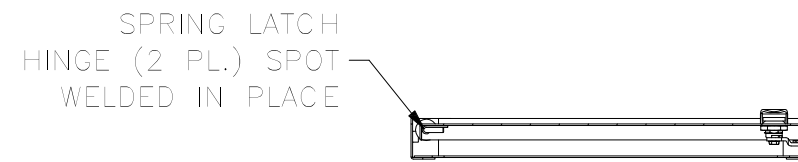

SECTION A-A

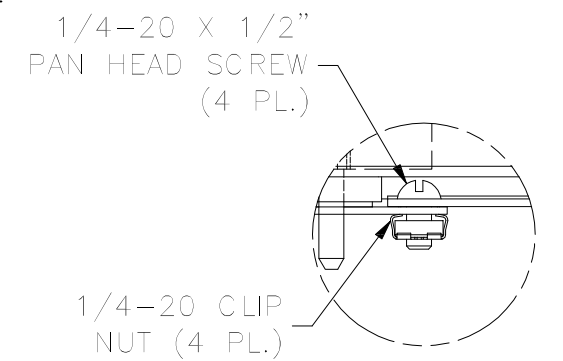

DETAIL B

PART#: HFWNSP2020C
(DATA SUBJECT TO CHANGE WITHOUT NOTICE)

THIS DRAWING IS PROPERTY OF HUBBELL INC. WIEGMANN
ALL INFORMATION IS PROPRIETARY AND NOT TO BE DUPLICATED