

TOP VIEW

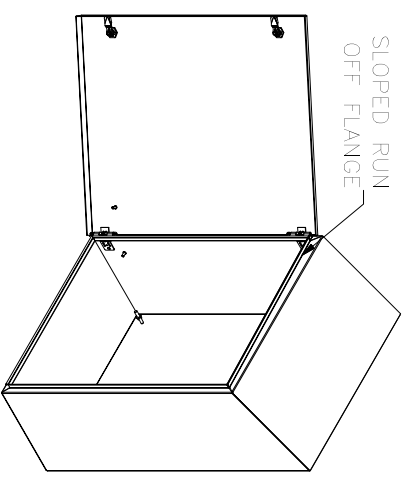

**REF. VIEW
(DOOR OPEN)**

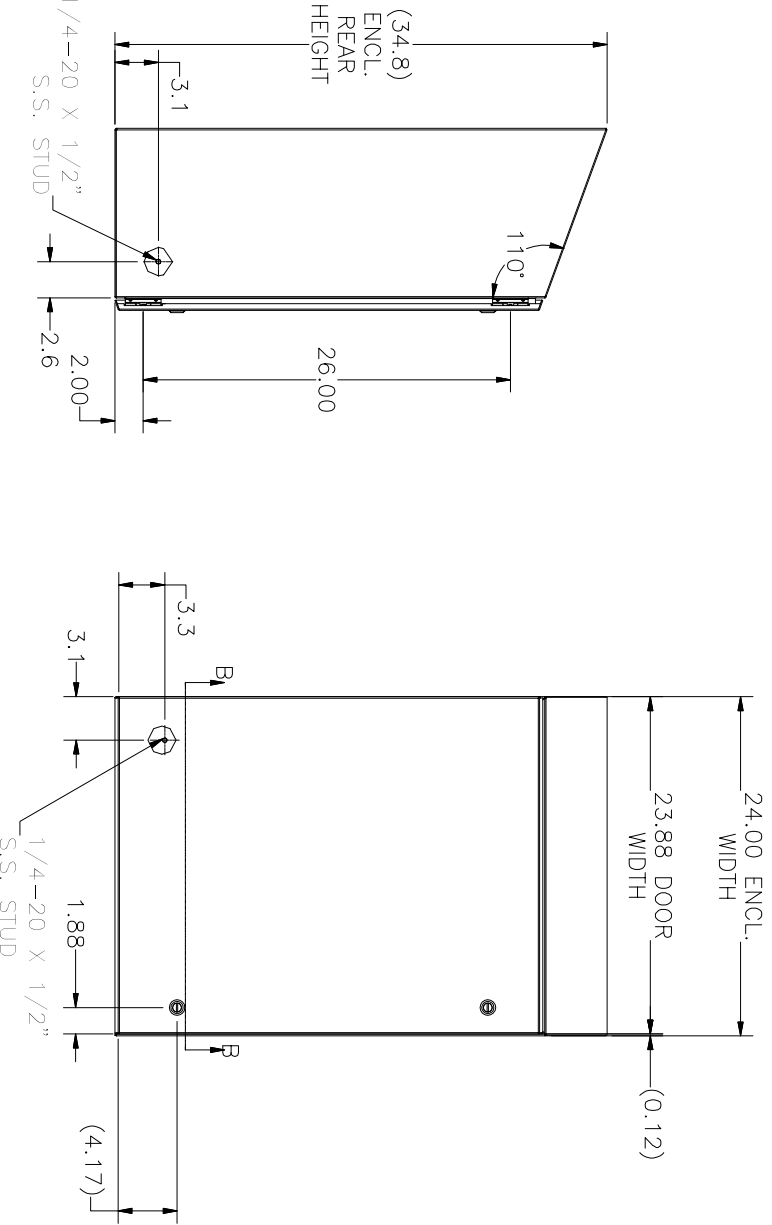

LEFT SIDE VIEW

FRONT VIEW

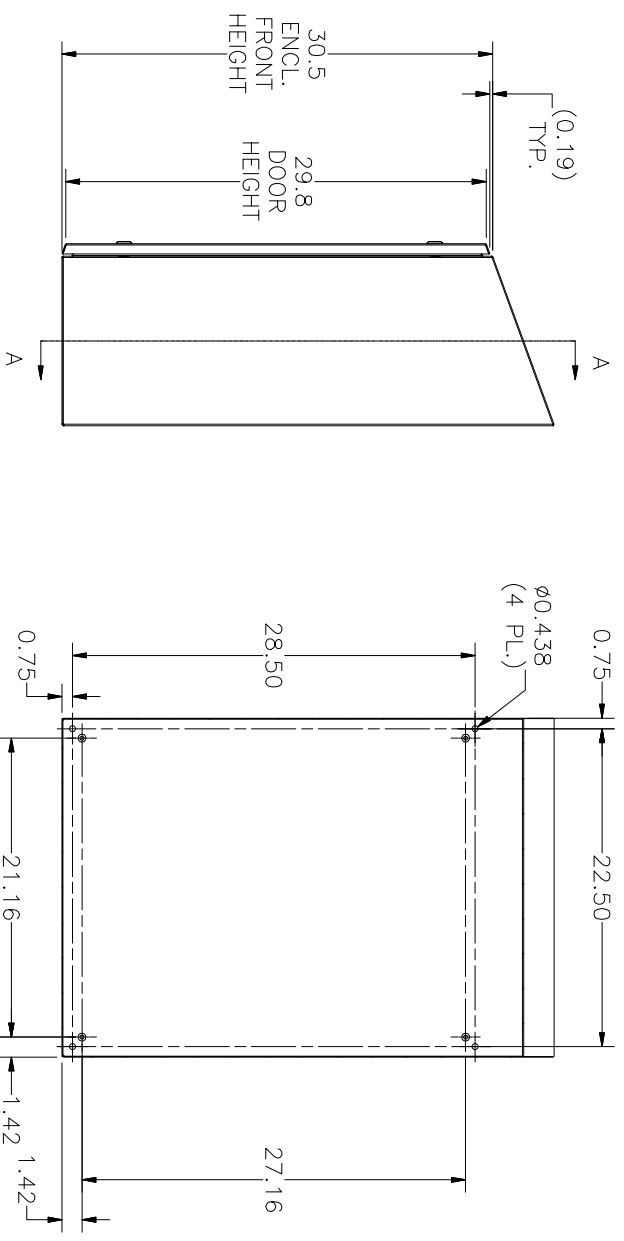

RIGHT SIDE VIEW

**SECTION A-A VIEW
(INSIDE BACK OF ENCL.)**

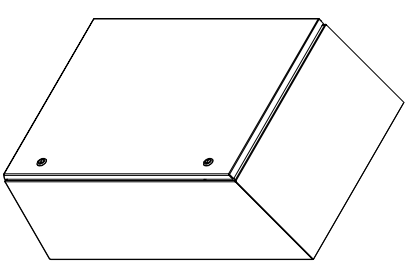

**REF. VIEW
(DOOR CLOSED)**

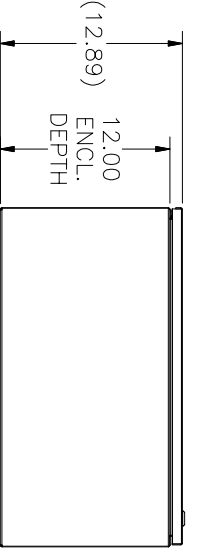

BOTTOM VIEW

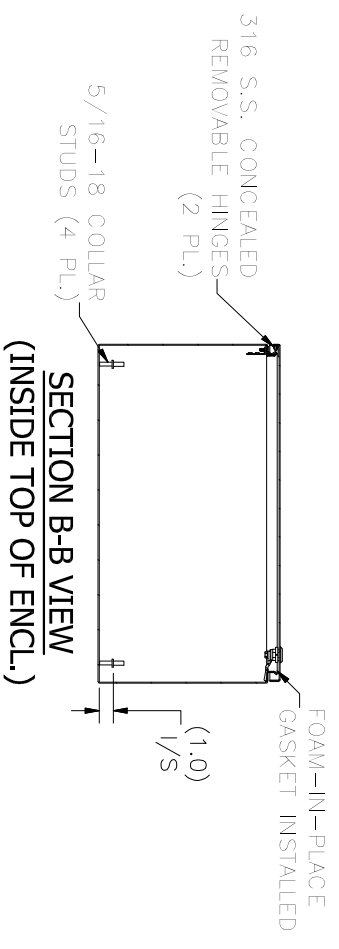

**SECTION B-B VIEW
(INSIDE TOP OF ENCL.)**

PART#: N412302412C SSSST
 (DATA SUBJECT TO CHANGE WITHOUT NOTICE)

THIS DRAWING IS PROPERTY OF HUBBELL INC. WIEGMANN
 ALL INFORMATION IS PROPRIETARY AND NOT TO BE DUPLICATED