

TOP VIEW

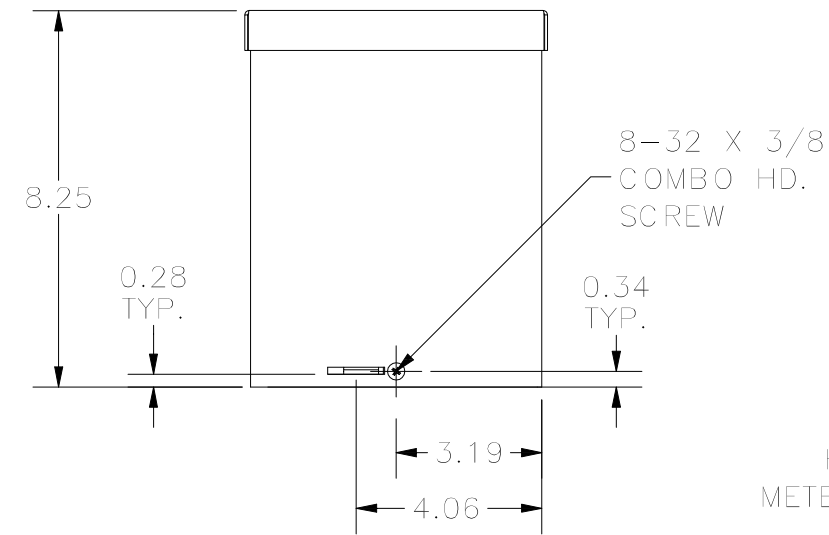

FRONT VIEW

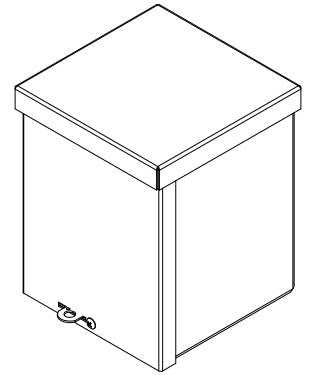
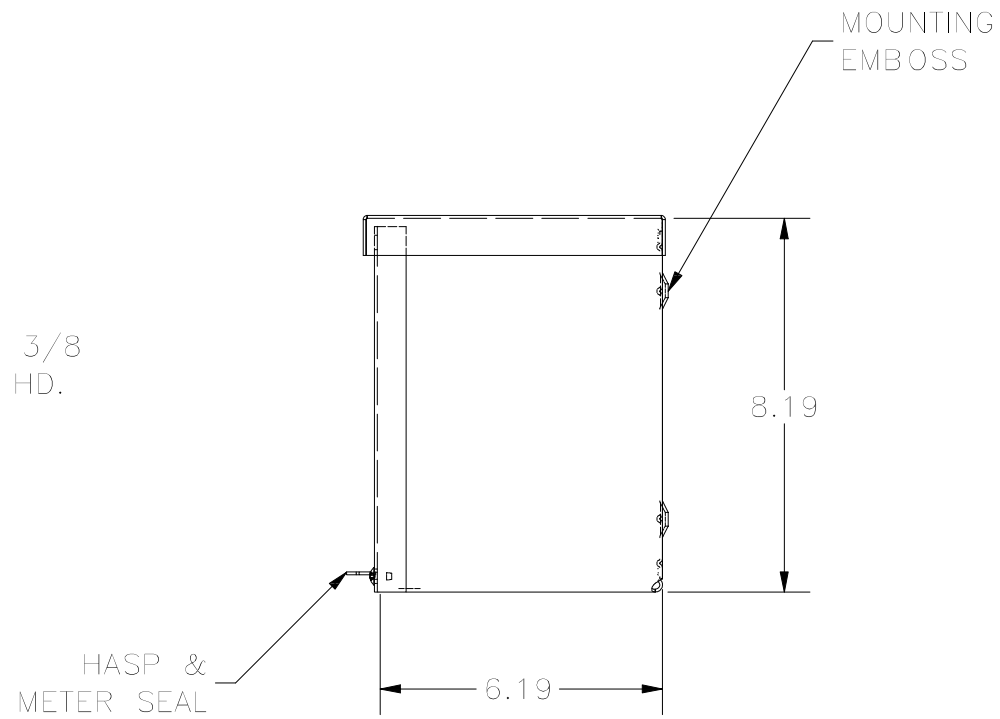

RIGHT VIEW

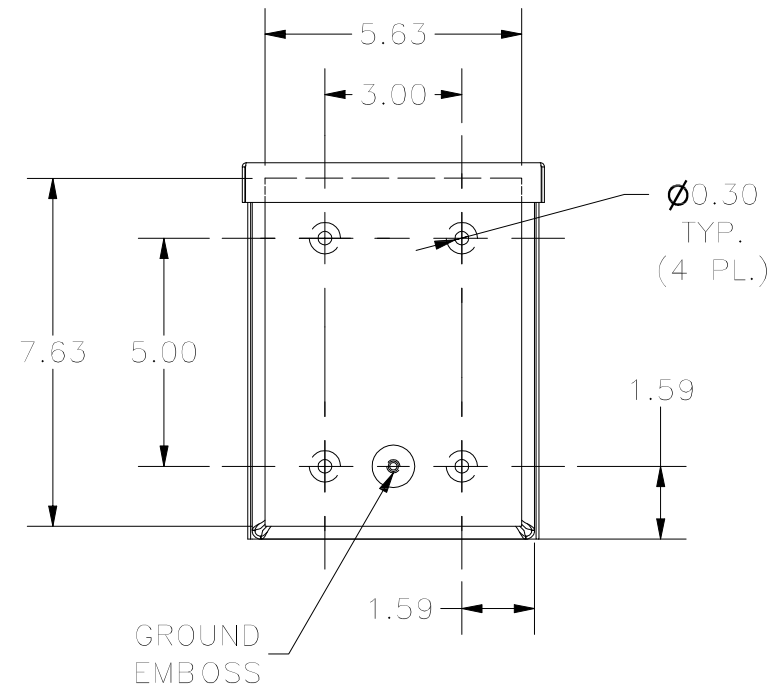

BACK VIEW

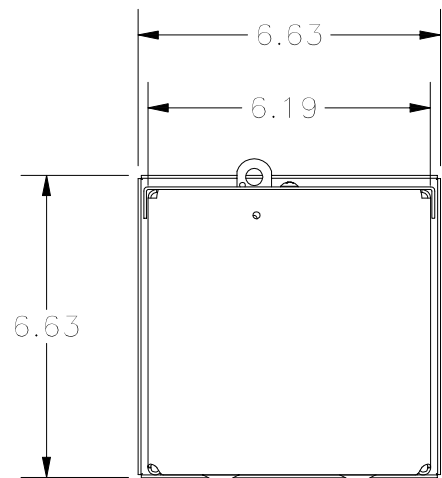

BOTTOM VIEW

PART#: RSC060806GNK
(DATA SUBJECT TO CHANGE WITHOUT NOTICE)

THIS DRAWING IS PROPERTY OF HUBBELL INC. WIEGMANN
ALL INFORMATION IS PROPRIETARY AND NOT TO BE DUPLICATED