

SC SERIES SCREW COVER PULL BOX ENCLOSURES (CONT.)								
CATALOG NUMBER				BODY/DOOR STEEL GAUGE	COVERS ONLY See Page A5	ENCLOSURE SIZE H+1/8", W+1/8", D+3/16"	KNOCKOUT PATTERN	
PAINTED		GALVANIZED					WIDTH SIDE	HEIGHT SIDE
W/KNOCKOUTS	W/O KNOCKOUTS	W/KNOCKOUTS	W/O KNOCKOUTS					
SC121804	SC121804NK	SC121804G	SC121804GNK	16/16	Yes	18.00x12.00x4.00 (457x305x102)	B-A-F-F-A-B	A-B-A-F-F-A-B-A
SC122404	SC122404NK	SC122404G	SC122404GNK	16/16	Yes	24.00x12.00x4.00 (610x305x102)	B-A-F-F-A-B	A-B-A-F-F-A-B-A
SC151504	SC151504NK	SC151504G	SC151504GNK	16/16	Yes	15.00x15.00x4.00 (381x381x102)	A-B-A-F-F-A-B-A	A-B-A-F-F-A-B-A
SC151804	SC151804NK	SC151804G	SC151804GNK	16/16	Yes	18.00x15.00x4.00 (457x381x102)	A-B-A-F-F-A-B-A	A-B-A-F-F-A-B-A
SC181804	SC181804NK	SC181804G	SC181804GNK	16/16	Yes	18.00x18.00x4.00 (457x457x102)	A-B-A-F-F-A-B-A	A-B-A-F-F-A-B-A
SC182404	SC182404NK	SC182404G	SC182404GNK	16/16	Yes	24.00x18.00x4.00 (610x457x102)	A-B-A-F-F-A-B-A	A-B-A-F-F-A-B-A
SC183004	SC183004NK	SC183004G	SC183004GNK	16/16	Yes	30.00x18.00x4.00 (762x457x102)	A-B-A-F-F-A-B-A	A-B-A-F-F-A-B-A
SC242404	SC242404NK	SC242404G	SC242404GNK	14/14	Yes	24.00x24.00x4.00 (610x610x102)	A-B-A-F-F-A-B-A	A-B-A-F-F-A-B-A
SC060606	SC060606NK	SC060606G	SC060606GNK	16/16	Yes	6.00x6.00x6.00 (152x152x152)	A-B-A	A-B-A
SC060806	SC060806NK	SC060806G	SC060806GNK	16/16	Yes	8.00x6.00x6.00 (203x152x152)	A-B-A	A-B-A
SC061206	SC061206NK	SC061206G	SC061206GNK	16/16	Yes	12.00x6.00x6.00 (305x152x152)	A-B-A	B-A-F-F-A-B
SC080806	SC080806NK	SC080806G	SC080806GNK	16/16	Yes	8.00x8.00x6.00 (203x203x152)	A-B-A	A-B-A
SC081006	SC081006NK	SC081006G	SC081006GNK	16/16	Yes	10.00x8.00x6.00 (254x203x152)	A-B-A	B-A-F-F-A
SC081206	SC081206NK	SC081206G	SC081206GNK	16/16	Yes	12.00x8.00x6.00 (305x203x152)	A-B-A	B-A-F-F-A-B
SC101006	SC101006NK	SC101006G	SC101006GNK	16/16	Yes	10.00x10.00x6.00 (254x254x152)	B-A-F-F-A	B-A-F-F-A
SC101206	SC101206NK	SC101206G	SC101206GNK	16/16	Yes	12.00x10.00x6.00 (305x254x152)	B-A-F-F-A	B-A-F-F-A-B
SC121206	SC121206NK	SC121206G	SC121206GNK	16/16	Yes	12.00x12.00x6.00 (305x305x152)	B-A-F-F-A-B	B-A-F-F-A-B
SC121506	SC121506NK	SC121506G	SC121506GNK	16/16	Yes	15.00x12.00x6.00 (381x305x152)	B-A-F-F-A-B	A-B-A-F-F-A-B-A
SC121806	SC121806NK	SC121806G	SC121806GNK	16/16	Yes	18.00x12.00x6.00 (457x305x152)	B-A-F-F-A-B	A-B-A-F-F-A-B-A
SC122406	SC122406NK	SC122406G	SC122406GNK	16/16	Yes	24.00x12.00x6.00 (610x305x152)	B-A-F-F-A-B	A-B-A-F-F-A-B-A

Note: Must specify CSA Label when ordering.
Consult factory for dimensions and drawings on 8", 10" and 12" deep enclosures.

Note: 8", 10" and 12" deep enclosures do not have mounting embosses in back of enclosure, only mounting holes.

Continued on page A4

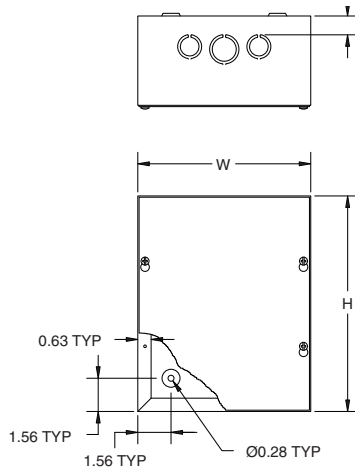
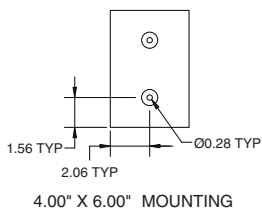
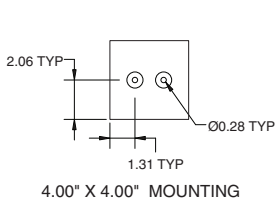

4" SIDE

Knockout Patterns

A -- 1/2" TO 3/4"
B -- 3/4" TO 1"
F -- 1" TO 1-1/4"

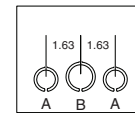

6" & 8" SIDE

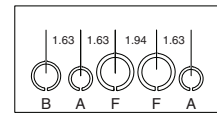

10" SIDE

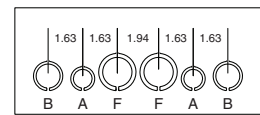

12" SIDE

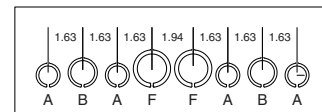

15", 18", 24",
30" & 36" SIDE.