

**TOP VIEW**

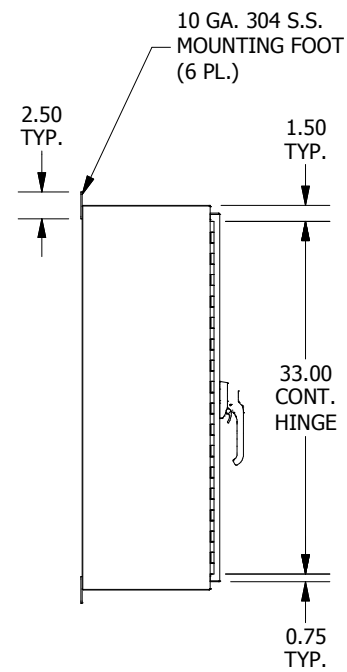

**LEFT SIDE VIEW**

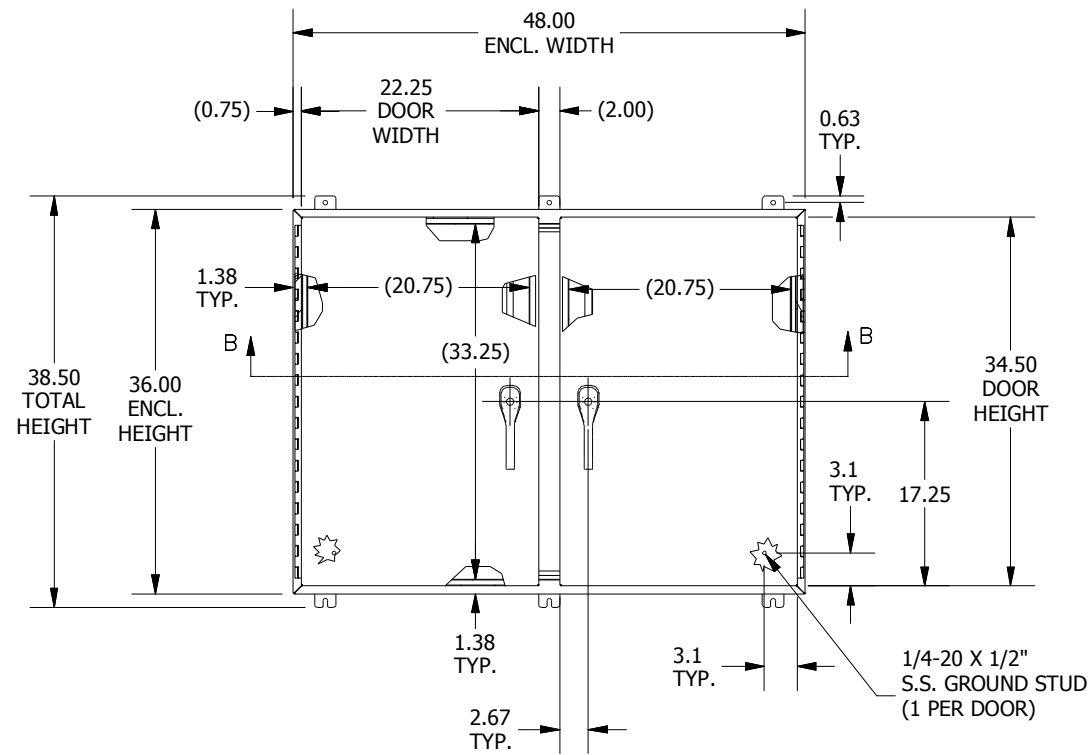

**FRONT VIEW**

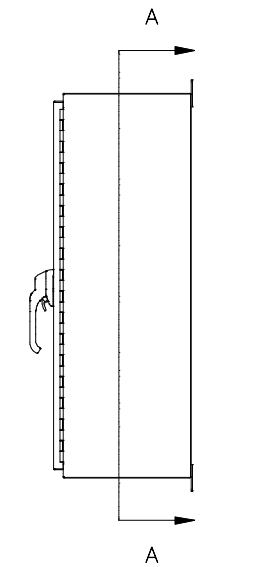

**RIGHT SIDE VIEW**

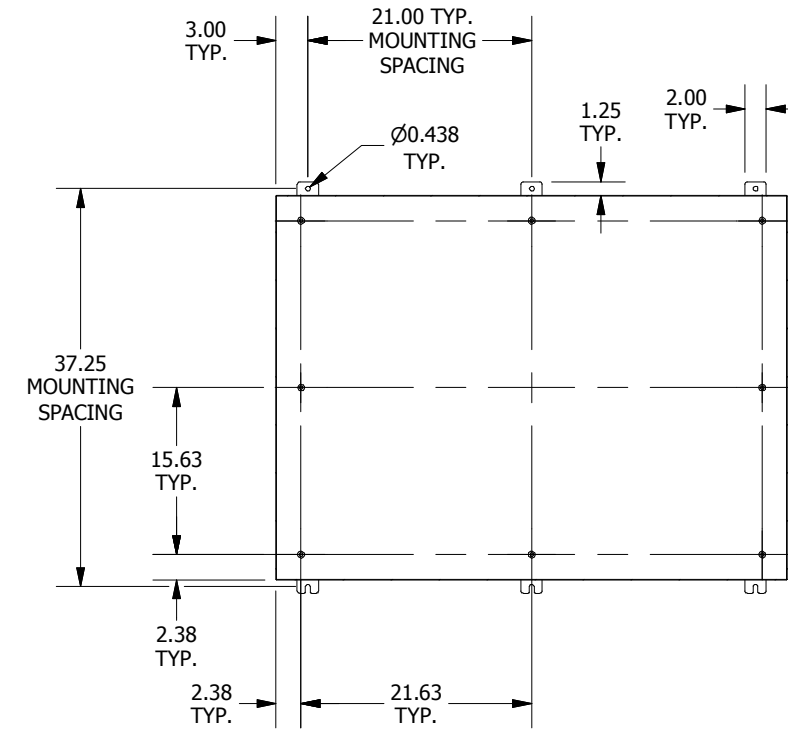

**SECTION A-A  
(INSIDE BACK VIEW OF ENCL.)**

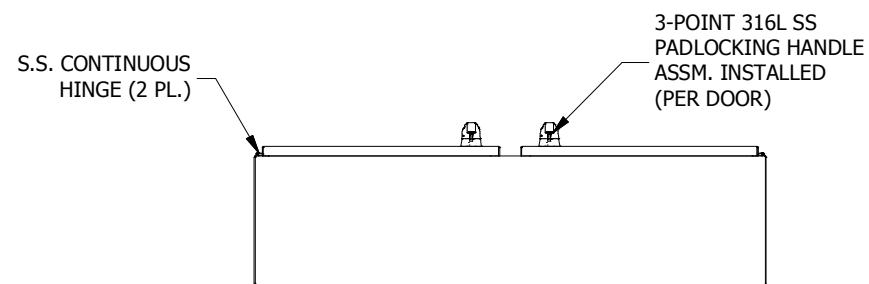
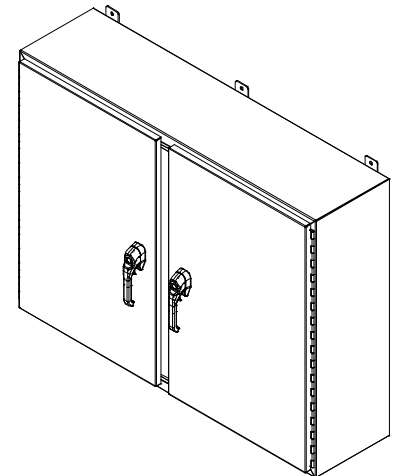
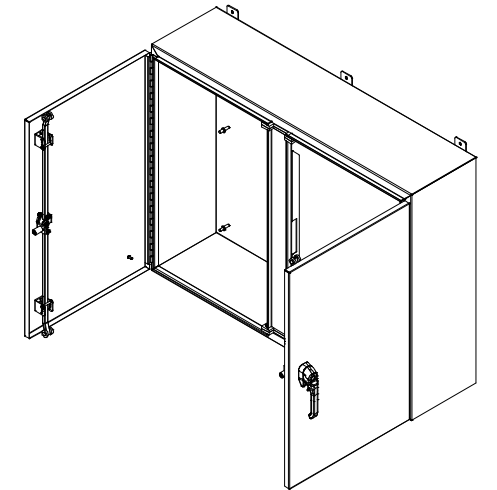

**BOTTOM VIEW**

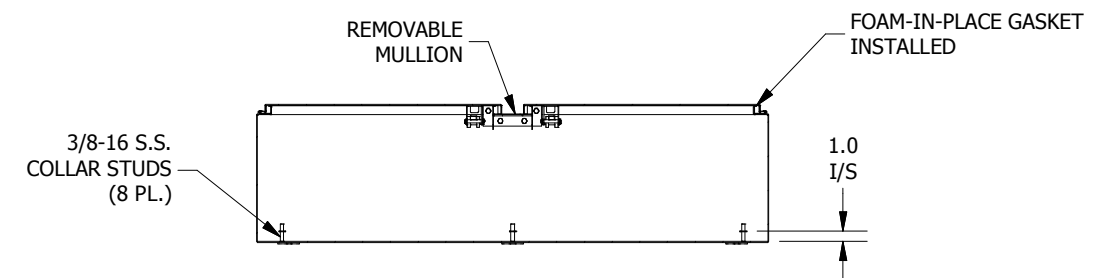

**SECTION B-B  
(INSIDE VIEW OF TOP)**

PART#: SSN4364812WF3PT  
(DATA SUBJECT TO CHANGE WITHOUT NOTICE)

THIS DRAWING IS PROPERTY OF HUBBELL INC. WIEGMANN  
ALL INFORMATION IS PROPRIETARY AND NOT TO BE DUPLICATED