

**TOP VIEW**

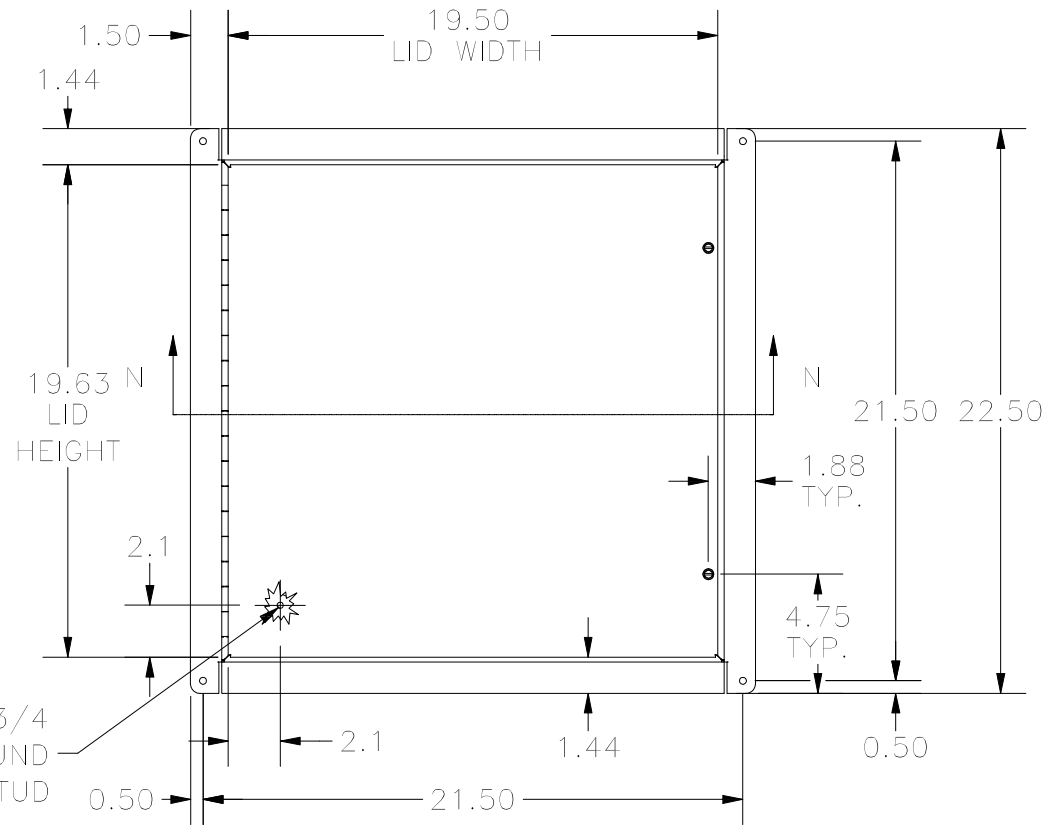

**FRONT VIEW**

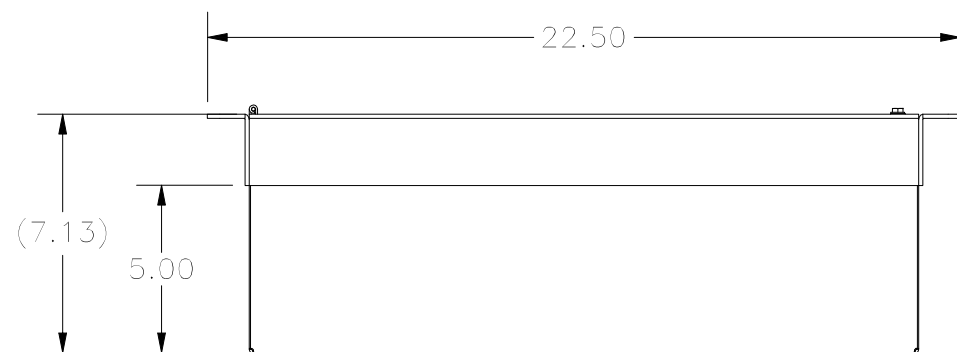

**BOTTOM VIEW**

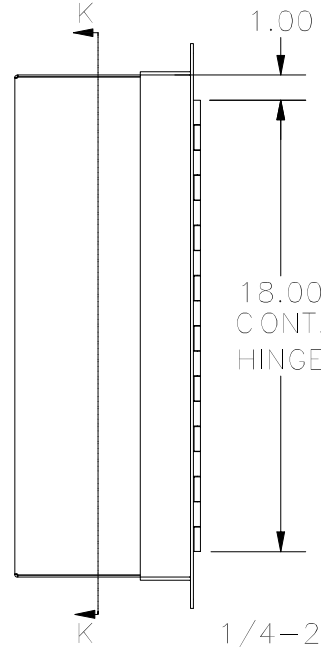

**LEFT SIDE VIEW**

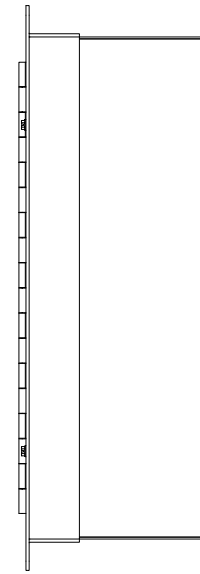

**RIGHT SIDE VIEW**

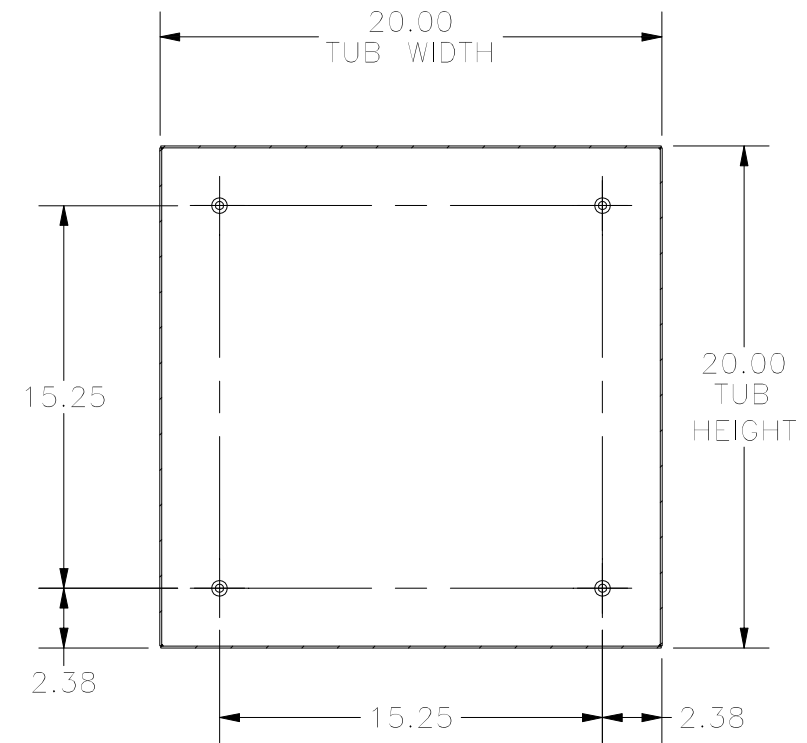

**SECTION K-K  
(INSIDE BACK OF ENCL.)**

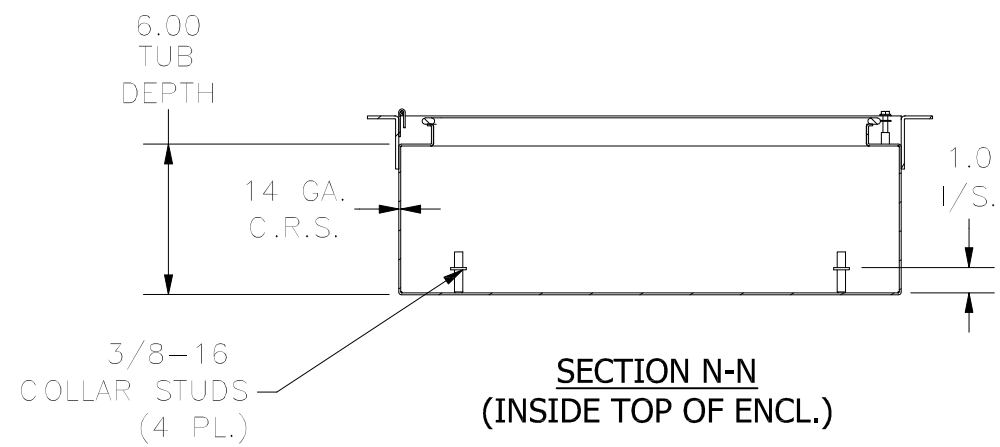

**SECTION N-N  
(INSIDE TOP OF ENCL.)**

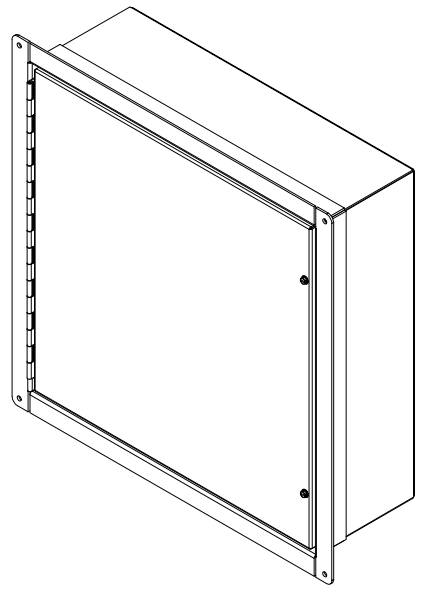

PART#: WA202006FM  
(DATA SUBJECT TO CHANGE WITHOUT NOTICE)

THIS DRAWING IS PROPERTY OF HUBBELL INC. WIEGMANN  
ALL INFORMATION IS PROPRIETARY AND NOT TO BE DUPLICATED