

PART#: WA72XM2718U
 (DATA SUBJECT TO CHANGE WITHOUT NOTICE)

THIS DRAWING IS PROPERTY OF HUBBELL INC. WIEGMANN
 ALL INFORMATION IS PROPRIETARY AND NOT TO BE DUPLICATED

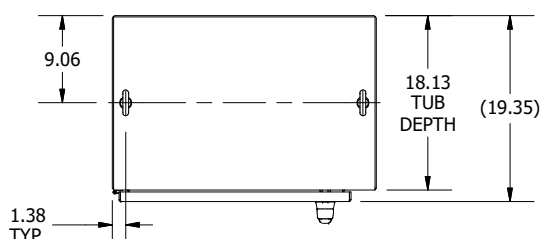

TOP VIEW

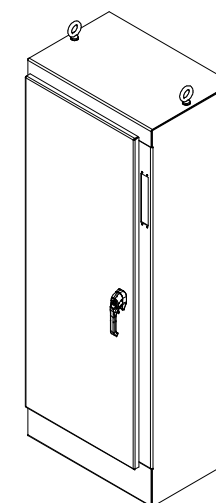
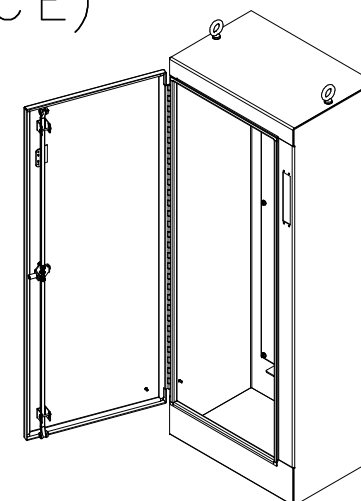
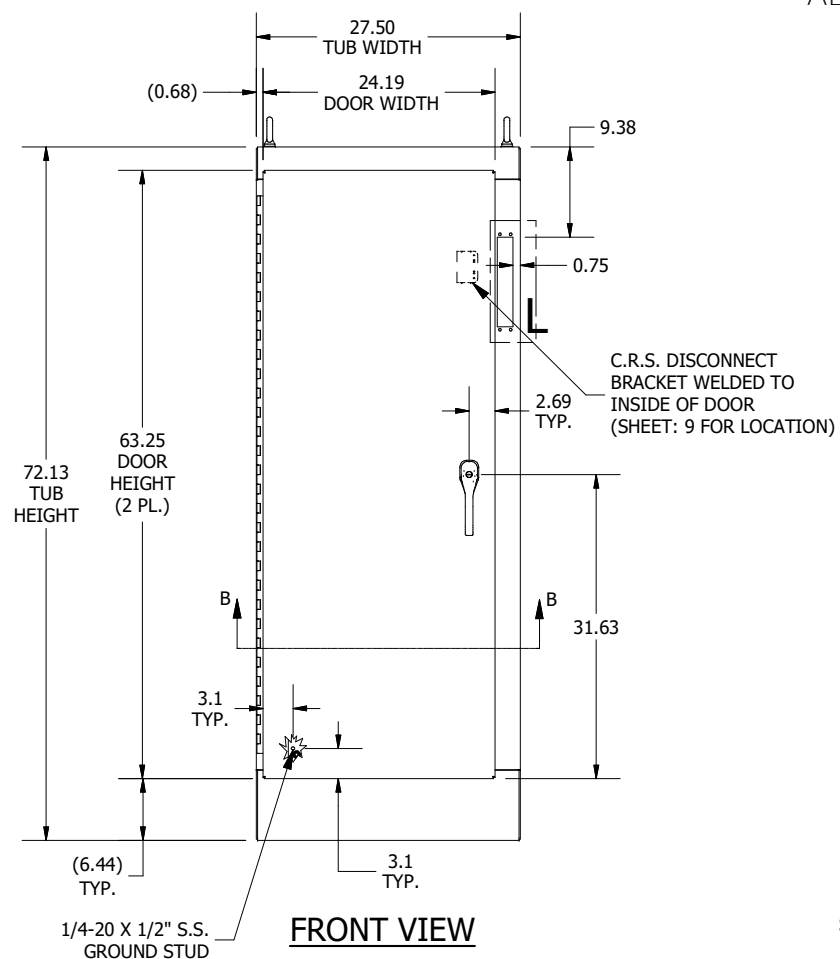

FRONT VIEW

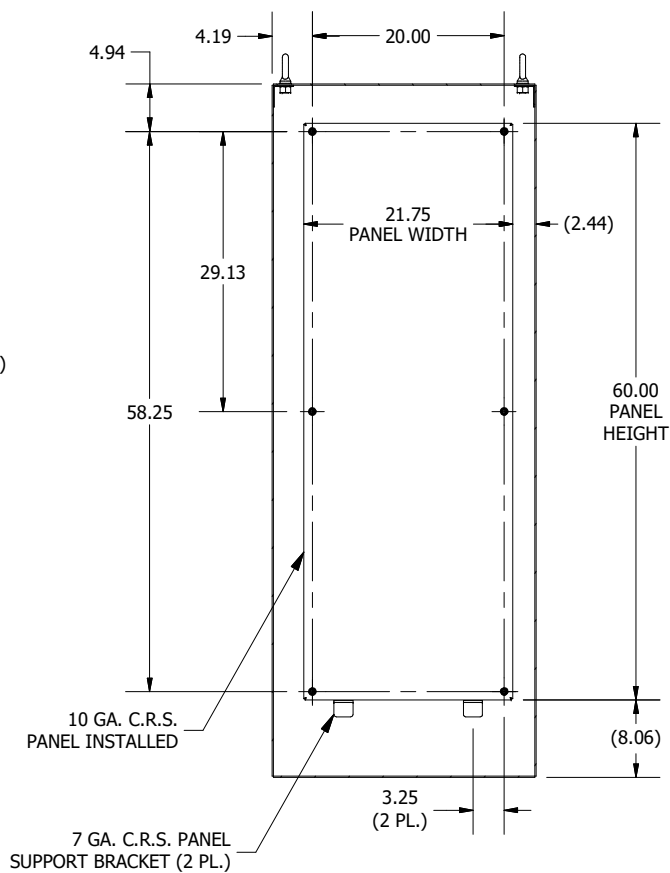

SECTION A-A
(INSIDE BACK OF ENCL.)

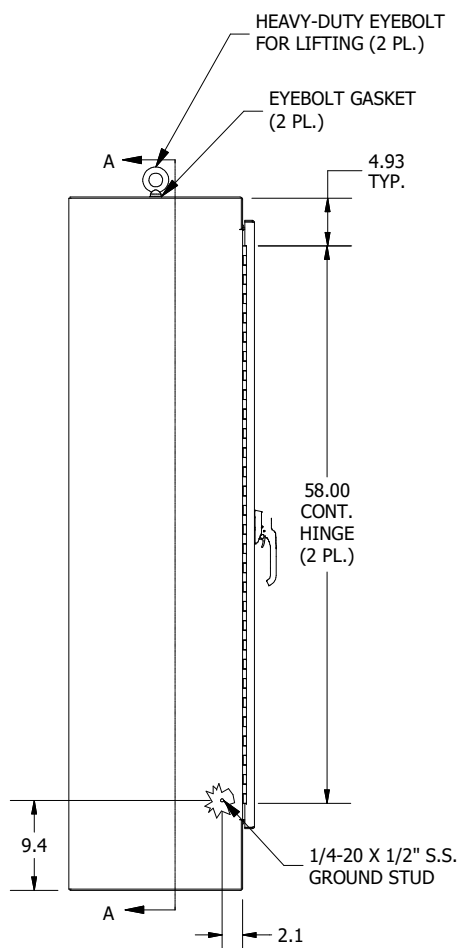

LEFT SIDE VIEW

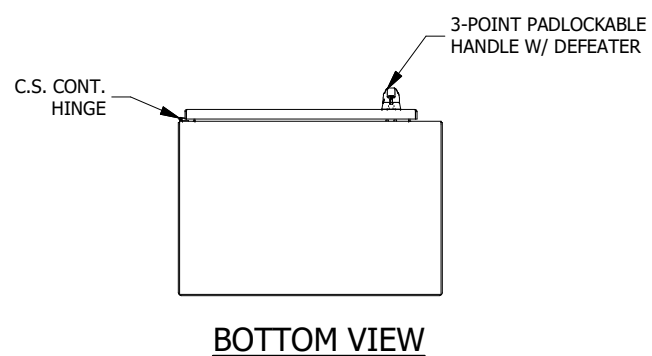

BOTTOM VIEW

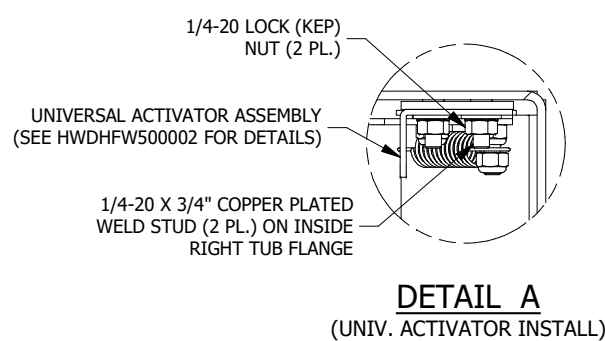

DETAIL A
(UNIV. ACTIVATOR INSTALL)

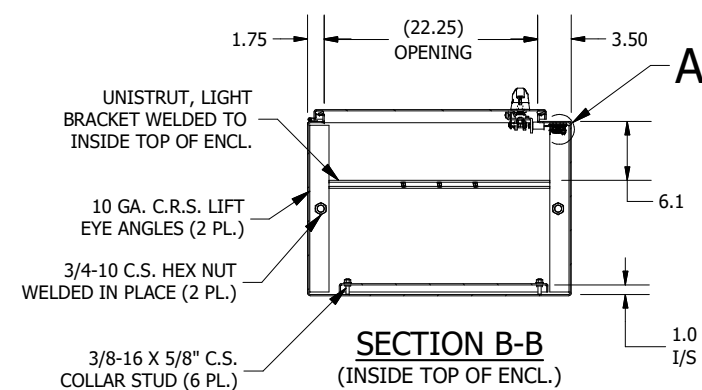

SECTION B-B
(INSIDE TOP OF ENCL.)

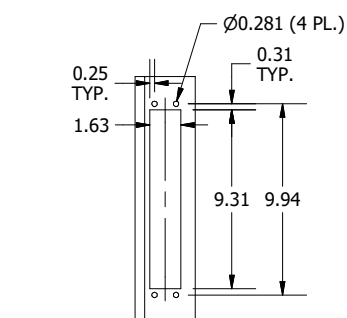

DETAIL L
(DISCONNECT CUTOUT DETAIL)