

INSTRUCTION MANUAL FOR DODGE® C-FLEX Module & FLEXIDYNE® Coupling

Sizes: 150 & 200 C-FLEX
Size: 5CF FLEXIDYNE Coupling

These instructions must be read thoroughly before installation or operation.

DESCRIPTION

C-FLEX is a dual C-face module designed for adapting a standard FLEXIDYNE coupling to a C-face motor/reducer combination. The FLEXIDYNE coupling provides a soft start, allowing the motor to come up to operating speed quickly when power is applied. Torque is limited so that the load is accelerated smoothly without being subjected to the normal 225% – 250% starting torque of a typical NEMA Design B A/C motor.

CAUTION: The C-FLEX Module is intended specifically for use with a C-face reducer. The output shaft of the module is not designed to accept any overhung load. Failure to observe this precaution could result in damage to or destruction of the equipment.

INSTALLATION

WARNING: To insure that drive is not unexpectedly started, turn off and lock out or tag power source before proceeding. Failure to observe these precautions could result in bodily injury.

1. NOTE: Use Model 5CF x 5/8" FLEXIDYNE unit with 56C frame motors; 5CF x 7/8" FLEXIDYNE unit with 140TC frame motors. Standard size 5C FLEXIDYNE unit will not fit in the C-FLEX Module.

Install rubber element on knurled end of C-FLEX Module output shaft until it bottoms against module. Slide both clamps over rubber element.

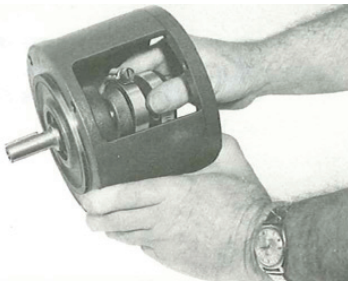

WARNING: Because of the possible danger to persons(s) or property from accidents which may result from the improper use of products, it is important that correct procedures be followed. Products must be used in accordance with the engineering information specified in the catalog. Proper installation, maintenance and operation procedures must be observed. The instructions in the instruction manuals must be followed. Inspections should be made as necessary to assure safe operation under prevailing conditions. Proper guards and other suitable safety devices or procedures as may be desirable or as may be specified in safety codes should be provided, and are neither provided by Dodge nor are the responsibility of Dodge. This unit and its associated equipment must be installed, adjusted and maintained by qualified personnel who are familiar with the construction and operation of all equipment in the system and the potential hazards involved. When risk to persons or property may be involved, a holding device must be an integral part of the driven equipment beyond the speed reducer output shaft.

2. Insert FLEXIDYNE unit thru the slots in the end of the module, knurled end first, and into rubber element.

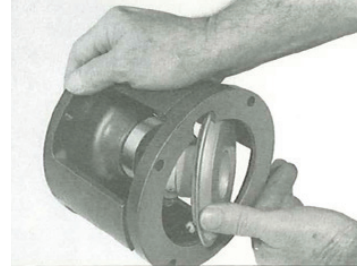

3. It is recommended that the reducer be firmly attached to its support before installing C-FLEX module and motor. Stake C-FLEX module output shaft key in position and insert module into reducer. Install and tighten bolts to 360 in-lbs.

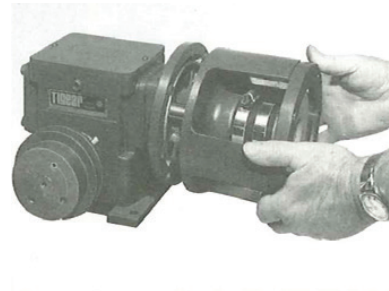

4. Stake the motor shaft key in position, flush with end of motor shaft.



5. Slide motor shaft into FLEXIDYNE unit. Install and tighten bolts. Locate rubber element so that it is flush with knurled end of C-FLEX module output shaft. Locate clamp flush with end of rubber element and tighten clamp screw snugly.

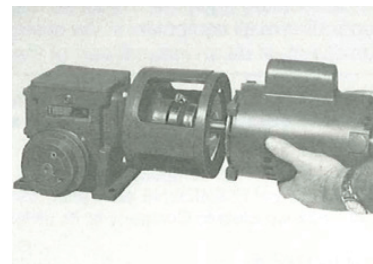

6. Note access hole provided in rubber element. Hold rubber element to keep it from rotating and rotate FLEXIDYNE unit until setscrew is visible in access hole. Position FLEXIDYNE unit so that setscrew is centered in access hole. Tighten setscrew securely, it is important that the setscrew bottoms on the key. In a similar manner locate and tighten second setscrew on the shaft. Locate clamp flush with the end of the rubber element. In order to provide proper balance, position the clamp tightening screws so that they are on opposite sides (180° apart) of the rubber element. Tighten clamp screw snugly.

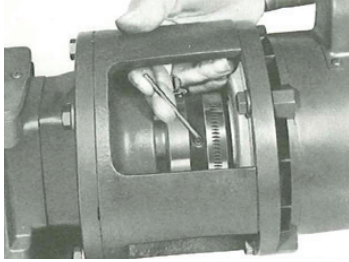

7. Remove the filler plug and install the proper amount of flow charge specified in Table 1. Replace and tighten filler plug, making sure that no flow charge is trapped in the threads. Torque filler plug screws to 35 inch-pounds. Where the C-FLEX installation is exposed to operating personnel, it is advisable to use the mesh-type guard provided. Drill 2 holes in the module housing for self-tapping screws. Wrap guard around housing and secure with screws.

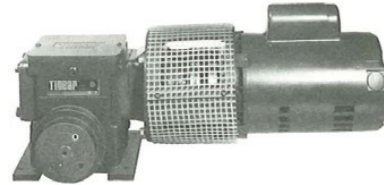

Flow Charge Recommendations

Table 1 - Based on % of Starting Torque for 1760 RPM NEMA Design B Motors

Rated Motor HP	100% @ 1760 RPM				125% @ 1750 RPM				150% @ 1740 RPM			
	Starting HP	Flow Charge		Max. Time in Sec.	Starting HP	Flow Charge		Max. Time in Sec.	Starting HP	Flow Charge		Max. Time in Sec.
		LBS.	OZ			LBS.	OZ			LBS.	OZ	
1/2	.5	0	4	140	.62	0	4.5	120	.75	0	5	115
3/4	.75	0	5	115	1.0	0	5.5	90	1.1	0	6	85
1	1.0	0	6	90	1.3	0	6.5	83	1.5	0	7	70
1-1/2	1.5	0	7	70	1.9	0	7.5	60	2.2	0	8	52
2	2.0	0	8	56	2.5	0	8.5	50	3.0	0	9	44

Rated Motor HP	175% @ 1700 RPM				200% @ 1650 RPM			
	Starting HP	Flow Charge		Max. Time in Sec.	Starting HP	Flow Charge		Max. Time in Sec.
		LBS.	OZ			LBS.	OZ	
1/2	.85	0	6	100	.94	0	7	90
3/4	1.3	0	7	76	1.4	0	8	70
1	1.7	0	8	60	1.9	0	9	56
1-1/2	2.5	0	9	50	2.8	0	10	44
2	3.4	0	10	40	3.6	0	11	37

Table 2: Thermal Capacity

Starting HP	Maximum Allowable Acceleration Time in seconds for 1750 rpm Motor Speed @ Various Starting Cycles							
	2 Hours	1 Hour	30 Minutes	15 Minutes	10 Minutes	5 Minutes	2 Minutes	1 Minute
.5	140	140	140	140	125	74	30	15
1.0	90	90	90	90	80	46	19	10
1.5	70	70	70	70	60	36	15	5
2.0	56	56	56	56	46	29	12	3
2.5	50	50	50	50	42	26	10	...
3.0	44	44	44	44	39	23	8	...
3.6	37	37	37	37	32	20	5	...

THERMAL CAPACITY

Since there is slippage within the flow charge during acceleration, heat is generated from friction. The thermal capacity of the FLEXIDYNE coupling is based on balancing the heat generated during acceleration with the cooling time between accelerations. The amount of heat generated is determined by the amount of energy dissipated by slipping and the duration of each acceleration. A longer time between starts will dissipate more heat; therefore, higher starting horsepowers may be transmitted, or longer acceleration times may be allowable (refer to Starting Cycle section).

Acceleration times shown in Table 1 are for starting frequencies of no more than one start per hour. If starting frequency is more than once per hour, use acceleration time for actual starting cycle shown in Table 2.

Acceleration times listed in Tables 1 and 2 are the MAXIMUM permissible for the various starting frequencies listed. The MINIMUM acceleration time required for proper FLEXIDYNE coupling operation is 1 to 1½ seconds. This is the time required for the flow charge to be uniformly distributed around the housing cavity before the unit “locks in.” Any acceleration time between the minimum and maximum listed is acceptable, although a shorter acceleration time will generally provide longer wear life. For applications requiring a specific acceleration time (within these limits) flow charge may be added or removed to produce the required results.

Stalled — If a jam-up stalls the drive, the motor continues to run and the FLEXIDYNE coupling slips. This causes heat to be generated at twice the rate of normal acceleration. Therefore, the allowable slipping time, when stalled, is half the allowable acceleration time given in Table 1.

Starting Cycle is the time from the beginning of one acceleration to the beginning of the next. Allowable acceleration times in Table 2 are based on the assumption that the FLEXIDYNE coupling will be running continuously except for a momentary stop before the next start. If the stop is more than momentary, decrease the actual starting cycle by one-half the stopped time before using Table 2; for example, with a 50-minute actual starting cycle of which 20 minutes is stopped time, decrease 50 by half of 20 to give 40 minutes as the starting cycle time to use for Table 2.

Grouped Starts — For several starts grouped together followed by uninterrupted running, add the acceleration times of all starts and consider it as the time for one start. The starting cycle would be the time from the beginning of one group of starts to the beginning of the next group.

OPERATION

CAUTION: The FLEXIDYNE rotor must slip during acceleration to allow flow charge to become evenly distributed. DO NOT ALLOW FLEXIDYNE MECHANISM TO RUN without a load on the driven end. Failure to observe this precaution could result in damage to or destruction of the equipment.

Acceleration — The amount of flow charge in the FLEXIDYNE determines the acceleration time for a given load. Longer acceleration times will occur when less flow charge is used and faster acceleration, from stop to full speed, will be observed with greater amounts of flow charge.

The FLEXIDYNE should start the load smoothly and without delay provided the proper amount of flow charge has been used. Should the acceleration time exceed the maximum allowable in Table 1, shut off power to the FLEXIDYNE immediately. Allow the FLEXIDYNE to cool, then add small amounts of flow charge until proper acceleration is observed.

Vibration is an indication of accelerating too rapidly and not allowing flow charge to become evenly distributed in the FLEXIDYNE housing. This can be corrected by removing small amounts of flow charge until vibration subsides. Other causes of vibration are undersize shafting, unit not installed far enough on shaft, or worn bore in the unit.

Slippage—The FLEXIDYNE can, without slipping, transmit overloads up to 130% of its present starting torque. Should this breakaway torque be exceeded, the FLEXIDYNE will slip and generate heat. Although slippage usually indicates increased loads, it can also be caused by worn flow charge or a worn rotor, especially if the FLEXIDYNE has been in operation for some time. The necessity to replace flow charge will be made evident by a loss in power transmitting capacity of the FLEXIDYNE.

MAINTENANCE

WARNING: To insure that drive is not unexpectedly started, turn off and lock out or tag power source before proceeding. Failure to observe these precautions could result in bodily injury.

For average applications involving 3 or 4 starts a day of not more than 6 seconds acceleration time each, the flow charge should be changed every 10,000 hours of operation. For more severe conditions, visually inspect flow charge at more frequent intervals; it should be changed when it has deteriorated to a half powder, half granular condition. Visual inspections should continue until enough flow charge changes have been made to adequately establish a schedule for renewing FLEXIDYNE flow charge.

Both the FLEXIDYNE and the module have been lubricated at the factory and no further lubrication is required. Never apply grease, oil or any other foreign material to the flow charge.

Parts List for C-Flex Module & FLEXIDYNE Coupling

Item	Quantity	Name of Part	Part Numbers	
			Model 150	Model 250
1	1	Housing	305030	303050
2	1	Shaft	305032	305033
3	1	Housing Shroud	305054	305054
4	2	Retaining Ring	421072	421072
5	2	Bearing	424219	424219
6	1	FLEXIDYNE Mechanism	305117	305037
7	2	Filler Plug	305018	305018
8	1	Rubber Element	305246	305246
9	2	Hose Clamp	421115	421115
10	1	Setscrew	400022	400014
11	1	Setscrew	400030	400018

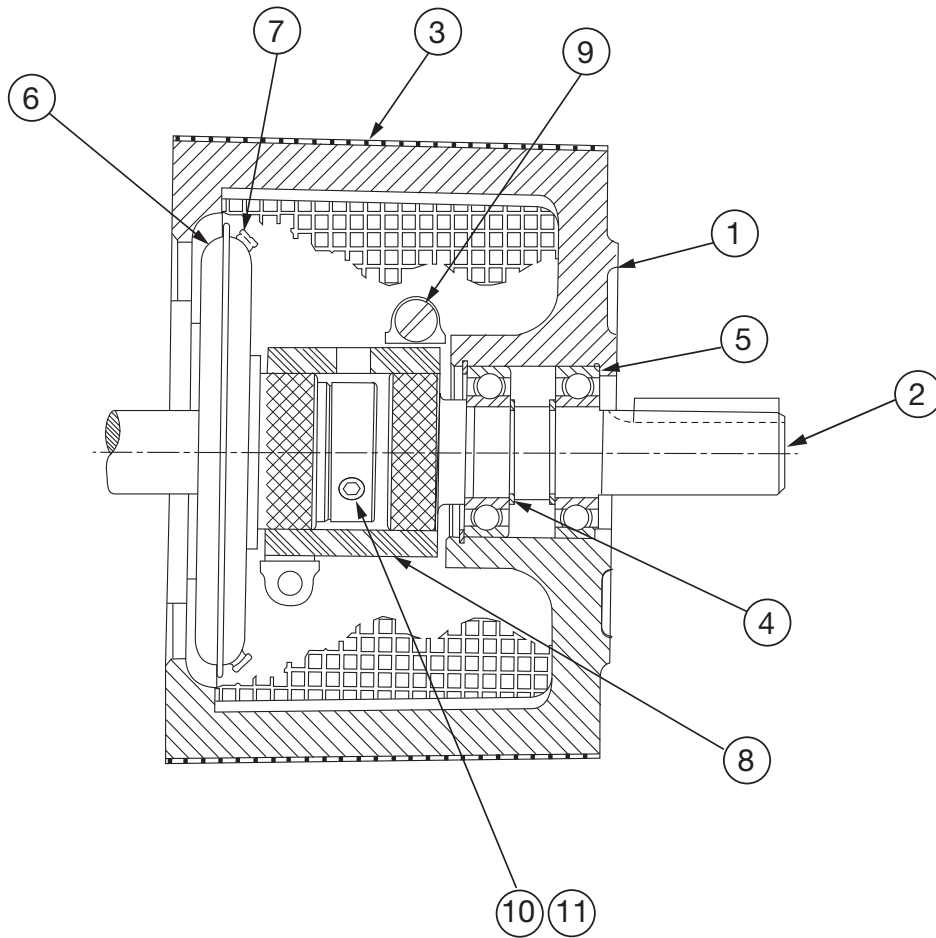

Dodge Industrial, Inc.
 1061 Holland Road
 Simpsonville, SC 29681
 +1 864 297 4800

