



Create Your Individual 3D PDF Datasheet



Learn How to Create Your Mechanical Product Catalog



Learn How to Create Your BIM Product Catalog



Reduce Your Costs in Engineering and Purchasing



# 124641

## SC 2 Bolt Flange Bearings -(Normal Duty) -Re-Lube and No-Lube



### 3D View

To activate the interactive 3D view, you must trust this document (see hint on the top) in Adobe Acrobat and click on the question mark.

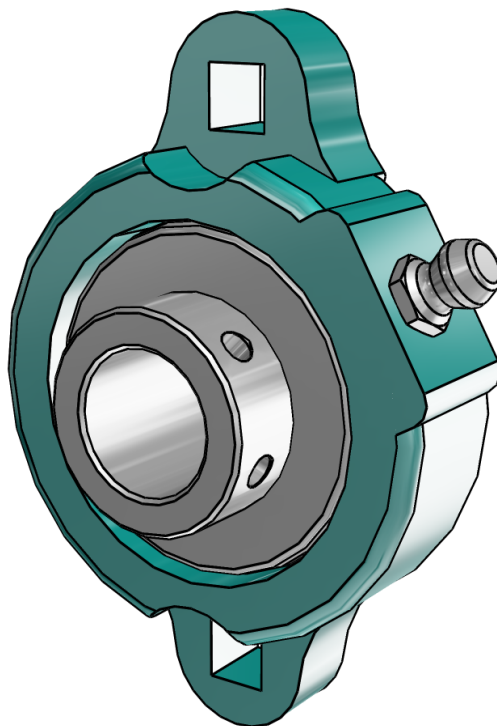

#### Zoom

Moves you toward or away from objects in the scene when you drag vertically. You can also zoom with the hand tool by holding down Shift as you drag.

#### Pan

Moves the model vertically and horizontally only. You can also pan with the hand tool: Ctrl-drag.

#### Rotate

Turns 3D objects around relative to the screen. How the objects move depends on the starting view, where you start dragging and the direction in which you drag.

# 3D PDF DATASHEET



eCATALOGsolutions



BIM catalogs.net



PARTsolutions



Create Your Individual 3D PDF Datasheet



Learn How to Create Your Mechanical Product Catalog



Learn How to Create Your BIM Product Catalog



Reduce Your Costs in Engineering and Purchasing



## 124641

SC 2 Bolt Flange Bearings -(Normal Duty) -Re-Lube and No-Lube

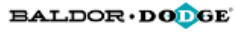

2D Derivation

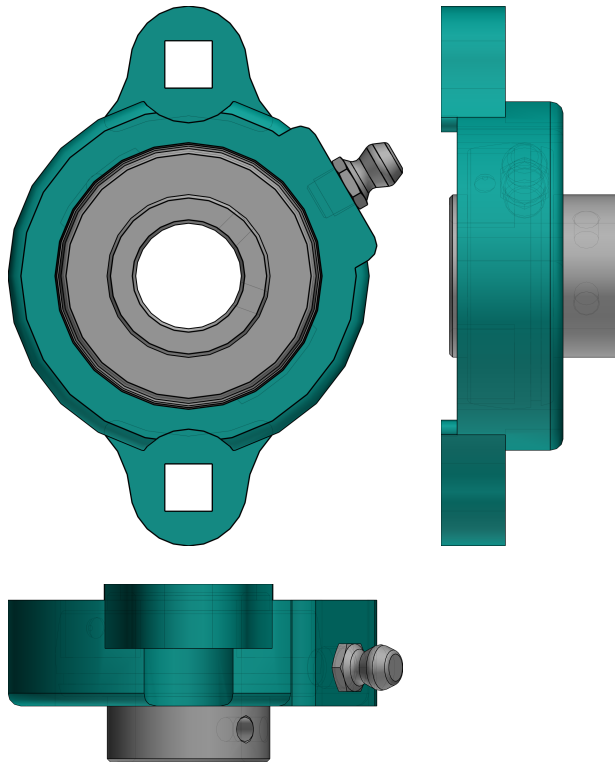

ISO View

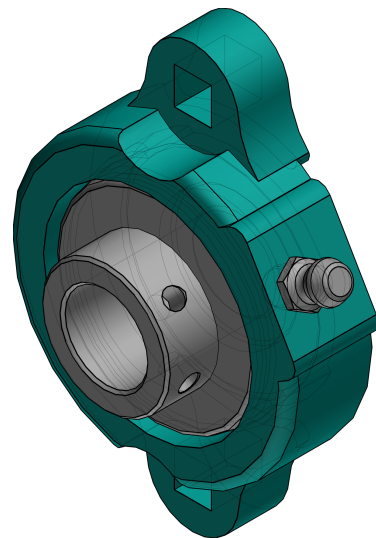

3D PDF DATASHEET



eCATALOG solutions



BIM catalogs.net



PART solutions



Create Your Individual 3D PDF Datasheet



Learn How to Create Your Mechanical Product Catalog



Learn How to Create Your BIM Product Catalog



Reduce Your Costs in Engineering and Purchasing



124641

SC 2 Bolt Flange Bearings -(Normal Duty) -Re-Lube and No-Lube

BALDOR • DODGE

## Technical Drawings

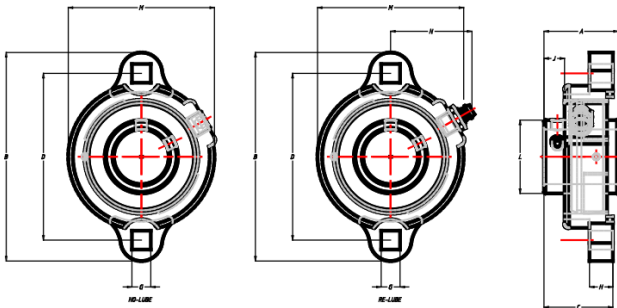

*NOTES:*

*GREASE USED:  
EXXON UNIREX N2*

*SEAL TYPE:  
DUAL GUARD LIP SEAL  
W/ RUBBERIZED FLINGER*

## 3D PDF DATASHEET



 eCATALOG solutions



 BIM catalogs.net



 PART solutions



Create Your Individual 3D PDF Datasheet 

Learn How to Create Your Mechanical Product Catalog 

Learn How to Create Your BIM Product Catalog 

Reduce Your Costs in Engineering and Purchasing 

# 124641

## SC 2 Bolt Flange Bearings -(Normal Duty) -Re-Lube and No-Lube

**BALDOR • DODGE**

### Technical Data

SERIES (Series)	203
SS (Shaft Size / INCH)	5/8
PN (Part No.)	124641
DESCRIPTION (Description)	LFT-SC-010
W (W / lbs)	0.55
LF (Lubrication Feature)	RE-LUBE
A (A / INCH)	1.00
B (B / INCH)	3.19
C (C / INCH)	1.05
D (D / INCH)	2.50
G (G / INCH)	0.28
H (H / INCH)	0.38
J (J / INCH)	0.33
L (L / INCH)	0.96
M (M / INCH)	2.13
N (N / INCH)	1.23

# 3D PDF DATASHEET



 eCATALOG solutions



 BIM catalogs.net



 PART solutions



Create Your Individual 3D PDF Datasheet ▶

Learn How to Create Your Mechanical Product Catalog ▶

Learn How to Create Your BIM Product Catalog ▶

Reduce Your Costs in Engineering and Purchasing ▶

## 124641

SC 2 Bolt Flange Bearings -(Normal Duty) -Re-Lube and No-Lube



### Bill of Materials

N°	Name	Description	Amount
1	assembly	124641	1
1.1	HOUSING	124641	1
1.2	GF203	405020c	1
1.3	INSERT	123329	1