

LENOX 

TOOL CATALOG

**POWER TOOL ACCESSORIES
HAND TOOLS**



A man wearing safety glasses is working on a wooden structure, possibly a roof or ceiling, with various wires and cables. The scene is dimly lit, with a strong light source from the right, creating a dramatic effect. The man is looking upwards, focused on his work. The background shows wooden beams and a dark, textured surface.

TABLE^{OF} **CONTENTS**

UPBLADE WITH LENOX

1-9

POWER TOOL ACCESSORIES

10-51

HAND TOOLS

52-68



UPBLADE^{WITH} LENOX[®]



WHAT'S UPBLADE?

If you use a LENOX blade you might already know. But UpBlade is more than just upgrading to the best blades in the market, UpBlade is a continuous commitment to being better. When you switch to LENOX you don't just UpBlade your blade, you UpBlade your tools, your cuts, your capabilities.

The logo features the word "UP" in blue and "BLADE" in red, both in a bold, sans-serif font. A small trademark symbol (TM) is located at the top right of the word "BLADE".

UPBLADE™

YOUR OPERATIONS

**WHEN CUTTING IS WHAT YOU DO, THE
BLADE YOU CHOOSE BECOMES EVEN
MORE IMPORTANT.**

You're only as efficient as your blade allows you to be. That's why we make sure our band saw blades cut faster and last longer, with the lowest cost per cut—making your operations more competitive. And with our tech reps making sure that our blades are always working at their optimal level, you'll spend more time cutting and less time changing blades. If you don't believe us, talk to your LENOX® representative about taking the UpBlade Challenge.

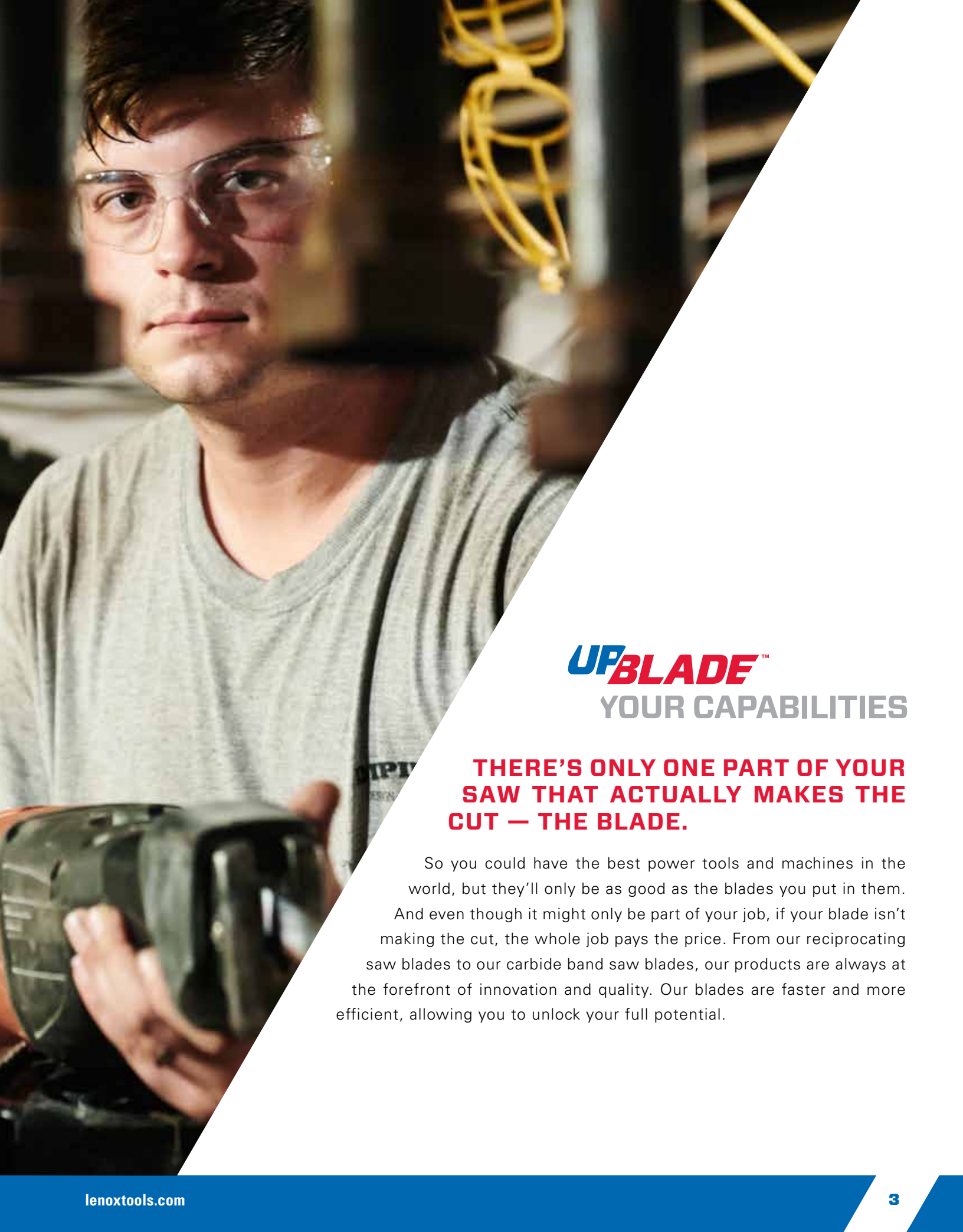

UPBLADE™
YOUR CAPABILITIES

**THERE'S ONLY ONE PART OF YOUR
SAW THAT ACTUALLY MAKES THE
CUT — THE BLADE.**

So you could have the best power tools and machines in the world, but they'll only be as good as the blades you put in them. And even though it might only be part of your job, if your blade isn't making the cut, the whole job pays the price. From our reciprocating saw blades to our carbide band saw blades, our products are always at the forefront of innovation and quality. Our blades are faster and more efficient, allowing you to unlock your full potential.



A large, diagonal photograph of an industrial factory interior, showing various pieces of machinery, pipes, and structural elements. The image is split diagonally from the top-left corner to the bottom-right corner, with the white background of the text on the right side.

UPBLADE™ YOUR CRAFT

HAVING THE BEST BLADES IS ONLY PART OF THE EQUATION.

To truly UpBlade, you must also improve yourself. That's why we've developed the LENOX Institute of Technology (LIT).

We provide our Technical Service Reps, distributor partners and consumers with hands-on training by expert instructors who have years of LENOX experience and application knowledge. Because our blades are only as good as the hands that wield them, LIT helps us make sure those hands are amongst the best in the business.

A man in a blue t-shirt, sunglasses, and work gloves is working on a white car door frame. He is leaning over the frame, which is propped up. In the background, there is a white car with its door open, a flagpole with a flag, and a clear blue sky. The scene is outdoors, likely at a manufacturing or repair facility.

OUR UPBLADE HERITAGE.

The word UpBlade represents a mindset that LENOX® has lived by from day one. For nearly 100 years we've led the industry through many changes and innovations, and our blades have consistently remained on top. You saw this reflected in *HACKMAN*® as he toured the world facing bigger challenges at every stop—returning to us with insights that helped improve our blades' designs. And you see it with the challenges we put before our blades in our One Blade campaign. Challenges such as cutting 8 cars with a single blade. As we push our blades to the limit we UpBlade not only their achievements, but your perception of what one blade is capable of. UpBlade is the reason LENOX makes the best blades in the market. Because we're not satisfied with being the best. We're working hard every day to get even better.



IT WASN'T A GOOD DAY TO LEAVE A WHITE CAR IN OUR PARKING LOT.

We had never cut more than five. But since we are obsessed with relentlessly improving our blades, we wanted to see if we could improve our records as well. And if any blade could do it, it was the LENOX T2™ Demolition. It's engineered to deliver the longest-lasting, fastest-cutting performance in the industry. The result? We ran out of cars before the blade was done cutting. Anyone want to go for nine?

Don't believe us? Go to oneblade.com to see the "making of" video and get a trial blade so you can see for yourself.



UPBLADE WITH
LENOX

LENOX T2™ Demolition Reciprocating Saw Blade / Model 5905

COMMITTED TO BEING BETTER FOR NEARLY 100 YEARS



1915

LENOX® American Saw founded by John Swanson, Carl Ericson, and Carl Davis to manufacture Hacksaw Blades in Springfield, MA

1918

Band Saw Blade production begins

LENOX purchases an electron beam welder and begins manufacturing Bi-metal Band Saw Blades

1965

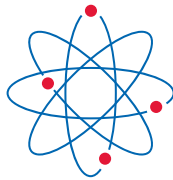

1964
All LENOX operations moved to its current location in East Longmeadow, MA



Hand Tools and Power Tool Accessories.

1977

First Bi-metal Reciprocating Saw Blades

1981

HACKMAN® uses a LENOX Hacksaw Blade to cut his first car in half

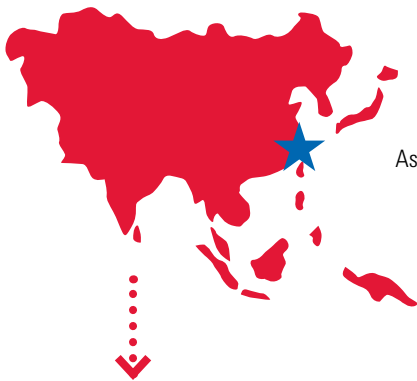

Asia Pacific headquarters set up in Shanghai

2006

2005

ARMOR® Band Saw Blades added to the product line

LENOX Gold® Bi-metal Utility Blade and Knife added to the product line

2004

2007

Snips, and Q Performance Solution™ Band Saw Blades added to the product line

LENOX T2™ Technology recip blades.

2008

Bi-Metal Drilling technology added to product line

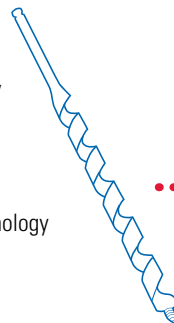

2009

HACKMAN®
WORLD TOUR 2009

Q88™ Band Saw Blade launched in Asia



LENOX's "The Blade in the Plaid Box" airplane flies from Portland, ME to Daytona, FL dropping circulars as it passes over large cities

1921

1952

A second plant was built on Chestnut Street, East Longmeadow, MA

LENOX began manufacturing Band Saw Blades at the East Longmeadow facility

1961



1959

Hole Saws added to product line

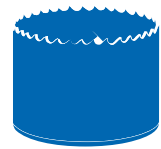

Hacksaw Frames and Carbide Band Saw Blades added to the product line

1985

1986

LENOX VARI-BIT® added to the product line

LENOX enters the Latin American Market

1987



1998

LENOX purchases a local Hand Hacksaw and Utility Knife Blade manufacturer and opened LENOX of Brazil



LENOX becomes the first company in the blade industry to achieve ISO 9001 certification

1996

1991

LENOX Self-Feed Bits added to the product line



2010

2011

Bi-Metal SPEED SLOT® Hole Saw



2015
100 YEAR
ANNIVERSARY





POWER ***TOOL***
ACCESSORIES

4,2mm
BI-METAL

LENOX®





DEMOLITION
Carbide Tipped Wood

T2™ RECIPROCATING SAW BLADES

LENOX <i>Gold</i> ®	14, 15
<i>LAZER</i> ®	16
Demolition	17
Bi-metal.....	18, 19
LENOX <i>DIAMOND</i> ™ & Carbide Grit	20
Carbide Tipped, Fleam Ground, Pallet Dismantling .	21
Reciprocating Saw Blade Kits	22
Blade, TPI & Blade Length Selection Guides	23
Cross Reference Chart	24, 25
<i>MASTER-BAND</i> ™ & <i>WOLF-BAND</i> ® Portable Bands...	26



LENOX Gold® RECIPROCATING SAW BLADES

Longest Lasting Blade. Ever.

EXTENDED BLADE LIFE

T2™ Technology and precision applied titanium coating help dissipate heat making blades last longer

FASTER CUTS

Titanium coating makes teeth more wear resistant so they stay sharp for quicker cuts

LONGER BLADE LIFE AND VERSATILITY

T2 technology's patented tooth design delivers longer blade life and enables faster cutting in the widest array of cutting applications



















Wood

Metal

















Demolition

LAZER® Extreme Metal

LENOX *Gold* RECIPROCATING SAW BLADES (CONTINUED)

	TPI	LENGTH X WIDTH X THICKNESS		5-PACK PROD NO	25-PACK PROD NO	APPLICATION
		IN	MM			
WOOD	6	6 x 7/16 x .050	152 x 11 x 1.3	21063676GRC	—	
	6	6 x 3/4 x .050	152 x 19 x 1.3	21060656GR	21074B656GR	
	6	9 x 3/4 x .050	229 x 19 x 1.3	21062956GR	21076B956GR	
	6	12 x 3/4 x .050	305 x 19 x 1.3	21061156GR	21075B156GR	
METAL	10	6 x 3/4 x .035	152 x 19 x .9	21064610GR	21078B610GR	
	10	8 x 3/4 x .050	203 x 19 x 1.3	21065810GR	21079B810GR	
	14	4 x 3/4 x .035	102 x 19 x .9	21066414GR	21080B414GR	
	14	6 x 3/4 x .035	152 x 19 x .9	21067614GR	21081B614GR	
	18	4 x 3/4 x .035	102 x 19 x .9	21068418GR	21082B418GR	
	18	6 x 3/4 x .035	152 x 19 x .9	21069618GR	21083B618GR	
	18	8 x 3/4 x .035	203 x 19 x .9	21070818GR	21084B818GR	
	24	4 x 3/4 x .035	102 x 19 x .9	21071424GR	—	
	24	6 x 3/4 x .035	152 x 19 x .9	21072624GR	21086B624GR	
	24	8 x 3/4 x .035	203 x 19 x .9	21073824GR	21087B824GR	
DEMOLITION	6	6 x 1 x .062	152 x 22 x 1.6	210886066GR	21220B6066GR	
	6	9 x 1 x .062	229 x 22 x 1.6	21090966GR	21222B966GR	
	6	12 x 1 x .062	305 x 22 x 1.6	21091106GR	21223B106GR	
	10	9 x 1 x .062	229 x 22 x 1.6	21089960GR	21221B960GR	
EXTREME METAL CUTTING	8	6 x 1 x .042	152 x 25 x 1.07	210926108GR	—	
	8	9 x 1 x .042	229 x 25 x 1.07	210969108GR	—	
	10	6 x 1 x .042	152 x 25 x 1.07	210936110GR	21225B6110GR	
	10	9 x 1 x .042	229 x 25 x 1.07	210979110GR	21229B9110GR	
	10	12 x 1 x .042	305 x 25 x 1.07	2110012110GR	21237B12110GR	
	14	6 x 1 x .042	152 x 25 x 1.07	210946114GR	21226B6114GR	
	14	9 x 1 x .042	229 x 25 x 1.07	210989114GR	21235B9114GR	
	14	12 x 1 x .042	305 x 25 x 1.07	2110112114GR	21238B12114GR	
	18	6 x 1 x .042	152 x 25 x 1.07	210956118GR	21227B6118GR	
	18	9 x 1 x .042	229 x 25 x 1.07	210999118GR	21236B9118GR	
18	12 x 1 x .042	305 x 25 x 1.07	2110212118GR	21239B12118GR		

ICON REFERENCE CHART

WOOD	NAIL-EMBEDDED WOOD	CONTOUR WOOD	PLASTIC	THICK METAL	MEDIUM METAL	THIN METAL	NON-FEROUS METAL
							
DEMOLITION	FIRE & RESCUE	PLASTER & DRYWALL	CAST IRON	CEMENT BOARD	TILE	ABRASIVES	NATURAL STONE
							



PLUNGE CUTTING WOOD BLADE

Patent pending plunge cutting tooth design prevents blade from walking to deliver faster, easier plunge cuts



LAZER[®] RECIPROCATING SAW BLADES

Best for Heavy Metal Cutting

FAST AND EASY HEAVY METAL CUTTING

T2 technology's patented tooth design delivers longer blade life and enables faster cutting

OPTIMIZED FOR HIGHER PERFORMANCE

Reinforced tooth design ensures higher performance in the most demanding jobs

STRAIGHT CUTS

Wider than conventional blades, this blade cuts straighter



TPI	LENGTH X WIDTH X THICKNESS		2-PACK PROD NO	5-PACK PROD NO	25-PACK PROD NO	50-PACK PROD NO	APPLICATION STRUCTURAL
	IN	MM					
8	6 x 1 x .042	152 x 25 x 1.07	—	201926108R	20196B6108R	—	Structural Steels greater than 3/16"
8	9 x 1 x .042	229 x 25 x 1.07	—	201939108R	20195B9108R	—	
8	12 x 1 x .042	305 x 25 x 1.07	—	2019412108R	20197B12108R	—	
10	6 x 1 x .042	152 x 25 x 1.07	24901T6110R	201706110R	20171B6110R	—	Structural Steels and All Metals 3/16"–1/2"
10	9 x 1 x .042	229 x 25 x 1.07	24905T9110R	201769110R	20177B9110R	—	
10	12 x 1 x .042	305 x 25 x 1.07	24909T12110R	2018212110R	20183B12110R	—	
14	6 x 1 x .042	152 x 25 x 1.07	24902T6114R	201726114R	20173B6114R	227640SB6114R	Structural Steels and All Metals 3/32"–3/8"
14	9 x 1 x .042	229 x 25 x 1.07	24906T9114R	201789114R	20179B9114R	227660SB9114R	
14	12 x 1 x .042	305 x 25 x 1.07	24910T12114R	2018412114R	20185B12114R	—	
18	6 x 1 x .042	152 x 25 x 1.07	24903T6118R	201746118R	20175B6118R	227650SB6118R	Structural Steels and All Metals 1/16"–1/4"
18	9 x 1 x .042	229 x 25 x 1.07	24907T9118R	201809118R	20181B9118R	227670SB9118R	
18	12 x 1 x .042	305 x 25 x 1.07	24911T12118R	2019012118R	20191B12118R	—	

DEMOLITION RECIPROCATING SAW BLADES

Best for Demolition and Nail-Embedded Wood

DEMOLITION JOBS ARE EASIER

T2 technology's patented tooth design delivers longer blade life and enables faster cutting

MAXIMUM DURABILITY

The tallest blade on the market prevents bending and provides maximum control in the toughest demolition applications

AGGRESSIVE CUTS EVEN IN TIGHT SPACES

Each blade has an optimized blade geometry including an aggressive tang angle and tapered blade shape to allow for cutting in tight areas



TPI	LENGTH X WIDTH X THICKNESS		2-PACK	5-PACK	25-PACK	50-PACK	APPLICATION
	IN	MM	PROD NO	PROD NO	PROD NO	PROD NO	
6	6 x 1 x .062	152 x 22 x 1.6	205126066R	203706066R5	20514B6066R	—	
6	9 x 1 x .062	229 x 22 x 1.6	20598966R	20371966R5	20523B966R	227630SB966R	
6	12 x 1 x .062	305 x 22 x 1.6	20500106R	20373106R5	20485B106R	—	
10	9 x 1 x .062	229 x 22 x 1.6	20597960R	20372960R5	20524B960R	227620SB960R	



BI-METAL RECIPROCATING SAW BLADES

Long Lasting, Fast Cutting and Versatile

LONGER BLADE LIFE AND VERSATILITY

T2 technology's patented tooth design delivers longer blade life and enables faster cutting in the widest array of cutting applications

MINIMIZE FRICTION AND HEAT BUILD UP

Engineered for performance this blade can handle the widest variety of metal materials providing an optimized cutting experience



TPI	LENGTH X WIDTH X THICKNESS		1-PACK PROD NO	5-PACK PROD NO	25-PACK PROD NO	50-PACK PROD NO	APPLICATION
	IN	MM					
4	6 x 3/4 x .050	152 x 19 x 1.3	20574S634R	20575634R	—	—	
6	4 x 3/4 x .050	102 x 19 x 1.3	—	20449456RP	—	—	
6	6 x 3/4 x .050	152 x 19 x 1.3	20571S636RP	20570636RP	20497B636RP	—	
6	6 x 3/4 x .035	152 x 19 x .9	20559S606R	20560606R	20492B606R	—	
6	6 x 7/16 x .050	152 x 11 x 1.3	20557S676RC	20556676RC	—	—	
6	6 x 3/4 x .050	152 x 19 x 1.3	20573S656R	20572656R	20530B656R	227500SB656R	
6	9 x 3/4 x .050	229 x 19 x 1.3	20587S956R	20582956R	20558B956R	227520SB956R	
6	12 x 3/4 x .050	305 x 19 x 1.3	20586S156R	20585156R	20495B156R	227550SB156R	
10	6 x 3/4 x .035	152 x 19 x .9	20561S610R	20562610R	20493B610R	227610SB610R	
10	8 x 3/4 x .050	203 x 19 x 1.3	20581S810R	20580810R	20590B810R	227530SB810R	
10/14	6 x 3/4 x .050	152 x 19 x 1.3	20592650R*	20374650R5	20515B650R	—	
10/14	8 x 3/4 x .050	203 x 19 x 1.3	—	20577850R	20535B850R	—	
10/14	12 x 3/4 x .050	305 x 19 x 1.3	20584S110R	20583110R	20491B110R	227580SB110R	
10/14	6 x 3/4 x .035	152 x 19 x .9	—	12129635R	—	—	
10/14	8 x 3/4 x .035	203 x 19 x .9	—	12130835R	—	—	

* This item is a 2-pack

BI-METAL RECIPROCATING SAW BLADES (CONTINUED)



TPI	LENGTH X WIDTH X THICKNESS		1-PACK PROD NO	5-PACK PROD NO	25-PACK PROD NO	50-PACK PROD NO	APPLICATION
	IN	MM					
14	3-5/8 x 5/16 x .035	92 x 8 x .9	—	20520314RC	—	—	
14	4 x 3/4 x .035	102 x 19 x .9	20551S414R	20550414R	20488B414R	227600SB414R	
14	6 x 3/4 x .035	152 x 19 x .9	20565S614R	20564614R	20494B614R	227560SB614R	
14	8 x 3/4 x .035	203 x 19 x .9	—	21519814R	1855567	1855570	
14	9 x 3/4 x .050	225 x 19 x 1.3	205119514R*	—	—	—	
18	3-5/8 x 5/16 x .035	92 x 8 x .9	20522S318RC	20521318RC	—	—	
18	4 x 3/4 x .035	102 x 19 x .9	20553S418R	20552418R	20489B418R	227590SB418R	
18	6 x 3/4 x .035	152 x 19 x .9	20567S618R	20566618R	20529B618R	227510SB618R	
18	8 x 3/4 x .035	203 x 19 x .9	20563S818R	20578818R	20487B818R	227540SB818R	
18	12 x 3/4 x .035	305 x 29 x .9	—	21510118R	21511B118R	—	
24	4 x 3/4 x .035	102 x 19 x .9	20555S424R	20554424R	20490B424R	—	
24	6 x 3/4 x .035	152 x 19 x .9	20569S624R	20568624R	20496B624R	227570SB624R	
24	8 x 3/4 x .035	203 x 19 x .9	—	20579824R	—	—	

* This item is a 2-pack



LENOX DIAMOND™ RECIPROCATING SAW BLADES

Cuts Cast. Fast.

LASTS LONGER

Nickel alloy-brazed diamond particles maintain sharpness to keep cutting after conventional carbide grit fails

CUTS 3X FASTER*

A narrow kerf design enables thinner, faster cuts

STRAIGHT, CLEAN CUTS

Unlike bulky snap cutters which crush pipes and leave ragged, uneven cuts, LENOX DIAMOND cuts clean. Durable chrome alloy backing steel provides extra stability

**Speed measured cutting 4" cast iron pipe at maximum speed vs. the leading competitor*



LENGTH X WIDTH X THICKNESS		1-PACK	APPLICATION
IN	MM	PROD NO	
8 x 3/4 x .040	203 x 19 x 1	10833800RDG	Cast Iron, Tile, Brick and Natural Stone
DOUBLE TANG			
9 x 3/4 x .042	225 x 19 x 1.07	1766338	
11 x 3/4 x .042	275 x 19 x 1.07	1766356	

CARBIDE GRIT RECIPROCATING SAW BLADES

For Cutting Non-Metallic Materials

HIGH PERFORMANCE IN ABRASIVE MATERIALS

Cuts through tough materials that resist chip-forming, including ceramics, pipe, man-made stone, brick, marble and more

SMOOTH, QUICK CUTS

Uniformly applied, durable carbide grit particles on a flexible blade provide fast cuts without snagging or binding



LENGTH X WIDTH X THICKNESS		2-PACK	APPLICATION	
IN	MM	PROD NO		GRIT
6 x 3/4 x .032	152 x 19 x .8	20505600RG	Medium	
8 x 3/4 x .040	203 x 19 x 1	20576800RG	Medium	
10 x 3/4 x .050	254 x 19 x 1.3	20506100RG	Medium	



CARBIDE TIPPED RECIPROCATING SAW BLADES

Engineered to Cut the Toughest Materials

VERSATILE AND EFFECTIVE

Cuts tough materials including cement board, cast aluminum, pressure treated wood, engineered lumber, and more

ENGINEERED FOR FASTER PERFORMANCE

Triple chip tooth design cuts 25% faster than standard carbide blades and provides exceptional fatigue resistance



TPI	LENGTH X WIDTH X THICKNESS		1-PACK	PROFILE	APPLICATION
	IN	MM	PROD NO		
3	8 x 3/4 x .050	203 x 19 x 1.3	205998535RCT	Straight	Fiberglass, Particle Board, Pressure-Treated Woods, Plywood, Cast Aluminum
6	6 x 3/4 x .050	152 x 19 x 1.3	205966565RCT	Straight	
6	6 x 3/4 x .050	152 x 19 x 1.3	205956563RCT	Contour	



EXTRA SHARP FLEAM GROUND RECIPROCATING BLADES

Fast, Clean Cutting in Wood or Plastic

BI-METAL CONSTRUCTION

Durable and flexible to survive nail strikes

FLEAM GROUND TOOTH FORM

Fast, clean wood cutting

IDEAL FOR CLEAN WOOD, PLASTIC PIPE AND TREE PRUNING



TPI	LENGTH X WIDTH X THICKNESS		5-PACK	APPLICATION
	IN	MM	PROD NO	
6	6 x 3/4 x .050	152 x 19 x 1.3	121016W6R	Clean Wood, Plastics, Pruning
6	9 x 3/4 x .050	229 x 19 x 1.3	121029W6R	



PALLET DISMANTLING RECIPROCATING SAW BLADES

High Performance Cutting for Pallet Refurbishing

ENGINEERED FOR STRENGTH

Specially treated to enhance performance and withstand nail strikes to keep cutting fast

LONG CUTTING LIFE

Patented tooth design and a rounded nose provide long blade life and enable easy access in tight spots



TPI	LENGTH X WIDTH X THICKNESS		250-PACK	APPLICATION
	IN	MM	PROD NO	
10	8 x 3/4 x .035	203 x 19 x .9	10729810RPC	Dismantling Pallets
10	10 x 3/4 x .035	254 x 19 x .9	107301010RPC	



RECIPROCATING SAW BLADE KITS



121439KPE
9 PIECE
GENERAL PURPOSE KIT
 Includes Storage Case

QTY	PROD NO	TPI	LENGTH X WIDTH X THICKNESS	
			IN	MM
2	656R	6	6 x 3/4 x .050	152 x 19 x 1.3
2	624R	24	6 x 3/4 x .035	152 x 19 x .9
2	818R	18	8 x 3/4 x .035	203 x 19 x .9
2	810R	10	8 x 3/4 x .050	203 x 19 x 1.3
1	960R	10	9 x 7/8 x .062	229 x 22 x 1.6



1214412RKD
12 PIECE
DEMOLITION KIT
 Includes Storage Case

QTY	PROD NO	TPI	LENGTH X WIDTH X THICKNESS	
			IN	MM
3	6066R	6	6 x 7/8 x .062	150 x 22 x 1.6
3	6114R	14	6 x 1 x .042	150 x 25 x 1.1
2	9114R	14	9 x 1 x .042	225 x 25 x 1.1
2	966R	6	9 x 7/8 x .062	225 x 22 x 1.6
2	960R	10	9 x 7/8 x .062	225 x 22 x 1.6



20502546A
5 PIECE
4" AND 6" BLADE ASSORTMENT

QTY	PROD NO	TPI	LENGTH X WIDTH X THICKNESS	
			IN	MM
1	414R	14	4 x 3/4 x .035	102 x 19 x .9
1	418R	18	4 x 3/4 x .035	102 x 19 x .9
1	614R	14	6 x 3/4 x .035	152 x 19 x .9
1	618R	18	6 x 3/4 x .035	152 x 19 x .9
1	656R	6	6 x 3/4 x .050	152 x 19 x 1.3



1839466
5 PIECE
METAL CUTTING KIT

QTY	PROD NO	TPI	LENGTH X WIDTH X THICKNESS	
			IN	MM
3	618R	18	6 x 3/4 x .035	152 x 19 x .9
2	818R	18	8 x 3/4 x .035	203 x 19 x .9



1839467
5 PIECE
WOOD CUTTING KIT

QTY	PROD NO	TPI	LENGTH X WIDTH X THICKNESS	
			IN	MM
3	656R	6	6 x 3/4 x .050	52 x 19 x 1.3
2	956R	6	9 x 3/4 x .035	29 x 19 x 1.3



1839465
5 PIECE
DEMOLITION KIT

QTY	PROD NO	TPI	LENGTH X WIDTH X THICKNESS	
			IN	MM
1	6066R	6	6 x 1 x .062	150 x 25 x 1.6
1	6114R	14	6 x 1 x .042	150 x 25 x 1.1
1	9114R	14	9 x 1 x .042	225 x 25 x 1.1
1	966R	6	9 x 1 x .062	225 x 25 x 1.6
1	960R	10	9 x 1 x .062	225 x 25 x 1.6



1073415RKG
15 PIECE KIT
 Includes Storage Case

QTY	PROD NO	TPI	LENGTH X WIDTH X THICKNESS	
			IN	MM
5	614R	14	6 x 3/4 x .035	152 x 19 x .9
5	618R	18	6 x 3/4 x .035	152 x 19 x .9
5	656R	6	6 x 3/4 x .050	152 x 19 x 1.3

RECIPROCATING SAW BLADE SELECTION GUIDE

	WOOD	NAIL-EMBEDDED WOOD	NON-FERROUS METAL	DEMOLITION	FIRE & RESCUE	PLASTICS & COMPOSITES	THICK METAL	MEDIUM METAL	THIN METAL	DRYWALL/ PLASTER	CEMENT BOARD	CAST IRON	ABRASIVES
BEST	LENOX GOLD [®]									CARBIDE TIPPED	LENOX DIAMOND™		
BETTER	BI-METAL	LAZER [®]	BI-METAL	LAZER			BI-METAL	LENOX DIAMOND	CARBIDE GRIT				
GOOD	—	BI-METAL	—	BI-METAL			—	CARBIDE GRIT	—				

TEETH PER INCH SELECTION GUIDE

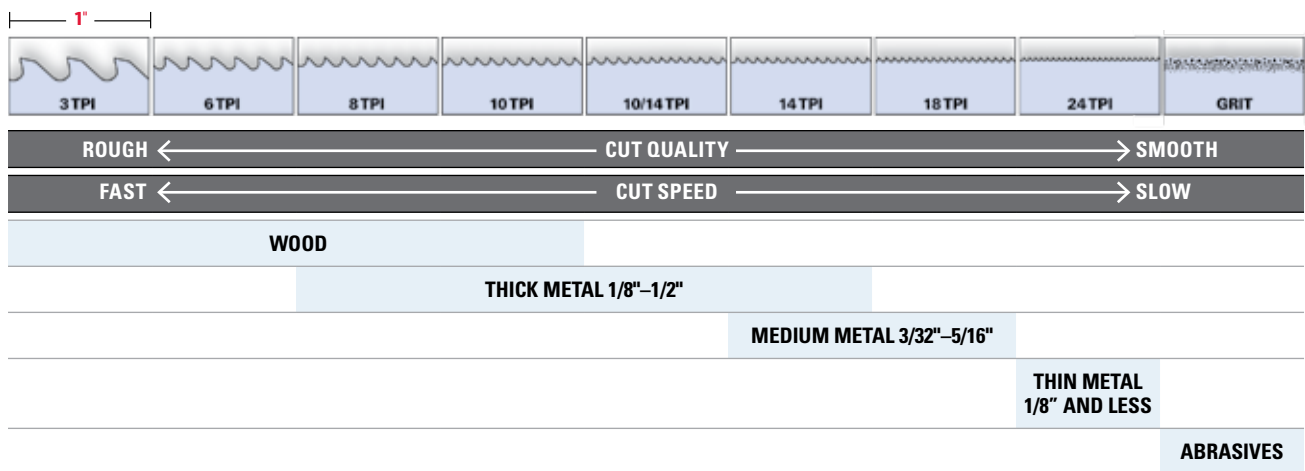

BLADE LENGTH SELECTION GUIDE

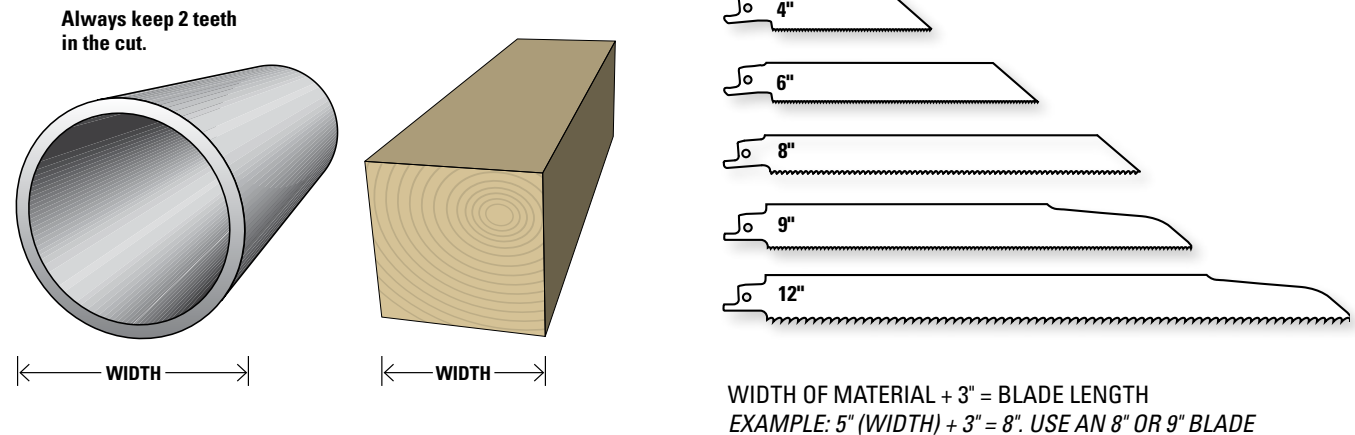

RECIPROCATING SAW BLADES CROSS REFERENCE CHART

	TPI	LENGTH		DESC	SHAPE	BOSCH® / BOSCH EDGE	DEWALT®	MILWAUKEE®/ MILWAUKEE ICE	MK MORSE®
		IN	MM						
LENOX Gold®	6	6	152	676GRC					
	6	6	152	656GR					
	6	6	152	6066GR					
	6	9	229	956GR					
	6	9	229	966GR					
	6	12	305	156GR					
	6	12	305	106GR					
	8	6	152	6108GR					
	8	9	229	9108GR					
	10	6	152	610GR					
	10	6	152	6110GR					
	10	8	203	810GR					
	10	9	229	9110GR					
	10	12	305	12110GR					
	14	4	102	414GR					
	14	6	152	614GR					
	14	6	152	6114GR					
	14	9	229	9114GR					
	14	12	305	12114GR					
	18	4	102	418GR					
	18	6	152	618GR					
	18	6	152	6118GR					
	18	8	203	818GR					
	18	9	229	9118GR					
18	12	305	12118GR						
24	4	102	424GR						
24	6	152	624GR						
24	8	203	824GR						
LENOX DIAMOND™	Grit	9	225	800DTDG					—
	Grit	11	275	100DTDG					—
LAZER®	8	6	152	6108R		RSM6X2, RSM7X2 RESM6X2	—	5700, 5701	—
	8	9	229	9108R		RSM9X2, RESM9X2	—	5705, 5706	—
	8	12	305	12108R		RSM12X2	—	5710, 5711	—
	10	6	152	6110R		S123XF, RPRM6, SAPP6, RESM6X2	—	5712, 4712	RB66210, RBFR66210W, RBMC64210
	10	9	229	9110R		RESM9X2	—	5713, 4713	RB1010, RBMC95010
	10	12	305	12110R		RAP1210	—	5714	RB1210, RB126210, RBFR126210W, RBMC125010
	14	6	152	6114R		RCM6X2, RECM6X2	DWA4186	5782, 4782	RBFR6214W, RBMC64214
	14	9	229	9114R		RCM9X2, RECM9X2	DWA4188	5787, 5795, 4788	RBFR96214W, RBMC95014
	14	12	305	12114R		RCM12X2	DWA4112	5794	RB1214, RBFR126214W, RBMC125014, RBU10514
	18	6	152	6118R		RCTM6X2, RECM6X2	—	5784, 4784	RB65018, RBMC64218
	18	9	229	9118R		RECM9X2	—	5788, 5798, 4788	RBMC95018
	18	12	305	12118R		—	—	5789	RBMC125018



	TPI	LENGTH		DESC	SHAPE	BOSCH® / BOSCH EDGE	DEWALT®	MILWAUKEE®/ MILWAUKEE ICE	MK MORSE®
		IN	MM						
DEMOLITION	6	6	152	6066R		RDN6V	DW4862	5021, 5701	RB66206C
	6	9	229	966R		RDN9V	DW4863	5026	RB96206
	6	12	305	106R		RDN12V	DW4806, DW4806B, DW4845, DW4877	5027	RB126206
	10	9	229	960R		REDM6X2, REDM9X2	—	—	RB96210, RBFR96210W
STANDARD BI-METAL	4	6	152	634R		S234XF	DW4801	—	RC603
	6	4	102	456RP		—	—	5052	RB606
	6	6	152	636RP		RDW66	—	—	RB606P
	6	6	152	656R		RDN6V, RHN66, RW66, RHN96, RN96, RN126	DW4802, DW4802B, DW4847, DW4848B, DW4876	5031, 5035	RB63506, RB65006, RB65058, RC606
	6	6	152	676RC		—	DW4816	5041	RB65006C
	6	6	152	606R		—	DW4850	5012, 5015	RB606ST, RB658, RC606ST
	6	9	229	956R		RPRW8, RDN9V, RSN9V, RHN96, RW96	DW4803, DW4803B, DW4848	5016, 5036	RB93506, RB95006, RC905, RC906
	6	12	305	156R		RHN126, RW126	DW4804, DW4804B, DW4849	5017, 5037	RB123506, RB125006, RB125058ST, RB125058, RC1206
	10	6	152	610R		RPRAP6, RAP610	DW4806, DW4806B, DW4845, DW4877	4091, 5090, 5091, 5092	RB610, RB65010, RBMC610, RC610
	10	8	203	810R		RPRAP8, RAP810, RAP910	DW4865B	5093, 5175	RB810, RB8501014, RBMC810
	10/14	6	152	635R		—	—	—	—
	10/14	6	152	650R		RD6V, RRD6V, SRD6, RAP6V	DW4864, DW4864B	—	RB61014, RB6501014, RB6501014T
	10/14	8	203	835R		—	—	5193	—
	10/14	8	203	850R		RD9V, RRD9V, SRD9, RAP9V RD12V, RRD12V, SRD12, RFM10V, SHMF10, RAP12V	DW4865	5193	RB81014, RB8501014
	10/14	12	305	110R		—	DW4838	5094, 5194	RB121014, RB12501014, RB12501014ST, RB12501014
	14	3-5/8	92	314RC		—	DW4814	5161, 5162	—
	14	4	102	414R		—	DW4807, DW4807B	5181	RB414, RH414
	14	6	152	614R		RM614	DW4808, DW4808B	5182, 5282, 4182	RB614, RB65014, RBMC614, RH614
	14	8	203	814R		RM914	—	5187, 4187	RB814, RBMC814
	14	9	225	9514R		—	—	—	—
	18	3-5/8	92	318RC		RSM418	—	5163	RB318S, RH318S, RH324S
	18	4	102	418R		RS418	DW4810	5183	RB418, RH318, RH418
	18	6	152	618R		RS618, RM618	DW4811, DW4811B, DW4878	5184, 5284, 4184	RB618, RBMC618, RH618
	18	8	203	818R		RM918	DW4921	5188, 4188	RB814, RB818, RBMC818
	18	12	305	118R		RM1218	—	5189, 4189	RB1018, RB1218, RBMC1218
	24	4	102	424R		S518A, S518AF, S518AF-100, S518EF, S518G	DW4812	5185	RB424, RH424
	24	6	152	624R		RM624	DW4815	5186, 5286, 4186	RB624, RBMC624, RH624
	24	8	203	824R		RM924	—	—	—
LENOX™ DIAMOND™	Grit	8	203	800DRDG		RCB8DG	—	1450	—
CARBIDE GRIT	Grit	6	152	600RG		RCB6G	DW4844	1400, 1410, 1420	RTCG4, RTCG6
	Grit	8	203	800RG		RCB9G	DW4843	1430	RTCG8
	Grit	10	254	100RG		—	—	—	RTCT6065
CARBIDE TIPPED	3	8	203	8535RCT		—	—	—	RTCT6065
	6	6	152	6565RCT		—	—	—	RCFP66
	6	6	152	6563RCT		—	—	—	—
FLEAM GROUND	6	6	152	6W6R		—	—	5015	—
	6	9	229	9W6R		—	—	5016	—



MASTER-BAND™ BLADES

Maximum Performance for Portable Band Saws

ENHANCED BEAM STRENGTH

Specially treated bands of .023 and .025 thicknesses offer increased blade strength, reducing deflection and twisting of blades during severe cutting conditions

SHATTER RESISTANT

Bi-metal blades bend and resist breaking and extend blade life

LONG LASTING

LENOX TUFF TOOTH design reinforces tooth for longer blade life



TPI	LENGTH X WIDTH X THICKNESS		EDGE MATERIAL	3-PACK PROD NO	25-PACK PROD NO	APPLICATION
	IN	MM				
10/14	44-7/8 x 1/2 x .023	1140 x 12.7 x .6	Matrix	8011438EW1014	9403B38EW1014	1/4" & larger, most metals
14	44-7/8 x 1/2 x .023	1140 x 12.7 x .6	Matrix	8011538EW14	9404B38EW14	3/16"–3/8," most metals
14/18	44-7/8 x 1/2 x .023	1140 x 12.7 x .6	Matrix	8011238EW1418	9407B38EW1418	1/8"–5/16," most metals
18	44-7/8 x 1/2 x .023	1140 x 12.7 x .6	Matrix	8011638EW18	9405B38EW18	3/32"–1/4," most metals
24	44-7/8 x 1/2 x .023	1140 x 12.7 x .6	Matrix	8011738EW24	9406B38EW24	up to 1/8," most metals
8/12	44-7/8 x 1/2 x .025	1140 x 12.7 x .6	M42	80143385EW812	9398B385EW812	3/8"–1/2," metals, including stainless steel
10/14	44-7/8 x 1/2 x .025	1140 x 12.7 x .6	M42	80144385EW1014	9399B385EW1014	1/4" & larger, metals, including stainless steel
14	44-7/8 x 1/2 x .025	1140 x 12.7 x .6	M42	80145385EW14	9400B385EW14	3/16"–3/8," metals, including stainless steel
14/18	44-7/8 x 1/2 x .025	1140 x 12.7 x .6	M42	80142385EW1418	9401B385EW1418	1/8"–5/16," metals, including stainless steel
18	44-7/8 x 1/2 x .025	1140 x 12.7 x .6	M42	82310385EW18	9402B385EW18	3/32"–1/4," metals, including stainless steel

WOLF-BAND® BLADES

Professional Performance and Exceptional Value

LONG LASTING

High speed steel teeth provide a strong, long lasting cutting edge

SHATTER RESISTANT

Bi-metal blades bend and resist breaking and extend blade life

EXCEPTIONAL VALUE

Professional performance and competitive pricing provide extraordinary cost-per-cut value



TPI	LENGTH X WIDTH X THICKNESS		1-PACK PROD NO	5-PACK PROD NO	25-PACK PROD NO	APPLICATION
	IN	MM				
10/14	44-7/8 x 1/2 x .020	1140 x 12.7 x .5	3842838PW10141	8009838PW10145	3842338PW1014	1/4" & larger
14	44-7/8 x 1/2 x .020	1140 x 12.7 x .5	3842938PW141	8010738PW145	3842438PW14	3/16"–3/8"
14/18	44-7/8 x 1/2 x .020	1140 x 12.7 x .5	3843038PW14181	8009938PW14185	3842738PW1418	1/8"–5/16"
18	44-7/8 x 1/2 x .020	1140 x 12.7 x .5	3843138PW181	8010838PW185	3842538PW18	3/32"–1/4"
24	44-7/8 x 1/2 x .020	1140 x 12.7 x .5	3843238PW241	8010938PW245	3842638PW24	up to 1/8"
COMPACT PORTABLE BAND SAW BLADES						
10/14	35-3/8 x 1/2 x .020	900 x 13 x .50	1786692	1786673	1786678	1/4" (6mm) & larger
14	35-3/8 x 1/2 x .020	900 x 13 x .50	1786693	1786674	1786679	3/16" (5mm)–3/8" (10mm)
18	35-3/8 x 1/2 x .020	900 x 13 x .50	1786695	1786675	1786680	3/32" (2mm)–1/4" (6mm)
24	35-3/8 x 1/2 x .020	900 x 13 x .50	1786660	1786676	1786761	up to 1/8" (3,2mm)



JIG SAW BLADES

Bi-metal.....	28
High Carbon Steel & LENOX <i>DIAMOND</i> [™] Grit	29
Carbide Grit, Jig Saw Blade Sets & Air Saw Blades	30
Metal Cutting Circular Saw Blades.....	31



BI-METAL JIG SAW BLADES

Ideal for Woodworking and Metal Cutting

PRECISION CUTTING

Super sharp to cut fast without deflection

SMOOTH FINISH

Ground to precision sharpness for straight cuts and a smooth finish

IDEAL FOR WOODWORKING

Designed for optimal performance in wood cutting, including hardwoods

SHATTER RESISTANT

Bi-metal technology flexes and resists breaking and extends blade life



	TPI	LENGTH		T-SHANK	PROCESS	2-PACK PROD NO	5-PACK PROD NO	25-PACK PROD NO	APPLICATION	COMPETITIVE CROSS REFERENCE BOSCH®
		IN	MM							
WOOD CUTTING	6	4	102		Milled	20305BT406S	—	20812B406S	Fast, rough cut	T144DF
	6	4	102		Ground	20315BT456S	20850F456S	20781B456S	Very fast, clean cut	
	6	6	102		Milled	20309BT686S			Fast cut	
	10	4	102		Milled	20306BT410S	20851F410S	20813B410S	Fast, nail-embedded wood	T127DF
	10	4	102		Ground	20313BT450S	20842F450S	20814B450S	Clean, smooth cut	T101BF
	10D	4	102		Ground	20314BT450SR	20843F450SR	20782B450SR	Down cut	T101BRF
	20	3-1/4	82.5		Ground	20311BT320SC	—	—	Scroll cut, laminates	T101AOF
METAL CUTTING	14	3-5/8	92.1		Milled	20301BT314S	20832F314S	20815B314S	Thick metal	T188BF/T118B
	18	3-5/8	92.1		Milled	20302BT318S	20834F318S	20816B318S	Medium metal	T118EF
	18	5-1/4	133.4		Milled	20308BT518S	20854F518S	—	Medium metal	T318B
	24	3-5/8	92.1		Milled	20303BT324S	20835F324S	20817B324S	Thin metal	T118A/T118AF
	32	3-5/8	92.1		Milled	20803BT332S	—	—	Very thin metal	T118G
WOOD CUTTING	6	4	102		Milled	20329BT486J	20652F486J	—	Fast, rough cut	U111DF
	6	4	102		Ground	20337BT456J	—	20784B456J	Very fast, clean cut	U101DF
	6	6	102		Milled	20331BT686J	—	—	Fast cut	—
	10	4	102		Milled	20328BT480J	20654F480J	—	Fast, nail-embedded wood	—
	10	4	102		Ground	20335BT450J	20648F450J	20702B450J	Clean, smooth cut	U101BF
	10D	4	102		Ground	20336BT450JR	—	20791B450JR	Down cut	—
	20	2-3/4	69.9		Ground	20333BT320JC	—	—	Scroll cut, laminates	U1A0F
	METAL CUTTING	14	3-5/8	92.1		Milled	20321BT314J	20641F314J	20705B314J	Thick metal
18		3-5/8	92.1		Milled	20322BT318J	20643F318J	20706B318J	Medium metal	U118E/U118EF
18		5-1/4	133.4		Milled	20330BT518J	—	—	Medium metal	—
24		3-5/8	92.1		Milled	20323BT324J	20644F324J	20707B324J	Thin metal	U118A/U118AF
32		3-5/8	92.1		Milled	20609BT332J	—	—	Very thin metal	U118G/U118GF

BOSCH is a registered trademark of Robert Bosch Tool Corporation

HIGH CARBON STEEL JIG SAW BLADES

Ideal for Woodworking

PRECISION CUTTING

Super sharp to cut fast without deflection

SMOOTH FINISH

Ground to precision sharpness for straight cuts and a smooth finish

IDEAL FOR WOODWORKING

Designed for optimal performance in wood cutting, including hardwoods

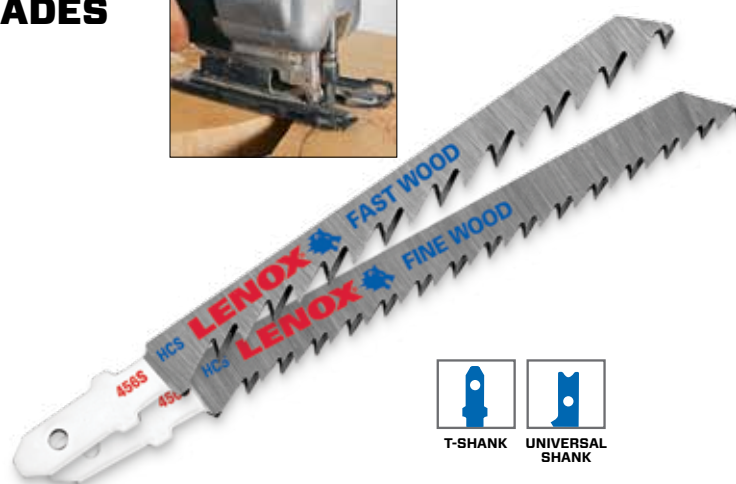

TPI	LENGTH		T-SHANK	PROCESS	2-PACK	5-PACK	25-PACK	APPLICATION	COMPETITIVE CROSS REFERENCE
	IN	MM			PROD NO	PROD NO	PROD NO		BOSCH®
6	4	102		Milled	20750CTS406S	20298CFS406S	—	Fast, rough cut	T111C
6	4	102		Ground	20751CT456S	20297CF456S	20292BC456S	Very fast, clean	T101D
6	3-5/8	92.1		Ground	20312CT416SC	—	—	Scroll cut	T244D
10	4	102		Ground	20752CT450S	20296CF450S	20291BC450S	Clean, smooth cut	T101B
10D	4	102		Ground	20753CT450SR	20295CF450SR	20290BC450SR	Down cut	T101BR
20	3-1/4	82.5		Ground	20754CT320SC	20299CF320SC	20294BC320SC	Scroll cut, laminates	T101A0

TPI	LENGTH		U-SHANK	PROCESS	2-PACK	5-PACK	25-PACK	APPLICATION	COMPETITIVE CROSS REFERENCE
	IN	MM			PROD NO	PROD NO	PROD NO		BOSCH®
6	4	102		Milled	20755CTS406J	—	—	Fast, rough cut	U111D
6	4	102		Ground	20756CT456J	—	20794BC456J	Very fast, clean cut	U101D
6	3-5/8	92.1		Ground	20334CT416JC	—	—	Scroll cut	U244D
10	4	102		Ground	20757CT450J	—	20795BC450J	Clean, smooth cut	U101B
10D	4	102		Ground	20758CT450JR	—	—	Down cut	U101BR
20	2-3/4	69.9		Ground	20759CT320JC	—	20797BC320JC	Scroll cut, laminates	U101A0

LENOX DIAMOND™ GRIT JIG SAW BLADE



TPI	LENGTH		T-SHANK	PROCESS	1-PACK	APPLICATION
	IN	MM			PROD NO	
Grit	3-1/2	88.9		Grit	12149	Ceramic Tile, Fiberglass



CARBIDE GRIT JIG SAW BLADES



TPI	LENGTH		SHAPE	PROCESS	2-PACK	5-PACK	APPLICATION	COMPETITIVE CROSS REFERENCE
	IN	MM	T-SHANK		PROD NO	PROD NO		BOSCH®
Grit	3-1/2	88.9		Grit	20300GT300S	20830F300SG	Ceramic Tile	T130RF3
U-SHANK								
Grit	3-1/2	88.9		Grit	20320GT300J	—	Ceramic Tile	—

BOSCH is a registered trademark of Robert Bosch Tool Corporation

JIG SAW BLADE SETS

Bi-Metal Sets



20868U743SA
7 PIECE T-SHANK
BI-METAL SET

456S, 450SR, 450S,
406S, 324S, 318S, 314S

VINYL POUCH



20606U743JA
7 PIECE U-SHANK
BI-METAL SET

456J, 450JR, 450J,
406J, 324J, 318J, 314J

VINYL POUCH

High Carbon Steel Sets



20764C543SA
5 PIECE T-SHANK
MULTI-PURPOSE SET

456S, 450S, 324S,
320SC, 318S

BLISTER PACK



20769C543JA
5 PIECE U-SHANK
MULTI-PURPOSE SET

456J, 450J, 324J,
320JC, 318J

BLISTER PACK

AIR SAW BLADES

Maximum Durability for Pneumatic Machine Cutting

SHATTER RESISTANT

Bi-metal blades bend and resist breaking and extend blade life

LONG LASTING

High speed steel teeth provide a strong, long lasting cutting edge



TPI	LENGTH X WIDTH X THICKNESS		5-PACK	25-PACK	APPLICATION
	IN	MM	PROD NO	PROD NO	
18	4 x 1/2 x .025	102 x 12.7 x .6	20426418T	20423B418T	For pneumatic machine cutting applications in automotive repair & sheet metal
24	4 x 1/2 x .025	102 x 12.7 x .6	20427424T	20424B424T	
32	4 x 1/2 x .025	102 x 12.7 x .6	20428432T	20425B432T	

METAL CUTTING CIRCULAR SAW BLADES

A Faster Way to Cut Metal™

EXTENDED LIFE

Titanium carbide tipped

Resists material build-up on teeth

CLEAN, COOL CUTS

Less burr than abrasive blades

No need for secondary grinding

Reduced material burning

MODIFIED TRIPLE CHIP GRIND

For added durability

RESHARPENABLE



	DIAMETER		PROD NO	TOOTH COUNT	RPM	ARBOR		APPLICATION
	IN	MM				IN	MM	
STEEL	5-3/8	135	21876ST538030CT	30	3500	—	20	Structurals Thick walled pipe Threaded rod Channel steel Plate Solid steel
	6-3/4	171	21878ST634040CT	40	5800	—	20	
	7	180	21879ST700038CT	38	4300	—	20	
	7-1/4	184	21881ST714040CT	40	5800	5/8	16	
	8	203	21884ST800050CT	50	5800	5/8	16	
	9	230	21885ST900048CT	48	5200	1	25.4	
	10	254	21886ST100052CT	52	5200	5/8	16	
	12	305	21888ST120060CT	60	1500	1	25.4	
	14	355	21891ST140080CT	80	1800	1	25.4	
THIN STEEL	6-1/2	165	21877TS612048CT	48	5800	5/8	16	Sheet metal Thin walled pipe Metal roofing Metal decking
	7	180	21880TS700068CT	68	4300	—	20	
	7-1/4	184	21883TS714068CT	68	5800	5/8	16	
	12	305	21890TS120080CT	80	1500	1	25.4	
	14	355	21893TS140090CT	90	1800	1	25.4	
ALUMINUM	7-1/4	184	21882AL714060CT	60	5800	5/8	16	Aluminum Copper Brass
	10	254	21887AL100080CT	80	5200	5/8	16	
	12	305	21889AL120080CT	80	4000	1	25.4	
	14	355	21892AL140080CT	80	3000	1	25.4	





HOLE SAWS

Bi-metal <i>SPEED SLOT</i> [®] Hole Saws	34, 35
<i>SNAP-BACK</i> [™] Arbors & Quick Change Extensions	36
Standard Arbors & Accessories	37
Bi-metal Kits	38, 39
Carbide Tipped & Kits	40
Carbide Grit & Kits	41
LENOX [®] <i>DIAMOND</i> [™]	42
Carbide Hole Cutters & <i>LENOX PROTOOL LUBE</i> [®]	43
<i>ONE TOOTH</i> [®] Rough Wood Hole Cutters	44
Carbide Grit Recessed Lighting & Hole Saw Selection Guide	45
Recommended Hole Saw RPM	46



BI-METAL SPEED SLOT® HOLE SAWS

Long Lasting, Fast Cutting and Versatile

PLUG REMOVAL AS EASY AS 1-2-3

SPEED SLOT features a staircase design for easy plug removal

UP TO 2X LIFE IN METAL CUTTING

Enhanced tooth geometry, a thin kerf design, and an advanced coating contribute to the efficiency of the cutting process

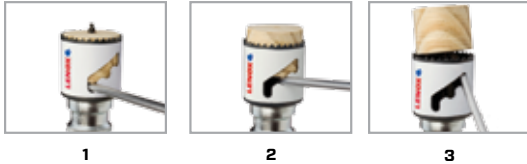

DIAMETER		1 PER BOX	1 PER BLISTER SEAL	1 PACK ARBORED	PIPE TAP		PIPE ENTRANCE		USE ARBOR	
IN	MM	PROD NO	PROD NO	PROD NO	IN	MM	IN	MM	SNAP-BACK™	STANDARD
9/16	14.3	300099L	1787781	1772423	—	—	—	—	5L	1L, 4L or 5L
5/8	15.9	3001010L	1771823	1772424	—	—	—	—	5L	1L, 4L or 5L
11/16	17.5	3001111L	1787773	1772425	—	—	—	—	5L	1L, 4L or 5L
3/4	19.1	3001212L	1771952	1772426	1/2	12.7	3/8	9.5	5L	1L, 4L or 5L
25/32	19.8	3009820MMHS	1771962	1772427	—	—	—	—	5L	1L, 4L or 5L
13/16	20.6	3001313L	1787775	1772428	—	—	—	—	5L	1L, 4L or 5L
7/8	22.2	3001414L	1771953	1772429	3/4	19.1	1/2	12.7	5L	1L, 4L or 5L
15/16	23.8	3001515L	1787776	1772430	—	—	—	—	5L	1L, 4L or 5L
1	25.4	3001616L	1771954	1772481	—	—	—	—	5L	1L, 4L or 5L
1-1/16	27.0	3001717L	1771955	1772482	—	—	—	—	5L	1L, 4L or 5L
1-1/8	28.6	3001818L	1771959	1772483	1	25.4	3/4	19.1	5L	1L, 4L or 5L
1-3/16	30.2	3001919L	1787777	1772474	—	—	—	—	5L	1L, 4L or 5L
1-1/4	31.8	3002020L	1771960	1772491	—	—	—	—	2L, 6L	2L, 3L or 6L
1-5/16	33.3	3002121L	1787778	1772492	—	—	—	—	2L, 6L	2L, 3L or 6L
1-3/8	34.9	3002222L	1771961	1772727	—	—	1	25.4	2L, 6L	2L, 3L or 6L
1-7/16	36.5	3002323L	1787779	1772728	—	—	—	—	2L, 6L	2L, 3L or 6L
1-1/2	38.1	3002424L	1771963	1772729	1-1/4	31.8	—	—	2L, 6L	2L, 3L, 6L or 7L
1-9/16	39.7	3002525L	1787780	1772730	—	—	—	—	2L, 6L	2L, 3L, 6L or 7L
1-5/8	41.3	3002626L	1771964	1772931	—	—	—	—	2L, 6L	2L, 3L, 6L or 7L
1-11/16	42.9	3002727L	1787800	1772932	—	—	—	—	2L, 6L	2L, 3L, 6L or 7L
1-3/4	44.5	3002828L	1771967	1772933	1-1/2	38.1	1-1/4	31.8	2L, 6L	2L, 3L, 6L or 7L
1-13/16	46.0	3002929L	1787841	1772935	—	—	—	—	2L, 6L	2L, 3L, 6L or 7L
1-7/8	47.6	3003030L	1771968	1772778	—	—	—	—	2L, 6L	2L, 3L, 6L or 7L
2	50.8	3003232L	1771970	1772779	—	—	1-1/2	38.1	2L, 6L	2L, 3L, 6L or 7L
2-1/16	52.4	3003333L	1787842	1772780	—	—	—	—	2L, 6L	2L, 3L, 6L or 7L
2-1/8	54.0	3003434L	1772003	1772951	—	—	—	—	2L, 6L	2L, 3L, 6L or 7L
2-1/4	57.2	3003636L	1771983	1772952	2	50.8	—	—	2L, 6L	2L, 3L, 6L or 7L
2-3/8	60.3	3003838L	1771984	1772953	—	—	—	—	2L, 6L	2L, 3L, 6L or 7L
2-1/2	63.5	3004040L	1771987	1772954	—	—	2	50.8	2L, 6L	2L, 3L, 6L or 7L
2-9/16	65.1	3004141L	1787843	1772955	—	—	—	—	2L, 6L	2L, 3L, 6L or 7L
2-5/8	66.7	3004242L	1771988	1772956	2-1/2	63.5	—	—	2L, 6L	2L, 3L, 6L or 7L
2-11/16	68.3	3004343L	1771989	—	—	—	—	—	2L, 6L	2L, 3L, 6L or 7L



DIAMETER		1 PER BOX	1 PER BLISTER SEAL	1 PACK ARBORED	PIPE TAP		PIPE ENTRANCE		USE ARBOR	
IN	MM	PROD NO	PROD NO	PROD NO	IN	MM	IN	MM	SNAP-BACK	STANDARD
2-3/4	69.9	3004444L	1771990	1772961	—	—	—	—	2L, 6L	2L, 3L, 6L or 7L
2-7/8	73.0	3004646L	1787844	1772962	—	—	—	—	2L, 6L	2L, 3L, 6L or 7L
3	76.2	3004848L	1772021	1772963	—	—	2-1/2	63.5	2L, 6L	2L, 3L, 6L or 7L
3-1/8	79.4	3005050L	1772022	1772964	—	—	—	—	2L, 6L	2L, 3L, 6L or 7L
3-1/4	82.6	3005252L	1772023	1772966	3	76.2	—	—	2L, 6L	2L, 3L, 6L or 7L
3-3/8	85.7	3005454L	1787845	1772945	—	—	—	—	2L, 6L	2L, 3L, 6L or 7L
3-1/2	88.9	3005656L	1772012	1772946	—	—	—	—	2L, 6L	2L, 3L, 6L or 7L
3-5/8	92.1	3005858L	1772013	1772949	—	—	3	76.2	2L, 6L	2L, 3L, 6L or 7L
3-3/4	95.3	3006060L	1787846	1772950	3-1/2	85.7	—	—	2L, 6L	2L, 3L, 6L or 7L
3-7/8	98.4	3006262L	1787847	1773001	—	—	—	—	2L, 6L	2L, 3L, 6L or 7L
4	101.6	3006464L	1772014	1773002	—	—	—	—	2L, 6L	2L, 3L, 6L or 7L
4-1/8	104.8	3006666L	1772018	1773003	—	—	3-1/2	85.7	2L, 6L	2L, 3L, 6L or 7L
4-1/4	108.0	3006868L	1772019	1773004	4	95.3	—	—	2L, 6L	2L, 3L, 6L or 7L
4-3/8	111.1	3007070L	1787848	1773005	—	—	—	—	2L, 6L	2L, 3L, 6L or 7L
4-1/2	114.3	3007272L	1772075	1773006	—	—	—	—	2L, 6L	2L, 3L, 6L or 7L
4-5/8	117.5	3007474L	1787850	—	—	—	4	95.3	2L, 6L	2L, 3L, 6L or 7L
4-3/4	120.7	3007676L	1772076	1773008	4-1/2	108.0	—	—	2L, 6L	2L, 3L, 6L or 7L
5	127.0	3008080L	1772077	—	—	—	—	—	2L, 6L	2L, 3L, 6L or 7L
5-1/2	139.7	3008888L	1787785	—	—	—	—	—	2L, 6L	2L, 3L, 6L or 7L
6	152.4	3009696L	1772121	—	—	—	—	—	2L, 6L	2L, 3L, 6L or 7L

CONTRACTOR'S HOLE SAW 5 PACKS

VALUE & CONVENIENCE

Unique packaging provides value and convenience for high volume users

PROD NO	IN	MM
10735B14L	7/8	22.2
10736B16L	1	25.4
10737B18L	1-1/8	28.6
10738B20L	1-1/4	31.8
10739B22L	1-3/8	34.9
10740B24L	1-1/2	38.1
10741B28L	1-3/4	44.5
10742B32L	2	50.8





SNAP-BACK™ ARBORS

No Tools. No Adaptors. No Screwing Around.

QUICK CHANGE

Faster and easier to engage/disengage hole saw

PREVENTS THREADS FROM STRIPPING

Drives off pins, not threads

NO TOOLS NEEDED

Prevents hole saw from locking on arbor

NO ADAPTOR REQUIRED

Arbor threads directly into all hole saws

EASIER PLUG REMOVAL



PROD NO	DESC	FITS HOLE SAWS	SIZES		THREAD SIZE	SHANK TYPE	SHANK SIZE	
			IN	MM			IN	MM
1779772	2L	20L-96L	1-1/4-6	31.8-152.4	5/8-18	Solid Hex	1/2 & larger	12.7 & larger
1779669	5L	9L-19L	9/16-1-3/16	14-30	1/2-20	Solid Hex	3/8 & larger	9.5 & larger
1779670	6L	20L-96L	1-1/4-6	31.8-152.4	5/8-18	Solid Hex	3/8 & larger	9.5 & larger

Solid Hex



SNAP-BACK QUICK CHANGE EXTENSIONS

DURABILITY AND EXTENDED LIFE

Carbon steel collar and shaft for durability and extended life

ONE-HANDED RELEASE

SNAP-BACK Quick Change mechanism for quick and easy release

BIT HELD SECURELY IN PLACE

Patented jaw design holds bits securely on 6-flatted shanks and ball detent bits



PROD NO	IN	MM	CHUCK SIZE		FITS ARBOR	
			IN	MM	SNAP-BACK	STANDARD
1852050	5-1/2	140	7/16	11	2L	1L, 2L, 3L
1852047	12	305	3/8	9.5	5L, 6L	5L, 6L, 7L
1852048	12	305	7/16	11	2L	1L, 2L, 3L
1852049	18	457	7/16	11	2L	1L, 2L, 3L

1852050 1852047 1852048 1852049

STANDARD ARBORS & ACCESSORIES

Arbors & Accessories for All Your Drilling Needs

ADDED DURABILITY

Hardened carbon steel for strength

STARTS ON CONTACT

Split point pilot drill for faster penetration and less walking



LENOX 6L Arbor with quick change feature (product no 1779805)

PROD NO	DESC	FITS HOLE SAWS	SIZES		SHANK TYPE	SHANK SIZE		PRIMARY FEATURE
			IN	MM		IN	MM	
1779774	1L	9L-19L	9/16-1-3/16	14.3-30.2	Hollow Hex	1/2 & larger	12.7 & larger	Adjustable pilot bit
1779801	2L	20L-96L	1-1/4-6	31.8-152.4	Solid Hex	1/2 & larger	12.7 & larger	Use for enlarging holes
1856058	2L	20L-96L	1-1/4-6	31.8-152.4	Hollow Hex	1/2 & larger	12.7 & larger	Use for enlarging holes, adjustable pilot bit
1779802	3L	20L-96L	1-1/4-6	31.8-152.4	Solid Hex	1/2 & larger	12.7 & larger	Solid shank
1779803	4L	9L-19L	9/16-1-3/16	14.3-30.2	3 Sided	1/4 & larger	6.4 & larger	Adjustable pilot bit, 3 flats on shank
1779804	5L	9L-19L	9/16-1-3/16	14.3-30.2	Hex	3/8 & larger	9.5 & larger	Use for 9A-19A arbored hole saws
1779805	6L	20L-96L	1-1/4-6	31.8-152.4	Hex	3/8 & larger	9.5 & larger	Quick change arbor
1779806	7L	24L-96L	1-1/2-6	31.8-152.4	Hex	3/8 & larger	9.5 & larger	Plug ejection feature

PROD NO	DESCRIPTION	CHUCK SIZE		SNAP BACK	FITS ARBOR	
		IN	MM		SOLID HEX	HOLLOW HEX
1779771	4-1/4" Pilot Drill (1 pack)	1/4	6.4	—	1L, 4L	2L
1779841	4-1/4" Pilot Drill (25 pack)	1/4	6.4	—	1L, 4L	2L
1779810	3-1/4" Pilot Drill (1 pack)	1/4	6.4	2L, 5L, 6L	2L, 3L, 5L, 6L, 7L	—
1864904	3-1/4" Pilot Drill (25/pack)	1/4	6.4	2L, 5L, 6L	2L, 3L, 5L, 6L, 7L	—
30297123CT	Carbide Tipped Pilot Drill (1 pack)	1/4	6.4	—	1L, 4L	2L
3029865CTPD	Carbide Tipped Pilot Drill (1pack)	1/4	6.4	2L,5L, 6L	2L, 3L, 5L, 6L, 7L	—
30857AA1	Arbor Adaptor (1 pack)	—	—	5L	1L, 4L, 5L	—
3084818X	18" Extension (1 pack)	1/2 & larger	12.7 & larger	2L	1L, 2L, 3L	2L
3084712 X	12" Extension (1 pack)	1/2 & larger	12.7 & larger	2L	1L, 2L, 3L	2L
3084310X*	10" Extension (1 pack)	3/8 & larger	9.5 & larger	5L, 6L	5L, 6L, 7L	—
3084655X	5-1/2" Extension (1 pack)	1/2 & larger	12.7 & larger	2L	1L, 2L, 3L	2L
2910114	1/4" x 1/4" Set Screw	—	—	2L, 5L, 6L	2L, 3L, 5L, 6L, 7L	2L
29102516	5/16" x 5/16" Set Screw	—	—	—	1L, 4L, Extension	—

* Fits arbored hole saws

ACCESSORIES

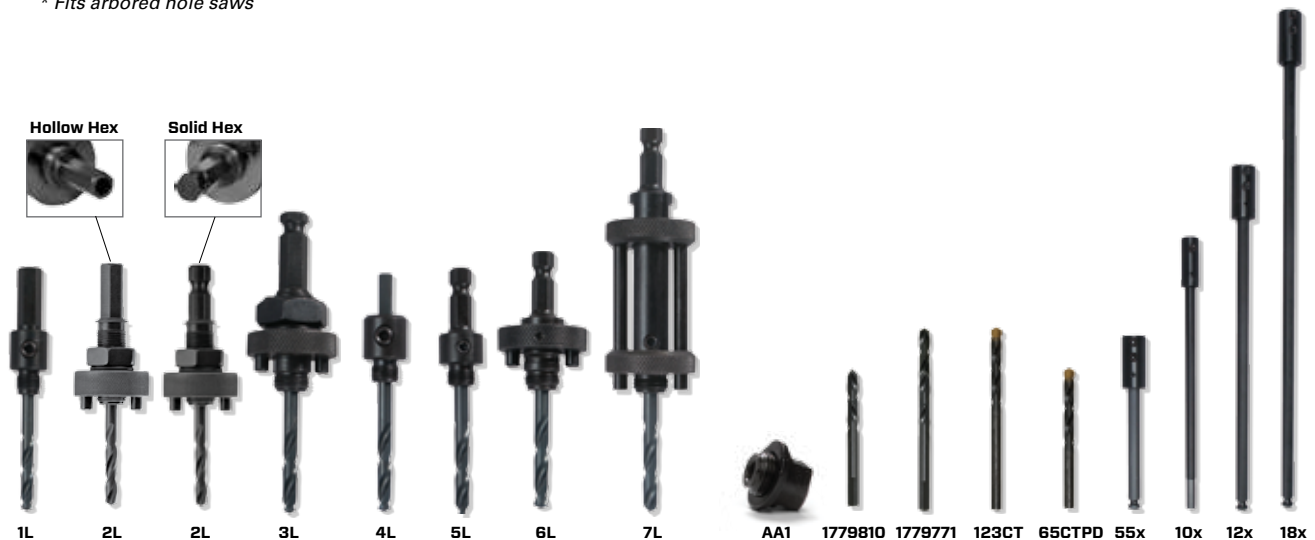



BI-METAL HOLE SAW KITS

Convenient Storage for Trade-Specific Uses

DURABLE

Durable construction resists damage caused by drops and tough workplace environments

SECURE

Latches close case tightly and securely. Lockable with standard padlocks

LONG LASTING

Metal latches and metal pin hinges won't break or tear



LARGE KIT
10" h x 14" w

MEDIUM KIT
8" h x 11" w

COMPACT KIT
4-11/16" h x 7-1/2" w

MINI KIT
9" h x 5" w



CONTRACTOR'S KITS



30370400G
5 PIECE KIT

2", 3", 3-3/8", 4-1/8"
SNAP-BACK Arbor: 2L

LARGE KIT



308201200G
17 PIECE KIT

5/8", 3/4", 7/8", 1", 1-1/8", 1-1/4",
1-3/8", 1-1/2", 1-3/4",
2", 2-1/2", 3"
SNAP-BACK Arbor: 2L

Arbor: 1L. Three pilot drills

LARGE KIT



30374500G
9 PIECE KIT

2-1/8", 2-9/16", 3-1/4", 3-3/4", 4-3/4"
SNAP-BACK Arbor: 2L

Three pilot drills

LARGE KIT



308042000G
26 PIECE KIT - BIG DADDY™

3/4", 7/8", 1", 1-1/8", 1-3/8", 1-1/2",
1-3/4", 2", 2-1/8", 2-1/4", 2-1/2",
2-11/16", 3", 3-1/4", 3-3/8", 3-5/8",
3-3/4", 4-1/8", 4-1/2", 4-3/4"
SNAP-BACK Arbors: 2L, 5L

Arbor: 1L. Three pilot drills

LARGE KIT



30807700G
9 PIECE KIT

7/8", 1", 1-1/4", 1-3/8",
1-1/2", 1-3/4", 2-1/8"
SNAP-BACK Arbors: 5L, 6L

MEDIUM KIT



1815140
7 PIECE KIT

7/8", 1-1/8", 1-3/8", 1-1/2", 2"
SNAP-BACK Arbors: 2L, 5L

MINI KIT

ELECTRICIAN'S KITS



30856C600L
9 PIECE KIT
7/8", 1-1/8", 1-3/8", 1-3/4", 2", 2-1/2"
SNAP-BACK Arbors: 2L, 5L
One arbor adaptor
MEDIUM KIT



30800600L
10 PIECE KIT
7/8", 1-1/8", 1-3/8", 1-3/4", 2", 2-1/2"
SNAP-BACK Arbors: 2L, 5L
One pilot drill
One arbor adaptor
LARGE KIT



308021200L
17 PIECE KIT
3/4", 7/8", 1-1/8", 1-3/8", 1-3/4", 2",
2-1/2", 2-11/16", 3", 3-5/8", 4-1/8", 4-3/4".
SNAP-BACK Arbors: 2L, 5L
Three pilot drills
LARGE KIT



1815139
8 PIECE KIT
7/8", 1-1/8", 1-3/8", 1-3/4", 2", 2-1/2"
SNAP-BACK Arbors: 2L, 5L
MINI KIT

PLUMBER'S KITS



30860C600P
9 PIECE KIT
3/4", 7/8", 1-1/8", 1-3/8", 2", 2-1/2"
SNAP-BACK Arbors: 2L, 5L
One arbor adaptor
MEDIUM KIT



30808600P
10 PIECE KIT
3/4", 7/8", 1-1/8", 1-1/2", 1-3/4", 2-1/4"
SNAP-BACK Arbors: 2L, 5L
One pilot drill
One arbor adaptor
LARGE KIT



1853786
10 PIECE KIT
2-1/8", 2-1/4", 2-9/16", 2-3/4",
3-5/8", 4", 4-5/8"
SNAP-BACK Arbor: 2L
Two pilot drills
LARGE KIT



308011200P
17 PIECE KIT
3/4", 7/8", 1-1/8", 1-1/2", 1-3/4", 2-1/4",
2-9/16", 3", 3-1/2", 4", 4-1/4", 4-1/2"
SNAP-BACK Arbors: 2L, 5L
Three pilot drills
LARGE KIT



1815195
7 PIECE KIT
1-1/4", 1-3/8", 1-1/2", 2", 2-1/2"
SNAP-BACK Arbors: 2L, 5L
MINI KIT

REFRIGERATION KIT



30830600R
8 PIECE KIT
5/8", 7/8", 1-1/8"
1-3/8", 1-5/8", 2-1/8"
SNAP-BACK Arbors:
5L, 6L
MEDIUM KIT

WELDER'S KIT



14789600W
9 PIECE KIT
3/4", 7/8", 1", 1-1/4",
1-1/2", 2"
SNAP-BACK Arbors:
2L, 5L
One arbor adaptor
MEDIUM KIT

AUTOMOTIVE KIT



30805500A
7 PIECE KIT
3/4", 7/8", 1",
1-1/8", 1-1/4"
Arbor: 5L
One arbor adaptor
COMPACT KIT



CARBIDE TIPPED HOLE SAWS

Designed for Cutting Tile and Stainless Steel

LONG TOOL LIFE

Heat resistant carbide teeth for long life in tile and stainless steel

ADDED DURABILITY

Thick backing plate resists damage and increases life

UNIQUE TOOTH CONFIGURATION

Engineered design provides ability to cut in stainless steel like no other

USE STANDARD ARBOR OR SNAP-BACK™ ARBOR



1 PER PACK PROD NO	DIAMETER		PIPE TAP		PIPE ENTRANCE		USE ARBOR	
	IN	MM	IN	MM	IN	MM	SNAP-BACK	STANDARD
3021111CT	11/16	17.5	—	—	—	—	5L	1L, 4L, 5L
3021212CT	3/4	19.1	1/2	12.7	3/8	9.5	5L	1L, 4L, 5L
3021414CT	7/8	22.2	3/4	19.1	1/2	12.7	5L	1L, 4L, 5L
3021616CT	1	25.4	—	—	—	—	5L	1L, 4L, 5L
3021818CT	1-1/8	28.6	1	25.4	3/4	19.1	5L	1L, 4L, 5L
3022020CT	1-1/4	31.8	—	—	—	—	2L	2L, 3L, 6L
3022222CT	1-3/8	34.9	—	—	1	25.4	2L	2L, 3L, 6L
3022424CT	1-1/2	38.1	1-1/4	31.8	—	—	2L	2L, 3L, 6L, 7L
3022626CT	1-5/8	41.3	—	—	—	—	2L	2L, 3L, 6L, 7L
3022828CT	1-3/4	44.5	1-1/2	38.1	1-1/4	31.8	2L	2L, 3L, 6L, 7L
3023232CT	2	50.8	—	—	1-1/2	38.1	2L	2L, 3L, 6L, 7L
3023434CT	2-1/8	54.0	—	—	—	—	2L	2L, 3L, 6L, 7L
3023636CT	2-1/4	57.2	2	50.8	—	—	2L	2L, 3L, 6L, 7L
3023838CT	2-3/8	60.3	—	—	—	—	2L	2L, 3L, 6L, 7L
3024040CT	2-1/2	63.5	—	—	2	50.8	2L	2L, 3L, 6L, 7L
3024141CT	2-9/16	65.1	—	—	—	—	2L	2L, 3L, 6L, 7L
3024242CT	2-5/8	66.7	2-1/2	63.5	—	—	2L	2L, 3L, 6L, 7L
3024343CT	2-11/16	68.3	—	—	—	—	2L	2L, 3L, 6L, 7L
3024848CT	3	76.2	—	—	2-1/2	63.5	2L	2L, 3L, 6L, 7L
3025252CT	3-1/4	82.6	3	76.2	—	—	2L	2L, 3L, 6L, 7L
3025454CT	3-3/8	85.7	—	—	—	—	2L	2L, 3L, 6L, 7L
3025656CT	3-1/2	88.9	—	—	—	—	2L	2L, 3L, 6L, 7L
3025858CT	3-5/8	92.1	—	—	3	76.2	2L	2L, 3L, 6L, 7L
3026060CT	3-3/4	95.3	3-1/2	88.9	—	—	2L	2L, 3L, 6L, 7L
3026464CT	4	101.6	—	—	—	—	2L	2L, 3L, 6L, 7L
3026666CT	4-1/8	104.8	—	—	3-1/2	88.9	2L	2L, 3L, 6L, 7L
3026868CT	4-1/4	108.0	4	101.6	—	—	2L	2L, 3L, 6L, 7L
3027272CT	4-1/2	114.3	—	—	—	—	2L	2L, 3L, 6L, 7L
3027676CT	4-3/4	120.7	4-1/2	114.3	4	101.6	2L	2L, 3L, 6L, 7L
3028080CT	5	127.0	—	—	—	—	2L	2L, 3L, 6L, 7L
3028888CT	5-1/2	139.7	—	—	—	—	2L	2L, 3L, 6L, 7L
3029696CT	6	152.4	—	—	—	—	2L	2L, 3L, 6L, 7L

Recommended RPM for each Carbide Tipped Hole Saw on page 46

Note: We recommend the use of a carbide tipped pilot drill when cutting ceramic wall tile.

Pilot drill 123CT fits the SNAP-BACK 2L or standard arbors 1L, 2L, 4L or 7L. Pilot drill 65CTPD fits the SNAP-BACK 2L or standard arbors 5L and 6L. See pages 36-37.

PLUMBER'S KIT



30294600CTP 8 PIECE

3/4", 7/8", 1-1/8", 1-1/2",
1-3/4", 2-1/4"
SNAP-BACK Arbor: 2L
Arbor: 1L

MEDIUM KIT

ELECTRICIAN'S KIT



30295600CTL 8 PIECE

7/8", 1-1/8", 1-3/8", 1-3/4",
2", 2-1/2"
SNAP-BACK Arbor: 2L
Arbor: 1L

MEDIUM KIT

CONTRACTOR'S KIT



302901100CTG 15 PIECE

3/4", 7/8", 1", 1-1/8", 1-1/4",
1-3/8", 1-1/2", 1-3/4", 2",
2-9/16", 3"
SNAP-BACK Arbor: 2L
Arbor: 1L
Two pilot drills

LARGE KIT

CARBIDE GRIT HOLE SAWS

Best for Cutting Abrasive Materials

CUTS ABRASIVE MATERIALS

Tungsten carbide grit cuts through fiberglass, ceramic tile, laminates and other abrasive materials

CLEAN CUTTING

Carbide grit edge will not snag or chip when cutting thin materials

USE STANDARD ARBOR OR SNAP-BACK™ ARBOR



1 PER BOX PROD NO	DIAMETER		PIPE TAP		PIPE ENTRANCE		USE ARBOR	
	IN	MM	IN	MM	IN	MM	SNAP-BACK	STANDARD
2991212CG	3/4	19.1	1/2	12.7	3/8	9.5		1L, 4L
2999820MMCG	25/32	19.8	—	—	—	—		1L, 4L
2991414CG	7/8	22.2	3/4	19.1	1/2	12.7		1L, 4L
2991616CG	1	25.4	—	—	—	—		1L, 4L
2991818CG	1-1/8	28.6	1	25.4	3/4	19.1		1L, 4L
2992020CG	1-1/4	31.8	—	—	—	—	2L	2L
2992222CG	1-3/8	34.9	—	—	1	25.4	2L	2L
2992424CG	1-1/2	38.1	1-1/4	31.8	—	—	2L	2L, 7L
2992828CG	1-3/4	44.5	1-1/2	38.1	1-1/4	31.8	2L	2L, 7L
2993232CG	2	50.8	—	—	1-1/2	38.1	2L	2L, 7L
2993434CG	2-1/8	54	—	—	—	—	2L	2L, 7L
2993636CG	2-1/4	57.2	2	50.8	—	—	2L	2L, 7L
2993838CG	2-3/8	60.3	—	—	—	—	2L	2L, 7L
2994040CG	2-1/2	63.5	—	—	2	50.8	2L	2L, 7L
2994141CG	2-9/16	65.1	—	—	—	—	2L	2L, 7L
2994848CG	3	76.2	—	—	2-1/2	63.5	2L	2L, 7L
2995252CG	3-1/4	82.6	3	76.2	—	—	2L	2L, 7L
2995858CG	3-5/8	92.1	—	—	3	76.2	2L	2L, 7L
2996464CG	4	101.6	—	—	—	—	2L	2L, 7L
2996666CG	4-1/8	104.8	—	—	3-1/2	88.9	2L	2L, 7L

PLUMBER'S KIT



29984600CGP

9 PIECE

3/4", 7/8", 1-1/8", 1-1/2",
2-1/8", 2-9/16"

SNAP-BACK Arbor: 2L
Arbor: 1L. One arbor adaptor

MEDIUM KIT

CONTRACTOR'S KIT



29985700CGK

10 PIECE

7/8", 1", 1-1/4", 1-3/8", 1-1/2",
1-3/4", 2-1/8"

SNAP-BACK Arbor: 2L
Arbor: 1L. One arbor adaptor

MEDIUM KIT



LENOX DIAMOND™ HOLE SAWS

More Holes. Less Time.

ONE PIECE HOLE SAWS

LONG LASTING

Continuous, brazed edge lasts longer in tile and stone

FAST, EASY CUTTING

Low torque, little pressure required

EASIER PLUG REMOVAL

Over-sized slot in hole saw for easy plug removal

1 PER PACK PROD NO	IN	MM	PIPE TAP		PIPE ENTRANCE	
			IN	MM	IN	MM
121063DGDS	3/16	5				
121074DGDS	1/4	6				
121085DGDS	5/16	8				
121096DGDS	3/8	10				
121108DGDS	1/2	13				
1211110DGDS	5/8	16				
1211212DGDS	3/4	19	3/4	13	3/8	10
1211416DGDS	1	25				
1211622DGDS	1-3/8	35			1	25
12158DGDS4A	4 pc kit*					

* Sizes: 3/16", 1/4", 5/16", 3/8"



Diamond Edge



Easier Plug Removal



No Arbor Needed



1856785

10 PIECE KIT

1/4", 3/4", 7/8", 1-1/8", 1-3/8",
2", 2-1/2"

SNAP-BACK Arbors: 2L, 5L
Hex Wrench

LARGE KIT

STANDARD HOLE SAWS

LONG LASTING

Brazed diamond edge for more holes in tile and stone

DURABLE

Robust design for greater durability in tough applications

FAST CUTTING

Cuts holes in less time than carbide grit or carbide tipped hole saws

EASIER PLUG REMOVAL

Round holes make removing plugs faster and easier

USE STANDARD ARBOR OR SNAP-BACK™ ARBOR

1 PER PACK PROD NO	IN	MM	PIPE TAP		PIPE ENTRANCE		USE ARBOR	
			IN	MM	IN	MM	SNAP-BACK	STANDARD
1211314DGHS	7/8	22	3/4	19	1/2	13	5L	1L, 4L, 5L
1225618DGHS	1-1/8	29	1	25	3/4	19	5L	1L, 4L, 5L
1211520DGHS	1-1/4	32					2L, 6L	2L, 3L, 6L
1211722DGHS	1-3/8	35			1	25	2L, 6L	2L, 3L or 6L
1211824DGHS	1-1/2	38	1-1/4	32			2L, 6L	2L, 3L, 6L, 7L
1211932DGHS	2	51			1-1/2	38	2L, 6L	2L, 3L, 6L, 7L
1212040DGHS	2-1/2	64			2	51	2L, 6L	2L, 3L, 6L, 7L

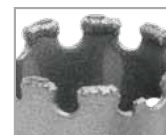

Diamond Edge



Easier Plug Removal

CARBIDE HOLE CUTTERS

Designed Specifically for Sheet Metal Hole Cutting

ACCURATE, BURR-FREE HOLES

Precision ground carbide teeth for fast cutting of clean, round holes

WILL NOT DAMAGE WORK

Over-drill stopper prevents the tool from penetrating beyond the hole

STARTS ON CONTACT

Split point pilot bit for faster penetration and less walking



1 PER BOX PROD NO	DIAMETER		CONDUIT SIZE	USE ARBOR	
	IN	MM		SNAP-BACK	STANDARD
2009212CHC	3/4	19.1	3/8"	5L	5L
2009314CHC	7/8	22.2	1/2"	5L	5L
2009416CHC	1	25.4	—	5L	5L
2009618CHC	1-1/8	28.6	3/4"	5L	5L
20097195CHC	1-7/32	30.9	—	5L	5L
2009820CHC	1-1/4	31.8	—	—	3L, 6L
2010022CHC	1-3/8	34.9	1"	—	3L, 6L
2010224CHC	1-1/2	38.1	—	—	3L, 6L
2010328CHC	1-3/4	44.5	1-1/4"	—	3L, 6L
2010432CHC	2	50.8	1-1/2"	—	3L, 6L
2010534CHCt	2-1/8	54.0	—	—	3L, 6L
2010840CHC	2-1/2	63.5	2"	—	3L, 6L
2010942CHC	2-5/8	66.7	—	—	3L, 6L
2011344CHC	2-3/4	69.9	—	—	3L, 6L
2011448CHC	3	76.2	2-1/2"	—	3L, 6L

ACCESSORIES	PROD NO	DESCRIPTION
	3087935PD	1/4" Split point stubby pilot bit
	308803CHCAS	Plug ejection springs
	300033L	3L, 1/2" Arbor for 20CHC – 48CHC. Solid hex shank
	300055L	5L, 3/8" Arbor for 11CHC – 19.5CHC. Solid hex shank
	12203K5LSC	5L SNAP-BACK Arbor

ELECTRICIAN'S KITS



30877300CHC 12 PIECE KIT

7/8", 1-1/8", 1-3/8". Arbors: 3L, 5L
1/4" split point pilot bit. Plug ejection
springs, 1/8" hex wrench

COMPACT KIT



30878500CHC 15 PIECE KIT

7/8", 1-1/8", 1-3/8", 1-3/4", 2", 2-1/2"
Arbors: 3L, 5L. 1/4" split point pilot bit
Plug ejection springs, 1/8" hex wrench

MEDIUM KIT



LENOX PROTOOL LUBE®

Extends Tool Life

SHORTENS CUTTING TIME BY UP TO 50%

Provides smoother, cleaner cutting and
dramatically longer tool life

REDUCES HEAT AND FRICTION

Water soluble, so it cleans up with water

Biodegradable and non-toxic

PROD NO	CONTAINER SIZE		CONTAINERS PER CASE
	GALLON	LITER	
68040LNX	6 oz	.17	12
68047	1	3.8	4
68048	5	18.9	—
68050	55	208.2 drum	—

NFPA CODE SPECS

HMS/WHMIS
HEALTH INDEX – 1
FLAMMABILITY – 0
REACTIVITY – 0
PERSONAL PROTECTION – A



Use this product as it comes from the container—do not mix with water.
MSDS available in hard copy or downloadable from lenoxtools.com



ONE TOOTH® ROUGH WOOD HOLE CUTTER

Drills Faster Than Self-Feed Bits

LONG LASTING

High speed steel tooth provides long tool life

CUTS FAST / LOW TORQUE

Designed to run at high speeds with very little torque

DURABLE WOOD CUTTING TOOL

Cuts wet, frozen, pressure treated and hard wood without binding

EASY PLUG REMOVAL

Patented design allows easy plug removal

CUTS AT AN ANGLE

Unique design provides the ability to cut at an angle

USE STANDARD ARBOR OR SNAP-BACK™ ARBOR

For optimal performance use a 3/8" Stubby Spade Bit with arbor



1 PER PACK PROD NO	CUTTER SIZE		CUTTING DEPTH		APPLICATION	USE ARBOR	
	IN	MM	IN	MM		SNAP-BACK	STANDARD
2542222HC	1-3/8	34.9	2-7/16"	62	1" pipe & lock installation	2L	2L, 3L
2543434HC	2-1/8	54.0	2-7/16"	62	1-1/2" pipe & lock installation	2L	2L, 3L
2543636HC	2-1/4	57.2	2-7/16"	62	1-1/2" pipe & 45°/90° bend couplings	2L	2L, 3L
2544141HC	2-9/16	65.1	2-7/16"	62	2" pipe	2L	2L, 3L
2544444HC	2-3/4	69.9	2-7/16"	62	2" pipe & 45°/90° bend couplings	2L	2L, 3L
2545454HC	3-3/8	85.7	2-7/16"	62	3" duct pipe & bendable duct pipe	2L	2L, 3L
2545656HC	3-5/8	92.1	2-7/16"	62	3" pipe	2L	2L, 3L
2546464HC	4	101.6	2-7/16"	62	3" pipe & coupling & dryer vent	2L	2L, 3L
2546969HC	4-5/16	109.5	2-7/16"	62	4" duct pipe & bendable duct pipe	2L	2L, 3L
2547474HC	4-5/8	117.5	2-7/16"	62	4" pipe	2L	2L, 3L
2548080HC	5	127.0	2-7/16"	62	4" pipe & coupling	2L	2L, 3L
2548787HC	5-1/2	139.7	2-7/16"	62	Toilet flange	2L	2L, 3L
2550000HC	6-1/4	158.8	2-7/16"	62	6" duct pipe	2L	2L, 3L
25310SB38	—	—	—	—	3/8" stubby spade bit	2L	2L, 3L
25312DIAF1	—	—	—	—	Diamond file for re-sharpening		



25476301G 7 PIECE

2-1/8", 2-9/16", 3-5/8"
SNAP-BACK Arbor: 2L, Diamond file
Two 3/8" stubby spade bits

LARGE KIT



25477701G 11 PIECE

2-1/8", 2-1/4", 2-9/16", 2-3/4",
3-5/8", 4", 4-5/8"
SNAP-BACK Arbor: 2L, Diamond file
Two 3/8" stubby spade bits

LARGE KIT

CARBIDE GRIT RECESSED LIGHTING HOLE SAWS

Best for Cutting Abrasive Materials

LONG LIFE

Hard tungsten carbide grit edge for a long life in abrasive materials

FAST, EASY CUTTING

Continuous cutting edge for smooth cutting

LIMITS DUST / DEBRIS

Solid back design collects dust and debris

NEW DESIGN



1 PER BOX PROD NO	DIAMETER		FOR FIXTURES	USE ARBOR	
	IN	MM		SNAP-BACK	STANDARD
30861438RL	4-3/8	111	Capri, Marco & Halo, Mini-Juno	2L	2L
12100538RL	5-3/8	137	Capri, Marco & Halo, Mini-Juno, Lightolier & Halo	2L	2L
30862638RL	6-3/8	162	Capri, Halo, Pathway & Thomas	2L	2L
30863658RL	6-5/8	168	Juno, Progress & Pathway	2L	2L
30864678RL	6-7/8	175	Capri, Hubbell®, Lightolier®, Lithonia®, Marco, Prescolite®, Progress	2L	2L

Use 123CT or 4321 Pilot Drill

HALO is a registered trademark of Halo Lighting, JUNO is a registered trademark of Juno Lighting Inc., LITHONIA is a registered trademark of Lithonia, Inc., LIGHTOLIER is a registered trademark of Lightolier, Inc., and PRESCOLITE is a registered trademark of Prescolite, Inc.

HOLE SAW SELECTION GUIDE

	WOOD	NAIL-EMBEDDED WOOD	NON-FERROUS METAL	PLASTICS & COMPOSITES	METAL	STAINLESS STEEL	DRYWALL/PLASTER	CAST IRON	CEMENT BOARD	ABRASIVES	TILE	STONE	
BEST	CARBIDE TIPPED			CARBIDE GRIT	CARBIDE TIPPED			LENOX® DIAMOND™					
BETTER	BI-METAL		BI-METAL					CARBIDE TIPPED	CARBIDE GRIT				
GOOD	CARBIDE GRIT	—	CARBIDE GRIT	CARBIDE TIPPED	CARBIDE GRIT			CARBIDE GRIT	BI-METAL	—	CARBIDE TIPPED	—	



RECOMMENDED HOLE SAW RPM

BI-METAL

DIAMETER		MILD	TOOL &	CAST		
IN	MM	STEEL	STAINLESS	IRON	BRASS	ALUM
9/16	14.3	580	300	400	790	900
5/8	15.9	550	275	365	730	825
11/16	17.5	500	250	330	665	750
3/4	19.1	460	230	300	600	690
25/32	19.8	425	210	280	560	630
13/16	20.6	425	210	280	560	630
7/8	22.2	390	195	260	520	585
15/16	23.8	370	185	245	495	555
1	25.4	350	175	235	470	525
1-1/16	27.0	325	160	215	435	480
1-1/8	28.6	300	150	200	400	450
1-3/16	30.2	285	145	190	380	425
1-1/4	31.8	275	140	180	360	410
1-5/16	33.3	260	135	175	345	390
1-3/8	34.9	250	125	165	330	375
1-7/16	36.5	240	120	160	315	360
1-1/2	38.1	230	115	150	300	345
1-9/16	39.7	220	110	145	290	330
1-5/8	41.3	210	105	140	280	315
1-11/16	42.9	205	100	135	270	305
1-3/4	44.5	195	95	130	250	295
1-13/16	46.0	190	95	125	250	285
1-7/8	47.6	180	90	120	240	270
2	50.8	170	85	115	230	255
2-1/16	52.4	165	80	110	220	245
2-1/8	54.0	160	80	105	210	240
2-1/4	57.2	150	75	100	200	225
2-3/8	60.3	140	70	95	190	220
2-1/2	63.5	135	65	90	180	205
2-9/16	65.1	130	65	85	175	200
2-5/8	66.7	130	65	85	170	195
2-11/16	68.3	125	60	80	160	185
2-3/4	69.9	125	60	80	160	185
2-7/8	73.0	120	60	80	160	180
3	76.2	115	55	75	150	170
3-1/8	79.4	110	55	70	140	165
3-1/4	82.6	105	50	70	140	155
3-3/8	85.7	100	50	65	130	150
3-1/2	88.9	95	45	65	130	145
3-5/8	92.1	95	45	60	120	140
3-3/4	95.3	90	45	60	120	135
3-7/8	98.4	85	40	55	110	130
4	101.6	85	40	55	110	130
4-1/8	104.8	80	40	55	110	120
4-1/4	108.0	80	40	55	110	120
4-3/8	111.1	75	35	50	100	105
4-1/2	114.3	75	35	50	100	105
4-5/8	117.5	75	35	50	100	105
4-3/4	120.7	70	35	45	90	95
5	127.0	70	35	45	90	95
5-1/2	139.7	65	30	40	85	90
6	152.4	65	30	40	85	90

CARBIDE TIPPED

DIAMETER				FIBER-	CERAMIC PARTICLE	CAST	COMPUTER	
IN	MM	ALUM	PLASTIC	GLASS	TILE	BOARD	IRON	FLOORING
3/4	19.1	1700	3430	250	500	3430	410	550
7/8	22.2	1500	2940	210	430	2940	180	470
1	25.4	1300	2570	190	370	2570	150	410
1-1/8	28.6	1100	2290	170	330	2290	140	370
1-3/8	34.9	900	1870	140	270	1870	110	300
1-1/2	38.1	900	1710	120	250	1710	100	270
1-3/4	44.5	700	1470	110	210	1470	90	240
2	50.8	600	1290	90	190	1290	80	210
2-1/4	57.2	600	1140	80	170	1140	70	180
2-1/2	63.5	500	1030	70	150	1030	60	160
3	76.2	400	860	60	120	860	50	140
3-1/4	82.6	400	790	60	110	790	50	130
3-5/8	92.1	400	710	50	100	710	40	110
3-3/4	95.3	300	690	50	100	690	40	110
4-1/8	104.8	300	620	50	90	620	40	100
4-3/4	120.7	300	540	40	80	540	30	90
5	127.0	200	480	40	80	500	30	90
5-1/2	139.7	200	420	40	70	460	30	80
6	152.4	100	360	30	60	420	30	60

Suggested RPMs only

CARBIDE GRIT

DIAMETER		BRICK, DRYWALL, PORCELAIN, MARBLE	SLATE, FIBERGLASS, CEMENT & PARTICLE BOARD	CAST
IN	MM	CERAMIC TILE	LAMINATES, GRANITE	IRON
3/4	19.1	800	900	600
25/32	19.8	800	900	600
7/8	22.2	800	900	600
1	25.4	800	900	600
1-1/8	28.6	500	600	400
1-1/4	31.8	500	600	400
1-3/8	34.9	500	600	400
1-1/2	38.1	500	600	400
1-3/4	44.5	500	600	400
2	50.8	400	500	200
2-1/8	54.0	400	500	200
2-1/4	57.2	400	500	200
2-3/8	60.3	200	300	100
2-1/2	63.5	200	300	100
2-9/16	65.1	200	300	100
2-5/8	66.7	200	300	100
3	76.2	200	300	100
3-1/4	82.6	100	200	100
3-5/8	92.1	100	200	100
4	101.6	100	200	100
4-1/8	104.8	100	200	100

Suggested RPMs only

LENOX DIAMOND™ HOLE SAWS

PORCELAIN, CERAMIC, SLATE, GRANITE, MARBLE, GLASS, FIBERGLASS, TRAVERTINE, CEMENT BOARD, LAMINATES

ONE PIECE			STANDARD		
DIAMETER			DIAMETER		
IN	MM		IN	MM	
3/16	5	1500-2000	7/8	22.2	800-1200
1/4	6	2000-2500	1-1/18	28.6	500-900
5/16	8	2000-2500	1-1/4	31.8	500-900
3/8	10	2000-2500	1-3/8	34.9	500-900
1/2	13	2000-2500	1-1/2	38.1	500-900
5/8	15	1500-2000	2	50.8	400-800
3/4	19.1	1500-2000	2-1/2	63.5	200-600

Suggested RPMs only

Suggested RPMs only



METAL AND WOOD DRILLING

LENOX® VARI-BIT® Step Drill Bits	48
Bi-metal Ship Auger Bits	49
Bi-metal Utility Bits	50
Bi-metal Self-Feed Bits	51



LENOX VARI-BIT® STEP DRILL BITS

Drills Fast, Clean, Round Holes

ACCURATE, BURR-FREE HOLES

Patented two flute design cuts fast, clean, round holes

STARTS ON CONTACT

Split point design for faster penetration and less walking

LONG TOOL LIFE

Steam oxide coating adds durability. Enhanced flute design removes chips rapidly. Use of LENOX PROTOOL LUBE® recommended to extend tool life



1 PER PACK PROD NO	Image	HOLE SIZES		#OF HOLE SIZES	SHANK SIZE	
		IN	MM		IN	MM
30881VB1		1/8, 5/32, 3/16, 7/32, 1/4, 9/32, 5/16, 11/32, 3/8, 13/32, 7/16, 15/32, 1/2	3.2, 4.0, 4.8, 5.6, 6.4, 7.1, 7.9, 8.7, 9.5, 10.3, 11.1, 11.9, 12.7	13	1/4	6.4
30882VB2		1/2, 9/16, 5/8, 11/16, 3/4, 13/16, 7/8, 15/16, 1	12.7, 14.3, 15.9, 17.5, 19.1, 20.6, 22.2, 23.8, 25.4	9	3/8	9.5
30883VB3		1/4, 5/16, 3/8, 7/16, 1/2, 9/16, 5/8, 11/16, 3/4	6.4, 7.9, 9.5, 11.1, 12.7, 14.3, 15.9, 17.5, 19.1	9	3/8	9.5
30884VB4		3/16, 1/4, 5/16, 3/8, 7/16, 1/2	4.8, 6.4, 7.9, 9.5, 11.1, 12.7	6	1/4	6.4
30886VB6		3/8, 1/2	9.5, 12.7	2	1/4	6.4
30887VB7		7/8 (for 1/2 conduit)	22.2 (for 12.7 conduit)	1	3/8	9.5
30908VB8		3/16, 1/4, 5/16, 3/8, 7/16, 1/2, 9/16, 5/8, 11/16, 3/4, 13/16, 7/8	4.8, 6.4, 7.9, 9.5, 11.1, 12.7, 14.3, 15.9, 17.5, 19.1, 20.6, 22.2	12	3/8	9.5
30909VB9		7/8, 1-1/8, 1-7/32	22.2, 28.6, 31.0	3	3/8	9.5
30888VB11		7/8, 1-1/8 (for 1/2 and 3/4 conduit)	22.2, 28.6 (for 12.7 and 19.1 conduit)	2	3/8	9.5
30912VB12		7/8, 1-1/8, 1-7/32, 1-1/4, 1-3/8	22.2, 28.6, 31.0, 31.8, 34.9	5	3/8	9.5
30925VBX8		8" (203mm) Extension. Fits 3/8 (9.5mm) shank & larger. 1 per pack.		-	3/8	9.5



**30889889
3 PIECE KIT**
VB1, VB2,
VB3
COMPACT KIT



**30926VBK4
4 PIECE KIT**
VB1, VB2,
VB7, VB8
COMPACT KIT



**30929VB30929
4 PIECE KIT**
VB1, VB3,
VB8, VB12
COMPACT KIT



**30927VBKA6
6 PIECE KIT**
VB1, VB2, VB6,
VB7, VB8, VB11
COMPACT KIT

BI-METAL SHIP AUGER BITS

Tougher than Nails

EXTREME DURABILITY

High speed steel cutting edge for superior durability in nail-embedded wood

LONGER LIFE

High speed steel screw tip increases wear resistance for extended life

FAST, EASY DRILLING

Unique parabolic screw tip pulls the bit through material quickly and effortlessly

RESHARPENABLE

Resharpener with LENOX Diamond File (prod no. 25312DIAF1)



High Speed Steel Cutting Edge



Parabolic Tip



Our bi-metal technology fuses two premium steels together.

PROD NO	HOLE DIAMETER		OVERALL LENGTH		TWIST LENGTH	
	IN	MM	IN	MM	IN	MM
1455507A1016	5/8	16	7-1/2	191	4	102
1455607A1116	11/16	18	7-1/2	191	4	102
1455707A1216	3/4	19	7-1/2	191	4	102
1455807A1316	13/16	21	7-1/2	191	4	102
1455907A1416	7/8	22	7-1/2	191	4	102
1456007A1516	15/16	24	7-1/2	191	4	102
1456107A1616	1	25	7-1/2	191	4	102
1456207A1716	1-1/16	27	7-1/2	191	4	102
1456307A1816	1-1/8	29	7-1/2	191	4	102
1456407A2016	1-1/4	32	7-1/2	191	4	102
1456507A2216	1-3/8	35	7-1/2	191	4	102
1456607A2416	1-1/2	38	7-1/2	191	4	102

PROD NO	HOLE DIAMETER		OVERALL LENGTH		TWIST LENGTH	
	IN	MM	IN	MM	IN	MM
145390080616*	3/8	10	18	457	12	305
145400080716*	7/16	11	18	457	12	305
145410080816	1/2	13	18	457	12	305
145420080916	9/16	14	18	457	12	305
145430081016	5/8	16	18	457	12	305
145440081116	11/16	18	18	457	12	305
145450081216	3/4	19	18	457	12	305
145460081316	13/16	21	18	457	12	305
145470081416	7/8	22	18	457	12	305
145480081516	15/16	24	18	457	12	305
145490081616	1	25	18	457	12	305
145500081716	1-1/16	27	18	457	12	305
145510081816	1-1/8	29	18	457	12	305
145520082016	1-1/4	32	18	457	12	305
145530082216	1-3/8	35	18	457	12	305
145540082416	1-1/2	38	18	457	12	305

*3/8" shank—all others 1/2" shank



1787507 15 PIECE, SELF-FEED BIT/ AUGER KIT

Augers: 7/8", 1-1/8", 1-1/4". Length: 7-1/2"
Self-feed bits: 1-1/2", 1-3/4", 2-1/8", 2-9/16"
Extension: 5-1/2". Five lead screws
Hex Wrench Set

LARGE KIT



BI-METAL UTILITY BITS

Tougher Than Nails

EXTREME DURABILITY

High speed steel cutting edges provide long life in tough applications, including nail-embedded wood

OPTIMIZED FOR CORDLESS DRILLING

Smooth, effortless drilling extends battery life

FAST CLEAN CUTTING

Three cutting edges enhance chip removal for a fast, clean hole

FAST, EASY DRILLING

Aggressive lead screw tip pulls the bit through material quickly and effortlessly



RESHARPENABLE
Resharpener with LENOX
Diamond File (25312DIAF1)

PROD NO	HOLE SIZE		OVERALL LENGTH	
	IN	MM	IN	MM
1094706A1016	5/8*	16	6	152
1094806A1216	3/4	19	6	152
1094906A1416	7/8	22	6	152
1095006A1616	1	25	6	152
1095106A1816	1-1/8	29	6	152
1095206A2016	1-1/4	32	6	152
1095306A2216	1-3/8	35	6	152

*1/4" shank—all others 3/8" shank



Fits Cordless Drill



3 Cutting Edges



Steel Cutting Edge



10954300S
3 PIECE SET
3/4", 7/8", 1"



14787300PS
3 PIECE PLUMBER'S SET
7/8", 1-1/8", 1-3/8"



10955500K
5 PIECE KIT
3/4", 7/8", 1", 1-1/8",
1-1/4"
COMPACT KIT



14788500PK
5 PIECE PLUMBER'S KIT
3/4", 7/8", 1", 1-1/8", 1-3/8"
COMPACT KIT

BI-METAL SELF-FEED BITS

Tougher than Nails

EXTREME DURABILITY

High speed steel cutting edge for superior durability in nail-embedded wood

Stays sharper longer

CLEAN HOLES AND EASY REMOVAL

Chamfered edge allows bit to be removed easily after drilling

Flutes remove excess wood chips

FAST, EASY DRILLING

Aggressive lead screw tip pulls the bit through material quickly and effortlessly

INCREASED VALUE

Extra lead screw and wrench included in every package

DEEPER CUTS

Longer shank that cuts 4"x 4" without extension

QUICK CHANGE

Impact hex shank allows for quick changing of the bits



RESHARPENABLE
Resharpener with LENOX
Diamond File (25312DIAF1)



Chamfered Edge & Flutes



Lead Tip Screw



High Speed Steel

PROD NO	HOLE DIAMETER		ENTRANCE FOR PIPE RIGID CONDUIT		ENTRANCE FOR TUBING	
	IN	MM	IN	MM	IN	MM
1787511	1	25	1/2	12.7	7/8	22.2
1787512	1-1/8	29	1/2	12.7	1	25.4
1787513	1-1/4	32	3/4	19	1-1/8	28.6
1787515	1-3/8	35	1	25.4	1-1/4	31.8
1787561	1-1/2	38	—	—	1-3/8	34.9
1787562	1-3/4	45	1-1/4	31.8	1-1/2	38.1
1787563	2	51	1-1/2	38.1	1-7/8	47.6
1787564	2-1/8	54	—	—	2	50.8
1787565	2-1/4	57	—	—	2-1/8	54
1787566	2-9/16	65	2	50	2-1/2	63.5
1787502	3	76	2-1/2	63	2-7/8	73
1787503	3-5/8	92	3	76.2	3-1/2	88.9
1787504	4-5/8	118	4	101.6	4-1/2	114.3

PROD NO	DESCRIPTION	FITS	QTY PER PACK
1787602	Self-Feed Lead Screws	1" - 1-3/8"	5
1787604	Self-Feed Lead Screws	1-1/2" - 2-9/16"	5
1787603	Self-Feed Lead Screws	3" - 4-5/8"	5
1787605	Self-Feed Set Screws	—	5
1787508	Hex Wrench Set, 1/8"	—	2
3084655X	5-1/2" shank extension*	—	1
3084712X	12" shank extension*	—	1
3084818X	18" shank extension*	—	1
25312DIAF1	Diamond File	—	1

ACCESSORIES

*All have 1/2" (13mm) hex shank with 2 set screws to lock BI-METAL SELF-FEED BIT in place



1787505 12 PIECE SELF-FEED KIT

1-3/8", 1-1/2", 2-1/8", 2-9/16"
Extension: 5-1/2" Five lead screws. Hex Wrench Set

LARGE KIT



1787506 16 PIECE SELF-FEED KIT

1-1/8", 1-1/4", 1-3/8", 1-1/2", 1-3/4",
2-1/8", 2-9/16" Extensions: 5-1/2", 12"
Five lead screws Hex Wrench Set

LARGE KIT



1787507 15 PIECE SELF-FEED BIT/ AUGER KIT

Augers: 7/8", 1-1/8", 1-1/4", Length: 7-1/2"
Self-feed bits: 1-1/2", 1-3/4", 2-1/8", 2-9/16"
Extension: 5-1/2", Five lead screws
Hex Wrench Set

LARGE KIT





HAND **TOOLS**

T2™ Hacksaw Blades	55
Hacksaw Frames	56, 57
Hand Saws	58
Snips & HVAC Tools	59
Plastic Tubing Cutters.....	60, 61
Tubing Cutters	62, 63
Locking Tradesman Utility Knife & Utility Knives.....	64
Utility Blades, Safety Knife & Blades.....	65
Soft Storage Tool Bags.....	66, 67
Pipe Wrenches & All-In-One Screwdrivers	65



TRIMMOR

LENOX®



Original
18

T2™ TECHNOLOGY HACKSAW BLADES

Up to 2X Life

T2 TECHNOLOGY

A new blade design that delivers up to 100% longer blade life versus the prior generation of LENOX hacksaw blades

SHATTER RESISTANT

Bi-metal construction allows blades to bend and flex without breaking

CUTS THROUGH TOUGH METALS:

- Black Pipe
- Unistrut®
- Copper Pipe
- Hardened Steel
- Threaded Rod
- Rebar

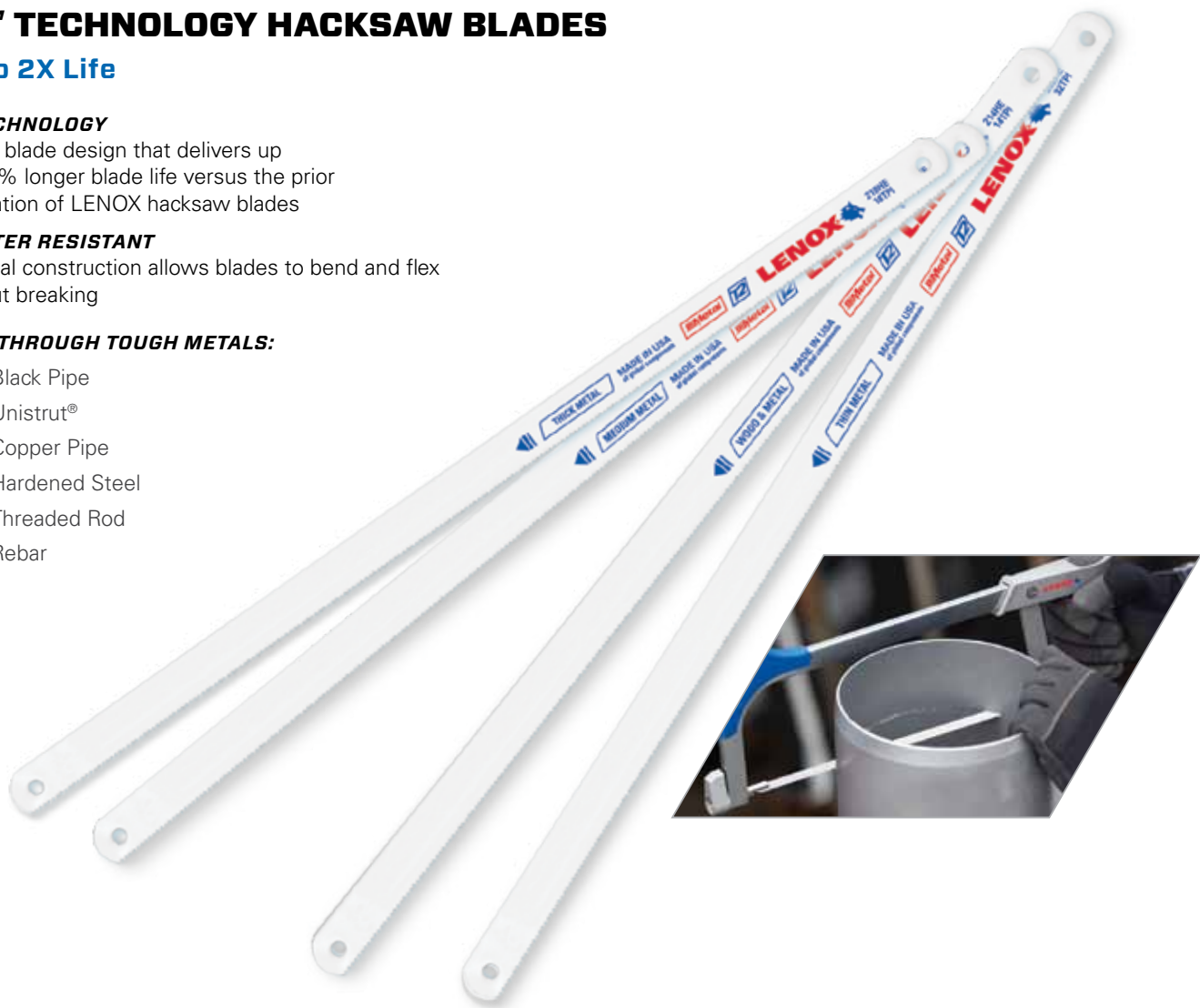

TPI	LENGTH X WIDTH		1-PACK PROD NO	2-PACK PROD NO	10-PACK PROD NO	100-PACK PROD NO	APPLICATION
	IN	MM					
14	12 x 1/2	300 x 12.7	—	—	20143V214HE	—	Wood and Metal
18	10 x 1/2	250 x 12.7	20150S018HE	20163T018HE	20140V018HE	20110018HE	Heavy Metal
18	12 x 1/2	300 x 12.7	20154S218HE	20160T218HE	20144V218HE	20116218HE	Heavy Metal
24	10 x 1/2	250 x 12.7	20151S024HE	23930T024HE	20141V024HE	20111024HE	Medium Metal
24	12 x 1/2	300 x 12.7	20155S224HE	20161T224HE	20145V224HE	20117224HE	Medium Metal
32	10 x 1/2	250 x 12.7	20152S032HE	20164T032HE	20142V032HE	20112032HE	Thin Metal
32	12 x 1/2	300 x 12.7	20156S232HE	20162T232HE	20146V232HE	20118232HE	Thin Metal



HT50 HIGH TENSION HACKSAW

50,000 PSI

HIGHEST TENSION. EVER

Unique I-beam construction allows blade to tension up to 50,000 psi, resulting in fast, straight cuts

COMFORTABLE GRIPS

Rubberized handles allow for confident handling even in wet or cold environments

CONVERT TO A JAB SAW

Accepts any LENOX reciprocating saw blade to be used as a jab saw

CONVENIENT BLADE STORAGE

Store up to 5 extra 12" hacksaw blades in the I-Beam



PROD NO	BLADE SPECIFICATION
12132HT50	12" (300mm) 24TPI Hacksaw Blade



Tension



Use as a Jab Saw



Stores up to 5 Blades



Comfort Grips

5012 LOW PROFILE HACKSAW

40,000 PSI

HIGH TENSION

Allows blade to tension up to 40,000 PSI, resulting in fast, straight cuts

FITS INTO TIGHT SPOTS

Low profile tip easily handles close-quarter cuts

MULTI-PURPOSE

Mount blade at 45 degrees for flush cutting applications

PROD NO	BLADE SPECIFICATION
209205012	12" (300mm) 24TPI Hacksaw Blade



Flush Cutting

88300 LIGHTWEIGHT HACKSAW

30,000 PSI

HIGH TENSION

Saw will tension up to 30,000 PSI

EASILY ADJUST TENSION

ERGONOMIC GRIP

Front handle grip reduces fatigue in continuous cutting applications

MULTI-PURPOSE

Mount blade at 45 degrees for flush cutting applications

PROD NO	BLADE SPECIFICATION
1213188300	12" (300mm) 24TPI Hacksaw Blade



Flush Cutting Comfort Grips

2012 COMPACT HACKSAW

20,000 PSI

ADJUSTABLE TENSION

Lightweight aluminum beam achieves tension up to 20,000 PSI

ERGONOMIC GRIP

Durable handle enables a confident grip in most work environments

MULTI-PURPOSE

Mount blade at 45 degrees for flush cutting applications

PROD NO	BLADE SPECIFICATION
1805722	12" (300mm) 24TPI Hacksaw Blade



Comfortable Grip

1512 ADJUSTABLE HACKSAW

15,000 PSI

EASILY ADJUST TENSION

Large front tensioning mechanism is easy to hold and adjust up to 15,000 PSI

ERGONOMIC GRIP

Rubberized grip allows for confident handling in any work environment

PROD NO	BLADE SPECIFICATION
1805723	12" (300mm) 24TPI Hacksaw Blade



Comfortable Grip



PVC/ABS

Plastic Pipe Hand Saw

CUTS PLASTIC PIPE EASILY

Cutting teeth cut on the pull stroke and not on the push stroke for safety

COMFORTABLE GRIPS

Rubberized handles allow for confident handling even in cold, hot, wet or dirty environments

FLUSH CUTTING OPTION

Easily mount the blade on the bottom of handle for flush cutting applications



Comfortable Handle



One Step Flush Cuttings

TPI	LENGTH		PROD NO	DESCRIPTION
	IN	MM		
10	12	304	20985HSF12	12" Blade & Handle
10	18	457	20980HSF18	18" Blade & Handle
10	12	304	20982HSB12	12" Replacement Blade
10	18	457	20981HSB18	18" Replacement Blade

FOLDING JAB AND UTILITY SAW

Designed for Cutting Multiple Materials

COMFORTABLE GRIP

Over-molded rubberized grip for a comfortable and secure grip while working

SECURELY HOLDS BLADE

Aluminum locking mechanism prevents blade from being removed during use

ACCOMMODATES HACKSAW BLADE

Ideal for flush cutting applications or when a hacksaw blade is not available

DIE CAST ALUMINUM CONSTRUCTION



Rotate Blade Out



Loosen Knob to Change Blade

PROD NO	DESCRIPTION	BLADES INCLUDED	APPLICATION
20997TFHS618636	Folding Jab Saw with 2 Blades	6J6R and 636RP	Plaster, drywall, wood, plastic and metal cutting
148216J6R	One Pack Replacement Blades		

975 COMPACT HAND HACKSAW

908 CLOSE QUARTER™ SAW

Cut a Wide Variety in Tight Spaces

RUGGED DESIGN

Heavy duty aluminum handle

FITS IN TIGHT SPOTS

Allows for flush cutting applications



PROD NO	DESCRIPTION	TPI	BLADE LENGTH	
			IN	MM
20975975	Compact Hand Saw	10	12	304
20908908	CLOSE QUARTER Saw	10	18	457
20906906	Replacement Blades	32	6	152

SNIPS

Maximum Durability for Long Life

LONG BLADE LIFE

Precision-formed blades for Aviation and Bulldog Snips

Bi-material blades for Offset Snips

ULTIMATE SPRING DURABILITY

Reinforced Chrome Silicon valve-quality wire lasts for a lifetime

COMFORTABLE GRIPS

Over-molded handles won't slip or twist

QUICK IDENTIFICATION

Color coding on both blades and handles plus arrow icons allow for easy tool recognition



PROD NO	DESCRIPTION	CUTTING CAPACITY		COMPETITIVE CROSS REFERENCE				
		SHEET METAL	STAINLESS STEEL	MALCO®	MIDWEST®	WISS®	KLEIN®	
22101101	Aviation Snip Left		18 ga	22 ga	M2001/MAXCG1	P6716-L	M1R	1100L
22102102	Aviation Snip Right		18 ga	22 ga	M2002/MAXCG2	P6716-R	M2R	1101R
22103103	Aviation Snip Straight		18 ga	22 ga	M2003/MAXCG3	P6716-S	M3R	1102S
22105105	Aviation Snip Bulldog		16 ga	20 ga	M2005/MAXCG5	P6716-B	M5R	2103
22206206	Offset Snip Left		18 ga	22 ga	M2006/MAXCG6	P6510-L	M6R	2100L
22207207	Offset Snip Right		18 ga	22 ga	M2007/MAXCG7	P6510-R	M7R	2101R

HVAC TOOLS

Precision Sheet Metal Fabrication Tools

ULTIMATE SPRING DURABILITY

Reinforced Chrome Silicone valve-quality wire lasts for a lifetime

COMFORTABLE GRIPS

Over-molded handles won't slip or twist



PROD NO	DESCRIPTION	CUTTING CAPACITY		COMPETITIVE CROSS REFERENCE				
		SHEET METAL	STAINLESS STEEL	MALCO®	MIDWEST®	WISS®	KLEIN®	
22208C3	3 Blade Crimper		18 ga	22 ga	C3	—	HC3V	—
22209C5	5 Blade Crimper		18 ga	22 ga	C5	FCT-M-C5	HC5V	86550
22210S2	3" Seamer		18 ga	22 ga	S2	FCT-M-S1	HS1V	86553
22211N2	1" V Notcher		18 ga	22 ga	N2	—	—	—
22212SL1	Snap Lock Punch		18 ga	22 ga	SL1	FCT-M-L1	—	—
22213PDC4R	Pipe Duct Cutter		18 ga	22 ga	4R	FCT-M-P1	M14R	—

Malco is a registered trademark of Malco Products, Inc. Midwest is a registered trademark of Midwest Tool and Cutlery Company
Wiss is a registered trademark of Cooper Industries, Inc. Klein is a registered trademark of Klein Tools.



S1 PEX TUBING CUTTER

Perfect Cuts. Straight and Easy.

PERFECT CUTS. STRAIGHT AND EASY.

Serrated stainless steel blade requires less force to make a cut, leaving a flush end

COMFORTABLE GRIPS

Rubberized handles allow for confident cutting even in wet or dirty environments

EASY OPEN & CLOSE

Conveniently positioned locking latch allows for true one-handed operation of spring-loaded cutter

CUTS UP TO 1" NOMINAL

(1-5/16" MAX. OD)



Straight Cuts

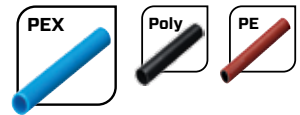

PROD NO	DESCRIPTION
12121S1	PEX Cutter
12125S1B	Plastic Tubing Cutter Replacement Blade

S2 CPVC TUBING CUTTER

Durable Construction

PERFECT CUTS. STRAIGHT AND EASY.

High carbon steel blade cuts rigid plastic tubing with a single cut

COMFORTABLE GRIPS

Rubberized handles allow for confident cutting even in wet or dirty environments

DURABLE CONSTRUCTION

Cast aluminum body stands up to rugged, repeated use

EASY OPEN & CLOSE

Conveniently positioned locking latch allows for true one-handed operation of spring-loaded cutter

CUTS UP TO 1" NOMINAL

(1-5/16" MAX. OD)



Easy Open & Close

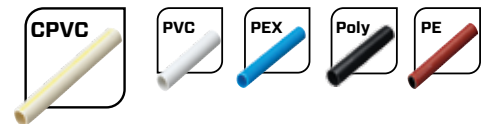

PROD NO	DESCRIPTION
12122S2	CPVC Cutter
12126S2B	Plastic Tubing Cutter Replacement Blade

R1 PVC TUBING CUTTER

Easy Ratcheting

PERFECT CUTS. STRAIGHT AND EASY.

Specifically designed jaw holds pipe in place while cutting with stainless steel blade

COMFORTABLE GRIPS

Rubberized handles allow for confident cutting even in wet or dirty environments

EASY OPEN & CLOSE

Conveniently positioned release button allows for true one-handed operation of ratcheting cutter, while locking tab secures blade in place

**CUTS UP TO 1-1/4" NOMINAL
(1-5/8" MAX. OD)**



Easy Ratcheting



One-Handed Operation

PROD NO	DESCRIPTION
12123R1	PVC Cutter
12127RB1	Plastic Tubing Cutter Replacement Blade

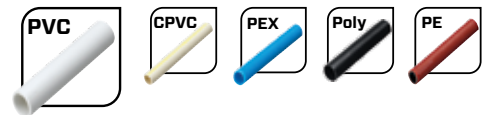

R2 PVC TUBING CUTTER

One-Handed Operation

PERFECT CUTS. STRAIGHT AND EASY.

Specifically designed jaw holds pipe in place while cutting with high-carbon steel blade

ONE-HANDED RATCHETING

One of the only large diameter cutters than can be ratcheted with just one hand

EASY OPEN

Pull both handles apart to quickly start the next cut

**CUTS UP TO 2" NOMINAL
(2-3/8" MAX. OD)**



Easy Ratcheting



One-Handed Operation

PROD NO	DESCRIPTION
12124R2	PVC Cutter
12128R2B	Plastic Tubing Cutter Replacement Blade

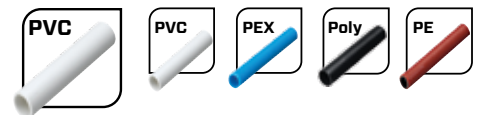



TUBING CUTTERS

Ergonomically Designed for Professional Performance

WON'T WALK WHILE CUTTING

Four roller tracking system keeps tube from threading

PROFESSIONAL DEBURRING

Cleanly and easily deburr pipes with the replaceable machinist's reamer

WILL NOT DAMAGE CUTTING WHEELS

Full-stop feed system prevents wheels and rollers from coming into contact

EASY TO USE

Change out wheels quickly & easily

CONVENIENT STORAGE

Store an extra cutting wheel in the handle



PROD NO	DESCRIPTION	TUBE DIAMETER RANGE		NUMBER OF WHEELS
		IN	MM	
21008TC58	Copper Cutting	1/8-5/8	3-16	1
21009TC1	Copper Cutting	1/8-1	3-25	2
21010TC118	Copper Cutting	1/8-1-1/8	3-29	2
21011TC138	Copper Cutting	1/8-1-3/8	3-35	2
21012TC134	Copper Cutting	1/8-1-3/4	3-45	2
21013TC258	Copper/Plastic Cutting	1/4-2-5/8	6-67	2



21008TC58



21009TC1



21010TC118



21011TC138



21012TC134



21013TC258

TIGHT SPACE TUBING CUTTERS

Cuts You Out of a Tight Spot

LESS BURR. MORE CUTS.

Optimized blade geometry of shock-resistant steel

COMPACT DESIGN FOR TIGHT SPOTS

Non-slip grooved cast aluminum body only needs 1/2" clearance to cut

NO RUSTING

Stainless steel rollers protect the cutter from corrosion

QUICK IDENTIFICATION

Color coding for easy tool recognition and cutting direction



PROD NO	DESCRIPTION	TUBE DIAMETER RANGE		NUMBER OF WHEELS
		IN	MM	
14830TS12	Copper Cutting	1/2	13	1
14831TS34	Copper Cutting	3/4	19	1
14832TS1	Copper Cutting	1	25	1
14833TSK	3 pc Kit	1/2, 3/4, 1	13,19,25	



14830TS12



14831TS34



14832TS1



14833TSK

Tubing Cutter Accessories

DESCRIPTION	1-PACK	2-PACK	6-PACK
	PROD NO	PROD NO	PROD NO
Stainless Steel Cutting Wheels*	—	21193TCW158SS2	21015TCW158SS
Plastic Cutting Wheels***	—	21191TCW158P2	21016TCW158P
Copper Cutting Wheels*	—	21192TCW158C2	21017TCW158C
Small Copper Cutting Wheels**	—	14829TSB	—
Replacement Deburrer fits 21011 & 21012 TC	21024TCD	—	—
Tubing Cutter Handle Screw****	21196TCHS	—	—

* Fits 21010, 21011, 21012, 21013 and many other competitors' Tubing Cutters

** Fits LENOX Product No 21008, 21009, 14830, 14831, 14832

*** Fits 21013

**** Fits LENOX Product No 21010-21013 only



Small Copper



Stainless Steel



Plastic



Copper



Deburrer



LOCKING TRADESMAN UTILITY KNIFE

Works Big. Folds Small.

EASY OPEN & CLOSE

Secure locking mechanism

COMFORT GRIP

Ergonomic rubberized grip

MULTI-USE TOOL

Bottle opener, screwdriver and pipe reamer

BUILT-IN WIRE STRIPPER

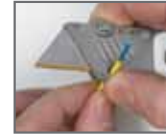

Wire Stripping



Pipe Reamer



Screwdriver



Bottle Opener

PROD NO	DESCRIPTION
10771FLK1	LENOX Gold® Locking Tradesman Utility Knife

UTILITY KNIVES

Durable Construction and Comfortable Grip for Extended Use

EXTREMELY DURABLE STAINLESS STEEL NOSE

One piece titanium coated nose resists wear and eliminates spreading

LONGEST LASTING UTILITY BLADES

Three shatterproof titanium edge blades included

EASY BLADE CHANGE

Quick blade release allows rotation or changing of blade without opening handle

INTERNAL BLADE STORAGE

Retractable knife stores up to five blades

Fixed knife stores up to ten blades

NO TOOL NEEDED TO OPEN



PROD NO	DESCRIPTION
20353SSRK1	LENOX Gold Quick Change Retractable Knife
20354SSFK1	LENOX Gold Fixed Blade Knife

UTILITY BLADES

Titanium Edge for Maximum Blade Life

LASTS LONGER

High speed steel edge with titanium coating keeps blades cutting after others have quit

SHATTERPROOF

Patented bi-metal construction allows blades to bend and flex without breaking

MAKES DEEPER CUTS

Four notch design allows blade to extend further

FITS ALL STANDARD UTILITY KNIVES

CUTS THE TOUGHEST MATERIALS

- Dry wall
- Insulation
- Flooring
- Roofing and more

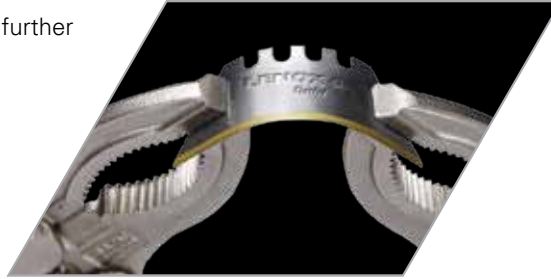

DESCRIPTION	5-PACK	50-PACK	100-PACK
	PROD NO	PROD NO	PROD NO
LENOX Gold Utility Knife Blade	20350GOLD5C	20351GOLD50D	20352GOLD100D

DISPENSERS

- Easy to use
- Dispenses one or five blades at a time
- 50 packs and 100 packs include dispensers

SELF-RETRACTING SAFETY KNIFE & BLUNT TIP SAFETY BLADES

A Safety Blade that Works

SMOOTH SELF-RETRACTION

Spring loaded shuttle

COMFORTABLE, NON-SLIP HANDLE

Ergonomic design

DUAL FUNCTION

Utility knife and box cutter settings

NO TOOL NEEDED FOR BLADE CHANGE

Quick blade changes

STORES UP TO 5 BLADES



PROD NO	DESCRIPTION
20366SRK1	Self-Retracting Safety Knife
20367BLUNT5C	Blunt Tip Safety Blade 5 pack
20368BLUNT50D	Blunt Tip Safety Blade 50 pack with Dispenser

INCREASED SAFETY

Blunt tip design

SHATTERPROOF

Patented bi-metal construction
Bends and flexes without breaking

LONG BLADE LIFE

High speed steel edge



SOFT STORAGE TOOL BAGS

GET ORGANIZED

Multiple pockets and storage options allow for easily locating the right tool

FUNCTIONAL DESIGN

Padded shoulder straps make carrying comfortable

Reflective materials make bag easy to find in darkness

Red liner helps to easily locate tools

HOLDS UP TO THE JOB

Water-resistant materials and reinforced rivets to withstand tough job site use



Tools not included

ELECTRICIAN'S TOTE

PROD NO	DESCRIPTION
1787422	10" Electrician's Tote

- 5 Open storage areas
- 12 Exterior pockets
- 16 Elastic loops
- 8 Interior pockets
- Tape measure clip
- Key clip
- Tape holder loop
- Small parts bin
- Clip on handle
- Padded shoulder strap
- Reflective material
- Reinforced rivets
- Water-resistant bottom
- Protective pad feet on bottom



Tape Loop



Key Clip



Handle Clip

CONTRACTOR'S TOOL BAG

PROD NO	DESCRIPTION
1787426	16" Contractor's Tool Bag

- Large open-mouth bag
- 14 Interior pockets
- Small parts bin
- Padded shoulder strap
- Reflective material
- Reinforced water-resistant bottom
- Protective pad feet on bottom



Small Parts Bin

PLUMBER'S TOTE

PROD NO	DESCRIPTION
1787474	19" Plumber's Tote

- 9 Exterior pockets
- 14 Interior pockets
- 10 Elastic loops
- Hacksaw pocket
- Tape measure clip
- Tape holder loop
- Foldable handle
- Padded shoulder strap
- Reflective material
- Hard plastic waterproof bottom



Hacksaw not included



Tape Loop

BUCKET TOOL ORGANIZER

PROD NO	DESCRIPTION
1787473	Bucket Tool Organizer

- 22 Exterior pockets
- 12 Interior pockets
- Hammer loop
- Tape hold loop
- Foldable handle
- Padded shoulder strap
- Side clips secure the organizer
- Reflective material



Bucket not included



Shoulder Strap



Side Clip



PIPE WRENCHES

Built for Extreme Durability

GRIPS TIGHTLY

Hardened teeth are ideal for most hard pipes, bolts and couplings

WITHSTANDS HIGH TORQUE

Enhanced durability for maximum torque

REDUCES HAND FATIGUE (CAST ALUMINUM)

Lightweight cast aluminum handle creates less arm stress



	PROD NO	SIZE		PIPE CAPACITY		RIDGID® COMPETITIVE CROSS REFERENCE	
		IN	CM	IN	MM	CAT NO	MODEL NO
CAST ALUMINUM	2382010ALPW	10	25	1-1/2	40	31090	810
	2382112ALPW	12	30	2	50	47057	812
	2382214ALPW	14	36	2	50	31095	814
	2382318ALPW	18	46	2-1/2	65	31100	818
	2382424ALPW	24	61	3	80	31105	824
	2382536ALPW	36	91	5	125	31110	836
	2382648ALPW	48	122	6	150	31115	848
HEAVY-DUTY CAST IRON	2381208HDPW	8	20	1	25	31005	8
	2381310HDPW	10	25	1-1/2	40	31010	10
	2381412HDPW	12	30	2	50	31015	12
	2381514HDPW	14	36	2	50	31020	14
	2381618HDPW	18	46	2-1/2	65	31025	18
	2381724HDPW	24	61	3	80	31030	24
	2381836HDPW	36	91	5	125	31035	36
	2381948HDPW	48	122	6	150	31040	48

RIDGID® is a trademark of Ridge Tool Company

ALL-IN-ONE SCREWDRIVERS

More Torque. More Power.

COMFORTABLE GRIP

Slip-resistant ergonomic grip for maximum torque

REDUCED STRIPPING

25% thicker nut driver for longer life

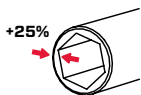

PROD NO	DESCRIPTION	⊕ #1	⊕ #2	⊖ 3/16"	⊖ 1/4"	⊙ 1/4"	⊙ 5/16"	⊖ #2	⊖ #3	⊙ 3/8"
23931	6-1 Screwdriver	•	•	•	•	•	•	—	—	—
23932	9-1 Screwdriver	•	•	•	•	•	•	•	•	•



DEMOLITION

Limited Warranty

TRADEMARK INFORMATION

INCONEL is a registered trademark of Huntington Alloys Corporation.
DURANICKEL, INCOLOY, MONEL and NI-SPAN C are registered trademarks of Inco Alloys International, Inc.
RENE 41 is a registered trademark of Teledyne Industries, Inc.
LITHONIA is a registered trademark of Lithonia, Inc.
LIGHTOLIER is a registered trademark of Lightolier, Inc.
PRESCOLITE is a registered trademark of Prescolite, Inc.
HUBBELL is a registered trademark of Hubbell, Inc.
MILWAUKEE is a registered trademark of Milwaukee Electric Tool Corp.
DEWALT is a registered trademark of Black & Decker Corporation.
MORSE is a registered trademark of M.K. Morse Company.
BOSCH is a registered trademark of Robert Bosch Tool Corporation.
NIMONIC is a registered trademark of Henry Wiggin & Company, Ltd.
KLEIN is a registered trademark of Klein Tools.
MALCO is a registered trademark of Malco Products, Inc.
MIDWEST is a registered trademark of Midwest Tool and Cutlery Company.
WISS is a registered trademark of Cooper Industries, Inc.
RIDGID is a registered trademark of Ridgid Tool Company.
NICHOLSON is a registered trademark of Cooper Hand Tools.
STARRETT is a registered trademark of the L.S. Starrett Company.

THE LENOX GUARANTEE

Our products are backed by the LENOX limited warranty. We warrant that our products are free from defects in materials and workmanship and that these products will perform as described under normal use and service. This warranty of quality is valid for 90 days from confirmed date of purchase. Except as expressly set forth herein, LENOX makes no other warranties, express or implied, with regard to products, and expressly disclaims any warranty of fitness for a particular purpose. This warranty gives you specific legal rights and you may also have other rights which vary from state to state. Use our products only in accordance with LENOX instructions.

GENERAL SAFETY TIPS

LENOX is involved in the Voluntary Protection Program (VPP), designed to recognize and promote effective safety and health management. Our employees agree to participate in the program and work with management to assure a safe and healthful workplace under an established set of criteria. Several benefits to the VPP are the motivation to work safely, reduced workers' compensation costs and fewer lost workdays due to injuries. This all results in better quality and productivity.

We are also very concerned for the safety of the people using our products. Here are a few tips to remind you to use all safety measures to avoid any type of injury:

1. Tools can injure – handle with care.
2. When cutting through walls, be sure you're clear of electrical wires behind the wall.
3. Power tools can bind and kick back. Be sure to hold them firmly and keep yourself out of the recoil path.
4. Wear eye protection and other appropriate safety equipment when using tools.
5. Make sure ladders or staging are stable before using.
6. When using drilling accessories, a power tool with a torque limiting device is recommended.
7. Use power tools in accordance with manufacturers' instructions and recommendations for accessories.

 facebook.com/lenoxtools

 twitter.com/lenoxtools

 youtube.com/lenoxtools

Customer Service: 800-628-8810

Technical Support: 800-642-0010

lenoxtools.com

5204A

301 Chestnut Street, East Longmeadow, MA 01028-0504 USA

©1/2013 LENOX, Newell Rubbermaid