



Bullhorn bracket safely supports HID floodlights. Great with Floodzilla, Megaflood and Flexflood models.

Color: Galvanized

Weight: 21.9 lbs

Project:	Type:
Prepared By:	Date:

Technical Specifications

Construction

Mounting:

BULL2W is for mounting slipfitter fixtures onto wooden poles

Finish:

Galvanized steel

Bullhorns:

2 tenons for slip fitters. Bullhorns fit 2 3/8" (6cm) O.D. tenons and accommodate 2 3/8" (6cm) slip fitters. Steel tubing .150" and .200" thick welded.

EPA:

Maximum EPA of 5.4 and 105 lbs per arm, total EPA of 10.8 and 210 lbs per BULL2W in a 80 MPH wind zone 1.3 gust factor
 Maximum EPA pf 2.65 and 84 lbs per arm, total EPA of 5.3 and 168 lbs per BULL2W in a 150 MPH wind zone 1.3 gust factor
 Per AASHTO 2015

Other

Patents:

The designs of fixtures are protected under U.S. and international intellectual property laws.

Buy American Act Compliance:

RAB values USA manufacturing! Upon request, RAB may be able to manufacture this product to be compliant with the Buy American Act (BAA). Please contact customer service to request a quote for the product to be made BAA compliant.

Dimensions

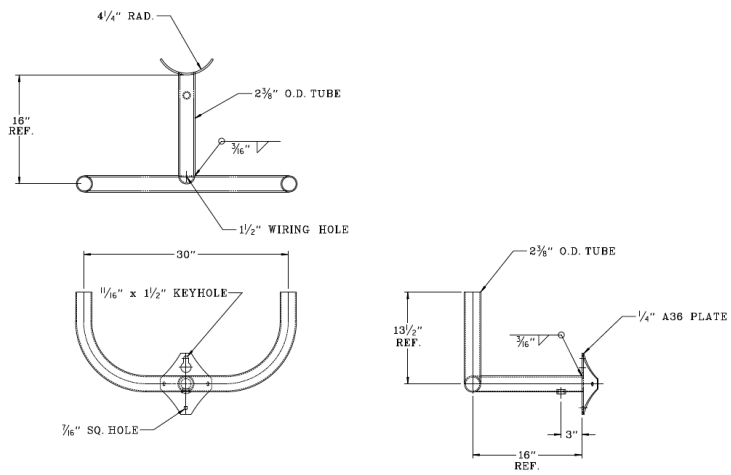

Features

- Easy, secure floodlight mounting
- Double Reinforced weld joints