



High performance LED Vaporproof fixture. A classic design with cutting edge LED technology. Comes with die cast guard and frosted globe. Specially designed for mounting as an uplight.

Color: Natural

Weight: 5.0 lbs

Project:	Type:
Prepared By:	Date:

Driver Info		LED Info	
Type	Constant Current	Watts	13W
120V	0.13A	Color Temp	4000K (Neutral)
208V	0.08A	Color Accuracy	88 CRI
240V	0.07A	L70 Lifespan	100,000 Hours
277V	0.06A	Lumens	595 lm
Input Watts	15.2W	Efficacy	39.1 lm/W

Technical Specifications

Compliance

UL Listed:

Suitable for wet locations. Suitable for mounting within 4ft (1.2m) of the ground.

IESNA LM-79 & LM-80 Testing:

RAB LED luminaires and LED components have been tested by an independent laboratory in accordance with IESNA LM-79 and LM-80.

Performance

Lifespan:

100,000-Hour LED lifespan based on IES LM-80 results and TM-21 calculations

Wattage Equivalency:

Equivalent to 26W CFL

Construction

Specification:

These specifications are for fixture with Frosted Glass Globe and Die Cast Guard combination. Consult warehouse for different fixture combinations.

Construction:

Die cast aluminum housing and door. Tether connects back housing halves for safety.

Cold Weather Starting:

The minimum starting temperature is -40°C (-40°F)

Ambient Temperature:

Suitable for use in up to 35°C (95°F)

Housing:

Die-cast aluminum housing and driver housing

Guard and Globe:

Shot blasted guard with frosted globe

Reflector:

High quality hydroformed semi-specular aluminum

Gaskets:

High-temperature Silicone

Finish:

Natural shot blasted aluminum

Green Technology:

Mercury and UV free. RoHS-compliant components.

Electrical

Driver:

Multi-chip single 13W high output long life LED Driver. Constant Current,100V-277V, 50/60 Hz., 100-240VAC.3-.15 Amps 277VAC.15 Amps. Will deliver 70% of its initial lumens at 100,000 hours based onlm-80 Tests.

THD:

6.1% at 120V, 10.1% at 277V

Surge Protection:

4kV

Installation

Mounting:

Three 3/4" NPS conduit entry points

LED Characteristics

Color Consistency:

3-step MacAdam Ellipse binning to achieve consistent fixture-to-fixture color

Color Stability:

LED color temperature is warrantied to shift no more than 200K in color temperature over a 5-year period

Color Uniformity:

RAB's range of Correlated Color Temperature follows the guidelines of the American National Standard for Specifications for the Chromaticity of Solid State Lighting (SSL) Products, ANSI C78.377-2017.

Technical Specifications (continued)

Other

Warranty:

RAB warrants that our LED products will be free from defects in materials and workmanship for a period of five (5) years from the date of delivery to the end user, including coverage of light output, color stability, driver performance and fixture finish. RAB's warranty is subject to all terms and conditions found at rablighting.com/warranty.

Patents:

The VXBRLED design is protected by U.S. Pat. D673,319 and in Taiwan Pat. D150463.

Dimensions

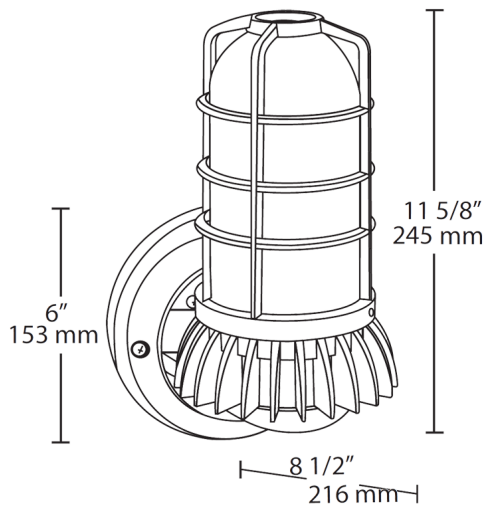

Features

- Specially designed for mounting as an uplight
- 100,000-hour life based on LM-80 results and TM-21 calculations
- Die Cast Aluminum Housing
- Classic design with state of the art LED technology
- Frosted globe emits uniform glow