

FAG

3211-BD-XL-TVH-L285

Angular contact ball bearing

Schaeffler ID:
0703190300000

Angular contact ball bearing 32..-BD-XL-TVH, double row, X-life, plastic cage

X-life

Technical information

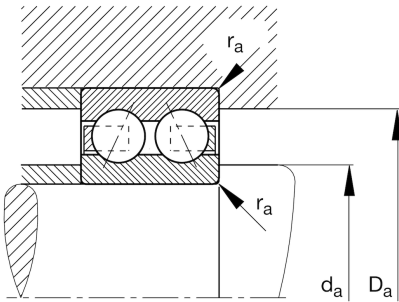
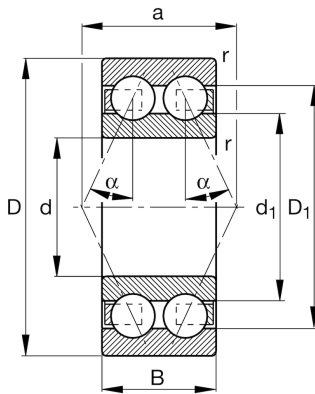

Main Dimensions & Performance Data

d	2,165 in	Bore diameter
D	3,937 in	Outside diameter
B	1,311 in	Width
C_r	13.714,029 lbf	Basic dynamic load rating, radial
C_{0r}	11.465,827 lbf	Basic static load rating, radial
C_{ur}	798,112 lbf	Fatigue load limit, radial
n_G	5.300 1/min	Limiting speed
n_{gr}	7.200 1/min	Reference speed
	2,105 lbs	Weight

Mounting dimensions

$d_{a \min}$	2,52 in	Minimum diameter shaft shoulder
$D_{a \max}$	3,583 in	Maximum diameter of housing shoulder
$r_{a \max}$	0,059 in	Maximum fillet radius

Dimensions

r_{\min}	0,059 in	Minimum chamfer dimension
D_1	3,457 in	Shoulder diameter outer ring
d_1	2,819 in	Shoulder diameter inner ring
a	2,299 in	Distance between the apexes of the pressure cones
α	30 °	Contact angle

Temperature range

T_{\min}	-4 °F	Operating temperature min.
T_{\max}	248 °F	Operating temperature max.