

# PRODUCT INFORMATION PACKET

Model No: 284TTTNA17101  
Catalog No: S567  
10,900,TEAO,284T,3/60/575  
Other Purpose



Regal and Marathon are trademarks of Regal Beloit Corporation or one of its affiliated companies.  
©2018 Regal Beloit Corporation, All Rights Reserved. MC017097E





### Nameplate Specifications

Output HP	<b>10 Hp</b>	Output KW	<b>7.46 kW</b>
Frequency	<b>60 Hz</b>	Voltage	<b>575 V</b>
Current	<b>12.1 A</b>	Speed	<b>880 rpm</b>
Service Factor	<b>1.15</b>	Phase	<b>3</b>
Efficiency	<b>88.5 %</b>	Duty	<b>CONTINUOUS</b>
Insulation Class	<b>H</b>	Design Code	<b>B</b>
KVA Code	<b>F</b>	Frame	<b>284T</b>
Enclosure	<b>TEAO</b>	Overload Protector	<b>NOT</b>
Ambient Temperature	<b>90 °C</b>	Drive End Bearing Size	<b>6311</b>
Opp Drive End Bearing Size	<b>6210</b>	UL	<b>No</b>
CSA	<b>Y</b>	CE	<b>N</b>
IP Code	<b>54</b>		

### Technical Specifications

Electrical Type	<b>SQ CAGE INV RATED</b>	Starting Method	<b>LINE OR INVERTER</b>
Poles	<b>8</b>	Rotation	<b>REV</b>
Mounting	<b>RIGID</b>	Motor Orientation	<b>HORIZONTAL</b>
Drive End Bearing	<b>BALL / HEAT STABILIZED</b>	Opp Drive End Bearing	<b>BALL / HEAT STABILIZED</b>
Frame Material	<b>CAST IRON</b>	Shaft Type	<b>T</b>
Overall Length	<b>23.42 in</b>	Frame Length	<b>12.75 in</b>
Shaft Diameter	<b>1.88 in</b>	Shaft Extension	<b>4.83 in</b>
Assembly/Box Mounting	<b>F1/F2 CAPABLE</b>		
Outline Drawing	<b>B-SS311239-1275</b>	Connection Diagram	<b>A-EE7300T</b>

This is an uncontrolled document once printed or downloaded and is subject to change without notice. Date Created: 04/05/2018

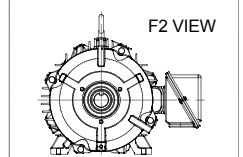
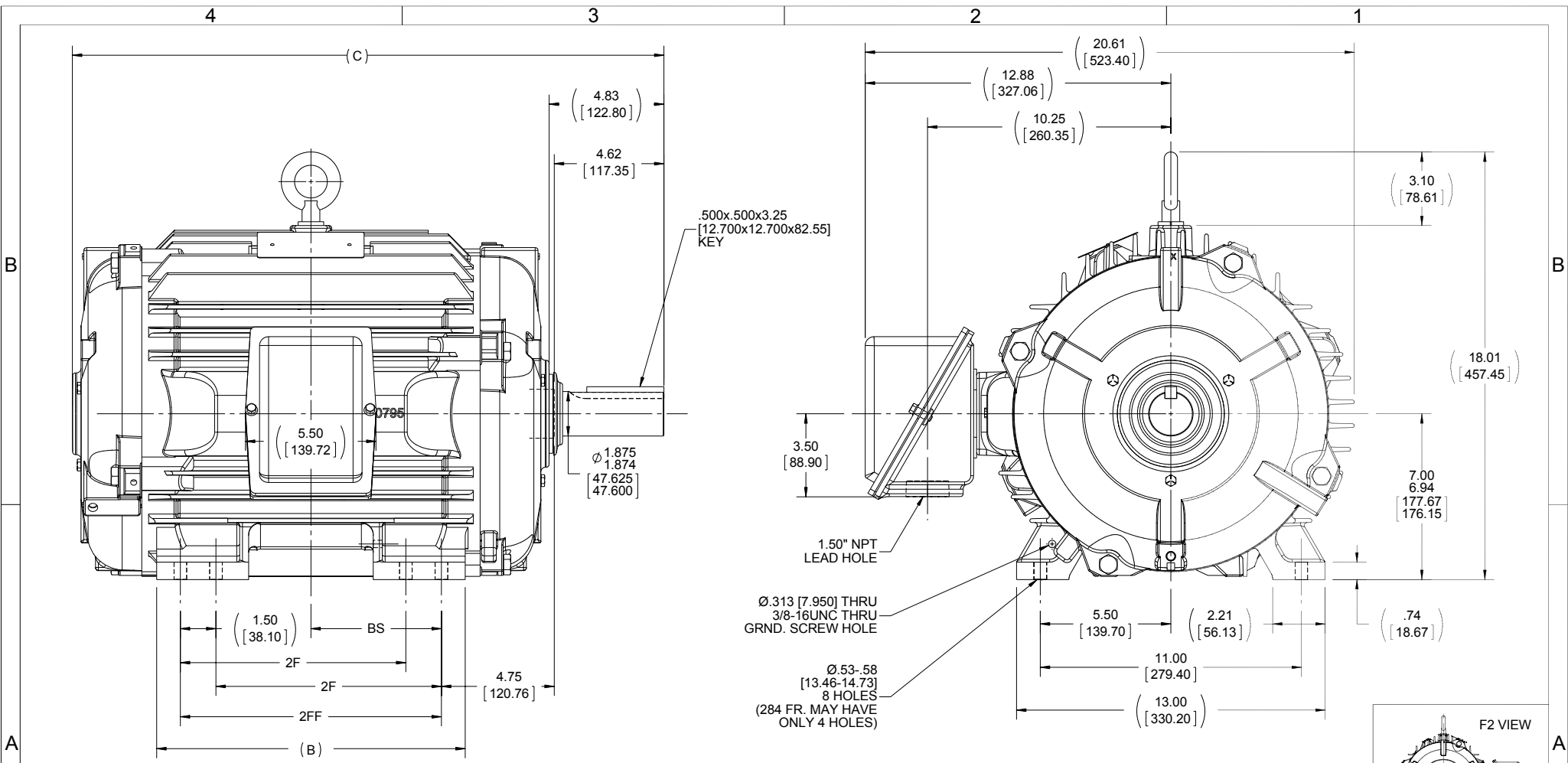

- NOTES:  
 1. CONDUIT BOX CAN BE ROTATED IN 90° STEPS.  
 2. CONDUIT BOX CAN BE MOUNTED ON OPPOSITE SIDE BY REMOVING BRACKETS AND TURNING FRAME 180°.  
 3. NAMEPLATE TO BE READ FROM CONDUIT BOX SIDE OF MOTOR.

DASH	FRAME	B	C	BS	2F	2FF
1275	284T	12.50 [317.50]	23.42 [594.87]	4.75 [120.65]	---	9.50 [241.30]
1425	284/286T	13.00 [330.20]	24.92 [632.97]	5.50 [139.70]	9.50 [241.30]	11.00 [279.40]

DRAWING REVISION E	REVISION BY W. JOERGER	DATE 07-01-2015
ECO ECO-0080734	APPROVED BY E. HEIL	DATE 07-01-2015
ECO DESCRIPTION REMOVED COVER PLATE AND SEAL FROM O.D.E.		

COPYRIGHT REGAL BELOIT AMERICA, INC. ALL RIGHTS RESERVED.  
 PROPRIETARY AND CONFIDENTIAL INFORMATION - THIS DOCUMENT IS THE PROPERTY OF REGAL BELOIT AMERICA, INC. (OWNER) AND CONTAINS OWNER'S PROPRIETARY INFORMATION. ANY PERSON, CORPORATION OR OTHER FIRM RECEIVING IT IS DEEMED, BY RECEIVING IT, TO AGREE THAT IT, AND/OR ANY PART OF IT, SHALL NOT BE DISCLOSED TO ANY PERSON, CORPORATION OR OTHER ENTITY, DUPLICATED, AND/OR USED, EXCEPT AS EXPRESSLY APPROVED IN WRITING IN ADVANCE BY OWNER. THIS DOCUMENT SHALL BE RETURNED TO OWNER UPON REQUEST. IT MAY BE SUBJECT TO CERTAIN RESTRICTIONS UNDER APPLICABLE EXPORT CONTROL LAWS AND REGULATIONS.

TOLERANCES UNLESS OTHERWISE SPECIFIED:		
DEC.	INCH	mm
.X	+0.1	[+2.5]
.XX	+0.03	[+0.76]
.XXX	+0.005	[+0.127]
.XXXX	+0.0005	[+0.0127]
REMOVE BURRS & BREAK SHARP		
EDGES: .003/.015 [0.076/3.81]		
CORNER FILLETS: .02 [51]		
MACHINED SURFACES: 200 5.1		
mm SHOWN IN [BRACKETS]		

DRAWN BY NJS
DATE 10-03-2001
APPROVED BY BW
DATE 10-05-2001
REFERENCE
THIRD ANGLE PROJECTION

<b>REGAL</b> ™ Regal Beloit America, Inc.	
DESCRIPTION <b>OUTLINE</b> 280T FR. - TEAO / TENV - BB - STD - 12.50" LAM	
MATERIAL	PROCESS/FINISH
SIZE B	DRAWING NUMBER SS311239
	SHEET 1 OF 1

**THREE PHASE - SINGLE VOLTAGE  
MOTOR - CONDUIT BOX @ 'A'**

**TO REVERSE ROTATION:  
INTERCHANGE ANY TWO LINE  
LEAD CONNECTIONS**

**NOTE FOR FACTORY USE ONLY:  
TO SURGE TEST:  
FOR 3 LEAD COMMON CONNECT:  
CONNECT P1 TO T1 THEN P2 TO L1  
FOR 6 LEAD COMMON CONNECT:  
CONNECT P1 TO BOTH T1  
THEN P2 TO L1**

TERMINAL BLOCK WHEN SPECIFIED

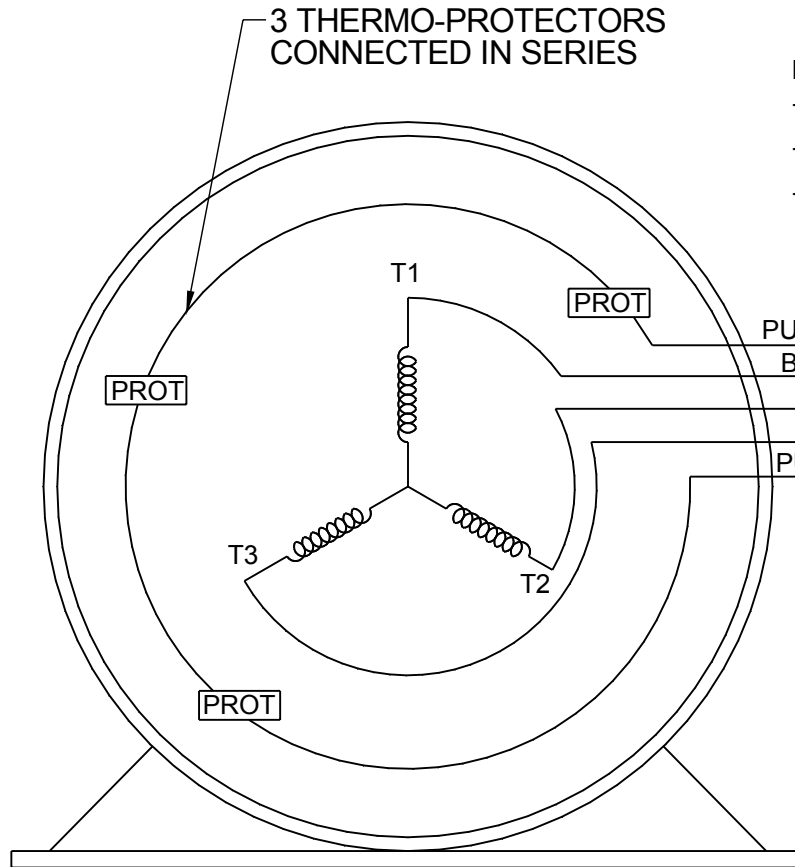
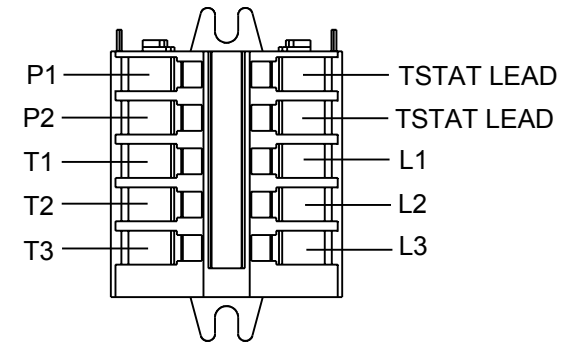

- PURPLE P1 (TB1)
- BLACK T1 (U1)
- RED T2 (V1)
- BLUE T3 (W1)
- PURPLE P2 (TB2)

- T2BM
- T6AW
- T6AL
- T6Z
- T4EG
- T4BF
- T8A
- T6H
- T6A
- T4AX
- T4A
- T2A
- T2F

**IF MOTOR HAS MULTIPLE  
T'S PER LEAD CONNECT  
TOGETHER LIKE T'S**

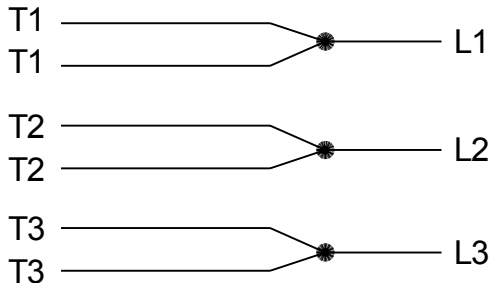

**A-9806 DECAL**

DRAWING REVISION AB	REVISION BY AJW	DATE 07-17-2015
ECO ECO-0081632	APPROVED BY T.VUE	DATE 07-17-2015
ECO DESCRIPTION REV'D IEC MARKINGS PER IEC-60034-8		
<small>COPYRIGHT REGAL BELOIT AMERICA, INC. ALL RIGHTS RESERVED. PROPRIETARY AND CONFIDENTIAL INFORMATION - THIS DOCUMENT IS THE PROPERTY OF REGAL BELOIT AMERICA, INC. ("OWNER") AND CONTAINS OWNER'S PROPRIETARY INFORMATION. ANY PERSON, CORPORATION OR OTHER FIRM RECEIVING IT IS DEEMED, BY RECEIVING IT, TO AGREE THAT IT, AND/OR ANY PART OF IT, SHALL NOT BE DISCLOSED TO ANY PERSON, CORPORATION OR OTHER ENTITY, DUPLICATED, AND/OR USED, EXCEPT AS EXPRESSLY APPROVED IN WRITING IN ADVANCE BY OWNER. THIS DOCUMENT SHALL BE RETURNED TO OWNER UPON REQUEST. IT MAY BE SUBJECT TO CERTAIN RESTRICTIONS UNDER APPLICABLE EXPORT CONTROL LAWS AND REGULATIONS.</small>		

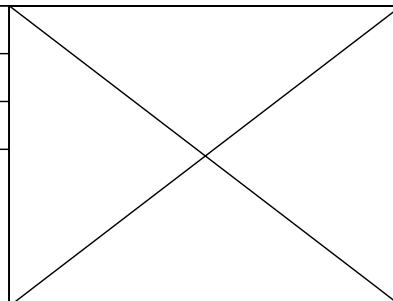

DRAWN BY LZ	Regal Beloit America, Inc.	
DATE 01-04-1994		
APPROVED BY GK	DESCRIPTION <b>CONN DIAGRAM-EXTERNAL</b> 3Ø-SINGLE VOLT-MOTOR WITH PROTECTOR	
DATE 01-20-1994	MATERIAL	
REFERENCE	PROCESS/FINISH	
THIRD ANGLE PROJECTION	SIZE <b>A</b>	DRAWING NUMBER <b>EE7300T</b>
		SHEET 1 OF 1



Data Sheet

Date: 29-06-2017  
 Customer: \_\_\_\_\_  
 Attention: \_\_\_\_\_  
 Submitted by: FAREEDA DUDEKULA



284TTTNA17101

Submittal

Data @ 575 V

Motor Load Data									
Load	0%	25%	50%	75%	100%	115%	125%	LR	
Current (Amps)	6.6	7.0	8.2	9.9	12.2	13.6	14.8	52.0	
Torque (ft-lb)	0.00	14.7	29.5	44.5	60.0	69.5	75.5	75.0	
RPM	900	895	890	885	880	875	870	0	
Efficiency (%)		81.5	87.5	89.5	88.5	88.5	87.5		
P.F. (%)	5.5	33.0	52.0	63.0	68.0	70.0	71.0	26.0	

Motor Speed Data						Information Block	
	LR	Pull-Up	BD	Rated	Idle		
Speed (RPM)	0	400	825	880	900	HP	10.0
Current (Amps)	52.0	48.0	30.4	12.2	6.6	Sync. RPM	900
Torque (ft-lb)	75.0	68.0	120	60.0	0.00	Frame	284
						Enclosure	TEAO

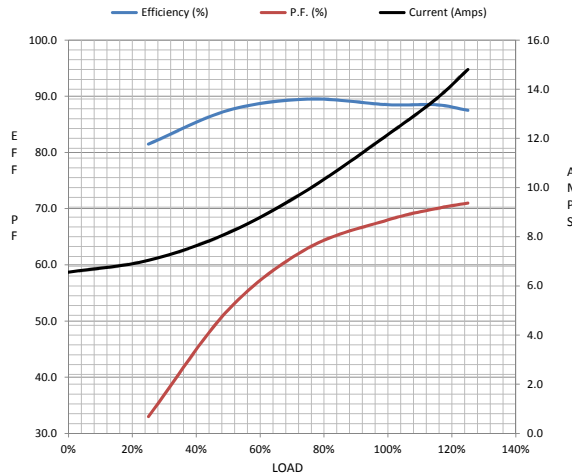

Construction	TTN			
Voltage	575 V			
Frequency	60 Hz			
Design	B			
LR Code letter	F			
Service Factor	1.15			
Temp Rise @ FL	0 ° C			
Duty	CONT			
Ambient	40 ° C			
Elevation	1,000 feet			
Rotor/Shaft wk <sup>2</sup>	4.4 Lb-Ft <sup>2</sup>			
Ref Wdg	K284837 NONE			
Sound Pressure @ 1M	999 dBA			
VFD Rating	VARIABLE 20:1			
Outline Dwg	B-SS311239-1275			
Conn. Diag	A-EE7300T			
Additional Specifications:				
0				
365THFS8036				
EQUIV CKT (OHMS / PHASE)				
R1	R2	X1	X2	Xm
0.7320	0.7460	3.9760	6.4790	49.1680

