

PRODUCT INFORMATION PACKET

Model No: 5KC49TN0067
Catalog No: C376
1,1725,TEFC,56C,1/60/115/208-230
Totally Enclosed Fan Cooled (TEFC)



Regal and Marathon are trademarks of Regal Beloit Corporation or one of its affiliated companies.
©2018 Regal Beloit Corporation, All Rights Reserved. MC017097E





Nameplate Specifications

Output HP	1 Hp	Output KW	0.75 kW
Frequency	60 Hz	Voltage	115/208-230 V
Current	13.2,6.7-6.6 A	Speed	1725 rpm
Service Factor	1	Phase	1
Efficiency	69.1 %	Duty	CONT
Insulation Class	B	KVA Code	K
Frame	56C	Enclosure	TEFC
Overload Protector	N/R	Ambient Temperature	40 °C
Drive End Bearing Size	6203	Opp Drive End Bearing Size	6203
UL	Recognized	CSA	Yes
CE	N		

Technical Specifications

Electrical Type	Capacitor start(CSIR)	Starting Method	SM
Poles	4	Rotation	CCW/CW
Mounting	WB	Motor Orientation	ANY
Drive End Bearing	BALL	Opp Drive End Bearing	LOCKED
Frame Material	Rolled Steel	Overall Length	12.96 in
Frame Length	7.68 in	Shaft Diameter	0.63 in
Shaft Extension	1.88 in		
Outline Drawing	52A107662P3	Connection Diagram	52A105381BA

This is an uncontrolled document once printed or downloaded and is subject to change without notice. Date Created: 04/05/2018

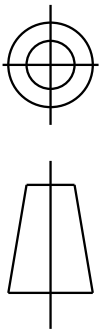

REV.	DESCRIPTION	DATE	APPROVED
11	CHG TO RBC FORMAT PER IS05-11777	03/01/06	ARCHANA

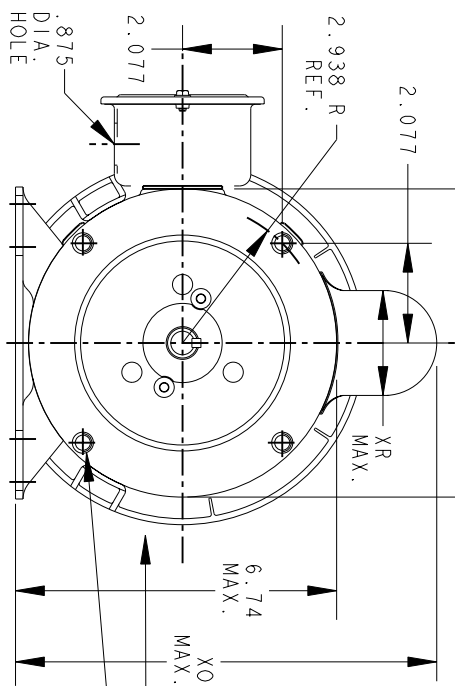
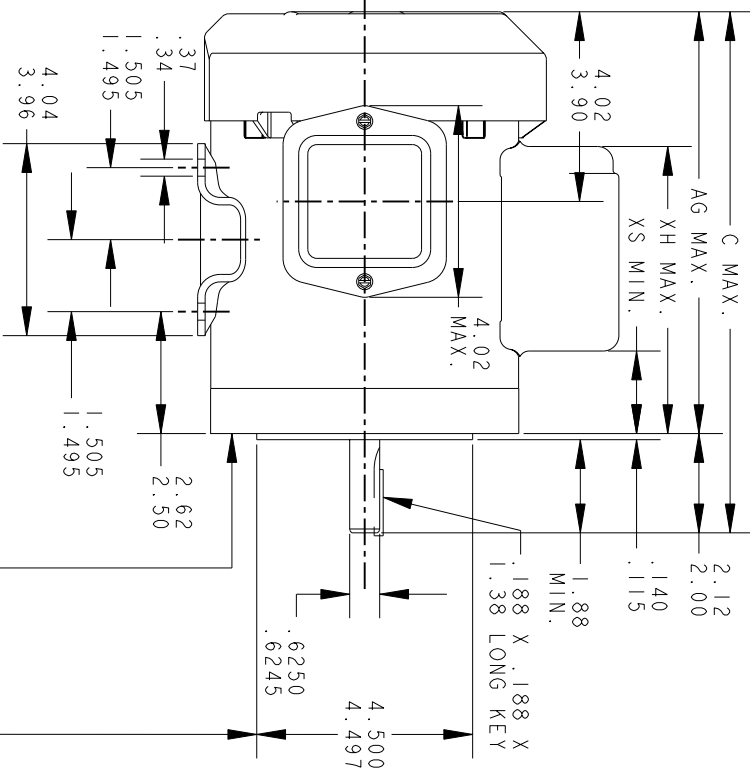
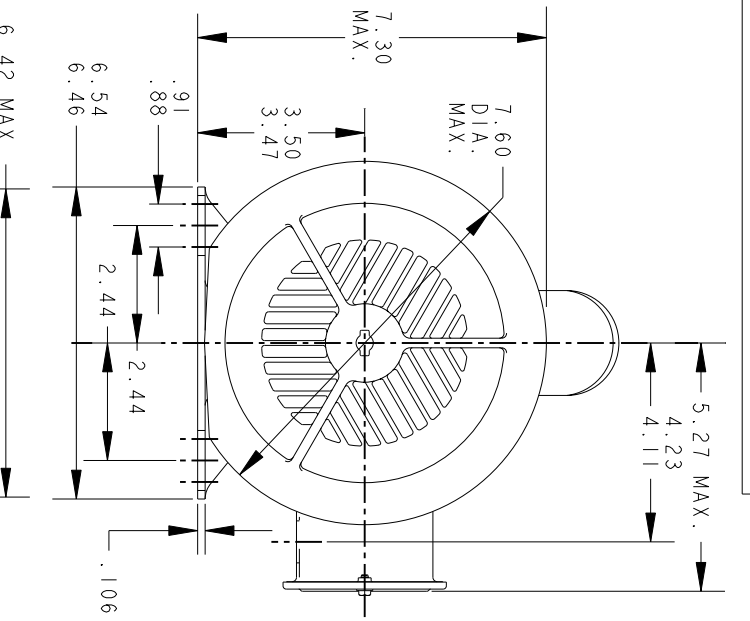

FACE RUNOUT (WITH INDICATOR MOUNTED STATIONARY RELATIVE TO SHAFT) MUST NOT EXCEED .004 T.I.R.

ECCENTRICITY OF THIS SURFACE (WITH INDICATOR MOUNTED STATIONARY RELATIVE TO SHAFT) MUST NOT EXCEED .004 T.I.R.

VIEW OF P.E. END SHIELD

.375-16 UNC-2B (4 HOLES) .70 MIN. FULL THREAD. THESE HOLES FIT A GAGE HAVING A RABBIT DIA. AND 4 PINS .2917 DIA. LOCATED ON THE BASIC HOLE POSITIONS.

P	TYPE	GE SIZE	NEMA FR	C	AG	XH	XO	XR	XS	MIN. SHELL
6	KC	49	56CY	12.97	10.85	7.61	8.69	2.15	1.86	7.68
5	KC	49	56CY	12.40	10.28	7.50	8.95	2.22	2.07	7.15
4	KC	49	56CY	12.44	10.32	7.54	8.22	1.60	1.79	7.15
3	KC	49	56CY	12.97	10.85	7.61	8.94	2.40	1.86	7.68
2	KC	46	56CY	11.84	9.72	6.48	8.84	2.22	1.94	6.55
1	KC	42	56CY	11.01	8.89	6.12	8.84	2.22	1.58	5.72

REGAL-BELOTT CORPORATION

TITLE **40 FRAME REDESIGN - GENERAL PURPOSE MOTOR - TEFC BALL BEARING - WELDED BASE - R2 END MOUNTED**

SIGNATURES		DATE
MODEL	M.D. PAPE	04/18/91
DETAIL		
CHECKED		
ENGRG		
MFG		
QUALITY		
ISSUED	M.D. PAPE	10/22/02
SOLID MODEL:	52A107662	

SIZE	SCALE	REF. No.	SHEET
A	0.003		1 of 1

52A107662 11

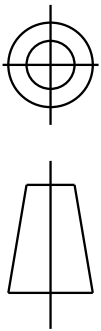

REV.
3

DESCRIPTION
UPDATED FORMAT

DATE
01/04/06

APPROVED
MAM

CCW/CW ROTATION - DUAL VOLTAGE
TYPE KC OR KH

CAPACITOR AS SHOWN FOR KC MOTORS ONLY. LEAD T5 BLACK CONNECTED DIRECTLY TO TERMINAL BOARD FOR KH MOTORS.

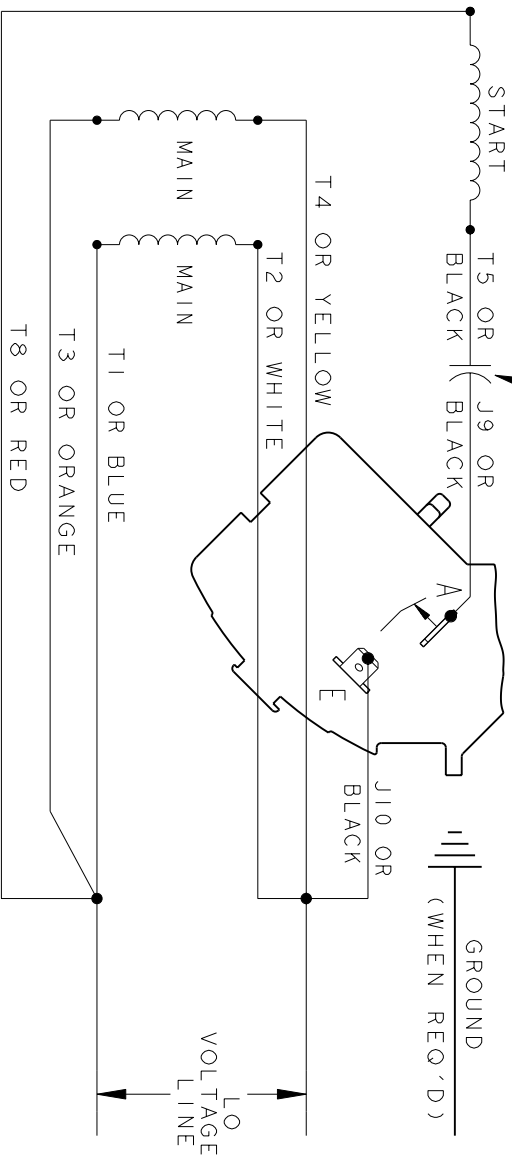

CAPACITOR AS SHOWN FOR KC MOTORS ONLY. LEAD T5 BLACK CONNECTED DIRECTLY TO TERMINAL BOARD FOR KH MOTORS.

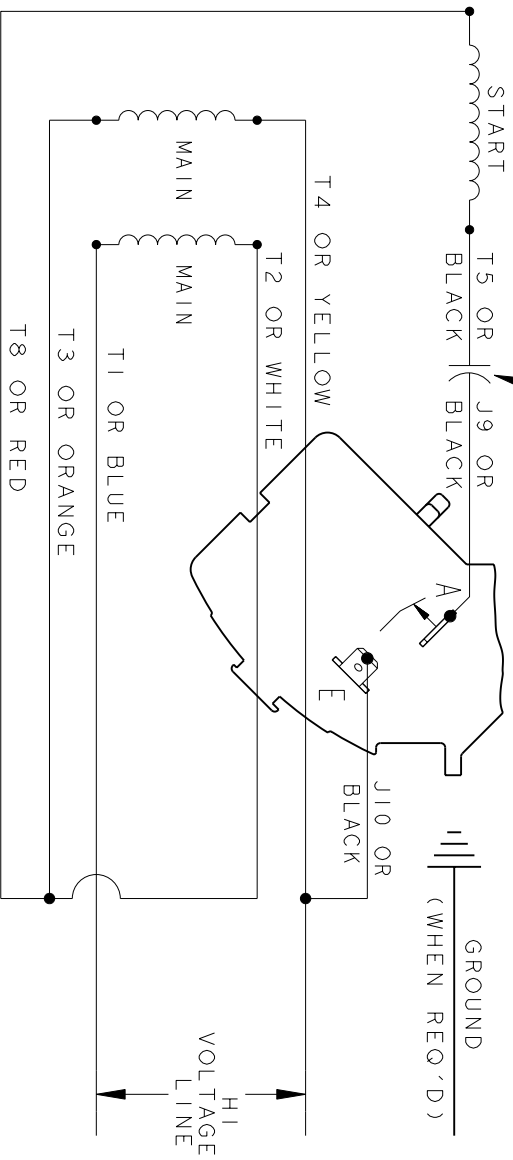

NOTE#1 - TO REVERSE ROTATION, INTERCHANGE T8 RED AND J10 BLACK LEADS.
NOTE#2 - WHEN MORE THAN ONE CAPACITOR IS USED, CONNECT IN PARALLEL.

SWITCH (H) - 115D958AA

REF. DIAG. - 113A326

CONNECTION LABEL - 52X332917

SIGNATURES		DATE
MODEL	M.D. PAPER	06/29/87
DETAIL		
CHECKED		
ENGRG		
MFG		
QUALITY		
ISSUED	M.D.P.	06/29/87
FOR ADDITIONAL INFO REFER TO:		
APPLIED PRACTICES		
DIMENSIONS ARE IN INCHES		
MATERIAL	SOLID MODEL: 52A105381BA	



REGAL-BELOIT CORPORATION

TITLE
CONNECTION DIAGRAM

FME: 30 FRAME SWITCH REDESIGN

52A105381BA

REV
3

SCALE: 1.000 REF. No: .

SHEET 1 of 1