

FRONT VIEW

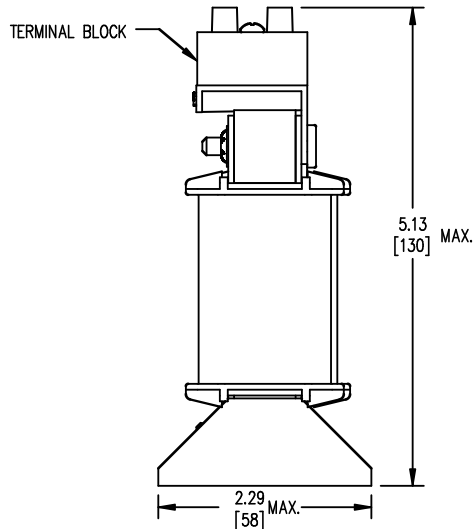

SIDE VIEW

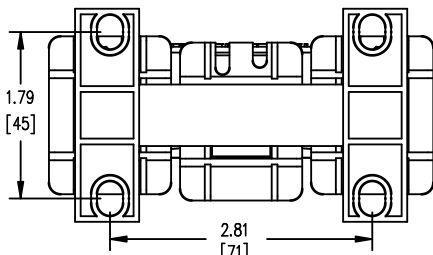

BOTTOM VIEW

TERMINAL BLOCK
SUITABLE FOR
#14 TO #18 AWG
CONDUCTORS
QTY. 1 PER PHASE

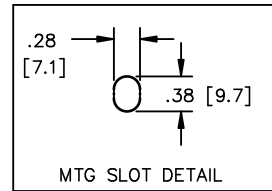

TOLERANCES
MOUNTING CENTERS = +/- .06"
MOUNTING HOLE SIZE = +/- .005"

THIS DRAWING CONTAINS PROPRIETARY INFORMATION
BELONGING TO HAMMOND POWER SOLUTIONS INC.,
AND IS NOT FOR GENERAL DISTRIBUTION

All Dimensions in Inches
mm in Parenthesis

REACTOR



HPS CENTURION R
THREE PHASE DRY TYPE REACTOR
Hammond
Power Solutions CRX06D6AC
1.5MH 50/60 HZ 6.6 AMPS

1003781e

0.6 KV CLASS TEMP CLASS: 130 TYPE JR-1
TERMINAL TORQUE: 5 LB-IN AMBIENT: 50°C

NOTES:



Hammond Power
Solutions Inc.

TITLE: 3 PHASE LINE REACTOR

DES:	PBAKER		
DATE:	14/06/24		
SCALE:	NTS		
NO.	DATE	BY	REVISION

SHEET 1 OF 1

EDBCRX06D6AC

0.0 jwen 2023/01/31 12:12