

# Packaged Performance Products

---

## Electromagnetic Clutches and Brakes

### Packaged Products Benefits

Warner Electric Packaged Products come pre-assembled, ready to install right out of the box.

Warner Electric Packaged Products consist of a single part number in most cases. One part number to inventory, one part number to track in your engineering system.

All Warner Electric packaged products incorporate our Autogap™ mechanism that automatically adjusts for wear. This eliminates the need for maintenance, but more importantly, it ensures the same engagement time cycle after cycle after cycle through the whole life of the unit ensuring consistent product manufacturing processes.

Warner Electric Packaged designs are available for:

- C-face mount applications
- Parallel shaft applications
- Base mount applications

### The Basics

The electric clutch and brake has been called the best thing that ever happened to the electric motor. It's simple, electric clutches and brakes do all the work, while permitting motors to run smoothly and continuously at their most efficient speed by connecting/disconnecting the motor and the load. Fast starts and stops, easy control interface, remote pushbutton operation and smooth acceleration and deceleration are outstanding user benefits.

### Reliable Performance

- High cycle rates
- Smooth soft starts
- Cushioned stops
- Accurate positioning
- Indexing
- Jogging
- Reversing
- Speed changing



# Packaged Performance Products

## Electromagnetic Clutches and Brakes

### Principle of Operation

A key feature of Warner Electric brakes and clutches is the method of actuation. Like an electromagnet, they have two basic parts. A magnetic field is generated as soon as the current flows through the magnet coil. This draws the armature into direct contact with the magnet. The strength of the magnetic field is directly proportional to the amount of current applied. Full range torque control from 0 to 100% is as simple as turning the knob on a light dimmer.

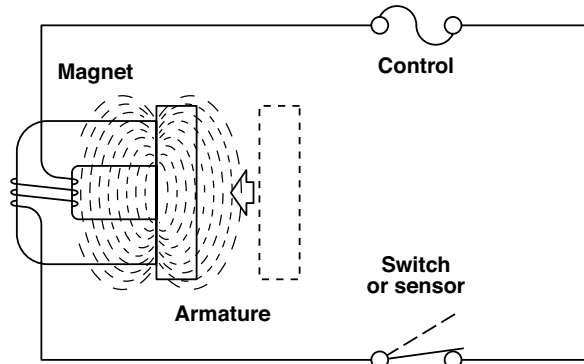

### Fast and Accurate

The benefits of electric actuation combined with the use of small, low inertia components is fast response, high cycle rates, and increased accuracy. While other devices are often sluggish and slow to respond, electric brakes and clutches respond instantly, resulting in higher productivity and better consistency.

### Easy to Select

Most of the time, all you need to know is motor horsepower and the speed at the brake or clutch location. Warner Electric takes care of the rest. The performance you require is built in, and with the broad range of products to choose from, you won't have to compromise with a clutch or brake that's a little too big or a little too small.

### Maintenance Free

Warner Electric brakes and clutches are clean and quiet. They require no maintenance. They never need lubrication, and they're completely self adjusting for wear. No complicated air system or messy hydraulics. Warner Electric brakes and clutches are outstandingly trouble free.

### Controllable

Electric brakes and clutches are incredibly easy to control. The shift from positive, instantaneous engagement to soft, cushioned starts and stops is as simple as turning a knob.



### Torque/Current Curve

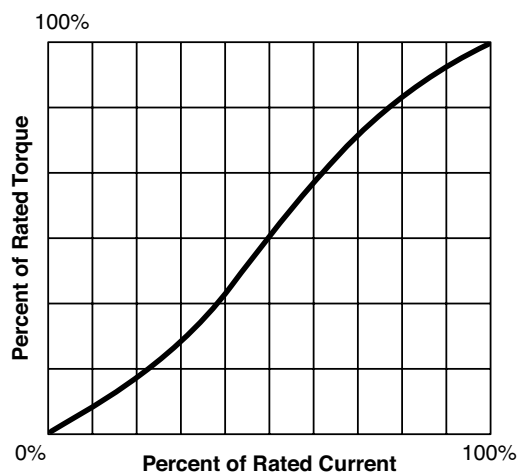

# Packaged Performance Products

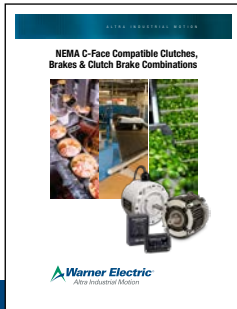

## NEMA C-face Clutches, Brakes and Clutch Brake Combinations P-8586-WE

### Electro Module

#### Individual Clutch and Brake Modules



#### EM Series

##### Modular Components that are Easily Combined

- ❑ 5 sizes
- ❑ 16 clutch and brake modules
- ❑ 16 to 95 lb. ft. torque range

Individual modules may be used in combination to form clutches, brakes or clutch/brake packages.

Electro Modules can be bolted directly to NEMA C-face motors or reducers, or base mounted for stand alone operation.

See P-8586-WE for Service Parts

### UniModule®

#### One Piece Preassembled Clutches and Clutch/Brakes



#### UM Series

##### C-face or Base Mounted Units

- ❑ 5 sizes
- ❑ 20 combinations
- ❑ 16 to 95 lb. ft. torque range

UniModule clutches and clutch/brake packages offer the ultimate in installation convenience.

Can be motor or reducer mounted, or used as a separate drive unit powered from a prime mover.

See P-8586-WE for Service Parts

#### UM Smooth-Start

##### Soft Engage Designs

- ❑ 5 sizes
- ❑ 10-57 lb.ft. torque range

Smooth-Start designs allow for a soft engage clutch and brake without sacrificing unit life.

#### UM-C Series

##### High Performance Version for High Cycle Rate Applications

- ❑ 3 sizes
- ❑ 6 combinations
- ❑ 16 to 95 lb. ft torque range

The UM-C units are UniModules with ceramic faced components, specifically designed for long life, high energy, and high cycle rate applications.

### Enclosed UniModule®

#### Preassembled Units Offer Clean, Quiet Operation



#### EUM Series

##### Totally Enclosed Clutch and Brake Packages

- ❑ 5 sizes
- ❑ 3 combinations
- ❑ 16 to 95 lb. ft. torque range

Totally enclosed, rugged enclosure keeps wear particles in and contaminants out. Finned for rapid heat dissipation and long life.

See P-8586-WE for Service Parts

#### EUM-W Series

##### Washdown Version

- ❑ 5 sizes
- ❑ 8 combinations
- ❑ 16 to 95 lb. ft. torque range

The washdown version of the EUM uses stainless steel shafting, USDA approved coating, corrosion resistant fasteners and special seals.

See P-8586-WE for Service Parts

# Packaged Performance Products



## Shaft Mounted Clutches & Brakes P-8587-WE

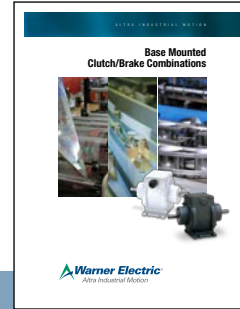

## Base Mounted Clutch/Brake Combinations P-8588-WE

### Electro Clutches Electro Brakes

#### Shaft Mounted Units



#### EC Series Clutches

##### Pre-Packaged Convenience

- ❑ 6 sizes
- ❑ 16 to 465 lb. ft. torque range

All the features of an electric clutch in a convenient, pre-packaged assembly. Mounts on any through shaft or extended motor shaft. Easy-to-assemble with standard sheaves, pulleys, gears and sprockets. Packaged design. No assembly required. Long life. No maintenance.

See P-8587-WE for Service Parts

#### EB Series Brakes

##### Torque Arm Mounting

- ❑ 6 sizes
- ❑ 16 to 465 lb. ft. torque range

Torque arm feature makes Electro Brakes easy to mount on any motor or through shaft. Packaged design. No assembly required. Long life. No maintenance.

See P-8587-WE for Service Parts

### Advanced Technology Clutches and Brakes

#### Extra Rugged Design



#### ATC Series Clutches ATB Series Brakes

##### Replaceable Friction Faces

- ❑ 3 sizes
- ❑ 25 to 115 lb. ft. torque range

Rugged, heavy duty units designed for extra long life and efficient operation. Cast components for durability. Finned armatures for high heat dissipation.

Friction faces are designed to allow for replacement without replacing valuable, non-wear components. Provides superior wear life with reduced engagement noise.

See P-8587-WE for Service Parts

#### SFP Series Clutches

- ❑ Pre-assembled SF – No assembly required
- ❑ Ball bearing mounted field and armature
- ❑ 70 inch pound and 270 inch pound sizes
- ❑ Bore sizes from 3/8" to 1/2" and 1/2" to 1"

SFP clutches provide the simplicity and cost efficiency of the Basic SF design, but with a ball bearing mounted armature hub.

### Electro Pack Clutch/Brakes

#### Foot Mounted Units

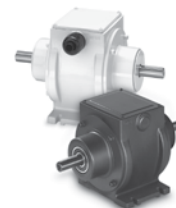

#### EP Series

##### Totally Enclosed Units

- ❑ 8 sizes
- ❑ 15 lb. to 1350 lb. ft. torque range

Electro Packs are rugged, pre-assembled clutch and brake combinations in enclosed, foot mounted housings.

See P-8588-WE for Service Parts

#### EP-C Series

##### High Performance Version

- ❑ 2 sizes
- ❑ 15 and 70 lb. in. torque

Ceramic faced wear components provide long life for high cycle rate use. Consistent torque and cycle repeatability with Smooth-Start/stop control.

#### EP-W Series

##### Washdown Design

- ❑ 2 sizes
- ❑ 70 and 270 lb. in. static torque ranges
- ❑ USDA approved coating
- ❑ Stainless steel shaft and hardware
- ❑ Available in 24 or 90 volt DC

# Packaged Performance Products

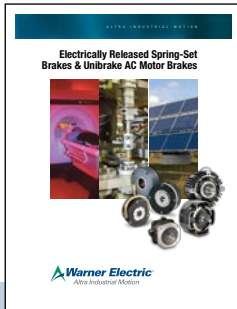

## Electrically Released Spring-Set Brakes & Unibrake AC Motor Brakes P-8589-WE

### Spring-Set Brakes

For Power-Off Static Holding and Emergency Stopping Applications

**WARNING** For general use in horizontal shaft applications only. For possible vertical applications, contact technical support.



#### ERS Series

Static Engaged

- 5 sizes
- 1.5 to 100 lb. ft. holding torque

Designed for static holding. ERS models feature multiple coil springs that force armature and friction faces together to generate braking torque when power is off. The Electromagnet counters the spring force to disengage the brake when power is applied.

Although this brake should be engaged only when the shaft is at rest, it can occasionally act as a dynamic braking device to stop a rotating load in an emergency situation.

#### Spring Set Brake Module

- 7 to 100 lb. ft. holding torque
- NEMA C-face version of the ERS Series



#### ERD Series

Dynamic Braking

- 8 sizes
- 4 to 221 lb. ft. holding torque

ERD units are electrically released, static and dynamic engaged, spring-set brakes for power-off load holding applications. These spring-set brakes automatically stop and hold a load in the event of a power failure or other emergency stop situations. Fully dynamic friction material allows for repeated braking cycles from full motor speed with no torque fade. An optional manual release allows the brake to be released by hand.

#### Unibrake Series AC Motor Brakes

- Spring Set/Solenoid Released
- Direct acting/manual release standard 3 families
- 3, 6, 10 and 15 lb. ft. capacity
- Steel or cast iron covers
- Rear mount or double C-face designs

### Permanent Magnet Brakes

For Power-Off Dynamic Stopping and Cycling Applications



#### FB Series

Shaft Mounted, Dynamic Braking

- 3 models
- 10.5 to 56 lb. ft. static torque

Permanent magnet brakes are designed to dynamically stop and hold a moving load and also for high cycle rate stopping. Electric power to the coil nullifies the attraction of the permanent magnet, releasing the brake.

FB models are pre-assembled and feature a torque arm for convenient shaft mounting.

See P-8590-WE for Service Parts.

#### ER Series

Flange Mounted, Dynamic Braking

- 5 models
- 10.5 to 400 lb. ft. static torque

The ER style brake offers a bulk head flange mounting system, the highest torque rating offered by Warner Electric in the power released series, high cycle rate capability, and excellent life. They require some assembly.

See P-8590-WE for Service Parts.

## Permanent Magnet Electrically Released Brakes P-8590-WE

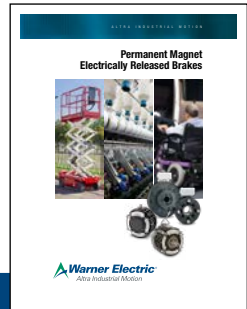

### Electro Module

#### C-face Brake Modules



#### EM-FBC Clutch/Brakes

##### Individual Module Components

- ❑ 3 sizes
- ❑ 10.5 to 56 lb. ft. torque range

Used in combination with an Electro Module motor or input clutch module for clutch/brake applications. Electrical power applied to the brake coil nullifies the permanent magnets' force and the brake releases. No springs to limit cycle rates.

#### EM-FBB

##### Brake Modules

- ❑ 5 sizes
- ❑ 10.5 to 56 lb. ft. torque range

Use for brake alone applications. Mounts between a C-face motor and reducer. Recommended for dynamic cycling operations only.

#### EM-MBFB

##### Motor Brakes

- ❑ 4 sizes
- ❑ 56C to 215C frame motors

Mounts to the back of a double shafted C-face motor. Never needs adjustment or lubrication.

### UniModule

#### C-face Brake Modules



#### UM-FBC Clutch/Brakes

##### One Piece Packages

- ❑ 4 sizes
- ❑ 7 combinations
- ❑ 10.5 to 56 lb. ft. static brake torque

UniModule pre-assembled clutch and electrically released brake packages are available in both C-face and base mounted versions.

Unique design employs powerful permanent magnets for maximum torque when power is removed from the brake coil. A small amount of electrical power applied to the brake coil nullifies the permanent magnets and the brake releases. No springs to limit cycle rates. Never any adjustment. No lubrication. These brakes are recommended for dynamic cycling operations only.

### Enclosed UniModule

#### C-face Brake Modules



#### EUM-FBB Brake Modules

##### Totally Enclosed

- ❑ 4 sizes
- ❑ 6 to 32 lb. ft. static torque

Totally enclosed UniModule electrically released brake packages keep contaminants out and wear particles in for clean, quiet operation. Assembly, alignment, and preburnishing have been done at the factory. Use for brake alone applications, mountings between a motor and a gear reducer. Select the torque required for the application. Higher torque brakes stop loads faster. Lower torque models provide softer stopping to prevent boxes on conveyors from tipping or skidding.

#### EUM-MBFB

##### Motor Brakes

- ❑ 4 sizes
- ❑ 56C to 215C frame motors

UniModule motor brakes are used for dynamic stopping and holding of loads when power is removed from the motor. Typical applications include conveyors, process equipment, and lifting devices. Mounts to a double shafted C-face motor.





## Electro Modules UniModules Enclosed UniModules

# A

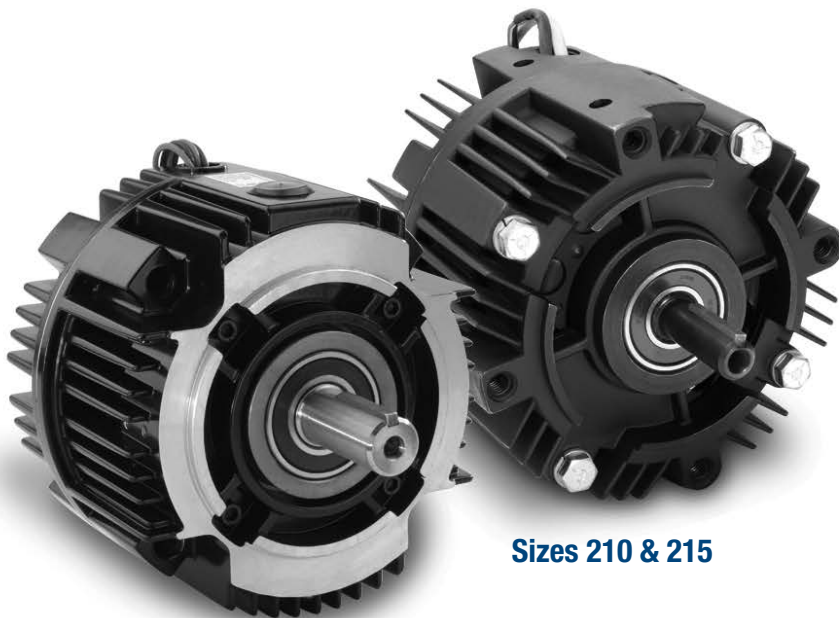

Sizes 210 & 215

Sizes 50, 100 & 180

- **Modular Design Flexibility**
- **Outstanding Controllability**
- **Accurate, Consistent Performance**
- **Bidirectional**