

# KD4 Single Flex KD41 & KD41T Floating Shaft Disc Couplings

Installation and  
Alignment Instructions  
FORM 23-001  
OCTOBER, 2000  
**KOP-FLEX®**

Emerson Power Transmission

KOP-FLEX, INC., P.O. BOX 1696, BALTIMORE MARYLAND 21203, 410-768-2000

KOP-FLEX CANADA, LTD., 19 METEOR DRIVE, REXDALE, ONTARIO, CANADA M9W-1A3, 416-675-7144

## ▲WARNING

Failure to observe safety precautions could cause personal injury or equipment damage.

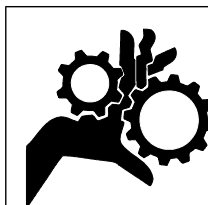

## ▲WARNING

Do not operate without guards. Turn off power to install or service.

## ▲WARNING

Because of the possible danger to person(s) or property from accidents which may result from the improper use or unapproved modification of the product, this product must be installed, maintained, and operated in accordance with the procedures, standards and engineering information specified in the product brochures and illustrations. To assure safe operation, this product should be inspected in accordance with the instructions described in this form. Proper guards and other suitable safety devices or procedures as may be desirable, or as may be specified in safety codes, should be installed by the user. Guards and other safety equipment are not provided, nor are they the responsibility of Emerson Power Transmission.

### 1.0 General Instructions

Prior to installation, inspect the coupling for any signs of damage during shipment. Check that all parts are on hand and are as ordered.

## ▲WARNING

ONLY BOLTS AND NUTS SUPPLIED BY KOP-FLEX ARE TO BE USED.

Components should be cradled or supported during handling to avoid damage and should be wrapped for protection. Flanges should be kept free of nicks and burrs.

Read all of the installation instructions and review the procedure before the actual coupling installation.

### 2.0 Installation of Coupling Hubs - Keyed Mounting

- 2.1 Check the hub bore and shaft for nicks and burrs, dress if necessary. Make sure that the bore and shaft are clean.
- 2.2 For tapered bores, check the fit of the bore to the shaft.
- 2.3 Keys must be precisely fitted to the keyways in the shaft and hub. Each key should have a tight fit on the sides with a slight clearance on top. To maintain dynamic balance, the keys should fill the keyways exactly and not be too short or too long.
- 2.4 Clean the hub bore and shaft. For straight bores, proceed to step 2.6. For tapered bores, mount the hub hand-tight on the shaft and lightly rap it with a soft mallet to establish the initial line-to-line fit. This is the START position. With a depth gauge, measure the amount the hub over hangs the shaft end and record this value. See Figure 1.

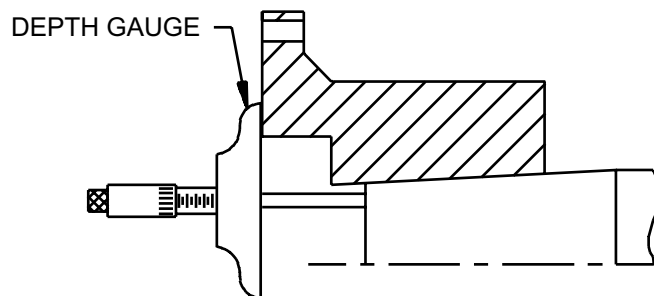

Figure 1. Measuring Hub Overhang

- 2.5 Tapered Bores Only: A recommended method to measure the hub advance is to install a split collar on the shaft, away from the hub by the amount of the specified advance. Use feeler gauges for accurate spacing. See Figure 2. The amount of hub advance is dependent upon the desired interference and taper angle as specified by the machine manufacturer or as given on the coupling drawing. See Figure 3.

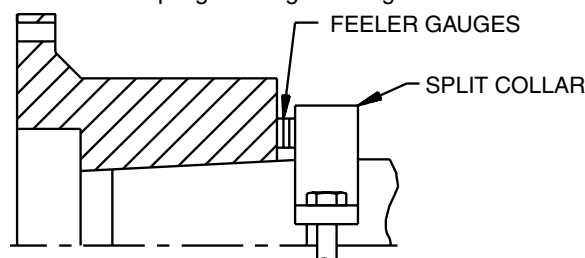

Figure 2. Using Split Collar to Set Advance

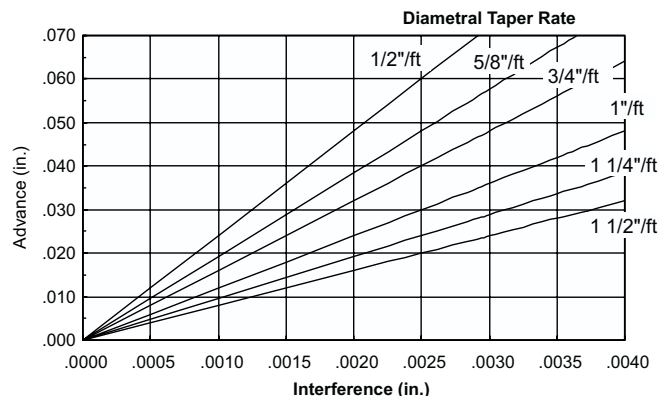

Figure 3. Hub Advance vs. Interference Chart

## ▲WARNING

Disconnect all power while adjusting units

- 2.6 Heat the hub to expand the bore; DO NOT allow the hub temperature to exceed 600°F (300°C). DO NOT apply an open flame to any part of the coupling, an oven is recommended.

**▲WARNING**

**To avoid the risk of explosion, fire, or damage to the coupling and equipment, and/or injury to personnel, do not use an open flame or oil bath to expand the hub. If heat is used at any time for installation, DO NOT allow the hub temperature to exceed 600°F (300°C).**

- 2.7 Place the hub in the proper position on the shaft. Hold the hub in place as it cools. For tapered bores, verify the hub advance (see Figures 1 and 2) and install the shaft retaining nut. Remove the split collar from the shaft.

**3.0 Alignment - KD4 Only**

- 3.1 KD4 couplings are single flex couplings, consisting of a single disc pack connecting (2) hubs and are designed to accommodate only angular misalignment. They are typically mounted on either end of a floating shaft to make a KD41 coupling.
- 3.2 The maximum recommended operating misalignment is:

0.10 degrees per disc pack  
(0.0035 in/in TIR parallel offset)

Note: Exact values and procedures for aligning equipment are normally specified by the equipment manufacturers.

**4.0 Alignment - KD41 and KD41T**

Note: Exact values and procedures for aligning equipment are normally specified by the equipment manufacturers.

The amounts given below represent values that would provide excellent coupling performance in operation.

Good initial alignment to the minimum possible values will promote optimum machinery performance and eliminate potential operating problems. After securely tightening the foundation bolts, the hub separation and alignment should be rechecked and adjusted if necessary.

The coupling alignment should be checked periodically. Even when a coupling is well aligned at installation, subsequent settling of foundations, shifting of equipment, etc., may cause the alignment to deteriorate.

**Offset and Angular Misalignment**

- 4.1 Reverse dial indication or optical methods of alignment (such as laser) are recommended. A cold alignment and a hot check (with corrections if necessary) are required. The hub flange OD can be used to mount the alignment equipment. The hub flange OD is machined to be concentric to the coupling bore and can be used as the reference diameter.
- 4.2 The maximum recommended operating misalignment is:

0.10 degrees per disc pack  
(0.0035 in/in TIR parallel offset)

**Important:** Total misalignment is the combination of equipment parallel offset and angular misalignment.

Note that improving the alignment below these values will promote optimum machinery performance.

**▲WARNING**

**Disconnect all power while adjusting units**

**Axial Misalignment**

- 4.3 Measure the length of the center section and the thicknesses of the two disc packs. See Figure 4. Measure the separation between the hub flanges and adjust the equipment until the axial hub separation equals the sum of the disc pack thicknesses and center section length. Hub separation =  $L + P1 + P2$ .

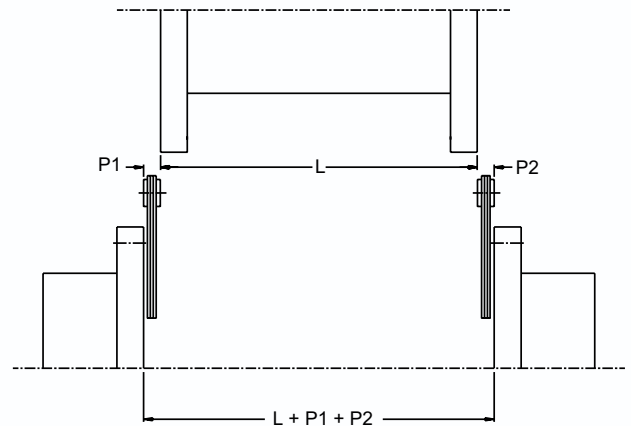

Figure 4. Axial Misalignment Measurements

Note: Certain equipment may have changes in shaft separation during operation due to: thermal growth, thrust loading, etc. This should be accounted for at installation by increasing or decreasing the hub separation to accept this movement during operation.

- 4.4 Disc pack thickness, P1 and P2, is the total thickness over the disc pack washers.

**5.0 Disc Pack Assembly**

- 5.1 Place the center section in position between the hub flanges. Place the disc packs between the flanges on both ends of the coupling.
- 5.2 Insert the disc pack bolt into the reamed hole of the hub and through the disc pack bushing. See Figure 5. The flat of the bolt head will act as a bolt lock with the hub body. Make sure the center section is properly indexed for the large clearance holes to receive the bolt ends. Tap the bolts lightly for full engagement until the heads rest on the hub flange surface. Repeat for the other bolts.

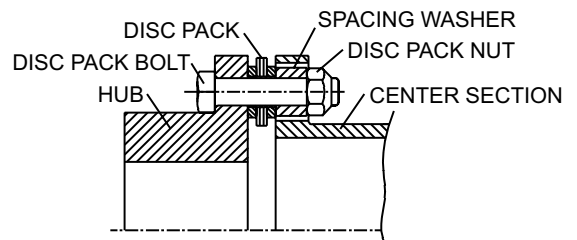

Figure 5. Bolt Disc Pack to Hub

- 5.3 Place the spacing washer and the disc pack nuts on the bolts. Tighten all nuts evenly and in an alternating fashion to the torque specified in Table 1.

- 5.4 Place a spacing washer over a disc pack bolt. Insert the bolt through the large hub clearance hole and the disc pack bushing. See Figure 6. Tap the bolts lightly for full engagement. Repeat for the other bolts.

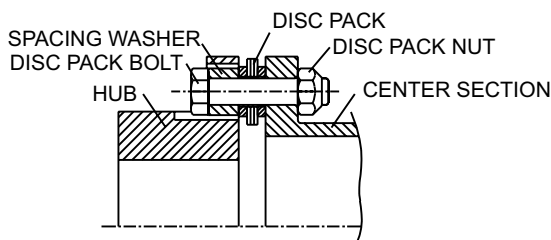

Figure 6. Bolt Disc Pack to Center Section

- 5.5 Place the disc pack nuts on the bolts. Tighten all nuts evenly and in an alternating fashion to the torque specified in Table 1.

Coupling Size	Nut Size	Tightening Torque (as supplied)		Tightening Torque (lubed)*	
		ft-lb	Nm	ft-lb	Nm
103	5/16-18	10	14	7	9
153	7/16-20	27	37	20	27
204	1/2-20	55	75	45	61
254	1/2-20	55	75	45	61
304	5/8-18	115	156	90	122
354	3/4-16	175	237	140	190
404	7/8-14	280	380	220	298
454	7/8-14	280	380	220	298
504	1-12	420	570	330	447
554	1 1/8-12	730	990	580	786
604	1 1/4-12	1020	1380	810	1100
705	1 1/2-12	1800	2440	1440	1950
805	1 3/4-12	2300	3120	1840	2500
905	1 3/4-12	2300	3120	1840	2500

\*Light Machine Oil

Table 1. Disc Pack Nut Tightening Torques

## 6.0 Removal

- 6.1 Remove the disc pack bolts, nuts and spacing washers. Be sure to support the center section. Remove the center section and disc packs.
- 6.2 **KEYED HUBS** - Install a puller on the hub using the tapped holes provided in the hub face. Pull the hub off the shaft.

## 7.0 Dynamic Balance

Balanced parts will be marked with the letter "B." The standard procedure is to component balance the hubs and center section. A standard balanced coupling will not have match marks. If a coupling is supplied with match marks, it has been specially balanced; the coupling must be assembled with the match marks in line.

## 8.0 Finish Boring and Keyways

Coupling hubs are often furnished with a "rough stock bore." This rough bore is not necessarily concentric to other hub diameters. To prepare for boring, set-up and indicate the hub as shown in Figure 7.

## 9.0 Bore Sizing and Recommended Fit

The finish bore size should be based on the actual measured shaft dimension, regardless of whether straight or taper shaft. For keyed shafts, a light interference fit based on a nominal interference rate of 0.0005 inch per inch of shaft diameter is suggested, or refer to published AGMA standards. **Do not** exceed an interference fit of 0.001 inch/inch of shaft diameter. If other than a light interference fit is desired, consult the published AGMA boring and keyway standards.

## Recommended Set-Up Method for Boring

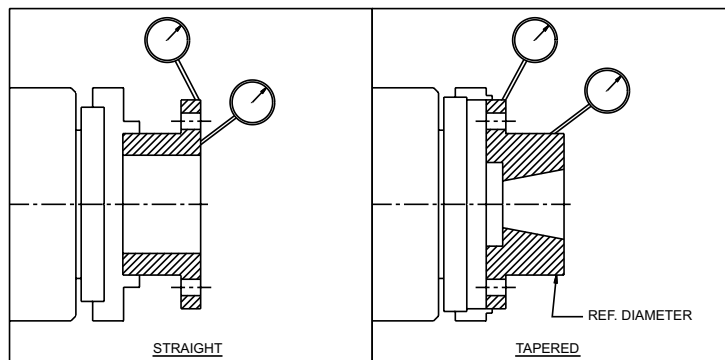

Figure 7.

Figure 8.

For **Straight Bores**, the rigid hub diameter should be chucked in the boring lathe and dial indicated as shown of Figure 7.

For **Taper Bores**, chuck and indicate as shown on Figure 7. Machine the counterbore and **SKIM A REFERENCE DIAMETER** on the hub body. Then chuck the hub as shown on Figure 8, and indicate using the reference diameter before final boring. Run-outs should be as near zero as possible. It is essential that the finished bore be concentric with the two indicating surfaces.

## 10.0 Keyways

Keyways should be cut to give a tight fit on the sides and slight clearance over the key. Keyways should not have sharp corners. Refer to published AGMA standards for specific dimensioning of coupling bores and keyways.

## 11.0 General Recommendations

- 11.1 KOP-FLEX KD41 and KD41T disc couplings are designed to operate for extended periods without the need for lubrication or maintenance. Visual inspection of the disc packs is sufficient to assess the operational condition of the coupling.
- 11.2 All machinery should be monitored to detect unusual or changing vibration levels. The KOP-FLEX KD41 and KD41T coupling, under normal operation conditions, has no wearing parts and will retain its original balance quality. Any change in vibration levels should be investigated and re-medial action should be taken immediately.

**▲WARNING** Disconnect all power while adjusting units

**5 YEAR WARRANTY REGISTRATION CARD**

Name (Last, First) \_\_\_\_\_  
Title: \_\_\_\_\_  
Company Name: \_\_\_\_\_  
Location: \_\_\_\_\_  
Phone: \_\_\_\_\_

**APPLICATION DATA**

Coupling Type: \_\_\_\_\_  
HP: \_\_\_\_\_  
RPM: \_\_\_\_\_  
Application: \_\_\_\_\_  
Shaft Size(s):    Driving: \_\_\_\_\_      Driven: \_\_\_\_\_  
Distance Between Shaft Ends \_\_\_\_\_  
Plant Identification    Pump # \_\_\_\_\_      Motor # \_\_\_\_\_

Send Warranty Card To:                                  Attention Marketing Department  
                                 Kop-Flex, Inc.  
                                 Mail to: P. O. Box 1696                                  or Fax to: 410-787-8424  
                                 Baltimore, MD 21203-1696



**Important Safety Instructions**  
**Before start-up** . . . for reasons of safety and to extend shaft coupling life, follow these requirements.

- 1. Coupling guards protect personnel. **ALL COUPLINGS MUST BE COVERED WITH A GUARD AS PER OSHA REQUIREMENTS.**
- 2. Recheck alignment after all foundation bolts and mechanical connections are tightened.
- 3. Make sure all fasteners are properly installed and tightened.
- 4. Take the time to double check your work.
- 5. Only authorized KOP-FLEX replacement parts are to be used.
- 6. Call KOP-FLEX for any clarification or questions.

