

H-MOSS® Controls Adaptive Dual Technology Wall Switches

HUBBELL



Features

- Dual technology sensing combines the individual advantages of passive infrared and ultrasonic detection
- No neutral required
- Built in photocell with manual super saver mode for daylight harvesting
- Impact resistant hard lens is standard and color matched to the switch

Ordering Information

Description	Device Color	UPC Number	Catalog Number
Dual (ultrasonic and passive infrared), 2 button for manual/auto control	Black	783585413174	AD2000BK2

Listings

cULus Listed
Meets ASHRAE 90.1
CEC Title 24 Certified

Specifications

Housing	High impact plastic (UL-94-5V)
Mounting Strap	Plated steel
Lens	Dual element pyrometer and 12 element cylindrical hard lens
Sensing Indicator	Passive Infrared, Red LED. Ultrasonic, Green LED.

Performance

Electrical	
Load Capacity	Incandescent - 0 to 800 watts, 120V AC Ballast - 0 to 1000 watts, 277V AC Ballast 0 to 1800 watts
Power Supply	120/277V AC, 50/60Hz
Mechanical	
Wire Leads	#18 AWG stranded wire, 6" long with ½" stripped ends
Environmental	
Operating Temperature	32°F to 104°F (0°C to 40°C); 0% to 95% non-condensing relative humidity
Controls	
Ambient Light	Adjustable ambient light override, 10 to 500 foot candles
Front Press Switch	Auto/Manual "ON" operating mode
Sensitivity	Adaptive 0% to 100%
Time Delay	Digital, adaptive 4 to 30 minutes
Coverage Pattern	
Area	1000 square foot. Area of coverage based on passive infrared technology minor motion pattern. See illustration.
Mounting Height	42 to 54 inches above floor

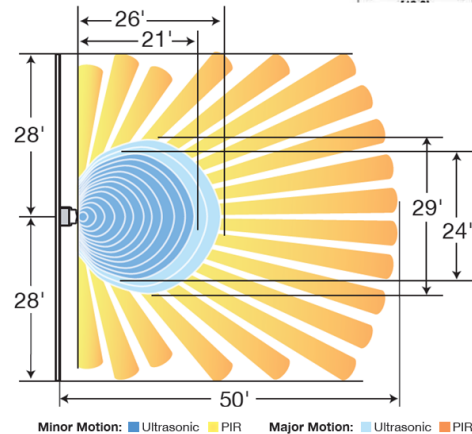
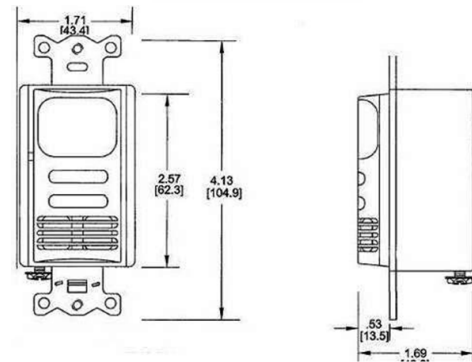

Complementary Products

Wallplate NP26BK, SS26

Online Resources

Customer Use Drawing
eCatalog
Installation Instructions

Dimensions in Inches (mm)

Hubbell Wiring Device-Kellems • Hubbell Incorporated (Delaware) • 40 Waterview Drive • Shelton, CT 06484

Phone (800) 288-6000 • Fax (800) 255-1031 • Specifications subject to change without notice.

