

MAGNA1

Installation and operating instructions



Original installation and operating instructions.

CONTENTS

	Page
1. Limited warranty	2
2. Symbols used in this document	3
3. General information	3
3.1 Applications	3
3.2 Pumped liquids	3
3.3 Operating conditions	4
3.4 Frost protection	4
3.5 Insulating shells	4
3.6 Non-return valve	4
3.7 Wiring diagram	5
3.8 Nameplate	6
3.9 Tools	6
4. Mechanical installation	7
4.1 Lifting the pump	7
4.2 Installing the pump	7
4.3 Positioning	7
4.4 Control box positions	8
4.5 Changing the control box position	9
5. Electrical installation	10
5.1 Supply voltage	10
5.2 Connection to the power supply	11
6. First start-up	13
7. Settings	14
8. Control panel	14
8.1 Elements on the control panel	14
8.2 Grundfos Eye	14
8.3 Light fields indicating the pump setting	14
9. Overview of settings	15
10. Pump setting	16
11. Selection of control mode	17
12. Fault finding	18
12.1 Grundfos Eye operating status	18
12.2 Resetting of fault indications	18
13. Technical data	19
14. Disposal	19

1. Limited warranty

Products manufactured by GRUNDFOS PUMPS CORPORATION (Grundfos) are warranted to the original user only to be free of defects in material and workmanship for a period of 24 months from date of installation, but not more than 30 months from date of manufacture. Grundfos' liability under this warranty shall be limited to repairing or replacing at Grundfos' option, without charge, F.O.B. Grundfos' factory or authorized service station, any product of Grundfos' manufacture. Grundfos will not be liable for any costs of removal, installation, transportation, or any other charges which may arise in connection with a warranty claim. Products which are sold but not manufactured by Grundfos are subject to the warranty provided by the manufacturer of said products and not by Grundfos' warranty. Grundfos will not be liable for damage or wear to products caused by abnormal operating conditions, accident, abuse, misuse, unauthorized alteration or repair, or if the product was not installed in accordance with Grundfos' printed installation and operating instructions.

To obtain service under this warranty, the defective product must be returned to the distributor or dealer of Grundfos' products from which it was purchased together with proof of purchase and installation date, failure date, and supporting installation data. Unless otherwise provided, the distributor or dealer will contact Grundfos or an authorized service station for instructions. Any defective product to be returned to Grundfos or a service station must be sent freight prepaid; documentation supporting the warranty claim and/or a Return Material Authorization must be included if so instructed.

GRUNDFOS WILL NOT BE LIABLE FOR ANY INCIDENTAL OR CONSEQUENTIAL DAMAGES, LOSSES, OR EXPENSES ARISING FROM INSTALLATION, USE, OR ANY OTHER CAUSES. THERE ARE NO EXPRESS OR IMPLIED WARRANTIES, INCLUDING MERCHANTABILITY OR FITNESS FOR A PARTICULAR PURPOSE, WHICH EXTEND BEYOND THOSE WARRANTIES DESCRIBED OR REFERRED TO ABOVE.

Some jurisdictions do not allow the exclusion or limitation of incidental or consequential damages and some jurisdictions do not allow limit actions on how long implied warranties may last. Therefore, the above limitations or exclusions may not apply to you. This warranty gives you specific legal rights and you may also have other rights which vary from jurisdiction to jurisdiction.

**Warning**

Prior to installation, read these installation and operating instructions. Installation and operation must comply with local regulations and accepted codes of good practice.

**Warning**

The use of this product requires experience with and knowledge of the product.

Persons with reduced physical, sensory or mental capabilities must not use this product, unless they are under supervision or have been instructed in the use of the product by a person responsible for their safety.

Children must not use or play with this product.

2. Symbols used in this document



Warning

If these safety instructions are not observed, it may result in personal injury.



Warning

If these instructions are not observed, it may lead to electric shock with consequent risk of serious personal injury or death.



Warning

The surface of the product may be so hot that it may cause burns or personal injury.



Warning

Risk of dropping objects which may cause personal injury.



Warning

Escaping vapor involves the risk of personal injury.

Caution

If these safety instructions are not observed, it may result in malfunction or damage to the equipment.

Note

Notes or instructions that make the job easier and ensure safe operation.

3. General information



The Grundfos MAGNA1 is a complete range of circulator pumps with integrated controller enabling adjustment of pump performance to the actual system requirements. In many systems, this will reduce the power consumption considerably, reduce noise from thermostatic radiator valves and similar fittings and improve the control of the system.

The desired head can be set on the pump control panel.

3.1 Applications

The Grundfos MAGNA1 is designed for circulating liquids in the following systems:

- heating systems
- air-conditioning and cooling systems.

The pump can also be used in the following systems:

- ground source heat pump systems
- solar-heating systems.

3.2 Pumped liquids

The pump is suitable for thin, clean, non-aggressive and non-explosive liquids, not containing solid particles or fibers that may attack the pump mechanically or chemically.

In heating systems, the water should meet the requirements of accepted standards on water quality in heating systems.

3.2.1 Glycol

The pump can be used for pumping water/glycol mixtures up to 50 %.

Example of a water/ethylene glycol mixture:

Maximum viscosity: 50 cSt ~ 50 % water / 50 % ethylene glycol mixture at +14 °F (-10 °C).

The pump has a power-limiting function that protects against overload.

The pumping of glycol mixtures will affect the max. curve and reduce the performance, depending on the water/ethylene glycol mixture and the liquid temperature.

To prevent the ethylene glycol mixture from degrading, avoid temperatures exceeding the rated liquid temperature and minimize the operating time at high temperatures.

It is important to clean and flush the system before the ethylene glycol mixture is added.

To prevent corrosion or lime precipitation, check and maintain the ethylene glycol mixture regularly. If further dilution of the supplied ethylene glycol is required, follow the glycol supplier's instructions.

Note

Additives with a density and/or kinematic viscosity higher than those that of water will reduce the hydraulic performance.



Warning

Do not use the pump for flammable liquids, such as diesel oil and gasoline.



Warning

Do not use the pump for aggressive liquids, such as acids and seawater.

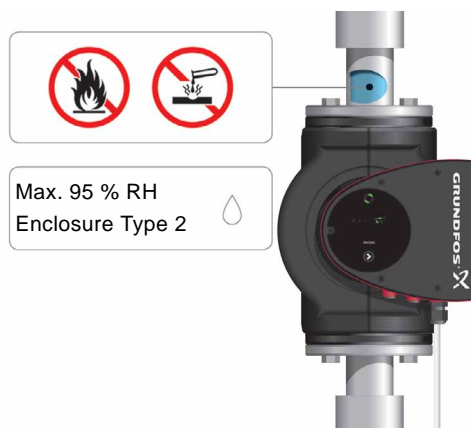

Fig. 1 Pumped liquids (flanged version)

TM05 6385 4612

3.3 Operating conditions

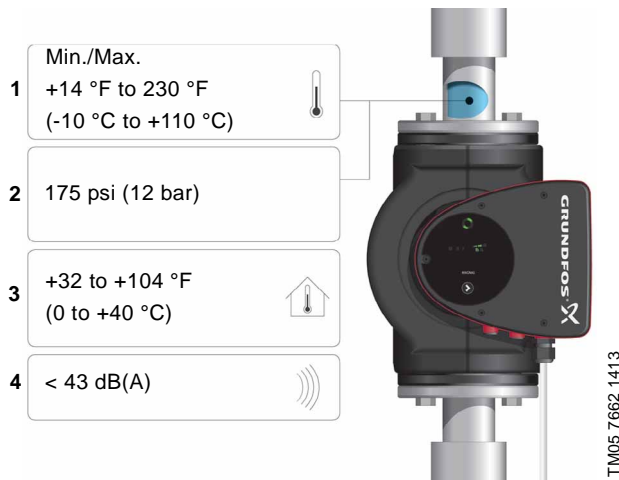

Fig. 2 Operating conditions

3.3.1 Liquid temperature

See fig. 2, pos. 1.

Continuously: +14 to +230 °F (-10 to +110 °C).

3.3.2 System pressure

See fig. 2, pos. 2.

The maximum permissible system pressure is stated on the pump nameplate. See fig. 7.

3.3.3 Ambient temperature

See fig. 2, pos. 3.

+32 to +104 °F (0 to +40 °C).

The control box is air-cooled. Therefore, it is important that the maximum permissible ambient temperature is not exceeded during operation.

During transport: -40 to + 158 °F (-40 to +70 °C).

3.3.4 Sound pressure level

See fig. 2, pos. 4.

The sound pressure level of the pump is lower than 43 dB(A).

3.3.5 Approvals

- Conforms to ANSI/UL Standard 778.
- Certified to CAN/CSA Standard C22.2 No. 108.
- The protective earth (ground) symbol \oplus identifies any terminal which is intended for connection to an external conductor for protection against electric shock in case of a fault, or the terminal of a protective earth (ground) electrode.

3.4 Frost protection

Caution

If the pump is not used during periods of frost, necessary steps must be taken to prevent frost bursts.

Note

Additives with a density and/or kinematic viscosity higher than those/that of water will reduce the hydraulic performance.

3.5 Insulating shells

Insulating shells are available for single-head pumps only.

Note

Limit the heat loss from the pump housing and pipework.

The heat loss from the pump and pipework can be reduced by insulating the pump housing and the pipework. See fig. 3.

- Insulating shells for pumps in heating systems are supplied with the pump.
- For pumps in air-conditioning and cooling systems (down to 14 °F (-10 °C)) it is required to apply a silicon sealant to the internal contours of the shell in order to eliminate any air gaps and prevent condensation between the insulation shell and pump housing. Alternatively, the pump can also be insulated manually in accordance with standard insulating requirements for heating and cooling systems.

The fitting of insulation shells will increase the pump dimensions.

Note

Pumps are factory-fitted with insulating shells. Remove the insulating shells before installing the pump.



Fig. 3 Fitting insulating shells to the pump

3.6 Non-return valve

If a non-return valve is fitted in the pipe system (fig. 4), it must be ensured that the set minimum discharge pressure of the pump is always higher than the closing pressure of the valve. This is especially important in proportional-pressure control mode (reduced head at low flow).

The closing pressure of a single non-return valve is accounted for in the pump settings as the minimum head delivered is 5 ft (1.5 m).

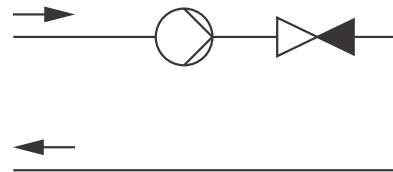
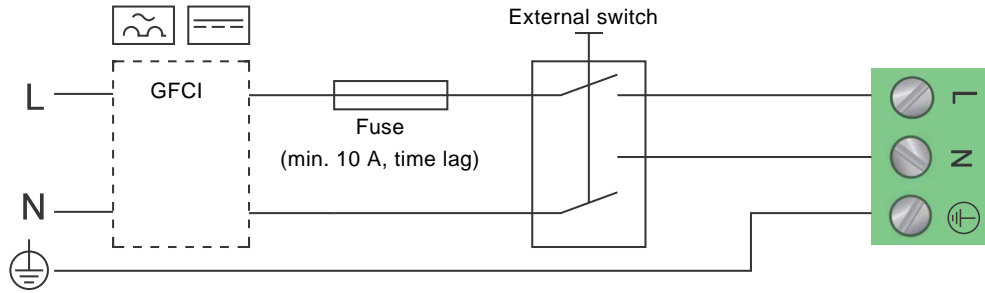

Fig. 4 Non-return valve

3.7 Wiring diagram

Caution All cables must be connected in accordance with local regulations.

3.7.1 For models 32-XX



TM06 1256 2214

Fig. 5 Example of terminal connection, 1 x 230 V ± 10 %, 50/60 Hz

3.7.2 For models 40-XX, 50-XX, 65-XX, 80-XX, 100-XX

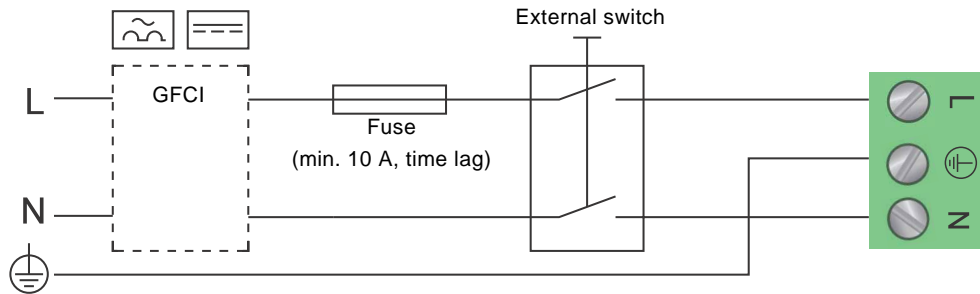

TM03 2397 0312

Fig. 6 Example of terminal connection, 1 x 230 V ± 10 %, 50/60 Hz, PE

3.8 Nameplate

The pump nameplate provides the following information:

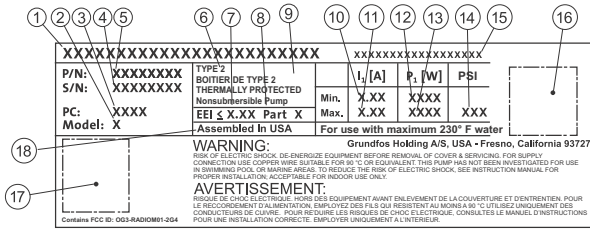

Fig. 7 Example of nameplate

Pos.	Description
1	Product name
2	Model
3	Production code (year and week)
4	Serial number
5	Product number
6	Enclosure type
7	Energy Efficiency Index (EEI)
8	Part (according to EEI)
9	TF-class
10	Minimum current [A]
11	Maximum current [A]
12	Minimum power [W]
13	Maximum power [W]
14	Maximum pressure
15	Voltage [V] and frequency [Hz]
16	QR (Quick Response) code
17	Approvals (nameplate)
18	Assembled in USA

TM05 6381 1713

3.9 Tools

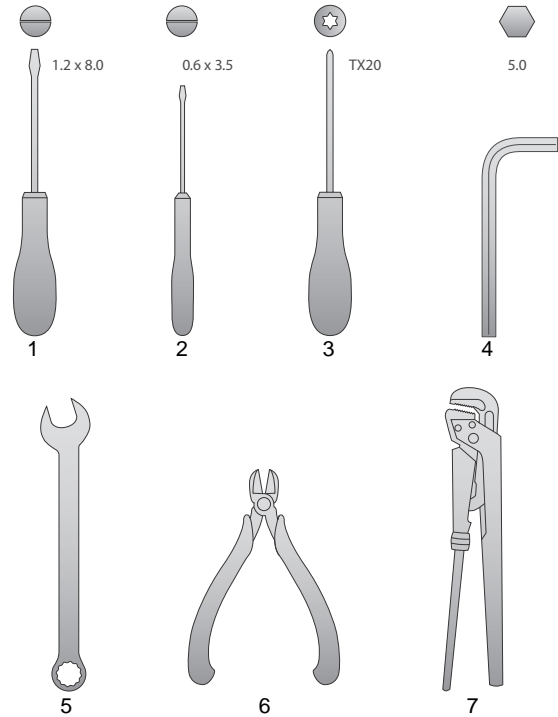

Fig. 8 Recommended tools

Pos.	Tool	Size
1	Screwdriver, straight slot	1.2 x 8.0 mm
2	Screwdriver, straight slot	0.6 x 3.5 mm
3	Screwdriver, torx bit	TX20
4	Hexagon key	5.0 mm
5	Open-end wrench	Depending on size
6	Wire cutter	
7	Pipe wrench	

TM05 6472 4712

4. Mechanical installation



4.1 Lifting the pump



Warning
Observe local regulations setting limits for manual lifting or handling.

Always lift directly on the pump head or the cooling fins when handling the pump.

For large pumps, it may be necessary to use lifting equipment.

4.2 Installing the pump

The MAGNA1 is designed for indoor installation.

The pump may be suspended direct in the pipes, provided that the pipework can support the pump.

To ensure adequate cooling of motor and electronics, observe the following requirements:

- Position the pump in such a way that sufficient cooling is ensured.
- The ambient temperature must not exceed +104 °F (+40 °C).

Step	Action	Illustration
1	Arrows on the pump housing indicate the liquid flow direction through the pump. The liquid flow direction can be horizontal or vertical, depending on the control box position.	
2	Mount the pump with gaskets in the pipework.	
3	Flanged version: Fit bolts and nuts. Use the right size of bolts according to system pressure.	

4.3 Positioning

Always install the pump with horizontal motor shaft.

- Pump installed correctly in a vertical pipe. See fig. 9, pos. A.
- Pump installed correctly in a horizontal pipe. See fig. 9, pos. B.
- Do not install the pump with vertical motor shaft. See fig. 9, pos. C and D.

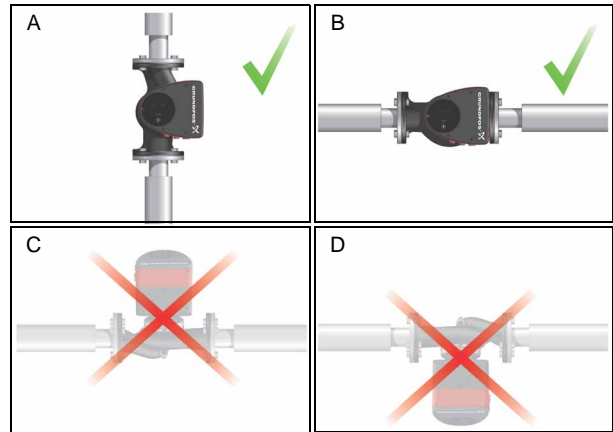

Fig. 9 Pump installed with horizontal motor shaft

TM05 5513 3812

TM05 5513 3812

TM05 5515 3812

TM05 5516 3816

4.4 Control box positions

To ensure adequate cooling, the control box must be in horizontal position with the Grundfos logo in vertical position. See fig. 10.

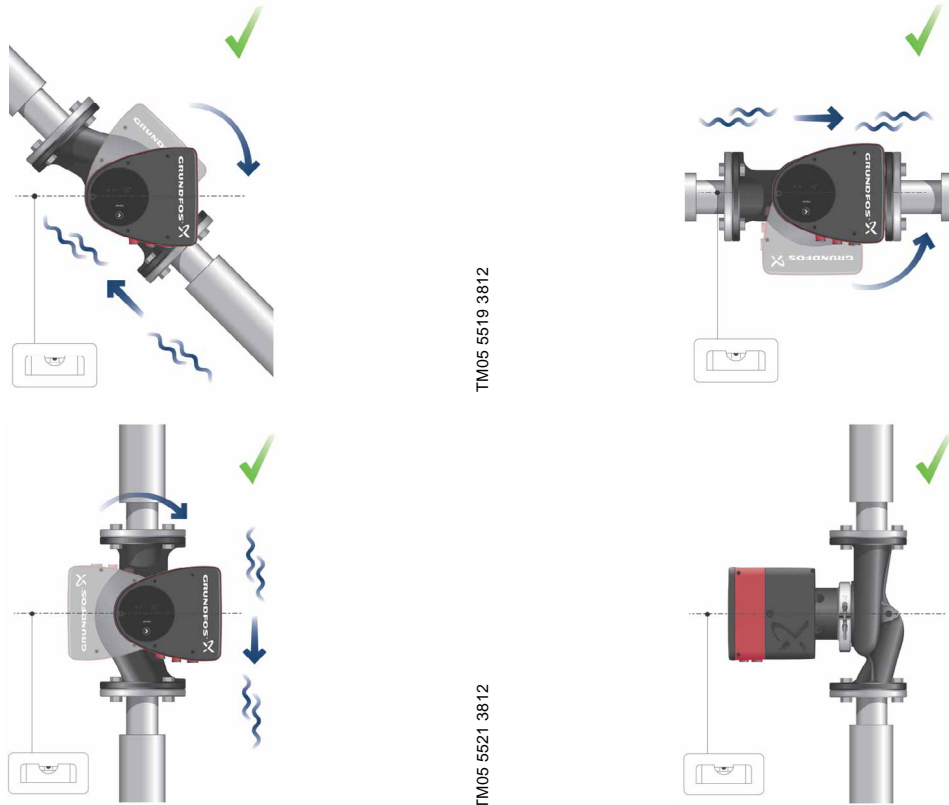

TM05 5519 3812

TM05 5521 3812

TM05 5520 3812

TM05 5522 3812

Fig. 10 Pump with control box in horizontal position

If the pump head is removed before the pump is installed in the pipework, pay special attention when fitting the pump head to the pump housing:

1. Gently lower the pump head with rotor shaft and impeller into the pump housing.
2. Make sure that the contact face of the pump housing and that of the pump head are in contact before the clamp is tightened. See fig. 11.

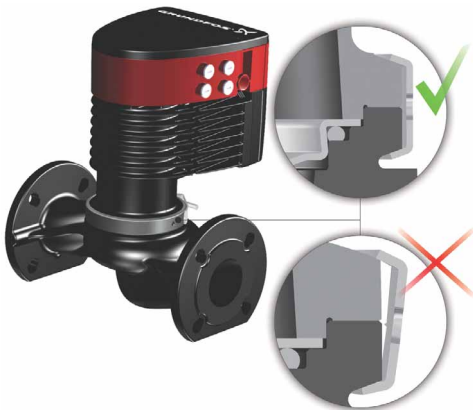

TM05 5837 4112

Fig. 11 Fitting the pump head to the pump housing

4.5 Changing the control box position



Warning
The warning symbol on the clamp holding the pump head and pump housing together indicates that there is a risk of personal injury. See specific warnings below.



Warning
When loosening the clamp, do not drop the pump head.



Warning
Risk of escaping vapor.

Step	Action	Illustration
1	Loosen the screw in the clamp holding the pump head and pump housing together. Warning: If the screw is loosened too much, the pump head will be completely disconnected from the pump housing.	TM05 2867 0612
2	Carefully rotate the pump head to the desired position. If the pump head is stuck, loosen it with a light blow of a rubber mallet.	TM05 5526 3812
3	Place the control box in horizontal position so that the Grundfos logo is in vertical position. The motor shaft must be horizontal.	TM05 5527 3812
4	Due to the drain hole in the stator housing, position the gap of the clamp as shown in step 4a, 4b, 4c, or 4d.	TM05 2870 0612
4a	Flanged single-head pump. Position the clamp so that the gap points towards the arrow. It can be in position 3 or 9 o'clock.	TM05 2918 0612 - TM05 2871 0612

Step	Action	Illustration
4b	Flanged single-head pump. Note: The gap of the clamp can also be in position 6 o'clock for the following pump sizes: • MAGNA1 65-XX • MAGNA1 80-XX • MAGNA1 100-XX.	TM05 2899 1912
4c	Twin-head pump. Position the clamps so that the gaps point towards the arrows. They can be in position 3 or 9 o'clock.	TM05 2917 0612 - TM05 2873 0612
4d	Threaded single-head pump. The gap of the clamp can be in position 3, 6, 9 or 12 o'clock.	TM05 5528 3812
5	Fit and tighten the screw holding the clamp to: 6 ± 0.7 ft-lbs (8 ± 1 Nm). Note: Do not retighten the screw if condensed water is dripping from the clamp.	TM05 2872 0612
6	Fit the insulating shells. Note: For air conditioning and cooling systems, a silicone sealant must be applied inside the insulation shell to eliminate all air gaps and prevent condensation between the pump housing and insulation shell. Alternatively, the pump may be insulated manually in accordance with standard insulation practices for cooling applications.	TM05 5529 3812

Caution If insulating the pump manually, do not insulate the control box or cover the control panel.



Fig. 12 Insulation of pump housing and pipework

TM05 5549 3812

5. Electrical installation



Carry out the electrical connection and protection according to local regulations.

Check that the supply voltage and frequency correspond to the values stated on the nameplate.



Warning

Switch off the power supply before making connections.



Warning

Never make any connections in the pump control box unless the power supply has been switched off for at least 5 minutes.

Warning

The pump must be connected to an external mains switch with a contact separation of at least 1/8 inch (3 mm) in each pole.

The ground terminal of the pump must be earth ground.



Grounding or neutralization can be used for protection against indirect contact.

If the pump is connected to an electric installation where a Ground Fault Circuit Interrupter (GFCI) is used as additional protection, this circuit interrupter must trip out when ground fault currents with DC content (pulsating DC) occur.

- If rigid conduit is to be used, the hub must be connected to the conduit system before it is connected to the terminal box of the pump.
- The pump must be connected to an external mains switch.
- The pump requires no external motor protection.
- The motor incorporates thermal protection against slow overloading and blocking (IEC 34-11: TP 211).
- When switched on via the power supply, the pump will start pumping after approximately 5 seconds.

Note

The number of starts and stops via the power supply must not exceed four times per hour.

5.1 Supply voltage

Check nameplate voltage.

1 x 115 V ± 10 %, 50/60 Hz, PE.

1 x 208-230 V ± 10 %, 50/60 Hz, PE.

See pump nameplate for rated supply voltage

The voltage tolerances are intended for mains voltage variations. They should not be used for running pumps at other voltages than those stated on the nameplate.

5.2 Connection to the power supply

5.2.1 Models 32-XX

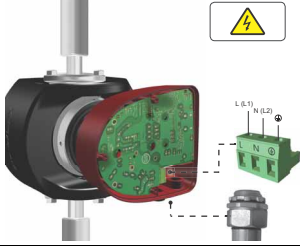
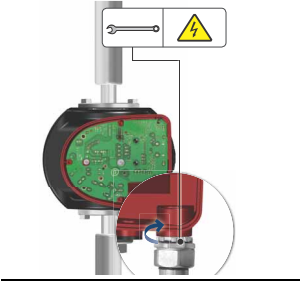
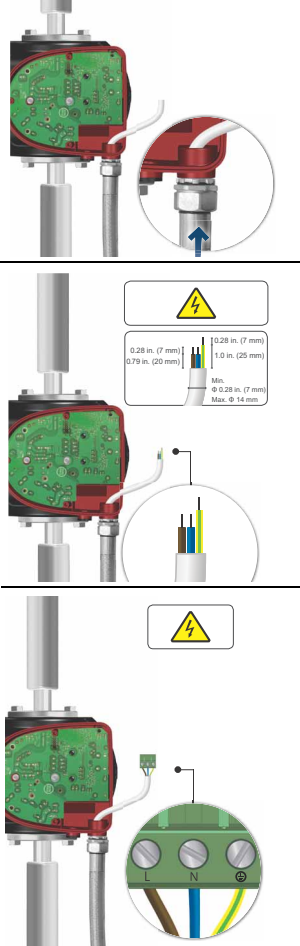
Step	Action	Illustration
1	Remove the front cover from the control box.	
2	Locate the power supply plug inside the control box.	
3	Connect the conduit and feed the power cable through the control box.	
4	Strip the wires as illustrated and connect the conductors to the power supply plug.	

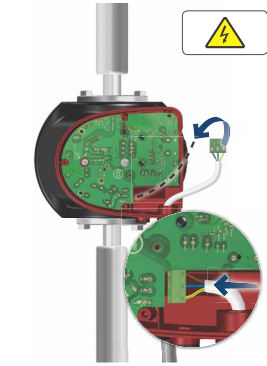
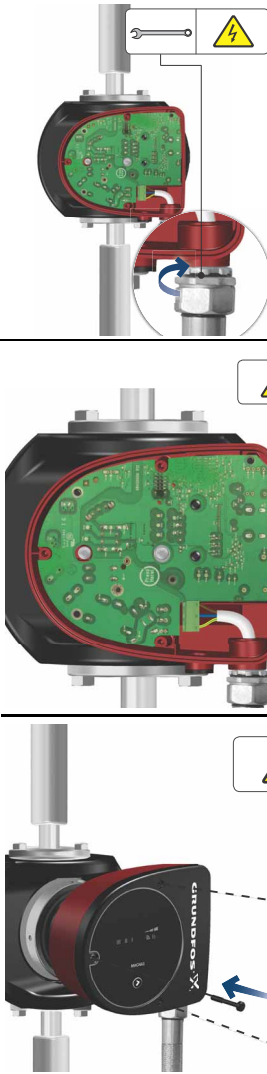
Step	Action	Illustration
5	Insert the supply plug into the power receptacle on the PCB.	
6	Tighten the conduit and refit the front cover.	

5.2.2 Models 40-XX, 50-XX, 65-XX, 80-XX, 100-XX



Step	Action	Illustration
1	Remove the front cover from the control box. Note: Do not remove the screws from the cover.	
2	Locate the power supply plug and conduit adapter in the box supplied with the pump.	
3	Connect the conduit adapter to the control box.	
4	Pull the power supply cable through the conduit adapter.	
5	Strip the cable conductors as illustrated.	

Step	Action	Illustration
6	Connect the cable conductors to the power supply plug. L - L or L1 Ground - Ground N - N or L2	
7	Insert the power supply plug into the male plug in the pump control box.	
8	Tighten the conduit adapter. Refit the front cover.	

6. First start-up

Do not start the pump until the system has been filled with liquid and vented. Furthermore, the required minimum inlet pressure must be available at the pump inlet. See section 13. *Technical data*.

The system cannot be vented through the pump. The pump is self-venting.

Step	Action	Illustration
1	<p>Switch on the power supply to the pump. Note: When switched on, the pump will start after approximately 5 seconds.</p>	
2	<p>Control panel at first start-up.</p>	
3	<p>The pump has been factory-set to the intermediate proportional-pressure curve. Select the control mode according to the system application.</p>	

TM05 5550 3812

TM05 5551 3812

TM05 5551 3812

7. Settings



8. Control panel



Warning
At high liquid temperatures, the pump housing may be very hot. In that case, only touch the control panel.

8.1 Elements on the control panel

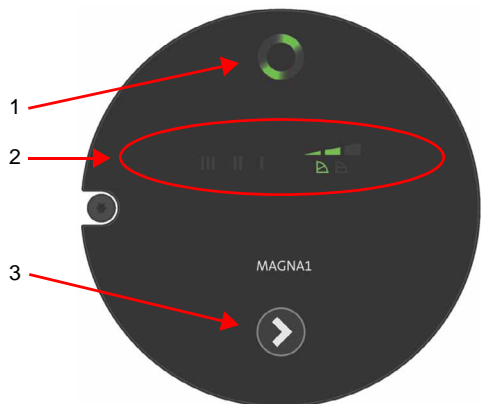

Fig. 13 Control panel

The control panel on the pump comprises the following elements:

Pos.	Description
1	Grundfos Eye operating status. See section 8.2 Grundfos Eye.
2	Eight light fields indicating the pump setting. See section 8.3 Light fields indicating the pump setting.
3	Push-button for selection of pump setting.

8.2 Grundfos Eye

The Grundfos Eye is on when the power supply has been switched on. See fig. 13, pos. 1.

The Grundfos Eye is an indicator light providing information about the actual pump status.

The indicator light will flash in different sequences and provide information about the following:

- power on/off
- pump alarms.

The function of the Grundfos Eye is described in section 12.1 Grundfos Eye operating status.

Note

Faults preventing the pump from operating properly (for example blocked rotor) are indicated by the Grundfos Eye. See section 12.1 Grundfos Eye operating status.

If a fault is indicated, correct the fault and reset the pump by switching the power supply off and on.

Note

If the pump impeller is rotated, for example when filling the pump with water, sufficient energy can be generated to light up the control panel even if the power supply has been switched off.

8.3 Light fields indicating the pump setting

The pump has nine optional performance settings which can be selected with the push-button. See fig. 13, pos. 2 and 3.

The pump setting is indicated by nine light fields in the display.



Fig. 14 Factory setting

Number of button presses	Active light fields	Description
0		Intermediate proportional-pressure curve, referred to as PP2
1		Highest proportional-pressure curve, referred to as PP3
2		Lowest constant-pressure curve, referred to as CP1
3		Intermediate constant-pressure curve, referred to as CP2
4		Highest constant-pressure curve, referred to as CP3
5		Constant curve/constant speed III
6		Constant curve/constant speed II
7		Constant curve/constant speed I
8		Lowest proportional-pressure curve, referred to as PP1

TM05 5553 3812

TM05 5552 3812

9. Overview of settings

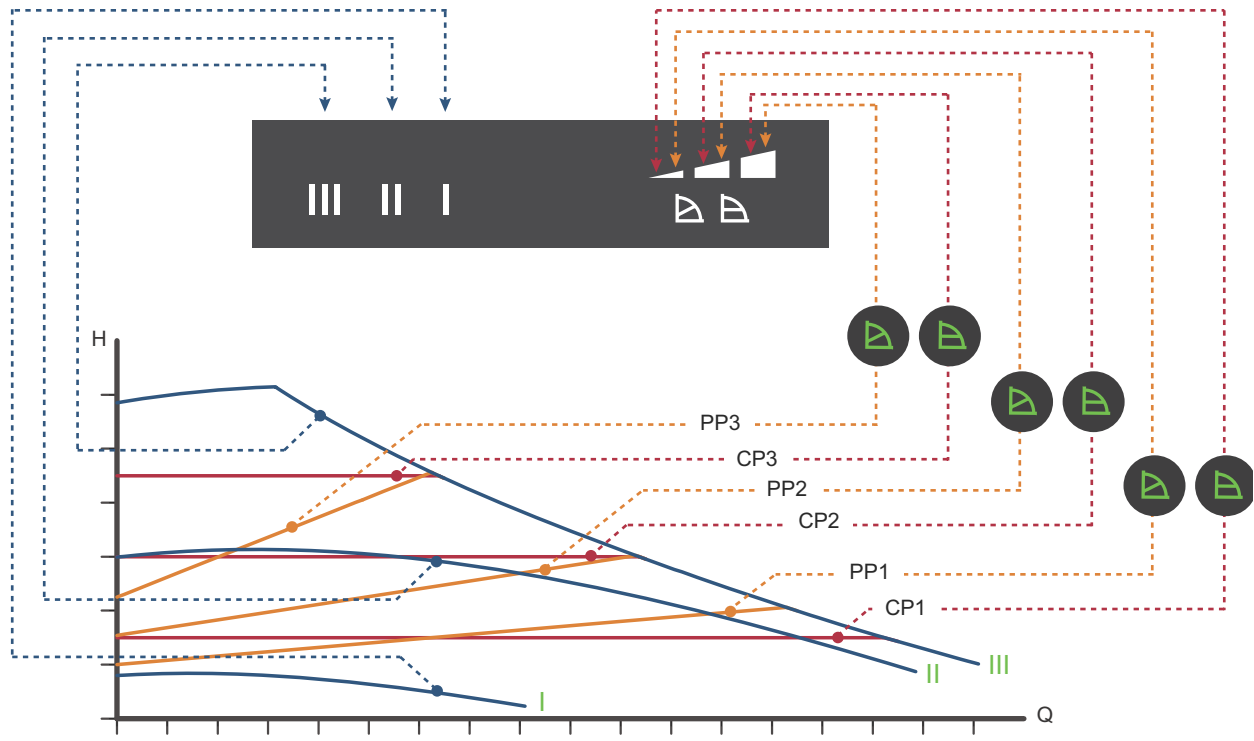

TM05 2777 0512

Fig. 15 Pump setting in relation to pump performance

Setting	Pump curve	Function
PP1	Lowest proportional-pressure curve	The duty point of the pump will move up or down on the lowest proportional-pressure curve, depending on the heat demand. See fig. 15. The head (pressure) is reduced at falling heat demand and increased at rising heat demand.
PP2	Intermediate proportional-pressure curve	The duty point of the pump will move up or down on the intermediate proportional-pressure curve, depending on the heat demand. See fig. 15. The head (pressure) is reduced at falling heat demand and increased at rising heat demand.
PP3	Highest proportional-pressure curve	The duty point of the pump will move up or down on the highest proportional-pressure curve, depending on the heat demand. See fig. 15. The head (pressure) is reduced at falling heat demand and increased at rising heat demand.
CP1	Lowest constant-pressure curve	The duty point of the pump will move out or in on the lowest constant-pressure curve, depending on the heat demand in the system. See fig. 15. The head (pressure) is kept constant, irrespective of the heat demand.
CP2	Intermediate constant-pressure curve	The duty point of the pump will move out or in on the intermediate constant-pressure curve, depending on the heat demand in the system. See fig. 15. The head (pressure) is kept constant, irrespective of the heat demand.
CP3	Highest constant-pressure curve	The duty point of the pump will move out or in on the highest constant-pressure curve, depending on the heat demand in the system. See fig. 15. The head (pressure) is kept constant, irrespective of the heat demand.
III	Speed III	The pump runs on a constant curve which means that it runs at a constant speed. In speed III, the pump is set to run on the max. curve under all operating conditions. See fig. 15. Quick venting of the pump can be obtained by setting the pump to speed III for a short period.
II	Speed II	The pump runs on a constant curve which means that it runs at a constant speed. In speed II, the pump is set to run on the intermediate curve under all operating conditions. See fig. 15.
I	Speed I	The pump runs on a constant curve which means that it runs at a constant speed. In speed I, the pump is set to run on the min. curve under all operating conditions. See fig. 15.

10. Pump setting

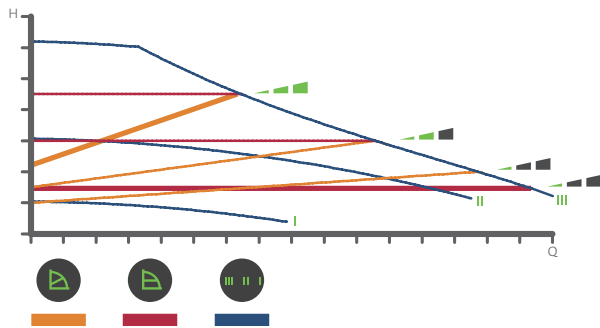

Fig. 16 Selection of pump setting for system type

Factory setting: Intermediate proportional-pressure curve, referred to as PP2.

Proportional-pressure curve (PP1, PP2 or PP3)

Proportional-pressure control adjusts the pump performance to the actual heat demand in the system, but the pump performance follows the selected performance curve, PP1, PP2 or PP3.

See fig. 17 where PP2 has been selected.

See section 11. *Selection of control mode* for further information.

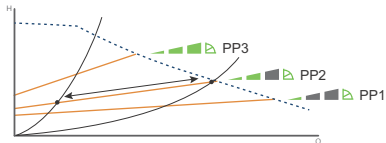

Fig. 17 Three proportional-pressure curves/settings

The selection of the right proportional-pressure setting depends on the characteristics of the heating system in question and the actual heat demand.

Constant-pressure curve (CP1, CP2 or CP3)

Constant-pressure control adjusts the pump performance to the actual heat demand in the system, but the pump performance follows the selected performance curve, CP1, CP2 or CP3.

See fig. 18 where CP1 has been selected.

See section 11. *Selection of control mode* for further information.

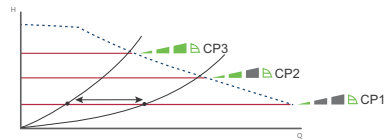

Fig. 18 Three constant-pressure curves/settings

The selection of the right constant-pressure setting depends on the characteristics of the heating system in question and the actual heat demand.

Constant curve/constant speed (I, II or III)

At constant-curve/constant-speed operation, the pump runs at a constant speed, independent of the actual flow demand in the system. The pump performance follows the selected performance curve, I, II or III. See fig. 19 where II has been selected.

See section 11. *Selection of control mode* for further information.

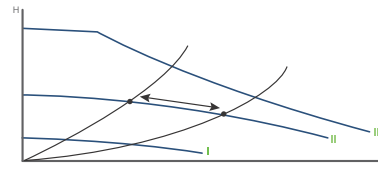
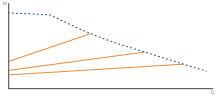
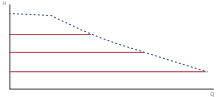
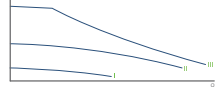

Fig. 19 Three constant-curve/constant-speed settings

The selection of the right constant-curve/constant-speed setting depends on the characteristics of the heating system in question.

11. Selection of control mode

System application	Select this control mode
<p>In systems with relatively large pressure losses in the distribution pipes and in air-conditioning and cooling systems.</p> <ul style="list-style-type: none"> • Two-pipe heating systems with thermostatic valves and <ul style="list-style-type: none"> – very long distribution pipes – strongly throttled pipe balancing valves – differential-pressure regulators – large pressure losses in those parts of the system through which the total quantity of water flows (for example boiler, heat exchanger and distribution pipe up to the first branching). • Primary circuit pumps in systems with large pressure losses in the primary circuit. • Air-conditioning systems with <ul style="list-style-type: none"> – heat exchangers (fan coils) – cooling ceilings – cooling surfaces. 	<p>Proportional pressure</p> 
<p>In systems with relatively small pressure losses in the distribution pipes.</p> <ul style="list-style-type: none"> • Two-pipe heating systems with thermostatic valves and <ul style="list-style-type: none"> – dimensioned for natural circulation – small pressure losses in those parts of the system through which the total quantity of water flows (for example boiler, heat exchanger and distribution pipe up to the first branching) or – modified to a high differential temperature between flow pipe and return pipe (for example district heating). • Underfloor heating systems with thermostatic valves. • One-pipe heating systems with thermostatic valves or pipe balancing valves. • Primary circuit pumps in systems with small pressure losses in the primary circuit. 	<p>Constant pressure</p> 
<p>The pump can also be set to operate according to the max. or min. curve, like an uncontrolled pump:</p> <ul style="list-style-type: none"> • The max. curve mode can be used in periods in which a maximum flow is required. This operating mode is for instance suitable for hot-water priority. • The min. curve mode can be used in periods in which a minimum flow is required. This operating mode is for instance suitable for manual night setback. 	<p>Constant curve</p> 



12. Fault finding



Warning

Before dismantling the pump, drain the system or close the isolating valve on either side of the pump. The pumped liquid may be scalding hot and under high pressure.

12.1 Grundfos Eye operating status

Grundfos Eye	Indication	Cause
	No lights on.	Power off. Pump not running.
	Two opposite green indicator lights running in the direction of rotation of the pump.	Power on. Pump running.
	Two opposite red indicator lights flashing simultaneously.	Alarm. Pump stopped.

12.2 Resetting of fault indications

A fault indication can be reset in one of the following ways:

- When the fault cause has been eliminated, the pump will revert to normal duty.
- If the fault disappears by itself, the fault indication will automatically be reset.

Fault	Automatic reset and restart?	Corrective actions
Other pumps or sources force flow through the pump even if the pump is stopped. There will be light in the display even if the power supply has been switched off.	Yes	Check the system for defective non-return valves and replace, if necessary. Check the system for correct position of non-return valves, etc.
Supply voltage to the pump too low.	Yes	Check that the power supply is within the specified range.
The pump is blocked.	No	Dismantle the pump, and remove any foreign matter or impurities preventing the pump from rotating.
No water at the pump inlet or the water contains too much air.	No	Prime and vent the pump before a new start-up. Check that the pump is operating correctly. If not, replace the pump, or call GRUNDFOS SERVICE for assistance.
Internal fault in the pump electronics.	Yes	Replace the pump, or call GRUNDFOS SERVICE for assistance.
Supply voltage to the pump too high.	Yes	Check that the power supply is within the specified range.

Caution

If the power supply cable is damaged, it must be replaced by the manufacturer, the manufacturer's service partner or a similarly qualified person.

13. Technical data

Supply voltage

See pump nameplate for rated supply voltage:

1 x 115 V ± 10 %, 50/60 Hz, PE.

1 x 208-230 V ± 10 %, 50/60 Hz, PE.

Motor protection

The pump requires no external motor protection.

Enclosure class

Enclosure Type 2.

Insulation class

F.

Relative air humidity

Maximum 95 %.

Ambient temperature

+32 to +104 °F (0 to +40 °C).

During transport: -40 to 158 °F (-40 to +70 °C).

Temperature class

TF110 (EN 60335-2-51).

Liquid temperature

Continuously: +14 to +230 °F (-10 to +110 °C).

System pressure

The maximum permissible system pressure is stated on the pump nameplate:

175 psi (12 bar).

Minimum inlet pressure

The following relative minimum inlet pressure must be available at the pump inlet during operation to avoid cavitation noise and damage to the pump bearings.

Single-head pumps DN	Liquid temperature		
	+167 °F (+75 °C)	+203 °F (+95 °C)	+230 °F (+110 °C)
	Inlet pressure [psi] / [bar] / [MPa]		
32-60/100	1.45 / 0.10 / 0.01	5.1 / 0.35 / 0.035	14.5 / 1.0 / 0.10
40-80	1.45 / 0.10 / 0.01	7.25 / 0.50 / 0.05	14.5 / 1.0 / 0.10
40-120/180	1.45 / 0.10 / 0.01	7.25 / 0.50 / 0.05	14.5 / 1.0 / 0.10
50-80	1.45 / 0.10 / 0.01	5.8 / 0.40 / 0.04	14.5 / 1.0 / 0.10
50-150	10.1 / 0.70 / 0.07	17.4 / 1.20 / 0.12	24.65 / 1.7 / 0.17
65-120	10.1 / 0.70 / 0.07	17.4 / 1.20 / 0.12	24.65 / 1.7 / 0.17
65-150	10.1 / 0.70 / 0.07	17.4 / 1.20 / 0.12	24.65 / 1.7 / 0.17
80-100	7.25 / 0.50 / 0.05	14.5 / 1.00 / 0.10	21.75 / 1.5 / 0.15
100-120	10.1 / 0.70 / 0.07	17.4 / 1.20 / 0.12	24.65 / 1.7 / 0.17

Note

The actual inlet pressure plus pump pressure against a closed valve must be lower than the maximum permissible system pressure.

The relative minimum inlet pressures apply to pumps installed up to 984 ft (300 m), above sea level. For altitudes above 984 ft (300 m), the required relative inlet pressure must be increased by 0.145 psi / 0.01 bar / 0.001 MPa per 328 ft (100 m) altitude. The MAGNA1 pump is only approved for an altitude of 6561 ft (2000 m) above sea level.

EMC (electromagnetic compatibility)

EN 55014-1:2006, EN 55014-2:1998, EN 61800-3-3:2008 and EN 61000-3-2:2006.

Sound pressure level

The sound pressure level of the pump is lower than 43 dB(A).

Leakage current

The pump mains filter will cause a discharge current to earth during operation. $I_{\text{leakage}} < 3.5 \text{ mA}$.

Power factor

The MAGNA1 has built-in PFC (Power Factor Correction) which gives a $\cos \phi$ from 0.98 to 0.99, i.e. very close to 1.

14. Disposal

This product has been designed with focus on the disposal and recycling of materials. The following average disposal values apply to all variants of Grundfos MAGNA1 pumps:

- 85 % recycling
- 10 % incineration
- 5 % depositing.

This product or parts of it must be disposed of in an environmentally sound way according to local regulations.

Subject to alterations.

GRUNDFOS Kansas City

17100 West 118th Terrace
Olathe, Kansas 66061
Phone: (913) 227-3400
Fax: (913) 227-3500

www.grundfos.us

GRUNDFOS Canada

2941 Brighton Road
Oakville, Ontario L6H 6C9 Canada
Phone: +1-905 829 9533
Telefax: +1-905 829 9512

www.grundfos.ca

GRUNDFOS México

Boulevard TLC No. 15
Parque Industrial Stiva Aeropuerto
C.P. 66600 Apodaca, N.L. México
Phone: 011-52-81-8144 4000
Fax: 011-52-81-8144 4010

www.grundfos.mx

L-MAG-TL-08

98459387 0714

ECM: 1138863

© Copyright Grundfos Holding A/S

The name Grundfos, the Grundfos logo, and be think innovate are registered trademarks owned by Grundfos Holding A/S or Grundfos A/S, Denmark. All rights reserved worldwide.