

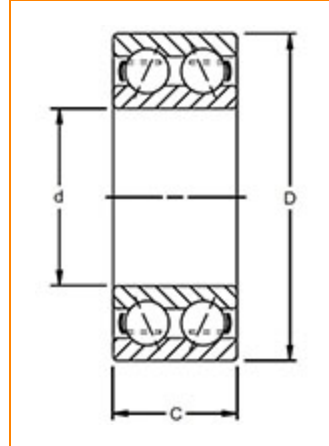

The Timken Company

4500 Mt Pleasant St. NW

N. Canton, OH 44720

Phone: (234) 262-3000

E-Mail: CustomerCAD@timken.com • **Web site:** www.timken.com
Part Number 5308K, Fafnir® Double Row Angular Contact Ball Bearings (5200, 5300, 5400)

[Specifications](#) | [Dimensions](#) | [Basic Load Ratings](#) | [Abutment and Fillet Dimensions](#)
Specifications

Design Units	Metric
d - Bore	40 mm
Ball Type	STEEL
Cage Type	Snap In
Manufacturing Part Number	5308K C3

Dimensions

D - Outer Diameter	90 mm 3.5433 in
C - Ring Width	36.53 mm 1.438 in
Contact Angle	20 °



Basic Load Ratings

C0 - Static Radial Rating	46000 N 10400 lbf
Ce - Dynamic Radial Rating¹	72400 N 16300 lbf

Abutment and Fillet Dimensions

R - Inner Ring "To Clear" Radius²	1.5 mm 0.059 in
r - Outer Ring "To Clear" Radius³	1.5 mm 0.059 in
da - Inner Ring Backing Diameter	49.911 mm 1.965 in
Da - Outer Ring Backing Diameter	79.375 mm 3.125 in

¹ Based on 10^6 revolutions of calculated fatigue life.

² Maximum housing fillet radius that bearing corners will clear.

³ Maximum shaft fillet radius that bearing corners will clear.

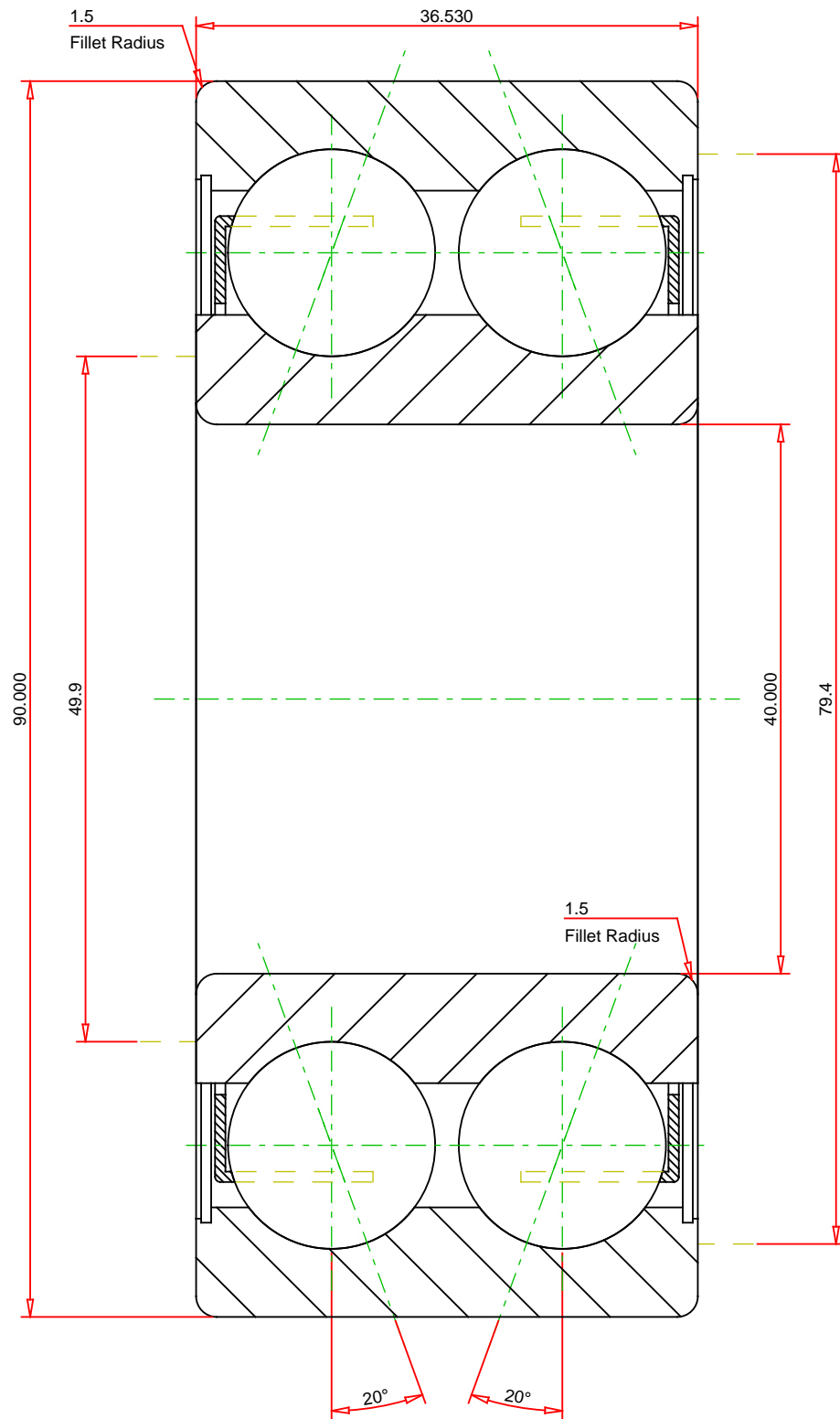

METRIC UNITS

Number of Balls Per Row	8
Bearing Weight	1.139 kg

TIMKEN®

THE TIMKEN COMPANY
NORTH CANTON, OHIO USA

5308K	
Fafnir® Double Row Angular Contact Ball Bearings (5200, 5300, 5400)	
Dynamic Load Rating	72400 N
Static Load Rating	46000 N

Every reasonable effort has been made to ensure the accuracy of the information contained in this writing, but no liability is accepted for errors, omissions or for any other reason.

FOR DISCUSSION ONLY