

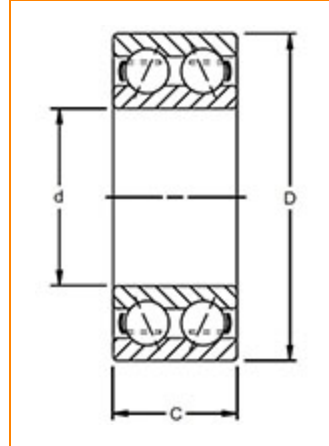

The Timken Company

4500 Mt Pleasant St. NW

N. Canton, OH 44720

Phone: (234) 262-3000

E-Mail: CustomerCAD@timken.com • **Web site:** www.timken.com
Part Number 5215K, Fafnir® Double Row Angular Contact Ball Bearings (5200, 5300, 5400)

[Specifications](#) | [Dimensions](#) | [Basic Load Ratings](#) | [Abutment and Fillet Dimensions](#)
Specifications

Design Units	Metric
d - Bore	75 mm
Ball Type	STEEL
Cage Type	Snap In
Manufacturing Part Number	5215KC3

Dimensions

D - Outer Diameter	130 mm 5.1181 in
C - Ring Width	41.28 mm 1.6250 in
Contact Angle	20°



Basic Load Ratings

C0 - Static Radial Rating	85700 N 19300 lbf
Ce - Dynamic Radial Rating¹	108000 N 24500 lbf

Abutment and Fillet Dimensions

R - Inner Ring "To Clear" Radius²	1.5 mm 0.059 in
r - Outer Ring "To Clear" Radius³	1.5 mm 0.059 in
da - Inner Ring Backing Diameter	84.963 mm 3.345 in
Da - Outer Ring Backing Diameter	118.745 mm 4.675 in

¹ Based on 10^6 revolutions of calculated fatigue life.

² Maximum housing fillet radius that bearing corners will clear.

³ Maximum shaft fillet radius that bearing corners will clear.

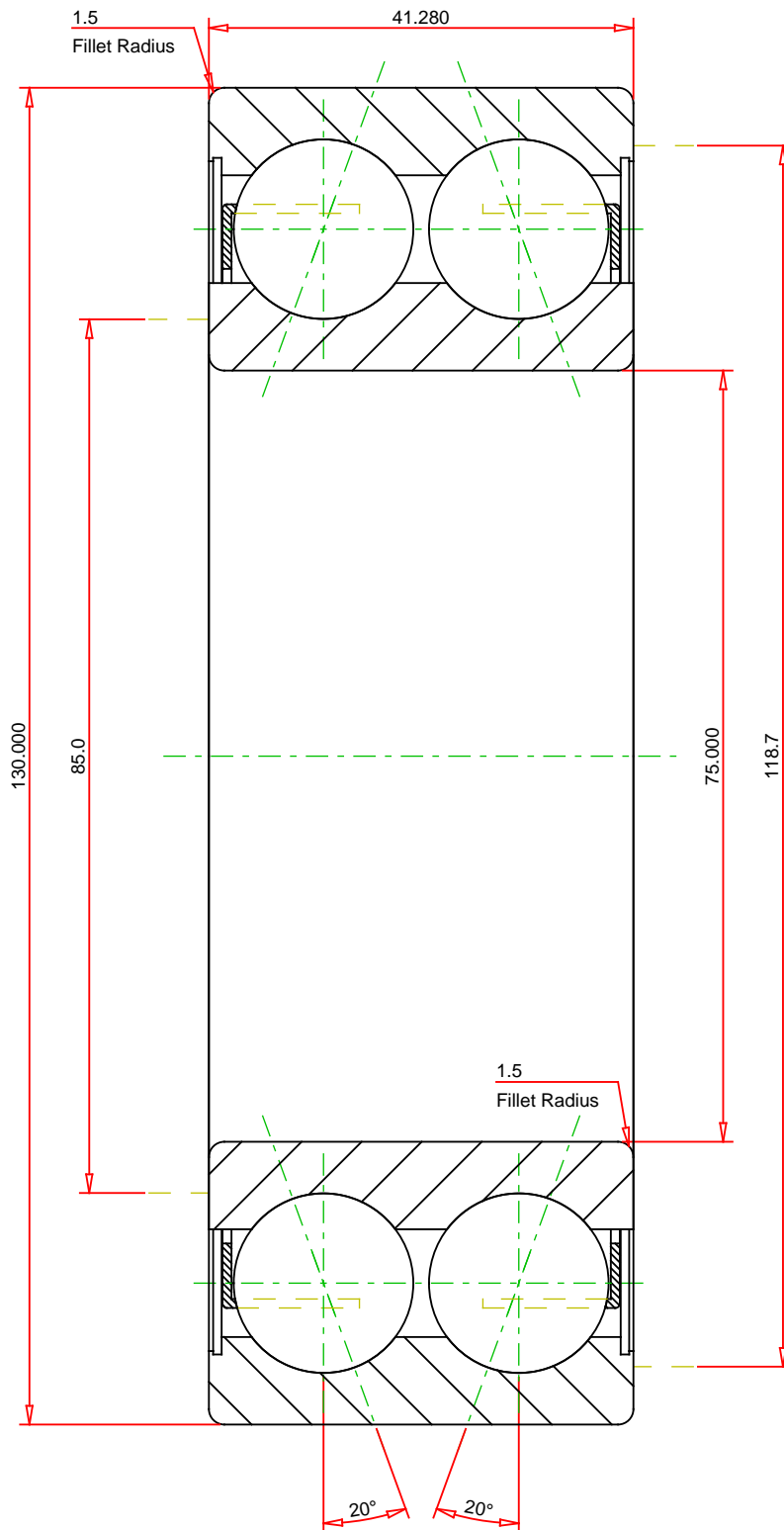

METRIC UNITS

Number of Balls Per Row	10
Bearing Weight	2.336 kg

TIMKEN®

THE TIMKEN COMPANY
NORTH CANTON, OHIO USA

5215K	
Fafnir® Double Row Angular Contact Ball Bearings (5200, 5300, 5400)	
Dynamic Load Rating	108000 N
Static Load Rating	85700 N

Every reasonable effort has been made to ensure the accuracy of the information contained in this writing, but no liability is accepted for errors, omissions or for any other reason.

FOR DISCUSSION ONLY