

The Timken Company

4500 Mt Pleasant St. NW

N. Canton, OH 44720

Phone: (234) 262-3000

E-Mail: CustomerCAD@timken.com • **Web site:** www.timken.com

Part Number 330385, Oil Seals Inch

Oil seals are used wherever shafts rotate and bearings require lubrication. Available in inch and metric sizes, the Timken line of O-Ring Seal Kits have the coverage you need for the most popular applications.

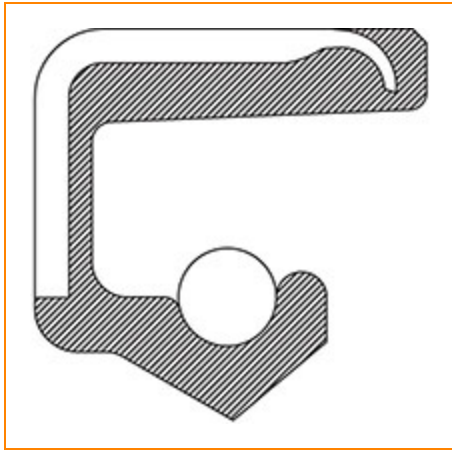

[Notes](#) | [Specifications](#) | [Dimensions](#)

Notes

Disclaimer

CAD Models / Sales Drawings are accurate envelope dimensions. Internal features such as lip position may vary from seal to seal and are only representative.

Specifications

Seal Type
[33](#)
Material

Nitrile

Series

330000

Inch/Metric

Inch



Dimensions

Shaft Size	0.375 in 9.525 mm
Outer Diameter	0.754 in 19.152 mm
Overall Width	0.25 in 6.35 mm
Housing Bore	0.75 in 19.05 mm