



The Timken Company

4500 Mt Pleasant St. NW

N. Canton, OH 44720

Phone: (234) 262-3000

E-Mail: CustomerCAD@timken.com • **Web site:** www.timken.com

Part Number SCJ1 1/4, Fafnir® Four-Bolt Flanged Mounted Bearings Setscrew Locking

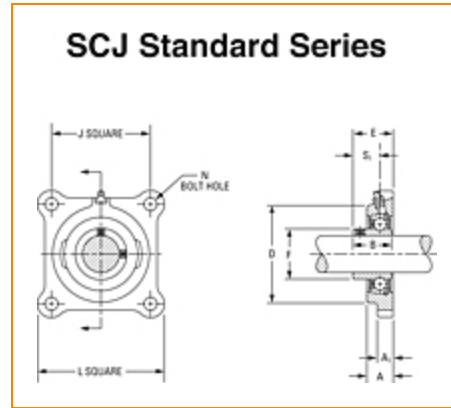

[Specifications](#) | [Dimensions](#) | [Basic Load Ratings](#)

Specifications

Series	Standard
Shaft Size d	1 1/4 in
Bearing Number	GYA104RRB
Seal Type	Molded Shroud
Housing Construction	Four-Bolt Square Flange
Alternate Part Name	SCJ11/4

Dimensions

Total Length L	117.5 mm 4.626 in
Housing Width A	24.6 mm 0.969 in



Bolt Hole Spacing	92.08 mm 3.625 in
Bolt Hole Size N	12 mm 0.472 in
Flange Thickness A1	15.1 mm 0.594 in
Center of Bearing from Housing End A2	12.3 mm 0.484 in
Inside Ring Width B	36.5 mm 1.4370 in
Dimension S1	25.65 mm 1.01 in
Dimension D	88.900 mm 3 1/2 in
Dimension E	38.1 mm 1.5 in
Dimension F	46.8 mm 1.8430 in
Bolt Size	M12

Basic Load Ratings

Static Load Rating	15300 N 3440 lbf
Dynamic Load Rating	28500 N 6400 lbf

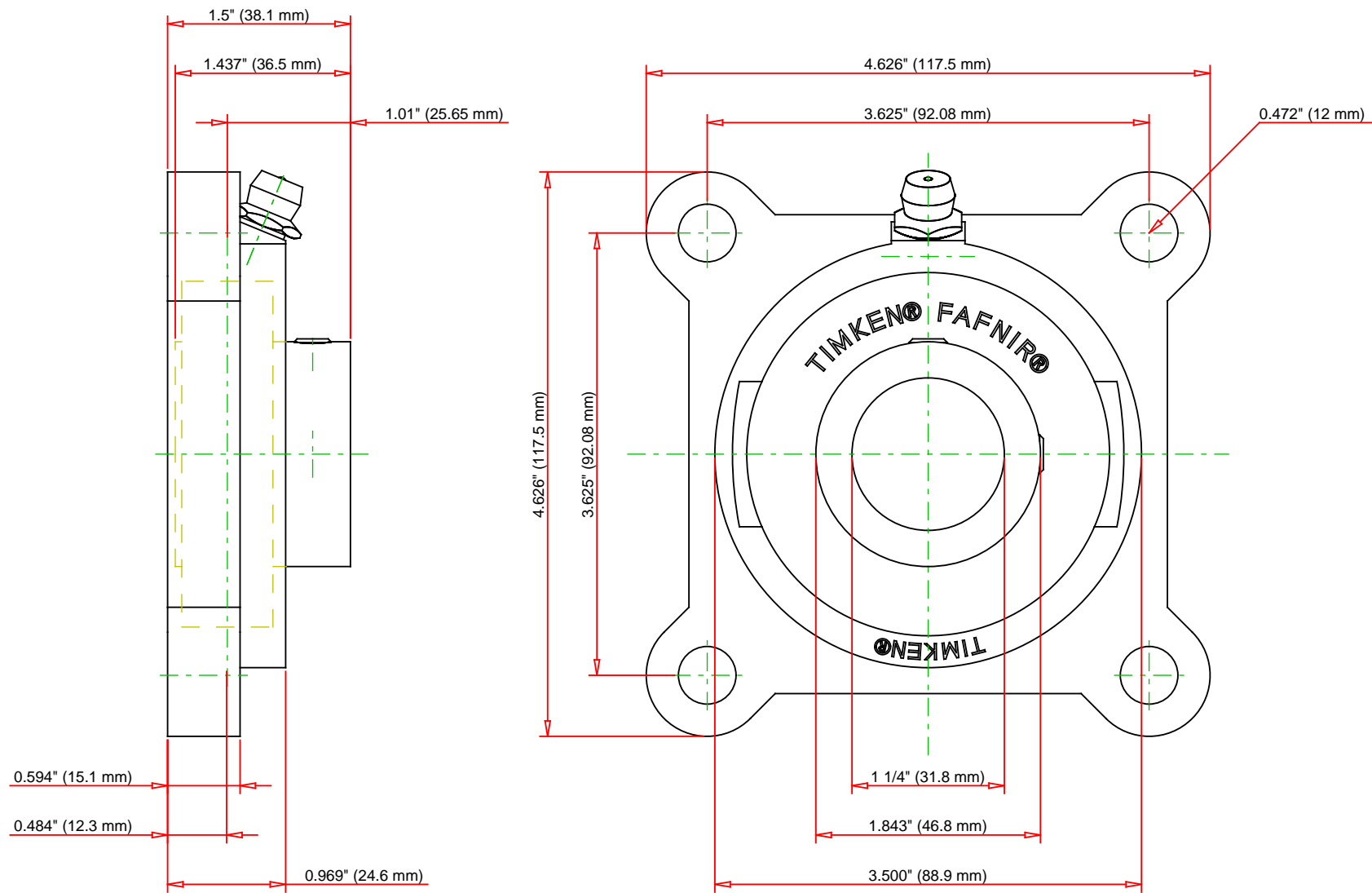

Bearing Number	GYA104RRB			
Load Ratings - C _r	6400	lbf	28500	N
Load Ratings - C _{0r}	3440	lbf	15300	N
Weight	2.98	lb	1.35	kg
Bolt Size	M8x1.25			

TIMKEN®
 THE TIMKEN COMPANY
 NORTH CANTON, OHIO USA

SCJ1 1/4
 Fafnir® Four-Bolt Flanged Mounted Bearings
 Setscrew Locking

Every reasonable effort has been made to ensure the accuracy of the information contained in this writing, but no liability is accepted for errors, omissions or for any other reason.

FOR DISCUSSION ONLY