

The Timken Company

4500 Mt Pleasant St. NW

N. Canton, OH 44720

Phone: (234) 262-3000

E-Mail: CustomerCAD@timken.com • **Web site:** www.timken.com

Part Number E-P2B-TRB-1 1/2, Type E Pillow Block: 2-Bolt Base Bearing

Type E tapered roller bearing Mounted Bearings are available in a wide variety of sizes and configurations to meet the requirements of demanding applications. Popular part numbers are in stock for immediate availability. Metric sizes also are available in shaft diameters ranging from 35 mm to 125 mm.

Open and Closed end covers available for purchase.

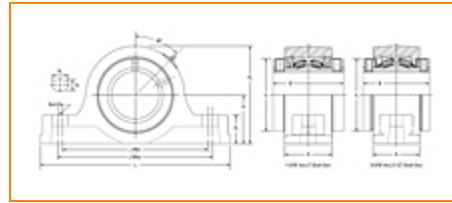

[Specifications](#) | [Dimensions](#) | [Radial and Thrust Factors; Speed and Slip-Fit Load Limits](#) | [Note](#)

Specifications

Shaft Size	1 1/2 in
Shaft Size Type	Imperial
UPC Code	053893606637
Lubrication	Grease - Premium Industrial
Housing Coating	E-Coat

Dimensions



Dimension B	3-3/8 in
Dimension L	7-7/8 in
Dimension A	2-3/8 in
Dimension J Min.	6-1/8 in
Dimension J Max.	6-3/8 in
Bolt Diameter	1/2 in
Dimension N	5/8 in
Dimension N₁	3/4 in
Dimension H₁	1-1/4 in
Dimension H₂	4-1/4 in
Dimension d₁	3-3/16 in
Dimension H	2-1/8 in

Radial and Thrust Factors; Speed and Slip-Fit Load Limits

e	0.44
X (if $F_a/F_r \leq e$)	0.87
Y (if $F_a/F_r \leq e$)	1.96
X (if $F_a/F_r > e$)	0.7
Y (if $F_a/F_r > e$)	2.37
K Factor	1.36
C₉₀ Dynamic Load Rating¹	7860 lbf
C₀ Static Load Rating	33000 lbf

F_{a-max} Maximum Permissible Thrust Load²	2590 lbf
F_{r-max} Maximum Allowable Slip Fit Radial Load³	6400 lbf
Max. Speed⁴	3320 rpm

Note

Note: All units have a 1/8" pipe thread grease fitting

The Maximum Permissible Thrust Load applies to conditions of slip fit with set screw mounting or in applications where a large moment loading occurs. The values shown are valid only when two collars and set screws are used.

Note

When heavy thrust forces are applied, the friction between the pillow block base may not be sufficient to prevent movement. Mechanical stops or shear bars with strength sufficient to support the load should be added. Never weld the pillow block or bearing to secure it to the shaft or base.

¹ C₉₀ is the Dynamic Load Rating based on a rated Life of 90 million revolutions (3000 hrs at 500 RPM).

² F_{a-max} is based on the limits of the holding force of two properly tightened collars and set screws. Fifty percent of the values should be used when a single collar is installed.

³ If the application loads approach or exceed F_{r-max}, the shaft fit should be adjusted to a line-to-line (g6 or h6) or light press fit (m6).

⁴ Timken Double Lip Seal

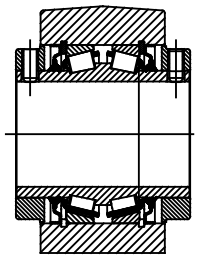
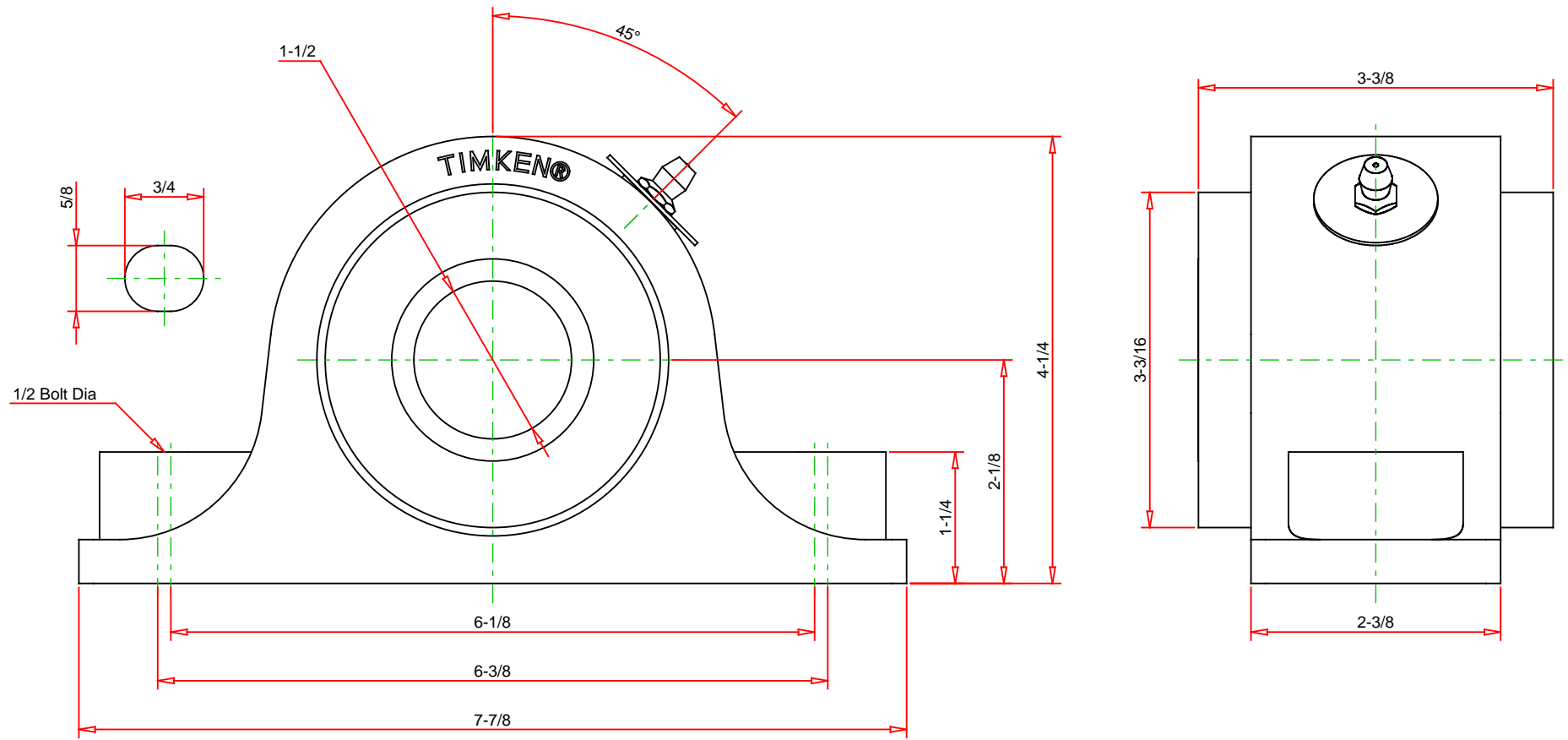

Note: Section View not to Scale

IMPERIAL UNITS

C90	7860	LBS
Co	33000	LBS
Fa-MAX	2590	LBS
Fr-MAX	6400	LBS
MAX SPEED	3320	RPM

TIMKEN
 THE TIMKEN COMPANY
 NORTH CANTON, OHIO USA

E-P2B-TRB-1 1/2
PILLOW BLOCK: 2-BOLT BASE

Every reasonable effort has been made to ensure the accuracy of the information contained in this writing, but no liability is accepted for errors, omissions or for any other reason.

FOR DISCUSSION ONLY