

The Timken Company

4500 Mt Pleasant St. NW

N. Canton, OH 44720

Phone: (234) 262-3000

E-Mail: CustomerCAD@timken.com • **Web site:** www.timken.com

Part Number E-PF-TRB-1 15/16, Type E Flange: Piloted Bearing

Type E tapered roller bearing Mounted Bearings are available in a wide variety of sizes and configurations to meet the requirements of demanding applications. Popular part numbers are in stock for immediate availability. Metric sizes also are available in shaft diameters ranging from 35 mm to 125 mm.

1-3/16 to 3-1/2 utilize one collar

3-15/16 to 5 utilize two collars

6 holes equally spaced (chordal spacing shown)

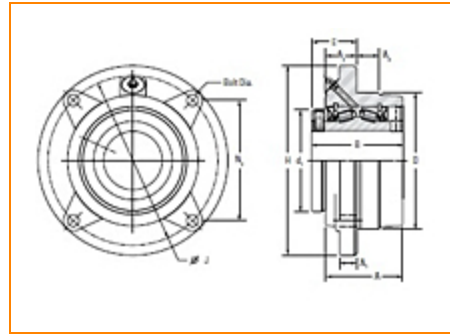

[Specifications](#) | [Radial and Thrust Factors](#); [Speed and Slip-Fit Load Limits](#) | [Note](#)

Specifications

Shaft Size Type	Imperial
UPC Code	053893778723
Lubrication	Grease - Premium Industrial
Housing Coating	E-Coat

Radial and Thrust Factors; Speed and Slip-Fit Load Limits



0.33

X (if $F_a/F_r \leq e$)

0.87

Y (if $F_a/F_r \leq e$)

2.64

X (if $F_a/F_r > e$)

0.7

Y (if $F_a/F_r > e$)

3.18

K Factor

1.83

Max. Speed¹

3050 rpm

Note

Note: All units have a 1/8" pipe thread grease fitting

The Maximum Permissible Thrust Load applies to conditions of slip fit with set screw mounting or in applications where a large moment loading occurs. The values shown are valid only when two collars and set screws are used.

Note

When heavy thrust forces are applied, the friction between the pillow block base may not be sufficient to prevent movement. Mechanical stops or shear bars with strength sufficient to support the load should be added. Never weld the pillow block or bearing to secure it to the shaft or base.

¹ Timken Double Lip Seal

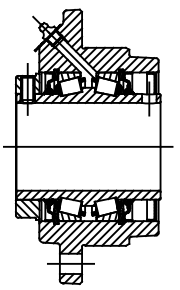
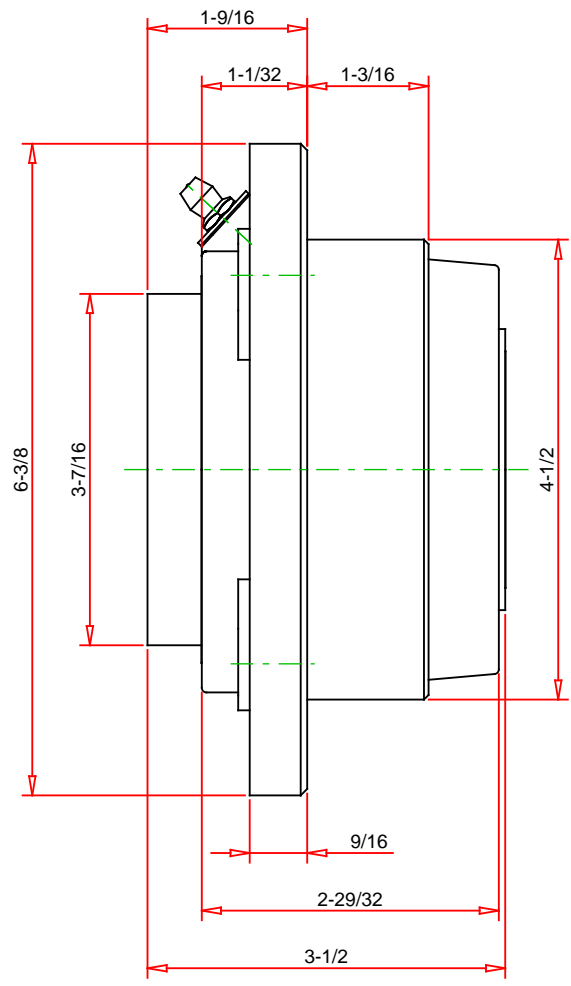
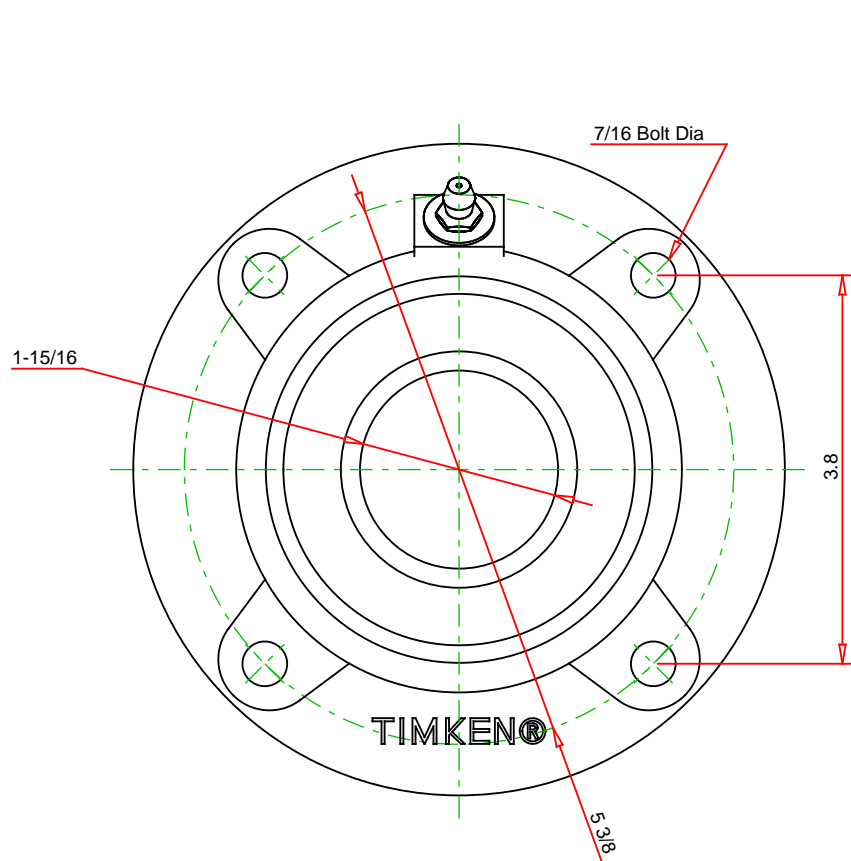

Note: Section View not to Scale

IMPERIAL UNITS

C90	10300	LBS
Co	43000	LBS
Fa-MAX	2590	LBS
Fr-MAX	8400	LBS
MAX SPEED	3050	RPM

TIMKEN®

THE TIMKEN COMPANY
NORTH CANTON, OHIO USA

E-PF-TRB-1 15/16
FLANGE: PILOTED

Every reasonable effort has been made to ensure the accuracy of the information contained in this writing, but no liability is accepted for errors, omissions or for any other reason.

FOR DISCUSSION ONLY