

# Series 9000 LaserSight Photoelectric Sensors

Catalog Numbers 42GRP-90L0, 42GRP-90L0-QD, 42GRP-92L2, 42GRP-92L2-QD, 42GRU-92L0, 42GRU-92L0-QD, 42GRU-92L0-QD1, 42GRU-92L2, 42GRP-92L2-QD

**IMPORTANT** Save these instructions for future use.

## Description

The LaserSight™ 9000 is a Class 1 visible red laser sensor designed for the detection of small parts in the packaging, material handling and semi-conductor industries. This sensor offers multiple sensing modes suitable for general purpose detection that can be easily set up by using the single-turn potentiometer and the highly visible user interface.

## Features

- Small spot size suitable for high precision sensing
- Class 1 visible laser beam for ease of alignment
- Precision long distance object detection in polarized and transmitted beam sensing modes
- Selectable light operate or dark operate
- Solid-state DC output and SPDT relay output models
- IP69K rated

## Description of Laser Class

**Class 1 Laser Product**  
Complies with 21 CFR 1040.10 and 1040.11 except for deviations pursuant to Laser Notice No. 50, dated June 24, 2007.

**CAUTION...Do not disassemble for repair**

Use of control or adjustments or performance of procedures other than those specified herein may result in hazardous radiation exposure. Do NOT attempt to disassemble this sensor for repair. A defective unit must be returned to the manufacturer.

## Class 1

Lasers that are safe under reasonably foreseeable conditions of operation, including the use of optical instruments for intrabeam viewing.

Reference IEC 60825-1:2007.

## Class 1 Laser Characteristics

For Safe Laser Use (see specifications):

- Do not permit a person to stare at the laser from within the beam.
- Do not point the laser at a person's eye at close range.
- Locate open laser beam paths either above or below eye level, where practical.

## Specifications

Certifications	cULus and CE Marked for all applicable directives	
<b>Environmental</b>		
Operating Environment	IP69K, NEMA 3, 4X, 6P, IP67 with 1200 psi washdown	
Operating Temperature [C (F)]	-10...+50° (14...122°)	
Vibration	10...55Hz, 1 mm amplitude; meets or exceeds IEC 60947-5-2	
Shock	30 g with 11 ms pulse duration, meets or exceeds IEC 60947-5-2	
Relative Humidity	5...95% (noncondensing)	
Ambient Light Immunity	5000 Lux (Incandescent light)	
<b>Optical</b>		
Sensing Modes	Sensing Range	Spot Size @ max. distance
Standard Diffuse	1...800 mm (0.03...31.5 in.)	2.0 x 3.5 mm (0.08 x 0.14 in.)
Polarized Retroreflective	0.3...40 m (1...130 ft)	20 x 25 mm (0.79 x 0.98 in.)
Transmitted Beam	300 m (1000 ft)	140 x 175 mm (5.5 x 6.89 in.)
Light Source	Visible red laser (650 nm)	
<b>Electrical</b>		
Voltage	10...30V DC, 105...132V AC, 70...264V AC/DC	
Current Consumption	45mA max (DC), 10 mA max (AC/DC), 70 mA max (AC)	
Sensor Protection	DC: Overload and short circuit, reverse polarity and false pulse	
<b>Outputs</b>		
Response Time	0.5 ms (diffuse, polarized retroreflective) 25 ms (SPDT relay) max.	
Output Type	PNP and NPN, SPDT EM relay	
Output Mode	Light or dark operate selectable	
Output Current	250 mA (DC), PNP/NPN 250 mA DC relay: 2 A @ 120V AC; 1 A @ 240V AC; 3 A @ 28V DC	
<b>Mechanical</b>		
Housing Material	Valox®	
Lens Material	Acrylic	
Connector Material	Neoprene	
Connection Types	2 m cable, 4-pin DC micro (M12) QD, 4-pin DC mini	
Supplied Accessories	Mounting brackets, cordsets, reflectors	

## User Interface

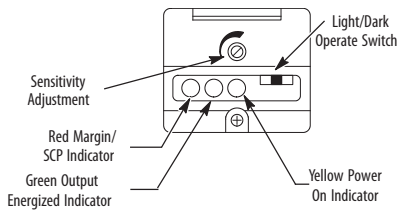

Using a screwdriver, open the top cover of the sensor to access the user interface panel. This panel contains a single-turn sensitivity adjustment knob, a two-position mode selector switch, along with three LED status indicators.

**IMPORTANT** Damage to the single-turn sensitivity adjustment knob may occur if turned beyond min./max. stop points.

Using a screwdriver, the sensitivity can be increased (clockwise) or decreased (counterclockwise) to meet the application requirements. The factory default setting for all versions is maximum sensitivity.

The LaserSight photoelectric sensor also contains a two-position selector switch. This switch is used to select either light or dark operate mode of the sensor. In the light operate mode, the sensor output will turn ON when the light is being reflected back to the sensor (reflector for retroreflective, source for transmitted beam or target for diffuse). In dark operate mode, the sensor output will turn OFF when no light is being reflected back to it.

**IMPORTANT** After initial sensor configuration, confirm that the user interface cover is closed tightly to maintain specified environmental rating!

## Status Indicators

Label	Color	State	Status
Output	Green	OFF	Output de-energized, SCP active
		ON	Output energized
Margin	Red	OFF	Margin < 2
		ON	Margin > 2
		Flashing	Output SCP active
Power	Yellow	OFF	Sensor not powered
		ON	Sensor powered

## Sensor Alignment

The red LED indicator is an alignment aid which indicates that a margin of 2X has been reached. This means that the sensor is receiving at least 2 times the signal strength back from the target needed to trigger an output signal. In general, it is desirable to have a higher margin to help overcome any deteriorating environmental conditions, e.g. dust buildup on the sensor's lens. When aligning the sensor, the best performance can be obtained if this margin indicator is illuminated with the target in place.

## Transmitted Beam Models

1. Visually align the emitter and receiver units until the green output LED turns ON (with light-operate mode) or turns OFF (with dark-operate mode).

2. To ensure that the beam is centered, it is recommended to sweep the emitter or receiver in the horizontal and vertical plane and determine at what position the output indicator turns ON and then turns OFF. Set the sensor midway between both positions. The red margin LED should also be ON when the beam is not broken.

## Polarized Retroreflective Models

1. Visually align the sensor on the reflector until the green output LED turns ON (with light-operate mode) or turns OFF (with dark-operate mode).
2. To ensure that the beam is centered, it is recommended to sweep the sensor in the horizontal and vertical plane and determine at what position the output indicator turns ON and then turns OFF. Set the sensor midway between both positions.
3. Break the beam with the object to be detected and check if the output indicator turns ON (dark-operate mode). If this does not occur, turn down the sensitivity adjustment until it does. Restore the light beam by removing the object and check if the output indicator turns OFF again and the red margin LED comes ON. If this does not occur, increase the size of the reflector or decrease the distance between the reflector and the reflector.

## Diffuse Models

1. Visually align the sensor on the object until the green output LED turns ON (with light-operate mode) or turns OFF (with dark-operate mode).
2. To ensure that the beam is centered, it is recommended to sweep the sensor in the horizontal and vertical plane and determine at what position the output indicator turns ON and then turns OFF. Set the sensor midway between both positions.
3. Remove the object in front of the sensor and eliminate any background reflection by turning down the sensitivity adjustment, if such background exists. Replace the object and verify that the output LED turns ON and the margin LED is ON. If the sensor continues to detect background reflections by turning down the sensitivity, it is recommended to eliminate these reflections by painting with a nonreflective color or to replace the sensor with a background suppression, sharp cutoff diffuse or retroreflective sensing mode sensor.

## Mounting the Sensor

**IMPORTANT** Securely close and tighten the screw on the user interface cover. Failure to check for a properly sealed user interface cover may result in a malfunction or property damage.

Securely mount the sensor on a firm, stable surface or support. A mounting which is subject to excessive vibration or shifting may cause intermittent operation. Adaptors and mounting brackets are available for a flexible installation. The sensor is supplied with the hardware kit 129-130 which contains a plastic mounting nut, lock washer, 2 M5 x 0.8 x 53 screws and nuts.

Once securely mounted, the sensor may be wired as indicated in the wiring diagrams.

## Wiring Diagrams

Quick-disconnect connection is shown in the following diagrams. Pin numbers correspond to male connectors on the sensor.

### All Models Except Transmitted Beam Source

Cable Model: 9\_LO

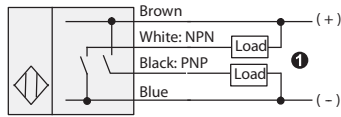

4-pin DC Micro QD Model: 9\_LO-QD

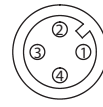

4-pin DC Mini QD Model: 9\_LO-QD1

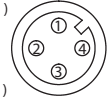

❶ Load can be on either black or white wire to create sourcing or sinking respectively.

Cable Model: 9\_L2

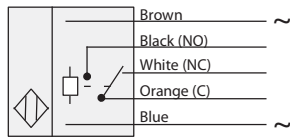

5-pin AC Mini QD Model: 9\_L2-QD

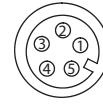
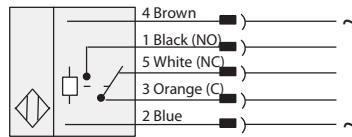

### Transmitted Beam Source

Cable Model: 42GRL-90\_

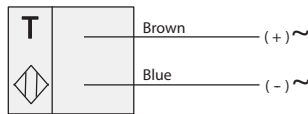

AC/DC Mini QD Model: 42GRL-90\_2-QD

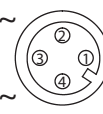

DC Micro QD Model: 42GRL-90\_0-QD

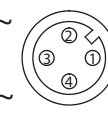
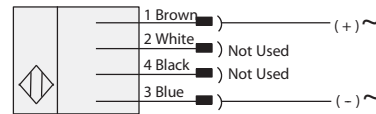

## Dimensions [mm (in.)]

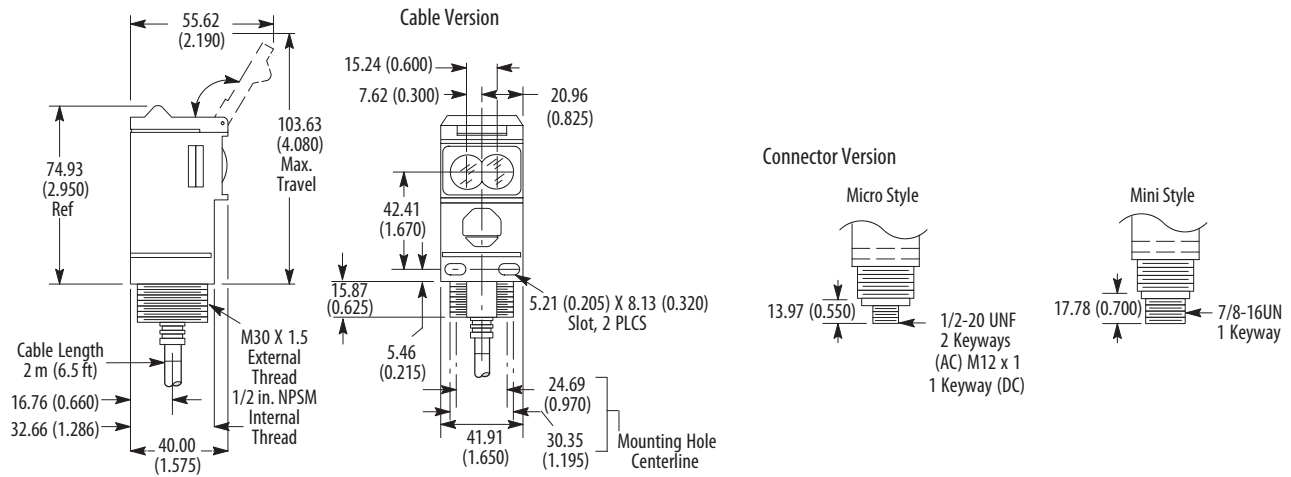

## Accessories [mm (in.)]

### Swivel/Tilt Mounting Assembly

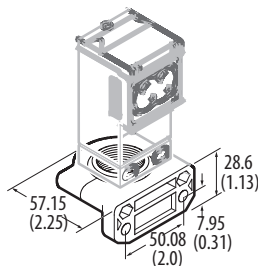

### Hardware Kit (30 mm) 129-130 (supplied with sensor)

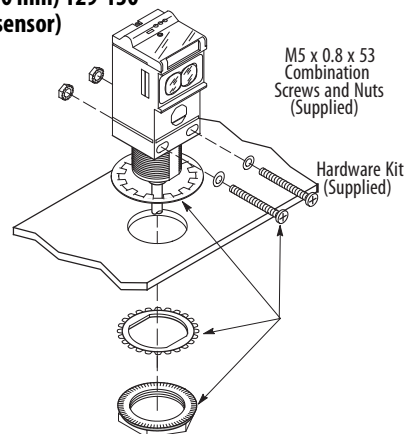

# Typical Response Curves

Standard Diffuse (800 mm)

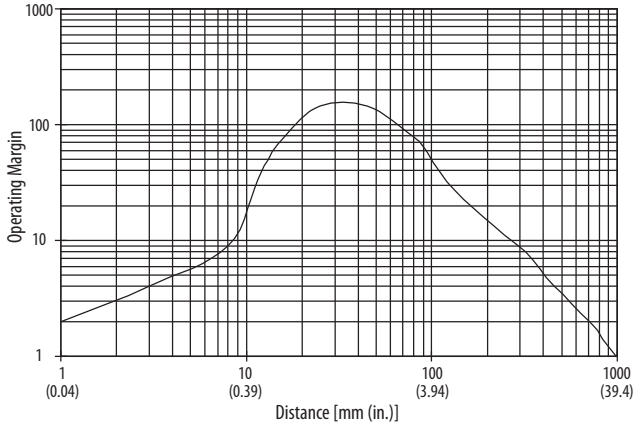

Beam Patter — Standard Diffuse (800 mm)

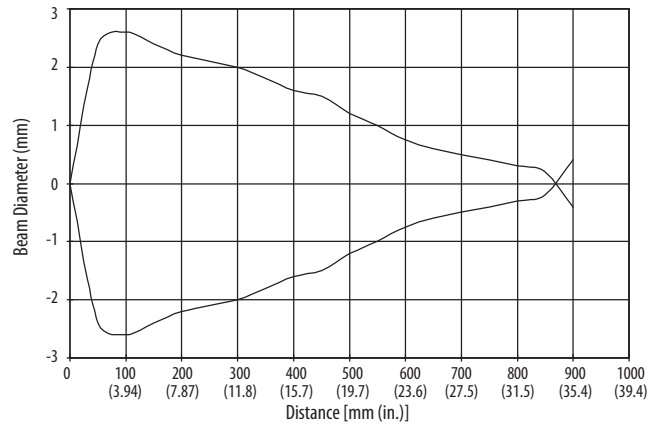

Polarized Retroreflective (40 m)

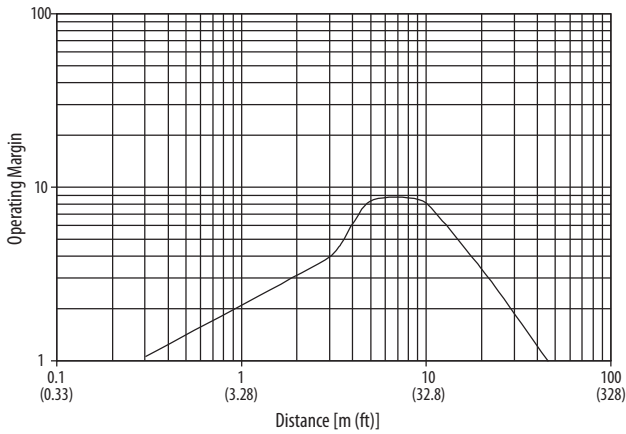

Beam Pattern — Polarized Retroreflective (40 m)

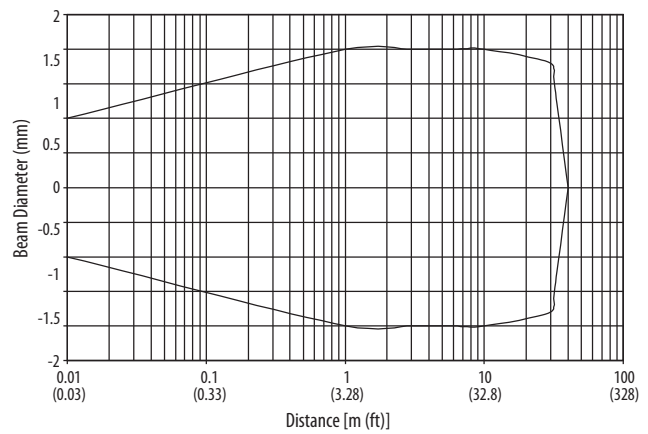

Transmitted Beam (300 m)

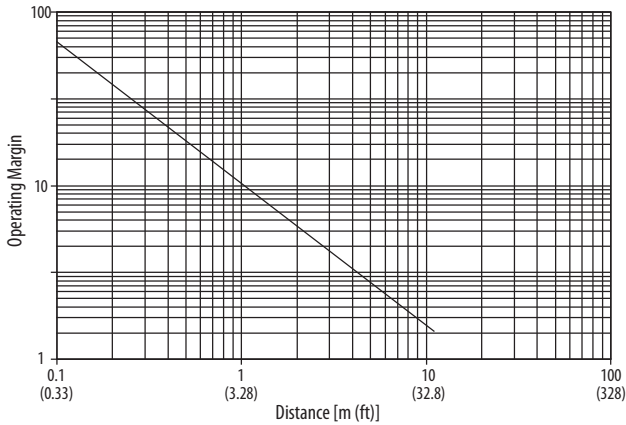

Beam Pattern — Transmitted Beam (300 m)

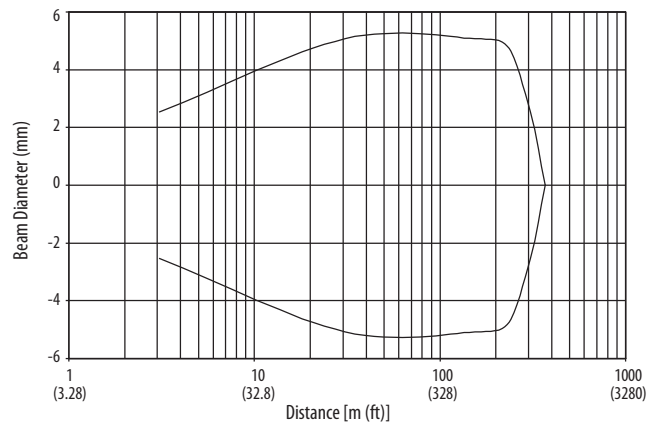

At the end of life, this equipment should be collected separately from any unsorted municipal waste.

Rockwell Automation maintains current product environmental information on its website at

<http://www.rockwellautomation.com/rockwellautomation/about-us/sustainability-ethics/product-environmental-compliance.page>.

Allan-Bradley, LaserSight, Rockwell Automation, and Rockwell Software are trademarks of Rockwell Automation, Inc. Trademarks not belonging to Rockwell Automation are property of their respective companies.

Rockwell Otomasyon Ticaret A.Ş., Kar Plaza İş Merkezi E Blok Kat:6 34752 İçerenköy, İstanbul, Tel: +90 (216) 5698400

[www.rockwellautomation.com](http://www.rockwellautomation.com)

## Power, Control and Information Solutions Headquarters

Americas: Rockwell Automation, 1201 South Second Street, Milwaukee, WI 53204-2496 USA, Tel: (1) 414.382.2000, Fax: (1) 414.382.4444

Europe/Middle East/Africa: Rockwell Automation NV, Pegasus Park, De Kleetlaan 12a, 1831 Diegem, Belgium, Tel: (32) 2 663 0600, Fax: (32) 2 663 0640

Asia Pacific: Rockwell Automation, Level 14, Core F, Cyberport 3, 100 Cyberport Road, Hong Kong, Tel: (852) 2887 4788, Fax: (852) 2508 1846

Publication 9000-IN005B-EN-P - July 2010

PN-385816

10000105748 Ver 02

Copyright © 2010 Rockwell Automation, Inc. All rights reserved. Printed in the U.S.A.