

# PowerFlex 700 AC Drives – Frames 0...10

Vector Control Firmware 4.001 and Up



## Important User Information

Read this document and the documents listed in the additional resources section about installation, configuration, and operation of this equipment before you install, configure, operate, or maintain this product. Users are required to familiarize themselves with installation and wiring instructions in addition to requirements of all applicable codes, laws, and standards.

Activities including installation, adjustments, putting into service, use, assembly, disassembly, and maintenance are required to be carried out by suitably trained personnel in accordance with applicable code of practice.

If this equipment is used in a manner not specified by the manufacturer, the protection provided by the equipment can be impaired.

In no event will Rockwell Automation, Inc. be responsible or liable for indirect or consequential damages resulting from the use or application of this equipment.

The examples and diagrams in this manual are included solely for illustrative purposes. Because of the many variables and requirements associated with any particular installation, Rockwell Automation, Inc. cannot assume responsibility or liability for actual use based on the examples and diagrams.

No patent liability is assumed by Rockwell Automation, Inc. with respect to use of information, circuits, equipment, or software described in this manual.

Reproduction of the contents of this manual, in whole or in part, without written permission of Rockwell Automation, Inc., is prohibited.

Throughout this manual, when necessary, we use notes to make you aware of safety considerations.



**WARNING:** Identifies information about practices or circumstances that can cause an explosion in a hazardous environment, which can lead to personal injury or death, property damage, or economic loss.



**ATTENTION:** Identifies information about practices or circumstances that can lead to personal injury or death, property damage, or economic loss. Attentions help you identify a hazard, avoid a hazard, and recognize the consequence.

---

### IMPORTANT

Identifies information that is critical for successful application and understanding of the product.

---

Labels can also be on or inside the equipment to provide specific precautions.



**SHOCK HAZARD:** Labels can be on or inside the equipment, for example, a drive or motor, to alert people that dangerous voltage can be present.



**BURN HAZARD:** Labels can be on or inside the equipment, for example, a drive or motor, to alert people that surfaces can reach dangerous temperatures.



**ARC FLASH HAZARD:** Labels can be on or inside the equipment, for example, a motor control center, to alert people to potential Arc Flash. Arc Flash will cause severe injury or death. Wear proper Personal Protective Equipment (PPE). Follow ALL Regulatory requirements for safe work practices and for Personal Protective Equipment (PPE).

---

The information below summarizes the changes to the PowerFlex 700 User Manual, publication 20B-UM002 since the last release.

### New and Updated Information

### Manual Updates

Description of New or Updated Information	Page
Removed the product certifications and specifications from Appendix A. All certification and specification information is located in the PowerFlex 700 Adjustable Frequency AC Drive Technical Data, publication <a href="#">20B-ID001</a> .	N/A

**Notes:**

<b>Preface</b>	Who Should Use this Manual? . . . . .	9
	What Is Not in this Manual . . . . .	9
	Manual Conventions . . . . .	9
	Additional Resources . . . . .	10
	ATEX Approved Drives & Motors . . . . .	10
	Drive Frame Sizes . . . . .	10
	General Precautions . . . . .	11
	Catalog Number Explanation . . . . .	13
	 <b>Chapter 1</b>	
<b>Programming and Parameters</b>	About Parameters . . . . .	15
	How Parameters are Organized . . . . .	17
	Numbered List View . . . . .	17
	Basic Parameter View . . . . .	18
	Advanced Parameter View . . . . .	19
	Monitor File . . . . .	21
	Motor Control File . . . . .	23
	Speed Command File . . . . .	29
	Dynamic Control File . . . . .	38
	Utility File . . . . .	44
	Communication File . . . . .	55
	Inputs & Outputs File . . . . .	59
	Applications File . . . . .	67
	Pos/Spd Profile File . . . . .	72
	Parameter Cross Reference – by Name . . . . .	77
	Parameter Cross Reference – by Number . . . . .	80
	 <b>Chapter 2</b>	
<b>Troubleshooting</b>	Faults and Alarms . . . . .	83
	Drive Status . . . . .	84
	Front Panel LED Indications . . . . .	84
	Precharge Board LED Indications . . . . .	85
	HIM Indication . . . . .	85
	Manually Clearing Faults . . . . .	85
	Fault Descriptions . . . . .	86
	Clearing Alarms . . . . .	90
	Alarm Descriptions . . . . .	91
	Common Symptoms/Corrective Actions . . . . .	94
	Testpoint C . . . . .	odes and Functions 96
	 <b>Appendix A</b>	
<b>Supplemental Drive Information</b>	Communication Configurations . . . . .	97
	Typical Programmable Controller Configurations . . . . .	97

**HIM Overview**

**Appendix B**

External & Internal Connections ..... 101

Removing/Installing the HIM..... 102

    Disconnecting the HIM..... 103

    Reconnecting the HIM ..... 103

Menu Structure ..... 104

    Diagnostics Menu ..... 105

    Parameter Menu..... 105

    Device Select Menu..... 105

    Memory Storage Menu..... 105

    Start Up Menu ..... 105

    Preferences Menu..... 105

Viewing and Editing Parameters ..... 106

    LCD HIM..... 106

Linking Parameters..... 107

    Establishing A Link ..... 107

**Application Notes**

**Appendix C**

Adjustable Voltage Operation ..... 109

    Enabling Adjustable Voltage..... 110

External Brake Resistor ..... 111

Hand-Off-Auto (HOA) ..... 111

Lifting/Torque Proving..... 111

    TorqProve Manual Start Up..... 113

    Drive Setup ..... 115

    Installation/Wiring..... 116

    Lifting/Torque Proving Application Programming..... 116

Limit Switches for Digital Inputs ..... 118

Minimum Speed ..... 119

Motor Control Technology ..... 120

    Torque Producers ..... 120

    Torque Controllers..... 120

    Speed Regulators ..... 121

Motor DC Injection..... 121

Motor Overload..... 122

Motor Overload Memory Retention Per 2005 NEC..... 123

Overspeed ..... 123

Position Indexer/Speed Profiler ..... 124

    Common Guidelines for all Step Types..... 124

    Position Loop Tuning..... 125

    Profile Command Control Word ..... 125

    Velocity Regulated Step Types and Parameters ..... 126

    Position Regulated Step Types and Parameters ..... 127

    Homing Routine ..... 128

    Example 1: Five Step Velocity Profile (Time-Based and Encoder-Based) ..... 130

    Example 2: Six Step Velocity Profile (Digital Input-Based) ..... 131

Example 3: Five Step Positioner with Incremental Encoder . . . . .	132
Power Loss Ride Through . . . . .	133
Process PID . . . . .	134
PI Enable . . . . .	134
Reverse Speed Limit . . . . .	136
Skip Frequency . . . . .	137
Sleep Wake Mode . . . . .	138
Definitions . . . . .	139
Start At PowerUp . . . . .	140
Stop Mode . . . . .	140
Configuration . . . . .	141
Stop Dwell Time . . . . .	145
Voltage Tolerance . . . . .	146

## Appendix D

<b>Instructions for ATEX Approved Drives in Group II Category (2) G D Applications with ATEX Approved Motors</b>	Motor Requirements . . . . .	148
	Drive Wiring . . . . .	148
	Drive Configuration . . . . .	149
	Hardware . . . . .	149
	Firmware . . . . .	149
	Start-Up & Periodic Drive Testing Requirement . . . . .	150
	Preparation . . . . .	150
	Test . . . . .	151

## Index





The purpose of this manual is to provide you with the basic information needed to program and troubleshoot the PowerFlex 700 Adjustable Frequency AC Drive with Vector Control.

Topic	Page
Who Should Use this Manual?	9
What Is Not in this Manual	9
Manual Conventions	9
Additional Resources	10
ATEX Approved Drives & Motors	10
Drive Frame Sizes	10
General Precautions	11
Catalog Number Explanation	13

**Who Should Use this Manual?** This manual is intended for qualified personnel. You must be able to program and operate Adjustable Frequency AC Drive devices. In addition, you must have an understanding of the parameter settings and functions.

**What Is Not in this Manual** The PowerFlex 700 Series B User Manual provides programming and troubleshooting information for the Vector Control drive, Frames 0...10.

Drive installation and wiring information is not in this manual, but can be found in the Installation Instructions for your drive:

- Frames 0...6 – [publication 20B-IN019](#)
- Frames 7...10 – [publication 20B-IN014](#)

Literature is available online at <http://www.rockwellautomation.com/literature>.

- Manual Conventions**
- In this manual we refer to the PowerFlex 700 Adjustable Frequency AC Drive as; drive, PowerFlex 700 or PowerFlex 700 Drive.
  - To help differentiate parameter names and LCD display text from other text, the following conventions will be used:
    - Parameter Names will appear in [brackets].  
For example: [DC Bus Voltage].
    - Display Text will appear in “quotes.” For example: “Enabled.”
  - The following words are used throughout the manual to describe an action:

Word	Meaning
Can	Possible, able to do something
Cannot	Not possible, not able to do something
May	Permitted, allowed
Must	Unavoidable, you must do this

Word	Meaning
Shall	Required and necessary
Should	Recommended
Should Not	Not recommended

## Additional Resources

These documents contain additional information concerning related products from Rockwell Automation.

Resource	Description
PowerFlex 700 Standard Control User Manual, publication <a href="#">20B-UM001</a>	Provides detailed information on: <ul style="list-style-type: none"> <li>Parameters and programming</li> <li>Faults, alarms, and troubleshooting</li> </ul>
PowerFlex 700 AC Drive Technical Data, publication <a href="#">20B-TD001</a>	This publication provides detailed drive specifications, option specifications and input protection device ratings.
PowerFlex Comm Adapter Manuals, publication <a href="#">20COMM-UM...</a>	These publications provide information on configuring, using, and troubleshooting PowerFlex communication adapters.
PowerFlex 70 and PowerFlex 700 Reference Manual, publication <a href="#">PFLEX-RM001</a>	These publications provide detailed application specific information for programming and configuring the PowerFlex 700 drive.
PowerFlex 70 Enhanced Control and PowerFlex 700 Vector Control Reference Manual, publication <a href="#">PFLEX-RM004</a>	
Wiring and Grounding Guidelines for Pulse Width Modulated (PWM) AC Drives, publication <a href="#">DRIVES-IN001</a>	Provides basic information needed to properly wire and ground PWM AC drives.
Safety Guidelines for the Application, Installation and Maintenance of Solid State Control, publication <a href="#">SGI-1.1</a>	Provides general guidelines for the application, installation, and maintenance of solid-state control.
Guarding Against Electrostatic Damage, publication <a href="#">8000-4.5.2</a>	Provides practices for guarding against Electrostatic damage (ESD)
Product Certifications website, <a href="http://ab.com">http://ab.com</a>	Provides declarations of conformity, certificates, and other certification details.

You can view or download publications at <http://www.rockwellautomation.com/literature/>. To order paper copies of technical documentation, contact your local Allen-Bradley distributor or Rockwell Automation sales representative.

## ATEX Approved Drives & Motors

For detailed information on using ATEX approved drives and motors, refer to [Appendix D](#).

## Drive Frame Sizes

Similar PowerFlex 700 drive sizes are grouped into frame sizes to simplify spare parts ordering, dimensioning, etc. A cross reference of drive catalog numbers and their respective frame size is provided in the [Catalog Number Explanation on page 13](#).

## General Precautions



**ATTENTION:** This drive contains ESD (Electrostatic Discharge) sensitive parts and assemblies. Static control precautions are required when installing, testing, servicing or repairing this assembly. Component damage can result if ESD control procedures are not followed. If you are not familiar with static control procedures, reference A-B publication 8000-4.5.2, "Guarding Against Electrostatic Damage" or any other applicable ESD protection handbook.



**ATTENTION:** An incorrectly applied or installed drive can result in component damage or a reduction in product life. Wiring or application errors, such as, undersizing the motor, incorrect or inadequate AC supply, or excessive ambient temperatures can result in malfunction of the system.



**ATTENTION:** Only qualified personnel familiar with adjustable frequency AC drives and associated machinery should plan or implement the installation, start-up and subsequent maintenance of the system. Failure to comply can result in personal injury and/or equipment damage.



**ATTENTION:** To avoid an electric shock hazard, verify that the voltage on the bus capacitors has discharged before performing any work on the drive. Measure the DC bus voltage at the +DC & -DC terminals of the Power Terminal Block (refer to the Installation Instructions for location). The voltage must be zero.



**ATTENTION:** Risk of injury or equipment damage exists. DPI or SCANport host products must not be directly connected together via 1202 cables. Unpredictable behavior can result if two or more devices are connected in this manner.



**ATTENTION:** An incorrectly applied or installed bypass system can result in component damage or reduction in product life. The most common causes are:

- Wiring AC line to drive output or control terminals.
- Improper bypass or output circuits not approved by Allen-Bradley.
- Output circuits which do not connect directly to the motor.

Contact Allen-Bradley for assistance with application or wiring.



**ATTENTION:** Loss of control in suspended load applications can cause personal injury and/or equipment damage. Loads must always be controlled by the drive or a mechanical brake. Parameters 600-611 are designed for lifting/torque proving applications. It is the responsibility of the engineer and/or end user to configure drive parameters, test any lifting functionality and meet safety requirements in accordance with all applicable codes and standards.



**ATTENTION:** The “adjust freq” portion of the bus regulator function is extremely useful for preventing nuisance overvoltage faults resulting from aggressive decelerations, overhauling loads, and eccentric loads. It forces the output frequency to be greater than commanded frequency while the drive’s bus voltage is increasing towards levels that would otherwise cause a fault. However, it can also cause either of the following two conditions to occur.

- Fast positive changes in input voltage (more than a 10% increase within 6 minutes) can cause uncommanded positive speed changes. However an “OverSpeed Limit” fault (F25) will occur if the speed reaches [Maximum Speed] + [Overspeed Limit], (parameters 82 and 83). If this condition is unacceptable, action should be taken to 1) limit supply voltages within the specification of the drive and, 2) limit fast positive input voltage changes to less than 10%. Without taking such actions, if this operation is unacceptable, the “adjust freq” portion of the bus regulator function must be disabled (see parameters 161 and 162).
- Actual deceleration times can be longer than commanded deceleration times. However, a “Decel Inhibit” fault (F24) is generated if the drive stops decelerating altogether. If this condition is unacceptable, the “adjust freq” portion of the bus regulator must be disabled (see parameters 161 and 162). In addition, installing a properly sized dynamic brake resistor will provide equal or better performance in most cases.

These faults are not instantaneous. Test results have shown that they can take between 2 . . . 12 seconds to occur.

---

# Catalog Number Explanation

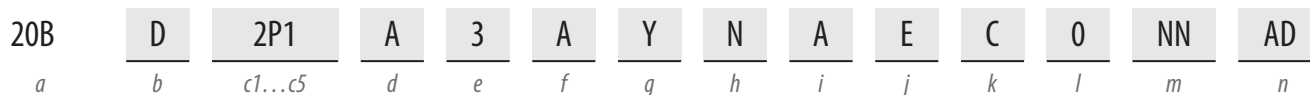

*a*

Drive	
Code	Type
20B	PowerFlex 700

*b*

Voltage Rating				
Code	Voltage	Ph.	Prechg.	Frames
B	240V AC	3	-	0...6
C	400V AC	3	-	0...10
D	480V AC	3	-	0...10
E	600V AC	3	-	0...6
F	690V AC	3	-	5...6
H	540V DC	-	N	5...6, 10
J	650V DC	-	N	5...6, 10
N	325V DC	-	Y	5...6
P	540V DC	-	Y	5...9
R	650V DC	-	Y	5...9
T	810V DC	-	Y	5...6
W	932V DC	-	Y	5...6

*c1*

ND Rating				
208/240V, 60 Hz Input				
Code	208V Amps	240V Amps	Hp	Frame
2P2	2.5	2.2	0.5	0
4P2	4.8	4.2	1.0	0
6P8	7.8	6.8	2.0	1
9P6	11	9.6	3.0	1
015	17.5	15.3	5.0	1
022	25.3	22	7.5	1
028	32.2	28	10	2
042	48.3	42	15	3
052	56	52	20	3
070	78.2	70	25	4
080	92	80	30	4
104	120	104	40	5
130	130	130	50	5
154	177	154	60	6
192	221	192	75	6
260	260	260	100	6

*c2*

ND Rating			
400V, 50 Hz Input			
Code	Amps	kW	Frame
1P3	1.3	0.37	0
2P1	2.1	0.75	0
3P5	3.5	1.5	0
5P0	5.0	2.2	0
8P7	8.7	4.0	0
011	11.5	5.5	0
015	15.4	7.5	1
022	22	11	1
030	30	15	2
037	37	18.5	2
043	43	22	3
056	56	30	3
072	72	37	3
085	85	45	4
105	105	55	5
125	125	55	5
140	140	75	5
170	170	90	6
205	205	110	6
260	260	132	6
292	292	160	7
325	325	180	7
365	365	200	8
415	415	240	8
481	481	280	8
535	535	300	8
600	600	350	8
730	730	400	9
875	875	500	10

*c3*

ND Rating			
480V, 60 Hz Input			
Code	Amps	Hp	Frame
1P1	1.1	0.5	0
2P1	2.1	1.0	0
3P4	3.4	2.0	0
5P0	5.0	3.0	0
8P0	8.0	5.0	0
011	11	7.5	0
014	14	10	1
022	22	15	1
027	27	20	2
034	34	25	2
040	40	30	3
052	52	40	3
065	65	50	3
077	77	60	4
096	96	75	5
125	125	100	5
156	156	125	6
180	180	150	6
248	248	200	6
292	292	250	7
325	325	250	7
365	365	300	8
415	415	350	8
481	481	400	8
535	535	450	8
600	600	500	8
730	730	600	9
875	875	700	10

*c4*

ND Rating			
600V, 60 Hz Input			
Code	Amps	Hp	Frame
1P7	1.7	1.0	0
2P7	2.7	2.0	0
3P9	3.9	3.0	0
6P1	6.1	5.0	0
9P0	9.0	7.5	0
011	11	10	1
017	17	15	1
022	22	20	2
027	27	25	2
032	32	30	3
041	41	40	3
052	52	50	3
062	62	60	4
077	77	75	5
099	99	100	5
125	125	125	6
144	144	150	6

20B

D

2P1

A

3

A

Y

N

A

E

C

O

NN

AD

a

b

c1...c5

d

e

f

g

h

i

j

k

l

m

n

c5

ND Rating			
690V, 50 Hz Input			
Code	Amps	kW	Frame
052	52	45	5
060	60	55	5
082	82	75	5
098	98	90	6
119	119	110	6
142	142	132	6

d

Enclosure	
Code	Enclosure
A	IP20, NEMA/UL Type 1
F ♣	Open/Flange Mount Front: IP00, NEMA/UL Type Open Back/Heatsink: IP54, NEMA Type 12
N ♣	Open/Flange Mount Front: IP00, NEMA/UL Type Open Back/Heatsink: IP54, NEMA 12
G ♣	Stand-Alone/Wall Mount IP54, NEMA/UL Type 12
U	Roll-In Front: IP00, NEMA/UL Type Open Back/Heatsink: IP54, NEMA 12 Frames 8 & 9 Only

♣ Only available for Frame 5 & Frame 6 drives, 400...690V.

♣ Only available for Frames 7...10.

e

HIM	
Code	Operator Interface
0	Blank Cover
3	LCD Display, Full Numeric Keypad
J ♣	Remote (Panel Mount), IP66, NEMA/UL Type 12 Full Numeric LCD HIM
K ♣	Remote (Panel Mount), IP66, NEMA/UL Type 12 Prog. Only LCD HIM

♣ Available with Frames 5...6 Stand-Alone IP54 drives (Enclosure Code "G").

f

Documentation	
Code	Type
A	Manual
N	No Manual
Q	No Shipping Package (Internal Use Only)

g

Brake	
Code	w/Brake IGBT ‡
Y	Yes
N	No

‡ Brake IGBT is standard on Frames 0-3, optional on Frames 4-6 and not available on Frames 7...10.

h

Internal Braking Resistor	
Code	w/Resistor
Y	Yes *
N	No

\* Not available for Frame 3 drives or larger.

i

Emission		
Code	CE Filter §	CM Choke
A	Yes	Yes
B #	Yes	No
N	No	No

§ Note: 600V class drives below 77 Amps (Frames 0-4) are declared to meet the Low Voltage Directive. It is the responsibility of the user to determine compliance to the EMC directive. Frames 7...10, 400/480V AC drives (Voltage Rating codes "C" and "D") meet CE certification requirements when installed per recommendations.

# Only available for 208...240V Frame 0-3 drives.

j

Comm Slot	
Code	Network Type
C	ControlNet (Coax)
D	DeviceNet
E	EtherNet/IP
N	None

k

Control & I/O		
Code	Control	I/O Volts
A	Standard ♦	24V DC/AC
B	Standard ♦	115V AC
C	Vector Δ	24V DC
D	Vector Δ	115V AC
N	Standard	None

Δ Vector Control Option utilizes DPI Only.

♦ Frame 0...6 drives only.

l

Feedback	
Code	Type
0	None
1	Encoder, 12V/5V

m

Future Use

n

Special Firmware (Frames 0...6 Only)	
Code	Type
AD ♦	60 Hz Maximum
AE ♦	Cascading Fan/Pump Control
AX ♦	82 Hz Maximum
BA ♦	Pump Off (for pump jack)

♦ Must be used with Vector Control option C or D (Position k). Positions m-n are only required when custom firmware is supplied.

## Programming and Parameters

This chapter provides a complete listing and description of the PowerFlex 700 parameters. The parameters can be programmed (viewed/edited) using an LCD HIM (Human Interface Module). As an alternative, programming can also be performed using DriveExplorer™ or DriveExecutive™ software and a personal computer. See [Appendix B](#) for a brief description of the LCD HIM.

Topic	Page	Topic	Page
About Parameters	15	Communication File	55
How Parameters are Organized	17	Inputs & Outputs File	59
Monitor File	21	Applications File	67
Motor Control File	23	Pos/Spd Profile File	72
Speed Command File	29	Parameter Cross Reference – by Name	77
Dynamic Control File	38	Parameter Cross Reference – by Number	80
Utility File	44		

### About Parameters

To configure a drive to operate in a specific way, drive parameters may have to be set. Three types of parameters exist:

- **ENUM Parameters**  
ENUM parameters allow a selection from 2 or more items. The LCD HIM will display a text message for each item.
- **Bit Parameters**  
Bit parameters have individual bits associated with features or conditions. If the bit is 0, the feature is off or the condition is false. If the bit is 1, the feature is on or the condition is true.
- **Numeric Parameters**  
These parameters have a single numerical value (that is, 0.1 Volts).

The example on the following page shows how each parameter type is presented in this manual.

1	2	3	4	5	6	7	8
File	Group	No.	Parameter Name & Description	Values			Related
UTILITY	Drive ...	198 	<b>[Load Frm Usr Set]</b> Loads a previously saved set of parameter values from a selected user set location in drive nonvolatile memory to active drive memory.	Default: 0	"Ready"		<a href="#">199</a> 
				Options: 0	"Ready"		
				1	"User Set 1"		
				2	"User Set 2"		
				3	"User Set 3"		
	Diagnostics	216	<b>[Dig In Status]</b> Status of the digital inputs.  Bit #	Read Only			<a href="#">361</a> ... <a href="#">366</a>
MOTOR...	Torque ...	434 	<b>[Torque Ref B Mult]</b> Defines the value of the multiplier for the [Torque Ref B Sel] selection.	Default: 1.0			<a href="#">053</a>
				Min/Max: -/+32767.0			
				Units: 0.1			

No.	Description											
1	<b>File</b> – Lists the major parameter file category.											
2	<b>Group</b> – Lists the parameter group within a file.											
3	<p><b>No.</b> – Parameter number. Note that all parameters in the PowerFlex 700VC are 32 bit.</p> <p> = Parameter value cannot be changed until drive is stopped.</p> <p> = Parameter only displayed when [Motor Cntl Sel] is set to "4."</p> <p> = This parameter only available with firmware version 6.002 and later.</p>											
4	<b>Parameter Name &amp; Description</b> – Parameter name as it appears on an LCD HIM, with a brief description of the parameter's function.											
5	<p><b>Values</b> – Defines the various operating characteristics of the parameter. Three types exist.</p> <table border="1"> <tr> <td>ENUM</td> <td>Default: Options:</td> <td>Lists the value assigned at the factory. "Read Only" = no default. Displays the programming selections available.</td> </tr> <tr> <td>Bit</td> <td>Bit:</td> <td>Lists the bit place holder and definition for each bit.</td> </tr> <tr> <td rowspan="2">Numeric</td> <td>Default: Min/Max: Units:</td> <td>Lists the value assigned at the factory. "Read Only" = no default. The range (lowest and highest setting) possible for the parameter. Unit of measure and resolution as shown on the LCD HIM.</td> </tr> <tr> <td colspan="2"> <p><b>Important:</b> Some parameters will have two unit values:</p> <ul style="list-style-type: none"> <li>Analog inputs can be set for current or voltage with [Anlg In Config], param. 320.</li> <li>Setting [Speed Units], parameter 79 selects Hz or RPM.</li> </ul> <p><b>Important:</b> When sending values through DPI ports, simply remove the decimal point to arrive at the correct value (i.e. to send "5.00 Hz," use "500").</p> </td> </tr> </table>	ENUM	Default: Options:	Lists the value assigned at the factory. "Read Only" = no default. Displays the programming selections available.	Bit	Bit:	Lists the bit place holder and definition for each bit.	Numeric	Default: Min/Max: Units:	Lists the value assigned at the factory. "Read Only" = no default. The range (lowest and highest setting) possible for the parameter. Unit of measure and resolution as shown on the LCD HIM.	<p><b>Important:</b> Some parameters will have two unit values:</p> <ul style="list-style-type: none"> <li>Analog inputs can be set for current or voltage with [Anlg In Config], param. 320.</li> <li>Setting [Speed Units], parameter 79 selects Hz or RPM.</li> </ul> <p><b>Important:</b> When sending values through DPI ports, simply remove the decimal point to arrive at the correct value (i.e. to send "5.00 Hz," use "500").</p>	
ENUM	Default: Options:	Lists the value assigned at the factory. "Read Only" = no default. Displays the programming selections available.										
Bit	Bit:	Lists the bit place holder and definition for each bit.										
Numeric	Default: Min/Max: Units:	Lists the value assigned at the factory. "Read Only" = no default. The range (lowest and highest setting) possible for the parameter. Unit of measure and resolution as shown on the LCD HIM.										
	<p><b>Important:</b> Some parameters will have two unit values:</p> <ul style="list-style-type: none"> <li>Analog inputs can be set for current or voltage with [Anlg In Config], param. 320.</li> <li>Setting [Speed Units], parameter 79 selects Hz or RPM.</li> </ul> <p><b>Important:</b> When sending values through DPI ports, simply remove the decimal point to arrive at the correct value (i.e. to send "5.00 Hz," use "500").</p>											
6	<b>Related</b> – Lists parameters (if any) that interact with the selected parameter. The symbol "" indicates that additional parameter information is available in Appendix C.											



## How Parameters are Organized

The LCD HIM displays parameters in a File-Group-Parameter or Numbered List view order. To switch display mode, access the Main Menu, press ALT, then Sel while cursor is on the parameter selection. In addition, using [\[Param Access Lvl\]](#), the user has the option to display the full parameter set (Advanced), commonly used parameters (Basic) or diagnostic/advanced tuning parameters (Reserved).

To simplify programming, the displayed parameters will change according to the selection made with [\[Motor Cntl Sel\]](#). For example, if “FVC Vector” is selected, the parameters associated solely with other operations such as Volts per Hertz or Sensorless Vector will be hidden. Refer to pages [18](#) and [19](#).

### *File-Group-Parameter Order*







This simplifies programming by grouping parameters that are used for similar functions. The parameters are organized into files. Each file is divided into groups, and each parameter is an element in a group. By default, the LCD HIM displays parameters by File-Group-Parameter view.

## Numbered List View

All parameters are in numerical order.

## Basic Parameter View

Parameter 196 [Param Access Lvl] set to option 0 “Basic.”

File	Group	Parameters							
	<b>Monitor</b>	<b>Metering</b>	Output Freq	001					
			Commanded Speed	002					
			Commanded Torque**	024					
			Output Current	003					
			Torque Current	004					
			DC Bus Voltage	012					
	<b>Motor Control</b>	Motor Data	Motor NP Volts	041	Motor NP RPM	044	Motor OL Hertz	047	
			Motor NP FLA	042	Motor NP Power	045	Motor Poles	049	
			Motor NP Hertz	043	Mtr NP Pwr Units	046			
		Torq Attributes	Motor Cntl Sel	053	Autotune Torque**	066	Torque Ref A Lo**	429	
			Maximum Voltage	054	Inertia Autotune**	067	Pos Torque Limit**	436	
			Maximum Freq	055	Torque Ref A Sel**	427	Neg Torque Limit**	437	
	Autotune		061	Torque Ref A Hi**	428				
	Speed Feedback	Motor Fdbk Type	412	Encoder PPR	413				
		<b>Speed Command</b>	Spd Mode & Limits	Speed Units	079	Minimum Speed	081	Rev Speed Limit**	454
				Feedback Select	080	Maximum Speed	082		
		Speed References	Speed Ref A Sel	090	Speed Ref B Hi	094	TB Man Ref Lo	098	
			Speed Ref A Hi	091	Speed Ref B Lo	095	Pulse Input Ref	099	
Speed Ref A Lo			092	TB Man Ref Sel	096				
Speed Ref B Sel			093	TB Man Ref Hi	097				
Discrete Speeds		Jog Speed 1	100	Jog Speed 2	108				
		Preset Speed 1-7	101-107						
		<b>Dynamic Control</b>	Ramp Rates	Accel Time 1	140	Decel Time 1	142	S-Curve %	146
	Accel Time 2			141	Decel Time 2	143			
	Load Limits	Current Lmt Sel	147	Current Lmt Val	148				
	Stop/Brake Modes	Stop/Brk Mode A	155	DC Brk Lvl Sel	157	Bus Reg Mode A	161		
		Stop/Brk Mode B	156	DC Brake Level	158	Bus Reg Mode B	162		
				DC Brake Time	159	DB Resistor Type	163		
	Restart Modes	Start At PowerUp	168	Auto Rstrt Tries	174	Auto Rstrt Delay	175		
	Power Loss	Power Loss Mode	184	Power Loss Time	185	Power Loss Level	186		
		<b>Utility</b>	Direction Config	Direction Mode	190				
			Drive Memory	Param Access Lvl	196	Load Frm Usr Set	198	Language	201
Reset To Defaults				197	Save To User Set	199			
Diagnostics			Start Inhibits	214	Dig In Status	216	Dig Out Status	217	
Faults			Fault Config 1	238					
Alarms			Alarm Config 1	259					
	<b>Inputs &amp; Outputs</b>	Analog Inputs	Anlg In Config	320	Analog In2 Hi	325			
			Analog In1 Hi	322	Analog In2 Lo	326			
			Analog In1 Lo	323					
		Analog Outputs	Analog Out1, 2 Sel	342	Analog Out1, 2 Lo	344	Analog Out2 Hi	346	
			Analog Out1 Hi	343	Analog Out1, 2 Sel	345	Analog Out1, 2 Lo	347	
		Digital Inputs	Digital In1-6 Sel	361-366					
		Digital Outputs	Digital Out1-3 Sel	380-388	Dig Out1-3 Level	381-389			





\*These parameters will only be displayed when parameter 053 [Motor Cntl Sel] is set to option “2 or 3.”

\*\*These parameters will only be displayed when parameter 053 [Motor Cntl Sel] is set to option “4.”





<sup>6</sup>Firmware version 6.002 and later.

## Advanced Parameter View

Parameter 196 [Param Access Lvl] set to option 1 “Advanced.”

File	Group	Parameters							
	Metering	Output Freq	001	Flux Current	005	DC Bus Memory	013		
		Commanded Speed	002	Output Voltage	006	Analog In1 Value	016		
	Drive Data	Ramped Speed	022	Output Power	007	Analog In2 Value	017		
		Speed Reference	023	Output Powr Fctr	008	Elapsed kWh	014		
		Commanded Torque**	024	Elapsed MWh	009	PTC HW Value	018		
		Speed Feedback	025	Elapsed Run Time	010	Spd Fdbk No Flit	021		
		Output Current	003	MOP Reference	011				
		Torque Current	004	DC Bus Voltage	012				
		Rated kW	026	Rated Amps	028				
		Rated Volts	027	Control SW Ver	029				
			Motor Data	Motor Type	040	Motor NP RPM	044	Motor OL Factor	048
				Motor NP Volts	041	Motor NP Power	045	Motor OL Mode <sup>6,x</sup>	050
	Motor NP FLA			042	Mtr NP Pwr Units	046	Motor Poles	049	
	Motor NP Hertz			043	Motor OL Hertz	047			
Torq Attributes	Motor Cntl Sel		053	Flux Current Ref	063	Torque Ref B Hi**	432		
	Maximum Voltage		054	IXo Voltage Drop	064	Torque Ref B Lo**	433		
	Autotune Torque**		055	Autotune Torque**	066	Torque Ref B Mult**	434		
	Compensation		056	Inertia Autotune**	067	Torque Setpoint 1**	435		
	Flux Up Mode		057	Torque Ref A Sel**	427	Torque Setpoint 2**	438		
	Flux Up Time		058	Torque Ref A Hi**	428	Pos Torque Limit**	436		
	SV Boost Filter		059	Torque Ref A Lo**	429	Neg Torque Limit**	437		
	Autotune		061	Torq Ref A Div**	430	Control Status**	440		
	IR Voltage Drop		062	Torque Ref B Sel**	431	Mtr Tor Cur Ref**	441		
Volts per Hertz	Start/Acc Boost		069	Break Voltage*	071				
	Run Boost*		070	Break Frequency*	072				
Speed Feedback	Motor Fdbk Type		412	Fdbk Filter Sel	416	Marker Pulse	421		
	Encoder PPR		413	Notch Filter Freq**	419	Pulse In Scale	422		
	Enc Position Fdbk		414	Notch Filter K**	420	Encoder Z Chan	423		
	Encoder Speed		415						
	Spd Mode & Limits		Speed Units	079	Overspeed Limit	083	Skip Freq Band*	087	
			Feedback Select	080	Skip Frequency 1*	084	Speed/Torque Mod**	088	
			Minimum Speed	081	Skip Frequency 2*	085	Rev Speed Limit**	454	
			Maximum Speed	082	Skip Frequency 3*	086			
	Speed References		Speed Ref A Sel	090	Speed Ref B Hi	094	TB Man Ref Hi	097	
			Speed Ref A Hi	091	Speed Ref B Lo	095	TB Man Ref Lo	098	
			Speed Ref A Lo	092	TB Man Ref Sel	096	Pulse Input Ref	099	
		Speed Ref B Sel	093						
	Discrete Speeds	Jog Speed 1	100	Preset Speed 1-7	101-107	Jog Speed 2	108		
	Speed Trim	Trim In Select	117	Trim Hi	119	Trim % Setpoint	116		
		Trim Out Select	118	Trim Lo	120				
	Slip Comp	Slip RPM @ FLA	121	Slip Comp Gain*	122	Slip RPM Meter	123		
	Process PI	PI Configuration	124	PI Upper Limit	132	PI Reference Lo	461		
		PI Control	125	PI Preload	133	PI Feedback Hi	462		
		PI Reference Sel	126	PI Status	134	PI Feedback Lo	463		
		PI Setpoint	127	PI Ref Meter	135	PI BW Filter	139		
		PI Feedback Sel	128	PI Fdbk Meter	136	PI Deriv Time	459		
		PI Integral Time	129	PI Error Meter	137	PI Output Gain	464		
		PI Prop Gain	130	PI Output Meter	138				
PI Lower Limit		131	PI Reference Hi	460					
Speed Regulator	Ki Speed Loop**	445	Spd Err Filt BW <sup>6,x</sup>	448	Speed Loop Meter**	451			
	Kp Speed Loop**	446	Speed Desired BW**	449					
	Kf Speed Loop**	447	Total Inertia**	450					
	Ramp Rates	Accel Time 1, 2	140,141	Decel Time 1, 2	142,143	S Curve %	146		
	Load Limits	Current Lmt Sel	147	Drive OL Mode	150	Regen Power Limit**	153		
		Current Lmt Val	148	PWM Frequency	151	Current Rate Limit**	154		
		Current Lmt Gain	149	Droop RPM @ FLA	152				
	Stop/Brake Modes	DB While Stopped	145	DC Brake Time	159	Bus Reg Kp*	164		
		Stop Mode	155,156	Bus Reg Ki*	160	Bus Reg Kd*	165		
		DC Brk Lvl Sel	157	Bus Reg Mode	161,162	Flux Braking	166		
		DC Brake Level	158	DB Resistor Type	163	Stop Dwell Time	452		
	Restart Modes	Start At PowerUp	168	Auto Rstrt Delay	175	Wake Time	181		
		Flying Start En	169	Sleep-Wake Mode	178	Sleep Level	182		
		Flying StartGain	170	Sleep-Wake Ref	179	Sleep Time	183		
		Auto Rstrt Tries	174	Wake Level	180	Powerup Delay	167		
	Power Loss	Power Loss Mode	184	Load Loss Level	187	Gnd Warn Level	177		
		Power Loss Time	185	Load Loss Time	188				
		Power Loss Level	186	Sheaf Pin Time	189				

continued on [page 20](#)

File	Group	Parameters						
	Direction Config	Direction Mode	190					
	HIM Ref Config	DPI Loss Action	173					
	MOP Config	Save MOP Ref	194	MOP Rate				
		MOP Rate	195					
	Drive Memory	Param Access Lvl	196	Reset Meters				
		Reset To Defaults	197	Language				
		Load Frm Usr Set	198	Voltage Class				
		Save To User Set	199	Drive Checksum				
		Drive Checksum	203					
	Diagnostics	Drive Status 1, 2	209,210	Dig Out Status				
		Drive Status 3 <sup>6,x</sup>	222	Drive Temp				
		Drive Alarm 1, 2	211,212	Drive OL Count				
		Speed Ref Source	213	Motor OL Count				
		Start Inhibits	214	Fault Speed				
		Last Stop Source	215	Fault Amps				
		Dig In Status	216	Fault Bus Volts				
		Status 1,2 @ Fault	227,228	Status 3 @ Fault <sup>6,x</sup>				
		Alarm 1,2 @ Fault	229,230	Testpoint 1,2 Sel				
		Testpoint 1,2 Data	234,236	Testpoint 1,2 Data				
	Mtr OL Trip Time	225,237						
Faults	Fault Config 1	238	Fault Clear Mode					
Fault Clear	240	Power Up Marker	242					
Alarms	Alarm Config 1	259	Alarm Clear					
Scaled Blocks	Scale1, 2 In Val	476,482	Scale1,2 Out Lo					
	Scale1, 2 In Hi	477,483	Scale1,2 Out Val					
	Scale1, 2 In Lo	478,484	Scale3, 4 In Lo					
	Scale1, 2 Out Hi	479,485	Scale3, 4 Out Hi					
	Scale3, 4 In Val	488,494	Scale3, 4 Out Lo					
Scale3, 4 In Hi	489,495	Scale3, 4 Out Val	493,499					
	Comm Control	DPI Baud Rate	270	Drive Ramp Rslt	273	DPI Ref Select	298	
		Drive Logic Rslt	271	DPI Port Sel	274	DPI Fdbk Select	299	
		Drive Ref Rslt	272	DPI Port Value	275			
	Masks & Owners	Logic Mask	276	Fault Clr Mask	283	Reference Owner	292	
		Start Mask	277	MOP Mask	284	Accel Owner	293	
		Jog Mask	278	Local Mask	285	Decel Owner	294	
		Direction Mask	279	Stop Owner	288	Fault Clr Owner	295	
		Reference Mask	280	Start Owner	289	MOP Owner	296	
		Accel Mask	281	Jog Owner	290	Local Owner	297	
		Decel Mask	282	Direction Owner	291			
	Datalinks	Data In A1-D2	300-307	Data Out A1-D2	310-317	HighRes Ref <sup>6,x</sup>	308	
	Security	Port Mask Act	595	Write Mask Act	597	Logic Mask Act	598	
		Write Mask Cfg	596	Logic Mask	276			
		Analog Inputs	Anlg In Config	320	Analog In1, 2 Hi	322,325	Analog In1, 2 Loss	324,327
			Anlg In Sqr Root	321	Analog In1, 2 Lo	323,326		
Analog Outputs		Anlg Out Config	340	Analog Out1, 2 Hi	343,346	Anlg Out1,2 Scale	354,355	
		Anlg Out Absolut	341	Analog Out1, 2 Lo	344,347	Anlg1 Out Setpt	377,378	
		Analog Out1, 2 Sel	342,345					
Digital Inputs		Digital In1-6 Sel	361-366	DigIn DataLogic <sup>6,x</sup>	411			
Digital Outputs		Digital Out Sel	380,384,388	Dig Out OffTime	383,387,391	Dig Out Param	393	
		Dig Out Level	381,385,389	Dig Out Setpt	379	Dig Out Mask	394	
		Dig Out OnTime	382,386,390	Dig Out Invert	392			
		Torq Proving	TorqProve Cnfg	600	ZeroSpdFloatTime	605	Brk Alarm Travel	610
	TorqProve Setup		601	Float Tolerance	606	MicroPos Scale%	611	
	Spd Dev Band		602	Brk Set Time	607	Torq Prove Sts	612	
	SpdBand Integrat		603	TorqLim SlewRate	608	Brake Test Torq <sup>6,x</sup>	613	
	Brk Release Time		604	BrkSlip Count	609			
	Adjust Voltage	Adj Volt Phase	650	Min Adj Voltage	661	Adj Volt Trim Lo	671	
		Adj Volt Select	651	Adj Volt Command	662	Adj Volt Trim %	672	
		Adj Volt Ref Hi	652	MOP Adj VoltRate	663	Adj Volt AccTime	675	
		Adj Volt Ref Lo	653	Adj Volt TrimSel	669	Adj Volt DecTime	676	
		Adj Volt Preset1-7	654-660	Adj Volt Trim Hi	670	Adj Volt S Curve	677	
	Oil Well Pump	Max Rod Torque	631	PCP Pump Sheave	637	Gearbox Sheave	643	
		TorqAlarm Level	632	PCP Rod Torque	638	Gearbox Ratio	644	
		TorqAlarm Action	633	Min Rod Speed	639	Motor Sheave	645	
		TorqAlarm Dwell	634	Max Rod Speed	640	Total Gear Ratio	646	
		TorqAlrm Timeout	635	OilWell Pump Sel	641	DB Resistor	647	
		TorqAlrm TO Act	636	Gearbox Rating	642	Gearbox Limit	648	
		ProfSetup/Status	Pos/Spd Prof Sts	700	Encoder Pos Tol	707	Find Home Ramp	714
			Units Traveled	701	Counts Per Unit	708	Pos Reg Filter	718
Home Position <sup>6,x</sup>			702	Vel Override	711	Pos Reg Gain	719	
Pos/Spd Prof Cmd			705	Find Home Speed	713			
Profile Step 1-16		Step x Type	720...	Step x DecelTime	723...	Step x Batch	726...	
		Step x Velocity	721...	Step x Value	724...	Step x Next	727...	
		Step x AccelTime	722...	Step x Dwell	725...			

\*These parameters will only be displayed when parameter 053 [Motor Cntl Sel] is set to option "2 or 3."

\*\*These parameters will only be displayed when parameter 053 [Motor Cntl Sel] is set to option "4."

<sup>6,x</sup>Firmware version 6.002 and later.

# Monitor File

File	Group	No.	Parameter Name & Description See <a href="#">page 16</a> for symbol descriptions	Values	Related
MONITOR	Metering	001	<b>[Output Freq]</b> Output frequency present at T1, T2 & T3 (U, V & W)	Default: Read Only Min/Max: -/+ [Maximum Freq] Units: 0.1 Hz	
		002	<b>[Commanded Speed]</b> Value of the active Speed/Frequency Reference. Displayed in Hz or RPM, depending on value of [Speed Units].	Default: Read Only Min/Max: -/+ [Maximum Speed] Units: 0.1 Hz 0.1 RPM	<a href="#">079</a>
		003	<b>[Output Current]</b> The total output current present at T1, T2 & T3 (U, V & W).	Default: Read Only Min/Max: 0.0/Drive Rated Amps x 2 Units: 0.1 Amps	
		004	<b>[Torque Current]</b> Based on the motor, the amount of current that is in phase with the fundamental voltage component.	Default: Read Only Min/Max: Drive Rating x -2/+2 Units: 0.1 Amps	
		005	<b>[Flux Current]</b> Amount of current that is out of phase with the fundamental voltage component.	Default: Read Only Min/Max: Drive Rating x -2/+2 Units: 0.1 Amps	
		006	<b>[Output Voltage]</b> Output voltage present at terminals T1, T2 & T3 (U, V & W).	Default: Read Only Min/Max: 0.0/Drive Rated Volts Units: 0.1 VAC	
		007	<b>[Output Power]</b> Output power present at T1, T2 & T3 (U, V & W). [Output Power] = SQRT (3) x [Output Voltage] x [Output Current] x [Output Powr Fctr]	Default: Read Only Min/Max: 0.0/Drive Rated kW x 2 Units: 0.1 kW	
		008	<b>[Output Powr Fctr]</b> Output Power Factor = ABS (SIN (Commanded Voltage Vector Angle - Measured Current Vector Angle))	Default: Read Only Min/Max: 0.00/1.00 Units: 0.01	
		009	<b>[Elapsed MWh]</b> Accumulated output energy of the drive.	Default: Read Only Min/Max: 0.0/214748352.0 MWh Units: 0.1 MWh	
		010	<b>[Elapsed Run Time]</b> Accumulated time drive is outputting power.	Default: Read Only Min/Max: 0.0/214748352.0 Hrs Units: 0.1 Hrs	
		011	<b>[MOP Reference]</b> Value of the signal at MOP (Motor Operated Potentiometer).	Default: Read Only Min/Max: -/+ [Maximum Speed] Units: 0.1 Hz 0.1 RPM	<a href="#">079</a>
		012	<b>[DC Bus Voltage]</b> Present DC bus voltage level.	Default: Read Only Min/Max: 0.0/Based on Drive Rating Units: 0.1 VDC	
		013	<b>[DC Bus Memory]</b> 6 minute average of DC bus voltage level.	Default: Read Only Min/Max: 0.0/Based on Drive Rating Units: 0.1 VDC	
		014	<b>[Elapsed kWh]</b> Accumulated output energy of the drive.	Default: Read Only Min/Max: 0.0/429496729.5 kWh Units: 0.1 kWh	
		016 017	<b>[Analog In1 Value]</b> <b>[Analog In2 Value]</b> Value of the signal at the analog inputs.	Default: Read Only Min/Max: 0.000/20.000 mA -/+10.000V Units: 0.001 mA 0.001 Volt	



File	Group	No.	Parameter Name & Description See <a href="#">page 16</a> for symbol descriptions	Values	Related
MONITOR	Metering	018	<b>[PTC HW Value]</b> Value present at the drive's PTC input terminals.	Default: Read Only Min/Max: -/+5.00 Volts Units: 0.01 Volts	
		021	<b>[Spd Fdbk No Filt]</b> Displays the unfiltered value of the actual motor speed, whether measured by encoder feedback or estimated.	Default: Read Only Min/Max: -/+400.0 Hz -/+24000.0 RPM Units: 0.1 Hz 0.1 RPM	
		022	<b>[Ramped Speed]</b> Value of commanded speed after Accel/Decel, and S-Curve are applied.	Default: Read Only Min/Max: -/+400.0 Hz -/+24000.0 RPM Units: 0.1 Hz 0.1 RPM	<a href="#">079</a>
		023	<b>[Speed Reference]</b> Summed value of ramped speed, process PI and droop. When FVC Vector mode is selected, droop will not be added.	Default: Read Only Min/Max: -/+400.0 Hz -/+24000.0 RPM Units: 0.1 Hz 0.1 RPM	<a href="#">079</a>
		024	<b>[Commanded Torque]</b>  Final torque reference value after limits and filtering are applied. Percent of motor rated torque.	Default: Read Only Min/Max: -/+800.0% Units: 0.1%	<a href="#">053</a>
		025	<b>[Speed Feedback]</b> Displays the lightly filtered value of the actual motor speed, whether measured by encoder feedback, or estimated.	Default: Read Only Min/Max: -/+400.0 Hz -/+24000.0 RPM Units: 0.1 Hz 0.1 RPM	
	Drive Data	026	<b>[Rated kW]</b> Drive power rating.	Default: Read Only Min/Max: 0.00/3000.00 kW Units: 0.01 kW	
		027	<b>[Rated Volts]</b> The drive input voltage class (208, 240, 400 etc.).	Default: Read Only Min/Max: 0.0/65535.0 VAC Units: 0.1 VAC	
		028	<b>[Rated Amps]</b> The drive rated output current.	Default: Read Only Min/Max: 0.0/65535.0 Amps Units: 0.1 Amps	
		029	<b>[Control SW Ver]</b> Main Control Board software version.	Default: Read Only Min/Max: 0.000/65535.000 Units: 0.001	<a href="#">196</a>

# Motor Control File

File	Group	No.	Parameter Name & Description See <a href="#">page 16</a> for symbol descriptions	Values	Related
MOTOR CONTROL	Motor Data	040	<b>[Motor Type]</b> Set to match the type of motor connected. <sup>(1)</sup> <b>Important:</b> Selecting option 1 or 2 also requires selection of "Custom V/Hz," option 2 in parameter 53.	Default: 0 "Induction" Options: 0 "Induction" 1 "Synchr Reluc" <sup>(1)</sup> 2 "Synchr PM" <sup>(1)</sup>	<a href="#">053</a>
		041	<b>[Motor NP Volts]</b> Set to the motor nameplate rated volts.	Default: Based on Drive Rating Min/Max: 0.0/[Rated Volts] Units: 0.1 VAC	
		042	<b>[Motor NP FLA]</b> Set to the motor nameplate rated full load amps.	Default: Based on Drive Rating Min/Max: 0.0/[Rated Amps] x 2 Units: 0.1 Amps	<a href="#">047</a> <a href="#">048</a>
		043	<b>[Motor NP Hertz]</b> Set to the motor nameplate rated frequency.	Default: Based on Drive Cat. No. Min/Max: 5.0/400.0 Hz Units: 0.1 Hz	
		044	<b>[Motor NP RPM]</b> Set to the motor nameplate rated RPM.	Default: 1750.0 RPM Min/Max: 60.0/24000.0 RPM Units: 1.0 RPM	
		045	<b>[Motor NP Power]</b> Set to the motor nameplate rated power.	Default: Based on Drive Rating Min/Max: 0.00/1000.00 Units: 0.01 kW/HP See <a href="#">[Mtr NP Pwr Units]</a>	<a href="#">046</a>
		046	<b>[Mtr NP Pwr Units]</b> Selects the motor power units to be used. This parameter is not reset when "Reset to Defaults" is selected. "Convert HP" = converts all power units to Horsepower. "Convert kW" = converts all power units to kilowatts.	Default: Drive Rating Based Options: 0 "Horsepower" 1 "kiloWatts" 2 "Convert HP" 3 "Convert kW"	
		047	<b>[Motor OL Hertz]</b> Selects the output frequency below which the motor operating current is derated. The motor thermal overload will generate a fault at lower levels of current.	Default: Motor NP Hz/3 Min/Max: 0.0/Motor NP Hz Units: 0.1 Hz	<a href="#">042</a> <a href="#">220</a> <b>i</b>
		048	<b>[Motor OL Factor]</b> Sets the operating level for the motor overload. $\text{Motor FLA} \times \frac{\text{OL}}{\text{Factor}} = \text{Operating Level}$	Default: 1.00 Min/Max: 0.20/2.00 Units: 0.01	<a href="#">042</a> <a href="#">220</a> <b>i</b>
		049	<b>[Motor Poles]</b> Defines the number of poles in the motor.	Default: 4 Min/Max: 2/40 Units: 1 Pole	
Torq Attributes	V6	050	<b>[Motor OL Mode]</b> Provides the ability to preserve the [Motor OL Count] value through a power cycle or drive reset.	<p>Bit #</p> <p>Factory Default Bit Values</p> <p><b>Option Descriptions</b></p> <p><b>Pwr Cyc Ret</b> If bit 0 is set to "0" (Disabled) the value of [Motor OL Count], parameter 220 is reset to zero by a drive reset or power cycle. A "1" (Enabled) will maintain the value. A transition from "1" to "0" resets [Motor OL Count] to zero.</p>	

File	Group	No.	Parameter Name & Description See page 16 for symbol descriptions	Values	Related
MOTOR CONTROL Torq Attributes		053	<p><b>[Motor Cntl Sel]</b></p> <p>Sets the method of motor control used in the drive.</p> <p>When “Adj Voltage” is selected, voltage control is independent from frequency control. The voltage and frequency components have independent references and accel/decel rates. Typical applications include non-motor loads or power supplies.</p> <p><b>Important:</b> “FVC Vector” mode requires autotuning of the motor. Being coupled to the load will determine inertia (preferably lightly-loaded). Total Inertia (parameter 450) will have to be estimated if uncoupled for tuning of the speed loop or separately adjust Ki and Kp (parameters 445 &amp; 446).</p>	<p>Default: 0 “Sensrls Vect”</p> <p>Options: 0 “Sensrls Vect” 1 “SV Economize” 2 “Custom V/Hz” 3 “Fan/Pmp V/Hz” 4 “FVC Vector” 5 “Adj Voltage”</p>	<b>i</b>
		054	<p><b>[Maximum Voltage]</b></p> <p>Sets the highest voltage the drive will output. Based on [Voltage Class], parameter 202.</p>	<p>Default: Drive Rated Volts</p> <p>Min/Max: Rated Volts x 0.25/Rated Volts</p> <p>Units: 0.1 VAC</p>	<a href="#">202</a>
		055	<p><b>[Maximum Freq]</b></p> <p>Sets the highest frequency the drive will output. Based on [Voltage Class], parameter 202. Also refer to [Overspeed Limit], parameter 083.</p>	<p>Default: 110.0 or 130.0 Hz</p> <p>Min/Max: 5.0/420.0 Hz</p> <p>Units: 0.1 Hz</p>	<a href="#">083</a> <a href="#">202</a>
		056	<p><b>[Compensation]</b></p> <p>Enables/disables correction options.</p> <div style="text-align: center;"> <p>Legend: 1 = Enabled, 0 = Disabled, x = Reserved</p> </div> <p>Bit #</p> <p>Factory Default Bit Values</p> <p>(1) For current limit (except FVC Vector mode). (2) Firmware 6.002 and later. (3) Firmware 9.001 and later.</p> <p><b>Option Descriptions</b></p> <p><b>Reflect Wave</b> Disables reflected wave overvoltage protection for long cable lengths. (typically enabled).</p> <p><b>Enable Jerk</b> In non-FVC Vector modes, disabling jerk removes a short S-curve at the start of the accel/decel ramp.</p> <p><b>Ixo AutoCalc</b> Not functional – reserved for future enhancements.</p> <p><b>Xsistor Diag</b> “0” disables power transistor power diagnostic tests which run at each start command. “1” enables transistor diagnostic tests.</p> <p><b>Rs Adapt</b> FVC w/Encoder Only - Disabling can improve torque regulation at lower speeds (typically not needed).</p> <p><b>Mtr Lead Rev</b> Reverses the phase rotation of the applied voltage, effectively reversing the motor leads. <b>Note: This bit is reset to “0” when parameters are reset to factory defaults.</b></p> <p><b>PWM Freq Lock</b> Keeps the PWM frequency from decreasing to 2 kHz at low operating frequencies in FVC Vector mode without encoder.</p> <p><b>DigIn DatLog</b> Enable [DigIn DataLogic], parameter 411.</p> <p><b>NoSyncPWM</b> Disables synchronous PWM.</p> <p><b>EncFiltStop</b> In FVC Vector mode only, sets the encoder filter based on parameter 416 - [Fdbk Filter Sel] to detect when the drive is at zero speed during the stop sequence.</p>		



File	Group	No.	Parameter Name & Description See <a href="#">page 16</a> for symbol descriptions	Values	Related
MOTOR CONTROL	Torq Attributes	057	<b>[Flux Up Mode]</b> Auto = Flux is established for a calculated time period based on motor nameplate data. [Flux Up Time] is not used. Manual = Flux is established for [Flux Up Time] before acceleration.	Default: 0 "Manual" Options: 0 "Manual" 1 "Automatic"	<a href="#">053</a> <a href="#">058</a>
		058	<b>[Flux Up Time]</b> Sets the amount of time the drive will use to try and achieve full motor stator flux. When a Start command is issued, DC current at current limit level is used to build stator flux before accelerating.	Default: 0.000 Secs Min/Max: 0.000/5.000 Secs Units: 0.001 Secs	<a href="#">053</a> <a href="#">058</a>
		059	<b>[SV Boost Filter]</b> Sets the amount of filtering used to boost voltage during Sensorless Vector and FVC Vector (encoderless) operation.	Default: 500 Min/Max: 0/32767 Units: 1	
		061	 <b>[Autotune]</b> Provides a manual or automatic method for setting [IR Voltage Drop], [Flux Current Ref] and [Ixo Voltage Drop]. Valid only when parameter 53 is set to "Sensrls Vect," "SV Economize" or "FVC Vector."  "Ready" (0) = Parameter returns to this setting following a "Static Tune" or "Rotate Tune." It also permits manually setting [IR Voltage Drop], [Ixo Voltage Drop] and [Flux Current Ref].  "Static Tune" (1) = A temporary command that initiates a non-rotational motor stator resistance test for the best possible automatic setting of [IR Voltage Drop] in all valid modes and a non-rotational motor leakage inductance test for the best possible automatic setting of [Ixo Voltage Drop] in "FVC Vector" mode. A start command is required following initiation of this setting. The parameter returns to "Ready" (0) following the test, at which time another start transition is required to operate the drive in normal mode. Used when motor cannot be rotated.  "Rotate Tune" (2) = A temporary command that initiates a "Static Tune" followed by a rotational test for the best possible automatic setting of [Flux Current Ref]. In "FVC Vector" mode, with encoder feedback, a test for the best possible automatic setting of [Slip RPM @ FLA] is also run. A start command is required following initiation of this setting. The parameter returns to "Ready" (0) following the test, at which time another start transition is required to operate the drive in normal mode. <b>Important:</b> If using rotate tune for "Sensrls Vect" mode, the motor should be uncoupled from the load or results may not be valid. With "FVC Vector," either a coupled or uncoupled load will produce valid results.   <b>ATTENTION:</b> Rotation of the motor in an undesired direction can occur during this procedure. To guard against possible injury and/or equipment damage, it is recommended that the motor be disconnected from the load before proceeding.  "Calculate" (3) = This setting uses motor nameplate data to automatically set [IR Voltage Drop], [Ixo Voltage Drop], [Flux Current Ref] and [Slip RPM @ FLA].	Default: 3 "Calculate" Options: 0 "Ready" 1 "Static Tune" 2 "Rotate Tune" 3 "Calculate"	<a href="#">053</a> <a href="#">062</a>
		062	<b>[IR Voltage Drop]</b> Value of voltage drop across the resistance of the motor stator at rated motor current. Used only when parameter 53 is set to "Sensrls Vect," "SV Economize" or "FVC Vector."	Default: Based on Drive Rating Min/Max: 0.0/[Motor NP Volts] x 0.25 Units: 0.1 VAC	<a href="#">053</a> <a href="#">061</a>
		063	<b>[Flux Current Ref]</b> Value of amps for full motor flux. Used only when parameter 53 is set to "Sensrls Vect," "SV Economize" or "FVC Vector."	Default: Based on Drive Rating Min/Max: 0.00/[Motor NP FLA] Units: 0.01 Amps	<a href="#">053</a> <a href="#">061</a>

File	Group	No.	Parameter Name & Description See <a href="#">page 16</a> for symbol descriptions	Values	Related
MOTOR CONTROL	Torq Attributes	064	<b>[Ixo Voltage Drop]</b> Value of voltage drop across the leakage inductance of the motor at rated motor current. Used only when parameter 53 is set to "Sensrls Vect," "SV Economize or "FVC Vector."	Default: Based on Drive Rating Min/Max: 0.0/230.0, 480.0, 575 VAC Units: 0.1 VAC	
		066	<b>[Autotune Torque]</b> Specifies motor torque applied to the motor during the flux current and inertia tests performed during an autotune.	Default: 50.0% Min/Max: 0.0/150.0% Units: 0.1%	<a href="#">053</a>
		067	<b>[Inertia Autotune]</b> Provides an automatic method of setting [Total Inertia]. This test is automatically run during Start-Up motor tests. <b>Important:</b> If using rotate tune for "Sensrls Vect" mode, the motor should be uncoupled from the load or results may not be valid. With "FVC Vector," either a coupled or uncoupled load will produce valid result.  "Ready" = Parameter returns to this setting following a completed inertia tune.  "Inertia Tune" = A temporary command that initiates an inertia test of the motor/load combination. The motor will ramp up and down, while the drive measures the amount of inertia.	Default: 0 "Ready" Options: 0 "Ready" 1 "Inertia Tune"	<a href="#">053</a> <a href="#">450</a>
		427 431	<b>[Torque Ref A Sel]</b> <b>[Torque Ref B Sel]</b> Selects the source of the external torque reference to the drive. How this reference is used is dependent upon [Speed/Torque Mod]. (1) See Appendix B for DPI port locations.	Default: 0 "Torque Stpt1" 24 "Disabled" Options: 0 "Torque Stpt1" 1 "Analog In 1" 2 "Analog In 2" 3-17 "Reserved" 18-22 "DPI Port 1-5" <sup>(1)</sup> 23 "Reserved" 24 "Disabled" 25-28 "Scale Block1-4" 29 "Torque Stpt2"	<a href="#">053</a>
		428 432	<b>[Torque Ref A Hi]</b> <b>[Torque Ref B Hi]</b> Scales the upper value of the [Torque Ref x Sel] selection when the source is an analog input.	Default: 100.0% 100.0% Min/Max: -/+800.0% Units: 0.1%	<a href="#">053</a>
		429 433	<b>[Torque Ref A Lo]</b> <b>[Torque Ref B Lo]</b> Scales the lower value of the [Torque Ref x Sel] selection when the source is an analog input.	Default: 0.0% 0.0% Min/Max: -/+800.0% Units: 0.1%	<a href="#">053</a>
		430	<b>[Torq Ref A Div]</b> Defines the value of the divisor for the [Torque Ref A Sel] selection.	Default: 1.0 Min/Max: 0.1/3276.7 Units: 0.1	<a href="#">053</a>
		434	<b>[Torque Ref B Mult]</b> Defines the value of the multiplier for the [Torque Ref B Sel] selection.	Default: 1.0 Min/Max: -/+3276.7 Units: 0.1	<a href="#">053</a>
		435	<b>[Torque Setpoint1]</b> Provides an internal fixed value for Torque Setpoint when [Torque Ref x Sel] is set to "Torque Setpt."	Default: 0.0% Min/Max: -/+800.0% Units: 0.1%	<a href="#">053</a>
		436	<b>[Pos Torque Limit]</b> Defines the torque limit for the positive torque reference value. The reference will not be allowed to exceed this value.	Default: 200.0% Min/Max: 0.0/800.0% Units: 0.1%	<a href="#">053</a>





File	Group	No.	Parameter Name & Description See page 16 for symbol descriptions	Values	Related
MOTOR CONTROL	Torq Attributes	437	<b>[Neg Torque Limit]</b> FV Defines the torque limit for the negative torque reference value. The reference will not be allowed to exceed this value.	Default: -200.0% Min/Max: -800.0/0.0% Units: 0.1%	<a href="#">053</a>
		438	<b>[Torque Setpoint2]</b> FV Provides an internal fixed value for Torque Setpoint when [Torque Ref x Sel] is set to "Torque Setpt 2."	Default: 0.0% Min/Max: -/+800.0% Units: 0.1%	
		440	<b>[Control Status]</b> FV Displays a summary status of any condition that can be limiting either the current or the torque reference.  	Read Only	<a href="#">053</a>
		441	<b>[Mtr Tor Cur Ref]</b> FV Displays the torque current reference value that is present at the output of the current rate limiter (parameter 154).	Default: Read Only Min/Max: -/+32767.0 Amps Units: 0.01 Amps	<a href="#">053</a>
	Volts per Hertz	069	<b>[Start/Acc Boost]</b> Sets the voltage boost level for starting and acceleration when "Custom V/Hz" mode is selected. Refer to parameter 083 [Overspeed Limit].	Default: Based on Drive Rating Min/Max: 0.0/[Motor NP Volts] x 0.25 Units: 0.1 VAC	<a href="#">053</a> <a href="#">070</a>
		070	<b>[Run Boost]</b> Sets the boost level for steady state or deceleration when "Fan/Pmp V/Hz" or "Custom V/Hz" modes are selected. See parameter 083 [Overspeed Limit].	Default: Based on Drive Rating Min/Max: 0.0/[Motor NP Volts] x 0.25 Units: 0.1 VAC	<a href="#">053</a> <a href="#">069</a>
		071	<b>[Break Voltage]</b> Sets the voltage the drive will output at [Break Frequency]. Refer to parameter 083 [Overspeed Limit].	Default: [Motor NP Volts] x 0.25 Min/Max: 0.0/[Motor NP Volts] Units: 0.1 VAC	<a href="#">053</a> <a href="#">072</a>
		072	<b>[Break Frequency]</b> Sets the frequency the drive will output at [Break Voltage]. Refer to parameter 083.	Default: [Motor NP Hz] x 0.25 Min/Max: 0.0/[Maximum Freq] Units: 0.1 Hz	<a href="#">053</a> <a href="#">071</a>
	Speed Feedback	412	<b>[Motor Fdbk Type]</b> Selects the encoder type; single channel or quadrature. Options 1 & 3 detect a loss of encoder signal (when using differential inputs) regardless of the [Feedback Select], param. 080 setting. For FVC Vector mode, use a quadrature encoder only (option 0/1). If a single channel encoder is used (option 2/3) in sensorless vector or V/Hz mode, select "Reverse Dis" (option 2) in param. 190.	Default: 0 "Quadrature" Options: 0 "Quadrature" 1 "Quad Check" 2 "Single Chan" 3 "Single Check"	

File	Group	No.	Parameter Name & Description See <a href="#">page 16</a> for symbol descriptions	Values	Related
MOTOR CONTROL	Speed Feedback	413	<b>[Encoder PPR]</b> Contains the encoder pulses per revolution. For improved operation in FVC Vector mode, PPR should be <sup>3</sup> (64 x motor poles).	Default: 1024 PPR Min/Max: 2/20000 PPR Units: 1 PPR	
		414	<b>[Enc Position Fdbk]</b> Displays raw encoder pulse count. For single channel encoders, this count will increase (per rev.) by the amount in [Encoder PPR]. For quadrature encoders this count will increase by 4 times the amount defined in [Encoder PPR]. A power cycle is required to reset this value.	Default: Read Only Min/Max: -/+2147483647 Units: 1	
		415	<b>[Encoder Speed]</b> Provides a monitoring point that reflects speed as seen from the feedback device.	Default: Read Only Min/Max: -/+420.0 Hz -/+25200.0 RPM Units: 0.1 Hz 0.1 RPM	<a href="#">079</a>
		416	<b>[Fdbk Filter Sel]</b> Selects the type of feedback filter desired. "Light" uses a 35/49 radian feedback filter. "Heavy" uses a 20/40 radian feedback filter.	Default: 0 "None" Options: 0 "None" 1 "Light" 2 "Heavy"	
		419	<b>[Notch FilterFreq]</b> Sets the center frequency for an optional 2-pole notch filter. Filter is applied to the torque command. "0" disables this filter.	Default: 0.0 Hz Min/Max: 0.0/500.0 Hz Units: 0.1 Hz	<a href="#">053</a>
		420	<b>[Notch Filter K]</b> Sets the gain for the 2-pole notch filter.	Default: 0.3 Hz Min/Max: 0.1/0.9 Hz Units: 0.1 Hz	<a href="#">053</a>
		421	<b>[Marker Pulse]</b> Latches the raw encoder count at each marker pulse.	Default: Read Only Min/Max: -/+2147483647 Units: 1	
		422	<b>[Pulse In Scale]</b> Sets the scale factor/gain for the Pulse Input when P423 is set to "Pulse Input." Calculate for the desired speed command as follows: for Hz, [Pulse In Scale] = $\frac{\text{Input Pulse Rate (Hz)}}{\text{Desired Cmd. (Hz)}}$ for RPM, [Pulse In Scale] = $\frac{\text{Input Pulse Rate (Hz)}}{\text{Desired Cmd. (RPM)}} \times \frac{120}{[\text{Motor Poles}]}$	Default: 64 Min/Max: 2/20000 Units: 1	
		423	<b>[Encoder Z Chan]</b> Defines if the input wired to terminals 5 & 6 of the Encoder Terminal Block will be used as a Pulse or Marker input. Options 1 & 3 detect a loss of signal (when using differential inputs) regardless of the [Feedback Select], param. 080 setting. When option 2 or 3 is used with Profile/Indexer mode, the "homing" routine will position to the nearest marker pulse off of the home limit switch.	Default: 0 "Pulse Input" Options: 0 "Pulse Input" 1 "Pulse Check" 2 "Marker Input" 3 "Marker Check"	

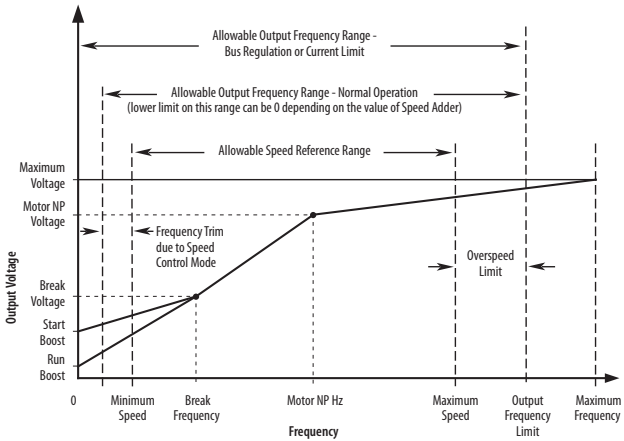
# Speed Command File

File	Group	No.	Parameter Name & Description See <a href="#">page 16</a> for symbol descriptions	Values	Related
SPEED COMMAND	Spd Mode & Limits	079	<p><b>[Speed Units]</b></p> <p> Selects the units to be used for all speed related parameters. Options 0 &amp; 1 indicate status only. 2 &amp; 3 will convert/configure the drive for that selection.</p> <p>“Convert Hz” (2) - converts all speed based parameters to Hz, and changes the value proportionately (i.e. 1800 RPM = 60 Hz).</p> <p>“Convert RPM” (3) - converts all speed based parameters to RPM, and changes the value proportionately.</p> <p>This parameter is not reset when “Reset to Defaults” is selected.</p>	Default: 0 “Hz” Options: 0 “Hz” 1 “RPM” 2 “Convert Hz” 3 “Convert RPM”	
		080	<p><b>[Feedback Select]</b></p> <p> Selects the source for motor speed feedback. Note that all selections are available when using Process PI.</p> <p>“Open Loop” (0) - no encoder is present, and slip compensation is not needed.</p> <p>“Slip Comp” (1) - tight speed control is needed, and encoder is not present.</p> <p>“Encoder” (3) - an encoder is present.</p> <p>“Simulator” (5) - Simulates a motor for testing drive operation &amp; interface check.</p>	Default: 0 “Open Loop” Options: 0 “Open Loop” 1 “Slip Comp” 2 “Reserved” 3 “Encoder” 4 “Reserved” 5 “Simulator”	<a href="#">412</a> <a href="#">152</a>
		081	<p><b>[Minimum Speed]</b></p> <p> Sets the low limit for speed reference after scaling is applied. Refer to parameter 083 [Overspeed Limit].</p>	Default: 0.0 Min/Max: 0.0/[Maximum Speed] Units: 0.1 Hz 0.1 RPM	<a href="#">079</a> <a href="#">083</a> <a href="#">092</a> <a href="#">095</a>
		082	<p><b>[Maximum Speed]</b></p> <p> Sets the high limit for speed reference after scaling is applied. Refer to parameter 083 [Overspeed Limit].</p>	Default: 50.0 or 60.0 Hz (volt class) [Motor NP RPM] Min/Max: 5.0/420.0 Hz 75.0/24000.0 RPM Units: 0.1 Hz 0.1 RPM	<a href="#">055</a> <a href="#">079</a> <a href="#">083</a> <a href="#">091</a> <a href="#">094</a> <a href="#">202</a>
		083	<p><b>[Overspeed Limit]</b></p> <p> Sets the incremental amount of the output frequency (above [Maximum Speed]) allowable for functions such as slip compensation. [Maximum Speed] + [Overspeed Limit] must be <math>\leq</math> [Maximum Freq]</p>	Default: 10.0 Hz 300.0 RPM Min/Max: 0.0/20.0 Hz 0.0/600.0 RPM Units: 0.1 Hz 0.1 RPM	<a href="#">055</a> <a href="#">079</a> <a href="#">082</a> 



File	Group	No.	Parameter Name & Description See <a href="#">page 16</a> for symbol descriptions	Values	Related
SPEED COMMAND	Spd Mode & Limits	084	<b>[Skip Frequency 1]</b>	Default: 0.0 Hz	<a href="#">087</a> 
		085	<b>[Skip Frequency 2]</b>	Default: 0.0 Hz	
		086	<b>[Skip Frequency 3]</b> Sets a frequency at which the drive will not operate.	Default: 0.0 Hz Min/Max: -/[Maximum Speed] Units: 0.1 Hz	
		087	<b>[Skip Freq Band]</b> Determines the bandwidth around a skip frequency. [Skip Freq Band] is split, applying 1/2 above and 1/2 below the actual skip frequency. The same bandwidth applies to all skip frequencies.	Default: 0.0 Hz Min/Max: 0.0/30.0 Hz Units: 0.1 Hz	<a href="#">084</a> <a href="#">085</a> <a href="#">086</a>
SPEED COMMAND	Spd Mode & Limits	088	<b>[Speed/Torque Mod]</b>  Selects the torque reference source. "Zero Torque" (0) - torque command = 0. "Speed Reg" (1) - drive operates as a speed regulator. "Torque Reg" (2) - an external torque reference is used for the torque command. "Min Torq/Spd" (3) - selects the smallest algebraic value to regulate to when the torque reference and torque generated from the speed regulator are compared. "Max Torq/Spd" (4) - selects the largest algebraic value when the torque reference and the torque generated from the speed regulator are compared. "Sum Torq/Spd" (5) - selects the sum of the torque reference and the torque generated from the speed regulator. "Absolute Min" (6) - selects the smallest absolute algebraic value to regulate to when the torque reference and torque generated from the speed regulator are compared. "Pos/Spd Prof" (7) - drive operates as a speed or position regulator as determined by the Profile Step parameters (720-877) and Setup parameters (705-719).	Default: 1 "Speed Reg" Options: 0 "Zero Torque" 1 "Speed Reg" 2 "Torque Reg" 3 "Min Torq/Spd" 4 "Max Torq/Spd" 5 "Sum Torq/Spd" 6 "Absolute Min" 7 "Pos/Spd Prof"	<a href="#">053</a>
		454	<b>[Rev Speed Limit]</b>  Sets a limit on speed in the negative direction, when in FVC Vector mode. Used in bipolar mode only. A value of zero disables this parameter and uses [Maximum Speed] for reverse speed limit.	Default: 0.0 RPM Min/Max: -[Max Speed]/0.0 Hz Units: 0.0 Hz 0.0 RPM	





**ATTENTION:** The speed of the drive could reach [Maximum Speed] + [Overspeed Limit] to meet required torque when any of the torque modes have been selected. Equipment damage and/or personal injury can result.

File	Group	No.	Parameter Name & Description See <a href="#">page 16</a> for symbol descriptions	Values	Related
SPEED COMMAND	Speed References	090	<p><b>[Speed Ref A Sel]</b></p> <p>Selects the source of the speed reference to the drive unless [Speed Ref B Sel] or [Preset Speed 1-7] is selected.</p> <p>(1) See <a href="#">Appendix B</a> for DPI port locations.                      (2) If selected, HIM manual control is not allowed.                      (3) Minimum 64 PPR required.</p>	Default: 2 "Analog In 2" Options: 1 "Analog In 1" 2 "Analog In 2" 3-6 "Reserved" 7 "Pulse In" <sup>(3)</sup> 8 "Encoder" 9 "MOP Level" 10 "Reserved" 11 "Preset Spd1" 12 "Preset Spd2" 13 "Preset Spd3" 14 "Preset Spd4" 15 "Preset Spd5" 16 "Preset Spd6" 17 "Preset Spd7" 18 "DPI Port 1" <sup>(1) (2)</sup> 19 "DPI Port 2" <sup>(1)</sup> 20 "DPI Port 3" <sup>(1)</sup> 21 "DPI Port 4" <sup>(1)</sup> 22 "DPI Port 5" <sup>(1)</sup> 23-24 "Reserved" 25 "Scale Block1" 26 "Scale Block2" 27 "Scale Block3" 28 "Scale Block4" 29 "Reserved" 30 "HighRes Ref"	<a href="#">002</a> <a href="#">091</a> ... <a href="#">093</a> <a href="#">101</a> ... <a href="#">107</a> <a href="#">117</a> ... <a href="#">120</a> <a href="#">192</a> ... <a href="#">194</a> <a href="#">213</a> <a href="#">272</a> <a href="#">273</a> <a href="#">320</a> <a href="#">361</a> ... <a href="#">366</a>
		091	<p><b>[Speed Ref A Hi]</b></p> <p>Scales the upper value of the [Speed Ref A Sel] selection when the source is an analog input.</p>	Default: [Maximum Speed] Min/Max: -/+ [Maximum Speed] Units: 0.1 Hz 0.01 RPM	<a href="#">079</a> <a href="#">082</a>
		092	<p><b>[Speed Ref A Lo]</b></p> <p>Scales the lower value of the [Speed Ref A Sel] selection when the source is an analog input.</p>	Default: 0.0 Min/Max: -/+ [Maximum Speed] Units: 0.1 Hz 0.01 RPM	<a href="#">079</a> <a href="#">081</a>
		093	<p><b>[Speed Ref B Sel]</b></p> <p>See <a href="#">[Speed Ref A Sel]</a>.</p>	Default: 11 "Preset Spd1" Options: See <a href="#">[Speed Ref A Sel]</a>	See <a href="#">090</a>
		094	<p><b>[Speed Ref B Hi]</b></p> <p>Scales the upper value of the [Speed Ref B Sel] selection when the source is an analog input.</p>	Default: [Maximum Speed] Min/Max: -/+ [Maximum Speed] Units: 0.1 Hz 0.01 RPM	<a href="#">079</a> <a href="#">093</a>
		095	<p><b>[Speed Ref B Lo]</b></p> <p>Scales the lower value of the [Speed Ref B Sel] selection when the source is an analog input.</p>	Default: 0.0 Min/Max: -/+ [Maximum Speed] Units: 0.1 Hz 0.01 RPM	<a href="#">079</a> <a href="#">090</a> <a href="#">093</a>

File	Group	No.	Parameter Name & Description See <a href="#">page 16</a> for symbol descriptions	Values	Related
SPEED COMMAND	Speed References	096	<p><b>[TB Man Ref Sel]</b></p> <p>Sets the manual speed reference source when a digital input (parameter 361...366) is configured for "Auto/Manual" or "Manual/Auto" (v7.002 &amp; later).</p> <p><sup>(1)</sup> "Analog In 2" is not a valid selection if it was selected for any of the following:</p> <ul style="list-style-type: none"> <li>- [Trim In Select]</li> <li>- [PI Feedback Sel]</li> <li>- [PI Reference Sel]</li> <li>- [Current Lmt Sel]</li> <li>- [Sleep-Wake Ref]</li> </ul> <p><sup>(2)</sup> Requires a Series B HIM with firmware v5.004 or greater.</p> <p>Selects the HIM to provide the manual speed reference when a digital input is configured for "Auto/Manual" or "Manual/Auto."</p> <p>Additionally, if [Man Ref Preload], parameter 193 is set to "Enabled," the automatic speed reference will be preloaded into the HIM when the drive switches to Manual mode from Automatic mode (or to Automatic mode from Manual mode).</p> <ul style="list-style-type: none"> <li>• Set [Save HIM Ref], parameter 192, bit 1 (Manual Mode) as desired.</li> <li>• Set [TB Man Ref Sel] to the desired drive reference when in Manual Mode. If set to one of the DPI Ports, then [Man Ref Preload] must be set to enable or disable reference preload of the current speed. Connect a HIM to the DPI Port selected.</li> <li>• When Manual mode is requested through the terminal block digital input, the drive evaluates if Manual mode can be granted.</li> <li>• If [TB Man Ref Sel] is set to a DPI Port and [Man Ref Preload] is enabled, the drive transfers the last value of the automatic speed reference to the HIM. The HIM is now the speed reference source. The terminal block has exclusive control based on [Save HIM Ref], bit 1 (Manual Mode). If [Man Ref Preload] is disabled, the HIM is now the speed reference source. The terminal block has exclusive control based on [Save HIM Ref], bit 1 (Manual Mode).</li> </ul> <p><b>Important:</b> the HIM does not enter Manual mode, it is only the reference source for the terminal block. When Auto mode is requested through the terminal block, the drive changes to Auto mode and returns control and reference to the previous state before Manual mode was requested.</p>	<p>Default: 1 "Analog In 1"</p> <p>Options: 1 "Analog In 1" 2 "Analog In 2"<sup>(1)</sup> 3-8 "Reserved" 9 "MOP Level" 10-17 "Reserved" 18 "DPI Port 1"<sup>(2)</sup> 19 "DPI Port 2"<sup>(2)</sup> 20 "DPI Port 3"<sup>(2)</sup></p>	<p><a href="#">097</a> <a href="#">098</a></p>
		097	<p><b>[TB Man Ref Hi]</b></p> <p>Scales the upper value of the [TB Man Ref Sel] selection when the source is an analog input.</p>	<p>Default: [Maximum Speed]</p> <p>Min/Max: -/[Maximum Speed]</p> <p>Units: 0.1 Hz 0.01 RPM</p>	<p><a href="#">079</a> <a href="#">096</a></p>
		098	<p><b>[TB Man Ref Lo]</b></p> <p>Scales the lower value of the [TB Man Ref Sel] selection when the source is an analog input.</p>	<p>Default: 0.0</p> <p>Min/Max: -/[Maximum Speed]</p> <p>Units: 0.1 Hz 0.01 RPM</p>	<p><a href="#">079</a> <a href="#">096</a></p>
		099	<p><b>[Pulse Input Ref]</b></p> <p>Displays the pulse input value as seen at terminals 5 and 6 of the Encoder Terminal Block, if [Encoder Z Chan], parameter 423 is set to "Pulse Input."</p>	<p>Default: Read Only</p> <p>Min/Max: -/+420.0 Hz -/+25200.0 RPM</p> <p>Units: 0.1 Hz 0.1 RPM</p>	
		100	<p><b>[Jog Speed 1]</b></p> <p>Sets the output frequency when Jog Speed 1 is selected.</p>	<p>Default: 10.0 Hz 300.0 RPM</p> <p>Min/Max: -/[Maximum Speed]</p> <p>Units: 0.1 Hz 1 RPM</p>	<p><a href="#">079</a></p>
		101 102 103 104 105 106 107	<p><b>[Preset Speed 1]</b> <b>[Preset Speed 2]</b> <b>[Preset Speed 3]</b> <b>[Preset Speed 4]</b> <b>[Preset Speed 5]</b> <b>[Preset Speed 6]</b> <b>[Preset Speed 7]</b></p> <p>Provides an internal fixed speed command value. In bipolar mode direction is commanded by the sign of the reference.</p>	<p>Default: 5.0 Hz/150 RPM 10.0 Hz/300 RPM 20.0 Hz/600 RPM 30.0 Hz/900 RPM 40.0 Hz/1200 RPM 50.0 Hz/1500 RPM 60.0 Hz/1800 RPM</p> <p>Min/Max: -/[Maximum Speed]</p> <p>Units: 0.1 Hz 1 RPM</p>	<p><a href="#">079</a> <a href="#">090</a> <a href="#">093</a></p>

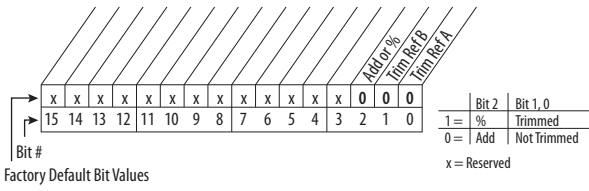

File	Group	No.	Parameter Name & Description See <a href="#">page 16</a> for symbol descriptions	Values	Related
SPEED COMMAND	Discrete Speeds	108	<b>[Jog Speed 2]</b> Sets the output frequency when Jog Speed 2 is selected.	Default: 10.0 Hz 300.0 RPM Min/Max: -/+ [Maximum Speed] Units: 0.1 Hz 1 RPM	
		116	<b>[Trim % Setpoint]</b>  Adds or subtracts a percentage of the speed reference or maximum speed. Dependent on the setting of [Trim Out Select], parameter 118.	Default: 0.0% Min/Max: -/+200.0% Units: 0.1%	<a href="#">118</a>
	117	<b>[Trim In Select]</b>  Specifies which analog input signal is being used as a trim input.  (1) See <a href="#">Appendix B</a> for DPI port locations. (2) If selected, HIM manual control is not allowed.	Default: 2 "Analog In 2" Options: 0 "PI Setpoint" 1 "Analog In 1" 2 "Analog In 2" 3-6 "Reserved" 7 "Pulse In" 8 "Encoder" 9 "MOP Level" 10 "Reserved" 11 "Preset Spd1" 12 "Preset Spd2" 13 "Preset Spd3" 14 "Preset Spd4" 15 "Preset Spd5" 16 "Preset Spd6" 17 "Preset Spd7" 18 "DPI Port 1" <sup>(1) (2)</sup> 19 "DPI Port 2" <sup>(1)</sup> 20 "DPI Port 3" <sup>(1)</sup> 21 "DPI Port 4" <sup>(1)</sup> 22 "DPI Port 5" <sup>(1)</sup> 23-24 "Reserved" 25-28 "Scale Block1-4"	<a href="#">090</a> <a href="#">093</a> <a href="#">127</a>	
	118	<b>[Trim Out Select]</b>  Specifies which speed references are to be trimmed.   Factory Default Bit Values		<a href="#">117</a> <a href="#">119</a> <a href="#">120</a>	
	119	<b>[Trim Hi]</b> Scales the upper value of the [Trim In Select] selection when the source is an analog input.	Default: 60.0 Hz Min/Max: -/+ [Maximum Speed] Units: 0.1 Hz 1 RPM/%	<a href="#">079</a> <a href="#">082</a> <a href="#">117</a>	
	120	<b>[Trim Lo]</b> Scales the lower value of the [Trim In Select] selection when the source is an analog input.	Default: 0.0 Hz Min/Max: -/+ [Maximum Speed] Units: 0.1 Hz 1 RPM/%	<a href="#">079</a> <a href="#">117</a>	

File	Group	No.	Parameter Name & Description See <a href="#">page 16</a> for symbol descriptions	Values	Related
SPEED COMMAND	Slip Comp		<b>Important:</b> Parameters in the Slip Comp Group are used to enable and tune the Slip Compensation Regulator. In order to allow the regulator to control drive operation, parameter 080 [Speed Mode] must be set to 1 "Slip Comp".		
		121	<b>[Slip RPM @ FLA]</b> Sets the amount of compensation to drive output at motor FLA. Slip RPM @ FLA = Synchronous Speed - Motor Nameplate RPM  If the value of parameter 061 [Autotune] = 3 "Calculate" changes made to this parameter will not be accepted.  Value can be changed by [Autotune] when "Encoder" is selected in [Feedback Select], parameter 080.	Default: Based on [Motor NP RPM] Min/Max: 0.0/1200.0 RPM Units: 0.1 RPM	<a href="#">061</a> <a href="#">080</a> <a href="#">122</a> <a href="#">123</a>
		122	<b>[Slip Comp Gain]</b> Sets the response time of slip compensation.	Default: 40.0 Min/Max: 1.0/100.0 Units: 0.1	<a href="#">080</a> <a href="#">121</a> <a href="#">122</a>
		123	<b>[Slip RPM Meter]</b> Displays the present amount of adjustment being applied as slip compensation.	Default: Read Only Min/Max: -/+300.0 RPM Units: 0.1 RPM	<a href="#">080</a> <a href="#">121</a> <a href="#">122</a>
		124	<b>[PI Configuration]</b> Sets configuration of the PI regulator.		<a href="#">124</a> ... <a href="#">138</a>
Process PI			<p>Factory Default Bit Values</p> <p><b>Option Description</b></p> <p>AdjVltTrim (10) Configures the PI regulator output to trim the voltage reference, rather than the torque or speed references. The trim can be configured to be exclusive by setting "Excl Mode" (bit 0). Trimming the voltage reference is not compatible with trimming the torque reference, thus if bits 8 &amp; 10 are set, a type II alarm will occur, setting "PI Cfg Cfct" (bit 19) in [Drive Alarm 2].</p>		<a href="#">124</a> ... <a href="#">138</a>
		125	<b>[PI Control]</b> Controls the PI regulator.		<a href="#">080</a>



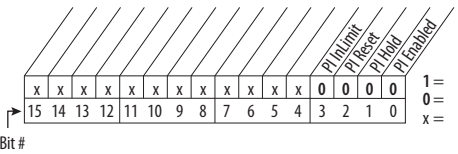



File	Group	No.	Parameter Name & Description See <a href="#">page 16</a> for symbol descriptions	Values	Related
SPEED COMMAND	Process PI	126	<b>[PI Reference Sel]</b> Selects the source of the PI reference.  (1) Adjustable Voltage Mode.	Default: 0 "PI Setpoint" Options: 0 "PI Setpoint" 1 "Analog In 1" 2 "Analog In 2" 3-6 "Reserved" 7 "Pulse In" 8 "Encoder" 9 "MOP Level" 10 "Master Ref" 11-17 "Preset Spd1-7" 18-22 "DPI Port 1-5" 23-24 "Reserved" 25-28 "Scale Block 1-4" 29 "Preset 1-7 Volt" <sup>(1)</sup> 36 "Voltage Cmd" <sup>(1)</sup>	<a href="#">124</a> <a href="#">124</a> ... <a href="#">138</a>  
		127	<b>[PI Setpoint]</b> Provides an internal fixed value for process setpoint when [PI Reference Sel] is set to "PI Setpoint."	Default: 50.00% Min/Max: -/+100.00% of Maximum Process Value Units: 0.01%	<a href="#">124</a> ... <a href="#">138</a>
		128	<b>[PI Feedback Sel]</b> Selects the source of the PI feedback.  (1) Adjustable Voltage Mode.	Default: 0 "PI Setpoint" Options: 0 "PI Setpoint" 1 "Analog In 1" 2 "Analog In 2" 3-6 "Reserved" 7 "Pulse In" 8 "Encoder" 9 "MOP Level" 10 "Master Ref" 11-17 "Preset Spd1-7" 18-22 "DPI Port 1-5" 23-24 "Reserved" 25-28 "Scale Block 1-4" 29 "Preset 1-7 Volt" <sup>(1)</sup> 36 "Voltage Cmd" <sup>(1)</sup> 37 "Output Power" <sup>(1)</sup> 38 "Output Cur" <sup>(1)</sup>	<a href="#">124</a> ... <a href="#">138</a>
		129	<b>[PI Integral Time]</b> Time required for the integral component to reach 100% of [PI Error Meter]. Not functional when the PI Hold bit of [PI Control] = "1" (enabled).	Default: 2.00 Secs Min/Max: 0.00/100.00 Secs Units: 0.01 Secs	<a href="#">124</a> ... <a href="#">138</a>
		130	<b>[PI Prop Gain]</b> Sets the value for the PI proportional component. PI Error x PI Prop Gain = PI Output	Default: 1.0 Min/Max: 0.00/100.00 Units: 0.01	<a href="#">124</a> ... <a href="#">138</a>
		131	<b>[PI Lower Limit]</b> Sets the lower limit of the PI output.	Default: -[Maximum Freq] -100% Min/Max: -/+400.0 Hz -/+800.0% Units: 0.1 Hz 0.1%	<a href="#">079</a> <a href="#">124</a> ... <a href="#">138</a>





File	Group	No.	Parameter Name & Description See page 16 for symbol descriptions	Values	Related
SPEED COMMAND	Process PI	132	<b>[PI Upper Limit]</b> Sets the upper limit of the PI output.	Default: +[Maximum Freq] 100% Min/Max: -/+400.0 Hz -/+800.0% Units: 0.1 Hz 0.1%	<a href="#">079</a> <a href="#">124</a> ... <a href="#">138</a>
		133	<b>[PI Preload]</b> Sets the value used to preload the integral component on start or enable.	Default: 0.0 Hz 100.0% Min/Max: [PI Lower Limit]/ [PI Upper Limit] Units: 0.1 Hz 0.1%	<a href="#">079</a> <a href="#">124</a> ... <a href="#">138</a>
		134	<b>[PI Status]</b> Status of the Process PI regulator. 	Read Only	<a href="#">124</a> ... <a href="#">138</a>
		135	<b>[PI Ref Meter]</b> Present value of the PI reference signal.	Default: Read Only Min/Max: -/+100.0% Units: 0.1%	<a href="#">124</a> ... <a href="#">138</a>
		136	<b>[PI Fdback Meter]</b> Present value of the PI feedback signal.	Default: Read Only Min/Max: -/+100.0% Units: 0.1%	<a href="#">124</a> ... <a href="#">138</a>
		137	<b>[PI Error Meter]</b> Present value of the PI error.	Default: Read Only Min/Max: -/+200.0% Units: 0.1%	<a href="#">124</a> ... <a href="#">138</a>
		138	<b>[PI Output Meter]</b> Present value of the PI output.	Default: Read Only Min/Max: -/+800.0% Units: 0.1%	<a href="#">124</a> ... <a href="#">138</a>
		139	<b>[PI BW Filter]</b> Provides filter for Process PI error signal. The output of this filter is displayed in [PI Error Meter]. Zero will disable the filter.	Default: 0.0 Radians Min/Max: 0.0/240.0 Radians Units: 0.1 Radians	<a href="#">137</a>
		459	<b>[PI Deriv Time]</b> Refer to formula below: $PI_{Out} = KD (Sec) \times \frac{d_{PI\ Error} (\%)}{d_t (Sec)}$	Default: 0.00 Secs Min/Max: 0.00/100.00 Secs Units: 0.01 Secs	
		460	<b>[PI Reference Hi]</b> Scales the upper value of [PI Reference Sel].	Default: 100.0% Min/Max: -/+100.0% Units: 0.1%	
		461	<b>[PI Reference Lo]</b> Scales the lower value of [PI Reference Sel].	Default: -100.0% Min/Max: -/+100.0% Units: 0.1%	
		462	<b>[PI Feedback Hi]</b> Scales the upper value of [PI Feedback Sel].	Default: 100.0% Min/Max: -/+100.0% Units: 0.1%	
		463	<b>[PI Feedback Lo]</b> Scales the lower value of [PI Feedback Sel].	Default: 0.0% Min/Max: -/+100.0% Units: 0.1%	
		464	<b>[PI Output Gain]</b> Sets the gain factor for [PI Output Meter].	Default: 1.000 Min/Max: -/+8.000 Units: 0.001	

File	Group	No.	Parameter Name & Description See <a href="#">page 16</a> for symbol descriptions	Values	Related
SPEED COMMAND	Speed Regulator	445	<b>[Ki Speed Loop]</b> Controls the integral error gain of the speed regulator. The drive automatically adjusts [Ki Speed Loop] when a non-zero value is entered for [Speed Desired BW] or an autotune is performed. Typically, manual adjustment of this parameter is needed only if system inertia cannot be determined through an autotune. [Speed Desired BW] is set to "0" when a manual adjustment is made to this parameter.	Default: 7.0 Min/Max: 0.0/4000.0 Units: 0.1	<a href="#">053</a>
		446	<b>[Kp Speed Loop]</b> Controls the proportional error gain of the speed regulator. The drive automatically adjusts [Kp Speed Loop] when a non-zero value is entered for [Speed Desired BW] or an auto-tune is performed. Typically, manual adjustment of this parameter is needed only if system inertia cannot be determined through an autotune. [Speed Desired BW] is set to "0" when a manual adjustment is made to this parameter. An internal Error Filter BW is active when Kp or [Speed Desired BW] is changed. It is set to Kp times [Total Inertia] with a minimum of 25 radians.	Default: 6.3 Min/Max: 0.0/200.0 Units: 0.1	<a href="#">053</a>
		447	<b>[Kf Speed Loop]</b> Controls the feed forward gain of the speed regulator. Setting the Kf gain greater than zero reduces speed feedback overshoot in response to a step change in speed reference.	Default: 0.0 Min/Max: 0.0/0.5 Units: 0.1	<a href="#">053</a>
		448	<b>[v6 Spd Err Filt BW]</b> Sets the bandwidth of a speed error filter used in FVC Vector mode. A setting of "0.0" disables the filter.	Default: 200.0 R/s Min/Max: 0.0/2000.0 R/s Units: 0.1 R/s	<a href="#">053</a>
		449	<b>[Speed Desired BW]</b> Sets the speed loop bandwidth and determines the dynamic behavior of the speed loop. As bandwidth increases, the speed loop becomes more responsive and can track a faster changing speed reference. Adjusting this parameter will cause the drive to calculate and change [Ki Speed Loop] and [Kp Speed Loop] gains.	Default: 0.0 Radians/Sec Min/Max: 0.0/250.0 Radians/Sec Units: 0.1 Radians/Sec	<a href="#">053</a>
		450	<b>[Total Inertia]</b> Represents the time in seconds, for a motor coupled to a load to accelerate from zero to base speed, at rated motor torque. The drive calculates Total Inertia during the autotune inertia procedure. Adjusting this parameter will cause the drive to calculate and change [Ki Speed Loop] and [Kp Speed Loop] gains.	Default: 0.10 Secs Min/Max: 0.01/600.00 Units: 0.01 Secs	<a href="#">053</a>
		451	<b>[Speed Loop Meter]</b> Value of the speed regulator output. (1) "%" if [Motor Cntl Sel] = "FVC Vector."	Default: Read Only Min/Max: -/+800.0% <sup>(1)</sup> -/+800.0 Hz -/+800.0 RPM Units: 0.1%/Hz/RPM	<a href="#">053</a> <a href="#">121</a> <a href="#">079</a>



## Dynamic Control File





File	Group	No.	Parameter Name & Description See <a href="#">page 16</a> for symbol descriptions	Values	Related
DYNAMIC CONTROL	Ramp Rates	140	<b>[Accel Time 1]</b>	Default: 10.0 Secs	<a href="#">142</a>
		141	<b>[Accel Time 2]</b> Sets the rate of accel for all speed increases. $\frac{\text{Max Speed}}{\text{Accel Time}} = \text{Accel Rate}$	10.0 Secs Min/Max: 0.0/3600.0 Secs Units: 0.1 Secs	<a href="#">143</a> <a href="#">146</a> <a href="#">361</a>
		142	<b>[Decel Time 1]</b>	Default: 10.0 Secs	<a href="#">140</a>
	143	<b>[Decel Time 2]</b> Sets the rate of decel for all speed decreases. $\frac{\text{Max Speed}}{\text{Decel Time}} = \text{Decel Rate}$	10.0 Secs Min/Max: 0.0/3600.0 Secs Units: 0.1 Secs	<a href="#">141</a> <a href="#">146</a> <a href="#">361</a>	
	146	<b>[S Curve %]</b> Sets the percentage of accel or decel time that is applied to the ramp as S Curve. Time is added, 1/2 at the beginning and 1/2 at the end of the ramp.	Default: 0% Min/Max: 0/100% Units: 1%	<a href="#">140</a> ... <a href="#">143</a>	
	Load Limits	147	 <b>[Current Lmt Sel]</b> Selects the source for the adjustment of current limit (i.e. parameter, analog input, etc.).	Default: 0 "Cur Lim Val" Options: 0 "Cur Lim Val" 1 "Analog In 1" 2 "Analog In 2"	<a href="#">146</a> <a href="#">149</a>
		148	<b>[Current Lmt Val]</b> Defines the current limit value when [Current Lmt Sel] = "Cur Lim Val." When in "Adj Voltage" mode, the output voltage will not be allowed to exceed this value.	Default: [Rated Amps] x 1.5 (Equation yields approximate default value.) Min/Max: Based on Drive Rating Units: 0.1 Amps	<a href="#">147</a> <a href="#">149</a>
		149	<b>[Current Lmt Gain]</b> Sets the responsiveness of the current limit.	Default: 250 Min/Max: 0/5000 Units: 1	<a href="#">147</a> <a href="#">148</a>
		150	<b>[Drive OL Mode]</b> Selects the drives response to increasing drive temperature and can reduce the current limit value as well as the PWM frequency. If the drive is being used with a sine wave filter, the filter is likely tuned to a specific carrier frequency. To ensure stable operation it is recommended to set this parameter to "Reduce CLim"	Default: 3 "Both-PWM 1st" Options: 0 "Disabled" 1 "Reduce CLim" 2 "Reduce PWM" 3 "Both-PWM 1st"	<a href="#">219</a>
		151	<b>[PWM Frequency]</b> Sets the carrier frequency for the PWM output. Drive derating can occur at higher carrier frequencies. For derating information, refer to the PowerFlex Reference Manual. <b>Important:</b> Changing the PWM frequency can affect the motor lead length. Refer to the motor cable length restriction tables in Wiring and Grounding Guidelines for Pulse Width Modulated (PWM) AC Drives, publication <a href="#">DRIVES-IN001</a> . <b>Important:</b> If parameter 053 [Motor Cntl Sel] is set to "FVC Vector," the drive will run at 2 kHz when operating below 6 Hz.	Default: 4 kHz or 2 kHz (Refer to <a href="#">Appendix A</a> ) Min/Max: 2/10 kHz Units: 2/4/8/10 kHz	
152	<b>[Droop RPM @ FLA]</b> Selects amount of droop that the speed reference is reduced when at full load torque. Zero disables the droop function. <b>Important:</b> Selecting "Slip Comp" with parameter 080 in conjunction with parameter 152, can produce undesirable results.	Default: 0.0 RPM Min/Max: 0.0/200.0 RPM Units: 0.1 RPM			



File	Group	No.	Parameter Name & Description See <a href="#">page 16</a> for symbol descriptions	Values	Related
DYNAMIC CONTROL	Load Limits	153	<b>[Regen Power Limit]</b>  Sets the maximum power limit allowed to transfer from the motor to the DC bus. When using an external dynamic brake, set this parameter to its maximum value.	Default: -50.0% Min/Max: -800.0/0.0% Units: 0.1%	<a href="#">053</a>
		154	<b>[Current Rate Limit]</b>  Sets the largest allowable rate of change for the current reference signal. This number is scaled in percent of maximum motor current every 250 microseconds.	Default: 400.0% Min/Max: 1.0/800.0% Units: 0.1%	<a href="#">053</a>
	Stop/Brake Modes	145	<b>[DB While Stopped]</b>  Enables/disables dynamic brake operation when drive is stopped. DB can operate if input voltage becomes too high. Disabled = DB will only operate when drive is running. Enable = DB can operate whenever drive is energized.	Default: 0 "Disabled" Options: 0 "Disabled" 1 "Enabled"	<a href="#">161</a> <a href="#">162</a>
		155 156	<b>[Stop Mode A]</b> <b>[Stop Mode B]</b> Active stop mode. [Stop Mode A] is active unless [Stop Mode B] is selected by inputs. <sup>(1)</sup> When using options 1, 2 or 4, refer to parameter 158 Attention statements.	Default: 1 "Ramp" Default: 0 "Coast" Options: 0 "Coast" 1 "Ramp" <sup>(1)</sup> 2 "Ramp to Hold" <sup>(1)</sup> 3 "DC Brake" 4 "Fast Brake" <sup>(1)</sup>	<a href="#">157</a> <a href="#">158</a> <a href="#">159</a> 
		157	<b>[DC Brake Lvl Sel]</b> Selects the source for [DC Brake Level].	Default: 0 "DC Brake Lvl" Options: 0 "DC Brake Lvl" 1 "Analog In 1" 2 "Analog In 2"	<a href="#">155</a> <a href="#">156</a> <a href="#">158</a> <a href="#">159</a>
		158	<b>[DC Brake Level]</b> Defines the DC brake current level injected into the motor when "DC Brake" is selected as a stop mode or when using the motor DC injection brake feature through a digital input. This also sets the braking current level when "Fast Stop" is selected. The DC braking voltage used in this function is created by a PWM algorithm and may not generate the smooth holding force needed for some applications. Refer to the PowerFlex Reference Manual.	Default: [Rated Amps] Min/Max: 0/[Rated Amps] x 1.5 (Equation yields approximate maximum value.) Units: 0.1 Amps	<a href="#">361</a> ... <a href="#">366</a>
		<div style="border: 1px solid black; padding: 5px;">  <p><b>ATTENTION:</b> If a hazard of injury due to movement of equipment or material exists, an auxiliary mechanical braking device must be used.</p> <p><b>ATTENTION:</b> This feature should not be used with synchronous or permanent magnet motors. Motors can be demagnetized during braking.</p> </div>			
		159	<b>[DC Brake Time]</b> Sets the amount of time DC brake current is "injected" into the motor. Not used for "Ramp to Hold" which will apply DC braking continuously. See <a href="#">page 143</a> .	Default: 0.0 Secs Min/Max: 0.0/90.0 Secs Units: 0.1 Secs	<a href="#">155</a> ... <a href="#">158</a> 
		160	<b>[Bus Reg Ki]</b> Sets the responsiveness of the bus regulator.	Default: 450 Min/Max: 0/5000 Units: 1	<a href="#">161</a> <a href="#">162</a>

File	Group	No.	Parameter Name & Description See <a href="#">page 16</a> for symbol descriptions	Values	Related
DYNAMIC CONTROL	Stop/Brake Modes	161	<b>[Bus Reg Mode A]</b>	Default: 1 "Adjust Freq"	<a href="#">160</a>
		162	<b>[Bus Reg Mode B]</b>	4 "Both-Frq 1st"	
			Sets the method and sequence of the DC bus regulator voltage. Choices are dynamic brake, frequency adjust or both. Sequence is determined by programming or digital input to the terminal block. <u>Dynamic Brake Setup</u> If a dynamic brake resistor is connected to the drive, both of these parameters must be set to either option 2, 3 or 4. Refer to the Attention statement on <a href="#">page 12</a> for important information on bus regulation.	Options: 0 "Disabled" 1 "Adjust Freq" 2 "Dynamic Brak" 3 "Both-DB 1st" 4 "Both-Frq 1st"	
			<b>ATTENTION:</b> The drive does not offer protection for externally mounted brake resistors. A risk of fire exists if external braking resistors are not protected. External resistor packages must be self-protected from over temperature or the protective circuit shown in <a href="#">Figure 5 on page 111</a> (or equivalent) must be supplied.		
		163	<b>[DB Resistor Type]</b> Selects whether the internal or an external DB resistor will be used. <b>Important:</b> In Frame 0...2 drives, only one DB resistor can be connected to the drive. Connecting both an internal & external resistor could cause damage. If a dynamic brake resistor is connected to the drive, [Bus Reg Mode A & B] must be set to either option 2, 3 or 4.	Default: 2 "None" Options: 0 "Internal Res" 1 "External Res" 2 "None"	<a href="#">161</a> <a href="#">162</a>
			<b>ATTENTION:</b> Equipment damage can result if a drive mounted (internal) resistor is installed and this parameter is set to "External Res" or "None." Thermal protection for the internal resistor will be disabled, resulting in possible device damage. Also see ATTENTION statement in parameter 161/162.		
		164	<b>[Bus Reg Kp]</b> Proportional gain for the bus regulator. Used to adjust regulator response.	Default: 1500 Min/Max: 0/10000 Units: 1	
		165	<b>[Bus Reg Kd]</b> Derivative gain for the bus regulator. Used to control regulator overshoot.	Default: 1000 Min/Max: 0/10000 Units: 1	
		166	<b>[Flux Braking]</b> Set to use an increase in the motor flux current to increase the motor losses, and allow a faster deceleration time when a chopper brake or regenerative capability is not available. Can be used as a stopping or fast deceleration method.	Default: 0 "Disabled" Options: 0 "Disabled" 1 "Enabled"	
		452	<b>[Stop Dwell Time]</b> Sets an adjustable delay time between detecting zero speed and disabling the speed and torque regulators, when responding to a stop command. For more information, please see <a href="#">Stop Dwell Time on page 145</a> . <b>Important:</b> Consult industry and local codes when setting the value of this parameter.	Default: 0.00 Secs Min/Max: 0.00/60.00 Secs Units: 0.01 Secs	



File	Group	No.	Parameter Name & Description See <a href="#">page 16</a> for symbol descriptions	Values	Related	
<b>DYNAMIC CONTROL</b>	<b>Restart Modes</b>	167	<b>[Powerup Delay]</b> Defines the programmed delay time, in seconds, before a start command is accepted after a power up.	Default: 0.0 Secs Min/Max: 0.0/10800.0 Secs Units: 0.1 Secs		
		168	<b>[Start At PowerUp]</b> Enables/disables a feature to issue a Start or Run command and automatically resume running at commanded speed after drive input power is restored. Requires a digital input configured for Run or Start and a valid start contact.	Default: 0 "Disabled" Options: 0 "Disabled" 1 "Enabled"		
		 <b>ATTENTION:</b> Equipment damage and/or personal injury can result if this parameter is used in an inappropriate application. Do not use this function without considering applicable local, national and international codes, standards, regulations or industry guidelines.				
		169	<b>[Flying Start En]</b> Enables/disables the function which reconnects to a spinning motor at actual RPM when a start command is issued. Not required in FVC Vector mode when using an encoder.	Default: 0 "Disabled" Options: 0 "Disabled" 1 "Enabled"	<a href="#">170</a>	
		170	<b>[Flying StartGain]</b> Sets the response of the flying start function. <b>Important:</b> Lower gain can be required for permanent magnet motors.	Default: 4000 Min/Max: 20/32767 Units: 1	<a href="#">169</a>	
		174	<b>[Auto Rstrt Tries]</b> Sets the maximum number of times the drive attempts to reset a fault and restart.	Default: 0 Min/Max: 0/9 Units: 1	<a href="#">175</a>	
 <b>ATTENTION:</b> Equipment damage and/or personal injury can result if this parameter is used in an inappropriate application. Do Not use this function without considering applicable local, national and international codes, standards, regulations or industry guidelines.						
175	<b>[Auto Rstrt Delay]</b> Sets the time between restart attempts when [Auto Rstrt Tries] is set to a value other than zero.	Default: 1.0 Secs Min/Max: 0.5/10800.0 Secs Units: 0.1 Secs	<a href="#">174</a>			

File	Group	No.	Parameter Name & Description See <a href="#">page 16</a> for symbol descriptions	Values	Related																											
DYNAMIC CONTROL	Restart Modes	178	<p><b>[Sleep-Wake Mode]</b></p> <p> Enables/disables the Sleep/Wake function. <b>Important:</b> When enabled, the following conditions must be met:</p> <ul style="list-style-type: none"> <li>A proper value must be programmed for [Sleep Level] &amp; [Wake Level].</li> <li>A speed reference must be selected in [Speed Ref A Sel].</li> <li>At least one of the following must be programmed (and input closed) in [Digital Inx Sel]; "Enable," "Stop=CF," "Run," "Run Forward," "Run Reverse."</li> </ul>	<p>Default: 0 "Disabled"</p> <p>Options: 0 "Disabled" 1 "Direct" (Enabled) 2 "Invert" (Enabled)<sup>(7)</sup></p>																												
		<p> <b>ATTENTION:</b> Enabling the Sleep-Wake function can cause unexpected machine operation during the Wake mode. Equipment damage and/or personal injury can result if this parameter is used in an inappropriate application. Do Not use this function without considering the information below and in <a href="#">Appendix C</a>. In addition, all applicable local, national &amp; international codes, standards, regulations or industry guidelines must be considered</p>																														
		<table border="1" style="width: 100%; border-collapse: collapse;"> <thead> <tr> <th style="width: 10%;">Input</th> <th style="width: 15%;">After Power-Up</th> <th style="width: 25%;">After a Drive Fault</th> <th colspan="2" style="width: 45%;">After a Stop Command</th> </tr> <tr> <td></td> <td></td> <td>Reset by Stop-CF, HIM or TB</td> <td>Reset by Clear Faults (TB)</td> <td>HIM or TB</td> </tr> </thead> <tbody> <tr> <td>Stop</td> <td>Stop Closed Wake Signal</td> <td>Stop Closed Wake Signal New Start or Run Cmd.<sup>(4)</sup></td> <td>Stop Closed Wake Signal</td> <td>Stop Closed <a href="#">Direct Mode</a> Analog Sig. &gt; Sleep Level<sup>(6)</sup> <a href="#">Invert Mode</a> Analog Sig. &lt; Sleep Level<sup>(6)</sup> New Start or Run Cmd.<sup>(4)</sup></td> </tr> <tr> <td>Enable</td> <td>Enable Closed Wake Signal<sup>(4)</sup></td> <td>Enable Closed Wake Signal New Start or Run Cmd.<sup>(4)</sup></td> <td>Enable Closed Wake Signal</td> <td>Enable Closed <a href="#">Direct Mode</a> Analog Sig. &gt; Sleep Level<sup>(6)</sup> <a href="#">Invert Mode</a> Analog Sig. &lt; Sleep Level<sup>(6)</sup> New Start or Run Cmd.<sup>(4)</sup></td> </tr> <tr> <td>Run Run For. Run Rev.</td> <td>Run Closed Wake Signal</td> <td>New Run Cmd.<sup>(5)</sup> Wake Signal</td> <td>Run Closed Wake Signal</td> <td>New Run Cmd.<sup>(5)</sup> Wake Signal</td> </tr> </tbody> </table>					Input	After Power-Up	After a Drive Fault	After a Stop Command				Reset by Stop-CF, HIM or TB	Reset by Clear Faults (TB)	HIM or TB	Stop	Stop Closed Wake Signal	Stop Closed Wake Signal New Start or Run Cmd. <sup>(4)</sup>	Stop Closed Wake Signal	Stop Closed <a href="#">Direct Mode</a> Analog Sig. > Sleep Level <sup>(6)</sup> <a href="#">Invert Mode</a> Analog Sig. < Sleep Level <sup>(6)</sup> New Start or Run Cmd. <sup>(4)</sup>	Enable	Enable Closed Wake Signal <sup>(4)</sup>	Enable Closed Wake Signal New Start or Run Cmd. <sup>(4)</sup>	Enable Closed Wake Signal	Enable Closed <a href="#">Direct Mode</a> Analog Sig. > Sleep Level <sup>(6)</sup> <a href="#">Invert Mode</a> Analog Sig. < Sleep Level <sup>(6)</sup> New Start or Run Cmd. <sup>(4)</sup>	Run Run For. Run Rev.	Run Closed Wake Signal	New Run Cmd. <sup>(5)</sup> Wake Signal	Run Closed Wake Signal	New Run Cmd. <sup>(5)</sup> Wake Signal	
		Input	After Power-Up	After a Drive Fault	After a Stop Command																											
		Reset by Stop-CF, HIM or TB	Reset by Clear Faults (TB)	HIM or TB																												
Stop	Stop Closed Wake Signal	Stop Closed Wake Signal New Start or Run Cmd. <sup>(4)</sup>	Stop Closed Wake Signal	Stop Closed <a href="#">Direct Mode</a> Analog Sig. > Sleep Level <sup>(6)</sup> <a href="#">Invert Mode</a> Analog Sig. < Sleep Level <sup>(6)</sup> New Start or Run Cmd. <sup>(4)</sup>																												
Enable	Enable Closed Wake Signal <sup>(4)</sup>	Enable Closed Wake Signal New Start or Run Cmd. <sup>(4)</sup>	Enable Closed Wake Signal	Enable Closed <a href="#">Direct Mode</a> Analog Sig. > Sleep Level <sup>(6)</sup> <a href="#">Invert Mode</a> Analog Sig. < Sleep Level <sup>(6)</sup> New Start or Run Cmd. <sup>(4)</sup>																												
Run Run For. Run Rev.	Run Closed Wake Signal	New Run Cmd. <sup>(5)</sup> Wake Signal	Run Closed Wake Signal	New Run Cmd. <sup>(5)</sup> Wake Signal																												
<p>(1) When power is cycled, if all of the above conditions are present after power is restored, restart will occur.</p> <p>(2) If all of the above conditions are present when [Sleep-Wake Mode] is "enabled," the drive will start.</p> <p>(3) Refer to Reference Control in the Installation Instructions for information on determining the active speed reference. The Sleep/Wake function and the speed reference can be assigned to the same input.</p> <p>(4) Command must be issued from HIM, TB or network.</p> <p>(5) Run Command must be cycled.</p> <p>(6) Signal does not need to be greater than wake level.</p> <p>(7) For Invert function, refer to [Analog In x Loss].</p>																																
		179	<p><b>[Sleep-Wake Ref]</b></p> <p> Selects the source of the input controlling the Sleep-Wake function.</p>	<p>Default: 2 "Analog In 2"</p> <p>Options: 1 "Analog In 1" 2 "Analog In 2"</p>																												
		180	<p><b>[Wake Level]</b></p> <p>Defines the analog input level that will start the drive.</p>	<p>Default: 6.000 mA, 6.000 Volts</p> <p>Min/Max: [Sleep Level]/20.000 mA 10.000 Volts</p> <p>Units: 0.001 mA 0.001 Volts</p>	<a href="#">181</a>																											
		181	<p><b>[Wake Time]</b></p> <p>Defines the amount of time at or above [Wake Level] before a Start is issued.</p>	<p>Default: 0.0 Secs</p> <p>Min/Max: 0.0/1000.0 Secs</p> <p>Units: 0.1 Secs</p>	<a href="#">180</a>																											

File	Group	No.	Parameter Name & Description See <a href="#">page 16</a> for symbol descriptions	Values	Related
DYNAMIC CONTROL	Restart Modes	182	<b>[Sleep Level]</b> Defines the analog input level that will stop the drive.	Default: 5.000 mA, 5.000 Volts Min/Max: 4.000 mA/[Wake Level] 0.000 Volts/[Wake Level] Units: 0.001 mA 0.001 Volts	<a href="#">183</a>
		183	<b>[Sleep Time]</b> Defines the amount of time at or below [Sleep Level] before a Stop is issued.	Default: 0.0 Secs Min/Max: 0.0/1000.0 Secs Units: 0.1 Secs	<a href="#">182</a>
	Power Loss	177	 <b>[Gnd Warn Level]</b> Sets the level at which a ground warning fault will occur. Configure with [Alarm Config 1].	Default: 3.0 Amps Min/Max: 1.0/5.0 Amps Units: 0.1 Amps	<a href="#">259</a>
		184	<b>[Power Loss Mode]</b> Sets the reaction to a loss of input power. Power loss is recognized when: <ul style="list-style-type: none"> <li>DC bus voltage is ≤ 73% of [DC Bus Memory] and [Power Loss Mode] is set to "Coast".</li> <li>DC bus voltage is ≤ 82% of [DC Bus Memory] and [Power Loss Mode] is set to "Decel".</li> </ul>	Default: 0 "Coast" Options: 0 "Coast" 1 "Decel" 2 "Continue" 3 "Coast Input" 4 "Decel Input" 5 "Decel 2 Stop" 	<a href="#">013</a> <a href="#">185</a>
		185	<b>[Power Loss Time]</b> Sets the time that the drive will remain in power loss mode before a fault is issued.	Default: 0.5 Secs Min/Max: 0.0/60.0 Secs Units: 0.1 Secs	<a href="#">184</a>
		186	<b>[Power Loss Level]</b> Sets the level at which the [Power Loss Mode] selection will occur.  The drive can use the percentages referenced in [Power Loss Mode] or a trigger point can be set for line loss detection as follows: $V_{\text{trigger}} = [\text{DC Bus Memory}] - [\text{Power Loss Level}]$ A digital input (programmed to "29, Pwr Loss Lvl") is used to toggle between fixed percentages and the detection level.	Default: Drive Rated Volts Min/Max: 0.0/999.9 VDC Units: 0.1 VDC	
		187	<b>[Load Loss Level]</b> Sets the percentage of motor nameplate torque (absolute value) at which a load loss alarm will occur.	Default: 200.0% Min/Max: 0.0/800.0% Units: 0.1%	<a href="#">211</a> <a href="#">259</a>
		188	<b>[Load Loss Time]</b> Sets the time that current is below the level set in [Load Loss Level] before a fault occurs.	Default: 0.0 Secs Min/Max: 0.0/300.0 Secs Units: 0.1 Secs	<a href="#">187</a>
	189	<b>[Shear Pin Time]</b> Sets the time that the drive is at or above current limit before a fault occurs. Zero disables this feature.	Default: 0.0 Secs Min/Max: 0.0/30.0 Secs Units: 0.1 Secs	<a href="#">238</a>	



**ATTENTION:** Drive damage can occur if proper input impedance is not provided as explained below.

If the value for [Power Loss Level] is greater than 18% of [DC Bus Memory], the user must provide a minimum line impedance to limit inrush current when the power line recovers. The input impedance should be equal to or greater than the equivalent of a 5% transformer with a VA rating 5 times the drives input VA rating.

# Utility File

File	Group	No.	Parameter Name & Description See <a href="#">page 16</a> for symbol descriptions	Values	Related								
UTILITY	Direction Config	190	<p><b>[Direction Mode]</b></p> <p>Selects method for changing direction.</p> <table border="1"> <tr> <th>Mode</th> <th>Direction Change</th> </tr> <tr> <td>Unipolar</td> <td>Drive Logic</td> </tr> <tr> <td>Bipolar</td> <td>Sign of Reference</td> </tr> <tr> <td>Reverse Dis</td> <td>Not Changeable</td> </tr> </table>	Mode	Direction Change	Unipolar	Drive Logic	Bipolar	Sign of Reference	Reverse Dis	Not Changeable	Default: 0 "Unipolar" Options: 0 "Unipolar" 1 "Bipolar" 2 "Reverse Dis"	<a href="#">320</a> ... <a href="#">327</a> <a href="#">361</a> ... <a href="#">366</a>
		Mode	Direction Change										
		Unipolar	Drive Logic										
Bipolar	Sign of Reference												
Reverse Dis	Not Changeable												
173	<p><b>[DPI Loss Action]</b></p> <p>Selects the speed reference that will be selected when a "DPI Px Loss" alarm occurs on the HIM that is providing the speed reference.</p> <p>"Hold OutFreq" (1) - selects the last HIM commanded speed reference.</p> <p>"Goto Preset1" (2) - selects the value that was saved in parameter 101 - [Preset Speed 1].</p> <p><b>Important:</b> The HIM reference is not retained if power is lost or removed.</p> <p><b>NOTE:</b> The user must verify that the HIM is not the sole stopping source and that an alternate stop source is available. If the HIM is the sole stopping source and it is disconnected, the drive will fault regardless of the configuration in parameter 238 [Fault Config 1].</p> <p><b>NOTE:</b> To avoid or override a DPI loss fault and keep the drive running, change the respective bit that corresponds to the DPI port (bits 16...18) in parameter 238 [Fault Config 1] to a value of "0" to disable the fault.</p>	Default: 0 "Disabled" Options: 0 "Disabled" 1 "Hold OutFreq" 2 "Goto Preset1"	<a href="#">238</a> <a href="#">259</a>										
192	<p><b>[Save HIM Ref]</b></p> <p>Enables HIM to control Speed Reference only or Reference, Start and Jog in Manual mode including two-wire control. Also enables a feature to save the present frequency reference value issued by the HIM to drive memory on power loss. Value is restored to the HIM on power up.</p> <p>Bit #</p> <p>Factory Default Bit Values</p> <p>At Powr Down                      1 = Save at Power Down                      0 = Do Not Save</p> <p>Manual Mode                      1 = HIM controls Reference, Start, Jog, Direction &amp; Clear Faults. Start &amp; Jog Disabled from all other Sources regardless of 2-Wire/3-Wire control selection. Must select Manual Mode on the HIM prior to setting this bit.                      0 = HIM controls only the Reference.</p> <p>HIM Disable                      1 = Start &amp; Jog on HIM Do Not Function in 3-Wire mode.                      0 = Start &amp; Jog on HIM will Function in 3-Wire mode.</p>												
		193	<p><b>[Man Ref Preload]</b></p> <p>Enables/disables a feature to automatically load the present "Auto" frequency reference value into the HIM when "Manual" is selected. Allows smooth speed transition from "Auto" to "Manual."</p>	Default: 0 "Disabled" Options: 0 "Disabled" 1 "Enabled"									

File	Group	No.	Parameter Name & Description See <a href="#">page 16</a> for symbol descriptions	Values	Related
UTILITY	MOP Config	194	<p><b>[Save MOP Ref]</b> Enables/disables the feature that saves the present MOP frequency reference at power down or at stop.</p> <p>Bit # Factory Default Bit Values</p>		
		195	<p><b>[MOP Rate]</b> Sets rate of change of the MOP reference in response to a digital input.</p>	Default: 1.0 Hz/s 30.0 RPM/s  Min/Max: 0.2/[Maximum Freq] 6.0/[Maximum Freq]  Units: 0.1 Hz/s 0.1 RPM/s	
	Drive Memory	196	<p><b>[Param Access Lvl]</b> Selects the parameter display level viewable on the HIM.</p> <ul style="list-style-type: none"> <li>• Basic = Reduced parameter set</li> <li>• Advanced = Full parameter set</li> <li>• Reserved = Full parameter set and Engineering parameters (refer to the PowerFlex Reference Manual).</li> </ul> <p>This parameter is not reset when "Reset to Defaults" is selected.</p>	Default: 0 "Basic"  Options: 0 "Basic" 1 "Advanced" 2 "Reserved"	
		197	<p><b>[Reset To Defaults]</b> Resets parameters to factory defaults except [Mtr NP Pwr Units], [Speed Units], [Param Access Lvl], [Language], [Voltage Class] &amp; [TorqProve Cnfg] (params 46, 79, 196, 201, 202 &amp; 600).</p> <ul style="list-style-type: none"> <li>• Option 1 resets parameters to factory defaults based on [Voltage Class].</li> <li>• Options 2 &amp; 3 will set [Voltage Class] to low or high and reset parameters to corresponding factory defaults.</li> </ul> <p><b>Important:</b> Frames 5 &amp; 6 - the internal fan voltage may have to be changed when using Option 2 or 3. See "Selecting /Verifying Fan Voltage" in the Installation Instructions, publication <a href="#">20B-IN0019</a>.</p>	Default: 0 "Ready"  Options: 0 "Ready" 1 "Factory" 2 "Low Voltage" 3 "High Voltage"	<a href="#">041</a> ... <a href="#">047</a> <a href="#">054</a> <a href="#">055</a> <a href="#">062</a> <a href="#">063</a> <a href="#">069</a> ... <a href="#">072</a> <a href="#">082</a> <a href="#">148</a> <a href="#">158</a>
		198	<p><b>[Load Frm Usr Set]</b> Loads a previously saved set of parameter values from a selected user set location in drive nonvolatile memory to active drive memory.</p>	Default: 0 "Ready"  Options: 0 "Ready" 1 "User Set 1" 2 "User Set 2" 3 "User Set 3"	<a href="#">199</a>
		199	<p><b>[Save To User Set]</b> Saves the parameter values in active drive memory to a user set in drive nonvolatile memory.</p>	Default: 0 "Ready"  Options: 0 "Ready" 1 "User Set 1" 2 "User Set 2" 3 "User Set 3"	<a href="#">198</a>
		200	<p><b>[Reset Meters]</b> Resets selected meters to zero.</p>	Default: 0 "Ready"  Options: 0 "Ready" 1 "MWh" 2 "Elapsed Time"	

File	Group	No.	Parameter Name & Description See <a href="#">page 16</a> for symbol descriptions	Values	Related
UTILITY	Drive Memory	201	<p><b>[Language]</b></p> <p>Selects the display language when using an LCD HIM. This parameter is not functional with an LED HIM.</p> <p>Options 6, 8 and 9 are "Reserved."</p> <p>This parameter is not reset when "Reset to Defaults" is selected.</p>	<p>Default: 0 "Not Selected"</p> <p>Options: 0 "Not Selected" 1 "English" 2 "Francais" 3 "Español" 4 "Italiano" 5 "Deutsch" 7 "Português" 10 "Nederlands"</p>	
		202	<p><b>[Voltage Class]</b></p> <p>Configures the drive current rating and associates it with the selected voltage (i.e. 400 or 480V). Normally used when downloading parameter sets. Min/Max &amp; Default values will be changed for parameters; 41-47, 54, 55, 62, 63, 69, 70-72, 82, 148, 158.</p> <p>This parameter is not reset when "Reset to Defaults" is selected.</p> <p><b>Important:</b> Frames 5...10 - If changing voltage class, verify correct voltage on the fan transformer. See "Selecting /Verifying Fan Voltage" in the Installation Instructions, publication <a href="#">20B-IN0019</a>.</p>	<p>Default: Based on Drive Cat. No.</p> <p>Options: 2 "Low Voltage" 3 "High Voltage" 4 "Reserved" 5 "Reserved"</p>	<p><a href="#">041</a></p> <p>...</p> <p><a href="#">047</a></p> <p><a href="#">054</a></p> <p><a href="#">055</a></p> <p><a href="#">062</a></p> <p><a href="#">063</a></p> <p><a href="#">069</a></p> <p>...</p> <p><a href="#">072</a></p> <p><a href="#">082</a></p> <p><a href="#">148</a></p> <p><a href="#">158</a></p>
		203	<p><b>[Drive Checksum]</b></p> <p>Provides a checksum value that indicates whether or not a change in drive programming has occurred.</p>	<p>Default: Read Only</p> <p>Min/Max: 0/65535</p> <p>Units: 1</p>	
		204	<p><b>[Dyn UsrSet Cnfg]</b></p> <p>Enables/Disables dynamic selection of user parameter sets.</p> <p><b>Important:</b> In dynamic mode, changes to the parameters are not saved to nonvolatile storage. Switching user sets restores the values last saved before enabling dynamic mode.</p> <p>Factory Default Bit Values</p> <p>Dynamic Mode _____ 1 = Enabled 0 = Disabled</p> <p>Ctrl Source _____ 1 = [Dyn UsrSet Sel] 0 = Digital Inputs</p> <p>x = Reserved</p>		
		205	<p><b>[Dyn UsrSet Sel]</b></p> <p>Selects user set if [Dyn UsrSet Cnfg] = xxxx xx11.</p> <p><b>Important:</b> All digital input selections (parameters 361-366) must be identical in all three user sets for proper Dynamic User Set operation (even if only two sets are used).</p> <p>Factory Default Bit Values</p> <p>1 = Enabled 0 = Disabled x = Reserved</p> <p>0 0 User Set 1 0 1 User Set 2 1 0 User Set 3 1 1 User Set 3</p>		
		206	<p><b>[Dyn UserSet Actv]</b></p> <p>Indicates the active user set and if the operation is dynamic or normal.</p> <p>Factory Default Bit Values</p> <p>1 = Condition True 0 = Condition False x = Reserved</p>	Read Only	

File	Group	No.	Parameter Name & Description See page 16 for symbol descriptions	Values	Related																																																																																																																																																																	
UTILITY	Diagnostics	209	<b>[Drive Status 1]</b> Present operating condition of the drive.	Read Only	210																																																																																																																																																																	
		<table border="1" style="margin-left: 20px;"> <tr> <td>15</td><td>14</td><td>13</td><td>12</td><td>11</td><td>10</td><td>9</td><td>8</td><td>7</td><td>6</td><td>5</td><td>4</td><td>3</td><td>2</td><td>1</td><td>0</td> </tr> <tr> <td>0</td><td>0</td><td>0</td><td>0</td><td>1</td><td>1</td><td>1</td><td>0</td><td>0</td><td>0</td><td>0</td><td>0</td><td>1</td><td>1</td><td>0</td><td>0</td> </tr> </table> <p>1 = Condition True 0 = Condition False x = Reserved</p>					15	14	13	12	11	10	9	8	7	6	5	4	3	2	1	0	0	0	0	0	1	1	1	0	0	0	0	0	1	1	0	0																																																																																																																																
		15	14	13	12	11	10	9	8	7	6	5	4	3	2	1	0																																																																																																																																																					
0	0	0	0	1	1	1	0	0	0	0	0	1	1	0	0																																																																																																																																																							
<table border="1" style="width: 100%; border-collapse: collapse;"> <thead> <tr> <th colspan="4">Bits<sup>(2)</sup></th> <th>Description</th> <th colspan="3">Bits<sup>(1)</sup></th> <th>Description</th> </tr> <tr> <th>15</th><th>14</th><th>13</th><th>12</th> <th></th> <th>11</th><th>10</th><th>9</th> <th></th> </tr> </thead> <tbody> <tr><td>0</td><td>0</td><td>0</td><td>0</td><td>Ref A Auto</td><td>0</td><td>0</td><td>0</td><td>Port 0 (TB)</td></tr> <tr><td>0</td><td>0</td><td>0</td><td>1</td><td>Ref B Auto</td><td>0</td><td>0</td><td>1</td><td>Port 1</td></tr> <tr><td>0</td><td>0</td><td>1</td><td>0</td><td>Preset 2 Auto</td><td>0</td><td>1</td><td>0</td><td>Port 2</td></tr> <tr><td>0</td><td>0</td><td>1</td><td>1</td><td>Preset 3 Auto</td><td>0</td><td>1</td><td>1</td><td>Port 3</td></tr> <tr><td>0</td><td>1</td><td>0</td><td>0</td><td>Preset 4 Auto</td><td>1</td><td>0</td><td>0</td><td>Port 4</td></tr> <tr><td>0</td><td>1</td><td>0</td><td>1</td><td>Preset 5 Auto</td><td>1</td><td>0</td><td>1</td><td>Port 5</td></tr> <tr><td>0</td><td>1</td><td>1</td><td>0</td><td>Preset 6 Auto</td><td>1</td><td>1</td><td>0</td><td>Port 6</td></tr> <tr><td>0</td><td>1</td><td>1</td><td>1</td><td>Preset 7 Auto</td><td>1</td><td>1</td><td>1</td><td>No Local Control</td></tr> <tr><td>1</td><td>0</td><td>0</td><td>0</td><td>TB Manual</td><td></td><td></td><td></td><td></td></tr> <tr><td>1</td><td>0</td><td>0</td><td>1</td><td>Port 1 Manual</td><td></td><td></td><td></td><td></td></tr> <tr><td>1</td><td>0</td><td>1</td><td>0</td><td>Port 2 Manual</td><td></td><td></td><td></td><td></td></tr> <tr><td>1</td><td>0</td><td>1</td><td>1</td><td>Port 3 Manual</td><td></td><td></td><td></td><td></td></tr> <tr><td>1</td><td>1</td><td>0</td><td>0</td><td>Port 4 Manual</td><td></td><td></td><td></td><td></td></tr> <tr><td>1</td><td>1</td><td>0</td><td>1</td><td>Port 5 Manual</td><td></td><td></td><td></td><td></td></tr> <tr><td>1</td><td>1</td><td>1</td><td>0</td><td>Port 6 Manual</td><td></td><td></td><td></td><td></td></tr> <tr><td>1</td><td>1</td><td>1</td><td>1</td><td>Jog Ref</td><td></td><td></td><td></td><td></td></tr> </tbody> </table>					Bits <sup>(2)</sup>				Description	Bits <sup>(1)</sup>			Description	15	14	13	12		11	10	9		0	0	0	0	Ref A Auto	0	0	0	Port 0 (TB)	0	0	0	1	Ref B Auto	0	0	1	Port 1	0	0	1	0	Preset 2 Auto	0	1	0	Port 2	0	0	1	1	Preset 3 Auto	0	1	1	Port 3	0	1	0	0	Preset 4 Auto	1	0	0	Port 4	0	1	0	1	Preset 5 Auto	1	0	1	Port 5	0	1	1	0	Preset 6 Auto	1	1	0	Port 6	0	1	1	1	Preset 7 Auto	1	1	1	No Local Control	1	0	0	0	TB Manual					1	0	0	1	Port 1 Manual					1	0	1	0	Port 2 Manual					1	0	1	1	Port 3 Manual					1	1	0	0	Port 4 Manual					1	1	0	1	Port 5 Manual					1	1	1	0	Port 6 Manual					1	1	1	1	Jog Ref				
Bits <sup>(2)</sup>				Description	Bits <sup>(1)</sup>			Description																																																																																																																																																														
15	14	13	12		11	10	9																																																																																																																																																															
0	0	0	0	Ref A Auto	0	0	0	Port 0 (TB)																																																																																																																																																														
0	0	0	1	Ref B Auto	0	0	1	Port 1																																																																																																																																																														
0	0	1	0	Preset 2 Auto	0	1	0	Port 2																																																																																																																																																														
0	0	1	1	Preset 3 Auto	0	1	1	Port 3																																																																																																																																																														
0	1	0	0	Preset 4 Auto	1	0	0	Port 4																																																																																																																																																														
0	1	0	1	Preset 5 Auto	1	0	1	Port 5																																																																																																																																																														
0	1	1	0	Preset 6 Auto	1	1	0	Port 6																																																																																																																																																														
0	1	1	1	Preset 7 Auto	1	1	1	No Local Control																																																																																																																																																														
1	0	0	0	TB Manual																																																																																																																																																																		
1	0	0	1	Port 1 Manual																																																																																																																																																																		
1	0	1	0	Port 2 Manual																																																																																																																																																																		
1	0	1	1	Port 3 Manual																																																																																																																																																																		
1	1	0	0	Port 4 Manual																																																																																																																																																																		
1	1	0	1	Port 5 Manual																																																																																																																																																																		
1	1	1	0	Port 6 Manual																																																																																																																																																																		
1	1	1	1	Jog Ref																																																																																																																																																																		
210	<b>[Drive Status 2]</b> Present operating condition of the drive.	Read Only	209																																																																																																																																																																			
<table border="1" style="margin-left: 20px;"> <tr> <td>15</td><td>14</td><td>13</td><td>12</td><td>11</td><td>10</td><td>9</td><td>8</td><td>7</td><td>6</td><td>5</td><td>4</td><td>3</td><td>2</td><td>1</td><td>0</td> </tr> <tr> <td>0</td><td>0</td><td>0</td><td>0</td><td>0</td><td>0</td><td>0</td><td>0</td><td>0</td><td>0</td><td>0</td><td>0</td><td>0</td><td>0</td><td>0</td><td>0</td> </tr> </table> <p>1 = Condition True 0 = Condition False x = Reserved</p>					15	14	13	12	11	10	9	8	7	6	5	4	3	2	1	0	0	0	0	0	0	0	0	0	0	0	0	0	0	0	0	0																																																																																																																																		
15	14	13	12	11	10	9	8	7	6	5	4	3	2	1	0																																																																																																																																																							
0	0	0	0	0	0	0	0	0	0	0	0	0	0	0	0																																																																																																																																																							
211	<b>[Drive Alarm 1]</b> Alarm conditions that currently exist in the drive. "Prof SetHome" will be set if the alarm is configured in [Alarm Config 1], "Prof/Indexer" is configured in [Speed/Torque Mod] and the homing routine has not been successfully completed.	Read Only	212																																																																																																																																																																			
<table border="1" style="margin-left: 20px;"> <tr> <td>31</td><td>30</td><td>29</td><td>28</td><td>27</td><td>26</td><td>25</td><td>24</td><td>23</td><td>22</td><td>21</td><td>20</td><td>19</td><td>18</td><td>17</td><td>16</td> </tr> <tr> <td>x</td><td>x</td><td>x</td><td>x</td><td>x</td><td>x</td><td>x</td><td>x</td><td>0</td><td>0</td><td>0</td><td>0</td><td>x</td><td>0</td><td>0</td><td>0</td> </tr> </table> <p>1 = Condition True 0 = Condition False x = Reserved</p> <p>(1) Firmware 6.002 and later. (2) Firmware 9.001 and later.</p>					31	30	29	28	27	26	25	24	23	22	21	20	19	18	17	16	x	x	x	x	x	x	x	x	0	0	0	0	x	0	0	0																																																																																																																																		
31	30	29	28	27	26	25	24	23	22	21	20	19	18	17	16																																																																																																																																																							
x	x	x	x	x	x	x	x	0	0	0	0	x	0	0	0																																																																																																																																																							

File	Group	No.	Parameter Name & Description See <a href="#">page 16</a> for symbol descriptions	Values	Related	
UTILITY	Diagnostics	212	<b>[Drive Alarm 2]</b> Alarm conditions that currently exist in the drive.	Read Only	<a href="#">211</a>	
		213	<b>[Speed Ref Source]</b> Displays the source of the speed reference to the drive.  (1) Options not listed are reserved for future use.	Default:      Read Only Options:      0 "PI Output" (1)             1 "Analog In 1" 2 "Analog In 2" 7 "Pulse In" 8 "Encoder" 9 "MOP Level" 10 "Jog Speed 1" 11-17 "Preset Spd1-7" 18-22 "DPI Port 1-5" 24 "Autotune" 25 "Jog Speed 2" 26-29 "Scale Block 1-4" 30 "Pos/Spd Prof" 31 "Position Reg" 32 "Micro Pos" 33 "Homing" 34 "Decel Switch" 35 "End Switch" 36 "Unipolar Lim" 37 "Rev Dis Lim" 38 "Max Spd Lim" 39 "Min Spd Lim" 40 "Rev Spd Lim" 41 "Load Trq Lim" 43 "HighRes Ref"	<a href="#">090</a> <a href="#">093</a> <a href="#">096</a> <a href="#">101</a>	
214	<b>[Start Inhibits]</b> Displays the inputs currently preventing the drive from starting.	Read Only				
			Description			
			Fast Brake, bit 7 Either a digital input is configured for Fast Stop and is enabled or [TorqProbe Setup], parameter 601, bit 0 is enabled.			



File	Group	No.	Parameter Name & Description See <a href="#">page 16</a> for symbol descriptions	Values	Related	
UTILITY	Diagnostics	215	<b>[Last Stop Source]</b> Displays the source that initiated the most recent stop sequence. It will be cleared (set to 0) during the next start sequence. (1) Options not listed are reserved for future use.	Default: Read Only Options: (1) 0 "Pwr Removed" 1-5 "DPI Port 1-5" 7 "Digital In" 8 "Fault" 9 "Not Enabled" 10 "Sleep" 11 "Jog" 12 "Autotune" 13 "Precharge"	<a href="#">361</a> <a href="#">362</a> <a href="#">363</a> <a href="#">364</a> <a href="#">365</a> <a href="#">366</a>	
		216	<b>[Dig In Status]</b> Status of the digital inputs.	Read Only	<a href="#">361</a> ... <a href="#">366</a>	
		217	<b>[Dig Out Status]</b> Status of the digital outputs.	Read Only	<a href="#">380</a> ... <a href="#">384</a>	
		218	<b>[Drive Temp]</b> Present operating temperature of the drive power section.	Default: Read Only Min/Max: 0.0/100.0% Units: 0.1%		
		219	<b>[Drive OL Count]</b> Accumulated percentage of drive overload. Continuously operating the drive over 100% of its rating will increase this value to 100% and cause a drive fault or foldback depending on the setting of [Drive OL Mode].	Default: Read Only Min/Max: 0.0/100.0% Units: 0.1%	<a href="#">150</a>	
220	<b>[Motor OL Count]</b> Accumulated percentage of motor overload. Continuously operating the motor over 100% of the motor overload setting will increase this value to 100% and cause a drive fault. Refer to <a href="#">page 123</a> .	Default: Read Only Min/Max: 0.0/100.0% Units: 0.1%	<a href="#">047</a> <a href="#">048</a>			
221	<b>[Mtr OL Trip Time]</b> Amount of time before a Drive Overload fault (F64) occurs if the load condition remains constant. A value of 99999 means that the drive is operating under the overload level.	Default: Read Only Min/Max: 0/99999 Units: 1	<a href="#">220</a>			

File	Group	No.	Parameter Name & Description See <a href="#">page 16</a> for symbol descriptions	Values	Related	
UTILITY	Diagnostics	222	<b>v6 [Drive Status 3]</b> Indicates if a device has manual control of the speed reference or if a "Fast Brake" is in progress.	Read Only 	1 = Condition True 0 = Condition False x = Reserved	
		223	<b>v6 [Status 3 @ Fault]</b> Captures and displays [Drive Status 3] bit pattern at the time of the last fault.	Read Only 	1 = Condition True 0 = Condition False x = Reserved	<a href="#">222</a>
		224	<b>[Fault Speed]</b> Captures and displays the output speed of the drive at the time of the last fault.	Default: Read Only Min/Max: 0.0/+[Maximum Freq] 0.0/+[Maximum Speed] Units: 0.1 Hz 0.1 RPM	<a href="#">079</a> <a href="#">225</a> ... <a href="#">230</a>	
		225	<b>[Fault Amps]</b> Captures and displays motor amps at the time of the last fault.	Default: Read Only Min/Max: 0.0/[Rated Amps] x 2 Units: 0.1 Amps	<a href="#">224</a> ... <a href="#">230</a>	
		226	<b>[Fault Bus Volts]</b> Captures and displays the DC bus voltage of the drive at the time of the last fault.	Default: Read Only Min/Max: 0.0/Max Bus Volts Units: 0.1 VDC	<a href="#">224</a> ... <a href="#">230</a>	
		227	<b>[Status 1 @ Fault]</b> Captures and displays [Drive Status 1] bit pattern at the time of the last fault.	Read Only 	1 = Condition True 0 = Condition False x = Reserved	<a href="#">209</a> <a href="#">224</a> ... <a href="#">230</a>
		228	<b>[Status 2 @ Fault]</b> Captures and displays [Drive Status 2] bit pattern at the time of the last fault.	Read Only 	1 = Condition True 0 = Condition False x = Reserved	<a href="#">210</a> <a href="#">224</a> ... <a href="#">230</a>



File	Group	No.	Parameter Name & Description See page 16 for symbol descriptions	Values	Related
UTILITY	Diagnostics	229	<p><b>[Alarm 1 @ Fault]</b></p> <p>Captures and displays [Drive Alarm 1] at the time of the last fault.</p> <p>(1) Firmware 6.002 and later. (2) Firmware 9.001 and later.</p>	Read Only	<a href="#">211</a> <a href="#">224</a> ... <a href="#">230</a>
		230	<p><b>[Alarm 2 @ Fault]</b></p> <p>Captures and displays [Drive Alarm 2] at the time of the last fault.</p>	Read Only	<a href="#">212</a> <a href="#">224</a> ... <a href="#">230</a>
		234 236	<p><b>[Testpoint 1 Sel]</b> <b>[Testpoint 2 Sel]</b></p> <p>Selects the function whose value is displayed value in [Testpoint x Data]. These are internal values that are not accessible through parameters. See <a href="#">Testpoint Codes and Functions on page 96</a> for a listing of available codes and functions.</p>	Default: 499 Min/Max: 0/65535 Units: 1	
		235 237	<p><b>[Testpoint 1 Data]</b> <b>[Testpoint 2 Data]</b></p> <p>The present value of the function selected in [Testpoint x Sel].</p>	Default: Read Only Min/Max: -/+2147483648 Units: 1	







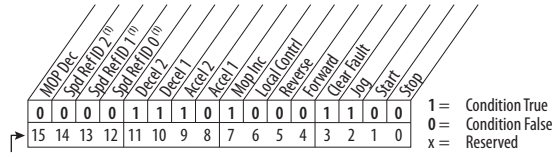

File	Group	No.	Parameter Name & Description	Values	Related																																																																																																				
UTILITY	Faults	238	<p><b>[Fault Config 1]</b></p> <p>Enables/disables annunciation of the listed faults.</p> <table border="1"><tr><td></td><td>PTC F/W</td><td>Dir Phase Loss (4)</td><td>Shear Pin Acc (2)</td><td>Load Loss</td><td>In Phase Loss (1)</td><td>Motor Therm</td><td>Descr Inhibit</td><td>Output Trips</td><td>Shear Pin</td><td>Motor Overld</td><td>HS Low Temp (3)</td><td>UnderVoltage</td><td>Power Loss</td><td></td><td></td></tr><tr><td></td><td>x</td><td>x</td><td>0</td><td>0</td><td>x</td><td>0</td><td>0</td><td>0</td><td>1</td><td>0</td><td>1</td><td>1</td><td>1</td><td>0</td><td></td></tr><tr><td></td><td>15</td><td>14</td><td>13</td><td>12</td><td>11</td><td>10</td><td>9</td><td>8</td><td>7</td><td>6</td><td>5</td><td>4</td><td>3</td><td>2</td><td>1</td><td>0</td></tr></table> <p>Bit #</p> <p>Factory Default Bit Values</p> <table border="1"><tr><td></td><td></td><td></td><td></td><td></td><td></td><td></td><td></td><td></td><td></td><td></td><td></td><td></td><td>DPI P3 Loss (5)</td><td>DPI P2 Loss (5)</td><td>DPI P1 Loss (5)</td><td></td></tr><tr><td></td><td>x</td><td>x</td><td>x</td><td>x</td><td>x</td><td>x</td><td>x</td><td>x</td><td>x</td><td>x</td><td>x</td><td>x</td><td>1</td><td>1</td><td>1</td><td></td></tr><tr><td></td><td>31</td><td>30</td><td>29</td><td>28</td><td>27</td><td>26</td><td>25</td><td>24</td><td>23</td><td>22</td><td>21</td><td>20</td><td>19</td><td>18</td><td>17</td><td>16</td></tr></table> <p>Bit #</p> <p>(1) Default is "1" for Frames 8-10. (2) When enabled, the drive ignores the shear pin fault during any accel/decel. (3) Firmware 6.002 and later. (4) If Torque Prove is enabled, Output Phase Loss will always be performed. (5) Firmware 9.001 and later. When these faults are disabled, always change parameter 173 [DPI Loss Action] to a value of "1" or "2."</p> <p>1 = Enabled 0 = Disabled x = Reserved</p>		PTC F/W	Dir Phase Loss (4)	Shear Pin Acc (2)	Load Loss	In Phase Loss (1)	Motor Therm	Descr Inhibit	Output Trips	Shear Pin	Motor Overld	HS Low Temp (3)	UnderVoltage	Power Loss				x	x	0	0	x	0	0	0	1	0	1	1	1	0			15	14	13	12	11	10	9	8	7	6	5	4	3	2	1	0														DPI P3 Loss (5)	DPI P2 Loss (5)	DPI P1 Loss (5)			x	x	x	x	x	x	x	x	x	x	x	x	1	1	1			31	30	29	28	27	26	25	24	23	22	21	20	19	18	17	16		
			PTC F/W	Dir Phase Loss (4)	Shear Pin Acc (2)	Load Loss	In Phase Loss (1)	Motor Therm	Descr Inhibit	Output Trips	Shear Pin	Motor Overld	HS Low Temp (3)	UnderVoltage	Power Loss																																																																																										
			x	x	0	0	x	0	0	0	1	0	1	1	1	0																																																																																									
			15	14	13	12	11	10	9	8	7	6	5	4	3	2	1	0																																																																																							
															DPI P3 Loss (5)	DPI P2 Loss (5)	DPI P1 Loss (5)																																																																																								
	x	x	x	x	x	x	x	x	x	x	x	x	1	1	1																																																																																										
	31	30	29	28	27	26	25	24	23	22	21	20	19	18	17	16																																																																																									
240	<p><b>[Fault Clear]</b></p> <p>Resets a fault and clears the fault queue.</p>	Default: 0 Options: 0, 1, 2	“Ready” “Ready” “Clear Faults” “Clr Flt Que”																																																																																																						
241	<p><b>[Fault Clear Mode]</b></p> <p>Enables/disables a fault reset (clear faults) attempt from any source. This does not apply to fault codes which are cleared indirectly via other actions.</p>	Default: 1 Options: 0, 1	“Enabled” “Disabled” “Enabled”																																																																																																						
242	<p><b>[Power Up Marker]</b></p> <p>Elapsed hours since initial drive power up. This value will rollover to 0 after the drive has been powered on for more than the max value shown. For relevance to most recent power up see [Fault x Time].</p>	Default: Read Only Min/Max: 0.0000/214748.3647 Hr Units: 0.1 Hr		<a href="#">244</a> <a href="#">246</a> <a href="#">248</a> <a href="#">250</a> <a href="#">252</a> <a href="#">254</a> <a href="#">256</a> <a href="#">258</a>																																																																																																					
243 245 247 249 251 253 255 257	<p><b>[Fault 1 Code]</b> <b>[Fault 2 Code]</b> <b>[Fault 3 Code]</b> <b>[Fault 4 Code]</b> <b>[Fault 5 Code]</b> <b>[Fault 6 Code]</b> <b>[Fault 7 Code]</b> <b>[Fault 8 Code]</b></p> <p>A code that represents the fault that tripped the drive. The codes will appear in these parameters in the order they occur ([Fault 1 Code] = the most recent fault).</p>	Default: Read Only Min/Max: 0/65535 Units: 0																																																																																																							

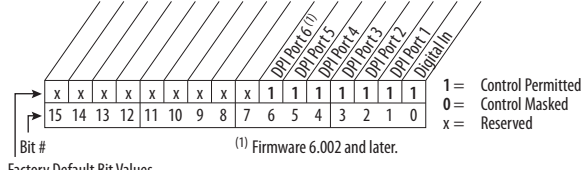
File	Group	No.	Parameter Name & Description See <a href="#">page 16</a> for symbol descriptions	Values	Related
UTILITY	Faults	244	<p>The time between <b>initial</b> drive power up and the occurrence of the associated trip fault. Can be compared to [Power Up Marker] for the time from the most recent power up.                      [Fault x Time] – [Power Up Marker] = Time difference to the most recent power up. A negative value indicates fault occurred before most recent power up. A positive value indicates fault occurred after most recent power up.</p> <p>To convert this value to the number days, hours, minutes and seconds, the following formula can be used:</p> <p>Fault x Time / 24 hours = (# of days).(remaining time)                      Remaining Time x 24 hours = (# of hours)                      Remaining Time x 60 minutes = (# of minutes).(remaining time)                      Remaining Time x 60 seconds = (# of seconds)                      Result = (# of days).(# of hours).(# of minutes).(# of seconds)</p> <p>Example: 1909.2390 Hrs / 1 Day/24 Hrs = 79.551625 Days                      0.551625 Days x 24 Hrs/Day = 13.239 Hrs                      0.239 Hrs x 60 Min/Hr = 14.34 Min                      0.34 Min x 60 Sec/Min = 20.4 Secs</p>	Default: Read Only Min/Max: 0.0000/214748.3647 Hr Units: 0.0001 Hr	<a href="#">242</a>
		246			
248					
250					
252					
254					
256					
258					
UTILITY	Alarms	259	<p><b>[Alarm Config 1]</b>                      Enables/disables alarm conditions that will initiate an active drive alarm.</p> <p>Bit #</p> <p>(1) Firmware 6.002 and later.                      (2) Firmware 9.001 and later.</p> <p>Description                      OW Trq Level, bit 19 For the Rod Torque Process Display to work, the Oil Well Torque Level must be enabled.</p>		
		261	<p><b>[Alarm Clear]</b>                      Resets all [Alarm 1-8 Code] parameters to zero.</p>	Default: 0 "Ready" Options: 0 "Ready" 1 "Clr Alrm Que"	<a href="#">262</a> <a href="#">263</a> <a href="#">264</a> <a href="#">265</a> <a href="#">266</a> <a href="#">267</a> <a href="#">268</a> <a href="#">269</a>



File	Group	No.	Parameter Name & Description See <a href="#">page 16</a> for symbol descriptions	Values	Related		
UTILITY	Alarms	262	[Alarm 1 Code]	Default: Read Only	<a href="#">261</a>		
		263	[Alarm 2 Code]	Min/Max: 0/65535			
		264	[Alarm 3 Code]	Units: 1			
		265	[Alarm 4 Code]				
		266	[Alarm 5 Code]				
		267	[Alarm 6 Code]				
		268	[Alarm 7 Code]				
		269	[Alarm 8 Code]				
				A code that represents a drive alarm. The codes will appear in the order they occur (first 4 alarms in – first 4 out alarm queue). A time stamp is not available with alarms.			
	Scaled Blocks		476	[Scale1 In Value]	Default: 0.0		
			482	[Scale2 In Value]	Min/Max: –/+32767.000		
			488	[Scale3 In Value]	Units: 0.1 (Scale 1 & 2)		
			494	[Scale4 In Value]	0.001 (Scale 3 & 4)		
					Displays the value of the signal being sent to [ScaleX In Value] using a link.		
				477	[Scale1 In Hi]	Default: 0.0	
				483	[Scale2 In Hi]	Min/Max: –/+32767.000	
				489	[Scale3 In Hi]	Units: 0.1 (Scale 1 & 2)	
				495	[Scale4 In Hi]	0.001 (Scale 3 & 4)	
					Scales the upper value of [ScaleX In Value].		
				478	[Scale1 In Lo]	Default: 0.0	
484				[Scale2 In Lo]	Min/Max: –/+32767.000		
490	[Scale3 In Lo]			Units: 0.1 (Scale 1 & 2)			
496	[Scale4 In Lo]			0.001 (Scale 3 & 4)			
			Scales the lower value of [ScaleX In Value].				
		479	[Scale1 Out Hi]	Default: 0.0			
		485	[Scale2 Out Hi]	Min/Max: –/+32767.000			
		491	[Scale3 Out Hi]	Units: 0.1 (Scale 1 & 2)			
		497	[Scale4 Out Hi]	0.001 (Scale 3 & 4)			
			Scales the upper value of [ScaleX Out Value].				
		480	[Scale1 Out Lo]	Default: 0.0			
		486	[Scale2 Out Lo]	Min/Max: –/+32767.000			
		492	[Scale3 Out Lo]	Units: 0.1 (Scale 1 & 2)			
		498	[Scale4 Out Lo]	0.001 (Scale 3 & 4)			
			Scales the lower value of [ScaleX Out Value].				
		481	[Scale1 Out Value]	Default: Read Only			
		487	[Scale2 Out Value]	Min/Max: –/+32767.000			
		493	[Scale3 Out Value]	Units: 0.1 (Scale 1 & 2)			
		499	[Scale4 Out Value]	0.001 (Scale 3 & 4)			
			Value of the signal being sent out of the Universal Scale block. Typically this value is used as the source of information and will be linked to another parameter.				

# Communication File

File	Group	No.	Parameter Name & Description See <a href="#">page 16</a> for symbol descriptions	Values	Related																																							
COMMUNICATION	Comm Control	270	<b>[DPI Baud Rate]</b>  Sets the baud rate for attached drive peripherals. When changing this value the drive must be reset for the change to take affect. Use 125 kbps with cable lengths greater than 75 m (246 ft). 500 kbps can be used for lengths less than 75 m (246 ft).	Default: 1 "500 kbps" Options: 0 "125 kbps" 1 "500 kbps"																																								
		271	<b>[Drive Logic Rslt]</b> Read Only The final logic command resulting from the combination of all DPI and discrete inputs. This parameter has the same structure as the product-specific logic command received via DPI and is used in peer to peer communications.																																									
																																												
		Bit #																																										
		<table border="1"> <thead> <tr> <th>Bits<sup>(1)</sup></th> <th colspan="2">Description</th> </tr> <tr> <th>14</th> <th>13</th> <th>12</th> </tr> </thead> <tbody> <tr> <td>0</td> <td>0</td> <td>0</td> <td>Last commanded speed source/no command on powerup</td> </tr> <tr> <td>0</td> <td>0</td> <td>1</td> <td>Ref A Auto</td> </tr> <tr> <td>0</td> <td>1</td> <td>0</td> <td>Ref B Auto</td> </tr> <tr> <td>0</td> <td>1</td> <td>1</td> <td>Preset 3 Auto</td> </tr> <tr> <td>1</td> <td>0</td> <td>0</td> <td>Preset 4 Auto</td> </tr> <tr> <td>1</td> <td>0</td> <td>1</td> <td>Preset 5 Auto</td> </tr> <tr> <td>1</td> <td>1</td> <td>0</td> <td>Preset 6 Auto</td> </tr> <tr> <td>1</td> <td>1</td> <td>1</td> <td>Preset 7 Auto</td> </tr> </tbody> </table>			Bits <sup>(1)</sup>	Description		14	13	12	0	0	0	Last commanded speed source/no command on powerup	0	0	1	Ref A Auto	0	1	0	Ref B Auto	0	1	1	Preset 3 Auto	1	0	0	Preset 4 Auto	1	0	1	Preset 5 Auto	1	1	0	Preset 6 Auto	1	1	1	Preset 7 Auto		
		Bits <sup>(1)</sup>	Description																																									
		14	13	12																																								
		0	0	0	Last commanded speed source/no command on powerup																																							
0	0	1	Ref A Auto																																									
0	1	0	Ref B Auto																																									
0	1	1	Preset 3 Auto																																									
1	0	0	Preset 4 Auto																																									
1	0	1	Preset 5 Auto																																									
1	1	0	Preset 6 Auto																																									
1	1	1	Preset 7 Auto																																									
272	<b>[Drive Ref Rslt]</b> Present frequency reference scaled as a DPI reference for peer to peer communications. The value shown is the value prior to the accel/decel ramp and the corrections supplied by slip comp, PI, etc.	Default: Read Only Min/Max: -/+2147483647 Units: 1																																										
273	<b>[Drive Ramp Rslt]</b> Present frequency reference scaled as a DPI reference for peer to peer communications. The value shown is the value after the accel/decel ramp, but prior to any corrections supplied by slip comp, PI, etc.	Default: Read Only Min/Max: -/+2147483647 Units: 1																																										
274	<b>[DPI Port Sel]</b> Selects which DPI port reference value will appear in [DPI Port Value].	Default: "DPI Port 1" Options: 1-5 "DPI Port 1-5"																																										
275	<b>[DPI Port Value]</b> Value of the DPI reference selected in [DPI Port Sel].	Default: Read Only Min/Max: -/+32767 Units: 1																																										
298	<b>[DPI Ref Select]</b>  Scales DPI on maximum frequency or maximum speed.	Default: 0 "Max Freq" Options: 0 "Max Freq" 1 "Max Speed"																																										

File	Group	No.	Parameter Name & Description See <a href="#">page 16</a> for symbol descriptions	Values	Related
COMMUNICATIONS	Comm Control	299	<p><b>[DPI Fdbk Select]</b></p> <p>Selects the DPI units displayed on the first line of the HIM and the feedback word through any connected DPI peripheral (20-COMM-x, 1203-USB, etc.).</p> <p>(1) Refer to Input/Output Definitions on <a href="#">page 62</a>.                      (2) "Speed Fdbk" is a filtered value. Choose "25, SpdFb NoFilt" if your process requires speed feedback via a communication network.</p>	<p>Default: 17 "Speed Fdbk" (2)</p> <p>Options:</p> <ul style="list-style-type: none"> <li>0 "Output Freq"</li> <li>1 "Command Spd"</li> <li>2 "Output Amps"</li> <li>3 "Torque Amps"</li> <li>4 "Flux Amps"</li> <li>5 "Output Power"</li> <li>6 "Output Volts"</li> <li>7 "DC Bus Volts"</li> <li>8 "PI Reference" (1)</li> <li>9 "PI Feedback"</li> <li>10 "PI Error"</li> <li>11 "PI Output"</li> <li>12 "%Motor OL"</li> <li>13 "%Drive OL"</li> <li>14 "CommandedTrq"</li> <li>15 "MtrTrqCurRef" (1)</li> <li>16 "Speed Ref"</li> <li>17 "Speed Fdbk" (2)</li> <li>18 "Pulse In Ref" (1)</li> <li>19 "Reserved"</li> <li>20-23 "Scale Block1-4" (1)</li> <li>24 "Param Cntl"</li> <li>25 "SpdFb NoFilt"</li> </ul>	
		276	<p><b>[Logic Mask]</b></p> <p> Determines which ports can control the drive when [Write Mask Act], bit 15 is set to "1." If the bit for a port is set to "0," the port will have no control functions except for stop.</p>  <p>(1) Firmware 6.002 and later.</p> <p>Factory Default Bit Values</p>		<p><a href="#">288</a></p> <p>...</p> <p><a href="#">297</a></p>
		277	<p><b>[Start Mask]</b></p> <p> Controls which adapters can issue start commands.</p>	See <a href="#">[Logic Mask]</a> .	<p><a href="#">288</a></p> <p>...</p> <p><a href="#">297</a></p>
		278	<p><b>[Jog Mask]</b></p> <p> Controls which adapters can issue jog commands.</p>	See <a href="#">[Logic Mask]</a> .	<p><a href="#">288</a></p> <p>...</p> <p><a href="#">297</a></p>
		279	<p><b>[Direction Mask]</b></p> <p> Controls which adapters can issue forward/reverse direction commands.</p>	See <a href="#">[Logic Mask]</a> .	<p><a href="#">288</a></p> <p>...</p> <p><a href="#">297</a></p>
		280	<p><b>[Reference Mask]</b></p> <p> Controls which adapters can select an alternate reference; [Speed Ref A, B Sel] or [Preset Speed 1-7].</p>	See <a href="#">[Logic Mask]</a> .	<p><a href="#">288</a></p> <p>...</p> <p><a href="#">297</a></p>
		281	<p><b>[Accel Mask]</b></p> <p> Controls which adapters can select [Accel Time 1, 2].</p>	See <a href="#">[Logic Mask]</a> .	<p><a href="#">288</a></p> <p>...</p> <p><a href="#">297</a></p>
		282	<p><b>[Decel Mask]</b></p> <p> Controls which adapters can select [Decel Time 1, 2].</p>	See <a href="#">[Logic Mask]</a> .	<p><a href="#">288</a></p> <p>...</p> <p><a href="#">297</a></p>
		283	<p><b>[Fault Clr Mask]</b></p> <p> Controls which adapters can clear a fault.</p>	See <a href="#">[Logic Mask]</a> .	<p><a href="#">288</a></p> <p>...</p> <p><a href="#">297</a></p>
		COMMUNICATIONS	Masks & Owners		



File	Group	No.	Parameter Name & Description See <a href="#">page 16</a> for symbol descriptions	Values	Related
COMMUNICATIONS	Masks & Owners	284	<b>[MOP Mask]</b>  Controls which adapters can issue MOP commands to the drive.	See <a href="#">[Logic Mask]</a> .	<a href="#">288</a> ... <a href="#">297</a>
		285	<b>[Local Mask]</b>  Controls which adapters are allowed to take exclusive control of drive logic commands (except stop). Exclusive "local" control can only be taken while the drive is stopped.	See <a href="#">[Logic Mask]</a> .	<a href="#">288</a> ... <a href="#">297</a>
		288	<b>[Stop Owner]</b> Adapters that are presently issuing a valid stop command. 	Read Only	<a href="#">276</a> ... <a href="#">285</a>
		289	<b>[Start Owner]</b> Adapters that are presently issuing a valid start command.	See <a href="#">[Stop Owner]</a> .	<a href="#">276</a> ... <a href="#">285</a>
		290	<b>[Jog Owner]</b> Adapters that are presently issuing a valid jog command.	See <a href="#">[Stop Owner]</a> .	<a href="#">276</a> ... <a href="#">285</a>
		291	<b>[Direction Owner]</b> Adapter that currently has exclusive control of direction changes.	See <a href="#">[Stop Owner]</a> .	<a href="#">276</a> ... <a href="#">285</a>
		292	<b>[Reference Owner]</b> Adapter that has the exclusive control of the command frequency source selection.	See <a href="#">[Stop Owner]</a> .	<a href="#">276</a> ... <a href="#">285</a>
		293	<b>[Accel Owner]</b> Adapter that has exclusive control of selecting [Accel Time 1, 2].	See <a href="#">[Stop Owner]</a> .	<a href="#">140</a> <a href="#">276</a> ... <a href="#">285</a>
		294	<b>[Decel Owner]</b> Adapter that has exclusive control of selecting [Decel Time 1, 2].	See <a href="#">[Stop Owner]</a> .	<a href="#">142</a> <a href="#">276</a> ... <a href="#">285</a>
		295	<b>[Fault Clr Owner]</b> Adapter that is presently clearing a fault.	See <a href="#">[Stop Owner]</a> .	<a href="#">276</a> ... <a href="#">285</a>
		296	<b>[MOP Owner]</b> Adapters that are currently issuing increases or decreases in MOP command frequency.	See <a href="#">[Stop Owner]</a> .	<a href="#">276</a> ... <a href="#">285</a>
		297	<b>[Local Owner]</b> Adapter that has requested exclusive control of all drive logic functions. If an adapter is in local lockout, all other functions (except stop) on all other adapters are locked out and non-functional. Local control can only be obtained when the drive is not running.	See <a href="#">[Stop Owner]</a> .	<a href="#">276</a> ... <a href="#">285</a>

File	Group	No.	Parameter Name & Description See <a href="#">page 16</a> for symbol descriptions	Values	Related
COMMUNICATIONS	Datalinks	300 301	<b>[Data In A1] - Link A Word 1</b> <b>[Data In A2] - Link A Word 2</b> Parameter number whose value will be written from a communications device data table. Value will not be updated until drive is stopped. Refer to your communications option manual for datalink information.	Default: 0 (0 = "Disabled") Min/Max: 0/611 Units: 1	
		302 303	<b>[Data In B1] - Link B Word 1</b> <b>[Data In B2] - Link B Word 2</b> 	See <a href="#">[Data In A1] - Link A Word 1</a> <a href="#">[Data In A2] - Link A Word 2</a> .	
		304 305	<b>[Data In C1] - Link C Word 1</b> <b>[Data In C2] - Link C Word 2</b> 	See <a href="#">[Data In A1] - Link A Word 1</a> <a href="#">[Data In A2] - Link A Word 2</a> .	
		306 307	<b>[Data In D1] - Link D Word 1</b> <b>[Data In D2] - Link D Word 2</b> Not available with Liquid-Cooled drives.	See <a href="#">[Data In A1] - Link A Word 1</a> <a href="#">[Data In A2] - Link A Word 2</a> .	
		308	<b>[HighRes Ref]</b> Used as a high resolution, 32 bit reference with Datalinks. -/[Maximum Freq] or -/[Maximum Speed] = 32767 x 65536	Default: 0 Min/Max: -/+2147418112 Units: 1	<a href="#">090</a> <a href="#">093</a> <a href="#">126</a> <a href="#">128</a> <a href="#">213</a> <a href="#">298</a>
		310 311	<b>[Data Out A1] - Link A Word 1</b> <b>[Data Out A2] - Link A Word 2</b> Parameter whose value will be written to a communications device data table.	Default: 0 (0 = "Disabled") Min/Max: 0/611 Units: 1	
		312 313	<b>[Data Out B1] - Link B Word 1</b> <b>[Data Out B2] - Link B Word 2</b>	See <a href="#">[Data Out A1] - Link A Word 1</a> <a href="#">[Data Out A2] - Link A Word 2</a> .	
		314 315	<b>[Data Out C1] - Link C Word 1</b> <b>[Data Out C2] - Link C Word 2</b>	See <a href="#">[Data Out A1] - Link A Word 1</a> <a href="#">[Data Out A2] - Link A Word 2</a> .	
		316 317	<b>[Data Out D1] - Link D Word 1</b> <b>[Data Out D2] - Link D Word 2</b>	See <a href="#">[Data Out A1] - Link A Word 1</a> <a href="#">[Data Out A2] - Link A Word 2</a> .	
		595	<b>[Port Mask Act]</b> Read Only Bits 0-5 indicate status for DPI port communication. Bit 15 indicates when security software is controlling the parameter.		
				<p>Bit #</p> <p>Factory Default Bit Values</p> <p>(1) Firmware 6.002 and later.</p>	
		596	<b>[Write Mask Cfg]</b> Enables/disables write access (parameters, links, etc.) for DPI ports. Changes to this parameter only become effective when power is cycled, the drive is reset or bit 15 of [Write Mask Act], transitions from "1" to "0."		
				<p>Bit #</p> <p>Factory Default Bit Values</p> <p>(1) Firmware 6.002 and later.</p>	

File	Group	No.	Parameter Name & Description See <a href="#">page 16</a> for symbol descriptions	Values	Related	
COMMUNICATIONS	Security	597	<b>[Write Mask Act]</b> Status of write access for DPI ports. When bit 15 is set, network security is controlling the write mask instead of [Write Mask Cfg].	Read Only		
		<p>Bit #</p> <p>Factory Default Bit Values</p> <p>(1) Firmware 6.002 and later.</p> <p>1 = Write Permitted 0 = Read Only x = Reserved</p>				
		276	<b>[Logic Mask]</b> Determines which ports can control the drive. If the bit for a port is set to "0," the port will have no control functions except for stop.		<a href="#">288</a> ... <a href="#">297</a>	
<p>Bit #</p> <p>Factory Default Bit Values</p> <p>(1) Firmware 6.002 and later.</p> <p>1 = Control Permitted 0 = Control Masked x = Reserved</p>						
		598	<b>[Logic Mask Act]</b> Indicates status of the logic mask for DPI ports. When bit 15 is set, network security is controlling the logic mask instead of [Logic Mask].	Read Only	<a href="#">276</a>	
<p>Bit #</p> <p>Factory Default Bit Values</p> <p>(1) Firmware 6.002 and later.</p> <p>1 = Control Permitted 0 = Control Masked x = Reserved</p>						

## Inputs & Outputs File

File	Group	No.	Parameter Name & Description See <a href="#">page 16</a> for symbol descriptions	Values	Related
INPUTS & OUTPUTS	Analog Inputs	320	<b>[Anlg In Config]</b> Selects the mode for the analog inputs. For current mode, verify that wiring is correct at I/O terminals 17/18 (Analog In 1) or 19/20 (Analog In 2). Refer to the Installation Instructions for details.		<a href="#">322</a> <a href="#">325</a> <a href="#">323</a> <a href="#">326</a>
		<p>Bit #</p> <p>Factory Default Bit Values</p> <p>1 = Current 0 = Voltage x = Reserved</p>			
		321	<b>[Anlg In Sqr Root]</b> Enables/disables the square root function for each input.		
<p>Bit #</p> <p>Factory Default Bit Values</p> <p>1 = Enable 0 = Disable x = Reserved</p>					

File	Group	No.	Parameter Name & Description See <a href="#">page 16</a> for symbol descriptions	Values	Related
INPUTS & OUTPUTS	Analog Inputs	322	<b>[Analog In 1 Hi]</b>	Default: 10.000 Volt	<a href="#">091</a> <a href="#">092</a>
		325	<b>[Analog In 2 Hi]</b>  Sets the highest input value to the analog input x scaling block. [Anlg In Config], parameter 320 defines if this input will be -/+10V or 0-20 mA.	10.000 Volt  Min/Max: 0.000/20.000mA -/+10.000V 0.000/10.000V Units: 0.001 mA 0.001 Volt	
		323	<b>[Analog In 1 Lo]</b>	Default: 0.000 Volt	
	326	<b>[Analog In 2 Lo]</b>  Sets the lowest input value to the analog input x scaling block. [Anlg In Config], parameter 320 defines if this input will be -/+10V or 0-20 mA. If set below 4 mA, [Analog In x Loss] should be "Disabled."	0.000 Volt  Min/Max: 0.000/20.000mA -/+10.000V 0.000/10.000V Units: 0.001 mA 0.001 Volt	<a href="#">091</a> <a href="#">092</a>	
	324	<b>[Analog In 1 Loss]</b>	Default: 0 "Disabled"	<a href="#">091</a> <a href="#">092</a>	
	327	<b>[Analog In 2 Loss]</b>  Selects drive action when an analog signal loss is detected. Signal loss is defined as an analog signal less than 1V or 2 mA. The signal loss event ends and normal operation resumes when the input signal level is greater than or equal to 1.5V or 3 mA. Note: parameter 190, [Direction Mode] must be set to "0, Unipolar."	0 "Disabled"  Options: 0 "Disabled" 1 "Fault" 2 "Hold Input" 3 "Set Input Lo" 4 "Set Input Hi" 5 "Goto Preset1" 6 "Hold OutFreq"		
Analog Outputs	340		<b>[Anlg Out Config]</b>  Selects the mode for the analog outputs. .  <p>Bit # 15 14 13 12 11 10 9 8 7 6 5 4 3 2 1 0</p> <p>Factory Default Bit Values</p> <p>1 = Current 0 = Voltage x = Reserved</p>		
	341		<b>[Anlg Out Absolut]</b>  Selects whether the signed value or absolute value of a parameter is used before being scaled to drive the analog output.  <p>Bit # 15 14 13 12 11 10 9 8 7 6 5 4 3 2 1 0</p> <p>Factory Default Bit Values</p> <p>1 = Absolute 0 = Signed x = Reserved</p>		

File	Group	No.	Parameter Name & Description See <a href="#">page 16</a> for symbol descriptions	Values	Related			
INPUTS & OUTPUTS	Analog Outputs	342	<b>[Analog Out1 Sel] [Analog Out2 Sel]</b>  Selects the source of the value that drives the analog output.	Default: 0 "Output Freq"	<a href="#">001</a> <a href="#">002</a> <a href="#">003</a> <a href="#">004</a> <a href="#">005</a> <a href="#">007</a> <a href="#">006</a> <a href="#">012</a> <a href="#">135</a> <a href="#">136</a> <a href="#">137</a> <a href="#">138</a> <a href="#">220</a> <a href="#">219</a>			
		345		Options: See Table				
		<b>Options</b>		<b>[Analog Out1 Lo] Value</b>		<b>[Analog Out1 Hi] Value</b>		
				Param. 341 = Signed		Param. 341 = Absolute		
		0		"Output Freq"		–[Maximum Speed]	0 Hz	+ [Maximum Speed]
		1		"Command Spd"		–[Maximum Speed]	0 Hz/RPM	+ [Maximum Speed]
		2		"Output Amps"		0 Amps	0 Amps	200% Rated
		3		"Torque Amps"		–200% Rated	0 Amps	200% Rated
		4		"Flux Amps"		0 Amps	0 Amps	200% Rated
		5		"Output Power"		0 kW	0 kW	200% Rated
6	"Output Volts"	0 Volts	0 Volts	120% Rated Input Volts				
7	"DC Bus Volts"	0 Volts	0 Volts	200% Rated Input Volts				
8	"PI Reference" <sup>(1)</sup>	–100%	0%	100%				
9	"PI Feedback"	–100%	0%	100%				
10	"PI Error"	–100%	0%	100%				
11	"PI Output"	–100%	0%	100%				
12	"%Motor OL"	0%	0%	100%				
13	"%Drive OL"	0%	0%	100%				
14	"CommandedTrq"	–800% Rated	0%	800% Rated				
15	"MtrTrqCurRef" <sup>(1)</sup>	–200% Rated	0%	200% Rated				
16	"Speed Ref"	–[Maximum Speed]	0 Hz/RPM	+ [Maximum Speed]				
17	"Speed Fdbk"	–[Maximum Speed]	0 Hz/RPM	+ [Maximum Speed]				
18	"Pulse In Ref" <sup>(1)</sup>	–25200.0 RPM	0 Hz/RPM	+ [Maximum Speed]				
19	"Torque Est" <sup>(1)</sup>	–800%	0%	+800%				
20-23	"Scale Block1-4" <sup>(1)</sup>							
24	"Param Cntl" <sup>(1)</sup>							
25	"SpdFb NoFilt"							
<sup>(1)</sup> Refer to Option Definitions on <a href="#">page 62</a> .								
		343	<b>[Analog Out1 Hi] [Analog Out2 Hi]</b>  Sets the analog output value when the source value is at maximum.	Default: 20.000 mA, 10.000 Volts	<a href="#">340</a> <a href="#">342</a>			
		346		Min/Max: 0.000/20.000mA Units: –/+10.000V 0.001 mA 0.001 Volt				
		344	<b>[Analog Out1 Lo] [Analog Out2 Lo]</b>  Sets the analog output value when the source value is at minimum.	Default: 0.000 mA, 0.000 Volts	<a href="#">340</a> <a href="#">342</a>			
		347		Min/Max: 0.000/20.000mA Units: –/+10.000V 0.001 mA 0.001 Volt				
		354	<b>[Anlg Out1 Scale] [Anlg Out2 Scale]</b>  Sets the high value for the range of analog out scale. Entering 0.0 will disable this scale and max scale will be used. Example: If [Analog Out Sel] = "Commanded Trq," a value of 150 = 150% scale in place of the default 800%.	Default: 0.0				
		355		Min/Max: [Analog Out1 Sel] Units: 0.1 Units shown are dependent on the value in parameter 342/345.				
		377	<b>[Anlg1 Out Setpt] [Anlg2 Out Setpt]</b>  Controls the analog output value from a communication device. Example: Set [Data In Ax] to "377" (value from communication device). Then set [Analog Outx Sel] to "Param Cntl."	Default: 4.000 mA, 0.000 Volts				
		378		Min/Max: 0.000/20.000 mA Units: –/+10.000V 0.001 mA 0.001 Volt				

**Table 1 - Selected Option Definitions – [Analog Outx Sel], [Digital Inx Sel], [Digital Outx Sel]**

Option	Description	Related
At Speed	Relay changes state when drive has reached commanded speed.	<a href="#">380</a>
Fast Stop	When open, the drive will stop with a 0.1 second decel time. (If Torque Proving is being used, float will be ignored at end of ramp and the mechanical brake will be set).	<a href="#">361</a> 
Excl Link	Links digital input to a digital output if the output is set to "Input 1-6 Link." This does not need to be selected in the Vector option.	<a href="#">361</a>
Find Home	Starts the commissioning procedure when a start command is issued to automatically position the motor to a home position established by a limit switch.	
Hold Step	Inhibits profile from transitioning to next step when active.	
Home Limit	This input is used for the "home" position.	
Input 1-6 Link	When Digital Output 1 is set to one of these (i.e. Input 3 Link) in conjunction with Digital Input 3 set to "Excl Link," the Digital Input 3 state (on/off) is echoed in the Digital Output 1.	<a href="#">380</a>
Micro Pos	Microposition input. When closed, the command frequency is set to a percentage speed reference as defined in [MicroPos Scale%], parameter 611.	<a href="#">361</a>
MOP Dec	Decrements speed reference as long as input is closed.	<a href="#">361</a>
MOP Inc	Increments speed reference as long as input is closed.	<a href="#">361</a>
MtrTrqCurRef	Torque producing current reference.	<a href="#">342</a>
Param Cntl	Parameter controlled analog output allows PLC to control analog outputs through data links. Set in [AnlgX Out Setpt], parameters 377-378.	<a href="#">342</a>
Param Cntl	Parameter controlled digital output allows PLC to control digital outputs through data links. Set in [Dig Out Setpt], parameter 379.	<a href="#">380</a>
PI Reference	Reference for PI block (see <a href="#">Process PID on page 134</a> ).	<a href="#">342</a>
Pos Redefine	Redefines the "home" position for the drive by latching encoder position.	
Pos Sel 1-5	Binary value of these inputs is used to select the starting step number for the profile.	
Precharge En	Forces drive into precharge state. Typically controlled by auxiliary contact on the disconnect at the DC input to the drive.	<a href="#">361</a>
Profile Input	Must be chosen if [Step X Type] is set to "Dig Input" and the digital input value that is entered in [Step X Value] is the value of this digital input selector.	
Pulse In Ref	Reference of the pulse input (Z channel of encoder - can be used while A & B channels are encoder inputs).	<a href="#">342</a>
RunFwd Level RunRev Level Run Level	Provides a run level input. They do not require a transition for enable or fault, but a transition is still required for a stop.	
Run w/Comm	Allows the comms start bit to operate like a run with the run input on the terminal block. Ownership rules apply.	
Scale Block 1-4	Output of scale blocks, parameters 354-355.	<a href="#">342</a>
SpdFb NoFilt	Provides an unfiltered value to an analog output. The filtered version "Speed Fdbk" includes a 125 ms filter.	
Torque Est	Calculated percentage of rated motor torque.	<a href="#">342</a>
Torque Setpt 1	Selects "Torque Stpt1" for [Torque Ref A Sel] when set, otherwise uses value selected in [Torque Ref A Sel].	<a href="#">361</a>
Vel Override	When active, multiplies value of [Step X Velocity] by % value in [Vel Override].	

File	Group	No.	Parameter Name & Description See <a href="#">page 16</a> for symbol descriptions	Values	Related																																				
INPUTS & OUTPUTS	Digital Inputs	361	[Digital In1 Sel]	Default: 4 "Stop – CF"																																					
		362	[Digital In2 Sel]	Default: 5 "Start"																																					
		363	[Digital In3 Sel]	Default: 18 "Auto/ Manual"																																					
		364	[Digital In4 Sel]	Default: 15 "Speed Sel 1"																																					
		365	[Digital In5 Sel]	Default: 16 "Speed Sel 2"																																					
		366	[Digital In6 Sel] <sup>(10)</sup>	Default: 17 "Speed Sel 3"																																					
			 Selects the function for the digital inputs.	Options: 0 "Not Used"																																					
			(1) Speed Select Inputs	1 "Enable" <sup>(7) (9)</sup>																																					
			<table border="1" data-bbox="755 493 1047 682"> <thead> <tr> <th>3</th> <th>2</th> <th>1</th> <th>Auto Reference Source</th> </tr> </thead> <tbody> <tr><td>0</td><td>0</td><td>0</td><td>Reference A</td></tr> <tr><td>0</td><td>0</td><td>1</td><td>Reference B</td></tr> <tr><td>0</td><td>1</td><td>0</td><td>Preset Speed 2</td></tr> <tr><td>0</td><td>1</td><td>1</td><td>Preset Speed 3</td></tr> <tr><td>1</td><td>0</td><td>0</td><td>Preset Speed 4</td></tr> <tr><td>1</td><td>0</td><td>1</td><td>Preset Speed 5</td></tr> <tr><td>1</td><td>1</td><td>0</td><td>Preset Speed 6</td></tr> <tr><td>1</td><td>1</td><td>1</td><td>Preset Speed 7</td></tr> </tbody> </table>	3	2	1	Auto Reference Source	0	0	0	Reference A	0	0	1	Reference B	0	1	0	Preset Speed 2	0	1	1	Preset Speed 3	1	0	0	Preset Speed 4	1	0	1	Preset Speed 5	1	1	0	Preset Speed 6	1	1	1	Preset Speed 7	2 "Clear Faults"(CF) <sup>(3)</sup>	
		3	2	1	Auto Reference Source																																				
		0	0	0	Reference A																																				
		0	0	1	Reference B																																				
		0	1	0	Preset Speed 2																																				
		0	1	1	Preset Speed 3																																				
1	0	0	Preset Speed 4																																						
1	0	1	Preset Speed 5																																						
1	1	0	Preset Speed 6																																						
1	1	1	Preset Speed 7																																						
	To access Preset Speed 1, set [Speed Ref x Sel] to "Preset Speed 1".	3 "Aux Fault"																																							
	Type 2 Alarms - Some digital input programming can cause conflicts that will result in a Type 2 alarm. Example: [Digital In1 Sel] set to "5, Start" in 3-wire control and [Digital In2 Sel] set to 7 "Run" in 2-wire. See <a href="#">Table 4 on page 91</a> for info on resolving this type of conflict.	4 "Stop – CF" <sup>(9)</sup>																																							
	(2) Speed/Torque Selection	5 "Start" <sup>(4) (8)</sup>																																							
	<table border="1" data-bbox="755 892 1047 1081"> <thead> <tr> <th>3</th> <th>2</th> <th>1</th> <th>Spd/Trq Mode</th> </tr> </thead> <tbody> <tr><td>0</td><td>0</td><td>0</td><td>Zero Torque</td></tr> <tr><td>0</td><td>0</td><td>1</td><td>Spd Reg</td></tr> <tr><td>0</td><td>1</td><td>0</td><td>Torque Reg</td></tr> <tr><td>0</td><td>1</td><td>1</td><td>Min Spd/Trq</td></tr> <tr><td>1</td><td>0</td><td>0</td><td>Max Spd/Trq</td></tr> <tr><td>1</td><td>0</td><td>1</td><td>Sum Spd/Trq</td></tr> <tr><td>1</td><td>1</td><td>0</td><td>Absolute</td></tr> <tr><td>1</td><td>1</td><td>1</td><td>Pos/Spd Prof</td></tr> </tbody> </table>	3	2	1	Spd/Trq Mode	0	0	0	Zero Torque	0	0	1	Spd Reg	0	1	0	Torque Reg	0	1	1	Min Spd/Trq	1	0	0	Max Spd/Trq	1	0	1	Sum Spd/Trq	1	1	0	Absolute	1	1	1	Pos/Spd Prof	6 "Fwd/ Reverse" <sup>(4)</sup>			
3	2	1	Spd/Trq Mode																																						
0	0	0	Zero Torque																																						
0	0	1	Spd Reg																																						
0	1	0	Torque Reg																																						
0	1	1	Min Spd/Trq																																						
1	0	0	Max Spd/Trq																																						
1	0	1	Sum Spd/Trq																																						
1	1	0	Absolute																																						
1	1	1	Pos/Spd Prof																																						
	(3) When [Digital Inx Sel] is set to option 2 "Clear Faults" the Stop button cannot be used to clear a fault condition.	7 "Run" <sup>(5) (9)</sup>																																							
	(4) Typical 3-Wire Inputs - Only 3-wire functions are allowed. Including 2-wire selections will cause a type 2 alarm.	8 "Run Forward" <sup>(5)</sup>																																							
	(5) Typical 2-Wire Inputs - Only 2-wire functions can be chosen. Including 3-wire selections will cause a type 2 alarm. See <a href="#">Table 4 on page 91</a> for conflicts.	9 "Run Reverse" <sup>(5)</sup>																																							
	(6) Configures the input to command a transition between the Manual/Auto or Auto/Manual speed references. Manual/Auto <sup>(68)</sup> is similar to "Auto/Manual" (18) except that the polarity is opposite.	10 "Jog1"	<a href="#">100</a>																																						
	<table border="1" data-bbox="755 1375 1047 1470"> <thead> <tr> <th>Input State</th> <th>"Auto/Manual"<sup>(18)</sup></th> <th>"Manual/Auto"<sup>(68)</sup></th> </tr> </thead> <tbody> <tr><td>Lo</td><td>Auto</td><td>Manual</td></tr> <tr><td>Hi</td><td>Manual</td><td>Auto</td></tr> </tbody> </table>	Input State	"Auto/Manual" <sup>(18)</sup>	"Manual/Auto" <sup>(68)</sup>	Lo	Auto	Manual	Hi	Manual	Auto	11 "Jog Forward" <sup>(5)</sup>																														
Input State	"Auto/Manual" <sup>(18)</sup>	"Manual/Auto" <sup>(68)</sup>																																							
Lo	Auto	Manual																																							
Hi	Manual	Auto																																							
	(7) Opening an "Enable" input will cause the motor to coast-to-stop, ignoring any programmed Stop modes.	12 "Jog Reverse" <sup>(5)</sup>																																							
	(8) "Dig In ConflictB" alarm will occur if a "Start" input is prog. without a "Stop" input.	13 "Stop Mode B"	<a href="#">156</a>																																						
	(9) Refer to the Sleep-Wake Mode Attention statement on <a href="#">page 42</a> .	14 "Bus Reg Md B"	<a href="#">162</a>																																						
	(10) A dedicated hardware enable input is available via a jumper selection. Refer to the Installation Instructions for further information.	15-17 "Speed Sel 1-3" <sup>(1)</sup>																																							
	(11) Only available when "Torque Proving" function is selected.	18 "Auto/ Manual" <sup>(6)</sup>	<a href="#">096</a>																																						
	(12) Refer to Option Definitions on <a href="#">page 62</a> .	19 "Local"																																							
	(13) Refer to [Dyn UsrSet Sel] on <a href="#">page 46</a> for selection information.	20 "Acc2 & Dec2"																																							
	(14) Firmware v6.002 and later.	21 "Accel 2"	<a href="#">141</a>																																						
	continued	22 "Decel 2"	<a href="#">143</a>																																						
		23 "MOP Inc" <sup>(12)</sup>	<a href="#">195</a>																																						
		24 "MOP Dec" <sup>(12)</sup>																																							
		25 "Excl Link" <sup>(12)</sup>																																							
		26 "PI Enable"	<a href="#">194</a>																																						
		27 "PI Hold"																																							
		28 "PI Reset"	<a href="#">380</a>																																						
		29 "Pwr Loss Lvl"	<a href="#">124</a>																																						
		30 "Precharge En" <sup>(12)</sup>																																							
		31-33 "Spd/Trq Sel1-3" <sup>(2)</sup>																																							
		34 "Jog 2"																																							
		35 "PI Invert"																																							
		36 "Torque Setpt 1" <sup>(12)</sup>																																							
		37 "Flt/MicroPos" <sup>(11) (12)</sup>																																							
		38 "Fast Stop" <sup>(12)</sup>																																							
		39 "Decel Limit"																																							
		40 "End Limit"																																							
		41-42 "UserSet Sel1-2" <sup>(13)</sup>																																							
		43 "Run Level"																																							
		44 "RunFwd Level"																																							
		45 "RunRev Level" <sup>(12)</sup>																																							
		46 "Run w/Comm" <sup>(12)</sup>																																							
		47 "Hold Step" <sup>(12)</sup>																																							
		48 "Redefine Pos" <sup>(12)</sup>																																							
		49 "Find Home" <sup>(12)</sup>																																							
		50 "Home Limit" <sup>(12)</sup>																																							
		51 "Vel Override" <sup>(12)</sup>																																							
		52-56 "Pos Sel 1-5" <sup>(12)</sup>																																							
		57 "Prof Input" <sup>(12)</sup>																																							
		58-59 "Reserved"																																							
		60-62 "AdjV Sel 1-3" <sup>(14) (15)</sup>																																							
		63-65 "AdjV/Hz Sel1-3" <sup>(14) (16)</sup>																																							
		66 "Abort Step" <sup>(14)</sup>																																							
		67 "Abort Prof" <sup>(14)</sup>																																							
		68 "Manual/Auto" <sup>(6)</sup>																																							
		69 "MtrDC Inject" <sup>(17)</sup>																																							
		70 "HOA Start" <sup>(17)</sup>																																							

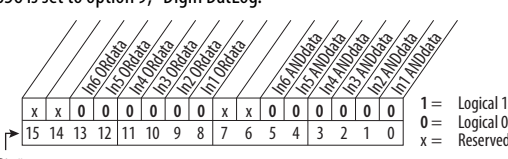
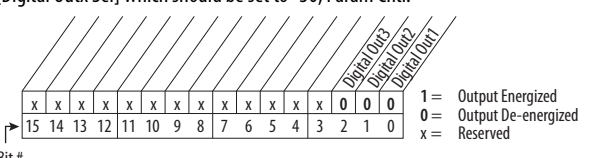



File	Group	No.	Parameter Name & Description See <a href="#">page 16</a> for symbol descriptions	Values	Related																																																																								
INPUTS & OUTPUTS	Digital Inputs		(15) Adjust Voltage Select Inputs <table border="1" style="margin: 5px;"> <tr><th>3</th><th>2</th><th>1</th><th>AdjV Sel</th></tr> <tr><td>0</td><td>0</td><td>0</td><td>Adj Volt Sel</td></tr> <tr><td>0</td><td>0</td><td>1</td><td>Adj Volt Preset1</td></tr> <tr><td>0</td><td>1</td><td>0</td><td>Adj Volt Preset2</td></tr> <tr><td>0</td><td>1</td><td>1</td><td>Adj Volt Preset3</td></tr> <tr><td>1</td><td>0</td><td>0</td><td>Adj Volt Preset4</td></tr> <tr><td>1</td><td>0</td><td>1</td><td>Adj Volt Preset5</td></tr> <tr><td>1</td><td>1</td><td>0</td><td>Adj Volt Preset6</td></tr> <tr><td>1</td><td>1</td><td>1</td><td>Adj Volt Preset7</td></tr> </table> (16) <table border="1" style="margin: 5px;"> <tr><th>3</th><th>2</th><th>1</th><th>AdjV Sel</th></tr> <tr><td>0</td><td>0</td><td>0</td><td>Adj Volt Sel &amp; Speed ref A Sel</td></tr> <tr><td>0</td><td>0</td><td>1</td><td>Adj Volt Preset1 &amp; Speed Ref B Sel</td></tr> <tr><td>0</td><td>1</td><td>0</td><td>Adj Volt Preset2 &amp; Speed Preset 2</td></tr> <tr><td>0</td><td>1</td><td>1</td><td>Adj Volt Preset3 &amp; Speed Preset 3</td></tr> <tr><td>1</td><td>0</td><td>0</td><td>Adj Volt Preset4 &amp; Speed Preset 4</td></tr> <tr><td>1</td><td>0</td><td>1</td><td>Adj Volt Preset5 &amp; Speed Preset 5</td></tr> <tr><td>1</td><td>1</td><td>0</td><td>Adj Volt Preset6 &amp; Speed Preset 6</td></tr> <tr><td>1</td><td>1</td><td>1</td><td>Adj Volt Preset7 &amp; Speed Preset 7</td></tr> </table> <p>Mixing selections 63-65 with 60-62 or 15-17 will cause a type 2 alarm.</p> (17)Firmware revision 10.001 and later.	3	2	1	AdjV Sel	0	0	0	Adj Volt Sel	0	0	1	Adj Volt Preset1	0	1	0	Adj Volt Preset2	0	1	1	Adj Volt Preset3	1	0	0	Adj Volt Preset4	1	0	1	Adj Volt Preset5	1	1	0	Adj Volt Preset6	1	1	1	Adj Volt Preset7	3	2	1	AdjV Sel	0	0	0	Adj Volt Sel & Speed ref A Sel	0	0	1	Adj Volt Preset1 & Speed Ref B Sel	0	1	0	Adj Volt Preset2 & Speed Preset 2	0	1	1	Adj Volt Preset3 & Speed Preset 3	1	0	0	Adj Volt Preset4 & Speed Preset 4	1	0	1	Adj Volt Preset5 & Speed Preset 5	1	1	0	Adj Volt Preset6 & Speed Preset 6	1	1	1	Adj Volt Preset7 & Speed Preset 7		
	3	2	1	AdjV Sel																																																																									
0	0	0	Adj Volt Sel																																																																										
0	0	1	Adj Volt Preset1																																																																										
0	1	0	Adj Volt Preset2																																																																										
0	1	1	Adj Volt Preset3																																																																										
1	0	0	Adj Volt Preset4																																																																										
1	0	1	Adj Volt Preset5																																																																										
1	1	0	Adj Volt Preset6																																																																										
1	1	1	Adj Volt Preset7																																																																										
3	2	1	AdjV Sel																																																																										
0	0	0	Adj Volt Sel & Speed ref A Sel																																																																										
0	0	1	Adj Volt Preset1 & Speed Ref B Sel																																																																										
0	1	0	Adj Volt Preset2 & Speed Preset 2																																																																										
0	1	1	Adj Volt Preset3 & Speed Preset 3																																																																										
1	0	0	Adj Volt Preset4 & Speed Preset 4																																																																										
1	0	1	Adj Volt Preset5 & Speed Preset 5																																																																										
1	1	0	Adj Volt Preset6 & Speed Preset 6																																																																										
1	1	1	Adj Volt Preset7 & Speed Preset 7																																																																										
	Digital Outputs	411	<b>v6 [DigIn DataLogic]</b> Provides data to the logical operations that will be done with the digital inputs when parameter 056 is set to option 9, "DigIn DatLog." 		<a href="#">056</a>																																																																								
	Digital Outputs	379	<b>[Dig Out Setpt]</b> Sets the digital output value from a communication device. Example: Set [Data In B1] to "379." The first three bits of this value will determine the setting of [Digital Outx Sel] which should be set to "30, Param Cntl." 		<a href="#">380</a>																																																																								







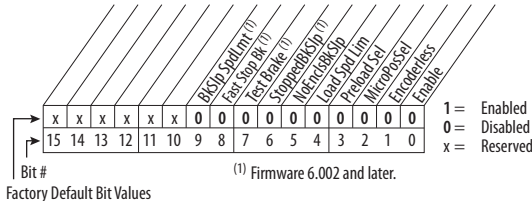

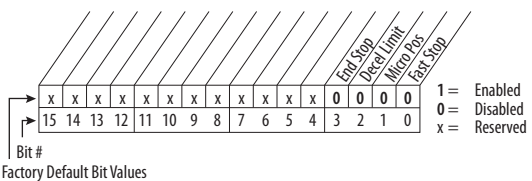

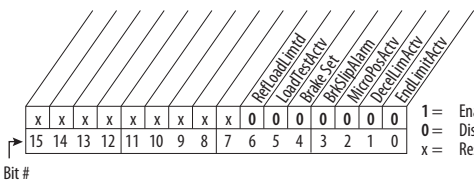





File	Group	No.	Parameter Name & Description See <a href="#">page 16</a> for symbol descriptions	Values	Related
INPUTS & OUTPUTS	Digital Outputs	380	<b>[Digital Out1 Sel]</b> <sup>(4)</sup>	Default: 1 "Fault"	<a href="#">381</a>
		384	<b>[Digital Out2 Sel]</b>	4 "Run"	<a href="#">385</a>
		388	<b>[Digital Out3 Sel]</b>	4 "Run"	<a href="#">389</a>
			Selects the drive status that will energize a (CRx) output relay.	Options: 1 "Fault" <sup>(1)</sup>	<a href="#">382</a>
				2 "Alarm" <sup>(1)</sup>	<a href="#">386</a>
				3 "Ready"	<a href="#">390</a>
				4 "Run"	<a href="#">383</a>
				5 "Forward Run"	
				6 "Reverse Run"	
				7 "Auto Restart"	
		8 "Powerup Run"			
		9 "At Speed" <sup>(2)</sup>			
		10 "At Freq" <sup>(3)</sup>	<a href="#">002</a>		
		11 "At Current" <sup>(3)</sup>	<a href="#">001</a>		
		12 "At Torque" <sup>(3)</sup>	<a href="#">003</a>		
		13 "At Temp" <sup>(3)</sup>	<a href="#">004</a>		
		14 "At Bus Volts" <sup>(3)</sup>	<a href="#">218</a>		
		15 "At PI Error" <sup>(3)</sup>	<a href="#">012</a>		
		16 "DC Braking"	<a href="#">137</a>		
		17 "Curr Limit"	<a href="#">157</a>		
		18 "Economize"	<a href="#">147</a>		
		19 "Motor Overld"	<a href="#">053</a>		
		20 "Power Loss"	<a href="#">048</a>		
		21-26 "Input 1-6 Link"	<a href="#">184</a>		
		27 "PI Enable"			
		28 "PI Hold"			
		29 "Drive Overload"			
		30 "Param Cntl" <sup>(2)</sup>	<a href="#">379</a>		
		31 "Mask 1 AND"			
		32 "Mask 1 OR"			
		33 "Prof At Pos"			
		34 "Prof Enabled"			
		35 "Prof Running"			
		36 "Prof Holding"			
		37 "Prof At Home"			
		38 "ProfComplete"			
		39 "Prof Homing"			
		40 "Prof Dwell"			
		41 "Prof Batch"			
		42-57 "Prof @ Step1-16"			
		58 "Manual Mode" <sup>(5)</sup>	<a href="#">222</a>		
		59 "Fast Braking" <sup>(5)</sup>	<a href="#">222</a>		
		60 "TrqPrv Brake" <sup>(5)</sup>	<a href="#">600</a>		
		61 "Speed Fdbk" <sup>(5)</sup>			
		381	<b>[Dig Out1 Level]</b>	Default: 0.0	<a href="#">380</a>
		385	<b>[Dig Out2 Level]</b>	0.0	
		389	<b>[Dig Out3 Level]</b>	0.0	
			Sets the relay activation level for options 10-15 in [Digital Outx Sel]. Units are assumed to match the above selection (i.e. "At Freq" = Hz, "At Torque" = Amps).	Min/Max: 0.0/819.2 Units: 0.1	
		382	<b>[Dig Out1 OnTime]</b>	Default: 0.00 Secs	<a href="#">380</a>
		386	<b>[Dig Out2 OnTime]</b>	0.00 Secs	
		390	<b>[Dig Out3 OnTime]</b>	0.00 Secs	
			Sets the "ON Delay" time for the digital outputs. This is the time between the occurrence of a condition and activation of the relay.	Min/Max: 0.00/600.00 Secs Units: 0.01 Secs	
		383	<b>[Dig Out1 OffTime]</b>	Default: 0.00 Secs	<a href="#">380</a>
		387	<b>[Dig Out2 OffTime]</b>	0.00 Secs	
		391	<b>[Dig Out3 OffTime]</b>	0.00 Secs	
			Sets the "OFF Delay" time for the digital outputs. This is the time between the disappearance of a condition and de-activation of the relay.	Min/Max: 0.00/600.00 Secs Units: 0.01 Secs	

File	Group	No.	Parameter Name & Description See <a href="#">page 16</a> for symbol descriptions	Values	Related																																																																																	
INPUTS & OUTPUTS Digital Outputs	Digital Outputs	392	<p><b>[Dig Out Invert]</b> Inverts the selected digital output.</p> <p>Bit # Factory Default Bit Values</p> <p>1 = Inverted 0 = Not Inverted x = Reserved</p>																																																																																			
		393	<p><b>[Dig Out Param]</b> Selects the value that the mask ([Dig Out Mask]) will be applied to.</p>	<p>Default: 0 "PI Config"</p> <p>Options:</p> <ul style="list-style-type: none"> <li>0 "PI Config"</li> <li>1 "PI Status"</li> <li>2-3 "Drive Sts 1-2"</li> <li>4-5 "DriveAlarm1-2"</li> <li>6 "StartInhibit"</li> <li>7 "DigIn Status"</li> <li>8-9 "DrvSts1/2Flt"</li> <li>10 "AlrmSts1/2Flt"</li> <li>12 "LogicCmdRslt"</li> <li>13 "Stop Owner"</li> <li>14 "Start Owner"</li> <li>15 "Jog Owner"</li> <li>16 "Dir Owner"</li> <li>17 "Ref Owner"</li> <li>18 "Accel Owner"</li> <li>19 "Decel Owner"</li> <li>20 "FltRst Owner"</li> <li>21 "MOP Owner"</li> <li>22 "Local Owner"</li> <li>23 "Limit Status"</li> <li>24 "PortMaskAct"</li> <li>25 "WriteMaskAct"</li> <li>26 "LogicMaskAct"</li> <li>27 "TorqProvCnfg"</li> <li>28 "TorqProvSet"</li> <li>29 "TorqProvSts"</li> <li>30 "Profile Sts"</li> <li>31 "Profile Cmd"</li> </ul>																																																																																		
		394	<p><b>[Dig Out Mask]</b> Sets the mask that is applied to the selected value in [Dig Out Param]. A bit (AND/OR) is applied, which is selected by the [Digital Outx Sel]. All bits with zeros in the mask are ignored.</p> <p>Bit # Factory Default Bit Values</p> <p>1 = Bit selected 0 = Bit Masked x = Reserved</p> <p>Example:</p> <p>Mask OR: If Any bits in the value are set in the mask, then the output is On.</p> <table border="1" style="width: 100%; border-collapse: collapse;"> <tr> <td>Selected Value</td> <td>0</td><td>0</td><td>0</td><td>0</td><td>1</td><td>1</td><td>0</td><td>0</td><td>1</td><td>1</td><td>1</td><td>1</td><td>0</td><td>0</td><td>0</td> </tr> <tr> <td>Mask</td> <td>0</td><td>0</td><td>0</td><td>0</td><td>0</td><td>0</td><td>0</td><td>0</td><td>1</td><td>0</td><td>0</td><td>0</td><td>0</td><td>1</td><td>0</td><td>0</td> </tr> <tr> <td>Result</td> <td colspan="16">Output On</td> </tr> </table> <p>Mask AND: If All bits in the value are set in the mask then the output is On.</p> <table border="1" style="width: 100%; border-collapse: collapse;"> <tr> <td>Selected Value</td> <td>0</td><td>0</td><td>0</td><td>0</td><td>1</td><td>1</td><td>0</td><td>0</td><td>1</td><td>1</td><td>1</td><td>1</td><td>0</td><td>0</td><td>0</td> </tr> <tr> <td>Mask</td> <td>0</td><td>0</td><td>0</td><td>0</td><td>0</td><td>0</td><td>0</td><td>0</td><td>1</td><td>0</td><td>0</td><td>0</td><td>0</td><td>1</td><td>0</td><td>0</td> </tr> </table>	Selected Value	0	0	0	0	1	1	0	0	1	1	1	1	0	0	0	Mask	0	0	0	0	0	0	0	0	1	0	0	0	0	1	0	0	Result	Output On																Selected Value	0	0	0	0	1	1	0	0	1	1	1	1	0	0	0	Mask	0	0	0	0	0	0	0	0	1	0	0	0	0	1	0	0
Selected Value	0	0	0	0	1	1	0	0	1	1	1	1	0	0	0																																																																							
Mask	0	0	0	0	0	0	0	0	1	0	0	0	0	1	0	0																																																																						
Result	Output On																																																																																					
Selected Value	0	0	0	0	1	1	0	0	1	1	1	1	0	0	0																																																																							
Mask	0	0	0	0	0	0	0	0	1	0	0	0	0	1	0	0																																																																						



## Applications File

File	Group	No.	Parameter Name & Description See <a href="#">page 16</a> for symbol descriptions	Values	Related						
APPLICATIONS	Torque Proving	600	<b>[TorqProve Cnfg]</b>  Enables/disables torque/brake proving feature. When "Enabled," [Digital Out1 Sel] becomes the brake control. Note: this value is not changed when parameters are reset to factory defaults. 	 <p>Bit #</p> <p>Factory Default Bit Values</p> <p>(<sup>1</sup>) Firmware 6.002 and later.</p> <p>1 = Enabled 0 = Disabled x = Reserved</p>							
		<u><b>Option Descriptions</b></u>	<b>Enable</b> Enables TorqProve features.	<b>Encoderless</b> Enables encoderless operation – bit 0 must also be enabled.	<b>MicroPosSel</b> A "1" allows the Micro Position digital input to change the speed command while the drive is running.	<b>Preload Sel</b> "0" uses the last torque for preload. "1" uses "TorqRef A" if commanded direction is forward and "TorqRef B" for reverse.	<b>Load Spd Lim</b> Enables drive to perform load calculation at base speed. Drive will then limit operation above base speed depending on load.	<b>NoEncsBkSlp</b> A "1" Disables the partial Brake Slip routine from the drive when encoderless is selected.	<b>StoppedBkSlp</b> Check for brake slip while stopped.	<b>Test Brake</b> Before releasing brake, test for slip using [Brake Test Torque].	<b>Fast Stop Bk</b> Immediately apply brake when a Fast Stop is initiated.
		601	<b>[TorqProve Setup]</b> Allows control of specific torque proving functions through a communication device.	 <p>Bit #</p> <p>Factory Default Bit Values</p> <p>1 = Enabled 0 = Disabled x = Reserved</p>							
		602	<b>[Spd Dev Band]</b> Defines the allowable difference between the commanded frequency and encoder feedback value. A fault will occur when the difference exceeds this value for a period of time.	Default: 2.0 Hz 60.0 RPM Min/Max: 0.1/15.0 Hz 3.0/450.0 RPM Units: 0.1 Hz 0.1 RPM	<a href="#">603</a>						
		603	<b>[SpdBand Integrat]</b> Sets the amount of time before a fault is issued when [Spd Dev Band] is outside its threshold.	Default: 60 mSec Min/Max: 1/200 mSec Units: 1 mSec	<a href="#">602</a>						
		604	<b>[Brk Release Time]</b> Sets the time between the brake release command and when the drive begins to accelerate. In Encoderless mode, this parameter sets the time to release the brake after drive starts.	Default: 0.10 Secs Min/Max: 0.00/10.00 Secs Units: 0.01 Secs							
		605	<b>[ZeroSpdFloatTime]</b> Sets the amount of time the drive is below [Float Tolerance] before the brake is set. Not used in Encoderless TorqProve mode.	Default: 5.0 Secs Min/Max: 0.1/500.0 Secs Units: 0.1 Secs							

File	Group	No.	Parameter Name & Description See <a href="#">page 16</a> for symbol descriptions	Values	Related	
APPLICATIONS	Torque Proving	606	<b>[Float Tolerance]</b> Sets the frequency level where the float timer starts. Also sets the frequency level where the brake will be closed in Encoderless TorqProve mode.	Default: 0.2 Hz 6.0 RPM Min/Max: 0.1/5.0 Hz 3.0/150.0 RPM Units: 0.1 Hz 0.1 RPM		
		607	<b>[Brk Set Time]</b> Defines the amount of delay time between commanding the brake to be set and the start of brake proving.	Default: 0.10 Secs Min/Max: 0.00/10.00 Secs Units: 0.01 Secs		
		608	<b>[TorqLim SlewRate]</b> Sets the rate to ramp the torque limits to zero during brake proving.	Default: 10.0 Secs Min/Max: 0.5/300.0 Secs Units: 0.1 Secs		
		609	<b>[BrkSlip Count]</b> Sets the number of encoder counts to define a brake slippage condition. Not used in encoderless operation.	Default: 250 Min/Max: 0/65535 Units: 1		
		610	<b>[Brk Alarm Travel]</b> Sets the number of motor shaft revolutions allowed during the brake slippage test. Drive torque is reduced to check for brake slippage. When slippage occurs, the drive allows this number of motor shaft revolutions before regaining control. Not used in Encoderless TorqProve mode.	Default: 1.0 Revs Min/Max: 0.0/1000.0 Revs Units: 0.1 Revs		
		611	 <b>[MicroPos Scale%]</b> Sets the percent of speed reference to be used when micropositioning has been selected in [TorqProve Cnfg]. Bit 2 of [TorqProve Cnfg], parameter 600 determines if the motor needs to come to a stop before this setting will take effect.	Default: 10.0% Min/Max: 0.1/100.0% Units: 0.1%	<a href="#">361</a> ... <a href="#">366</a> <a href="#">600</a>	
		612	<b>[Torq Prove Sts]</b> Displays the status bits for TorqProve.  Legend: 1 = Enabled 0 = Disabled x = Reserved	Read Only		
		613	 <b>[Brake Test Torq]</b> Sets test torque to use when [Brake Test] is enabled in [TorqProv Cnfg].	Default: 50.0% Min/Max: 0.0/150.0% Units: 0.1%	<a href="#">600</a>	
		Oil Well Pump	631	<b>[Rod Load Torque]</b> Displays the load side torque. [Alarm Config 1], parameter 259, bit 19 must be enabled to activate this display.	Default: Read Only Min/Max: 0.00/32000.00 FtLb Units: 0.01 FtLb	
			632	<b>[TorqAlarm Level]</b> Sets the level at which the Torque Alarm becomes active. Note: only active with PC pump applications (see param. <a href="#">641</a> ).	Default: 0.00 FtLb Min/Max: 0.00/5000.00 FtLb Units: 0.01 FtLb	
633	<b>[TorqAlarm Action]</b> Sets the drive action when the Torque Alarm is exceeded. Note: only active with PC pump applications (see param. <a href="#">641</a> ).		Default: 0 "No Action" Options: 0 "No Action" 1 "Goto Preset1"			

File	Group	No.	Parameter Name & Description See <a href="#">page 16</a> for symbol descriptions	Values	Related
APPLICATIONS	Oil Well Pump	634	<b>[TorqAlarm Dwell]</b> Sets the time that the torque must exceed [TorqAlarm Level] before [TorqAlarm Action] takes place. Note: only active with PC pump applications (see param. <a href="#">641</a> ).	Default: 0.0 Secs Min/Max: 0.0/60.0 Secs Units: 0.1 Secs	
		635	<b>[TorqAlrm Timeout]</b> Sets the amount of time a Torque Alarm can be active until timeout action begins. Note: only active with PC pump applications (see param. <a href="#">641</a> ).	Default: 0.0 Secs Min/Max: 0.0/600.0 Secs Units: 0.1 Secs	
		636	<b>[TorqAlrm TO Act]</b>  Sets the drive action when [TorqAlrm Timeout] is exceeded. Note: only active with PC pump applications (see p. <a href="#">641</a> ).	Default: 0 "Resume" Options: 0 "Resume" 1 "Fault Drive"	
		637	<b>[PCP Pump Sheave]</b>  Specifies the pump sheave diameter.	Default: 20.00 Inch Min/Max: 0.25/200.00 Inch Units: 0.01 Inch	
		638	<b>[Max Rod Torque]</b>  Sets the desired maximum torque on the polished rod in a PCP oil well application	Default: 500.0 FtLb Min/Max: 0.0/3000.0 FtLb Units: 0.1 FtLb	
		639	<b>[Min Rod Speed]</b>  Sets the minimum speed for the polished rod in a PCP oil well application.	Default: 0.0 RPM Min/Max: 0.0/199.0 RPM Units: 0.1 RPM	<a href="#">081</a> <a href="#">646</a>
		640	<b>[Max Rod Speed]</b>  Sets the maximum speed for the polished rod in a PCP oil well application.	Default: 300.0 RPM Min/Max: 200.0/600.0 RPM Units: 0.1 RPM	<a href="#">082</a> <a href="#">646</a>
		641	<b>[OilWell Pump Sel]</b>  Selects the type of oil well application. "Disable" (0) - Disables oil well parameters. "Pump Jack" (1) - Sets parameters based on Pump Jack type oil well. "PC Oil Well" (2) - Sets parameters based on Progressive Cavity type Pumps.	Default: 0 "Disable" Options: 0 "Disable" 1 "Pump Jack" 2 "PC Oil Well"	<a href="#">190</a> <a href="#">279</a>
		642	<b>[Gearbox Rating]</b>  Sets the gearbox rating.	Default: 640.0 Kin# Min/Max: 16.0/2560.0 Kin# Units: 0.1 Kin#	
		643	<b>[Gearbox Sheave]</b>  Sets the Sheave diameter on the Gearbox.	Default: 0.25 Inch Min/Max: 0.25/100.00 Inch Units: 0.01 Inch	
		644	<b>[Gearbox Ratio]</b>  Specifies the nameplate gear ratio.	Default: 1.00 Min/Max: 1.00/40.00 Units: 0.01	
		645	<b>[Motor Sheave]</b>  Sets the sheave diameter on the motor.	Default: 10.00 Inch Min/Max: 0.25/25.00 Inch Units: 0.01 Inch	
		646	<b>[Total Gear Ratio]</b>  Displays the calculated total gear ratio as follows: $\frac{[\text{Gearbox Sheave}] \times [\text{Gearbox Ratio}]}{[\text{Motor Sheave}]}$	Default: Read Only Min/Max: 0.00/32000.00 Units: 0.01	
		647	<b>[DB Resistor]</b>  Calculates the negative torque maximum available from the dynamic brake resistor.	Default: 10.4 Ohms Min/Max: 0.0/100.0 Ohms Units: 0.1 Ohms	

File	Group	No.	Parameter Name & Description See <a href="#">page 16</a> for symbol descriptions	Values	Related	
APPLICATIONS	Oil Well Pump	648	<b>[Gearbox Limit]</b> Sets the gearbox torque limit. This value is used in determining the [Pos Torque Limit] & [Neg Torque Limit].	Default: 100.0% Min/Max: 0.0/200.0% Units: 0.1%		
		650	<b>[Adj Volt Phase]</b> "1 Phase" (0) - Select to operate single phase loads connected to the U & V phases. Not designed to operate single phase motors. "3 Phase" (1) - Select to operate three phase loads.	Default: 1 "3 Phase" Options: 0 "1 Phase" 1 "3 Phase"		
		651	<b>[Adj Volt Select]</b> Selects the source of the voltage reference to the drive.	Default: 2 "Analog In 2" Options: 0 "Reserved" 1 "Analog In 1" 2 "Analog In 2" 3-6 "Reserved" 7-8 "Not Used" 9 "MOP Level" 10 "Reserved" 11-17 "Preset Volt1-7" 18-22 "DPI Port 1-5"		
			652	<b>[Adj Volt Ref Hi]</b> Scales the upper value of the [Adj Volt Select] selection when the source is an analog input.	Default: 100.0% Min/Max: -/+100.0% of Drive Rated Volts Units: 0.1%	
			653	<b>[Adj Volt Ref Lo]</b> Scales the lower value of the [Adj Volt Select] selection when the source is an analog input.	Default: 0.0% Min/Max: -/+100.0% of Drive Rated Volts Units: 0.1%	
		Adjust Voltage	654	<b>[Adj Volt Preset1]</b>	Default: 0.0 VAC	
			655	<b>[Adj Volt Preset2]</b>	Min/Max: 0.0/Drive Rated Volts Units: 0.1 VAC	
			656	<b>[Adj Volt Preset3]</b>		
			657	<b>[Adj Volt Preset4]</b>		
			658	<b>[Adj Volt Preset5]</b>		
			659	<b>[Adj Volt Preset6]</b>		
			660	<b>[Adj Volt Preset7]</b> Provides an internal fixed voltage command value that is available as a selection for [Adj Volt Select].		
			661	<b>[Min Adj Voltage]</b> Sets the low limit for the voltage reference when [Motor Cntrl Sel] is set to "Adj Voltage."	Default: 0.0 VAC Min/Max: 0.0/Drive Rated Volts Units: 0.1 VAC	
		662	<b>[Adj Volt Command]</b> Displays the voltage value of the reference specified in [Adj Volt Select].	Default: Read Only Min/Max: 0.0/Drive Rated Volts Units: 0.1 VAC		
		663	<b>[MOP Adj VoltRate]</b> Sets the rate for the MOP.	Default: 1.0 V/s Min/Max: 0.1/100.0 V/s Units: 0.1 V/s		
		669	<b>[Adj Volt TrimSel]</b> Selects the source of the voltage trim that is added to or subtracted from the voltage reference.	Default: 2 "Analog In 2" Options: 0 "Reserved" 1 "Analog In 1" 2 "Analog In 2" 3-6 "Reserved" 7-8 "Not Used" 9 "MOP Level" 10 "Reserved" 11-17 "Preset Volt1-7" 18-22 "DPI Port 1-5"		

File	Group	No.	Parameter Name & Description See <a href="#">page 16</a> for symbol descriptions	Values	Related
APPLICATIONS	Adjust Voltage	670	<b>[Adj Volt Trim Hi]</b>  Scales the upper value of the [Adj Volt TrimSel] selection when the source is an analog input.	Default: 100.0% Min/Max: 0.0/100.0% of Drive Rated Volts Units: 0.1%	
		671	<b>[Adj Volt Trim Lo]</b>  Scales the lower value of the [Adj Volt TrimSel] selection when the source is an analog input.	Default: 0.0% Min/Max: 0.0/100.0% of Drive Rated Volts Units: 0.1%	
		672	<b>[Adj Volt Trim %]</b> Scales the total voltage trim value from all sources. Analog In 1 & 2 are scaled separately with [Adj Volt Trim Hi] & [Adj Volt Trim Lo] then [Adj Volt Trim %] sets the trim value. The sign of this value will determine if trim is added or subtracted from the reference.	Default: 0.0% Min/Max: -/+100.0% of Drive Rated Volts Units: 0.1%	
		675	<b>[Adj Volt AccTime]</b> Sets the rate of voltage increase. The value will be the time it takes to ramp the voltage from [Min Adj Voltage] to [Maximum Voltage]. An "S" curve can be applied to the ramp using parameter 677.	Default: 0.0 Secs Min/Max: 0.0/3600.0 Secs Units: 0.1 Secs	
		676	<b>[Adj Volt DecTime]</b> Sets the rate of voltage decrease. The value will be the time it takes to ramp the voltage from [Maximum Voltage] to [Min Adj Voltage]. An "S" curve can be applied to the ramp using [Adj Volt Scurve]. <b>Important:</b> This ramp and [Decel Time 1/2] (parameters 142/143) must ramp to zero for drive to Stop.	Default: 0.0 Secs Min/Max: 0.0/3600.0 Secs Units: 0.1 Secs	
		677	<b>[Adj Volt S Curve]</b> Sets the percentage of accel or decel time to be applied to the voltage ramp as "S" curve. Time is added 1/2 at the beginning and 1/2 at the end.	Default: 0.0% Min/Max: 0.0/100.0% Units: 0.1%	

# Pos/Spd Profile File

File	Group	No.	Parameter Name & Description See <a href="#">page 16</a> for symbol descriptions	Values	Related
POS/SPD PROFILE	ProfSetup/Status	700	<b>[Pos/Spd Prof Sts]</b> Provides status of the profile/indexer. Bits 0-4 are a binary value. <div style="text-align: center;"> </div>	Read Only	
		701	<b>[Units Traveled]</b> Number of units traveled from the home position.	Default: Read Only Min/Max: -/+ 21474836.47 Units: 0.01	
		702	<sup>v6</sup> <b>[Home Position]</b> A "Find Home" or a "Redefine Pos" sets [Units Traveled] to this value.	Default: 0.00 Min/Max: -/+ 21474836.47 Units: 0.01	<a href="#">701</a>
		705	<b>[Pos/Spd Prof Cmd]</b> Control word for the profile/indexer. The control functions are the same as those in the digital input section. If a digital input is configured to provide the starting step (bits 0-4), then its starting step value takes priority over [Pos/Spd Prof Cmd]. If a digital input is configured for any of bits 8-12, the corresponding functions will respond to the digital input status or the status of [Pos/Spd Prof Cmd]. <div style="text-align: center;"> </div>		
		707	<b>[Encoder Pos Tol]</b> Sets the "At Position" tolerance window (see [Pos/Spd Prof Sts], bit 12) around the encoder count. The value is subtracted from and added to the encoder unit value. It is applied to all steps using encoder units.	Default: 10 Min/Max: 1/50000 Units: 1	
		708	<b>[Counts per Unit]</b> Sets the number of encoder counts equal to one unit. A 1024 PPR quadrature encoder has 4096 pulses (counts) in one revolution.	Default: 4096 Min/Max: 1/1000000 Units: 1	
		711	<b>[Vel Override]</b> This value is a multiplier to the [Step x Velocity] value when "Vel Override" bit of [Pos/Spd Prof Cmd] is set to "1". This is applicable to all step types.	Default: 100.0% Min/Max: 10.0/150.0% Units: 0.1%	



File	Group	No.	Parameter Name & Description See <a href="#">page 16</a> for symbol descriptions	Values	Related
POS/SPD PROFILE	ProfSetup/Status	713	<b>[Find Home Speed]</b> Sets the speed and direction that are active when "Find Home" of [Pos/Spd Prof Cmd] is active. The sign of the value defines direction ("+" = Forward, "-" = Reverse).	Default: +10.0% of [Maximum Speed] Min/Max: -/+50.0% of [Maximum Speed] Units: 0.1 Hz 0.1 RPM	
		714	<b>[Find Home Ramp]</b> Sets the rate of acceleration and deceleration of the Find Home moves.	Default: 10.0 Secs Min/Max: 0.0/3600.0 Secs Units: 0.1 Secs	
		718	<b>[Pos Reg Filter]</b> Sets the error signal filter in the position regulator.	Default: 25.0 Min/Max: 0.0/500.0 Units: 0.1	
		719	<b>[Pos Reg Gain]</b> Sets the gain adjustment for the position regulator.	Default: 4.0 Min/Max: 0.0/200.0 Units: 0.1	
		720	<b>[Step 1 Type]</b>	Default: 1 "Time"	
		730	<b>[Step 2 Type]</b>	Options: 0 "End"	
		740	<b>[Step 3 Type]</b>	1 "Time"	
		750	<b>[Step 4 Type]</b>	2 "Time Blend"	
		760	<b>[Step 5 Type]</b>	3 "Dig Input"	
		770	<b>[Step 6 Type]</b>	4 "Encoder Incr"	
		780	<b>[Step 7 Type]</b>	5 "EnclncrBlend"	
		790	<b>[Step 8 Type]</b>	6 "Encoder Abs"	
		800	<b>[Step 9 Type]</b>	7 "End Hold Pos"	
		810	<b>[Step 10 Type]</b>	8 "Param Level"	
		820	<b>[Step 11 Type]</b>		
		830	<b>[Step 12 Type]</b>		
	840	<b>[Step 13 Type]</b>			
	850	<b>[Step 14 Type]</b>			
	860	<b>[Step 15 Type]</b>			
	870	<b>[Step 16 Type]</b>			
			<p>Selects the type of move for a particular step.</p> <p>The following step types use the <u>velocity regulator</u> only:</p> <p>"End" (0) - drive ramps to zero speed and stops the profile after the programmed dwell time.</p> <p>"Time" (1) - drive ramps to [Step x Velocity], holds speed and decels to zero in specified [Step x Value] time.</p> <p>"Time Blend" (2) - drive ramps to [Step x Velocity], and holds speed until [Step x Value] time completes, then transitions to step defined in [Step x Next].</p> <p>"Dig Input" (3) - drive ramps to [Step x Velocity], holds speed until input specified in [Step x Value] transitions in the direction defined by sign of [Step x Value].</p> <p>"EnclncrBlend" (5) - drive ramps to [Step x Velocity], holds speed, when at encoder position defined by [Step x Value] within tolerance window transition to [Step x Next].</p> <p>"Param Level" (8) - drive ramps to [Step x Velocity], holds speed, and compares [Step x Value] to [Step x Dwell]. The sign of [Step x Value] ("+" = &gt;, "-" = &lt;) determines when to transition [Step x Next] and compares [Step x Dwell] to the value specified by the parameter number in [Step x Value].</p> <p>The following step types use the point-to-point <u>position regulator</u>:</p> <p>"Encoder Incr" (4) - drive ramps to [Step x Velocity], holds speed then ramps to zero at encoder position defined by [Step x Value] within position tolerance window.</p> <p>"Encoder Abs" (6) - drive ramps to [Step x Velocity], in direction required, holds speed, then ramps to zero at position within tolerance window.</p> <p>"End Hold Pos" (7) - drive holds last position for [Step x Dwell] time then stops.</p> <p>The drive must have [Direction Mode] set to "Bipolar" for the position regulator to function properly. Current, Torque and Regen Power Limits must be set so as not to limit the programmed deceleration time. If one of the limits occur, the position regulator can overshoot the position set point. Sleep Mode must be turned off.</p>		

File	Group	No.	Parameter Name & Description See <a href="#">page 16</a> for symbol descriptions	Values	Related	
POS/SPD PROFILE	Profile Step 1-16	721	[Step 1 Velocity]	Default: 0.0		
		731	[Step 2 Velocity]	Min/Max: -/+ [Maximum Speed]		
		741	[Step 3 Velocity]	Units: 0.1 Hz		
		751	[Step 4 Velocity]	0.1 RPM		
		761	[Step 5 Velocity]			
		771	[Step 6 Velocity]			
		781	[Step 7 Velocity]			
		791	[Step 8 Velocity]			
		801	[Step 9 Velocity]			
		811	[Step 10 Velocity]			
		821	[Step 11 Velocity]			
		831	[Step 12 Velocity]			
		841	[Step 13 Velocity]			
		851	[Step 14 Velocity]			
		861	[Step 15 Velocity]			
		871	[Step 16 Velocity]			
				Step Speed – Sign of this value is used to determine direction for Time, Time Blended, Digital Input & Parameter Level step types. The value is an absolute number for all encoder step types		
			722	[Step 1 AccelTime]	Default: 10.0 Secs	
			732	[Step 2 AccelTime]	Min/Max: 0.0/3600.0 Secs	
			742	[Step 3 AccelTime]	Units: 0.1 Secs	
			752	[Step 4 AccelTime]		
			762	[Step 5 AccelTime]		
			772	[Step 6 AccelTime]		
			782	[Step 7 AccelTime]		
			792	[Step 8 AccelTime]		
			802	[Step 9 AccelTime]		
			812	[Step 10 AccelTime]		
			822	[Step 11 AccelTime]		
			832	[Step 12 AccelTime]		
			842	[Step 13 AccelTime]		
			852	[Step 14 AccelTime]		
			862	[Step 15 AccelTime]		
			872	[Step 16 AccelTime]		
					This is the acceleration rate for the step. Sets the time to ramp from zero to [Maximum Speed].	
			723	[Step 1 DecelTime]	Default: 10.0 Secs	
			733	[Step 2 DecelTime]	Min/Max: 0.0/3600.0 Secs	
			743	[Step 3 DecelTime]	Units: 0.1 Secs	
			753	[Step 4 DecelTime]		
			763	[Step 5 DecelTime]		
			773	[Step 6 DecelTime]		
			783	[Step 7 DecelTime]		
			793	[Step 8 DecelTime]		
			803	[Step 9 DecelTime]		
			813	[Step 10 DecelTime]		
			823	[Step 11 DecelTime]		
			833	[Step 12 DecelTime]		
			843	[Step 13 DecelTime]		
			853	[Step 14 DecelTime]		
		863	[Step 15 DecelTime]			
		873	[Step 16 DecelTime]			
				This is the deceleration rate for the step. Sets the time to ramp from [Maximum Speed] to zero.		

File	Group	No.	Parameter Name & Description See <a href="#">page 16</a> for symbol descriptions	Values	Related		
POS/SPD PROFILE	Profile Step 1-16	724	[Step 1 Value]	Default: 6.0 Min/Max: Based on [Step x Type] Units: 0.01 Units dependent on [Step x Type]			
		734	[Step 2 Value]				
		744	[Step 3 Value]				
		754	[Step 4 Value]				
		764	[Step 5 Value]				
		774	[Step 6 Value]				
		784	[Step 7 Value]				
		794	[Step 8 Value]				
		804	[Step 9 Value]				
		814	[Step 10 Value]				
		824	[Step 11 Value]				
		834	[Step 12 Value]				
		844	[Step 13 Value]				
		854	[Step 14 Value]				
		864	[Step 15 Value]				
		874	[Step 16 Value]				
				Sets the step value used for time, time blend, digital input number, parameter level and encoder based units. Also determines the condition to move to the next step.			
				Time/Time Blend: 0.00-3600.00 seconds			
				Digital Input: 1 to 6 (decimal ignored) The sign value "+" makes inputs "active high" and a "-" makes them "active low".			
				Parameter Level: parameter number			
				Encoder Absolute/Encoder Incremental/Encoder Incremental Blend: 99,999.00 units (see <a href="#">Counts per Unit</a> ).			
				725		[Step 1 Dwell]	Default: 10.0 Min/Max: Based on [Step x Type] Units: 0.01 Secs If [Step x Type] = "Param Level," units are the same as the parameter number specified in [Step x Value]
				735		[Step 2 Dwell]	
				745		[Step 3 Dwell]	
				755		[Step 4 Dwell]	
				765		[Step 5 Dwell]	
				775		[Step 6 Dwell]	
				785		[Step 7 Dwell]	
				795		[Step 8 Dwell]	
				805		[Step 9 Dwell]	
				815		[Step 10 Dwell]	
				825		[Step 11 Dwell]	
		835	[Step 12 Dwell]				
		845	[Step 13 Dwell]				
		855	[Step 14 Dwell]				
		865	[Step 15 Dwell]				
		875	[Step 16 Dwell]				
		After the condition to move to the next step has been satisfied, the drive continues at its present velocity or position until the dwell time expires. At that point the next step is executed. Not applicable for blend-type moves.					

File	Group	No.	Parameter Name & Description See <a href="#">page 16</a> for symbol descriptions	Values	Related	
POS/SPD PROFILE	Profile Step 1-16	726	[Step 1 Batch]	Default: 1 Min/Max: 0/1000000 Units: 1		
		736	[Step 2 Batch]			
		746	[Step 3 Batch]			
		756	[Step 4 Batch]			
		766	[Step 5 Batch]			
		776	[Step 6 Batch]			
		786	[Step 7 Batch]			
		796	[Step 8 Batch]			
		806	[Step 9 Batch]			
		816	[Step 10 Batch]			
		826	[Step 11 Batch]			
		836	[Step 12 Batch]			
		846	[Step 13 Batch]			
		856	[Step 14 Batch]			
		866	[Step 15 Batch]			
		876	[Step 16 Batch]			
				Sets the number of times to run this step. "0" = continuously run this step.		
		Profile Step 1-16	727	[Step 1 Next]	Default: 2 Min/Max: 1/16 Units: 1	
			737	[Step 2 Next]		
			747	[Step 3 Next]		
			757	[Step 4 Next]		
			767	[Step 5 Next]		
			777	[Step 6 Next]		
			787	[Step 7 Next]		
			797	[Step 8 Next]		
			807	[Step 9 Next]		
			817	[Step 10 Next]		
	827		[Step 11 Next]			
	837	[Step 12 Next]				
	847	[Step 13 Next]				
	857	[Step 14 Next]				
	867	[Step 15 Next]				
	877	[Step 16 Next]				
			Sets the step number to execute after this step is complete (including [Step x Batch]).			

# Parameter Cross Reference – by Name

Parameter Name	Number	Group	Page
Accel Mask	281	Masks & Owners	<a href="#">56</a>
Accel Owner	293	Masks & Owners	<a href="#">57</a>
Accel Time X	140, 141	Ramp Rates	<a href="#">38</a>
Adj Volt AccTime	675	Adjust Voltage	<a href="#">71</a>
Adj Volt Command	662	Adjust Voltage	<a href="#">70</a>
Adj Volt DecTime	676	Adjust Voltage	<a href="#">71</a>
Adj Volt Phase	650	Adjust Voltage	<a href="#">70</a>
Adj Volt Preset1-7	654-660	Adjust Voltage	<a href="#">70</a>
Adj Volt Ref Hi	652	Adjust Voltage	<a href="#">70</a>
Adj Volt Ref Lo	653	Adjust Voltage	<a href="#">70</a>
Adj Volt S Curve	677	Adjust Voltage	<a href="#">71</a>
Adj Volt Select	651	Adjust Voltage	<a href="#">70</a>
Adj Volt Trim %	672	Adjust Voltage	<a href="#">71</a>
Adj Volt Trim Hi	670	Adjust Voltage	<a href="#">71</a>
Adj Volt Trim Lo	671	Adjust Voltage	<a href="#">71</a>
Adj Volt TrimSel	669	Adjust Voltage	<a href="#">70</a>
Alarm Clear	261	Alarms	<a href="#">53</a>
Alarm Config 1	259	Alarms	<a href="#">53</a>
Alarm X @ Fault	229, 230	Diagnostics	<a href="#">51</a>
Alarm X Code	262-269	Alarms	<a href="#">54</a>
Analog In X Hi	322, 325	Analog Inputs	<a href="#">60</a>
Analog In X Lo	323, 326	Analog Inputs	<a href="#">60</a>
Analog In X Loss	324, 327	Analog Inputs	<a href="#">60</a>
Analog In1 Value	16	Metering	<a href="#">21</a>
Analog In2 Value	17	Metering	<a href="#">21</a>
Analog OutX Hi	343, 346	Analog Outputs	<a href="#">61</a>
Analog OutX Lo	344, 347	Analog Outputs	<a href="#">61</a>
Analog OutX Sel	342, 345	Analog Outputs	<a href="#">61</a>
Anlg In Config	320	Analog Inputs	<a href="#">59</a>
Anlg In Sqr Root	321	Analog Inputs	<a href="#">59</a>
Anlg Out Absolut	341	Analog Outputs	<a href="#">60</a>
Anlg Out Config	340	Analog Outputs	<a href="#">60</a>
Anlg OutX Scale	354, 355	Analog Outputs	<a href="#">61</a>
Anlg OutX Setpt	377, 378	Analog Outputs	<a href="#">61</a>
Auto Rstrt Delay	175	Restart Modes	<a href="#">41</a>
Auto Rstrt Tries	174	Restart Modes	<a href="#">41</a>
Autotune	61	Torq Attributes	<a href="#">25</a>
Autotune Torque	66	Torq Attributes	<a href="#">26</a>
Brake Test Torq	613	Torq Proving	<a href="#">68</a>
Break Frequency	72	Volts per Hertz	<a href="#">27</a>
Break Voltage	71	Volts per Hertz	<a href="#">27</a>
Brk Alarm Travel	610	Torq Proving	<a href="#">68</a>
Brk Release Time	604	Torq Proving	<a href="#">67</a>
Brk Set Time	607	Torq Proving	<a href="#">68</a>
BrkSlip Count	609	Torq Proving	<a href="#">68</a>
Bus Reg Kd	165	Stop/Brake Modes	<a href="#">40</a>
Bus Reg Ki	160	Stop/Brake Modes	<a href="#">39</a>
Bus Reg Kp	164	Stop/Brake Modes	<a href="#">40</a>
Bus Reg Mode X	161, 162	Stop/Brake Modes	<a href="#">40</a>
Commanded Freq	2	Metering	<a href="#">21</a>
Commanded Torque	24	Metering	<a href="#">22</a>
Compensation	56	Torq Attributes	<a href="#">24</a>
Control Status	440	Torq Attributes	<a href="#">27</a>
Control SW Ver	29	Drive Data	<a href="#">22</a>
Counts Per Unit	708	ProfSetup/Status	<a href="#">72</a>
Current Lmt Gain	149	Load Limits	<a href="#">38</a>
Current Lmt Sel	147	Load Limits	<a href="#">38</a>
Current Lmt Val	148	Load Limits	<a href="#">38</a>
Current Rate Limit	154	Load Limits	<a href="#">39</a>
Data In XX	300-307	Datalinks	<a href="#">58</a>
Data Out XX	310-317	Datalinks	<a href="#">58</a>
DB Resistor	647	Oil Well Pump	<a href="#">69</a>
DB Resistor Type	163	Stop/Brake Modes	<a href="#">40</a>
DB While Stopped	145	Stop/Brake Modes	<a href="#">39</a>
DC Brake Level	158	Stop/Brake Modes	<a href="#">39</a>
DC Brake Time	159	Stop/Brake Modes	<a href="#">39</a>
DC Brk Lvl Sel	157	Stop/Brake Modes	<a href="#">39</a>
DC Bus Memory	13	Metering	<a href="#">21</a>
DC Bus Voltage	12	Metering	<a href="#">21</a>
Decel Mask	282	Masks & Owners	<a href="#">56</a>
Decel Owner	294	Masks & Owners	<a href="#">57</a>
Decel Time X	142, 143	Ramp Rates	<a href="#">38</a>
DigIn DataLogic	411	Digital Inputs	<a href="#">64</a>
Dig In Status	216	Diagnostics	<a href="#">49</a>
Digital InX Sel	361-366	Digital Inputs	<a href="#">63</a>

Parameter Name	Number	Group	Page
Digital OutX Sel	380, 384, 388	Digital Outputs	<a href="#">65</a>
Dig Out Invert	392	Digital Outputs	<a href="#">66</a>
Dig Out Mask	394	Digital Outputs	<a href="#">66</a>
Dig Out Param	393	Digital Outputs	<a href="#">66</a>
Dig Out Setpt	379	Digital Outputs	<a href="#">64</a>
Dig Out Status	217	Diagnostics	<a href="#">49</a>
Dig OutX Level	381, 385, 389	Digital Outputs	<a href="#">65</a>
Dig OutX OffTime	383, 387, 391	Digital Outputs	<a href="#">65</a>
Dig OutX OnTime	382, 386, 390	Digital Outputs	<a href="#">65</a>
Direction Mask	279	Masks & Owners	<a href="#">56</a>
Direction Mode	190	Direction Config	<a href="#">44</a>
Direction Owner	291	Masks & Owners	<a href="#">57</a>
DPI Baud Rate	270	Comm Control	<a href="#">55</a>
DPI Fdbk Select	299	Comm Control	<a href="#">56</a>
DPI Loss Action	173	HIM Ref Config	<a href="#">44</a>
DPI Port Sel	274	Comm Control	<a href="#">55</a>
DPI Port Value	275	Comm Control	<a href="#">55</a>
DPI Ref Select	298	Comm Control	<a href="#">55</a>
Drive Alarm X	211, 212	Diagnostics	<a href="#">47</a>
Drive Checksum	203	Drive Memory	<a href="#">46</a>
Drive Logic Rslt	271	Comm Control	<a href="#">55</a>
Drive OL Count	219	Diagnostics	<a href="#">49</a>
Drive OL Mode	150	Load Limits	<a href="#">38</a>
Drive Ramp Rslt	273	Comm Control	<a href="#">55</a>
Drive Ref Rslt	272	Comm Control	<a href="#">55</a>
Drive Status 1, 2	209, 210	Diagnostics	<a href="#">47</a>
Drive Status 3	222	Diagnostics	<a href="#">50</a>
Drive Temp	218	Diagnostics	<a href="#">49</a>
Droop RPM @ FLA	152	Load Limits	<a href="#">38</a>
Dyn UserSet Actv	206	Drive Memory	<a href="#">46</a>
Dyn UserSet Cnfg	204	Drive Memory	<a href="#">46</a>
Dyn UserSet Sel	205	Drive Memory	<a href="#">46</a>
Elapsed kWh	14	Metering	<a href="#">21</a>
Elapsed MWh	9	Metering	<a href="#">21</a>
Elapsed Run Time	10	Metering	<a href="#">21</a>
Enc Position Fdbk	414	Speed Feedback	<a href="#">28</a>
Encoder Pos Tol	707	ProfSetup/Status	<a href="#">72</a>
Encoder PPR	413	Speed Feedback	<a href="#">28</a>
Encoder Speed	415	Speed Feedback	<a href="#">28</a>
Encoder Z Chan	423	Speed Feedback	<a href="#">28</a>
Fault 1 Code	243	Faults	<a href="#">52</a>
Fault 1 Time	244	Faults	<a href="#">53</a>
Fault 2 Code	245	Faults	<a href="#">52</a>
Fault 2 Time	246	Faults	<a href="#">53</a>
Fault 3 Code	247	Faults	<a href="#">52</a>
Fault 3 Time	248	Faults	<a href="#">53</a>
Fault 4 Code	249	Faults	<a href="#">52</a>
Fault 4 Time	250	Faults	<a href="#">53</a>
Fault 5 Code	251	Faults	<a href="#">52</a>
Fault 5 Time	252	Faults	<a href="#">53</a>
Fault 6 Code	253	Faults	<a href="#">52</a>
Fault 6 Time	254	Faults	<a href="#">53</a>
Fault 7 Code	255	Faults	<a href="#">52</a>
Fault 7 Time	256	Faults	<a href="#">53</a>
Fault 8 Code	257	Faults	<a href="#">52</a>
Fault 8 Time	258	Faults	<a href="#">53</a>
Fault Amps	225	Diagnostics	<a href="#">50</a>
Fault Bus Volts	226	Diagnostics	<a href="#">50</a>
Fault Clear	240	Faults	<a href="#">52</a>
Fault Clear Mode	241	Faults	<a href="#">52</a>
Fault Ctr Mask	283	Masks & Owners	<a href="#">56</a>
Fault Ctr Owner	295	Masks & Owners	<a href="#">57</a>
Fault Config 1	238	Faults	<a href="#">52</a>
Fault Speed	224	Diagnostics	<a href="#">50</a>
Fdbk Filter Sel	416	Speed Feedback	<a href="#">28</a>
Feedback Select	80	Spd Mode & Limits	<a href="#">29</a>
Find Home Ramp	714	ProfSetup/Status	<a href="#">73</a>
Find Home Speed	713	ProfSetup/Status	<a href="#">73</a>
Float Tolerance	606	Torq Proving	<a href="#">68</a>
Flux Braking	166	Stop/Brake Modes	<a href="#">40</a>
Flux Current	5	Metering	<a href="#">21</a>
Flux Current Ref	63	Torq Attributes	<a href="#">25</a>
Flux Up Mode	57	Torq Attributes	<a href="#">25</a>
Flux Up Time	58	Torq Attributes	<a href="#">25</a>

Parameter Name	Number	Group	Page
Flying Start En	169	Restart Modes	<a href="#">41</a>
Flying StartGain	170	Restart Modes	<a href="#">41</a>
Gearbox Limit	648	Oil Well Pump	<a href="#">69</a>
Gearbox Rating	642	Oil Well Pump	<a href="#">69</a>
Gearbox Sheave	643	Oil Well Pump	<a href="#">69</a>
Gearbox Ratio	644	Oil Well Pump	<a href="#">69</a>
Gnd Warn Level	177	Power Loss	<a href="#">43</a>
HighRes Ref	308	Datalinks	<a href="#">58</a>
Home Position	702	ProfSetup/Status	<a href="#">72</a>
Inertia Autotune	67	Torq Attributes	<a href="#">26</a>
IR Voltage Drop	62	Torq Attributes	<a href="#">25</a>
Ixo Voltage Drop	64	Torq Attributes	<a href="#">26</a>
Jog Mask	278	Masks & Owners	<a href="#">56</a>
Jog Owner	290	Masks & Owners	<a href="#">57</a>
Jog Speed 1	100	Discrete Speeds	<a href="#">32</a>
Jog Speed 2	108	Discrete Speeds	<a href="#">33</a>
Kf Speed Loop	447	Speed Regulator	<a href="#">37</a>
Ki Speed Loop	445	Speed Regulator	<a href="#">37</a>
Kp Speed Loop	446	Speed Regulator	<a href="#">37</a>
Language	201	Drive Memory	<a href="#">46</a>
Last Stop Source	215	Diagnostics	<a href="#">49</a>
Load Frm Usr Set	198	Drive Memory	<a href="#">45</a>
Load Loss Level	187	Power Loss	<a href="#">43</a>
Load Loss Time	188	Power Loss	<a href="#">43</a>
Local Mask	285	Masks & Owners	<a href="#">57</a>
Local Owner	297	Masks & Owners	<a href="#">57</a>
Logic Mask	276	Masks & Owners	<a href="#">56</a>
		Security	<a href="#">59</a>
Logic Mask Act	598	Security	<a href="#">59</a>
Man Ref Preload	193	HIM Ref Config	<a href="#">44</a>
Marker Pulse	421	Speed Feedback	<a href="#">28</a>
Maximum Freq	55	Torq Attributes	<a href="#">24</a>
Maximum Speed	82	Spd Mode & Limits	<a href="#">29</a>
Maximum Voltage	54	Torq Attributes	<a href="#">24</a>
Max Rod Speed	640	Oil Well Pump	<a href="#">69</a>
Max Rod Torque	638	Oil Well Pump	<a href="#">69</a>
MicroPos Scale%	611	Torq Proving	<a href="#">68</a>
Min Adj Voltage	661	Adjust Voltage	<a href="#">70</a>
Minimum Speed	81	Spd Mode & Limits	<a href="#">29</a>
Min Rod Speed	639	Oil Well Pump	<a href="#">69</a>
MOP Adj VoltRate	663	Adjust Voltage	<a href="#">70</a>
MOP Mask	284	Masks & Owners	<a href="#">57</a>
MOP Owner	296	Masks & Owners	<a href="#">57</a>
MOP Rate	195	MOP Config	<a href="#">45</a>
MOP Reference	11	Metering	<a href="#">21</a>
Motor Cntl Sel	53	Torq Attributes	<a href="#">24</a>
Motor Fdbk Type	412	Speed Feedback	<a href="#">27</a>
Motor NP FLA	42	Motor Data	<a href="#">23</a>
Motor NP Hertz	43	Motor Data	<a href="#">23</a>
Motor NP Power	45	Motor Data	<a href="#">23</a>
Motor NP RPM	44	Motor Data	<a href="#">23</a>
Motor NP Volts	41	Motor Data	<a href="#">23</a>
Motor OL Count	220	Diagnostics	<a href="#">49</a>
Motor OL Factor	48	Motor Data	<a href="#">23</a>
Motor OL Hertz	47	Motor Data	<a href="#">23</a>
Motor OL Mode	50	Motor Data	<a href="#">23</a>
Motor Poles	49	Motor Data	<a href="#">23</a>
Motor Sheave	645	Oil Well Pump	<a href="#">69</a>
Motor Type	40	Motor Data	<a href="#">23</a>
Mtr NP Pwr Units	46	Motor Data	<a href="#">23</a>
Mtr OL Trip Time	221	Diagnostics	<a href="#">49</a>
Mtr Tor Cur Ref	441	Torq Attributes	<a href="#">27</a>
Neg Torque Limit	437	Torq Attributes	<a href="#">27</a>
Notch Filter Freq	419	Speed Feedback	<a href="#">28</a>
Notch Filter K	420	Speed Feedback	<a href="#">28</a>
OilWell Pump Sel	641	Oil Well Pump	<a href="#">69</a>
Output Current	3	Metering	<a href="#">21</a>
Output Freq	1	Metering	<a href="#">21</a>
Output Power	7	Metering	<a href="#">21</a>
Output Powr Fctr	8	Metering	<a href="#">21</a>
Output Voltage	6	Metering	<a href="#">21</a>
Overspeed Limit	83	Spd Mode & Limits	<a href="#">29</a>
Param Access Lvl	196	Drive Memory	<a href="#">45</a>
PCP Pump Sheave	637	Oil Well Pump	<a href="#">69</a>
PI BW Filter	139	Process PI	<a href="#">36</a>
PI Configuration	124	Process PI	<a href="#">34</a>
PI Control	125	Process PI	<a href="#">34</a>

Parameter Name	Number	Group	Page
PI Deriv Time	459	Process PI	<a href="#">36</a>
PI Error Meter	137	Process PI	<a href="#">36</a>
PI Fdbk Meter	136	Process PI	<a href="#">36</a>
PI Feedback Hi	462	Process PI	<a href="#">36</a>
PI Feedback Lo	463	Process PI	<a href="#">36</a>
PI Feedback Sel	128	Process PI	<a href="#">35</a>
PI Integral Time	129	Process PI	<a href="#">35</a>
PI Lower Limit	131	Process PI	<a href="#">35</a>
PI Output Gain	464	Process PI	<a href="#">36</a>
PI Output Meter	138	Process PI	<a href="#">36</a>
PI Preload	133	Process PI	<a href="#">36</a>
PI Prop Gain	130	Process PI	<a href="#">35</a>
PI Ref Meter	135	Process PI	<a href="#">36</a>
PI Reference Hi	460	Process PI	<a href="#">36</a>
PI Reference Lo	461	Process PI	<a href="#">36</a>
PI Reference Sel	126	Process PI	<a href="#">35</a>
PI Setpoint	127	Process PI	<a href="#">35</a>
PI Status	134	Process PI	<a href="#">36</a>
PI Upper Limit	132	Process PI	<a href="#">36</a>
Port Mask Act	595	Security	<a href="#">58</a>
Pos Reg Filter	718	ProfSetup/Status	<a href="#">73</a>
Pos Reg Gain	719	ProfSetup/Status	<a href="#">73</a>
Pos Torque Limit	436	Torq Attributes	<a href="#">26</a>
Pos/Spd Prof Cmd	705	ProfSetup/Status	<a href="#">72</a>
Pos/Spd Prof Sts	700	ProfSetup/Status	<a href="#">72</a>
Power Loss Level	186	Power Loss	<a href="#">43</a>
Power Loss Mode	184	Power Loss	<a href="#">43</a>
Power Loss Time	185	Power Loss	<a href="#">43</a>
Power Up Marker	242	Faults	<a href="#">52</a>
Powerup Delay	167	Restart Modes	<a href="#">41</a>
Preset Speed 1-7	101-107	Discrete Speeds	<a href="#">32</a>
PTC HW Value	18	Metering	<a href="#">22</a>
Pulse In Scale	422	Speed Feedback	<a href="#">28</a>
Pulse Input Ref	99	Speed Reference	<a href="#">32</a>
PWM Frequency	151	Load Limits	<a href="#">38</a>
Ramped Speed	22	Metering	<a href="#">22</a>
Rated Amps	28	Drive Data	<a href="#">22</a>
Rated kW	26	Drive Data	<a href="#">22</a>
Rated Volts	27	Drive Data	<a href="#">22</a>
Reference Mask	280	Masks & Owners	<a href="#">56</a>
Reference Owner	292	Masks & Owners	<a href="#">57</a>
Regen Power Limit	153	Load Limits	<a href="#">39</a>
Reset Meters	200	Drive Memory	<a href="#">45</a>
Reset To Defaults	197	Drive Memory	<a href="#">45</a>
Rev Speed Limit	454	Speed Regulator	<a href="#">30</a>
Rod Load Torque	631	Oil Well Pump	<a href="#">68</a>
Run Boost	70	Volts per Hertz	<a href="#">27</a>
S Curve %	146	Ramp Rates	<a href="#">38</a>
Save HIM Ref	192	HIM Ref Config	<a href="#">44</a>
Save MOP Ref	194	MOP Config	<a href="#">45</a>
Save To User Set	199	Drive Memory	<a href="#">45</a>
ScaleX In Hi	477-495	Scaled Blocks	<a href="#">54</a>
ScaleX In Lo	478-496	Scaled Blocks	<a href="#">54</a>
ScaleX In Value	476-494	Scaled Blocks	<a href="#">54</a>
ScaleX Out Hi	479-497	Scaled Blocks	<a href="#">54</a>
ScaleX Out Lo	480-498	Scaled Blocks	<a href="#">54</a>
ScaleX Out Value	481-499	Scaled Blocks	<a href="#">54</a>
Shear Pin Time	189	Power Loss	<a href="#">43</a>
Skip Freq Band	87	Spd Mode & Limits	<a href="#">30</a>
Skip Frequency 1-3	84-86	Spd Mode & Limits	<a href="#">30</a>
Sleep Level	182	Restart Modes	<a href="#">43</a>
Sleep Time	183	Restart Modes	<a href="#">43</a>
Sleep-Wake Mode	178	Restart Modes	<a href="#">42</a>
Sleep-Wake Ref	179	Restart Modes	<a href="#">42</a>
Slip Comp Gain	122	Slip Comp	<a href="#">34</a>
Slip RPM @ FLA	121	Slip Comp	<a href="#">34</a>
Slip RPM Meter	123	Slip Comp	<a href="#">34</a>
Spd Dev Band	602	Torq Proving	<a href="#">67</a>
Spd Err Filr BW	448	Speed Regulator	<a href="#">37</a>
Spd Fdbk No Filr	21	Metering	<a href="#">22</a>
SpdBand Integrat	603	Torq Proving	<a href="#">67</a>
Speed Desired BW	449	Speed Regulator	<a href="#">37</a>
Speed Feedback	25	Metering	<a href="#">22</a>
Speed Loop Meter	451	Speed Regulator	<a href="#">37</a>
Speed Ref Source	213	Diagnostics	<a href="#">48</a>
Speed Ref X Hi	91, 94	Speed Reference	<a href="#">31</a>
Speed Ref X Lo	92, 95	Speed Reference	<a href="#">31</a>

Parameter Name	Number	Group	Page
Speed Ref X Sel	90, 93	Speed Reference	<a href="#">31</a>
Speed Reference	23	Metering	<a href="#">22</a>
Speed Units	79	Spd Mode & Limits	<a href="#">29</a>
Speed/Torque Mod	88	Spd Mode & Limits	<a href="#">30</a>
Start At PowerUp	168	Restart Modes	<a href="#">41</a>
Start Inhibits	214	Diagnostics	<a href="#">48</a>
Start Mask	277	Masks & Owners	<a href="#">56</a>
Start Owner	289	Masks & Owners	<a href="#">57</a>
Start/Acc Boost	69	Volts per Hertz	<a href="#">27</a>
Status 1, 2 @ Fault	227, 228	Diagnostics	<a href="#">50</a>
Status 3 @ Fault	223	Diagnostics	<a href="#">50</a>
Step x AccelTime	722...	Profile Setup	<a href="#">74</a>
Step x Batch	726...	Profile Setup	<a href="#">76</a>
Step x DecelTime	723...	Profile Setup	<a href="#">74</a>
Step x Dwell	725...	Profile Setup	<a href="#">75</a>
Step x Next	727...	Profile Setup	<a href="#">76</a>
Step x Type	720...	Profile Setup	<a href="#">73</a>
Step x Value	724...	Profile Setup	<a href="#">75</a>
Step x Velocity	721...	Profile Setup	<a href="#">74</a>
Stop Dwell Time	452	Stop/Brake Modes	<a href="#">40</a>
Stop Mode X	155, 156	Stop/Brake Modes	<a href="#">39</a>
Stop Owner	288	Masks & Owners	<a href="#">57</a>
SV Boost Filter	59	Torq Attributes	<a href="#">25</a>
TB Man Ref Hi	97	Speed Reference	<a href="#">32</a>
TB Man Ref Lo	98	Speed Reference	<a href="#">32</a>
TB Man Ref Sel	96	Speed Reference	<a href="#">32</a>
Testpoint X Data	235, 237	Diagnostics	<a href="#">51</a>
Testpoint X Sel	234, 236	Diagnostics	<a href="#">51</a>
Torq Ref A Div	430	Torq Attributes	<a href="#">26</a>
TorqAlarm Level	632	Oil Well Pump	<a href="#">68</a>
TorqAlarm Action	633	Oil Well Pump	<a href="#">68</a>
TorqAlarm Dwell	634	Oil Well Pump	<a href="#">69</a>
TorqAlarm Timeout	635	Oil Well Pump	<a href="#">69</a>
TorqAlrm TO Act	636	Oil Well Pump	<a href="#">69</a>
TorqLim SlewRate	608	Torq Proving	<a href="#">68</a>
TorqProve Cnfg	600	Torq Proving	<a href="#">67</a>
TorqProve Setup	601	Torq Proving	<a href="#">67</a>
TorqProve Status	612	Torq Proving	<a href="#">68</a>
Torque Current	4	Metering	<a href="#">21</a>
Torque Ref B Mult	434	Torq Attributes	<a href="#">26</a>
Torque Ref X Hi	428, 432	Torq Attributes	<a href="#">26</a>
Torque Ref X Lo	429, 433	Torq Attributes	<a href="#">26</a>
Torque Ref X Sel	427, 431	Torq Attributes	<a href="#">26</a>
Torque Setpoint	435	Torq Attributes	<a href="#">26</a>
Torque Setpoint2	438	Torq Attributes	<a href="#">27</a>
Total Gear Ratio	646	Oil Well Pump	<a href="#">69</a>
Total Inertia	450	Speed Regulator	<a href="#">37</a>
Trim % Setpoint	116	Speed Trim	<a href="#">33</a>
Trim Hi	119	Speed Trim	<a href="#">33</a>
Trim In Select	117	Speed Trim	<a href="#">33</a>
Trim Lo	120	Speed Trim	<a href="#">33</a>
Trim Out Select	118	Speed Trim	<a href="#">33</a>
Units Traveled	701	ProfSetup/Status	<a href="#">72</a>
Vel Override	711	ProfSetup/Status	<a href="#">72</a>
Voltage Class	202	Drive Memory	<a href="#">46</a>
Wake Level	180	Restart Modes	<a href="#">42</a>
Wake Time	181	Restart Modes	<a href="#">42</a>
Write Mask Act	597	Security	<a href="#">59</a>
Write Mask Cfg	596	Security	<a href="#">58</a>
ZeroSpdFloatTime	605	Torq Proving	<a href="#">67</a>

## Parameter Cross Reference – by Number

Number	Parameter Name	Group	Page
1	Output Freq	Metering	<a href="#">21</a>
2	Commanded Freq	Metering	<a href="#">21</a>
3	Output Current	Metering	<a href="#">21</a>
4	Torque Current	Metering	<a href="#">21</a>
5	Flux Current	Metering	<a href="#">21</a>
6	Output Voltage	Metering	<a href="#">21</a>
7	Output Power	Metering	<a href="#">21</a>
8	Output Powr Fctr	Metering	<a href="#">21</a>
9	Elapsed MWh	Metering	<a href="#">21</a>
10	Elapsed Run Time	Metering	<a href="#">21</a>
11	MOP Reference	Metering	<a href="#">21</a>
12	DC Bus Voltage	Metering	<a href="#">21</a>
13	DC Bus Memory	Metering	<a href="#">21</a>
14	Elapsed kWh	Metering	<a href="#">21</a>
16	Analog In1 Value	Metering	<a href="#">21</a>
17	Analog In2 Value	Metering	<a href="#">21</a>
18	PTC HW Value	Metering	<a href="#">22</a>
21	Spd Fdbk No Filt	Metering	<a href="#">22</a>
22	Ramped Speed	Metering	<a href="#">22</a>
23	Speed Reference	Metering	<a href="#">22</a>
24	Commanded Torque	Metering	<a href="#">22</a>
25	Speed Feedback	Metering	<a href="#">22</a>
26	Rated kW	Drive Data	<a href="#">22</a>
27	Rated Volts	Drive Data	<a href="#">22</a>
28	Rated Amps	Drive Data	<a href="#">22</a>
29	Control SW Ver	Drive Data	<a href="#">22</a>
40	Motor Type	Motor Data	<a href="#">23</a>
41	Motor NP Volts	Motor Data	<a href="#">23</a>
42	Motor NP FLA	Motor Data	<a href="#">23</a>
43	Motor NP Hertz	Motor Data	<a href="#">23</a>
44	Motor NP RPM	Motor Data	<a href="#">23</a>
45	Motor NP Power	Motor Data	<a href="#">23</a>
46	Mtr NP Pwr Units	Motor Data	<a href="#">23</a>
47	Motor OL Hertz	Motor Data	<a href="#">23</a>
48	Motor OL Factor	Motor Data	<a href="#">23</a>
49	Motor Poles	Motor Data	<a href="#">23</a>
50	Motor OL Mode	Motor Data	<a href="#">23</a>
53	Motor Cntl Sel	Torq Attributes	<a href="#">24</a>
54	Maximum Voltage	Torq Attributes	<a href="#">24</a>
55	Maximum Freq	Torq Attributes	<a href="#">24</a>
56	Compensation	Torq Attributes	<a href="#">24</a>
57	Flux Up Mode	Torq Attributes	<a href="#">25</a>
58	Flux Up Time	Torq Attributes	<a href="#">25</a>
59	SV Boost Filter	Torq Attributes	<a href="#">25</a>
61	Autotune	Torq Attributes	<a href="#">25</a>
62	IR Voltage Drop	Torq Attributes	<a href="#">25</a>
63	Flux Current Ref	Torq Attributes	<a href="#">25</a>
64	Ixo Voltage Drop	Torq Attributes	<a href="#">26</a>
66	Autotune Torque	Torq Attributes	<a href="#">26</a>
67	Inertia Autotune	Torq Attributes	<a href="#">26</a>
69	Start/Acc Boost	Volts per Hertz	<a href="#">27</a>
70	Run Boost	Volts per Hertz	<a href="#">27</a>
71	Break Voltage	Volts per Hertz	<a href="#">27</a>
72	Break Frequency	Volts per Hertz	<a href="#">27</a>
79	Speed Units	Spd Mode & Limits	<a href="#">29</a>
80	Feedback Select	Spd Mode & Limits	<a href="#">29</a>
81	Minimum Speed	Spd Mode & Limits	<a href="#">29</a>
82	Maximum Speed	Spd Mode & Limits	<a href="#">29</a>
83	Overspeed Limit	Spd Mode & Limits	<a href="#">29</a>
84-86	Skip Frequency 1-3	Spd Mode & Limits	<a href="#">30</a>
87	Skip Freq Band	Spd Mode & Limits	<a href="#">30</a>
88	Speed/Torque Mod	Spd Mode & Limits	<a href="#">30</a>
90, 93	Speed Ref X Sel	Speed Reference	<a href="#">31</a>
91, 94	Speed Ref X Hi	Speed Reference	<a href="#">31</a>
92, 95	Speed Ref X Lo	Speed Reference	<a href="#">31</a>
96	TB Man Ref Sel	Speed Reference	<a href="#">32</a>
97	TB Man Ref Hi	Speed Reference	<a href="#">32</a>
98	TB Man Ref Lo	Speed Reference	<a href="#">32</a>
99	Pulse Input Ref	Speed Reference	<a href="#">32</a>
100	Jog Speed 1	Discrete Speeds	<a href="#">32</a>
101-107	Preset Speed 1-7	Discrete Speeds	<a href="#">32</a>
108	Jog Speed 2	Discrete Speeds	<a href="#">33</a>
116	Trim % Setpoint	Speed Trim	<a href="#">33</a>
117	Trim In Select	Speed Trim	<a href="#">33</a>
118	Trim Out Select	Speed Trim	<a href="#">33</a>
119	Trim Hi	Speed Trim	<a href="#">33</a>

Number	Parameter Name	Group	Page
120	Trim Lo	Speed Trim	<a href="#">33</a>
121	Slip RPM @ FLA	Slip Comp	<a href="#">34</a>
122	Slip Comp Gain	Slip Comp	<a href="#">34</a>
123	Slip RPM Meter	Slip Comp	<a href="#">34</a>
124	PI Configuration	Process PI	<a href="#">34</a>
125	PI Control	Process PI	<a href="#">34</a>
126	PI Reference Sel	Process PI	<a href="#">35</a>
127	PI Setpoint	Process PI	<a href="#">35</a>
128	PI Feedback Sel	Process PI	<a href="#">35</a>
129	PI Integral Time	Process PI	<a href="#">35</a>
130	PI Prop Gain	Process PI	<a href="#">35</a>
131	PI Lower Limit	Process PI	<a href="#">35</a>
132	PI Upper Limit	Process PI	<a href="#">36</a>
133	PI Preload	Process PI	<a href="#">36</a>
134	PI Status	Process PI	<a href="#">36</a>
135	PI Ref Meter	Process PI	<a href="#">36</a>
136	PI Fdbk Meter	Process PI	<a href="#">36</a>
137	PI Error Meter	Process PI	<a href="#">36</a>
138	PI Output Meter	Process PI	<a href="#">36</a>
139	PI BW Filter	Process PI	<a href="#">36</a>
140, 141	Accel Time X	Ramp Rates	<a href="#">38</a>
142, 143	Decel Time X	Ramp Rates	<a href="#">38</a>
145	DB While Stopped	Stop/Brake Modes	<a href="#">39</a>
146	S Curve %	Ramp Rates	<a href="#">38</a>
147	Current Lmt Sel	Load Limits	<a href="#">38</a>
148	Current Lmt Val	Load Limits	<a href="#">38</a>
149	Current Lmt Gain	Load Limits	<a href="#">38</a>
150	Drive OL Mode	Load Limits	<a href="#">38</a>
151	PWM Frequency	Load Limits	<a href="#">38</a>
152	Droop RPM @ FLA	Load Limits	<a href="#">38</a>
153	Regen Power Limit	Load Limits	<a href="#">39</a>
154	Current Rate Limit	Load Limits	<a href="#">39</a>
155, 156	Stop Mode X	Stop/Brake Modes	<a href="#">39</a>
157	DC Brk Lvl Sel	Stop/Brake Modes	<a href="#">39</a>
158	DC Brake Level	Stop/Brake Modes	<a href="#">39</a>
159	DC Brake Time	Stop/Brake Modes	<a href="#">39</a>
160	Bus Reg Ki	Stop/Brake Modes	<a href="#">39</a>
161, 162	Bus Reg Mode X	Stop/Brake Modes	<a href="#">40</a>
163	DB Resistor Type	Stop/Brake Modes	<a href="#">40</a>
164	Bus Reg Kp	Stop/Brake Modes	<a href="#">40</a>
165	Bus Reg Kd	Stop/Brake Modes	<a href="#">40</a>
166	Flux Braking	Stop/Brake Modes	<a href="#">40</a>
167	Powerup Delay	Restart Modes	<a href="#">41</a>
168	Start At PowerUp	Restart Modes	<a href="#">41</a>
169	Flying Start En	Restart Modes	<a href="#">41</a>
170	Flying StartGain	Restart Modes	<a href="#">41</a>
173	DPI Loss Action	HIM Ref Config	<a href="#">44</a>
174	Auto Rstrt Tries	Restart Modes	<a href="#">41</a>
175	Auto Rstrt Delay	Restart Modes	<a href="#">41</a>
177	Gnd Warn Level	Power Loss	<a href="#">43</a>
178	Sleep-Wake Mode	Restart Modes	<a href="#">42</a>
179	Sleep-Wake Ref	Restart Modes	<a href="#">42</a>
180	Wake Level	Restart Modes	<a href="#">42</a>
181	Wake Time	Restart Modes	<a href="#">42</a>
182	Sleep Level	Restart Modes	<a href="#">43</a>
183	Sleep Time	Restart Modes	<a href="#">43</a>
184	Power Loss Mode	Power Loss	<a href="#">43</a>
185	Power Loss Time	Power Loss	<a href="#">43</a>
186	Power Loss Level	Power Loss	<a href="#">43</a>
187	Load Loss Level	Power Loss	<a href="#">43</a>
188	Load Loss Time	Power Loss	<a href="#">43</a>
189	Shear Pin Time	Power Loss	<a href="#">43</a>
190	Direction Mode	Direction Config	<a href="#">44</a>
192	Save HIM Ref	HIM Ref Config	<a href="#">44</a>
193	Man Ref Preload	HIM Ref Config	<a href="#">44</a>
194	Save MOP Ref	MOP Config	<a href="#">45</a>
195	MOP Rate	MOP Config	<a href="#">45</a>
196	Param Access Lvl	Drive Memory	<a href="#">45</a>
197	Reset To Defaults	Drive Memory	<a href="#">45</a>
198	Load Frm Usr Set	Drive Memory	<a href="#">45</a>
199	Save To User Set	Drive Memory	<a href="#">45</a>
200	Reset Meters	Drive Memory	<a href="#">45</a>
201	Language	Drive Memory	<a href="#">46</a>
202	Voltage Class	Drive Memory	<a href="#">46</a>
203	Drive Checksum	Drive Memory	<a href="#">46</a>
204	Dyn UserSet Cnfg	Drive Memory	<a href="#">46</a>
205	Dyn UserSet Sel	Drive Memory	<a href="#">46</a>



Number	Parameter Name	Group	Page
206	Dyn UserSet Actv	Drive Memory	46
209, 210	Drive Status X	Diagnostics	47
211, 212	Drive Alarm X	Diagnostics	47
213	Speed Ref Source	Diagnostics	48
214	Start Inhibits	Diagnostics	48
215	Last Stop Source	Diagnostics	49
216	Dig In Status	Diagnostics	49
217	Dig Out Status	Diagnostics	49
218	Drive Temp	Diagnostics	49
219	Drive OL Count	Diagnostics	49
220	Motor OL Count	Diagnostics	49
221	Mtr OL Trip Time	Diagnostics	49
222	Drive Status 3	Diagnostics	50
223	Status 3 @ Fault	Diagnostics	50
224	Fault Speed	Diagnostics	50
225	Fault Amps	Diagnostics	50
226	Fault Bus Volts	Diagnostics	50
227, 228	Status X @ Fault	Diagnostics	50
229, 230	Alarm X @ Fault	Diagnostics	51
234, 236	Testpoint X Sel	Diagnostics	51
235, 237	Testpoint X Data	Diagnostics	51
238	Fault Config 1	Faults	52
240	Fault Clear	Faults	52
241	Fault Clear Mode	Faults	52
242	Power Up Marker	Faults	52
243	Fault 1 Code	Faults	52
244	Fault 1 Time	Faults	53
245	Fault 2 Code	Faults	52
246	Fault 2 Time	Faults	53
247	Fault 3 Code	Faults	52
248	Fault 3 Time	Faults	53
249	Fault 4 Code	Faults	52
250	Fault 4 Time	Faults	53
251	Fault 5 Code	Faults	52
252	Fault 5 Time	Faults	53
253	Fault 6 Code	Faults	52
254	Fault 6 Time	Faults	53
255	Fault 7 Code	Faults	52
256	Fault 7 Time	Faults	53
257	Fault 8 Code	Faults	52
258	Fault 8 Time	Faults	53
259	Alarm Config 1	Alarms	53
261	Alarm Clear	Alarms	53
262-269	Alarm X Code	Alarms	54
270	DPI Baud Rate	Comm Control	55
271	Drive Logic Rslt	Comm Control	55
272	Drive Ref Rslt	Comm Control	55
273	Drive Ramp Rslt	Comm Control	55
274	DPI Port Sel	Comm Control	55
275	DPI Port Value	Comm Control	55
276	Logic Mask	Masks & Owners	56
		Security	59
277	Start Mask	Masks & Owners	56
278	Jog Mask	Masks & Owners	56
279	Direction Mask	Masks & Owners	56
280	Reference Mask	Masks & Owners	56
281	Accel Mask	Masks & Owners	56
282	Decel Mask	Masks & Owners	56
283	Fault Ctr Mask	Masks & Owners	56
284	MOP Mask	Masks & Owners	57
285	Local Mask	Masks & Owners	57
288	Stop Owner	Masks & Owners	57
289	Start Owner	Masks & Owners	57
290	Jog Owner	Masks & Owners	57
291	Direction Owner	Masks & Owners	57
292	Reference Owner	Masks & Owners	57
293	Accel Owner	Masks & Owners	57
294	Decel Owner	Masks & Owners	57
295	Fault Ctr Owner	Masks & Owners	57
296	MOP Owner	Masks & Owners	57
297	Local Owner	Masks & Owners	57
298	DPI Ref Select	Comm Control	55
299	DPI Fdbk Select	Comm Control	56
300-307	Data In XX	Datalinks	58
308	HighRes Ref	Datalinks	58
310-317	Data Out XX	Datalinks	58
320	Anlg In Config	Analog Inputs	59

Number	Parameter Name	Group	Page
321	Anlg In Sqr Root	Analog Inputs	59
322, 325	Analog In X Hi	Analog Inputs	60
323, 326	Analog In X Lo	Analog Inputs	60
324, 327	Analog In X Loss	Analog Inputs	60
340	Anlg Out Config	Analog Outputs	60
341	Anlg Out Absolut	Analog Outputs	60
342, 345	Analog OutX Sel	Analog Outputs	61
343, 346	Analog OutX Hi	Analog Outputs	61
344, 347	Analog OutX Lo	Analog Outputs	61
354, 355	Anlg OutX Scale	Analog Outputs	61
361-366	Digital InX Sel	Digital Inputs	63
377, 378	Anlg OutX Setpt	Analog Outputs	61
379	Dig Out Setpt	Digital Outputs	64
380, 384, 388	Digital OutX Sel	Digital Outputs	65
381, 385, 389	Dig OutX Level	Digital Outputs	65
382, 386, 390	Dig OutX OnTime	Digital Outputs	65
383, 387, 391	Dig OutX OffTime	Digital Outputs	65
392	Dig Out Invert	Digital Outputs	66
393	Dig Out Param	Digital Outputs	66
394	Dig Out Mask	Digital Outputs	66
411	DigIn DataLogic	Digital Inputs	64
412	Motor Fdbk Type	Speed Feedback	27
413	Encoder PPR	Speed Feedback	28
414	Enc Position Fdbk	Speed Feedback	28
415	Encoder Speed	Speed Feedback	28
416	Fdbk Filter Sel	Speed Feedback	28
419	Notch Filter Freq	Speed Feedback	28
420	Notch Filter K	Speed Feedback	28
421	Marker Pulse	Speed Feedback	28
422	Pulse In Scale	Speed Feedback	28
423	Encoder Z Chan	Speed Feedback	28
427, 431	Torque Ref X Sel	Torq Attributes	26
428, 432	Torque Ref X Hi	Torq Attributes	26
429, 433	Torque Ref X Lo	Torq Attributes	26
430	Torq Ref A Div	Torq Attributes	26
434	Torque Ref B Mult	Torq Attributes	26
435	Torque Setpoint	Torq Attributes	26
436	Pos Torque Limit	Torq Attributes	26
437	Neg Torque Limit	Torq Attributes	27
438	Torque Setpoint2	Torq Attributes	27
440	Control Status	Torq Attributes	27
441	Mtr Tor Cur Ref	Torq Attributes	27
445	Ki Speed Loop	Speed Regulator	37
446	Kp Speed Loop	Speed Regulator	37
447	Kf Speed Loop	Speed Regulator	37
448	Spd Err Filt BW	Speed Regulator	37
449	Speed Desired BW	Speed Regulator	37
450	Total Inertia	Speed Regulator	37
451	Speed Loop Meter	Speed Regulator	37
452	Stop Dwell Time	Stop/Brake Mode	40
454	Rev Speed Limit	Speed Regulator	30
459	PI Deriv Time	Process PI	36
460	PI Reference Hi	Process PI	36
461	PI Reference Lo	Process PI	36
462	PI Feedback Hi	Process PI	36
463	PI Feedback Lo	Process PI	36
464	PI Output Gain	Process PI	36
476-494	ScaleX In Value	Scaled Blocks	54
477-495	ScaleX In Hi	Scaled Blocks	54
478-496	ScaleX In Lo	Scaled Blocks	54
479-497	ScaleX Out Hi	Scaled Blocks	54
480-498	ScaleX Out Lo	Scaled Blocks	54
481-499	ScaleX Out Value	Scaled Blocks	54
595	Port Mask Act	Security	58
596	Write Mask Cfg	Security	58
597	Write Mask Act	Security	59
598	Logic Mask Act	Security	59
600	TorqProve Cnfg	Torq Proving	67
601	TorqProve Setup	Torq Proving	67
602	Spd Dev Band	Torq Proving	67
603	SpdBand Integrat	Torq Proving	67
604	Brk Release Time	Torq Proving	67
605	ZeroSpdFloatTime	Torq Proving	67
606	Float Tolerance	Torq Proving	68

Number	Parameter Name	Group	Page
607	Brk Set Time	Torq Proving	<a href="#">68</a>
608	TorqLim SlewRate	Torq Proving	<a href="#">68</a>
609	BrkSlip Count	Torq Proving	<a href="#">68</a>
610	Brk Alarm Travel	Torq Proving	<a href="#">68</a>
611	MicroPos Scale%	Torq Proving	<a href="#">68</a>
612	TorqProve Status	Torq Proving	<a href="#">68</a>
613	Brake Test Torq	Torq Proving	<a href="#">68</a>
631	Rod Load Torque	Oil Well Pump	<a href="#">68</a>
632	TorqAlarm Level	Oil Well Pump	<a href="#">68</a>
633	TorqAlarm Action	Oil Well Pump	<a href="#">68</a>
634	TorqAlarm Dwell	Oil Well Pump	<a href="#">69</a>
635	TorqAlrm Timeout	Oil Well Pump	<a href="#">69</a>
636	TorqAlrm TO Act	Oil Well Pump	<a href="#">69</a>
637	PCP Pump Sheave	Oil Well Pump	<a href="#">69</a>
638	Max Rod Torque	Oil Well Pump	<a href="#">69</a>
639	Min Rod Speed	Oil Well Pump	<a href="#">69</a>
640	Max Rod Speed	Oil Well Pump	<a href="#">69</a>
641	OilWell Pump Sel	Oil Well Pump	<a href="#">69</a>
642	Gearbox Rating	Oil Well Pump	<a href="#">69</a>
643	Gearbox Sheave	Oil Well Pump	<a href="#">69</a>
644	Gearbox Ratio	Oil Well Pump	<a href="#">69</a>
645	Motor Sheave	Oil Well Pump	<a href="#">69</a>
646	Total Gear Ratio	Oil Well Pump	<a href="#">69</a>
647	DB Resistor	Oil Well Pump	<a href="#">69</a>
648	Gearbox Limit	Oil Well Pump	<a href="#">70</a>
650	Adj Volt Phase	Adjust Voltage	<a href="#">70</a>
651	Adj Volt Select	Adjust Voltage	<a href="#">70</a>
652	Adj Volt Ref Hi	Adjust Voltage	<a href="#">70</a>
653	Adj Volt Ref Lo	Adjust Voltage	<a href="#">70</a>
654-660	Adj Volt Preset1-7	Adjust Voltage	<a href="#">70</a>
661	Min Adj Voltage	Adjust Voltage	<a href="#">70</a>
662	Adj Volt Command	Adjust Voltage	<a href="#">70</a>
663	MOP Adj VoltRate	Adjust Voltage	<a href="#">70</a>
669	Adj Volt TrimSel	Adjust Voltage	<a href="#">70</a>
670	Adj Volt Trim Hi	Adjust Voltage	<a href="#">71</a>
671	Adj Volt Trim Lo	Adjust Voltage	<a href="#">71</a>
672	Adj Volt Trim %	Adjust Voltage	<a href="#">71</a>
675	Adj Volt AccTime	Adjust Voltage	<a href="#">71</a>
676	Adj Volt DecTime	Adjust Voltage	<a href="#">71</a>
677	Adj Volt S Curve	Adjust Voltage	<a href="#">71</a>
700	Pos/Spd Prof Sts	ProfSetup/Status	<a href="#">72</a>
701	Units Traveled	ProfSetup/Status	<a href="#">72</a>
702	Home Position	ProfSetup/Status	<a href="#">72</a>
705	Pos/Spd Prof Cmd	ProfSetup/Status	<a href="#">72</a>
707	Encoder Pos Tol	ProfSetup/Status	<a href="#">72</a>
708	Counts Per Unit	ProfSetup/Status	<a href="#">72</a>
711	Vel Override	ProfSetup/Status	<a href="#">72</a>
713	Find Home Speed	ProfSetup/Status	<a href="#">73</a>
714	Find Home Ramp	ProfSetup/Status	<a href="#">73</a>
718	Pos Reg Filter	ProfSetup/Status	<a href="#">73</a>
719	Pos Reg Gain	ProfSetup/Status	<a href="#">73</a>
720...	Step x Type	Profile Setup	<a href="#">73</a>
721...	Step x Velocity	Profile Setup	<a href="#">74</a>
722...	Step x AccelTime	Profile Setup	<a href="#">74</a>
723...	Step x DecelTime	Profile Setup	<a href="#">74</a>
724...	Step x Value	Profile Setup	<a href="#">75</a>
725...	Step x Dwell	Profile Setup	<a href="#">75</a>
726...	Step x Batch	Profile Setup	<a href="#">76</a>
727...	Step x Next	Profile Setup	<a href="#">76</a>

## Troubleshooting

This chapter provides information to guide you in troubleshooting the PowerFlex 700. Included is a listing and description of drive faults (with possible solutions, when applicable) and alarms.

For information on...	Page
Faults and Alarms	83
Drive Status	84
Manually Clearing Faults	85
Fault Descriptions	86
Clearing Alarms	90
Alarm Descriptions	91
Common Symptoms/Corrective Actions	94
Testpoint Codes and Functions	96

### Faults and Alarms

A fault is a condition that stops the drive. There are three fault types.

Type	Fault Description
1	Auto-Reset Run When this type of fault occurs, and [Auto Rstrt Tries] (see <a href="#">page 41</a> ) is set to a value greater than "0," a user-configurable timer, [Auto Rstrt Delay] (see <a href="#">page 41</a> ) begins. When the timer reaches zero, the drive attempts to automatically reset the fault. If the condition that caused the fault is no longer present, the fault will be reset and the drive will be restarted.
2	Non-Resettable This type of fault normally requires drive or motor repair. The cause of the fault must be corrected before the fault can be cleared. The fault will be reset on power up after repair.
3	User Configurable These faults can be enabled/disabled to annunciate or ignore a fault condition.

An alarm is a condition that, if left untreated, can stop the drive. There are two alarm types.

Type	Alarm Description
1	User Configurable These alarms can be enabled or disabled through [Alarm Config 1] on <a href="#">page 53</a> .
2	Non-Configurable These alarms are always enabled.

## Drive Status

The condition or state of your drive is constantly monitored. Any changes will be indicated through the LEDs and/or the HIM (if present).

### Front Panel LED Indications

Figure 1 - Typical Drive Status Indicators

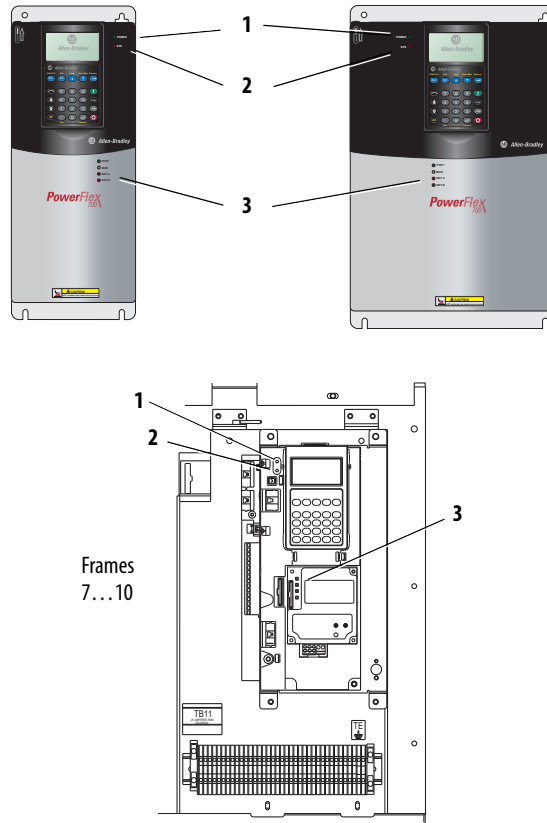

#	Name	Color	State	Description
1	PWR (Power)	Green	Steady	Illuminates when power is applied to the drive.
2	STS (Status)	Green	Flashing	Drive ready, but not running & no faults are present.
			Steady	Drive running, no faults are present.
		Yellow See <a href="#">page 91</a>	Flashing, Drive Stopped	A start inhibit condition exists, the drive cannot be started. Check parameter 214 [Start Inhibits].
			Flashing, Drive Running	An intermittent type 1 alarm condition is occurring. Check parameter 211 [Drive Alarm 1].
			Steady, Drive Running	A continuous type 1 alarm condition exists. Check parameter 211 [Drive Alarm 1].
		Red See <a href="#">page 86</a>	Flashing	Fault has occurred. Check [Fault x Code] or Fault Queue.
Steady	A non-resettable fault has occurred.			
3	PORT	Green	–	Status of DPI port internal communications (if present).
	MOD	Yellow	–	Status of communications module (when installed).
	NET A	Red	–	Status of network (if connected).
	NET B	Red	–	Status of secondary network (if connected).

## Precharge Board LED Indications

Precharge Board LED indicators are found on AC input drives, Frames 5...10.

Name	Color	State	Description
Power	Green	Steady	Indicates when precharge board power supply is operational
Alarm	Yellow	Flashing	Number in “[ ]” indicates flashes and associated alarm <sup>(1)</sup> : [1] Low line voltage (<90%). [2] Very low line voltage (<50%). [3] Low phase (one phase <80% of line voltage). [4] Frequency out of range or asymmetry (line sync failed). [5] Low DC bus voltage (triggers ride-through operation). [6] Input frequency momentarily out of range (40-65 Hz). [7] DC bus short circuit detection active.
Fault	Red	Flashing	Number in “[ ]” indicates flashes and associated fault <sup>(2)</sup> : [2] DC bus short (Udc <2% after 20 ms). [4] Line sync failed or low line (Uac <50% Unom).

(1) An alarm condition automatically resets when the condition no longer exists.

(2) A fault indicates a malfunction that must be corrected and can only be reset after cycling power.

## HIM Indication

The LCD HIM also provides visual notification of a fault or alarm condition.

Condition	Display
<p><b>Drive is indicating a fault</b></p> <p>The LCD HIM immediately reports the fault condition by displaying the following.</p> <ul style="list-style-type: none"> <li>• “Faulted” appears in the status line</li> <li>• Fault number</li> <li>• Fault name</li> <li>• Time that has passed since fault occurred</li> </ul> <p>Press the <b>Esc</b> key to regain HIM control.</p>	
<p><b>Drive is indicating an alarm</b></p> <p>The LCD HIM immediately reports the alarm condition by displaying the following.</p> <ul style="list-style-type: none"> <li>• Alarm name (Type 2 alarms only)</li> <li>• Alarm bell graphic</li> </ul>	

## Manually Clearing Faults

Step
1. Press the <b>Esc</b> key to acknowledge the fault. The fault information will be removed so that you can use the HIM.
2. Address the condition that caused the fault. The cause must be corrected before the fault can be cleared.
3. After corrective action has been taken, clear the fault using <b>one</b> of these methods. <ul style="list-style-type: none"> <li>– Press the <b>Stop</b> key.</li> <li>– Cycle drive power.</li> <li>– Set parameter 240 [Fault Clear] to “1.”</li> <li>– “Clear Faults” on the HIM Diagnostic menu.</li> </ul>

## Fault Descriptions

**Table 2 - Fault Types, Descriptions and Actions**

Fault	No.	Type <sup>(1)</sup>	Description	Action
Analog In Loss	29	1 3	An analog input is configured to fault on signal loss. A signal loss has occurred. Configure with [Anlg In 1, 2 Loss] on <a href="#">page 60</a> .	1. Check parameters. 2. Check for broken/loose connections at inputs.
Anlg Cal Chksum	108		The checksum read from the analog calibration data does not match the checksum calculated.	Replace drive.
Auto Rstrt Tries	33	3	Drive unsuccessfully attempted to reset a fault and resume running for the programmed number of [Flt RstRun Tries]. Enable/Disable with [Fault Config 1] on <a href="#">page 52</a> .	Correct the cause of the fault and manually clear.
AutoTune Aborted	80		Autotune function was canceled by the user or a fault occurred.	Restart procedure.
Auxiliary Input	2	1	Auxiliary input interlock is open.	Check remote wiring.
Cntl Bd Overtemp	55		The temperature sensor on the Main Control Board detected excessive heat.	1. Check Main Control Board fan. 2. Check surrounding air temperature. 3. Verify proper mounting/cooling.
DB Resistance	69		Resistance of the internal DB resistor is out of range.	Replace resistor.
Decel Inhibit	24	3	The drive is not following a commanded deceleration because it is attempting to limit bus voltage.	1. Verify input voltage is within drive specified limits. 2. Verify system ground impedance follows proper grounding techniques. 3. Disable bus regulation and/or add dynamic brake resistor and/or extend deceleration time. <b>See the Attention statement on <a href="#">page 12</a> for further info.</b>
Drive OverLoad	64		Drive rating of 110% for 1 minute or 150% for 3 seconds has been exceeded.	Reduce load or extend Accel Time.
Drive Powerup	49		No fault displayed. Used as a Power Up Marker in the Fault Queue indicating that the drive power has been cycled.	
Excessive Load	79		Motor did not come up to speed in the allotted time during autotune.	1. Uncouple load from motor. 2. Repeat Autotune.
Encoder Loss	91		Requires differential encoder. One of the two encoder channel signals is missing.	1. Check Wiring. 2. Check motor rotation. 3. Check encoder pulses, rotation, etc. 4. Replace encoder.
Encoder Quad Err	90		Both encoder channels changed state within one clock cycle.	1. Check for externally induced noise. 2. Replace encoder.
Fatal Faults	900-930	2	Diagnostic code indicating a drive malfunction.	1. Cycle power. 2. Replace Main Control Board. 3. Contact Tech Support.
Faults Cleared	52		No fault displayed. Used as a marker in the Fault Queue indicating that the fault clear function was performed.	
Flt QueueCleared	51		No fault displayed. Used as a marker in the Fault Queue indicating that the clear queue function was performed.	
FluxAmpsRef Rang	78		The value for flux amps determined by the Autotune procedure exceeds the programmed [Motor NP FLA].	1. Reprogram [Motor NP FLA] with the correct motor nameplate value. 2. Repeat Autotune.

Fault	No.	Type (1)	Description	Action
Ground Fault	13	1	A current path to earth ground greater than 25% of drive rating.	Check the motor and external wiring to the drive output terminals for a grounded condition.
Hardware Fault	93		Hardware enable is disabled (jumped high) but logic pin is still low.	1. Check jumper. 2. Replace Main Control Board.
Hardware Fault	130		Gate array load error.	1. Cycle power. 2. Replace Main Control Board.
Hardware Fault	131		Dual port failure.	1. Cycle power. 2. Replace Main Control Board.
Hardware PTC	18		Motor PTC (Positive Temperature Coefficient) Overtemp.	
Heatsink LowTemp v6	10	1	Annunciates a too low temperature case or an open NTC (heatsink temperature sensing device) circuit.	1. Verify ambient temperature. 2. In cold ambient temperatures, add space heaters.
Heatsink OvrTemp	8	1	Heatsink temperature exceeds 100% of [Drive Temp] or is less than approximately -19 °C.	1. Verify that maximum ambient temperature has not been exceeded. 2. Check fan. 3. Check for excess load. 4. In cold ambient temperatures, add space heaters.
HW OverCurrent	12	1	The drive output current has exceeded the hardware current limit.	Check programming. Check for excess load, improper DC boost setting, DC brake volts set too high or other causes of excess current.
Incompat MCB-PB	106	2	Drive rating information stored on the power board is incompatible with the main control board.	1. Load compatible version files into drive. 2. Frame 7 . . . 10 drives must have firmware version 4.009 or greater.
I/O Comm Loss	121		I/O Board lost communications with the Main Control Board.	Check connector. Check for induced noise. Replace I/O board or Main Control Board.
I/O Failure	122		I/O was detected, but failed the powerup sequence.	Replace Main Control Board.
Input Phase Loss	17		The DC bus ripple has exceeded a preset level.	Check incoming power for a missing phase/blown fuse.
IR Volts Range	77		"Calculate" is the autotune default and the value determined by the autotune procedure for IR Drop Volts is not in the range of acceptable values.	Re-enter motor nameplate data.
Ixo VoltageRange	87		Voltage calculated for motor inductive impedance exceeds 25% of [Motor NP Volts].	1. Check for proper motor sizing. 2. Check for correct programming of [Motor NP Volts], parameter 41. 3. Additional output impedance can be required.
Load Loss	15		Drive output torque current is below [Load Loss Level] for a time period greater than [Load Loss time].	1. Verify connections between motor and load. 2. Verify level and time requirements.
Motor Overload	7	1 3	Internal electronic overload trip. Enable/Disable with [Fault Config 1] on <a href="#">page 52</a> .	An excessive motor load exists. Reduce load so drive output current does not exceed the current set by [Motor NP FLA].
Motor Thermistor	16		Thermistor output is out of range.	1. Verify that thermistor is connected. 2. Motor is overheated. Reduce load.
NVS I/O Checksum	109		EEPROM checksum error.	1. Cycle power and repeat function. 2. Replace Main Control Board.
NVS I/O Failure	110		EEPROM I/O error.	1. Cycle power and repeat function. 2. Replace Main Control Board.

Fault	No.	Type <sup>(1)</sup>	Description	Action
Output PhaseLoss	21		Current in one or more phases has been lost or remains below a preset level.	Check the drive and motor wiring. Check for phase-to-phase continuity at the motor terminals. Check for disconnected motor leads.
OverSpeed Limit	25	1	Functions such as Slip Compensation or Bus Regulation have attempted to add an output frequency adjustment greater than that programmed in [Overspeed Limit].	Remove excessive load or overhauling conditions or increase [Overspeed Limit].
OverVoltage	5	1	DC bus voltage exceeded maximum value.	Monitor the AC line for high line voltage or transient conditions. Bus overvoltage can also be caused by motor regeneration. Extend the decel time or install dynamic brake option.
Parameter Chksum	100	2	The checksum read from the board does not match the checksum calculated.	1. Restore defaults. 2. Reload User Set if used.
Params Defaulted	48		The drive was commanded to write default values to EEPROM.	1. Clear the fault or cycle power to the drive. 2. Program the drive parameters as needed.
Phase U to Grnd	38		A phase to ground fault has been detected between the drive and motor in this phase.	1. Check the wiring between the drive and motor. 2. Check motor for grounded phase. 3. Replace drive.
Phase V to Grnd	39			
Phase W to Grnd	40			
Phase UV Short	41		Excessive current has been detected between these two output terminals.	1. Check the motor and drive output terminal wiring for a shorted condition. 2. Replace drive.
Phase VW Short	42			
Phase UW Short	43			
Port 1-6 DPI Loss v6 (Port 6)	81-86	2	DPI port stopped communicating. A SCANport device was connected to a drive operating DPI devices at 500k baud.	1. If adapter was not intentionally disconnected, check wiring to the port. Replace wiring, port expander, adapters, Main Control Board or complete drive as required. 2. Check HIM connection. 3. If an adapter was intentionally disconnected and the [Logic Mask] bit for that adapter is set to "1", this fault will occur. To disable this fault, set the [Logic Mask] bit for the adapter to "0."
Port 1-6 Adapter v6 (Port 6)	71-76		The communications card has a fault.	Check DPI device event queue and corresponding fault information for the device.
Power Down v6 Csum	111		EEPROM data is corrupt on drive power up.	Clear the fault or cycle power to the drive.
Power Loss	3	1 3	DC bus voltage remained below 85% of nominal for longer than [Power Loss Time]. Enable/Disable with [Fault Config 1] on <a href="#">page 52</a> .	Monitor the incoming AC line for low voltage or line power interruption.
Power Unit	70		One or more of the output transistors were operating in the active region instead of desaturation. This can be caused by excessive transistor current or insufficient base drive voltage.	1. Check for damaged output transistors. 2. Replace drive.
Pulse In Loss	92		Z Channel is selected as a pulse input and no signal is present.	1. Check wiring. 2. Replace pulse generator.
Pwr Brd Chksum1	104		The checksum read from the EEPROM does not match the checksum calculated from the EEPROM data.	Clear the fault or cycle power to the drive.



Fault	No.	Type (1)	Description	Action
Pwr Brd Chksum2	105	2	The checksum read from the board does not match the checksum calculated.	1. Cycle power to the drive. 2. If problem persists, replace drive.
Replaced MCB-PB	107	2	Main Control Board was replaced and parameters were not programmed.	1. Restore defaults. 2. Reprogram parameters.
See Manual	28		Encoderless TorqProve has been enabled but user has not read and understood application concerns of encoderless operation.	Read the "Attention" on <a href="#">page 112</a> relating to the use of TorqProve with no encoder.
Shear Pin	63	3	Programmed [Current Lmt Val] has been exceeded. Enable/Disable with [Fault Config 1] on <a href="#">page 52</a> .	Check load requirements and [Current Lmt Val] setting.
Software Fault	88		Microprocessor handshake error.	Replace Main Control Board.
Software Fault	89		Microprocessor handshake error.	Replace Main Control Board.
SW OverCurrent	36	1	Drive output current has exceeded the 1ms current rating. This rating is greater than the 3 second current rating and less than the hardware overcurrent fault level. It is typically 200- 250% of the drive continuous rating.	Check for excess load, improper DC boost setting. DC brake volts set too high.
TorqPrv Spd Band	20		Difference between [Commanded Speed] and [Encoder Speed] has exceeded the level set in [Spd Dev Band] for a time period greater than [Spd Band Integrat].	1. Check wiring between drive and motor. 2. Check release of mechanical brake.
Trnsistr OvrTemp	9	1	Output transistors have exceeded their maximum operating temperature.	1. Verify that maximum ambient temperature has not been exceeded. 2. Check fan. 3. Check for excess load.
UnderVoltage	4	1 3	DC bus voltage fell below the minimum value of 407V DC at 400/480V input or 204V DC at 200/240V input. Enable/Disable with [Fault Config 1] ( <a href="#">page 52</a> ).	Monitor the incoming AC line for low voltage or power interruption.
UserSet1 Chksum	101	2	The checksum read from the user set does not match the checksum calculated.	Re-save user set.
UserSet2 Chksum	102	2		
UserSet3 Chksum	103	2		

(1) See [page 83](#) for a description of fault types.

**Table 3 - Fault Cross Reference**

No. (1)	Fault	No. (1)	Fault	No. (1)	Fault
2	Auxiliary Input	39	Phase V to Grnd	88	Software Fault
3	Power Loss	40	Phase W to Grnd	89	Software Fault
4	UnderVoltage	41	Phase UV Short	90	Encoder Quad Err
5	OverVoltage	42	Phase VW Short	91	Encoder Loss
7	Motor Overload	43	Phase UW Short	92	Pulse In Loss
8	Heatsink OvrTemp	48	Params Defaulted	93	Hardware Fault
9	Trnsistr OvrTemp	49	Drive Powerup	100	Parameter Chksum
10 <sup>(2)</sup>	Heatsink Low Temp	51	Flt QueueCleared	101-103	UserSet Chksum
12	HW OverCurrent	52	Faults Cleared	104	Pwr Brd Chksum1
13	Ground Fault	55	Cntl Bd Overtemp	105	Pwr Brd Chksum2
15	Load Loss	63	Shear Pin	106	Incompat MCB-PB
16	Motor Thermistor	64	Drive OverLoad	107	Replaced MCB-PB
17	Input Phase Loss	69	DB Resistance	108'eyw	Anlg Cal Chksum
18	Hardware PTC	70	Power Unit	109	NVS I/O Checksum
20	TorqPrv Spd Band	71- 75	Port 1-5 Adapter	110	NVS I/O Failure
21	Output PhaseLoss	76 <sup>(2)</sup>	Port 6 Adapter	111 <sup>(2)</sup>	Power Down Csum
24	Decel Inhibit	77	IR Volts Range	121	I/O Comm Loss
25	OverSpeed Limit	78	FluxAmpsRef Rang	122	I/O Failure
28	See Manual	79	Excessive Load	130	Hardware Fault
29	Analog In Loss	80	AutoTune Aborted	131	Hardware Fault
33	Auto Rstrt Tries	81- 85	Port 1-5 DPI Loss	900-930	Fatal Faults
36	SW OverCurrent	86 <sup>(2)</sup>	Port 6 DPI Loss		
38	Phase U to Grnd	87	IXo VoltageRange		

(1) Fault numbers not listed are reserved for future use.

(2) Firmware 6.002 and later only.

## Clearing Alarms

Alarms are automatically cleared when the condition that caused the alarm is no longer present.

# Alarm Descriptions

**Table 4 - Alarm Descriptions and Actions**

Alarm	No.	Type(1)	Description																																																																																																				
AdjVoltRef Cflct	33	1	Invalid adjustable voltage reference selection conflict.																																																																																																				
Analog In Loss	5	1	An analog input is configured for "Alarm" on signal loss and signal loss has occurred.																																																																																																				
Bipolar Conflict	20	2	Parameter 190 [Direction Mode] is set to "Bipolar" or "Reverse Dis" and one or more of the following digital input functions is configured: "Fwd/Reverse," "Run Forward," "Run Reverse," "Jog Forward" or "Jog Reverse."																																																																																																				
Brake Slipped	32	2	Encoder movement has exceeded the level in [BrkSlipCount] after the brake was set.																																																																																																				
Brake Slipping	16	2	Brake slip procedure is in progress.																																																																																																				
<b>v6</b>																																																																																																							
Decel Inhibit	10	1	Drive is being inhibited from decelerating.																																																																																																				
Dig In ConflictA	17	2	Digital input functions are in conflict. Combinations marked with a "⚡" will cause an alarm.																																																																																																				
			<table border="1"> <thead> <tr> <th></th> <th>Acc2/Dec2</th> <th>Accel 2</th> <th>Decel 2</th> <th>Jog 1/2</th> <th>Jog Fwd</th> <th>Jog Rev</th> <th>Fwd/Rev</th> </tr> </thead> <tbody> <tr> <td>Acc2/Dec2</td> <td></td> <td>⚡</td> <td>⚡</td> <td></td> <td></td> <td></td> <td></td> </tr> <tr> <td>Accel 2</td> <td>⚡</td> <td></td> <td></td> <td></td> <td></td> <td></td> <td></td> </tr> <tr> <td>Decel 2</td> <td>⚡</td> <td></td> <td></td> <td></td> <td></td> <td></td> <td></td> </tr> <tr> <td>Jog 1/2</td> <td></td> <td></td> <td></td> <td></td> <td>⚡</td> <td>⚡</td> <td></td> </tr> <tr> <td>Jog Fwd</td> <td></td> <td></td> <td></td> <td>⚡</td> <td></td> <td></td> <td>⚡</td> </tr> <tr> <td>Jog Rev</td> <td></td> <td></td> <td></td> <td>⚡</td> <td></td> <td></td> <td>⚡</td> </tr> <tr> <td>Fwd/Rev</td> <td></td> <td></td> <td></td> <td></td> <td>⚡</td> <td>⚡</td> <td></td> </tr> </tbody> </table>		Acc2/Dec2	Accel 2	Decel 2	Jog 1/2	Jog Fwd	Jog Rev	Fwd/Rev	Acc2/Dec2		⚡	⚡					Accel 2	⚡							Decel 2	⚡							Jog 1/2					⚡	⚡		Jog Fwd				⚡			⚡	Jog Rev				⚡			⚡	Fwd/Rev					⚡	⚡																																					
	Acc2/Dec2	Accel 2	Decel 2	Jog 1/2	Jog Fwd	Jog Rev	Fwd/Rev																																																																																																
Acc2/Dec2		⚡	⚡																																																																																																				
Accel 2	⚡																																																																																																						
Decel 2	⚡																																																																																																						
Jog 1/2					⚡	⚡																																																																																																	
Jog Fwd				⚡			⚡																																																																																																
Jog Rev				⚡			⚡																																																																																																
Fwd/Rev					⚡	⚡																																																																																																	
Dig In ConflictB	18	2	A digital Start input has been configured without a Stop input or other functions are in conflict. Combinations that conflict are marked with a "⚡" and will cause an alarm.																																																																																																				
			<table border="1"> <thead> <tr> <th></th> <th>Start</th> <th>Stop-CF</th> <th>Run</th> <th>Run Fwd</th> <th>Run Rev</th> <th>Jog 1/2</th> <th>Jog Fwd</th> <th>Jog Rev</th> <th>Fwd/Rev</th> </tr> </thead> <tbody> <tr> <td>Start</td> <td></td> <td></td> <td>⚡</td> <td>⚡</td> <td>⚡</td> <td></td> <td>⚡</td> <td>⚡</td> <td></td> </tr> <tr> <td>Stop-CF</td> <td></td> <td></td> <td></td> <td></td> <td></td> <td></td> <td></td> <td></td> <td></td> </tr> <tr> <td>Run</td> <td>⚡</td> <td></td> <td></td> <td>⚡</td> <td>⚡</td> <td></td> <td>⚡</td> <td>⚡</td> <td></td> </tr> <tr> <td>Run Fwd</td> <td>⚡</td> <td></td> <td>⚡</td> <td></td> <td></td> <td>⚡</td> <td></td> <td></td> <td>⚡</td> </tr> <tr> <td>Run Rev</td> <td>⚡</td> <td></td> <td>⚡</td> <td></td> <td></td> <td>⚡</td> <td></td> <td></td> <td>⚡</td> </tr> <tr> <td>Jog 1/2</td> <td></td> <td></td> <td></td> <td>⚡</td> <td>⚡</td> <td></td> <td></td> <td></td> <td></td> </tr> <tr> <td>Jog Fwd</td> <td>⚡</td> <td></td> <td>⚡</td> <td></td> <td></td> <td></td> <td></td> <td></td> <td></td> </tr> <tr> <td>Jog Rev</td> <td>⚡</td> <td></td> <td>⚡</td> <td></td> <td></td> <td></td> <td></td> <td></td> <td></td> </tr> <tr> <td>Fwd/Rev</td> <td></td> <td></td> <td></td> <td>⚡</td> <td>⚡</td> <td></td> <td></td> <td></td> <td></td> </tr> </tbody> </table>		Start	Stop-CF	Run	Run Fwd	Run Rev	Jog 1/2	Jog Fwd	Jog Rev	Fwd/Rev	Start			⚡	⚡	⚡		⚡	⚡		Stop-CF										Run	⚡			⚡	⚡		⚡	⚡		Run Fwd	⚡		⚡			⚡			⚡	Run Rev	⚡		⚡			⚡			⚡	Jog 1/2				⚡	⚡					Jog Fwd	⚡		⚡							Jog Rev	⚡		⚡							Fwd/Rev				⚡	⚡				
	Start	Stop-CF	Run	Run Fwd	Run Rev	Jog 1/2	Jog Fwd	Jog Rev	Fwd/Rev																																																																																														
Start			⚡	⚡	⚡		⚡	⚡																																																																																															
Stop-CF																																																																																																							
Run	⚡			⚡	⚡		⚡	⚡																																																																																															
Run Fwd	⚡		⚡			⚡			⚡																																																																																														
Run Rev	⚡		⚡			⚡			⚡																																																																																														
Jog 1/2				⚡	⚡																																																																																																		
Jog Fwd	⚡		⚡																																																																																																				
Jog Rev	⚡		⚡																																																																																																				
Fwd/Rev				⚡	⚡																																																																																																		
Dig In ConflictC	19	2	More than one physical input has been configured to the same input function. Multiple configurations are not allowed for the following input functions. Forward/Reverse      Run Reverse      Bus Regulation Mode B Speed Select 1      Jog Forward      Acc2 / Dec2 Speed Select 2      Jog Reverse      Accel 2 Speed Select 3      Run      Decel 2 Run Forward      Stop Mode B																																																																																																				
DPI Port1 Loss	38	1	The HIM connected to DPI Port 1-3 stopped communicating to the drive. Check the HIM connection.																																																																																																				
DPI Port2 Loss	39	1																																																																																																					
DPI Port3 Loss	40	1																																																																																																					
Drive OL Level 1	8	1	The calculated IGBT temperature requires a reduction in PWM frequency. If [Drive OL Mode] is disabled and the load is not reduced, an overload fault will eventually occur.																																																																																																				
Drive OL Level 2	9	1	The calculated IGBT temperature requires a reduction in Current Limit. If [Drive OL Mode] is disabled and the load is not reduced, an overload fault will eventually occur.																																																																																																				
FluxAmpsRef Rang	26	2	The calculated or measured Flux Amps value is not within the expected range. Verify motor data and rerun motor tests.																																																																																																				
Ground Warn	15	1	Ground current has exceeded the level set in [Gnd Warn Level].																																																																																																				

Alarm	No.	Type <sup>(1)</sup>	Description
Home Not Set	34	1	Configurable alarm set in parameter 259, bit 17. When set to "1," this alarm is displayed when any of the following occur: <ul style="list-style-type: none"> <li>parameter 88 is set to "7" (Pos/Spd Prof)</li> <li>on power up and parameter 88 = "7"</li> <li>recall user sets and parameter 88 = "7"</li> </ul> Alarm is cleared when: <ul style="list-style-type: none"> <li>setting parameter 88 to a value other than "7"</li> <li>reset defaults</li> <li>parameter 259, bit 17 is cleared</li> <li>a digital input is configured as "Set Home" and input is True</li> <li>parameter 705, bit 9 is "Enabled"</li> <li>parameter 700, bit 13 (At Home) is "Enabled" - position regulator will set this bit if device is "home"</li> </ul>
In Phase Loss	13	1	The DC bus ripple has exceeded a preset level.
IntDBRes OvrHeat	6	1	The drive has temporarily disabled the DB regulator because the resistor temperature has exceeded a predetermined value.
IR Volts Range	25	2	The drive auto tuning default is "Calculate" and the value calculated for IR Drop Volts is not in the range of acceptable values. This alarm should clear when all motor nameplate data is properly entered.
Ixo Vlt Rang	28	2	Motor leakage inductance is out of range.
Load Loss	14	1	Output torque current is below [Load Loss Level] for a time period greater than [Load Loss time].
MaxFreq Conflict	23	2	The sum of [Maximum Speed] and [Overspeed Limit] exceeds [Maximum Freq]. Raise [Maximum Freq] or lower [Maximum Speed] and/or [Overspeed Limit] so that the sum is less than or equal to [Maximum Freq].
Motor Thermistor	12	1	The value at the thermistor terminals has been exceeded.
Motor Type Cflct	21	2	[Motor Type] has been set to "Synchr Reluc" or "Synchr PM" and one or more of the following exist: <ul style="list-style-type: none"> <li>[Motor Cntl Sel] = "Sensrls Vect," "SV Economize" or "Fan/Pmp V/Hz."</li> <li>[Flux Up Time] is greater than 0.0 Secs.</li> <li>[Speed Mode] is set to "Slip Comp."</li> <li>[Autotune] = "Static Tune" or "Rotate Tune."</li> </ul>
NP Hz Conflict	22	2	Fan/pump mode is selected in [Motor Cntl Sel] and the ratio of [Motor NP Hertz] to [Maximum Freq] is greater than 26.
PI Config Conflict	52	2	Check [PI Configuration], both "AdjVoltTrim" & "Torque Trim" are selected.
Power Loss	3	1	Drive has sensed a power line loss.
Precharge Active	1	1	Drive is in the initial DC bus precharge state.
Prof Step Cflct	50	2	An error is detected in trend step(s). <ul style="list-style-type: none"> <li>Set if Sleep Mode is enabled.</li> <li>Set if: <ul style="list-style-type: none"> <li>any profile step uses "Encoder Incr" and/or "Enc Absolute" <i>and</i> [Motor Cntl Sel], parameter 53 is <u>not</u> set to "FVC Vector" <i>and</i> [Feedback Select], parameter 80 is <u>not</u> set to "Encoder" or "Simulator" <i>and</i> [Speed/Torque Mod], parameter 88 = "7" (Pos/Spd Prof).</li> <li>a Step Type is configured for "Dig Input" and the Step Value is greater than 6, less than 6, or zero <i>or</i> the digital input selected with [Digital Inx Sel] is <u>not</u> set to "57, Prof Input."</li> </ul> </li> <li>Cleared if none of the above occur.</li> </ul>
PTC Conflict	31	2	PTC is enabled for Analog In 1, which is configured as a 0-20 mA current source in [Anlg In Config].
Sleep Config	29	2	Sleep/Wake configuration error. With [Sleep-Wake Mode] = "Direct," possible causes include: drive is stopped and [Wake Level] < [Sleep Level]. "Stop=CF," "Run," "Run Forward," or "Run Reverse" is not configured in [Digital Inx Sel].
Speed Ref Cflct	27	2	[Speed Ref x Sel] or [PI Reference Sel] is set to "Reserved".

Alarm	No.	Type <sup>(1)</sup>	Description
Start At PowerUp	4	1	[Start At PowerUp] is enabled. Drive can start at any time within 10 seconds of drive powerup.
TB Man Ref Cfct	30	2	Occurs when: <ul style="list-style-type: none"> <li>• “Auto/Manual” is selected (default) for [Digital In3 Sel], parameter 363 <i>and</i></li> <li>• [TB Man Ref Sel], parameter 96 has been reprogrammed.</li> </ul> No other use for the selected analog input can be programmed. Example: If [TB Man Ref Sel] is reprogrammed to “Analog In 2,” all of the factory default uses for “Analog In 2” must be reprogrammed (such as parameters 90, 117, 128 and 179). To correct: <ul style="list-style-type: none"> <li>• Verify/reprogram the parameters that reference an analog input <u>or</u></li> <li>• Reprogram [Digital In3] to another function or “Unused.”</li> </ul>
TorqProve Cfct	49	2	When [TorqProve Cnfg] is enabled, [Motor Cntl Sel], [Feedback Select] and [Motor Fdbk Type] must be properly set (see <a href="#">page 115</a> ).
UnderVoltage	2	1	The bus voltage has dropped below a predetermined value.
VHz Neg Slope	24	2	[Torq Perf Mode] = “Custom V/Hz” & the V/Hz slope is negative.
Waking	11	1	The Wake timer is counting toward a value that will start the drive.

(1) See [page 83](#) for a description of alarm types.

**Table 5 - Alarm Cross Reference**

No. <sup>(1)</sup>	Alarm	No. <sup>(1)</sup>	Alarm	No. <sup>(1)</sup>	Alarm
1	Precharge Active	15	Ground Warn	28	Ixo Vlt Rang
2	UnderVoltage	16 <sup>(2)</sup>	Brake Slipping	29	Sleep Config
3	Power Loss	17	Dig In ConflictA	30	TB Man Ref Cfct
4	Start At PowerUp	18	Dig In ConflictB	31	PTC Conflict
5	Analog in Loss	19	Dig In ConflictC	32	Brake Slipped
6	IntDBRes OvrHeat	20	Bipolar Conflict	33	AdjVoltRef Cfct
8	Drive OL Level 1	21	Motor Type Cfct	34	Home Not Set
9	Drive OL Level 2	22	NP Hz Conflict	38	DPI Port1 Loss
10	Decel Inhibt	23	MaxFreq Conflict	39	DPI Port2 Loss
11	Waking	24	VHz Neg Slope	40	DPI Port3 Loss
12	Motor Thermistor	25	IR Volts Range	49	Torq Prove Cfct
13	In Phase Loss	26	FluxAmpsRef Rang	50	Prof Step Cfct
14	Load Loss	27	Speed Ref Cfct	52	PI Config Conflict

(1) Alarm numbers not listed are reserved for future use.

(2) Firmware 6.002 and later only.

## Common Symptoms/ Corrective Actions

**Table 6 - Drive does not Start from Start or Run Inputs wired to the terminal block.**

Cause(s)	Indication	Corrective Action
Drive is Faulted	Flashing red status light	Clear fault. <ul style="list-style-type: none"> <li>Press Stop</li> <li>Cycle power</li> <li>Set [Fault Clear] to 1 (see <a href="#">page 52</a>)</li> <li>“Clear Faults” on the HIM Diagnostic menu</li> </ul>
Incorrect input wiring. Refer to the Installation Instructions for wiring examples. <ul style="list-style-type: none"> <li>2 wire control requires Run, Run Forward, Run Reverse or Jog input.</li> <li>3 wire control requires Start and Stop inputs.</li> <li>Jumper from terminal 25 to 26 is required.</li> </ul>	None	Wire inputs correctly and/or install jumper.
Incorrect digital input programming. <ul style="list-style-type: none"> <li>Mutually exclusive choices have been made (i.e., Jog and Jog Forward).</li> <li>2 wire and 3 wire programming can be conflicting.</li> <li>Exclusive functions (i.e., direction control) can have multiple inputs configured.</li> <li>Stop is factory default and is not wired.</li> </ul>	None	Program [Digital Inx Sel] for correct inputs ( <a href="#">page 63</a> ). Start or Run programming can be missing.
	Flashing yellow status light and “DigIn CflctB” indication on LCD HIM. [Drive Status 2] shows type 2 alarm(s).	Program [Digital Inx Sel] to resolve conflicts ( <a href="#">page 63</a> ). Remove multiple selections for the same function. Install stop button to apply a signal at stop terminal.

**Table 7 - Drive does not Start from HIM.**

Cause(s)	Indication	Corrective Action
Drive is programmed for 2 wire control. HIM Start button is disabled for 2 wire control unless param. 192, bit 1 = “1.”	None	If 2 wire control is required, no action needed. See [Save HIM Ref] on <a href="#">page 44</a> . If 3 wire control is required, program [Digital Inx Sel] for correct inputs (see <a href="#">page 63</a> ).

**Table 8 - Drive does not respond to changes in speed command.**

Cause(s)	Indication	Corrective Action
No value is coming from the source of the command.	LCD HIM Status Line indicates “At Speed” and output is 0 Hz.	1. If the source is an analog input, check wiring and use a meter to check for presence of signal. 2. Check [Commanded Speed] for correct source (see <a href="#">page 21</a> ).
Incorrect reference source has been programmed.	None	3. Check [Speed Ref Source] for the source of the speed reference (see <a href="#">page 48</a> ). 4. Reprogram [Speed Ref A Sel] for correct source (see <a href="#">page 31</a> ).
Incorrect Reference source is being selected via remote device or digital inputs.	None	5. Check [Drive Status 1], <a href="#">page 47</a> , bits 12 and 13 for unexpected source selections. 6. Check [Dig In Status], <a href="#">page 49</a> to see if inputs are selecting an alternate source. 7. Reprogram digital inputs to correct “Speed Sel x” option (see <a href="#">page 63</a> ).

**Table 9 - Motor and/or drive will not accelerate to commanded speed.**

Cause(s)	Indication	Corrective Action
Acceleration time is excessive.	None	Reprogram [Accel Time x], see <a href="#">page 38</a> .
Excess load or short acceleration times force the drive into current limit, slowing or stopping acceleration.	None	Check [Drive Status 2], bit 10 to see if the drive is in Current Limit (see <a href="#">page 47</a> ). Remove excess load or reprogram [Accel Time x], see <a href="#">page 38</a> .
Speed command source or value is not as expected.	None	Check for the proper Speed Command using Steps 1 through 7 above.
Programming is preventing the drive output from exceeding limiting values.	None	Check [Maximum Speed], <a href="#">page 29</a> and [Maximum Freq] <a href="#">page 24</a> to assure that speed is not limited by programming.

**Table 10 - Motor operation is unstable.**

Cause(s)	Indication	Corrective Action
Motor data was incorrectly entered or Autotune was not performed.	None	1. Correctly enter motor nameplate data. 2. Perform "Static" or "Rotate" Autotune procedure, see <a href="#">page 25</a> .

**Table 11 - Drive will not reverse motor direction.**

Cause(s)	Indication	Corrective Action
Digital input is not selected for reversing control.	None	Check [Digital Inx Sel], <a href="#">page 63</a> . Choose correct input and program for reversing mode.
Digital input is incorrectly wired.	None	Check input wiring.
Direction mode parameter is incorrectly programmed.	None	Reprogram [Direction Mode], <a href="#">page 44</a> for analog "Bipolar" or digital "Unipolar" control.
Motor wiring is improperly phased for reverse.	None	Switch two motor leads.
A bipolar analog speed command input is incorrectly wired or signal is absent.	None	1. Use meter to check that an analog input voltage is present. 2. Check wiring. Positive voltage commands forward direction. Negative voltage commands reverse direction.

**Table 12 - Stopping the drive results in a Decel Inhibit fault.**

Cause(s)	Indication	Corrective Action
The bus regulation feature is enabled and is halting deceleration due to excessive bus voltage. Excess bus voltage is normally due to excessive regenerated energy or unstable AC line input voltages. Internal timer has halted drive operation.	Decel Inhibit fault screen. LCD Status Line indicates "Faulted".	1. See Attention statement on <a href="#">page 12</a> . 2. Reprogram parameters 161/162 to eliminate any "Adjust Freq" selection. 3. Disable bus regulation (parameters 161 & 162) and add a dynamic brake. 4. Correct AC input line instability or add an isolation transformer. 5. Reset drive.

## Testpoint Codes and Functions

Select testpoint with [Testpoint x Sel], parameters 234/236. Values can be viewed with [Testpoint x Data], parameters 235/237.

No. <sup>(1)</sup>	Description	Units	Values		
			Minimum	Maximum	Default
01	DPI Error Status	1	0	255	0
02	Heatsink Temp	0.1 degC	-100.0	100.0	0
03	Active Cur Limit	1	0	32767	0
04	Active PWM Freq	1 Hz	2	10	4
05	Life MegaWatt Hr <sup>(2)</sup>	0.0001 MWh	0	214748.3647	0
06	Life Run Time	0.0001 Hrs	0	214748.3647	0
07	Life Pwr Up Time	0.0001 Hrs	0	214748.3647	0
08	Life Pwr Cycles	1	0	4294967295	0
09	Life MW-HR Fract <sup>(2)</sup>	1	0	4294967295	0
10	MW-HR Frac Unit <sup>(2)</sup>	1	0	4294967295	0
11	MCB Life Time	0.0001 Hrs	0	214748.3647	0
12	Raw Analog In 1	1	0		0
13	Raw Analog In 2	1	0		0
16	CS Msg Rx Cnt	1	0	65535	0
17	CS Msg Tx Cnt	1	0	65535	0
18	CS Timeout Cnt	1	0	255	0
19	CS Msg Bad Cnt	1	0	255	0
22	PC Msg Rx Cnt	1	0	65535	0
23	PC Msg Tx Cnt	1	0	65535	0
24-29	PC1-6 Timeout Cnt	1	0	255	0
30	CAN BusOff Cnt	1	0	65535	0
31	No. of Analog Inputs	1	0	x	0
32	Unfiltered Bus Voltage	1	0	65535	0
33	MTO Norm Mtr Amp	0.1 Amps	0	65535	0
36	DTO-Cmd DC Hold	1	0	32767	0
37	Control Bd Temp	0.1	0.0	60.0	0.0
38	Junction Temp	0.1 degC	-100.0	200.0	0
39	Gnd Warn Level	0.1 Amps	0	3276.7	0
40	In Phase Loss Level	1	0	32767	0
629	Motor OL Count				

(1) Enter in [Testpoint x Sel].

(2) Use the equation below to calculate total Lifetime MegaWatt Hours.

$$\frac{\text{Value of Code 9}}{\text{Value of Code 10}} \times 0.1 + \text{Value of Code 5} = \text{Total Lifetime MegaWatt H}$$



## Supplemental Drive Information

Topic	Page
Communication Configurations	97

For product certifications and specifications, see PowerFlex 700 Adjustable Frequency AC Drive Technical Data, publication [20B-TD001](#).

### Communication Configurations

### Typical Programmable Controller Configurations

**IMPORTANT** If block transfers are programmed to continuously write information to the drive, care must be taken to properly format the block transfer. If attribute 10 is selected for the block transfer, values will be written only to RAM and will not be saved by the drive. This is the preferred attribute for continuous transfers. If attribute 9 is selected, each program scan will complete a write to the drives non-volatile memory (EEPROM). Since the EEPROM has a fixed number of allowed writes, continuous block transfers will quickly damage the EEPROM. Do Not assign attribute 9 to continuous block transfers. Refer to the individual communications adapter User Manual for additional details.

#### Logic Command/Status Words

**Table 13 - Logic Command Word**

Logic Bits																Command	Description	
15	14	13	12	11	10	9	8	7	6	5	4	3	2	1	0			
																x	Stop <sup>(1)</sup>	0 = Not Stop 1 = Stop
																x	Start <sup>(1)(2)</sup>	0 = Not Start 1 = Start
																x	Jog	0 = Not Jog 1 = Jog
																x	Clear Faults	0 = Not Clear Faults 1 = Clear Faults
											x	x					Direction	00 = No Command 01 = Forward Command 10 = Reverse Command 11 = Hold Present Direction
										x							Local Control	0 = No Local Control 1 = Local Control

Logic Bits																Command	Description
15	14	13	12	11	10	9	8	7	6	5	4	3	2	1	0		
								x								MOP Increment	0 = Not Increment 1 = Increment
						x	x									Accel Rate	00 = No Command 01 = Use Accel Time 1 10 = Use Accel Time 2 11 = Use Present Time
				x	x											Decel Rate	00 = No Command 01 = Use Decel Time 1 10 = Use Decel Time 2 11 = Use Present Time
	x	x	x													Reference Select <sup>(3)</sup>	000 = No Command 001 = Ref. 1 (Ref A Select) 010 = Ref. 2 (Ref B Select) 011 = Ref. 3 (Preset 3) 100 = Ref. 4 (Preset 4) 101 = Ref. 5 (Preset 5) 110 = Ref. 6 (Preset 6) 111 = Ref. 7 (Preset 7)
x																MOP Decrement	0 = Not Decrement 1 = Decrement

- (1) A "0 = Not Stop" condition (logic 0) must first be present before a "1 = Start" condition will start the drive. The Start command acts as a momentary Start command. A "1" will start the drive, but returning to "0" will not stop the drive.
- (2) This Start will not function if a digital input (parameters 361-366) is programmed for 2-Wire Control (option 7, 8 or 9).
- (3) This Reference Select will not function if a digital input (parameters 361-366) is programmed for "Speed Sel 1, 2 or 3" (option 15, 16 or 17). When using the Logic Command Word for the Speed Reference Selection, always set bit 12, 13, or 14 to "1." Note that Reference Selection is "Exclusive Ownership" see [Reference Owner] on [page 57](#).

**Table 14 - Logic Status Word**

Logic Bits																Status	Description
15	14	13	12	11	10	9	8	7	6	5	4	3	2	1	0		
															x	Ready	0 = Not Ready 1 = Ready
															x	Active	0 = Not Active 1 = Active
													x			Command Direction	0 = Reverse 1 = Forward
												x				Actual Direction	0 = Reverse 1 = Forward
											x					Accel	0 = Not Accelerating 1 = Accelerating
										x						Decel	0 = Not Decelerating 1 = Decelerating
									x							Alarm	0 = No Alarm 1 = Alarm
								x								Fault	0 = No Fault 1 = Fault

Logic Bits																Status	Description
15	14	13	12	11	10	9	8	7	6	5	4	3	2	1	0		
							x									At Speed	0 = Not At Reference 1 = At Reference
				x	x	x										Local Control <sup>(1)</sup>	000 = Port 0 (TB) 001 = Port 1 010 = Port 2 011 = Port 3 100 = Port 4 101 = Port 5 110 = Reserved 111 = No Local
x	x	x	x													Reference Source	0000 = Ref A Auto 0001 = Ref B Auto 0010 = Preset 2 Auto 0011 = Preset 3 Auto 0100 = Preset 4 Auto 0101 = Preset 5 Auto 0110 = Preset 6 Auto 0111 = Preset 7 Auto 1000 = Term Blk Manual 1001 = DPI 1 Manual 1010 = DPI 2 Manual 1011 = DPI 3 Manual 1100 = DPI 4 Manual 1101 = DPI 5 Manual 1110 = Reserved 1111 = Jog Ref

(1) See "Owners" on [page 57](#) for further information.



## HIM Overview

Topic	Page
External & Internal Connections	101
Menu Structure	104
Viewing and Editing Parameters	106
Removing/Installing the HIM	102

### External & Internal Connections

The PowerFlex 700 provides a number of cable connection points.

**Figure 2 - Port Locations - Frames 0...6 (0 Frame shown).**

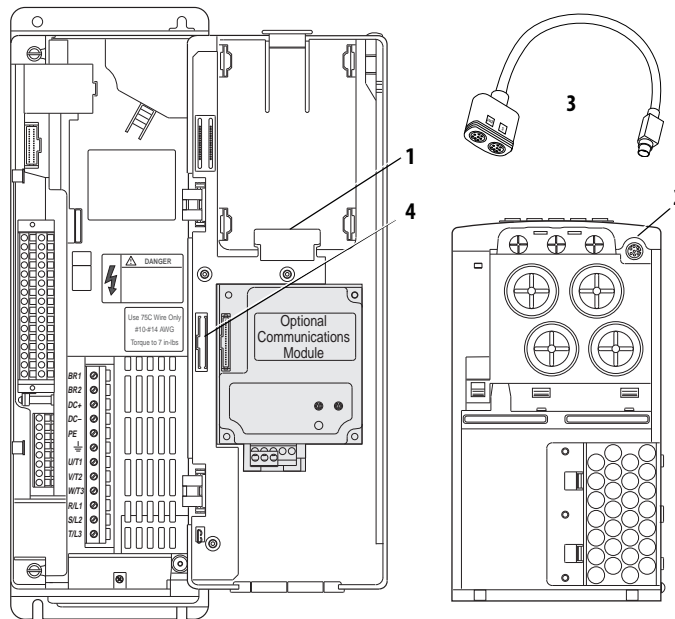

No.	Connector	Description
1	DPI Port 1	HIM connection when installed in cover.
2	DPI Port 2	Cable connection for handheld and remote options.
3	DPI Port 3 or 2	Splitter cable connected to DPI Port 2 provides additional port.
4	DPI Port 5	Cable connection for communications adapter.

Figure 3 - Port Locations - Frames 7...10

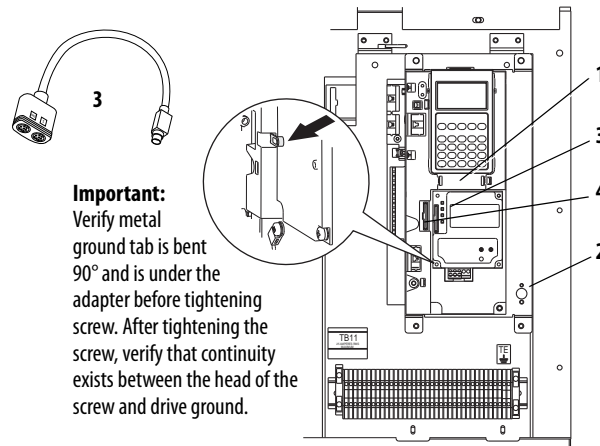

**Important:**  
Verify metal ground tab is bent 90° and is under the adapter before tightening screw. After tightening the screw, verify that continuity exists between the head of the screw and drive ground.

No.	Connector	Description
1	DPI Port 1	HIM connection.
2	DPI Port 2	Cable connection for handheld and remote options. Located on side of chassis for Frame 7 IP20, NEMA/UL Type 1.
3	DPI Port 3 or 2	Splitter cable connected to DPI Port 2 provides additional port.
4	DPI Port 5	Cable connection for communications adapter.

## Removing/Installing the HIM

The HIM can be removed or installed while the drive is powered.

**IMPORTANT** In the drive default configuration, HIM removal is only permissible in Auto mode. If the HIM is removed while in Manual mode or the HIM is the only remaining control device, a fault will occur.

Step	Example Display
<p>To remove the HIM...</p> <ol style="list-style-type: none"> <li>1. Press the <b>ALT</b> key and then the <b>↵</b> (Enter) key. The Remove HIM confirmation screen appears.</li> <li>2. Press the <b>↵</b> (Enter) key to confirm that you want to remove the HIM.</li> <li>3. Remove the HIM from the drive.</li> </ol> <p>To install HIM...</p> <ol style="list-style-type: none"> <li>1. Insert into drive or connect cable.</li> </ol>	<div style="border: 1px solid black; padding: 5px;"> <p>Remove Op Intrfc: Press Enter to Disconnect Op Intrfc? (Port 1 Control)</p> </div>

## Disconnecting the HIM

In drive Firmware Revision 9.001 and later, the user can configure the drive to continue operating at a defined speed reference if a HIM DPI Port 1-3 loss occurs, which is indicated by bits 21, 22, and 23 in read-only parameter 211 [Drive Alarm 1]. These three ports can be configured independently. Using this feature will allow the drive to operate at the speed defined in parameter 173 [DPI Loss Action], and indicate a DPI Port x Loss as configured in parameter 238 [Fault Config 1] and parameter 259 [Alarm Config 1]. If the HIM was supplying the speed reference when removed, the drive speed reference cannot be adjusted from any other source while the HIM is disconnected.

If the present speed reference was not from the DPI port that was disconnected, the drive speed will continue to be commanded by that reference.

If the drive stops while the HIM is disconnected and the DPI Port x loss is activated, the last commanded HIM speed reference will be saved in the drive. When the user issues a start command, the last commanded HIM speed reference will be used.

---

**IMPORTANT** When using parameter 173 [DPI Loss Action], the user must make certain that the HIM is not the sole stopping source. The user must verify that an alternate stop source is available. If the HIM is the sole stopping source and it is disconnected, the drive will fault regardless of the configuration in parameter 238 [Fault Config 1].

---

In the default condition, a DPI loss fault will occur if a HIM is disconnected. To avoid or override a DPI loss fault and keep the drive running:

1. Set parameter 173 [DPI Loss Action] to “1” (Hold OutFreq) or “2” (Goto Preset1).
2. Change the respective bit that corresponds to the DPI port (bits 16..18) in parameter 238 [Fault Config 1] to a value of “0” to disable the fault.
3. Verify that the respective bit that corresponds to the DPI port (bits 21...23) in parameter 259 [Alarm Config 1] is in its default state of “1” (condition true).

## Reconnecting the HIM

When the HIM is reconnected to the original DPI port, the drive speed reference will be transferred to the HIM, providing a constant drive speed while the HIM regains control of the speed reference. Once communication between the drive and HIM is re-established, the DPI Port x Loss alarm will clear and the HIM will control the speed reference.

# Menu Structure

Figure 4 - HIM Menu Structure

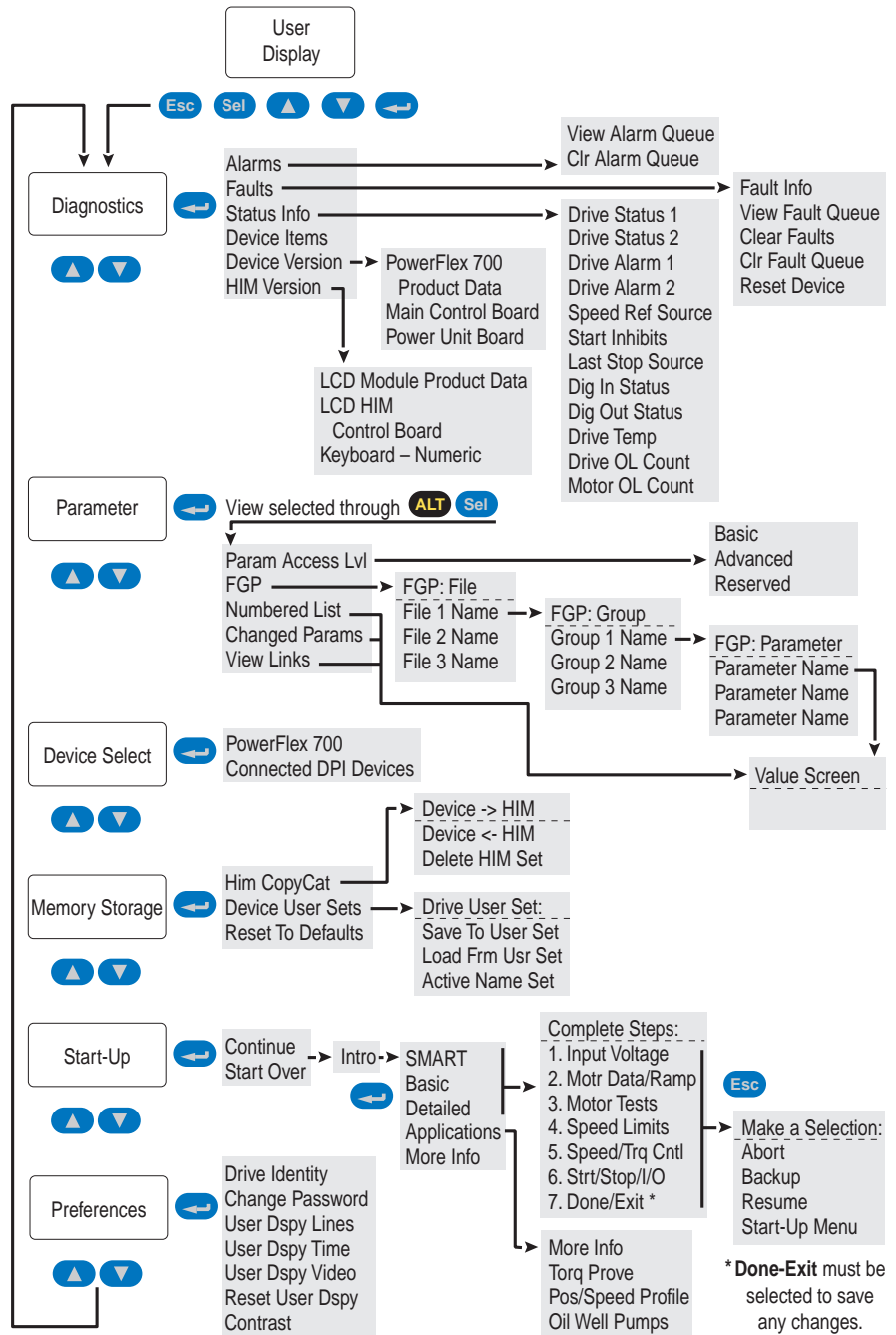

Press **▲ ▼** to move between menu items

Press **Esc** to move 1 level back in the menu structure

Press **←** to select a menu item

Press **ALT Sel** to select how to view parameters

\* **Done-Exit** must be selected to save any changes.



## Diagnostics Menu

When a fault trips the drive, use this menu to access detailed data about the drive.

Option	Description
Alarms	View alarm queue and clear alarms.
Faults	View fault queue or fault information, clear faults or reset drive.
Status Info	View parameters that display status information about the drive.
Device Version	View the firmware version and hardware series of components.
HIM Version	View the firmware version and hardware series of the HIM.

## Parameter Menu

Refer to [Viewing and Editing Parameters on page 106](#).

The drive is initially set to Basic Parameter View. To view all parameters, set parameter 196 [Param Access Lvl] to option 1 “Advanced.” To view Engineering parameters (refer to the PowerFlex Reference Manual, publication PFLEX-RM002 for details) select option 2 “Reserved.” Parameter 196 is not affected by the Reset to Defaults.

Option	Description
Changed	Parameters changed for default.

## Device Select Menu

Use this menu to access parameters in connected peripheral devices.

## Memory Storage Menu

Drive data can be saved to, or recalled from, User and HIM sets. *User sets* are files stored in permanent nonvolatile drive memory. *HIM sets* are files stored in permanent nonvolatile HIM memory.

Option	Description
HIM Copycat Device -> HIM Device <- HIM	Save data to a HIM set, load data from a HIM set to active drive memory or delete a HIM set.
Device User Sets	Save data to a User set, load data from a User set to active drive memory or name a User set.
Reset To Defaults	Restore the drive to its factory-default settings.

## Start Up Menu

See Installation Instructions.

## Preferences Menu

The HIM and drive have features that you can customize.

Option	Description
Drive Identity	Add text to identify the drive.
Change Password	Enable/disable or modify the password.
User Dspy Lines	Select the display, parameter, scale and text for the User Display. The User Display is two lines of user-defined data that appears when the HIM is not being used for programming.
User Dspy Time	Set the wait time for the User Display or enable/disable it.
User Dspy Video	Select Reverse or Normal for the Frequency and User Display lines.
Reset User Dspy	Return all the options for the User Display to factory default values.

## Viewing and Editing Parameters

### LCD HIM

<ol style="list-style-type: none"> <li>In the Main Menu, press the <b>▲</b> or <b>▼</b> key to scroll to "Parameter."</li> <li>Press the <b>↵</b> (Enter) key. "FGP File" appears on the top line and the first three files appear below it.</li> <li>Press the <b>▲</b> or <b>▼</b> key to scroll through the files.</li> <li>Press the <b>↵</b> (Enter) key to select a file. The groups in the file are displayed under it.</li> <li>Repeat steps 3 and 4 to select a group and then a parameter. The parameter value screen will appear.</li> <li>Press the <b>↵</b> (Enter) key to edit the parameter.</li> <li>Press the <b>▲</b> or <b>▼</b> key to change the value. If desired, press the <b>SEL</b> key to move from digit to digit, letter to letter, or bit to bit. The digit or bit that you can change will be highlighted.</li> <li>Press the <b>↵</b> (Enter) key to save the value. If you want to cancel a change, press the <b>ESC</b> key.</li> <li>Press the <b>▲</b> or <b>▼</b> key to scroll through the parameters in the group, or press the <b>ESC</b> key to return to the group list.</li> </ol>	<div style="border: 1px solid black; padding: 2px; margin-bottom: 5px;">                     FGP: File                      Monitor  <b>Motor Control</b>                      Speed Command                 </div> <div style="border: 1px solid black; padding: 2px; margin-bottom: 5px;">                     FGP: Group                      Motor Data  <b>Torq Attributes</b>                      Volts per Hertz                 </div> <div style="border: 1px solid black; padding: 2px; margin-bottom: 5px;">                     FGP: Parameter                      Maximum Voltage  <b>Maximum Freq</b>                      Compensation                 </div> <div style="border: 1px solid black; padding: 2px; margin-bottom: 5px;">                     FGP:            Par 55                      Maximum Freq  <b>60.00</b>        Hz                      25 &lt;&gt; 400.00                 </div> <div style="border: 1px solid black; padding: 2px;">                     FGP:            Par 55                      Maximum Freq  <b>90.00</b>        Hz                      25 &lt;&gt; 400.00                 </div>
---	--

#### Numeric Keypad Shortcut

If using a HIM with a numeric keypad, press the ALT key and the +/- key to access the parameter by typing its number.

## Linking Parameters









Most parameter values are entered directly by the user. However, certain parameters can be “linked,” so the value of one parameter becomes the value of another. For Example: the value of an analog input can be linked to [Accel Time 2]. Rather than entering an acceleration time directly (via HIM), the link allows the value to change by varying the analog signal. This can provide additional flexibility for advanced applications.

Each link has 2 components:

- Source parameter – sender of information.
- Destination parameter – receiver of information.

Most parameters can be a source of data for a link, except parameter values that contain an integer representing an ENUM (text choice). These are not allowed, since the integer is not actual data (it represents a value). [Table 15](#) lists the parameters that can be destinations. All links must be established between equal data types (parameter value formatted in floating point can only source data to a destination parameter value that is also floating point). A maximum of ten links is allowed.

### Establishing A Link

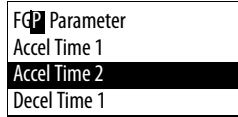
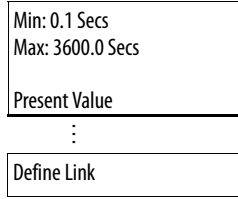
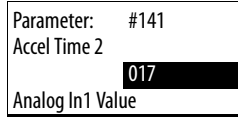
<ol style="list-style-type: none"> <li>1. Select a valid destination parameter (see <a href="#">Table 15</a>) to be linked (refer to <a href="#">page 106</a>). The parameter value screen will appear.</li> <li>2. Press the  (Enter) key to edit the parameter. The cursor will move to the value line.</li> <li>3. Press the  key and then the  key. Next, press the  or  key to change “Present Value” to “Define Link.” Then press the  (Enter) key.</li> <li>4. Enter the Source Parameter Number and press the  (Enter) key. The linked parameter can now be viewed two different ways by repeating steps 1-4 and selecting “Present Value” or “Define Link.” If an attempt is made to edit the value of a linked parameter, “Parameter is Linked!” will be displayed, indicating that the value is coming from a source parameter and cannot be edited.</li> <li>5. To remove a link, repeat steps 1-5 and change the source parameter number to zero (0).</li> <li>6. Press the  key to return to the group list.</li> </ol>	  
--	--

**Table 15 - Linkable Parameters**

No.	Parameter	No.	Parameter	No.	Parameter
54	Maximum Voltage	182	Sleep Level	607	Brk Set Time
58	Flux Up Time	183	Sleep Time	608	TorqLim SlewRate
59	SV Boost Filter	185	Power Loss Time	609	Brk Slip Count
66	Autotune Torque	186	Power Loss Level	610	Brk Alarm Travel
69	Start/Acc Boost	187	Load Loss Level	611	MicroPos Scale%
70	Run Boost	188	Load Loss Time	613	Brake Test Torq
71	Break Voltage	189	Shear Pin Time	632	TorqAlarm Level
72	Break Frequency	195	MOP Rate	634	TorqAlarm Dwell
84-86	Skip Frequency X	308	HighRes Ref	635	TorqAlrm Timeout
87	Skip Freq Band	322-325	Analog In X Hi	637	PCP Pump Sheave
91	Speed Ref A Hi	323-326	Analog In X Lo	638	Max Rod Torque
92	Speed Ref A Lo	343-345	Analog OutX Hi	639	Min Rod Speed
94	Speed Ref B Hi	344-346	Analog OutX Lo	640	Max Rod Speed
95	Speed Ref B Lo	354-355	Anlg OutX Scale	642	Gearbox Rating
97	TB Man Ref Hi	377-358	Anlg OutX Setpt	643	Gearbox Sheave
98	TB Man Ref Lo	381-389	Dig OutX Level	644	Gearbox Ratio
100	Jog Speed 1	382-390	Dig OutX OnTime	645	Motor Sheave
101-107	Preset Speed X	383-391	Dig OutX OffTime	647	DB Resistor
108	Jog Speed 2	419	Notch FilterFreq	648	Gearbox Limit
116	Trim % Setpoint	420	Notch Filter K	652	Adj Volt Ref Hi
119	Trim Hi	428	Torque Ref A Hi	653	Adj Volt Ref Lo
120	Trim Lo	429	Torque Ref A Lo	654-660	Adj Volt PresetX
121	Slip RPM @ FLA	430	Torq Ref A Div	661	Min Adj Voltage
122	Slip Comp Gain	432	Torque Ref B Hi	663	MOP Adj VoltRate
127	PI Setpoint	433	Torque Ref B Lo	670	Adj Volt Trim Hi
129	PI Integral Time	434	Torq Ref B Mult	671	Adj Volt Trim Lo
130	PI Prop Gain	435	Torque Setpoint1	672	Adj Volt Trim %
131	PI Lower Limit	436	Pos Torque Limit	675	Adj Volt AccTime
132	PI Upper Limit	437	Neg Torque Limit	676	Adj Volt DecTime
133	PI Preload	438	Torque Setpoint2	677	Adj Volt S Curve
139	PI BW Filter	445	Ki Speed Loop	702	Home Position
140-142	Accel Time X	446	Kp Speed Loop	707	Encoder Pos Tol
141-143	Accel Time X	447	Kf Speed Loop	711	Vel Override
146	S Curve %	448	Spd Err Filt BW	713	Find Home Speed
148	Current Lmt Val	449	Speed Desired BW	714	Find Home Ramp
149	Current Lmt Gain	450	Total Inertia	718	Pos Reg Filter
151	PWM Frequency	459	PI Deriv Time	719	Pos Reg Gain
152	Droop RPM @ FLA	460	PI Reference Hi	721-871	Step X Velocity
153	Regen Power Lim	461	PI Reference Lo	722-872	Step X AccelTime
154	Current Rate Lim	462	PI Feedback Hi	723-873	Step X DecelTime
158	DC Brake Level	463	PI Feedback Lo	724-874	Step X Value
159	DC Brake Time	464	PI Output Gain	725-875	Step X Dwell
160	Bus Reg Ki	494	ScaleX In Value	726-876	Step X Batch
164	Bus Reg Kp	495	ScaleX In Hi	727-877	Step X Next
165	Bus Reg Kd	496	ScaleX In Lo		
167	Powerup Delay	497	ScaleX Out Hi		
170	Flying StartGain	498	ScaleX Out Lo		
175	Auto Rstrt Delay	602	Spd Dev Band		
177	Gnd Warn Level	603	SpdBand Integrat		
180	Wake Level	604	Brk Release Time		
181	Wake Time	605	ZeroSpdFloatTime		
		606	Float Tolerance		

## Application Notes

Topic	Page
Adjustable Voltage Operation	109
External Brake Resistor	111
Hand-Off-Auto (HOA)	111
Lifting/Torque Proving	111
Limit Switches for Digital Inputs	118
Minimum Speed	119
Motor Control Technology	120
Motor DC Injection	121
Motor Overload	122
Motor Overload Memory Retention Per 2005 NEC	123
Overspeed	123

Topic	Page
Position Indexer/Speed Profiler	124
Power Loss Ride Through	133
Process PID	134
Reverse Speed Limit	136
Skip Frequency	137
Sleep Wake Mode	138
Start At PowerUp	140
Stop Mode	140
Stop Dwell Time	145
Voltage Tolerance	146

### Adjustable Voltage Operation

In Adjustable Voltage control mode, the output voltage is controlled independently from the output frequency. The voltage and frequency components have independent references and acceleration/deceleration rates. Single-phase and three-phase output is possible with this feature. The Adjustable Voltage mode is designed to operate on electro-magnetic loads - not typical AC motors.

Typical applications include:

- Linear Motors
- Vibration Welding
- Vibratory conveying
- Electromagnetic Stirring
- Induction Heating (400 Hz or lower)
- Resistive Loads (dryers)
- Power Supplies

## Enabling Adjustable Voltage

Adjustable Voltage is enabled in [Motor Cntl Sel], parameter 053 by selecting “5, Adj Voltage.” In this mode, current limit will now reduce voltage instead of frequency when the threshold is reached. Aggressive ramp rates on the voltage command should be avoided to minimize nuisance overcurrent trips.

### *Fixed Frequency Control Applications*

Many of the applications require a fixed frequency operation with variable voltage levels. For these applications it is best to set the frequency ramp rates to “0” using [Accel Time 1 & 2] and [Decel Time 1 & 2], parameters 140-143. The ramp rates for output voltage are independently controlled with parameters [Adj Volt AccTime] and [Adj Volt DecTime], parameters 675-676.

### *Output Filters*

Several adjustable voltage applications can require the use of output filters. Any L-C or sine wave filter used on the output side of the drive must be compatible with the desired frequency of operation, as well as the PWM voltage waveform developed by the inverter. The drive is capable of operating from 0-400 Hz output frequency and the PWM frequencies range from 2-10 kHz. When a filter is used on the output of the drive, [Drive OL Mode], parameter 150 should be programmed so that PWM frequency is not affected by an overload condition (i.e. “0, Disabled” or “1, Reduce CLim”).

### *Trim Function*

The trim function can be used with the Adjustable Voltage mode. The value of the selection in [Adj Volt TrimSel], parameter 669 is summed with the value of [Adj Volt Select], parameter 651. Scaling of the trim function is controlled with [Adj Volt Trim%], parameter 672. When the sign of [Adj Volt Trim%] is negative, the value selected in [Adj Volt TrimSel] is subtracted from the reference.

### *Process Control*

The Process PI loop in the drive can be configured to regulate the frequency or voltage commands of the drive. Typical applications using the Adjustable Voltage mode will close the loop around the voltage command. Process PI is enabled by selecting “1, AdjVoltTrim” in bit 10 of [PI Configuration], parameter 124. This bit configures the PI regulator output to trim the voltage reference, rather than the torque or speed references. The trim can be configured to be exclusive by selecting “1, Excl Mode” in bit 0 of [PI Configuration], parameter 124. Trimming the voltage reference is not compatible with trimming the torque reference, thus if bits 10 and 8 of [PI Configuration] are set, a type II alarm will occur, setting bit 19 (PI Cfg Cflct) in [Drive Alarm 2], parameter 212.

## External Brake Resistor



**ATTENTION:** The drive does not offer protection for externally mounted brake resistors. A risk of fire exists if external braking resistors are not protected. External resistor packages must be self-protected from over temperature or a circuit equivalent to the one shown below must be supplied.

**Figure 5 - External Brake Resistor Circuitry**

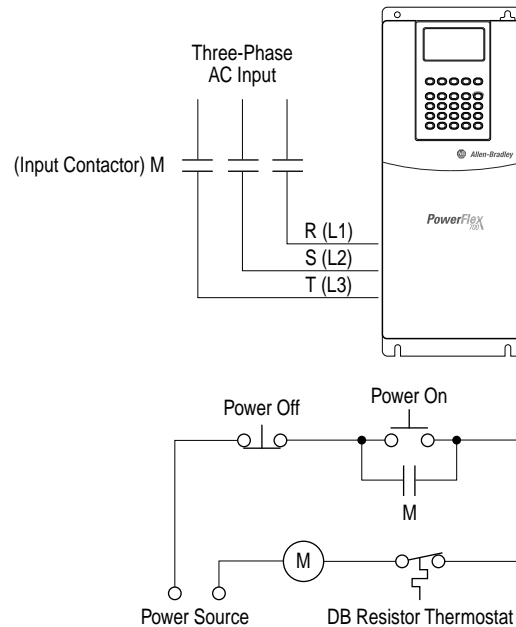

## Hand-Off-Auto (HOA)

The Hand-Off-Auto feature (firmware revision 10.001 and later) adds a delay to the Start input when 3-wire control is used. This helps to prevent a stop/start race condition. A 50 ms delay is added after the stop input is closed and before the start input is checked. To select this feature, choose “HOA Start” (70), in [Digital Inx Sel], parameters 361...366 (see [page 63](#)).

## Lifting/Torque Proving

The TorqProve™ feature of the PowerFlex 700 is intended for applications where proper coordination between motor control and a mechanical brake is required. Prior to releasing a mechanical brake, the drive will check motor output phase continuity and verify proper motor control (torque proving). The drive will also verify that the mechanical brake has control of the load prior to releasing drive control (brake proving). After the drive sets the brake, motor movement is monitored to ensure the brakes ability to hold the load. TorqProve can be operated with an encoder or encoderless.

TorqProve functionality with an encoder includes:

- Torque Proving (includes flux up and last torque measurement)
- Brake Proving
- Brake Slip (feature slowly lowers load if brake slips/fails)
- Float Capability (ability to hold full torque at zero speed)
- Micro-Positioning
- Fast Stop
- Speed Deviation Fault, Output Phase Loss Fault, Encoder Loss Fault.

Encoderless TorqProve functionality includes:

- Torque Proving (includes flux up and last torque measurement)
- Brake Proving
- Micro-Positioning
- Fast Stop
- Speed Deviation Fault, Output Phase Loss Fault.

---

**IMPORTANT** Brake Slip detection and Float capability (ability to hold load at zero speed) are not available in encoderless TorqProve.

---



**ATTENTION:** Loss of control in suspended load applications can cause personal injury and/or equipment damage. Loads must always be controlled by the drive or a mechanical brake. Parameters 600-612 are designed for lifting/torque proving applications. It is the responsibility of the engineer and/or end user to configure drive parameters, test any lifting functionality and meet safety requirements in accordance with all applicable codes and standards.

---



**ATTENTION:** User must read the following prior to the use of TorqProve with no encoder.

Encoderless TorqProve must be limited to lifting applications where personal safety is not a concern. Encoders offer additional protection and must be used where personal safety is a concern. Encoderless TorqProve cannot hold a load at zero speed without a mechanical brake and does not offer additional protection if the brake slips/fails. Loss of control in suspended load applications can cause personal injury and/or equipment damage.

It is the responsibility of the engineer and/or user to configure drive parameters, test any lifting functionality and meet safety requirements in accordance with all applicable codes and standards. If encoderless TorqProve is desired, the user must certify the safety of the application. To acknowledge that the end user has read this "Attention" and properly certified their encoderless application, bit 8 ("TPEndless") of [Compensation], parameter 56 must be changed to a "1." This will disable Fault 28, "See Manual" and allow bit 1 of Parameter 600 to be changed to a "1" enabling encoderless TorqProve.

---



## TorqProve Manual Start Up

It is possible to use the Assisted Start Up to tune the motor. However, it is recommended that the motor be disconnected from the hoist/crane equipment during the routine. If this is not possible, refer to steps [1](#) through [12](#) on the following pages.



**ATTENTION:** To guard against personal injury and/or equipment damage caused by unexpected brake release, verify the Digital Out 1 brake connections and/or programming. The default drive configuration energizes the Digital Out 1 relay when power is applied to the drive. The PowerFlex 700 drive will not control the mechanical brake until TorqProve is enabled. If the brake is connected to this relay, it could be released. If necessary, disconnect the relay output until wiring/programming can be completed and verified.

### Initial Static Auto Tune Test

1. Set the following parameters as shown.

No.	Name	Value	Notes
380	[Digital Out1 Sel]	"9, At Speed"	keeps brake engaged during test
041-045	[Motor NP . . .]	per nameplate	enter motor nameplate data
053	[Motor Cntl Sel]	"4, FVC Vector"	
080	[Feedback Select]	"3, Encoder"	
061	[Autotune]	"1, Static Tune"	

2. Press the Start key on the HIM. Parameters 062-064 will be updated.

### Motor Rotation/Encoder Direction Test

3. Set the following parameters as shown.

No.	Name	Value	Notes
053	[Motor Cntl Sel]	"0, Sensrls Vect"	
080	[Feedback Select]	"0, Open Loop"	
090	[Speed Ref A Sel]	"11, Preset Spd1"	
238	[Fault Config 1]	Bit 8, "In PhaseLoss" = 1 Bit 12, "OutPhaseLoss" = 1	
380	[Digital Out1 Sel]	"4, Run"	releases brake

**IMPORTANT** If the direction of travel is critical at this point, perform short jogs to determine which run direction (RUNFWD or RUNREV) should be used in the next steps.

4. Press Start and run the drive in the desired direction. Observe the direction of motor rotation.  
If rotation is not in the desired direction:
  - remove drive power and reverse the two motor leads, or . . .
  - set bit 5 of [Compensation], parameter 56 to “Mtr Lead Rev.”
5. With the drive running, observe [Encoder Speed], parameter 415. If the sign of the encoder is not the same as the displayed frequency, remove drive power and reverse encoder leads A and A NOT.
6. With the drive running, verify correct motor rotation and encoder direction. Set [Motor Fdbk Type], parameter 412 to “1, Quad Check.” Stop the drive.

*Rotate AutoTune Test*



**ATTENTION:** In this test the following conditions will occur:

- The motor will be run for 12 seconds at base frequency (60 Hz). Note that equipment travel during this 12 second interval can exceed equipment limits. However, travel distance can be reduced by setting [Maximum Speed], parameter 82 to a value less than 45 Hz (i.e. 22.5 Hz = 12 seconds at 30 Hz).
- The brake will be released without torque provided by the drive for 15 seconds.

To guard against personal injury and/or equipment damage, this test should not be performed if either of the above conditions are considered unacceptable by the user.

7. Set the following parameters as shown.

No.	Name	Value	Notes
053	[Motor Cntl Sel]	“4, FVC Vector”	
080	[Feedback Select]	“3, Encoder”	
061	[Autotune]	“2, Rotate Tune”	

8. Start the drive and run the motor in the desired direction. Parameters 062, 063, 064, and 121 will be updated.

*Inertia AutoTune Test*

9. Set [Inertia Autotune], parameter 067 to “1, Inertia Tune.”
10. Press Start and run the motor in the direction desired. Parameters 445, 446, and 450 will be updated.
11. Set [Speed Desired BW], parameter 449 to desired setting.
12. Set up is complete - check for proper operation.

## Drive Setup

### *TorqProve with Encoder*

To Enable TorqProve with an encoder, bit 0 of [TorqProve Cnfg], parameter 600 must be set to “1.” Once this is set, a Type 2 alarm will be active until the following settings are entered:

No.	Name	Value	Notes
053	[Motor Cntl Sel]	“4, FVC Vector”	
080	[Feedback Select]	“3, Encoder”	
412	[Motor Fdbk Type]	“1, Quad Check”	

In addition, [Stop Mode A/B], parameters 155/156 must be set to option “1, Ramp” and [DC Brake Time], parameter 159 must be set to “0.0 Secs.”

### *Encoderless TorqProve*

To Enable Encoderless TorqProve, both bits 0 and 1 of [TorqProve Cnfg], parameter 600 must be set to “1.” Once this is set, a Type 2 alarm will be active until the following settings are entered:

No.	Name	Value	Notes
053	[Motor Cntl Sel]	“4, FVC Vector” or “0, Sensrls Vect”	
080	[Feedback Select]	“1, Slip Comp”	

In addition, [Stop Mode A/B], parameters 155/156 must be set to option “1, Ramp” and [DC Brake Time], parameter 159 must be set to “0.0 Secs.”

### *Encoderless Guidelines*

You can not hold zero speed in encoderless mode or operate near zero speed because of this, it is very important to set [Minimum Speed], parameter 81 to **two or three times the slip frequency** when in encoderless mode. (Example: A 1740 RPM motor has 2 Hz of slip. Set [Minimum Speed] to 4..6 Hz.)

In addition, [Stop Mode A/B], parameters 155/156 must be set to option “1, Ramp” and [DC Brake Time], parameter 159 must be set to “0.0 Secs.”

Also set [Float Tolerance], parameter 606 to **one to three times the slip frequency** when in encoderless mode. You should also use fast accel and decel times (less than 2 seconds) when operating in encoderless mode.

## Installation/Wiring

When [TorqProve Cnfg] is set to “Enable,” the Digital Out 1 relay is used to control the external brake contactor. The normally open (N.O.) contact, when closed, is intended to energize the contactor. This provides the mechanical brake with voltage, causing the brake to release. Any interruption of power to the contactor will set the mechanical brake. Programming [Digital Out1 Sel], parameter 380 will be ignored when [TorqProve Cnfg] is set to “Enable.”

**Figure 6 - Typical 24V Torque Proving Configuration**

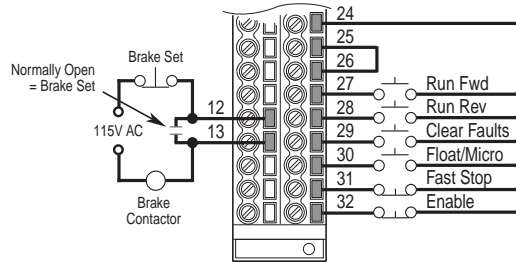

## Lifting/Torque Proving Application Programming

The PowerFlex 700 lifting application is mainly influenced by parameters 600 through 611 in the Torque Proving group of the Application file. [Figure 7](#) and the paragraphs that follow describe programming.

**Figure 7 - Torque Proving Flow Diagram**

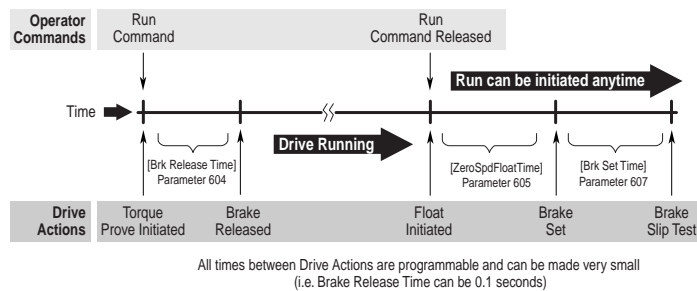

### Torque Proving

When the drive receives a start command to begin a lifting operation, the following actions occur:

1. The drive first performs a transistor diagnostic test to check for phase-to-phase and phase-to-ground shorts. A failure status from either of these tests will result in a drive fault and the brake relay will NOT be energized (brake remains set).

2. The drive will then provide the motor with flux as well as perform a check for current flow through all three motor phases. This ensures that torque will be delivered to the load when the mechanical brake is released. When torque proving is enabled, open phase loss detection is performed regardless of the setting of Bit 12 of [Fault Config 1], parameter 238.
3. If the drive passes all tests, the brake will be released and the drive will take control of the load after the programmed time in [Brk Release Time], parameter 604 which is the typical mechanical release time of the brake.

### *Brake Proving*

When the drive receives a stop command to end a lifting operation, the following actions occur:

1. The brake is commanded closed when the speed of the motor reaches zero.
2. After the time period programmed in [Brk Set Time], parameter 607, the drive will verify if the brake is capable of holding torque. It will do this by ramping the torque down at a rate set in [TorqLim SlewRate], parameter 608. Note that the drive can be started again at anytime without waiting for either of the above timers to finish.
3. While the torque is ramping down, the drive will perform a brake slip test. If movement exceeds the limit set in [BrkSlip Count], parameter 609, then an alarm is set (32, Brake Slipped) and the drive will start a brake slip procedure. The drive will allow the motor to travel the distance programmed [Brk Alarm Travel], parameter 610. Another slip test will be performed and will repeat continuously until; A) the load stops slipping, or B) the load reaches the ground. This feature keeps control of the load and returns it to the ground in a controlled manner in the event of a mechanical brake failure.

Once a Brake Slipped alarm occurs, drive power must be cycled to clear the alarm and re-start the drive.

### *Speed Monitoring / Speed Band Limit*

This routine is intended to fault the drive if the difference between the speed reference and the encoder feedback is larger than the value set in [Spd Dev Band], parameter 602 and the drive is NOT making any progress toward the reference. [SpdBand Integrat], parameter 603 sets the time that the speed difference can be greater than the deviation band before causing a fault and setting the brake.

### *Float*

Float is defined as the condition when the drive is holding the load at zero hertz while holding off the mechanical brake. The float condition starts when the frequency drops below the speed set in [Float Tolerance], parameter 606. Float will stay active for a period of time set by [ZeroSpdFloatTime], parameter 605. If a digital input (parameters 361...366) is set to "Micro Pos" (also Float) and it is closed, the Float condition will stay active and will disregard the timer. This signal is also available through a communication device, see [TorqProve Setup], parameter 601.

When encoderless TorqProve is enabled, the drive cannot hold the load at zero speed. Parameter 606 [Float Tolerance] will then define the speed at which the brake is set.

### *Micro Position*

Micro Position refers to rescaling of the commanded frequency by a percentage entered in [MicroPos Scale %], parameter 611. This allows for slower operation of a lift which provides an operator with better resolution when positioning a load. Micro Position is activated only when the drive is running at or near zero speed. This can be initiated by a digital input configured as Micro Pos or through a communication device ([TorqProve Setup]) which is the same digital input which signals the float condition. To allow the Micro Position digital input to change the speed command while the drive is running, enter a “1” in Parameter 600, Bit 2 “MicroPosSel.” A “0” will require drive to reach zero speed for micro position speed to become active.

### *Fast Stop*

Fast Stop is intended to stop the load as fast as possible then set the mechanical brake. The Fast Stop can be initiated from a digital input or through a communication device through [TorqProve Setup]. The difference from a normal stop is that the decel time is forced to be 0.1 seconds. When the Torque Proving function is enabled, the Float time is ignored at the end of the ramp. This feature can be used without enabling the Torque Proving function.

## Limit Switches for Digital Inputs

The PowerFlex 700 includes digital input selections for decel and end limit switches. These can be used for applications that use limit switches for decelerating near the end of travel and then stopping at the end position. The end limit switch can also be used for end limit stops as many hoists require. These inputs can be used with or without TorqProve enabled.

### *Decel Limit for Digital Inputs*

Decel Limit is enabled by selecting “Decel Limit” as one of the digital inputs in [Digital In1-6 Select], parameters 361-366. When this input is “low” (opposite logic), the speed reference command will change from the selected reference to the value in [Preset Speed 1], parameter 101. The deceleration rate will be based on the active deceleration time. This limit will be enforced only in the direction the drive was running when the switch was activated (momentarily or continuously, see “B” in [Figure 8](#)). The opposite direction will still be allowed to run at the selected reference speed. No speed limitation will occur between the limit switches (“A” in [Figure 8](#)).

Two different switches can be connected in series to one digital input to provide a decel limit at both ends of the application (that is, lift, conveyor, etc.). With proper set up, the drive will automatically apply the speed reduction based on the direction of the load even though only one digital input is being used. See “B” in [Figure 8](#).

### End Travel Limit for Digital Inputs

End Travel Limit is enabled by selecting “End Limit” as one of the digital inputs in [Digital In1-6 Select]. A “low” at this input (opposite logic) will cause the drive to do a fast decel (0.1 sec) and turn off. This Stop limit will be enforced only in the direction the drive was running when the switch was activated (momentarily or continuously, see “C” in [Figure 8](#)).

A Start command in the same direction will only allow 0 Hz to be commanded. A Start in the opposite direction will allow motion with a speed command from the selected speed reference. If TorqProve is Enabled, the drive will hold zero speed for a time determined by [ZeroSpdFloat Time], parameter 605.

Two different input switches can be connected in series to one digital input to provide an end limit at both ends of the application (for example, lift, conveyor, etc.). With proper set up, the drive will automatically apply the proper stopping based on the direction of the load even though only one digital input is being used.

### Limit Switch Set up

1. Move the load to a position between the two decel switches (“A” in [Figure 8](#)).
2. Select the switches in [Digital In1-6 Select]. If switches are only used on one end of travel, simply keep the load off of both switches when selecting in [Digital In1-6 Select].

If the set up is done incorrectly, the application will not move or will move at an incorrect (slower) speed. This can be corrected by selecting “Not Used” for both limit switches in [Digital In1-6 Select]. Then, move the load between the Decel Switches and select the limit switches again in [Digital In1-6 Select].

---

**IMPORTANT** When properly set up, the drive will remember its location during power cycles (or power loss) unless the load is manually moved during power down conditions. If this occurs, simply reset the feature using the procedure above.

---

**Figure 8 - Limit Switch Operation**

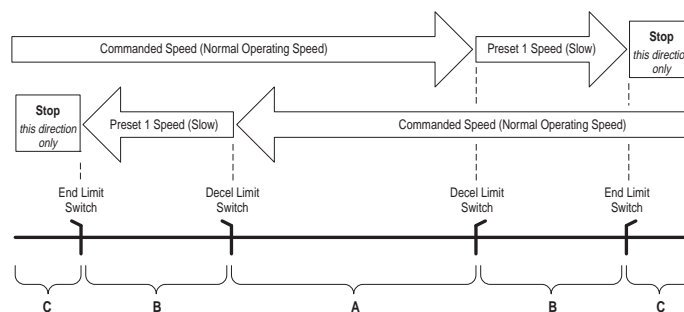

## Minimum Speed

Refer to [Reverse Speed Limit on page 136](#).

## Motor Control Technology

Within the PowerFlex family there are several motor control technologies:

- Torque Producers
- Torque Controllers
- Speed Regulators

### Torque Producers

#### *Volts/Hertz*

This technology follows a specific pattern of voltage and frequency output to the motor, regardless of the motor being used. The shape of the V/Hz curve can be controlled a limited amount, but once the shape is determined, the drive output is fixed to those values. Given the fixed values, each motor will react based on its own speed/torque characteristics.

This technology is good for basic centrifugal fan/pump operation and for most multi-motor applications. Torque production is generally good.

#### *Sensorless Vector*

This technology combines the basic Volts/Hertz concept with known motor parameters such as Rated FLA, Hp, Voltage, stator resistance and flux producing current. Knowledge of the individual motor attached to the drive allows the drive to adjust the output pattern to the motor and load conditions. By identifying motor parameters, the drive can maximize the torque produced in the motor and extend the speed range at which that torque can be produced.

This technology is excellent for applications that require a wider speed range and applications that need maximum possible torque for breakaway, acceleration or overload. Centrifuges, extruders, conveyors and others are candidates.

### Torque Controllers

#### *Vector*

This technology differs from the two above, because it actually controls or regulates torque. Rather than allowing the motor and load to actually determine the amount of torque produced, Vector technology allows the drive to regulate the torque to a defined value. By independently identifying and controlling both flux and torque currents in the motor, true control of torque is achieved. High bandwidth current regulators remain active with or without encoder feedback to produce outstanding results.

This technology is excellent for those applications where torque control, rather than mere torque production, is key to the success of the process. These include web handling, demanding extruders and lifting applications such as hoists or material handling.



Vector Control can operate in one of two configurations:

1. Encoderless

Not to be confused with Sensorless Vector above, Encoderless Vector based on Allen-Bradley's patented Field Oriented Control technology means that a feedback device is not required. Torque control can be achieved across a significant speed range without feedback.

2. Closed Loop (with Encoder)

Vector Control with encoder feedback utilizes Allen-Bradley's Force Technology™. This industry leading technology allows the drive to control torque over the entire speed range, including zero speed. For those applications that require smooth torque regulation at very low speeds or full torque at zero speed, Closed Loop Vector Control is the answer.

## Speed Regulators

Any of the PowerFlex drives, regardless of their motor control technology (Volts/Hz, Sensorless Vector or Vector) can be set up to regulate speed. Speed regulation and torque regulation must be separated to understand drive operation.

The PowerFlex 700 can offer improved speed regulation by adding speed feedback. Using a speed feedback device (encoder) tightens speed regulation to 0.001% of base speed and extends the speed range to zero speed.

## Motor DC Injection

The Motor DC Injection feature allows DC injection braking to be enabled by using a digital input when the drive is stopped. Programming the digital input through parameters 361...366 activates the DC injection braking. Firmware revisions before 10.001 only allowed DC injection braking to occur during a stop sequence of the drive. Firmware revisions 10.001 and later allow the flexibility to turn on DC injection after the drive has stopped, as long as there are no faults and the drive is enabled. To select this feature, the "MtrDC Inject" (69) option has been added to [Digital Inx Sel], parameters 361...366 (see [page 63](#)). The level of DC brake current injected into the motor is defined in [DC Brake Level], parameter 158. Bit 5 ("DC Braking") of [Drive Status 2], parameter 210 will indicate when the DC injection brake input is high.

## Motor Overload

For single motor applications the drive can be programmed to protect the motor from overload conditions. An electronic thermal overload  $I^2T$  function emulates a thermal overload relay. This operation is based on three parameters; [Motor NP FLA], [Motor OL Factor] and [Motor OL Hertz] (parameters 042, 048, and 047, respectively).

[Motor NP FLA] is multiplied by [Motor OL Factor] to allow the user to define the continuous level of current allowed by the motor thermal overload. [Motor OL Hertz] is used to allow the user to adjust the frequency below which the motor overload is derated.

The motor can operate up to 102% of FLA continuously. If the drive was just activated, it will run at 150% of FLA for 180 seconds. If the motor had been operating at 100% for over 30 minutes, the drive will run at 150% of FLA for 60 seconds. These values assume the drive is operating above [Motor OL Hertz], and that [Motor OL Factor] is set to 1.00.

Operation below 100% current causes the temperature calculation to account for motor cooling.

[Motor OL Hertz] defines the frequency where motor overload capacity derate should begin. The motor overload capacity is reduced when operating below [Motor OL Hertz]. For all settings of [Motor OL Hertz] other than zero, the overload capacity is reduced to 70% at an output frequency of zero.

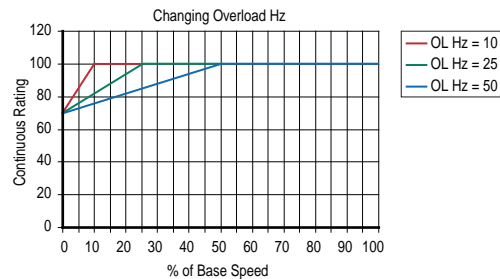
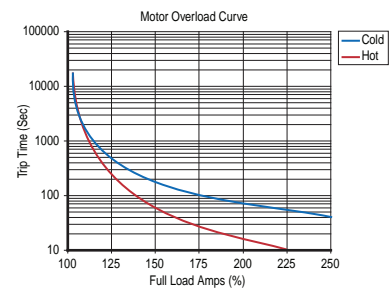

[Motor NP FLA] is multiplied by [Motor OL Factor] to select the rated current for the motor thermal overload. This can be used to raise or lower the level of current that will cause the motor thermal overload to trip. The effective overload factor is a combination of [Motor OL Hertz] and [Motor OL Factor].

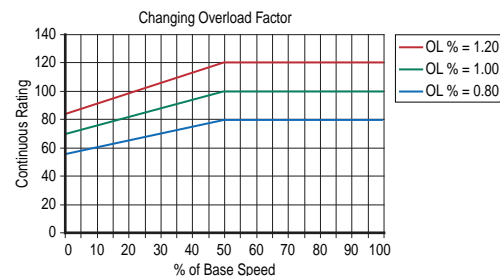

## Motor Overload Memory Retention Per 2005 NEC

Firmware version 4.002 or greater – has the ability to retain the motor overload count at power down per the 2005 NEC motor overtemp requirement. To Enable/Disable this feature, refer to the table below. Once Enabled, the value for [Testpoint 1 Sel] can be changed.

Overload Retention	[Testpoint 1 Sel], param 234	[Testpoint 1 Data], param 235
Enable	"629"	"1"
Disable	"499" <sup>(1)</sup>	"0" <sup>(1)</sup>

(1) Default setting.

Firmware version 6.002 or greater – when bit 0 of [Motor OL Mode], parameter 50 is set to "1," the value of [Motor OL Count], parameter 220 is maintained through a power cycle or drive reset. This is an enhanced version of the v4.002 Motor Overload Memory function. The testpoint method will still work, but the preferred method is to set [Motor OL Mode], parameter 50.

## Overspeed

Overspeed Limit is a user programmable value that allows operation at maximum speed, but also provides an "overspeed band" that will allow a speed regulator such as encoder feedback or slip compensation to increase the output frequency above maximum speed in order to maintain maximum motor speed.

[Figure 9](#) illustrates a typical Custom V/Hz profile. Minimum Speed is entered in Hertz and determines the lower speed reference limit during normal operation. Maximum Speed is entered in Hertz and determines the upper speed reference limit. The two "Speed" parameters only limit the speed reference and not the output frequency.

**Figure 9 - Custom V/Hz Profile**

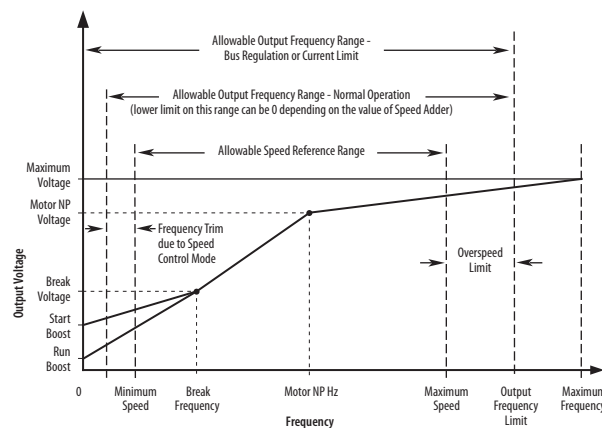

The actual output frequency at maximum speed reference is the sum of the speed reference plus "speed adder" components from functions such as slip compensation.

The Overspeed Limit is entered in Hertz and added to Maximum Speed and the sum of the two (Speed Limit) limit the output frequency. This sum (Speed Limit) must be compared to Maximum Frequency and an alarm is initiated which prevents operation if the Speed Limit exceeds Maximum Frequency.

## Position Indexer/Speed Profiler

The PowerFlex 700 includes a position indexer/speed profiler which provides either point-to-point positioning with a position regulator or speed profiling using a velocity regulator. Point-to-point positioning can be either incremental moves or absolute moves which are referenced to home. Encoder feedback (incremental encoder) is required for the position regulator. Speed profiling steps can be time-based or triggered by digital inputs, encoder counts or parameter levels. These speed profiling steps can be operated open loop or with an encoder.

The indexer is programmed by entering data into a 16 step array. Each step has several variables for optimal customization (see below). The steps can be run in a continuous cycle or a single cycle. The process can also move to or from any step in the array.

Step Type	Value	Velocity	Accel Time	Decel Time	Next Step Condition	Dwell	Batch	Next
-----------	-------	----------	------------	------------	---------------------	-------	-------	------

This feature also includes homing capability to a limit switch or a marker pulse using an automatic homing procedure.

---

**IMPORTANT** The PowerFlex 700 uses an incremental encoder only. Since absolute encoders are not used, your process must be able to accommodate this homing procedure after a power down or power loss.

---

### Common Guidelines for all Step Types

- **Enabling Position Indexer/Speed Profiler**  
This feature is enabled by selecting “7, Pos/Spd Prof” in [Speed/Torque Mod], parameter 088. Parameters 700...877 set up the indexer/profiler.
- **Motor Control Modes**  
For Position Indexing with an encoder, only FVC Vector Control should be used for optimum performance.  
For Velocity Profiling, any motor control mode can be used. However, Sensorless Vector or FVC Vector Control modes will offer the best performance.
- **Direction Control**  
The drive must be configured to allow the profile to control the direction. This is accomplished by setting [Direction Mode], parameter 190 to “Bipolar” (default is “Unipolar”).
- **Speed Regulator**  
The bandwidth of the speed regulator will affect the performance. If the connected inertia is relatively high, the bandwidth will be low and therefore a bit sluggish. When programming the acceleration and deceleration rates for each step, do not make them too aggressive or the regulator will be limited and therefore overshoot the desired position.

- Limits

Many threshold values can affect the performance of the profile/indexer. To help minimize the possibility of overshooting a position, ensure that the following parameters are set for the best performance.

No.	Parameter	Description
153	[Regen Power Limit]	Default is –50% and will likely require a greater negative value. A brake or other means of dissipating regenerative energy is recommended.
147	[Current Lmt Sel]	By default these parameters are set to provide 150% of drive rating. If lowered, the performance can be degraded.
148	[Current Lmt Val]	
161 162	[Bus Reg Mode A] [Bus Reg Mode B]	The default setting will adjust frequency to regulate the DC Bus voltage under regenerative conditions. This will most likely cause a position overshoot. To resolve this, select “Dynamic Brak” and size the load resistor for the application.

## Position Loop Tuning

Two parameters are available for tuning the position loop.

- [Pos Reg Filter], parameter 718 is a low pass filter at the input of the position regulator.
- [Pos Reg Gain], parameter 719 is a single adjustment for increasing or decreasing the responsiveness of the regulator.

By default these parameters are set at approximately a 6:1 ratio (filter = 25, gain = 4). It is recommended that a minimum ratio of 4:1 be maintained.

## Profile Command Control Word

The profile/indexer is controlled with [Pos/Spd Prof Cmd], parameter 705. The bit definitions are as follows:

Bit	Name	Description
0	Start Step 0	The binary value of these bits determines which step will be the starting step for the profile when a start command is issued. If the value of these bits are not 1-16 the drive will not run since it does not have a valid step to start from. Valid Examples: 00011 = step 3, 01100 = step 12
1	Start Step 1	
2	Start Step 2	
3	Start Step 3	
4	Start Step 4	
5-7	Reserved	Reserved for future use
8	Hold Step	When set, this command will inhibit the profile from transitioning to the next step when the condition(s) required are satisfied. When the <i>hold</i> command is released, the profile will transition to the next step.
9	Pos Redefine	This bit is used to set the present position as <i>home</i> . When this bit is set, [Profile Status] bit <i>At Home</i> will be set and the [Units Traveled] will be set to zero.
10	Find Home	This bit is used to command the find home routine.
11	Vel Override	When set, the velocity of the present step will be multiplied by the value in [Vel Override].
12-31	Reserved	Reserved for future use

The [Pos/Spd Prof Cmd] bits can be set via DPI interface (HIM or Comm) or digital inputs. When digital input(s) are programmed for “Pos Sel 1-5,” the starting step of the profile is exclusively controlled by the digital inputs. The DPI interface value for bits 0-4 will be ignored.

If a digital input is configured for the bit 8-11 functions (see above), the DPI interface or the digital input can activate the command.

### Velocity Regulated Step Types and Parameters

Each of the Velocity Regulated steps has the following associated parameters or functions. Refer to the following page for descriptions.

Step Type	Value	Velocity	Accel Time	Decel Time	Next Step Condition	Dwell	Batch	Next
<b>Time</b>	Total Move Time	Speed & Direction	Accel Rate	Decel Rate	Time greater than [Step Value]	Dwell Time	Batch Number	Next Step
<b>Time Blend</b>	Total Time	Speed & Direction	Accel Rate	Decel Rate	Time greater than [Step Value]	NA	NA	Next Step
<b>Digital Input</b>	Digital Input Number	Speed & Direction	Accel Rate	Decel Rate	Digital Input logic	Dwell Time	Batch Number	Next Step
<b>Encoder Incremental Blend</b>	Position & Direction	Speed	Accel Rate	Decel Rate	At Position [Step Value]	NA	NA	Next Step
<b>Parameter Level</b>	Parameter Number +/-	Speed & Direction	Accel Rate	Decel Rate	[Step Value] > or < [Step Dwell]	Compare Value	NA	Next Step
<b>End</b>	NA	NA	NA	Decel Rate	At Zero transition	Dwell Time	NA	Stop

NA = Function not applicable to this step type

#### *Time*

When started, the drive will ramp to the desired velocity, hold the speed, and then ramp to zero in the programmed time for the given step. Dwell time and batch affect when the next step is executed.

#### *Time Blend*

When started, the drive will ramp to the desired velocity and hold speed for the programmed time. At this point it will transition to the next step and ramp to the programmed velocity without going to zero speed.

#### *Digital Input*

When started, the drive will ramp to the desired velocity and hold speed until the digital input programmed in the value transitions in the direction defined. When this occurs, the profile will transition to the next step after dwell and batch settings are satisfied. It will then ramp to the programmed velocity without going to zero speed.

*Encoder Incremental Blend (EnIncrBlend)*

When started, the drive will ramp to the desired velocity and hold speed until the units of travel programmed is reached (within tolerance window). The profile will then transition to the next step and the drive will ramp to the speed of the new step without first going to zero speed.

*Encoder Incremental Blend with Hold*

This profile is the same as the previous, but contains the “Hold” function. While “Hold” is applied, the step transition is inhibited. When released, the step can then transition if the conditions to transition are satisfied.

*Parameter Level (Param Level)*

When started, the drive will ramp to the desired velocity, hold speed and compare the parameter value of the parameter number programmed in [Step Value] to the [Step Dwell] level. The sign of the [Step Value] defines “less than or greater than” [Step Dwell]. When true, the profile will transition to the next step.

*End*

The drive ramps to zero speed and stops the profile. It clears the current step bits and sets the “Complete” bit (14) in [Profile Status], parameter 700.

## Position Regulated Step Types and Parameters

Each of the Position Regulated steps has the following associated parameters or functions:

Step Type	Value	Velocity	Accel Time	Decel Time	Next Step Condition	Dwell	Batch	Next
<b>Encoder Absolute</b>	Position & Direction	Speed	Accel Rate	Decel Rate	At Position	Dwell Time	NA	Next Step
<b>Encoder Incremental</b>	Position & Direction	Speed	Accel Rate	Decel Rate	At Position	Dwell Time	Batch Number	Next Step
<b>End Hold Position</b>	NA	NA	NA	NA	At Position	Dwell Time	NA	Stop

NA = Function not applicable to this step type

*Encoder Absolute*

This is a move to an absolute position, which is referenced from the home position. When started the drive ramps to the desired velocity in the direction required, holds the speed, then ramps to zero speed landing or ending at the commanded position within the tolerance window.

*Encoder Incremental (Encoder Incr)*

This is a move increment from the current position in the direction, distance and speed programmed. When started the drive ramps to the desired velocity, holds the speed, then ramps to zero speed landing or ending at the commanded position within the tolerance window.

*End Hold Position*

The drive holds the last position and stops the profile after dwell time expires. Must be used with position regulated profile. Do Not use “End.”

**Homing Routine**

Each time the profile/indexer is enabled, the drive requires a home position to be detected. The following options are available:

- Homing to Marker Pulse with Encoder Feedback

When “Find Home” is commanded the homing routine is run when a start command is issued. The Homing bit (11) in [Profile Status] will be set while the homing routine is running. The drive will ramp to the speed and direction set in [Find Home Speed], parameter 713 at the rate set in [Find Home Ramp], parameter 714 until the digital input defined as “Home Limit” is activated. The drive will then ramp to zero and then back up to first marker pulse prior to the Home Limit switch at 1/10 the [Find Home Speed]. When on the marker pulse, the At Home bit (13) is set in [Profile Status] and the drive is stopped.

Figure 10 shows the sequence of operation for homing to a marker pulse. [Encoder Z Chan], parameter 423 must be set to “Marker Input” or “Marker Check” for this type of homing.

**Figure 10 - Homing to Marker**

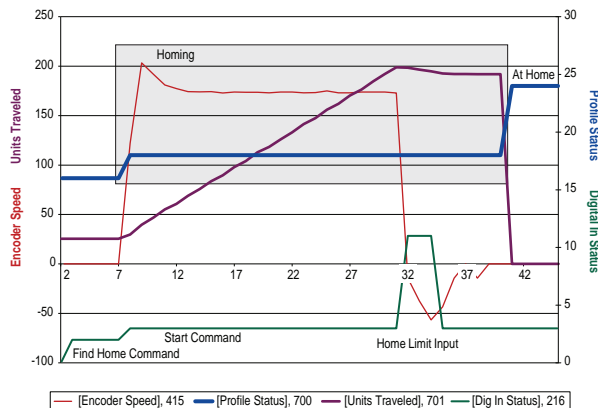



- Homing to Limit Switch with Encoder Feedback

When “Find Home” is commanded, the homing routine is run when a start command is issued. The Homing bit (11) in [Profile Status] will be set while the homing routine is running. The drive will ramp to the speed and direction set in [Find Home Speed] at the rate set in [Find Home Ramp] until the digital input defined as Home Limit is activated. The drive will then reverse direction at 1/10 the [Find Home Speed] to the point where the Home Limit switch activated and stop.

[Figure 11](#) shows the sequence of operation for homing to a limit switch with encoder feedback (without a marker pulse). [Encoder Z Chan] must be set to “Pulse Input” or “Pulse Check.”

**Figure 11 - Homing to a Limit Switch**

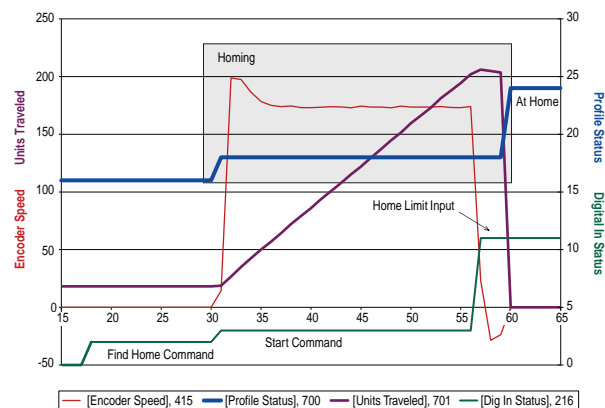

- Homing to Limit Switch w/o Encoder Feedback

When “Find Home” is commanded, the homing routine is run when a Start command is issued. The Homing bit (11) in [Profile Status] will be set while the homing routine is running. The drive will ramp to the speed and direction set in [Find Home Speed] at the rate set in [Find Home Ramp] until the digital input defined as Home Limit is activated. The drive will then decelerate to zero. If the switch is no longer activated, the drive will reverse direction at 1/10 the [Find Home Speed] to the switch position and then stop. The Home Limit switch will be active when stopped.

[Figure 12](#) shows the sequence of operation for homing to a limit switch without encoder feedback.

**Figure 12 - Homing to Limit Switch (No Feedback)**

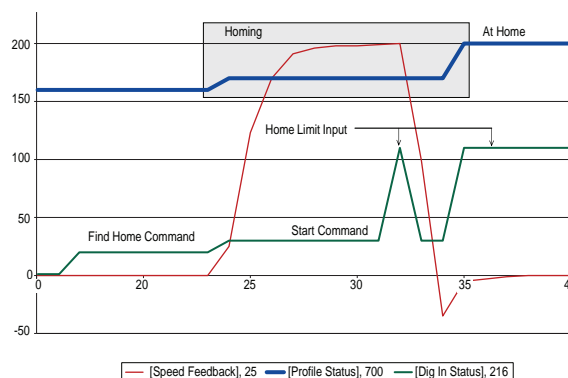

- Position Redefine

When “Pos Redefine” is set, the present position is established as Home and [Units Traveled] is set to zero.

- Disable Homing Requirement

If a home position is not required, the routine can be disabled by clearing [Alarm Config 1], bit 17 (Prof SetHome) to “0.” This will disable the alarm from being set when Pos/Spd Profile mode is configured in [Speed/Torque Mod] and will set the present position as Home.

Once Homing is complete the Find Home command must be removed to allow the profile to be run. If the Find Home command is not removed, when the drive is started the routine will see that it is At Home and the drive will stop.

### Example 1: Five Step Velocity Profile (Time-Based and Encoder-Based)

The first three steps are “Time” steps followed by an “Encoder Abs” step to zero and then an “End” step. For each Time step the drive ramps at [Step x AccelTime] to [Step x Velocity] in the direction of the sign of [Step x Velocity]. The drive then decelerates at [Step X DecelTime] to zero. The [Step X Value] is programmed to the desired time for the total time of the accel, run and decel of the step. Each step has a 1 second time programmed in [Step X Dwell] which is applied to the end of each step. After the dwell time expires, the profile transitions to the next step. The absolute step is used to send the profile back to the home position. This is done by programming [Step 4 Value] to zero.

Figure 13 - Time Example

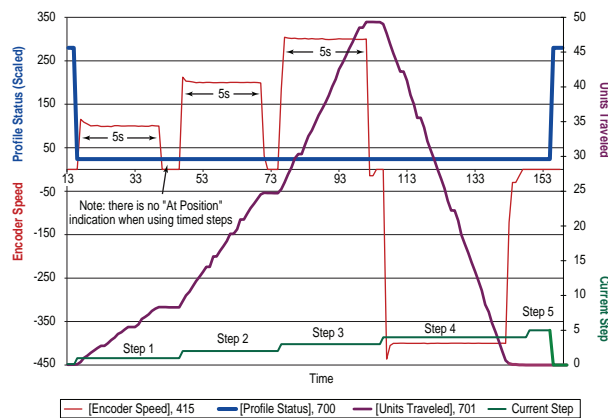

Step #	[Step x Type]	[Step x Velocity]	[Step x AccelTime]	[Step x DecelTime]	[Step x Value]	[Step x Dwell]	[Step x Batch]	[Step x Next]
1	Time	100	0.5	0.5	5.00	1.00	1	2
2	Time	200	0.5	0.5	5.00	1.00	1	3
3	Time	300	0.5	0.5	5.00	1.00	1	4
4	Encoder Abs	400	0.5	0.5	0.00	1.00	1	5
5	End	N/A	N/A	0.5	N/A	0.00	N/A	N/A

## Example 2: Six Step Velocity Profile (Digital Input-Based)

In each step, the drive ramps at [Step x AccelTime] to [Step x Velocity] in the direction of the sign of [Step x Velocity] until a digital input is detected. When the input is detected it transitions to the next step in the profile. This continues through Digital Input #6 activating step 5. Step 5 is defined as a “Parameter Level” step. Digital Inputs used in the profile must be defined as “Prof Input.”

**IMPORTANT** A transition is required to start each step. If the input is already true when transitioning to a digital input step, the indexer will not go to the next step.

**Figure 14 - Digital Input Example**

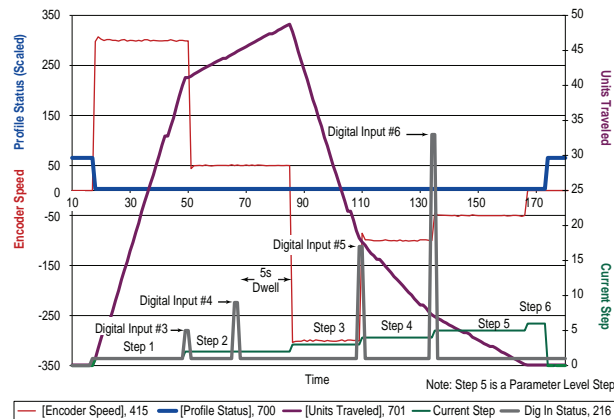

Step #	[Step x Type]	[Step x Velocity]	[Step x AccelTime]	[Step x DecelTime]	[Step x Value]	[Step x Dwell]	[Step x Batch]	[Step x Next]
1	Digital Input	300	0.5	0.5	3.00	0.00	1	2
2	Digital Input	50	0.5	0.5	4.00	5.00	1	3
3	Digital Input	-300	0.5	0.5	5.00	0.00	1	4
4	Digital Input	-100	0.5	0.5	6.00	0.00	1	5
5	Param Level	-50	0.5	0.5	701	0.00	1	6
6	End	N/A	N/A	0.5	N/A	0.00	N/A	N/A

### Example 3: Five Step Positioner with Incremental Encoder

The first three steps of this indexer are “Encoder Incr” steps followed by an “Encoder Abs” step to zero and then an “End Hold Position” step. For each “Encoder Incr” step the drive ramps at [Step x AccelTime] to [Step x Velocity] in the direction of the sign of [Step x Value]. It then decelerates at the rate of [Step x DecelTime] to the position programmed in [Step x Value] which sets the desired units of travel for the step. When the value programmed in [Step x Value] is reached within the tolerance window programmed in [Encoder Pos Tol], the “At Position” bit is set in [Profile Status]. In this example a dwell value held each of the first three steps “At Position” for 1 second. After the [Step x Dwell] time expires, the profile transitions to the next step. The absolute step is used to send the profile back to the home position. This is accomplished by programming [Step 4 Value] to zero.

Figure 15 - Encoder Incremental w/Dwell Example

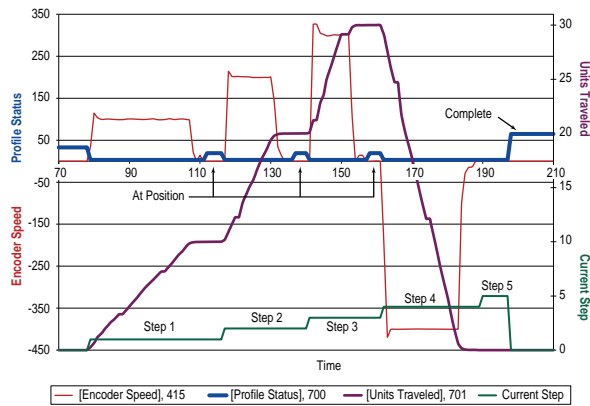

Step #	[Step x Type]	[Step x Velocity]	[Step x AccelTime]	[Step x DecelTime]	[Step x Value]	[Step x Dwell]	[Step x Batch]	[Step x Next]
1	Encoder Incr	100	0.5	0.5	10.00	1.00	1	2
2	Encoder Incr	200	0.5	0.5	10.00	1.00	1	3
3	Encoder Incr	300	0.5	0.5	10.00	1.00	1	4
4	Encoder Abs	400	0.5	0.5	0.00	1.00	N/A	5
5	End Hold Position	N/A	N/A	0.5	N/A	0.00	N/A	N/A

## Power Loss Ride Through

When AC input power is lost, energy is being supplied to the motor from the DC bus capacitors. The energy from the capacitors is not being replaced (via the AC line), thus, the DC bus voltage will fall rapidly. The drive must detect this fall and react according to the way it is programmed. Two parameters display DC bus voltage:

- [DC Bus Voltage] - displays the instantaneous value
- [DC Bus Memory] - displays a 6 minute running average of the voltage

All drive reactions to power loss are based on [DC Bus Memory]. This averages low and high line conditions and sets the drive to react to the average rather than assumed values. For example, a 480V installation would have a 480V AC line and produce a nominal 648V DC bus. If the drive were to react to a fixed voltage for line loss detect, (that is, 533V DC), then normal operation would occur for nominal line installations. However, if a lower nominal line voltage of 440V AC was used, then nominal DC bus voltage would be only 594V DC. If the drive were to react to the fixed 533V level (only -10%) for line loss detect, any anomaly might trigger a false line loss detection. Line loss, therefore always uses the 6 minute average for DC bus voltage and detects line loss based on a fixed percentage of that memory. In the same example, the average would be 594V DC instead of 650V DC and the fixed percentage, 27% for “Coast to Stop” and 18% for all others, would allow identical operation regardless of line voltage.

The PowerFlex 70 uses only these fixed percentages. The PowerFlex 700 can selectively use the same percentages or the user can set a trigger point for line loss detect. The adjustable trigger level is set using [Power Loss Level], see [page 43](#).

**Figure 16 - Power Loss Mode = Coast**

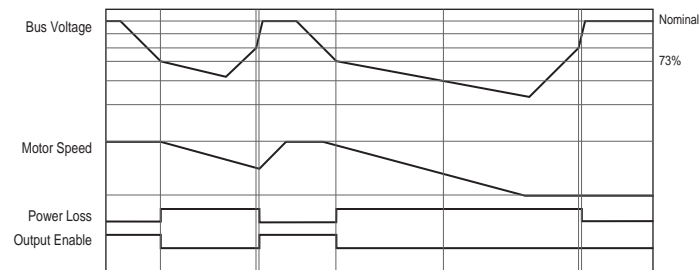

**Figure 17 - Power Loss Mode = Decel**

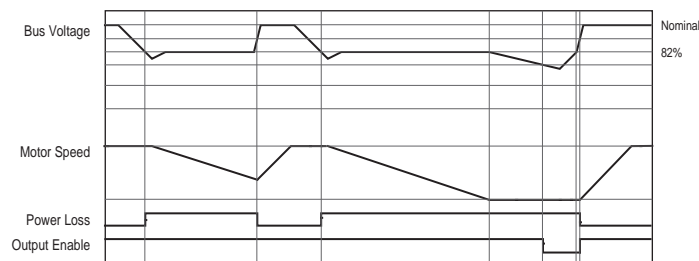

## Process PID

The internal PI function of the PowerFlex 700 provides closed loop process control with proportional and integral control action. The function is designed for use in applications that require simple control of a process without external control devices. The PI function allows the microprocessor of the drive to follow a single process control loop.

The PI function reads a process variable input to the drive and compares it to a desired setpoint stored in the drive. The algorithm will then adjust the output of the PI regulator, changing drive output frequency to try and make the process variable equal the setpoint.

It can operate as trim mode by summing the PI loop output with a master speed reference.

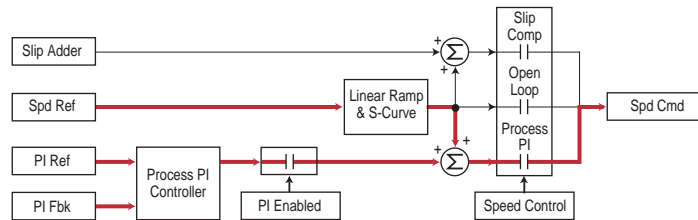

Or, it can operate as control mode by supplying the entire speed reference. This method is identified as “exclusive mode.”

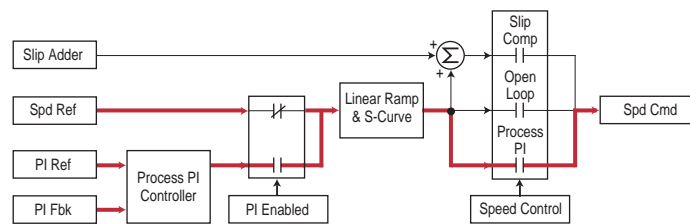

## PI Enable

The output of the PI loop can be turned on (enabled) or turned off (disabled). This control allows the user to determine when the PI loop is providing part or all of the commanded speed. The logic for enabling the PI loop is shown below.

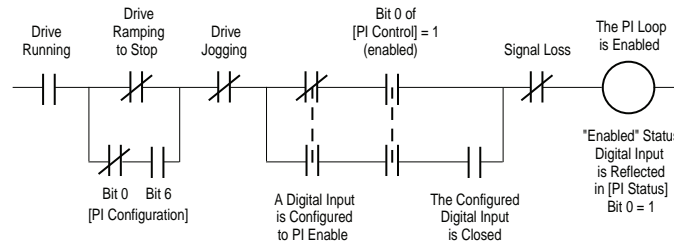

The drive must be running for the PI loop to be enabled. The loop will be disabled when the drive is ramping to a stop (unless “Stop Mode” is configured in [PI Configuration]), jogging or the signal loss protection for the analog input(s) is sensing a loss of signal.

If a digital input has been configured to “PI Enable,” two events are required to enable the loop: the digital input must be closed AND bit 0 of the PI Control parameter must be = 1.

If no digital input is configured to “PI Enable,” then only the Bit 0 = 1 condition must be met. If the bit is permanently set to a “1”, then the loop will become enabled as soon as the drive goes into “run.”

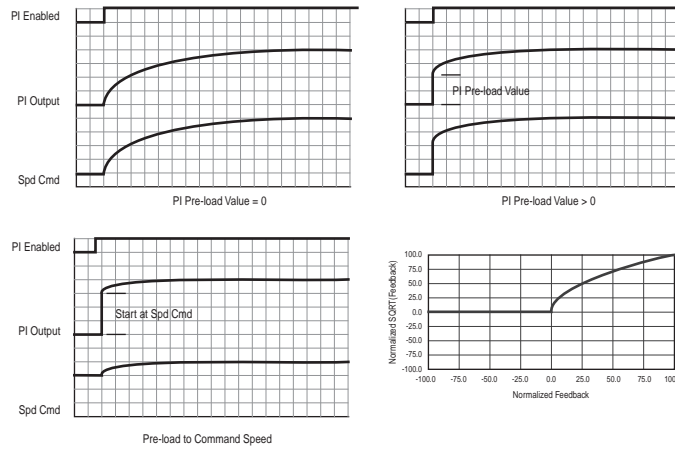

**Figure 18 - Process Trim**

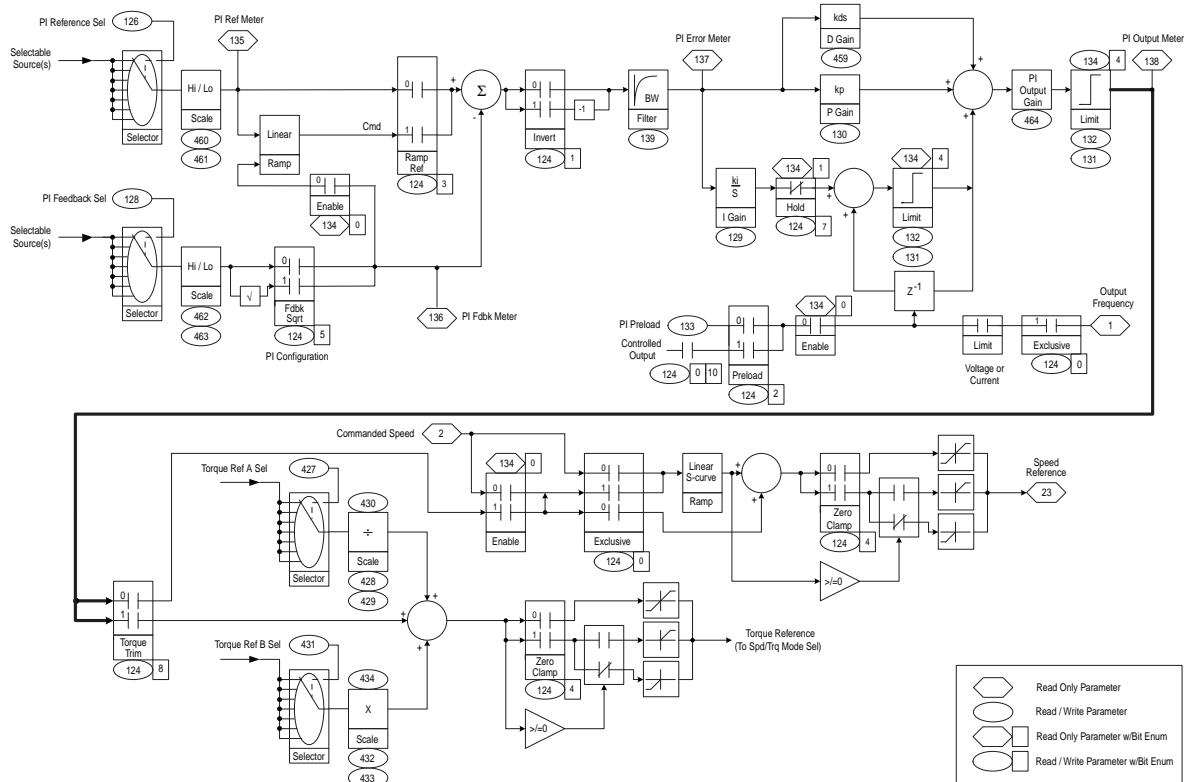

## Reverse Speed Limit

Figure 19 - [Rev Speed Limit], parameter 454 set to zero

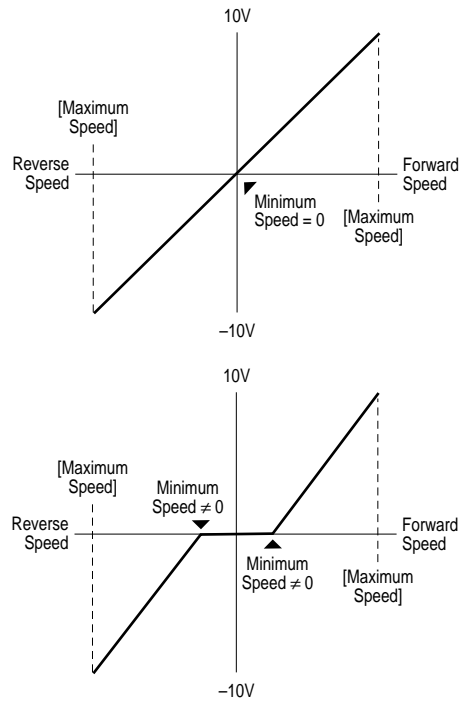
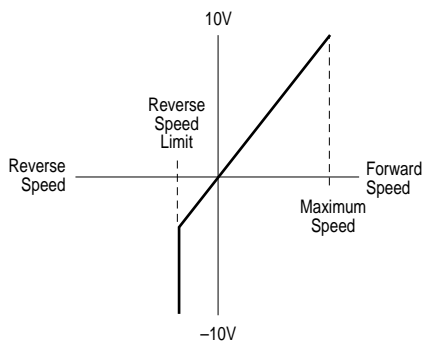

Figure 20 - [Rev Speed Limit], parameter 454 set to a non-zero value





## Skip Frequency

**Figure 21 - Skip Frequency**

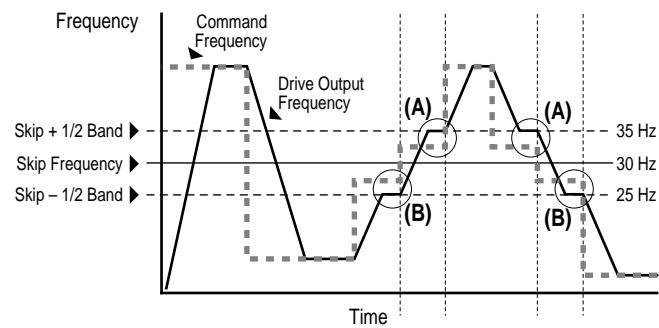

Some machinery can have a resonant operating frequency that must be avoided to minimize the risk of equipment damage. To assure that the motor cannot continuously operate at one or more of the points, skip frequencies are used. Parameters 084...086, ([Skip Frequency 1-3]) are available to set the frequencies to be avoided.

The value programmed into the skip frequency parameters sets the center point for an entire “skip band” of frequencies. The width of the band (range of frequency around the center point) is determined by parameter 87, [Skip Freq Band]. The range is split, half above and half below the skip frequency parameter.

If the commanded frequency of the drive is greater than or equal to the skip (center) frequency and less than or equal to the high value of the band (skip plus 1/2 band), the drive will set the output frequency to the high value of the band. See (A) in [Figure 21](#).

If the commanded frequency is less than the skip (center) frequency and greater than or equal to the low value of the band (skip minus 1/2 band), the drive will set the output frequency to the low value of the band. See (B) in [Figure 21](#).

Acceleration and deceleration are not affected by the skip frequencies. Normal accel/decel will proceed through the band once the commanded frequency is greater than the skip frequency. See (A) & (B) in [Figure 21](#). This function affects only continuous operation within the band.

**Skip Frequency Examples**

The skip frequency will have hysteresis so the output does not toggle between high and low values. Three distinct bands can be programmed. If none of the skip bands touch or overlap, each band has its own high/low limit.

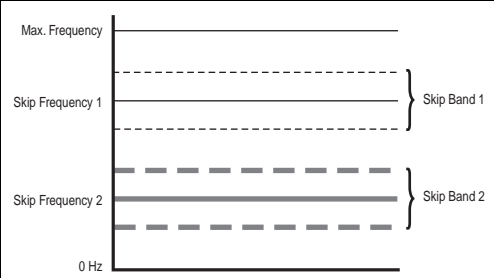

If skip bands overlap or touch, the center frequency is recalculated based on the highest and lowest band values.

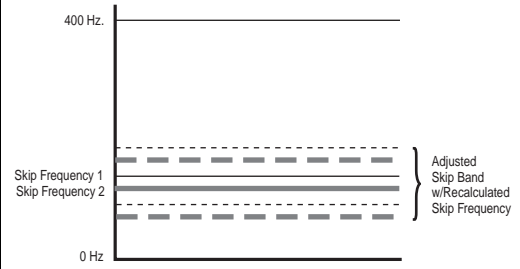

If a skip band(s) extend beyond the max frequency limits, the highest band value will be clamped at the max frequency limit. The center frequency is recalculated based on the highest and lowest band values.

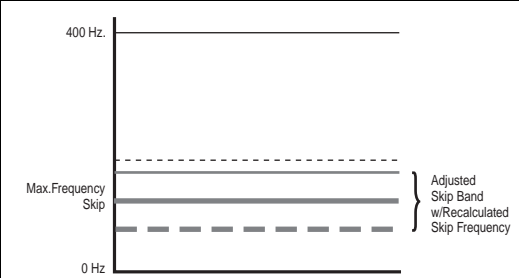

If the band is outside the limits, the skip band is inactive.

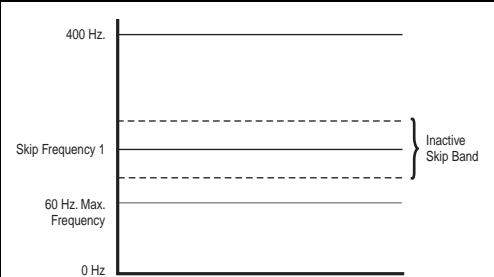

**Sleep Wake Mode**

This function stops (sleep) and starts (wake) the drive based on separately configurable analog input levels rather than discrete start and stop signals. When enabled in “Direct” mode, the drive will start (wake) when an analog signal is greater than or equal to the user specified [Wake Level], and stop the drive when an analog signal is less than or equal to the user specified [Sleep Level]. When Sleep Wake is enabled for “Invert” mode<sup>(1)</sup>, the drive will start (wake) when an analog signal is less than or equal to the user specified [Wake Level], and stop the drive when an analog signal is greater than or equal to the user specified [Sleep Level].

(1) Invert mode is only available with Vector firmware 3.xxx and later.

## Definitions

- **Wake** - A start command generated when the analog input value remains above [Wake Level] (or below when Invert mode is active) for a time greater than [Wake Time].
- **Sleep** - A Stop command generated when the analog input value remains below [Sleep Level] (or above when Invert mode is active) for a time greater than [Sleep Time].
- **Speed Reference** – The active speed command to the drive as selected by drive logic and [Speed Ref x Sel].
- **Start Command** - A command generated by pressing the Start button on the HIM, closing a digital input programmed for Start, Run, Run Forward or Run Reverse.

Refer to [Figure 22](#).

**Figure 22 - Sleep Wake Mode**

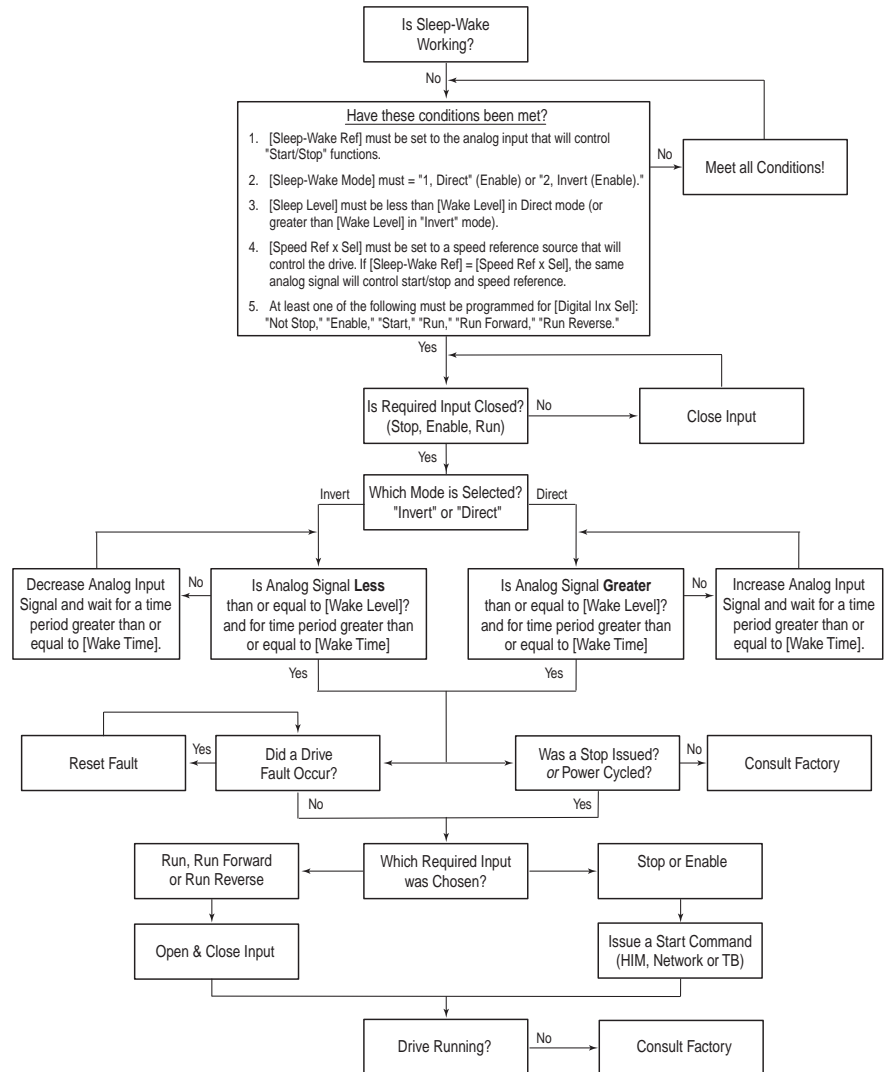

## Start At PowerUp

A powerup delay time of up to 30 seconds can be programmed through [Powerup Delay], parameter 167. After the time expires, the drive will start if all of the start permissive conditions are met. Before that time, restart is not possible.

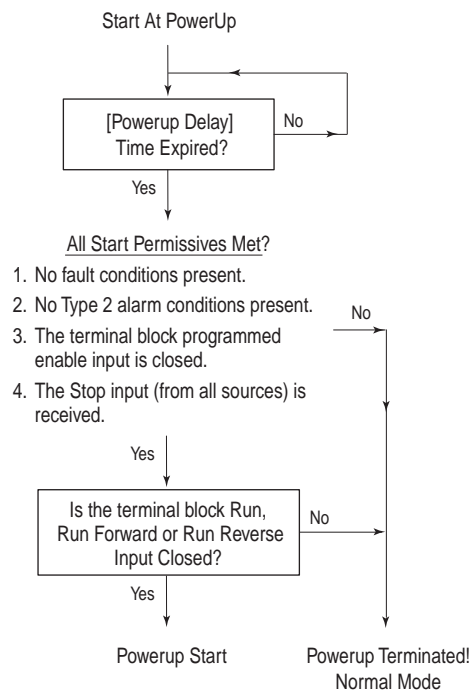

## Stop Mode

The PowerFlex 700 offers several methods for stopping a load. The method/mode is defined by [Stop/Brk Mode A/B], parameters 155 and 156. These modes include:

- Coast
- Ramp
- Ramp to Hold
- DC Brake
- Fast Brake

Additionally, [Flux Braking], parameter 166 can be selected separately to provide additional braking during a “Stop” command or when reducing the speed command. For “Stop” commands, this will provide additional braking power during “Ramp” or “Ramp to Hold” selections only. If “Fast Brake” or “DC Brake” is used, “Flux Braking” will only be active during speed changes (if enabled).

A “Ramp” selection will always provide the fastest stopping time if a method to dissipate the required energy from the DC bus is provided (that is, resistor brake, regenerative brake, etc.). The alternative braking methods to external brake requirements can be enabled if the stopping time is not as restrictive. Each of these methods will dissipate energy in the motor (use care to avoid motor overheating). [Table 16](#) describes several braking capability examples.

**Table 16 - Braking Method Examples**

Method	Use When Application Requires...	Braking Power
Ramp	<ul style="list-style-type: none"> <li>The fastest stopping time or fastest ramp time for speed changes (external brake resistor or regenerative capability required for ramp times faster than the methods below).</li> <li>High duty cycles, frequent stops or speed changes. (The other methods can result in excessive motor heating).</li> </ul>	Most, if an external resistor or regenerative device is connected.
Fast Brake	<ul style="list-style-type: none"> <li>Additional braking capability without use of an external brake resistor or regenerative unit, but only effective during stop events, not speed changes.</li> </ul> <p><b>Important:</b> For this feature to function properly the active Bus Reg Mode A or B must be set to Adjust "Freq" and <b>NOT</b> be "Disabled!"</p>	More than Flux Braking or DC Brake
Flux Braking	<p>In some applications, Flux Braking can provide a method for fast speed changes or stops. It is not suitable for high inertia loads or high duty cycle operation for applications greater than 1 cycle per minute. This feature supplies additional flux current to the motor and can cause motor thermistor or overvoltage faults in the drive.</p> <ul style="list-style-type: none"> <li>Fast speed changes and fast stopping time.</li> <li>Typical stop from speeds below 50% of base speed ("Flux Braking" will likely stop the load faster than "Fast Brake" in this case).</li> </ul> <p><b>Important:</b> This can be used in conjunction with "Ramp" or "Ramp to Hold" for additional braking power or with "Fast Brake" or "DC Brake" for speed changes.</p> <p><b>Important:</b> For this feature to function properly the active Bus Reg Mode A or B must be set to Adjust "Freq" and <b>NOT</b> be "Disabled!"</p>	More than DC Brake
DC Brake	<ul style="list-style-type: none"> <li>Additional braking capability without use of external brake resistor or regenerative units</li> </ul>	Less than above methods

## Configuration

- [Stop/Brk Mode A], parameter 155
- [Stop/Brk Mode B], parameter 156
  - 0 = Coast
  - 1 = Ramp
  - 2 = Ramp to Hold
  - 3 = DC Brake
  - 4 = Fast Brake
- [DC Brk Lvl Sel], parameter 157
  - 0 = "DC Brake Lvl" – selects parameter 158 as the source for the DC brake level
  - 1 = "Analog in 1"
  - 2 = "Analog in 2"
- [DC Brake Level], parameter 158 – sets the DC brake level in amps, when parameter 157 = "DC Brake Lvl"
- [DC Brake Time], parameter 159 – sets the amount of time that DC braking is applied after the ramp (if any).
- [Flux Braking], parameter 166 – may need to adjust parameter 549
  - 0 = Disabled, 1 = Enabled
- [Digital InX Sel], parameters 361...366
  - 13 = "Stop Mode B" – setting a digital input to this function allows the use of a digital input to switch between Stop Mode A (open input) and Stop Mode B (closed input).
  - 38 = "Fast Stop" – setting a digital input to this function allows the use of a digital input to, when opened, initiate a stop with a 0.1 second decel time. If torque proving is being used, float will be ignored at the end of the ramp and the mechanical brake will be set.

Detailed Operation

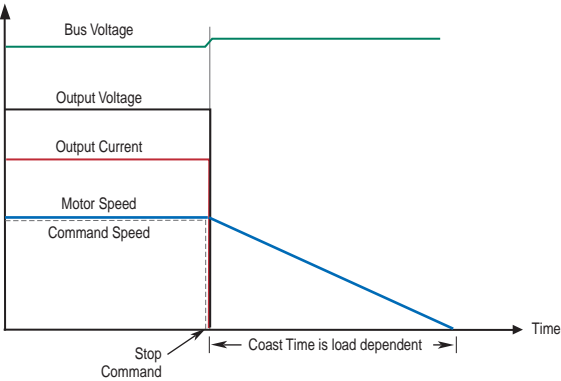
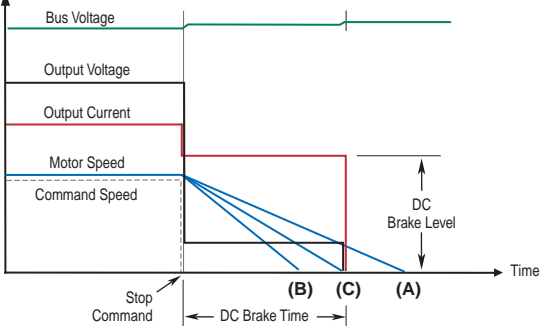
Mode	Description
Coast to Stop	 <p><b>Coast</b> is selected by setting [Stop Mode A/B] to a value of "0." When in Coast to Stop, the drive acknowledges the Stop command by shutting off the drive output and releasing control of the motor. The load and motor will coast until the kinetic energy is dissipated.</p>
DC Brake to Stop	 <p>This method uses DC injection of the motor to Stop and/or hold the load. <b>DC Brake</b> is selected by setting [Stop Mode A/B] to a value of "3." The amount of time that braking will be applied is programmed in [DC Brake Time] and the magnitude of the current used for braking is programmed in and [DC Brake Level]. This mode of braking will generate up to 40% of rated motor torque for braking and is typically used for low inertia loads with infrequent Stop cycles.</p> <ol style="list-style-type: none"> <li>1. On Stop, three-phase drive output goes to zero (off).</li> <li>2. Drive outputs DC voltage on the last used phase at the level programmed in [DC Brake Level], parameter 158. This voltage causes a "stopping" brake torque. If the voltage is applied for a time that is longer than the actual possible stopping time, the remaining time will be used to attempt to hold the motor at zero speed (decel profile "B" on the diagram above).</li> <li>3. DC voltage to the motor continues for the amount of time programmed in [DC Brake Time], parameter 159. Braking ceases after this time expires.</li> <li>4. After the DC Braking ceases, no further power is supplied to the motor. The motor/load may or may not be stopped. The drive has released control of the motor/load (decel profile "A" on the diagram above).</li> <li>5. The motor, if rotating, will coast from its present speed for a time that is dependent on the remaining kinetic energy and the mechanics of the system (inertia, friction, etc.).</li> <li>6. Excess motor current and/or applied duration, could cause motor damage. The user is also cautioned that motor voltage can exist long after the Stop command is issued. The right combination of Brake Level and Brake Time must be determined to provide the safest, most efficient stop (decel profile "C" on the diagram above).</li> </ol>

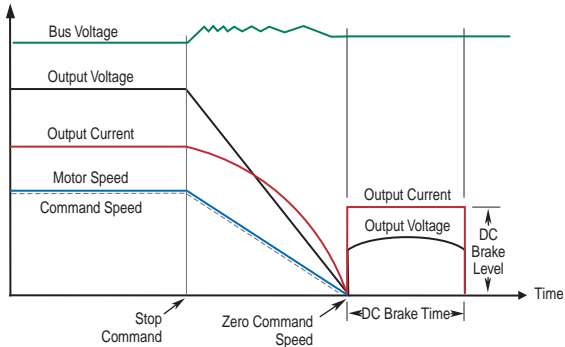
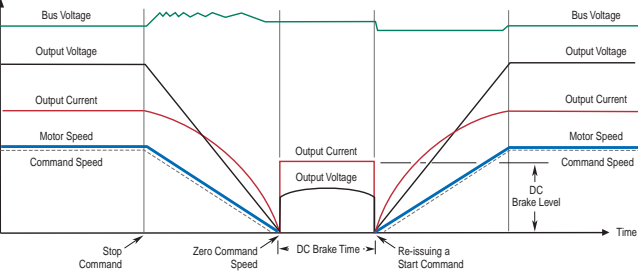
Mode	Description
<b>Ramp</b>	 <p>This method uses drive output reduction to stop the load. <b>Ramp</b> is selected by setting [Stop Mode A/B] to a value of "1." The drive will ramp the frequency to zero based on the deceleration time programmed into [Decel Time 1/2]. The "normal" mode of machine operation can utilize [Decel Time 1]. If the machine "stop" requires a faster deceleration than desired for normal deceleration, [Decel Time 2] can be activated with a faster rate selected. When in Ramp mode, the drive acknowledges the stop command by decreasing or "ramping" the output voltage and frequency to zero in a programmed period (Decel Time), maintaining control of the motor until the drive output reaches zero. The drive output is then shut off. The load and motor should follow the decel ramp. Other factors such as bus regulation and current limit can alter the actual decel rate.</p> <p>Ramp mode can also include a "timed" hold brake. Once the drive has reached zero output hertz on a Ramp-to-Stop and both parameters [DC Brake Time] and [DC Brake Level] are not zero, the drive applies DC to the motor producing current at the DC Brake Level for the DC Brake Time.</p> <ol style="list-style-type: none"> <li>1. On Stop, drive output will decrease according to the programmed pattern from its present value to zero. The pattern can be linear or squared. The output will decrease to zero at the rate determined by the programmed [Maximum Freq] and the programmed active [Decel Time x].</li> <li>2. The reduction in output can be limited by other drive factors such as bus or current regulation.</li> <li>3. When the output reaches zero the output is shut off.</li> <li>4. The motor, if rotating, will coast from its present speed for a time that is dependent on the mechanics of the system (inertia, friction, etc.).</li> </ol>
<b>Ramp to Hold</b>	 <p>This method combines two of the methods above. It uses drive output reduction to stop the load and DC injection to hold the load at zero speed once it has stopped.</p> <ol style="list-style-type: none"> <li>1. On Stop, drive output will decrease according to the programmed pattern from its present value to zero. The pattern can be linear or squared. The output will decrease to zero at the rate determined by the programmed [Maximum Freq] and the programmed active [Decel Time x].</li> <li>2. The reduction in output can be limited by other drive factors such as bus or current regulation.</li> <li>3. When the output reaches zero, three-phase drive output goes to zero (off) and the drive outputs DC voltage on the last used phase at the level programmed in [DC Brake Level], parameter 158. This voltage causes a "holding" brake torque.</li> <li>4. DC voltage to the motor continues until a Start command is reissued or the drive is disabled.</li> <li>5. If a Start command is reissued, DC Braking ceases and the drive returns to normal AC operation. If an Enable command is removed, the drive enters a "not ready" state until the enable is restored.</li> </ol>

Mode	Description
<b>Fast Brake</b>	<div data-bbox="748 247 1219 579"> </div> <p data-bbox="721 590 1469 663">This method takes advantage of the characteristic of the induction motor whereby frequencies greater than zero (DC braking) can be applied to a spinning motor that will provide more braking torque without causing the drive to regenerate.</p> <ol data-bbox="721 667 1469 1062" style="list-style-type: none"> <li>1. On Stop, the drive output will decrease based on the motor speed, keeping the motor out of the regen region. This is accomplished by lowering the output frequency below the motor speed where regeneration will not occur. This causes excess energy to be lost in the motor.</li> <li>2. The method uses a PI based bus regulator to regulate the bus voltage to a reference (for example, 750V) by automatically decreasing output frequency at the proper rate.</li> <li>3. When the frequency is decreased to a point where the motor no longer causes the bus voltage to increase, the frequency is forced to zero. DC brake will be used to complete the stop if the DC Braking Time is non-zero, then the output is shut off.</li> <li>4. Use of the current regulator ensures that over current trips don't occur and allow for an easily adjustable and controllable level of braking torque.</li> <li>5. Use of the bus voltage regulator results in a smooth, continuous control of the frequency and forces the maximum allowable braking torque to be utilized at all times.</li> <li>6. <b>Important:</b> For this feature to function properly the active Bus Reg Mode A or B must be set to Adjust "Freq" and NOT be "Disabled."</li> </ol> <p data-bbox="721 1087 967 1115"><b>Test Example for Fast Braking</b></p> <div data-bbox="721 1121 1382 1535"> </div> <p data-bbox="721 1566 1118 1593"><b>Implementation Block Diagram for Fast Braking</b></p> <div data-bbox="721 1608 1414 1944"> </div>



## Stop Dwell Time

Parameter 452 [Stop Dwell Time] sets an adjustable delay time between detecting zero speed and disabling the speed and torque regulators, when responding to a stop command.

---

**IMPORTANT** Consult industry and local codes when setting the value of this parameter.

---

**Figure 23 - Drive Operation When Par. 452 [Stop Dwell Time] Equals Zero**

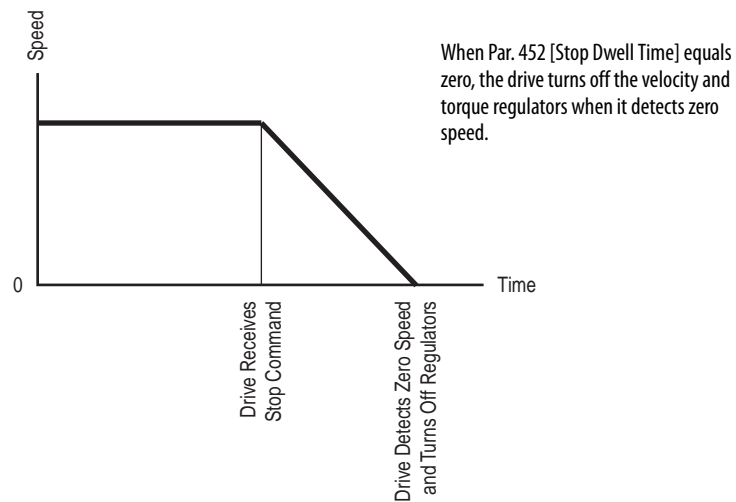

**Figure 24 - Drive Operation When Par. 452 [Stop Dwell Time] is Greater Than Zero**

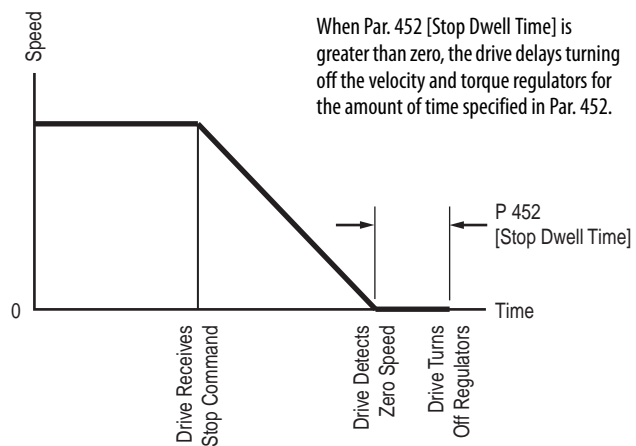

# Voltage Tolerance

Drive Rating	Nominal Line Voltage	Nominal Motor Voltage	Drive Full Power Range	Drive Operating Range
200...240	200	200*	200...264	180...264
	208	208	208...264	
	240	230	230...264	
380...480	380	380*	380...528	342...528
	400	400	400...528	
	480	460	460...528	
500...600 (Frames 0...4 Only)	600	575*	575...660	432...660
500...690 (Frames 5 & 6 Only)	600	575*	575...660	475...759
	690	690	690...759	475...759

Drive Full Power Range = Nominal Motor Voltage to Drive Rated Voltage +10%. Rated power is available across the entire Drive Full Power Range.

Drive Operating Range = Lowest (\*) Nominal Motor Voltage -10% to Drive Rated Voltage +10%. Drive Output is linearly derated when Actual Line Voltage is less than the Nominal Motor Voltage.

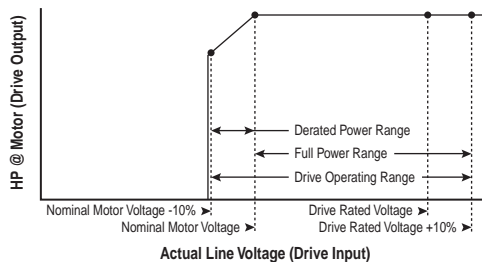

### EXAMPLE

Calculate the maximum power of a 5 Hp, 460V motor connected to a 480V rated drive supplied with 342V Actual Line Voltage input.

- Actual Line Voltage / Nominal Motor Voltage = 74.3%
- $74.3\% \times 5 \text{ Hp} = 3.7 \text{ Hp}$
- $74.3\% \times 60 \text{ Hz} = 44.6 \text{ Hz}$

At 342V Actual Line Voltage, the maximum power the 5 Hp, 460V motor can produce is 3.7 Hp at 44.6 Hz.

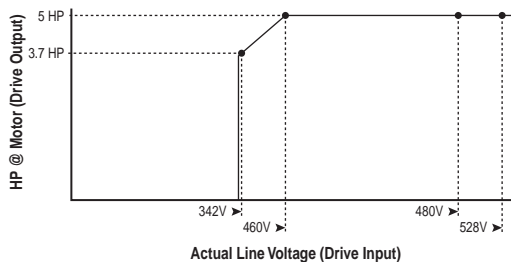

---

## Instructions for ATEX Approved Drives in Group II Category (2) G D Applications with ATEX Approved Motors

Topic	Page
Motor Requirements	148
Drive Wiring	148
Drive Configuration	149
Start-Up & Periodic Drive Testing Requirement	150

This document provides information on operation of an ATEX Approved drive and ATEX approved motor. The motor is located in a defined hazardous environment, while the drive is not. A protective system is required to stop current flow to the motor when an over temperature condition has been sensed in the motor. When sensed, the drive will go into a fault stop condition.

The drive is manufactured under the guidelines of the ATEX directive 94/9/EC. These Drives are in Group II Category (2) GD Applications with ATEX Approved Motors. Certification of the drive for the ATEX group and category on its nameplate requires installation, operation, and maintenance according to this document and to the requirements found in the User Manual and appropriate Motor Instruction Manual(s).



**ATTENTION:** Operation of this ATEX certified drive with an ATEX certified motor that is located in a hazardous environment requires additional installation, operation, and maintenance procedures beyond those stated in the standard user manual. Equipment damage and/or personal injury can result if all additional instructions in this document are not observed.

---

## Motor Requirements

- The motor must be manufactured under the guidelines of the ATEX directive 94/9/EC. It must be installed, operated, and maintained per the motor manufacturer supplied instructions.
- Only motors with nameplates marked for use on an inverter power source, and labeled for specific hazardous areas, can be used in hazardous areas on inverter (variable frequency) power.
- When the motor is indicated for ATEX Group II Category 2 for use in gas environments (Category 2G) the motor must be of flameproof construction, EEx d (according to EN50018) or Ex d (according to EN60079-1 or IEC60079-1). Group II motors are marked with a temperature or a temperature code.
- When the motor is indicated for ATEX Group II Category 2 for use in dust environments (Category 2D) the motor must be protected by an enclosure (according to EN50281-1-1 or according to IEC61241-1: Ex tD). Group II motors are marked with a temperature.
- The motor over temperature signal supplied to the drive must be a normally closed contact (open during over temperature condition) compatible with the drive’s digital (logic) input circuitry. If multiple sensors are required in the motor, the connection at the drive must be the resultant of all required contacts wired in series. Note that the drives are available with either 24V DC or 115V AC input circuitry.
- Refer to all product markings for additional cautions that can apply.
- Typical motor markings are contained on a motor certification nameplate similar to [Figure 25](#).

Figure 25 - Sample Motor Nameplate

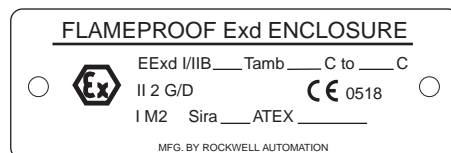

## Drive Wiring

**IMPORTANT** ATEX certification of this drive requires that 2 separate digital (logic) inputs be configured to monitor a normally closed over temperature contact (or multiple contacts wired in series) presented to the drive from the motor.

The first input must be “Digital Input6/Hardware Enable” (terminal 32). The second can be any other unused digital input between 1 and 5. Note that all inputs are typically supplied in a “default” configuration to a function such as Start and Stop. This can influence the input selected by the user for this function. The following examples will assume Digital Input 5 (terminal 31) is being used as the additional required input. The 2 input terminals must be wired in “parallel” (jumper is acceptable) so each is monitoring the over temperature contacts. Digital signal inputs are wired with respect to the digital input common. Refer to the Installation Instructions regarding setup for either internal or external 24V DC or external 115V AC logic power, depending on the type that is supplied in your drive. Motor supplied contacts must have ratings compatible with the drive’s input circuit ratings and applied voltage level.

**Figure 26 - Wiring Example**

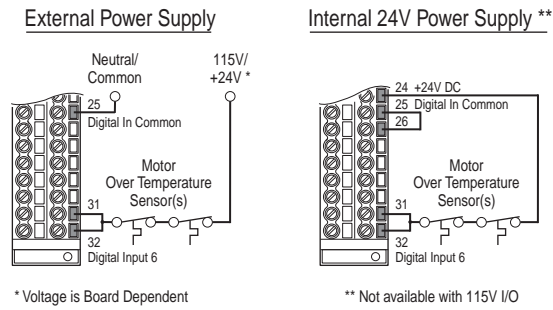

## Drive Configuration

Both of the digital inputs required to monitor for motor over temperature must be configured correctly to assure that the drive will shut down independent of drive software operation, and be put into a fault condition that will require a fault reset before the drive can be restarted.

## Hardware

Digital Input 6 must be configured as a Hardware Enable. This is accomplished by removing Jumper J10 from the Main Control Board in the I/O Control Cassette. Refer to the instructions in the I/O wiring section of the Installation Instructions.

## Firmware

- The functionality of Digital Input 5 is determined by parameter 365 [Digital In5 Sel]. (If a different digital input “x” is selected, refer to the corresponding [Digital In “x” Sel] parameter.) This parameter must be set to a value of “3” to configure this input as an “Aux Fault.” When this digital input is opened, the drive will immediately shut down in a fault condition and require a fault reset before the drive can be restarted.
- Opening Digital Input 6 when configured as a Hardware Enable will interrupt IGBT gate firing directly. Additionally, Digital Input 6 will put the drive into a normal “not-enabled” shutdown condition. It is configured by parameter 366 [Digital In6 Sel]. This parameter must be set to a value of “1” to configure this input as an “Enable.” When Digital Input 6 is opened, the gate firing will be interrupted and the drive will go into a “not-enabled” shutdown condition. Because the additional digital Input (typically Digital Input 5) must be wired to open simultaneously and be configured to put the drive into a fault condition, the drive will not restart if a new start command is given until the fault is reset.

## Start-Up & Periodic Drive Testing Requirement

The integrity of both the Hardware Enable input (Digital Input 6) and the additional Aux Fault input must be maintained and verified periodically to meet certification requirements. The interval must be determined by the requirements of the application, but not be greater than one year. In addition to any requirements to check the integrity of the over temperature device(s) and the wiring of the over temperature contact closure to the drive terminals, the drive circuitry itself requires testing. This must be done during a maintenance period when the motor environment is not hazardous and all necessary precautions have been taken to repeatedly start and stop the drive and motor safely.



**ATTENTION:** Power must be applied to the drive to perform the following procedure. Some of the voltages present are at incoming line potential. To avoid electric shock hazard or damage to equipment, only qualified service personnel should perform the following procedure. Thoroughly read and understand the procedure before beginning. If an event does not occur while performing this procedure, Do Not Proceed. Remove Power including user supplied control voltages. User supplied voltages can exist even when main AC power is not applied to then drive. Correct the malfunction before continuing.

### Preparation

1. Disconnect all power from the drive including control power, if supplied.
2. Disconnect the motor from the driven load if necessary, to run this test.
3. Disconnect the motor over temperature contact connections from the drive. This includes both Digital Input 6 (terminal 32) and the additional required input (typically Digital Input 5, terminal 31). Remove the jumper between the two inputs if one is in place.
4. Connect a means to open and close a N.C. contact between Digital Input 6 (terminal 32) and input common. Connect a separate means to open and close a N.C. contact between the additional input (typically Digital Input 5, terminal 31) and input common (see [Figure 27](#)). The switching devices (pushbutton, relay, etc.) must have contacts rated for either the 24V DC or 115V AC input circuit, whichever was supplied with the drive.

**Figure 27 - Example Test Circuit**

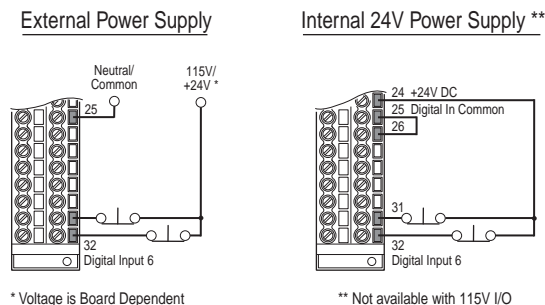

5. Be sure both sets of test contacts are closed. Assure all control connections are properly made to the drive. Reapply power to the drive including external control power, if supplied.

## Test

6. Perform any necessary parameter adjustments and start the drive. Confirm that the drive stops and starts normally, then start and slowly accelerate the motor.
7. Open Digital Input 6. The drive should stop and the motor coast to rest. The HIM/OIM should indicate that the drive is “Not Enabled.”
8. Close Digital Input 6. The drive should not start but the HIM/OIM should indicate that the drive is “Stopped.”

---

**IMPORTANT** The drive should not start when closing Digital Input 6 even if a maintained start command is present and had not been removed when the drive stopped.

---

9. Provide the command to restart the drive. In the case of a maintained start, remove and reapply the start command. In either case the drive should run normally.
10. With the motor running, open Digital Input 5. The drive should stop and the motor coast to rest. The HIM/OIM should indicate that the drive is in an “Auxiliary Input” fault condition.
11. Close Digital Input 5. The drive should not start and the HIM/OIM will continue to indicate an “Auxiliary Input” fault condition.
12. Provide the command to restart the drive. In the case of a maintained start, remove and reapply the start command. In either case the drive should remain stopped and in a fault condition.
13. Provide a Fault Reset command to the drive. The drive fault should clear. The drive should not start even if a maintained start is applied when the fault is reset.
14. Provide the command to restart the drive. In the case of a maintained start, remove and reapply the start command. In either case the drive should run normally.
15. Stop the drive, and disconnect all power from the drive including external control power.
16. Disconnect the test switching devices from the two digital inputs.
17. Determine a way to interrupt the continuity of the over temperature circuit when it is reconnected to the motor.
18. Properly reconnect the motor over temperature contact connection to the drive and include the test mechanism to interrupt the over temperature circuit’s continuity. This includes both Digital Input 6 (terminal 32) and the additional required digital input. Reconnect the jumper between the two inputs if one had been in place.
19. Reconnect power to the drive including external control power.
20. Start drive and confirm that it is operating properly.
21. Interrupt the continuity of the over temperature circuit connected to the drive. The drive should stop and the motor coast to rest. The HIM/OIM should indicate that the drive is in an Auxiliary Input fault condition.

22. Remake continuity of the over temperature circuit connected to the drive's digital inputs. The drive should remain stopped and in an Auxiliary Input fault condition.
23. Provide the command to restart the drive. In the case of a maintained start, remove and reapply the start command. The drive should remain stopped and in an Auxiliary Input fault condition.
24. Provide a fault reset command to the drive. The drive fault should clear but the drive should not restart.
25. Provide the command to restart the drive. The drive should run normally.
26. Stop the drive and disconnect all power including external control power.
27. Remove the test mechanism, reconnect original wires and verify all wiring.
28. Reconnect the motor to the load if it had been previously disconnected.
29. Check for proper operation.



## A

- Accel Mask** 56
- Accel Owner** 57
- Accel Time x** 38
- Adj Volt AccTime** 71
- Adj Volt Command** 70
- Adj Volt DecTime** 71
- Adj Volt Phase** 70
- Adj Volt Preset** 70
- Adj Volt Ref Hi** 70
- Adj Volt Ref Lo** 70
- Adj Volt S Curve** 71
- Adj Volt Select** 70
- Adj Volt Trim %** 71
- Adj Volt Trim Hi** 71
- Adj Volt Trim Lo** 71
- Adj Volt TrimSel** 70
- Adjust Voltage Group** 70
- Adjustable Voltage Operation** 109
- AdjVoltRef Cfct Alarm** 91
- Alarm & Fault Types** 83
- Alarm 1 @ Fault** 51
- Alarm 2 @ Fault** 51
- Alarm Clear** 53
- Alarm Config 1** 53
- Alarm Descriptions** 91
- Alarm x Code** 54
- Alarms**
  - AdjVoltRef Cfct 91
  - Analog In Loss 91
  - Bipolar Conflict 91
  - Brake Slipped 91
  - Brake Slipping 91
  - Decel Inhibit 91
  - Dig In Conflict 91
  - Drive OL Level 91
  - FluxAmpsRef Rang 91
  - Ground Warn 91
  - Home Not Set 92
  - In Phase Loss 92
  - IntDBRes OvrHeat 92
  - IR Volts Range 92
  - Ixo Vlt Rang 92
  - Load Loss 92
  - MaxFreq Conflict 92
  - Motor Thermistor 92
  - Motor Type Cfct 92
  - NP Hz Conflict 92
  - PI Config Conflict 92
  - Power Loss 92
  - Precharge Active 92
  - Prof Step Cfct 92
  - PTC Conflict 92
  - Sleep Config 92
  - Speed Ref Cfct 92
  - Start At PowerUp 93
  - TB Man Ref Cfct 93
  - Torq Prove Cfct 93
  - UnderVoltage 93
  - VHz Neg Slope 93
  - Waking 93
- Alarms Group** 53
- Alarms, Clearing** 90
- Analog In Loss Alarm** 91
- Analog In Loss Fault** 86
- Analog In x Hi** 60
- Analog In x Lo** 60
- Analog Inputs Group** 59
- Analog Inx Value** 21
- Analog Out Scale** 61
- Analog Out1 Hi** 61
- Analog Out1 Lo** 61
- Analog Out1 Sel** 61
- Analog Out2 Lo** 61
- Analog Out2 Sel** 61
- Analog Outputs Group** 60
- Anlg Cal Chksum Fault** 86
- Anlg In Config** 59
- Anlg In Loss** 60
- Anlg In Sqr Root** 59
- Anlg Out Absolut** 60
- Anlg Out Config** 60
- Anlg Out Setpt** 61
- Applications File** 67
- ATEX Approved Motors, Operation with** 147
- Auto Rstrt Delay** 41
- Auto Rstrt Tries** 41
- Auto Rstrt Tries Fault** 86
- Auto-Reset/Start** 83
- Autotune** 25
- AutoTune Aborted Fault** 86
- Autotune Torque** 26
- Auxiliary Input Fault** 86

## B

- Bipolar Conflict Alarm** 91
- Brake Slipped Alarm** 91
- Brake Slipping Alarm** 91
- Brake Test Torq** 68
- Brake, Dynamic** 40
- Break Frequency** 27
- Break Voltage** 27
- Brk Alarm Travel** 68
- Brk Release Time** 67
- Brk Set Time** 68
- BrkSlip Count** 68
- Bus Capacitors, Discharging** 11
- Bus Reg Kd** 40
- Bus Reg Ki** 39
- Bus Reg Kp** 40

**Bus Reg Mode A** 40

**Bus Reg Mode B** 40

## C

**Capacitors - Bus, Discharging** 11

**Catalog Number Explanation** 13

**Clear Fault Clr Owner** 57

**Clearing Alarms** 90

**Clearing Faults** 85

**Cntl Bd Overtemp Fault** 86

**Comm Control Group** 55

**Commanded Speed** 21

**Commanded Torque** 22

**Common Symptoms and Corrective Action** 94

**Communication File** 55

**Communications**

Logic Command Word 97

Logic Status Word 98

Programmable Controller Configurations 97

**Compensation** 24

**Control Options** 17

**Control Status** 27

**Control SW Ver** 22

**Copycat** 105

**Counts per Unit** 72

**Cross Reference, Parameter**

by Name 77

by Number 80

**Current Lmt Gain** 38

**Current Lmt Sel** 38

**Current Lmt Val** 38

**Current Rate Limit** 39

## D

**Data In Ax** 58

**Data Out Ax** 58

**Data, Saving** 105

**Datalinks Group** 58

**DB Resistance Fault** 86

**DB Resistor** 69

**DB Resistor Type** 40

**DB While Stopped** 39

**DC Brake Level** 39

**DC Brake Time** 39

**DC Brk Lvl Sel** 39

**DC Bus Memory** 21

**DC Bus Voltage** 21

**Decel Inhibit Fault** 86

**Decel Inhibit Alarm** 91

**Decel Mask** 56

**Decel Owner** 57

**Decel Time x** 38

**Defaults, Resetting to** 45, 105

**Diagnostic Data, Viewing** 105

**Diagnostics Group** 47

**Dig In Conflict Alarm** 91

**Dig In Status** 49

**Dig Out Invert** 66

**Dig Out Mask** 66

**Dig Out Param** 66

**Dig Out Setpt** 64

**Dig Out Status** 49

**Dig Outx Level** 65

**Dig Outx OffTime** 65

**Dig Outx OnTime** 65

**DigIn DataLogic** 64

**Digital Inputs Group** 63

**Digital Inx Sel** 63

**Digital Outputs Group** 63

**Digital Outx Sel** 65

**Direction Config Group** 44

**Direction Mask** 56

**Direction Mode** 44

**Direction Owner** 57

**Discrete Speeds Group** 32

**DPI Baud Rate** 55

**DPI Fdbk Select** 56

**DPI Loss Action** 44

**DPI Port 1-6 Fault** 88

**DPI Port Locations** 101

**DPI Port Sel** 55

**DPI Port Value** 55

**DPI Ref Select** 55

**Drive Alarm 1** 47

**Drive Alarm 2** 48

**Drive Checksum** 46

**Drive Data Group** 22

**Drive Frame Size** 10

**Drive Logic Rslt** 55

**Drive Memory Group** 45

**Drive OL Count** 49

**Drive OL Level Alarm** 91

**Drive OL Mode** 38

**Drive Overload Fault** 86

**Drive Powerup Fault** 86

**Drive Ramp Rslt** 55

**Drive Ref Rslt** 55

**Drive Status 1** 47

**Drive Status 2** 47

**Drive Status 3** 50

**Drive Temp** 49

**DriveExecutive** 15

**DriveExplorer** 15

**Droop RPM @ FLA** 38

**Dyn UserSet Actv** 46

**Dyn UsrSet Cnfg** 46

**Dyn UsrSet Sel** 46

**Dynamic Brake**

Resistor Selection 40

Setup 40  
**Dynamic Control File** 38

## E

**Editing Parameters** 15  
**Elapsed kWh** 21  
**Elapsed MWh** 21  
**Elapsed Run Time** 21  
**Enc Position Fdbk** 28  
**Encoder Loss Fault** 86  
**Encoder Pos Tol** 72  
**Encoder PPR** 28  
**Encoder Quad Err Fault** 86  
**Encoder Speed** 28  
**Encoder Z Chan** 28  
**ESD, Static Discharge** 11  
**Excessive Load Fault** 86  
**External Brake Resistor** 111

## F

**Factory Defaults, Resetting to** 45, 105  
**Fan/Pump Parameter Set** 45  
**Fatal Faults Fault** 86  
**Fault & Alarm Types** 83  
**Fault 1 Time** 53  
**Fault Amps** 50  
**Fault Bus Volts** 50  
**Fault Clear** 52  
**Fault Clear Mode** 52  
**Fault Clr Mask** 56  
**Fault Config x** 52  
**Fault Descriptions** 86  
**Fault Queue** 105  
**Fault Speed** 50  
**Fault x Code** 52  
**Faults**  
     Analog In Loss 86  
     Anlg Cal Chksum 86  
     Auto Rstrt Tries 86  
     AutoTune Aborted 86  
     Auxiliary Input 86  
     Cntl Bd Overtemp 86  
     DB Resistance 86  
     Decel Inhibit 86  
     DPI Port 1-6 88  
     Drive Overload 86  
     Drive Powerup 86  
     Encoder Loss 86  
     Encoder Quad Err 86  
     Excessive Load 86  
     Fatal Faults 86  
     Faults Cleared 86  
     Flt QueueCleared 86  
     FluxAmpsRef Rang 86  
     Ground Fault 87

Hardware Fault 87  
 Hardware PTC 87  
 Heatsink LowTemp 87  
 Heatsink OvrTemp 87  
 HW OverCurrent 87  
 I/O Comm Loss 87  
 I/O Failure 87  
 Incompat MCB-PB 87  
 Input Phase Loss 87  
 IR Volts Range 87  
 Ix0 VoltageRange 87  
 Load Loss 87  
 Motor Overload 87  
 Motor Thermistor 87  
 NVS I/O Checksum 87  
 NVS I/O Failure 87  
 Output PhaseLoss 88  
 OverSpeed Limit 88  
 OverVoltage 88  
 Parameter Chksum 88  
 Params Defaulted 88  
 Phase Short 88  
 Phase to Grnd 88  
 Port 1-6 DPI Loss 88  
 Power Loss 88  
 Power Unit 88  
 Pulse In Loss 88  
 Pwr Brd Chksum 88  
 Pwr Brd Chksum2 89  
 Replaced MCB-PB 89  
 See Manual 89  
 Shear Pin 89  
 Software 89  
 SW OverCurrent 89  
 TorqPrv Spd Band 89  
 Trmsistr OvrTemp 89  
 UnderVoltage 89  
 UserSet Chksum 89

**Faults Cleared Fault** 86

**Faults Group** 52

**Faults, Clearing** 85

**Fdbk Filter Sel** 28

**Feedback Select** 29

**FGP** 17

**File**

    Applications 67  
     Communication 55  
     Dynamic Control 38  
     Inputs & Outputs 59  
     Monitor 21  
     Motor Control 23  
     Pos/Spd Profile 72  
     Speed Command 29  
     Utility 44

**File-Group-Parameter** 17

**Find Home Ramp** 73

**Find Home Speed** 73

**Float Tolerance** 68

**Flt QueueCleared Fault** 86

**Flux Braking** 40  
**Flux Current** 21  
**Flux Current Ref** 25  
**Flux Up Mode** 25  
**Flux Up Time** 25  
**Flux Vector Control Option** 17  
**FluxAmpsRef Rang Alarm** 91  
**FluxAmpsRef Rang Fault** 86  
**Flying Start En** 41  
**Flying StartGain** 41  
**Frame Size, Drive** 10

## G

**Gearbox Limit** 70  
**Gearbox Rating** 69  
**Gearbox Ratio** 69  
**Gearbox Sheave** 69  
**General Precautions** 11  
**Gnd Warn Level** 43  
**Ground Fault** 87  
**Ground Warn Alarm** 91  
**Group**

- Adjust Voltage 70
- Alarms 53
- Analog Inputs 59
- Analog Outputs 60
- Comm Control 55
- Datalinks 58
- Diagnostics 47
- Digital Inputs 63
- Digital Outputs 63
- Direction Config 44
- Discrete Speeds 32
- Drive Data 22
- Drive Memory 45
- Faults 52
- HIM Ref Config 44
- Load Limits 38
- Masks & Owners 56
- Metering 21
- MOP Config 45
- Motor Data 23
- Power Loss 43
- Process PI 34
- Profile Step 73
- ProfSetup/Status 72
- Ramp Rates 38
- Restart Modes 41
- Scaled Blocks 54
- Slip Comp 34
- Spd Mode & Limits 29
- Speed Feedback 27
- Speed References 31
- Speed Regulator 37
- Speed Trim 33
- Stop/Brake Modes 39
- Torq Attributes 23

Torque Proving 67  
Volts per Hertz 27

## H

**Hand-Off-Auto (HOA)** 111  
**Hardware Fault** 87  
**Hardware PTC Fault** 87  
**Heatsink LowTemp Fault** 87  
**Heatsink OvrTemp Fault** 87  
**HighRes Ref** 58  
**HIM Menu Structure** 105  
**HIM Menus**

- Diagnostics 105
- Memory Storage 105
- Preferences 105

**HIM Ref Config Group** 44  
**HIM, Removing/Installing** 102  
**Home Not Set Alarm** 92  
**Home Position** 72  
**HW OverCurrent Fault** 87

## I

**I/O Comm Loss Fault** 87  
**I/O Failure Fault** 87  
**In Phase Loss Alarm** 92  
**Incompat MCB-PB Fault** 87  
**Inertia Autotune** 26  
**Input Phase Loss Fault** 87  
**Inputs & Outputs File** 59  
**IntDBRes OvrHeat Alarm** 92  
**IR Voltage Drop** 25  
**IR Volts Range Alarm** 92  
**IR Volts Range Fault** 87  
**Ixo Vit Rang Alarm** 92  
**Ixo Voltage Drop** 26  
**IXo VoltageRange Fault** 87

## J

**Jog Mask** 56  
**Jog Owner** 57  
**Jog Speed 1** 32  
**Jog Speed 2** 33

## K

**Kf Speed Loop** 37  
**Ki Speed Loop** 37  
**Kp Speed Loop** 37

## L

**Language** 46  
**Last Stop Source** 49

**LCD HIM Menus** 105  
**LEDs** 84  
**Lifting/Torque Proving** 111  
**Limit Switches** 118  
**Linear List** 17  
**Linking Parameters** 107  
**Load Frm Usr Set** 45  
**Load Limits Group** 38  
**Load Loss Alarm** 92  
**Load Loss Fault** 87  
**Load Loss Level** 43  
**Load Loss Time** 43  
**Local Mask** 57  
**Local Owner** 57  
**Logic Command Word** 97  
**Logic Mask** 56, 59  
**Logic Mask Act** 59  
**Logic Status Word** 98

## M

**Man Ref Preload** 44  
**Marker Pulse** 28  
**Masks & Owners Group** 56  
**Max Rod Speed** 69  
**Max Rod Torque** 69  
**MaxFreq Conflict Alarm** 92  
**Maximum Freq** 24  
**Maximum Speed** 29  
**Maximum Voltage** 24  
**Memory Retention, Motor Overload** 123  
**Menu Structure, HIM** 105  
**Metering Group** 21  
**MicroPos Scale%** 68  
**Min Adj Voltage** 70  
**Min Rod Speed** 69  
**Minimum Speed** 29, 119  
**MOD LED** 84  
**Monitor File** 21  
**MOP Adj VoltRate** 70  
**MOP Config Group** 45  
**MOP Mask** 57  
**MOP Owner** 57  
**MOP Rate** 45  
**MOP Reference** 21  
**Motor Cntl Sel** 24  
**Motor Control File** 23  
**Motor Control Technology** 120  
**Motor Data Group** 23  
**Motor DC Injection** 121  
**Motor Fdbk Type** 27  
**Motor NP FLA** 23  
**Motor NP Hertz** 23  
**Motor NP Power** 23  
**Motor NP RPM** 23

**Motor NP Volts** 23  
**Motor OL Count** 49  
**Motor OL Factor** 23  
**Motor OL Hertz** 23  
**Motor OL Mode** 23  
**Motor Overload** 122  
**Motor Overload Fault** 87  
**Motor Overload Memory Retention** 123  
**Motor Poles** 23  
**Motor Sheave** 69  
**Motor Thermistor Alarm** 92  
**Motor Thermistor Fault** 87  
**Motor Type** 23  
**Motor Type Cflct Alarm** 92  
**Mtr OL Trip Time** 49  
**Mtr Tor Cur Ref** 27

## N

**Neg Torque Limit** 27  
**NET LED** 84  
**Non-Resettable** 83  
**Notch Filter K** 28  
**Notch FilterFreq** 28  
**NP Hz Conflict Alarm** 92  
**NVS I/O Checksum Fault** 87  
**NVS I/O Failure Fault** 87

## O

**OilWell Pump Sel** 69  
**Operator Interface** 106  
**Output Current** 21  
**Output Freq** 21  
**Output PhaseLoss Fault** 88  
**Output Power** 21  
**Output Powr Fctr** 21  
**Output Voltage** 21  
**Overspeed** 123  
**Overspeed Limit** 29  
**OverSpeed Limit Fault** 88  
**OverVoltage Fault** 88

## P

**Param Access Lvl** 45  
**Parameter**  
     Changing/Editing 106  
     Descriptions 15  
     File-Group-Parameter Organization 17  
     Linear List 17  
     Viewing 106  
**Parameter Chksum Fault** 88  
**Parameter Cross Reference**  
     by Name 77  
     by Number 80

- Parameter Linking** 107
- Parameter View**
  - Advanced - Vector Control 19
  - Basic - Vector Control 18
- Parameters**
  - 32 Bit 16
  - Accel Mask 56
  - Accel Owner 57
  - Accel Time x 38
  - Adj Volt AccTime 71
  - Adj Volt Command 70
  - Adj Volt DecTime 71
  - Adj Volt Phase 70
  - Adj Volt Preset 70
  - Adj Volt Ref Hi 70
  - Adj Volt Ref Lo 70
  - Adj Volt S Curve 71
  - Adj Volt Select 70
  - Adj Volt Trim % 71
  - Adj Volt Trim Hi 71
  - Adj Volt Trim Lo 71
  - Adj Volt TrimSel 70
  - Alarm 1 @ Fault 51
  - Alarm 2 @ Fault 51
  - Alarm Clear 53
  - Alarm Config 1 53
  - Alarm x Code 54
  - Analog In x Hi 60
  - Analog In x Lo 60
  - Analog Inx Value 21
  - Analog Out Scale 61
  - Analog Out1 Hi 61
  - Analog Out1 Lo 61
  - Analog Out1 Sel 61
  - Analog Out2 Hi 61
  - Analog Out2 Lo 61
  - Analog Out2 Sel 61
  - Anlg In Config 59
  - Anlg In Loss 60
  - Anlg In Sqr Root 59
  - Anlg Out Absolut 60
  - Anlg Out Config 60
  - Anlg Out Setpt 61
  - Auto Rstrt Delay 41
  - Auto Rstrt Tries 41
  - Autotune 25
  - Autotune Torque 26
  - Brake Test Torq 68
  - Break Frequency 27
  - Break Voltage 27
  - Brk Alarm Travel 68
  - Brk Release Time 67
  - Brk Set Time 68
  - BrkSlip Count 68
  - Bus Reg Kd 40
  - Bus Reg Ki 39
  - Bus Reg Kp 40
  - Bus Reg Mode A 40
  - Bus Reg Mode B 40
  - Commanded Speed 21
  - Commanded Torque 22
  - Compensation 24
  - Control Status 27
  - Control SW Ver 22
  - Counts per Unit 72
  - Current Lmt Gain 38
  - Current Lmt Sel 38
  - Current Lmt Val 38
  - Current Rate Limit 39
  - Data In Ax 58
  - Data Out Ax 58
  - DB Resistor 69
  - DB Resistor Type 40
  - DB While Stopped 39
  - DC Brake Level 39
  - DC Brake Time 39
  - DC Brk Lev Sel 39
  - DC Bus Memory 21
  - DC Bus Voltage 21
  - Decel Mask 56
  - Decel Owner 57
  - Decel Time x 38
  - Dig In Status 49
  - Dig Out Invert 66
  - Dig Out Mask 66
  - Dig Out Param 66
  - Dig Out Setpt 64
  - Dig Out Status 49
  - Dig Outx Level 65
  - Dig Outx OffTime 65
  - Dig Outx OnTime 65
  - DigIn DataLogic 64
  - Digital Inx Sel 63
  - Digital Outx Sel 65
  - Direction Mask 56
  - Direction Mode 44
  - Direction Owner 57
  - DPI Baud Rate 55
  - DPI Fdbk Select 56
  - DPI Loss Action 44
  - DPI Port Sel 55
  - DPI Port Value 55
  - DPI Ref Select 55
  - Drive Alarm 1 47
  - Drive Alarm 2 48
  - Drive Checksum 46
  - Drive Logic Rslt 55
  - Drive OL Count 49
  - Drive OL Mode 38
  - Drive Ramp Rslt 55
  - Drive Ref Rslt 55
  - Drive Status 1 47
  - Drive Status 2 47
  - Drive Status 3 50
  - Drive Temp 49
  - Droop RPM @ FLA 38
  - Dyn UserSet Actv 46
  - Dyn UsrSet Cnfg 46
  - Dyn UsrSet Sel 46
  - Elapsed kWh 21

Elapsed MWh 21  
Elapsed Run Time 21  
Enc Position Fdbk 28  
Encoder Pos Tol 72  
Encoder PPR 28  
Encoder Speed 28  
Encoder Z Chan 28  
Fault 1 Time 53  
Fault Amps 50  
Fault Bus Volts 50  
Fault Clear 52  
Fault Clear Mode 52  
Fault Clr Mask 56  
Fault Clr Owner 57  
Fault Config x 52  
Fault Speed 50  
Fault x Code 52  
Fdbk Filter Sel 28  
Feedback Select 29  
Find Home Ramp 73  
Find Home Speed 73  
Float Tolerance 68  
Flux Braking 40  
Flux Current 21  
Flux Current Ref 25  
Flux Up Mode 25  
Flux Up Time 25  
Flying Start En 41  
Flying StartGain 41  
Gearbox Limit 70  
Gearbox Rating 69  
Gearbox Ratio 69  
Gearbox Sheave 69  
Gnd Warn Level 43  
HighRes Ref 58  
Home Position 72  
Inertia Autotune 26  
IR Voltage Drop 25  
Ixo Voltage Drop 26  
Jog Mask 56  
Jog Owner 57  
Jog Speed 1 32  
Jog Speed 2 33  
Kf Speed Loop 37  
Ki Speed Loop 37  
Kp Speed Loop 37  
Language 46  
Last Stop Source 49  
Load Frm Usr Set 45  
Load Loss Level 43  
Load Loss Time 43  
Local Mask 57  
Local Owner 57  
Logic Mask 56, 59  
Logic Mask Act 59  
Man Ref Preload 44  
Marker Pulse 28  
Max Rod Speed 69  
Max Rod Torque 69  
Maximum Freq 24  
Maximum Speed 29  
Maximum Voltage 24  
MicroPos Scale% 68  
Min Adj Voltage 70  
Min Rod Speed 69  
Minimum Speed 29  
MOP Adj VoltRate 70  
MOP Mask 57  
MOP Owner 57  
MOP Rate 45  
MOP Reference 21  
Motor Cntl Sel 24  
Motor Fdbk Type 27  
Motor NP FLA 23  
Motor NP Hertz 23  
Motor NP Power 23  
Motor NP RPM 23  
Motor NP Volts 23  
Motor OL Count 49  
Motor OL Factor 23  
Motor OL Hertz 23  
Motor OL Mode 23  
Motor Poles 23  
Motor Sheave 69  
Motor Type 23  
Mtr OL Trip Time 49  
Mtr Tor Cur Ref 27  
Neg Torque Limit 27  
Notch Filter K 28  
Notch FilterFreq 28  
OilWell Pump Sel 69  
Output Current 21  
Output Freq 21  
Output Power 21  
Output Powr Fctr 21  
Output Voltage 21  
Overspeed Limit 29  
Param Access Lvl 45  
PCP Pump Sheave 69  
PI BW Filter 36  
PI Configuration 34  
PI Control 34  
PI Deriv Time 36  
PI Error Meter 36  
PI Fdbk Meter 36  
PI Feedback Hi 36  
PI Feedback Lo 36  
PI Feedback Sel 35  
PI Integral Time 35  
PI Lower Limit 35  
PI Output Gain 36  
PI Output Meter 36  
PI Preload 36  
PI Prop Gain 35  
PI Ref Meter 36  
PI Reference Hi 36  
PI Reference Lo 36  
PI Reference Sel 35  
PI Setpoint 35  
PI Status 36

PI Upper Limit 36  
Pos Reg Filter 73  
Pos Reg Gain 73  
Pos Torque Limit 26  
Pos/Spd Prof Cmd 72  
Pos/Spd Prof Sts 72  
Power Loss Level 43  
Power Loss Mode 43  
Power Loss Time 43  
Powerup Delay 41  
PowerUp Marker 52  
Preset Speed x 32  
PTC HW Value 22  
Pulse In Scale 28  
Pulse Input Ref 32  
PWM Frequency 38  
Ramped Speed 22  
Rated Amps 22  
Rated kW 22  
Rated Volts 22  
Reference Mask 56  
Reference Owner 57  
Regen Power Limit 39  
Reset Meters 45  
Reset To Defaults 45  
Rev Speed Limit 30  
Rod Load Torque 68  
Run Boost 27  
S Curve % 38  
Save HIM Ref 44  
Save MOP Ref 45  
Save To User Set 45  
Scale In Hi 54  
Scale In Lo 54  
Scale In Value 54  
Scale Out Hi 54  
Scale Out Lo 54  
Scale Out Value 54  
Shear Pin Time 43  
Skip Freq Band 30  
Skip Frequency x 30  
Sleep Level 43  
Sleep Time 43  
Sleep-Wake Mode 42  
Sleep-Wake Ref 42  
Slip Comp Gain 34  
Slip RPM @ FLA 34  
Slip RPM Meter 34  
Spd Err Filt BW 37  
Spd Fdbk No Filt 22  
SpdBand Integrat 67  
Speed Desired BW 37  
Speed Dev Band 67  
Speed Feedback 22  
Speed Loop Meter 37  
Speed Ref A Hi 31  
Speed Ref A Lo 31  
Speed Ref A Sel 31  
Speed Ref B Hi 31  
Speed Ref B Lo 31  
Speed Ref B Sel 31  
Speed Ref Source 48  
Speed Reference 22  
Speed Units 29  
Speed/Torque Mod 30  
Start At PowerUp 41  
Start Inhibits 48  
Start Mask 56  
Start Owner 57  
Start/Acc Boost 27  
Status 1 @ Fault 50  
Status 2 @ Fault 50  
Status 3 @ Fault 50  
Step x AccelTime 74  
Step x Batch 76  
Step x DecelTime 74  
Step x Dwell 75  
Step x Next 76  
Step x Type 73  
Step x Value 75  
Step x Velocity 74  
Stop Dwell Time 40  
Stop Mode x 39  
Stop Owner 57  
SV Boost Filter 25  
TB Man Ref Hi 32  
TB Man Ref Lo 32  
TB Man Ref Sel 32  
Testpoint x Data 51  
Testpoint x Sel 51  
Torq Prove Sts 68  
Torq Ref A Div 26  
TorqAlarm Action 68  
TorqAlarm Dwell 69  
TorqAlarm Level 68  
TorqAlrm Timeout 69  
TorqAlrm TO Act 69  
TorqLim SlewRate 68  
TorqProve Cnfg 67  
TorqProve Setup 67  
Torque Current 21  
Torque Ref B Mult 26  
Torque Ref x Hi 26  
Torque Ref x Lo 26  
Torque Ref x Sel 26  
Torque Setpoint1 26  
Torque Setpoint2 27  
Total Gear Ratio 69  
Total Inertia 37  
Trim % Setpoint 33  
Trim Hi 33  
Trim In Select 33  
Trim Lo 33  
Trim Out Select 33  
Units Traveled 72  
Vel Override 72  
Voltage Class 46  
Wake Level 42  
Wake Time 42  
Write Mask Act 59



Write Mask Cfg 58  
 Zero SpdFloatTime 67  
**Params Defaulted Fault** 88  
**PCP Pump Sheave** 69  
**Phase Short Fault** 88  
**Phase to Grnd Fault** 88  
**PI BW Filter** 36  
**PI Config Conflict Alarm** 92  
**PI Configuration** 34  
**PI Control** 34  
**PI Deriv Time** 36  
**PI Error Meter** 36  
**PI Fdback Meter** 36  
**PI Feedback Hi** 36  
**PI Feedback Lo** 36  
**PI Feedback Sel** 35  
**PI Integral Time** 35  
**PI Lower Limit** 35  
**PI Output Gain** 36  
**PI Output Meter** 36  
**PI Preload** 36  
**PI Prop Gain** 35  
**PI Ref Meter** 36  
**PI Reference Hi** 36  
**PI Reference Lo** 36  
**PI Reference Sel** 35  
**PI Setpoint** 35  
**PI Status** 36  
**PI Upper Limit** 36  
**Port 1-6 DPI Loss Fault** 88  
**PORT LED** 84  
**Ports, DPI Type** 101  
**Pos Reg Filter** 73  
**Pos Reg Gain** 73  
**Pos Torque Limit** 26  
**Pos/Spd Prof Cmd** 72  
**Pos/Spd Prof Sts** 72  
**Pos/Spd Profile File** 72  
**Power Loss Alarm** 92  
**Power Loss Fault** 88  
**Power Loss Group** 43  
**Power Loss Level** 43  
**Power Loss Mode** 43  
**Power Loss Ride Through** 133  
**Power Loss Time** 43  
**Power Unit Fault** 88  
**Powerup Delay** 41  
**PowerUp Marker** 52  
**Precautions, General** 11  
**Precharge Active Alarm** 92  
**Preferences, Setting** 105  
**Preset Speed x** 32  
**Process PI Group** 34  
**Process PID** 134  
**Prof Step Cflct Alarm** 92

**Profile Step Group** 73  
**ProfSetup/Status Group** 72  
**Programmable Controller Configurations** 97  
**Programming** 15  
**PTC Conflict Alarm** 92  
**PTC HW Value** 22  
**Pulse In Loss Fault** 88  
**Pulse In Scale** 28  
**Pulse Input Ref** 32  
**PWM Frequency** 38  
**Pwr Brd Chksum Fault** 88  
**Pwr Brd Chksum2** 89  
**PWR LED** 84

## R

**Ramp Rates Group** 38  
**Ramped Speed** 22  
**Rated Amps** 22  
**Rated kW** 22  
**Rated Volts** 22  
**Reference Mask** 56  
**Reference Owner** 57  
**Regen Power Limit** 39  
**Replaced MCB-PB Fault** 89  
**Reset Meters** 45  
**Reset to Defaults** 45, 105  
**Restart Modes Group** 41  
**Rev Speed Limit** 30  
**Reverse Speed Limit** 136  
**Rod Load Torque** 68  
**Run Boost** 27

## S

**S Curve %** 38  
**Save HIM Ref** 44  
**Save MOP Ref** 45  
**Save To User Set** 45  
**Saving Data** 105  
**Scale In Hi** 54  
**Scale In Lo** 54  
**Scale In Value** 54  
**Scale Out Hi** 54  
**Scale Out Lo** 54  
**Scale Out Value** 54  
**Scaled Blocks Group** 54  
**See Manual Fault** 89  
**Setting Preferences** 105  
**Shear Pin Fault** 89  
**Shear Pin Time** 43  
**Skip Freq Band** 30  
**Skip Frequency** 137  
**Skip Frequency x** 30  
**Sleep Config Alarm** 92  
**Sleep Level** 43

**Sleep Time** 43  
**Sleep Wake Mode** 138  
**Sleep-Wake Mode** 42  
**Sleep-Wake Ref** 42  
**Slip Comp Gain** 34  
**Slip Comp Group** 34  
**Slip RPM @ FLA** 34  
**Slip RPM Meter** 34  
**Software Fault** 89  
**Spd Err Filt BW** 37  
**Spd Fdbk No Filt** 22  
**Spd Mode & Limits Group** 29  
**SpdBand Integrat** 67  
**Speed Command File** 29  
**Speed Desired BW** 37  
**Speed Dev Band** 67  
**Speed Feedback** 22  
**Speed Feedback Group** 27  
**Speed Loop Meter** 37  
**Speed Ref A Hi** 31  
**Speed Ref A Lo** 31  
**Speed Ref A Sel** 31  
**Speed Ref B Hi** 31  
**Speed Ref B Lo** 31  
**Speed Ref B Sel** 31  
**Speed Ref Cflct Alarm** 92  
**Speed Ref Source** 48  
**Speed Reference** 22  
**Speed References Group** 31  
**Speed Regulator Group** 37  
**Speed Trim Group** 33  
**Speed Units** 29  
**Speed/Torque Mod** 30  
**Standard Control Option** 17  
**Start At PowerUp** 41, 140  
**Start At PowerUp Alarm** 93  
**Start Inhibits** 48  
**Start Mask** 56  
**Start Owner** 57  
**Start/Acc Boost** 27  
**Static Discharge, ESD** 11  
**Status 1 @ Fault** 50  
**Status 2 @ Fault** 50  
**Status 3 @ Fault** 50  
**Status LEDs** 84  
**Step x AccelTime** 74  
**Step x Batch** 76  
**Step x DecelTime** 74  
**Step x Dwell** 75  
**Step x Next** 76  
**Step x Type** 73  
**Step x Value** 75  
**Step x Velocity** 74  
**Stop Dwell Time** 40  
**Stop Mode x** 39

**Stop Owner** 57  
**Stop/Brake Modes Group** 39  
**STS LED** 84  
**SV Boost Filter** 25  
**SW OverCurrent Fault** 89

## T

**TB Man Ref Cflct Alarm** 93  
**TB Man Ref Hi** 32  
**TB Man Ref Lo** 32  
**TB Man Ref Sel** 32  
**Testpoint Codes and Functions** 96  
**Testpoint x Data** 51  
**Testpoint x Sel** 51  
**Torq Attributes Group** 23  
**Torq Prove Cflct Alarm** 93  
**Torq Prove Sts** 68  
**Torq Ref A Div** 26  
**TorqAlarm Action** 68  
**TorqAlarm Dwell** 69  
**TorqAlarm Level** 68  
**TorqAlrm Timeout** 69  
**TorqAlrm TO Act** 69  
**TorqLim SlewRate** 68  
**TorqProve Cnfg** 67  
**TorqProve Setup** 67  
**TorqPrv Spd Band Fault** 89  
**Torque Current** 21  
**Torque Proving** 111  
**Torque Proving Group** 67  
**Torque Ref B Mult** 26  
**Torque Ref x Hi** 26  
**Torque Ref x Lo** 26  
**Torque Ref x Sel** 26  
**Torque Setpoint1** 26  
**Torque Setpoint2** 27  
**Total Gear Ratio** 69  
**Total Inertia** 37  
**Trim % Setpoint** 33  
**Trim Hi** 33  
**Trim In Select** 33  
**Trim Lo** 33  
**Trim Out Select** 33  
**Trnsistr OvrTemp Fault** 89  
**Troubleshooting** 83

## U

**UnderVoltage**  
 Alarm 93  
 Fault 89  
**Units Traveled** 72  
**User Configurable Alarm** 83  
**User Sets** 105  
**UserSet Chksum Fault** 89

**Utility File** 44

## **V**

**Vel Override** 72

**VHz Neg Slope Alarm** 93

**Viewing and Changing Parameters** 106

**Voltage Class** 46

**Voltage Tolerance** 146

**Volts per Hertz Group** 27

## **W**

**Wake Level** 42

**Wake Time** 42

**Waking Alarm** 93

**Web Sites, see WWW, World Wide Web**

**Write Mask Cfg** 58

**WWW, World Wide Web** 9

## **Z**

**Zero SpdFloatTime** 67





## Rockwell Automation Support

Rockwell Automation provides technical information on the Web to assist you in using its products.

At <http://www.rockwellautomation.com/support> you can find technical and application notes, sample code, and links to software service packs. You can also visit our Support Center at <https://rockwellautomation.custhelp.com/> for software updates, support chats and forums, technical information, FAQs, and to sign up for product notification updates.

In addition, we offer multiple support programs for installation, configuration, and troubleshooting. For more information, contact your local distributor or Rockwell Automation representative, or visit <http://www.rockwellautomation.com/services/online-phone>.

## Installation Assistance

If you experience a problem within the first 24 hours of installation, review the information that is contained in this manual. You can contact Customer Support for initial help in getting your product up and running.

United States or Canada	1.440.646.3434
Outside United States or Canada	Use the <a href="#">Worldwide Locator</a> at <a href="http://www.rockwellautomation.com/rockwellautomation/support/overview.page">http://www.rockwellautomation.com/rockwellautomation/support/overview.page</a> , or contact your local Rockwell Automation representative.

## New Product Satisfaction Return

Rockwell Automation tests all of its products to help ensure that they are fully operational when shipped from the manufacturing facility. However, if your product is not functioning and needs to be returned, follow these procedures.

United States	Contact your distributor. You must provide a Customer Support case number (call the phone number above to obtain one) to your distributor to complete the return process.
Outside United States	Please contact your local Rockwell Automation representative for the return procedure.

## Documentation Feedback

Your comments will help us serve your documentation needs better. If you have any suggestions on how to improve this document, complete this form, publication [RA-DU002](#), available at <http://www.rockwellautomation.com/literature/>.

Rockwell Automation maintains current product environmental information on its website at <http://www.rockwellautomation.com/rockwellautomation/about-us/sustainability-ethics/product-environmental-compliance.page>.

Rockwell Otomasyon Ticaret A.Ş., Kar Plaza İş Merkezi E Blok Kat:6 34752 İçerenköy, İstanbul, Tel: +90 (216) 5698400

**[www.rockwellautomation.com](http://www.rockwellautomation.com)**

### Power, Control and Information Solutions Headquarters

Americas: Rockwell Automation, 1201 South Second Street, Milwaukee, WI 53204-2496 USA, Tel: (1) 414.382.2000, Fax: (1) 414.382.4444  
Europe/Middle East/Africa: Rockwell Automation NV, Pegasus Park, De Kleetlaan 12a, 1831 Diegem, Belgium, Tel: (32) 2 663 0600, Fax: (32) 2 663 0640  
Asia Pacific: Rockwell Automation, Level 14, Core F, Cyberport 3, 100 Cyberport Road, Hong Kong, Tel: (852) 2887 4788, Fax: (852) 2508 1846

Publication 20B-UM002G-EN-P - July 2014

Supersedes Publication 20B-UM002F-EN-P - June 2013

Copyright © 2014 Rockwell Automation, Inc. All rights reserved. Printed in the U.S.A.