

# MicroLogix 1400 Programmable Controllers

Catalog Number(s) 1766-L32AWA, 1766-L32AWAA,  
1766-L32BWA, 1766-L32BWAA, 1766-L32BXB,  
1766-L32BXBA

<b>Topic</b>	<b>Page</b>
Important User Information	4
Additional Resources	7
Overview	8
Controller Description	9
Hazardous Location Considerations	11
Mount the Controller	13
Connect 1762 I/O Expansion Modules	18
Wire the Controller	19
Specifications	28

## Important User Information

Solid state equipment has operational characteristics differing from those of electromechanical equipment. Safety Guidelines for the Application, Installation and Maintenance of Solid State Controls (Publication SGI-1.1 available from your local Rockwell Automation sales office or online at

<http://literature.rockwellautomation.com>) describes some important differences between solid state equipment and hard-wired electromechanical devices. Because of this difference, and also because of the wide variety of uses for solid state equipment, all persons responsible for applying this equipment must satisfy themselves that each intended application of this equipment is acceptable.





In no event will Rockwell Automation, Inc. be responsible or liable for indirect or consequential damages resulting from the use or application of this equipment.

The examples and diagrams in this manual are included solely for illustrative purposes. Because of the many variables and requirements associated with any particular installation, Rockwell Automation, Inc. cannot assume responsibility or liability for actual use based on the examples and diagrams.

No patent liability is assumed by Rockwell Automation, Inc. with respect to use of information, circuits, equipment, or software described in this manual.

Reproduction of the contents of this manual, in whole or in part, without written permission of Rockwell Automation, Inc., is prohibited.

Throughout this manual, when necessary, we use notes to make you aware of safety considerations.

<p><b>WARNING</b></p> 	<p>Identifies information about practices or circumstances that can cause an explosion in a hazardous environment, which may lead to personal injury or death, property damage, or economic loss.</p>
<p><b>IMPORTANT</b></p>	<p>Identifies information that is critical for successful application and understanding of the product.</p>
<p><b>ATTENTION</b></p> 	<p>Identifies information about practices or circumstances that can lead to personal injury or death, property damage, or economic loss. Attentions help you identify a hazard, avoid a hazard and recognize the consequences.</p>
<p><b>SHOCK HAZARD</b></p> 	<p>Labels may be on or inside the equipment (for example, drive or motor) to alert people that dangerous voltage may be present.</p>
<p><b>BURN HAZARD</b></p> 	<p>Labels may be on or inside the equipment (for example, drive or motor) to alert people that surfaces may reach dangerous temperatures.</p>



---

## Environment and Enclosure

---

**ATTENTION**

This equipment is intended for use in a Pollution Degree 2 industrial environment, in overvoltage Category II applications (as defined in IEC publication 60664-1), at altitudes up to 2000 meters (6562 ft) without derating.

This equipment is considered Group 1, Class A industrial equipment according to IEC/CISPR Publication 11. Without appropriate precautions, there may be potential difficulties ensuring electromagnetic compatibility in other environments due to conducted as well as radiated disturbance.

This equipment is supplied as open-type equipment. It must be mounted within an enclosure that is suitably designed for those specific environmental conditions that will be present and appropriately designed to prevent personal injury resulting from accessibility to live parts. The enclosure must have suitable flame-retardant properties to prevent or minimize the spread of flame, complying with a flame spread rating of 5VA, V2, V1, V0 (or equivalent) if non-metallic. The interior of the enclosure must be accessible only by the use of a tool. Subsequent sections of this publication may contain additional information regarding specific enclosure type ratings that are required to comply with certain product safety certifications.

---

## Preventing Electrostatic Discharge

---



**ATTENTION**

This equipment is sensitive to electrostatic discharge, which can cause internal damage and affect normal operation. Follow these guidelines when you handle this equipment:

- Touch a grounded object to discharge potential static.
  - Wear an approved grounding wriststrap.
  - Do not touch connectors or pins on component boards.
  - Do not touch circuit components inside the equipment.
  - Use a static-safe workstation, if available.
  - Store the equipment in appropriate static-safe packaging when not in use.
-

## North American Hazardous Location Approval

The following modules are North American Hazardous Location approved: 1766-L32AWA, 1766-L32AWAA, 1766-L32BWA, 1766-L32BWAA, 1766-L32BWB, 1766-L32BWBAA, 1766-L32BWBBA, 1766-L32BWBBA

<p><b>The following information applies when operating this equipment in hazardous locations:</b></p>	<p><b>Informations sur l'utilisation de cet équipement en environnements dangereux:</b></p>	
<p>Products marked "CL I, DIV 2, GP A, B, C, D" are suitable for use in Class I Division 2 Groups A, B, C, D, Hazardous Locations and nonhazardous locations only. Each product is supplied with markings on the rating nameplate indicating the hazardous location temperature code. When combining products within a system, the most adverse temperature code (lowest "T" number) may be used to help determine the overall temperature code of the system. Combinations of equipment in your system are subject to investigation by the local Authority Having Jurisdiction at the time of installation.</p>	<p>Les produits marqués "CL I, DIV 2, GP A, B, C, D" ne conviennent qu'à une utilisation en environnements de Classe I Division 2 Groupes A, B, C, D dangereux et non dangereux. Chaque produit est livré avec des marquages sur sa plaque d'identification qui indiquent le code de température pour les environnements dangereux. Lorsque plusieurs produits sont combinés dans un système, le code de température le plus défavorable (code de température le plus faible) peut être utilisé pour déterminer le code de température global du système. Les combinaisons d'équipements dans le système sont sujettes à inspection par les autorités locales qualifiées au moment de l'installation.</p>	
<p><b>WARNING</b></p> 	<p><b>EXPLOSION HAZARD</b></p> <ul style="list-style-type: none"> <li>• Do not disconnect while the circuit is live or unless the area is known to be free of ignitable concentrations.</li> <li>• Do not disconnect connections to this equipment unless power has been removed or the area is known to be nonhazardous. Secure any external connections that mate to this equipment by using screws, sliding latches, threaded connectors, or other means provided with this product.</li> <li>• Substitution of components may impair suitability for Class I, Division 2.</li> <li>• Do not remove or replace lamps, fuses or plug-in modules (as applicable) unless power has been disconnected or the area is known to be free of ignitable concentrations of flammable gases or vapors.</li> </ul>	<p><b>AVERTISSEMENT</b></p>  <p><b>RISQUE D'EXPLOSION</b></p> <ul style="list-style-type: none"> <li>• Couper le courant ou s'assurer que l'environnement est classé non dangereux avant de débrancher l'équipement.</li> <li>• Couper le courant ou s'assurer que l'environnement est classé non dangereux avant de débrancher les connecteurs. Fixer tous les connecteurs externes reliés à cet équipement à l'aide de vis, loquets coulissants, connecteurs filetés ou autres moyens fournis avec ce produit.</li> <li>• La substitution de composants peut rendre cet équipement inadapté à une utilisation en environnement de Classe I, Division 2.</li> <li>• S'assurer que l'environnement est classé non dangereux avant de changer les piles.</li> </ul>

## Additional Resources

Resource	Description
MicroLogix 1400 Programmable Controllers User Manual <a href="#">1766-UM001</a>	A more detailed description of how to install and use your MicroLogix 1400 programmable controller and expansion I/O system.
MicroLogix 1400 Instruction Set Reference Manual <a href="#">1766-RM001</a>	A reference manual that contains data and function files, instruction set, and troubleshooting information for MicroLogix 1400.
Installation Instructions 1762-INxxx	Information on installing and using 1762 expansion I/O modules.
Industrial Automation Wiring and Grounding Guidelines <a href="#">1770-4.1</a>	More information on proper wiring and grounding techniques.

If you would like a manual, you can:

- download a free electronic version from the internet:  
<http://literature.rockwellautomation.com>
- purchase a printed manual by contacting your local Allen-Bradley distributor or Rockwell Automation representative

## Overview

MicroLogix 1400 controllers are suitable for use in an industrial environment when installed in accordance with these instructions. Specifically, this equipment is intended for use in clean, dry environments (Pollution degree 2<sup>(1)</sup>) and with circuits not exceeding Over Voltage Category II<sup>(2)</sup> (IEC 60664-1)<sup>(3)</sup>. AC powered products must be connected to the secondary of an isolating transformer.

Install your controller using these installation instructions.

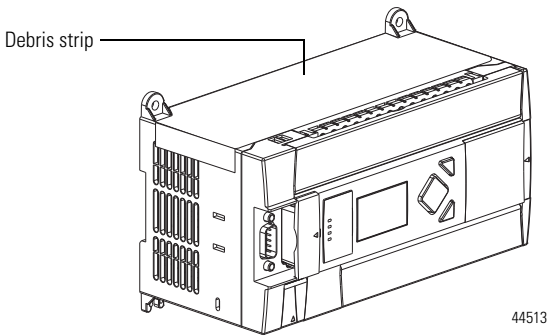

---

### ATTENTION



Do not remove the protective debris strip until after the controller and all other equipment in the panel near the controller are mounted and wiring is complete. Once wiring is complete, remove protective debris strip. Failure to remove strip before operating can cause overheating.

---

---

### ATTENTION



Electrostatic discharge can damage semiconductor devices inside the controller. Do not touch the connector pins or other sensitive areas.

---

<sup>(1)</sup> Pollution Degree 2 is an environment where, normally, only non-conductive pollution occurs except that occasionally a temporary conductivity caused by condensation shall be expected.

<sup>(2)</sup> Over Voltage Category II is the load level section of the electrical distribution system. At this level transient voltages are controlled and do not exceed the impulse voltage capability of the product's insulation.

<sup>(3)</sup> Pollution Degree 2 and Over Voltage Category II are International Electrotechnical commissions (IEC) designations.

## Controller Description

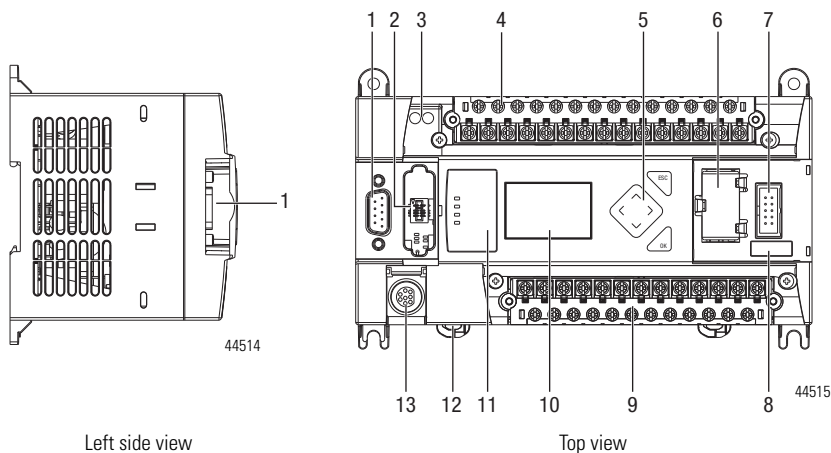

Left side view

Top view

	Description
1	Comm port 2 - 9-pin D-Shell RS-232C connector
2	Memory module (refer to MicroLogix 1400 Memory Module Installation Instructions, publication <a href="#">1766-IN010</a> for instructions on installing the memory module).
3	User 24V (for 1766-L32BWA and 1766-L32BWAA only)
4	Input terminal block
5	LCD Display Keypad (ESC, OK, Up, Down, Left, Right)
6	Battery compartment
7	1762 expansion bus connector
8	Battery connector
9	Output terminal block
10	LCD Display
11	Indicator LED panel
12	Comm port 1 - RJ45 connector
13	Comm port 0 - 8-pin mini DIN RS-232C/RS-485 connector

### Controller Input and Output Description

Catalog Number	Description				
	Input Power	User Power	Embedded Discrete I/O	Embedded Analog I/O	Comm. Ports
1766-L32BWA	100/240V AC	24V DC	12 Fast 24V DC Inputs 8 Normal 24V DC Inputs 12 Relay Outputs	None	1 RS232/RS485 <sup>(1)</sup> 1 Ethernet/IP 1 RS232 <sup>(2)</sup>
1766-L32AWA		None	20 120V AC Inputs 12 Relay Outputs		
1766-L32BXB	24 V DC		12 Fast 24V DC Inputs 8 Normal 24V DC Inputs 6 Relay Outputs 3 Fast DC Outputs 3 Normal DC Outputs		
1766-L32BWAA	100/240V AC	24V DC	12 Fast 24V DC Inputs 8 Normal 24V DC Inputs 12 Relay Outputs	4 Voltage Inputs 2 Voltage Outputs	
1766-L32AWAA		None	20 120V AC Inputs 12 Relay Outputs		
1766-L32BXBA	24V DC		12 Fast 24V DC Inputs 8 Normal 24V DC Inputs 6 Relay Outputs 3 Fast DC Outputs 3 Normal DC Outputs		

<sup>(1)</sup> Isolated RS-232/RS-485 combo port. Same as ML1100 Comm 0

<sup>(2)</sup> Non-isolated RS-232. Standard D-sub connector





## Hazardous Location Considerations

This equipment is suitable for use in Class I, Division 2, Groups A, B, C, D or non-hazardous locations only. The following WARNING statement applies to use in hazardous locations.

### WARNING



### EXPLOSION HAZARD

- Substitution of components may impair suitability for Class I, Division 2.
- Do not replace components or disconnect equipment unless power has been switched off.
- Do not connect or disconnect components unless power has been switched off.
- This product must be installed in an enclosure. All cables connected to the product must remain in the enclosure or be protected by conduit or other means.
- All wiring must comply with N.E.C. article 501-10(b) and/or in accordance with Section 18-1J2 of the Canadian Electrical Code, and in accordance with the authority having jurisdiction.

Use only the following communication cables in Class I, Division 2 hazardous locations.

Environment Classification	Communication Cables
Class I, Division 2 Hazardous Environment	1761-CBL-AC00 Series C or later
	1761-CBL-AM00 Series C or later
	1761-CBL-AP00 Series C or later
	1761-CBL-PM02 Series C or later
	1761-CBL-HM02 Series C or later
	2707-NC9 Series C or later
	1763-NC01 Series A or later
	1747-CP3 Series

## Environnements dangereux

Cet équipement est conçu pour une utilisation en environnements dangereux de Classe I, Division 2, Groupes A, B, C, D ou non dangereux. La mise en garde suivante s'applique à utilisation en environnements dangereux.

### WARNING



### DANGER D'EXPLOSION

- La substitution de composants peut rendre cet équipement impropre à une utilisation en environnement de Classe I, Division 2.
- Ne pas remplacer de composants ou déconnecter l'équipement sans s'être assuré que l'alimentation est coupée.
- Ne pas connecter ou déconnecter des composants sans s'être assuré que l'alimentation est coupée.
- Ce produit doit être installé dans une armoire. Tous les câbles connectés à l'appareil doivent rester dans l'armoire ou être protégés par une goulotte ou tout autre moyen.
- L'ensemble du câblage doit être conforme à la réglementation en vigueur dans les pays où l'appareil est installé.

Utilisez uniquement les câbles de communication suivants dans les environnements dangereux de Classe I, Division 2.

Classification des environnements	Câbles de communication
Environnement dangereux de Classe I, Division 2	1761-CBL-AC00 série C ou ultérieure
	1761-CBL-AM00 série C ou ultérieure
	1761-CBL-AP00 série C ou ultérieure
	1761-CBL-PM02 série C ou ultérieure
	1761-CBL-HM02 série C ou ultérieure
	2707-NC9 série C ou ultérieure
	1763-NC01 série A ou ultérieure
	série 1747-CP3

### ATTENTION



### UNSUPPORTED CONNECTION

Do not connect the Comm0 port on the MicroLogix 1400 controller to another MicroLogix family controller such as MicroLogix 1000, MicroLogix 1200, or MicroLogix 1500 using a 1761-CBL-AM00 (8-pin mini-DIN to 8-pin mini-DIN) cable or equivalent.

This type of connection will cause damage to the RS-232/485 communication port (Channel 0) of the MicroLogix 1400 and/or the controller itself. Communication pins used for RS-485 communications are alternately used for 24V power on the other MicroLogix controllers.

## Mount the Controller

### General Considerations

Most applications require installation in an industrial enclosure to reduce the effects of electrical interference and environmental exposure. Locate your controller as far as possible from power lines, load lines, and other sources of electrical noise such as hard-contact switches, relays, and ac motor drives. For more information on proper grounding guidelines, see the Industrial Automation Wiring and Grounding Guidelines, publication [1770-4.1](#).

#### ATTENTION



Mount the controller horizontally only. Vertical mounting is not supported due to thermal considerations.

#### ATTENTION



Be careful of metal chips when drilling mounting holes for your controller or other equipment within the enclosure or panel. Drilled fragments that fall into the controller could cause damage. Do not drill holes above a mounted controller if the protective debris strips have been removed.

#### WARNING



Do not place the MicroLogix 1400 Programmable Controller in direct sunlight. Prolonged exposure to direct sunlight could degrade the LCD display.

#### WARNING



The local programming terminal port is intended for temporary use only and must not be connected or disconnected unless the area is assured to be nonhazardous.

## Mounting Dimensions

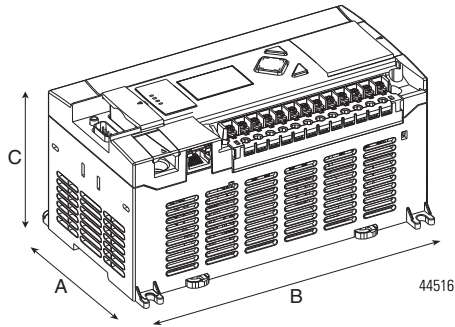

1766-L32BWA, 1766-L32AWA, 1766-L32BXB,  
1766-L32BWAA, 1766-L32AWAA, 1766-L32BXBA

Dimension	Height
A	90 mm (3.5 in.)
B	180 mm (7.087 in.)
C	87 mm (3.43 in.)

## Controller Spacing

The controller mounts horizontally, with the expansion I/O extending to the right of the controller. Allow 50 mm (2 in.) of space on all but the right side for adequate ventilation, as shown below.

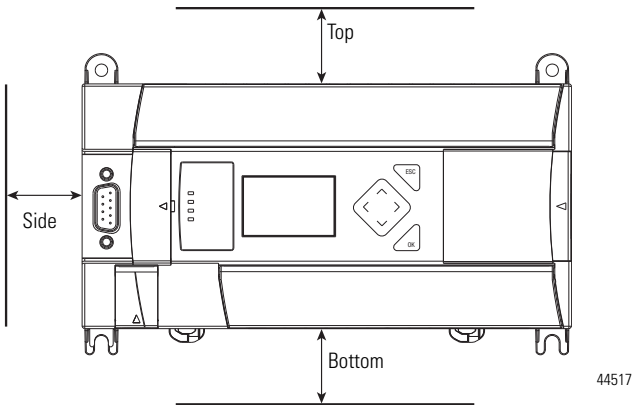

## DIN Rail Mounting

The maximum extension of the latch is 14 mm (0.55 in.) in the open position. A flat-blade screwdriver is required for removal of the controller. The controller can be mounted to EN50022-35x7.5 or EN50022-35x15 DIN rails. DIN rail mounting dimensions are shown below.

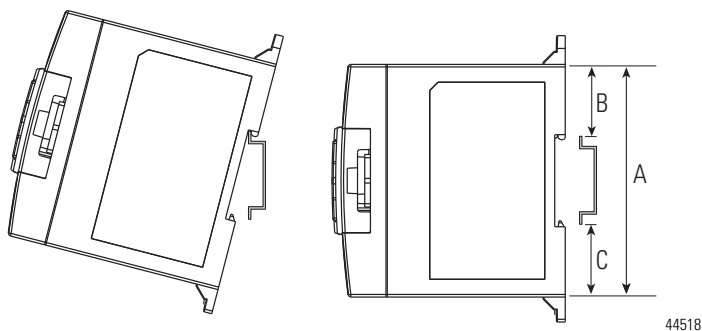

Dimension	Height
A	90 mm (3.5 in.)
B	27.5 mm (1.08 in.)
C	27.5 mm (1.08 in.)

Follow these steps to install your controller on the DIN rail.

1. Mount your DIN rail. Make sure that the placement of the controller on the DIN rail meets the recommended spacing requirements (see Controller Spacing on page 14 for more information). Refer to the mounting template inside the back cover of this document.
2. If it is open, close the DIN latch.
3. Hook the top slot over the DIN rail.
4. While pressing the controller down against the top of the rail, snap the bottom of the controller into position.
5. Leave the protective debris strip attached until you are finished wiring the controller and any other devices.

Follow these steps to remove your controller from the DIN rail.

1. Place a flat-blade screwdriver in the DIN rail latch at the bottom of the controller.

2. Holding the controller, pry downward on the latch until the latch locks in the open position.
3. Repeat steps 1 and 2 for the second DIN rail latch.
4. Unhook the top of the DIN rail slot from the rail.

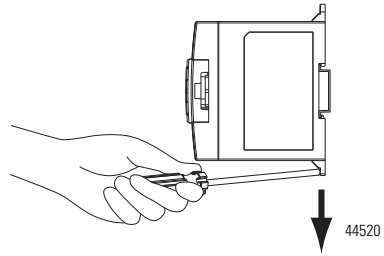
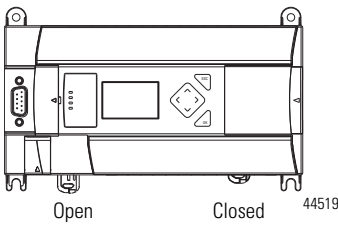

## Panel Mounting

Mount to panel using #8 or M4 screws. Follow these steps to install your controller using mounting screws.

1. Remove the mounting template from inside the back cover of this document.
2. Secure the template to the mounting surface. Make sure your controller is spaced properly (see Controller Spacing on page 14 for more information).
3. Drill holes through the template.
4. Remove the mounting template.
5. Mount the controller.
6. Leave the protective debris strip in place until you are finished wiring the controller and any other devices

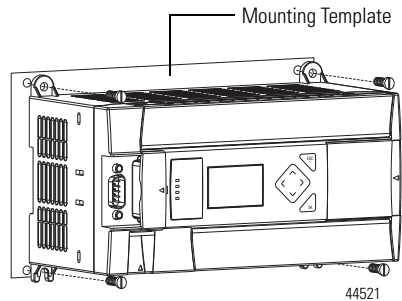

## Using the Battery

The MicroLogix 1400 controller is equipped with a replaceable battery (catalog number 1747-BA). The Battery Low indicator on the LCD display of the controller shows the status of the replaceable battery. When the battery is low, the indicator is set (displayed as a solid rectangle). This means that either the battery wire connector is disconnected, or the battery may fail within 2 days if it is connected.

### IMPORTANT

The MicroLogix 1400 controller ships with the battery wire connector connected. Ensure that the battery wire connector is inserted into the connector port if your application needs battery power. For example, when using a real-time clock (RTC).

Replacing the battery when the controller is powered down will lose all user application memory. Replace the battery when the controller is powered on. Refer to the SLC 500 Lithium Battery Installation Instructions, publication [1747-IN515](#), for more information on installation, handling, usage, storage, and disposal of the battery.

### WARNING



When you connect or disconnect the battery an electrical arc can occur. This could cause an explosion in hazardous location installations. Be sure that the area is nonhazardous before proceeding.

For Safety information on the handling of lithium batteries, including handling and disposal of leaking batteries, see Guidelines for Handling Lithium Batteries, publication [AG 5-4](#).

Follow these steps to connect the replaceable battery.

1. Insert the replaceable battery wire connector into the controller's battery connector.

2. Secure the battery connector wires so that it does not block the 1762 expansion bus connector as shown below.

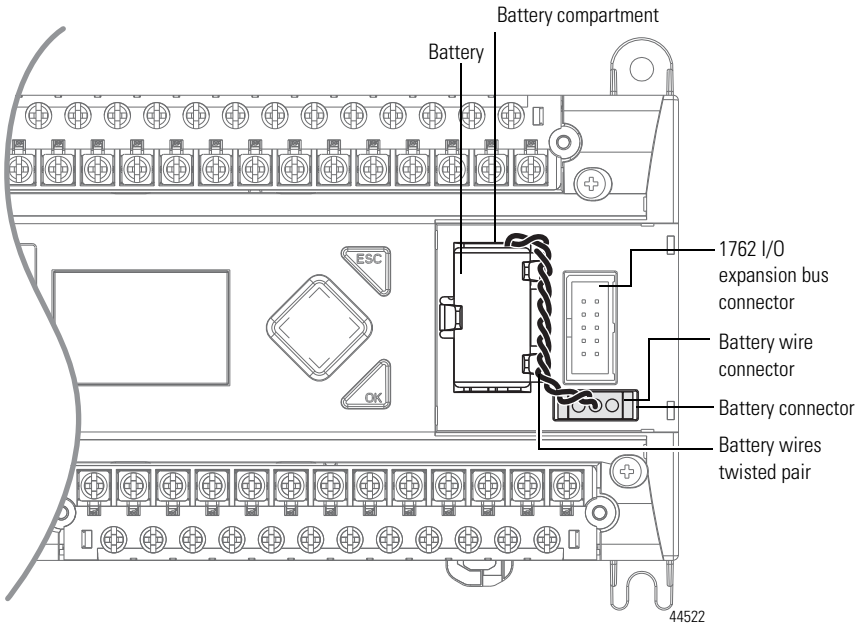

## Connect 1762 I/O Expansion Modules

### ATTENTION



Remove power from the system before installing or removing expansion I/O or damage to the controller may result.

Connect 1762 I/O after mounting the controller.

1. Remove the expansion port cover to install expansion I/O modules.
2. Plug the ribbon cable connector into the bus connector.



3. Replace the cover as shown below.

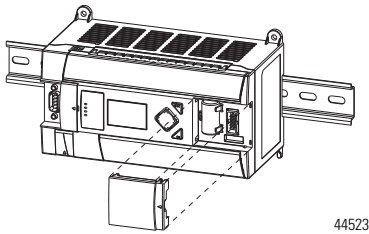

The MicroLogix 1400 controller is designed to support up to any seven 1762 expansion I/O modules.

For detailed information on using expansion I/O, refer to the installation instructions for your expansion module.

## Wire the Controller

The shading in the following terminal block illustrations indicates which terminal groups are tied to which commons.

## Terminal Block Layouts

### WARNING



When you connect or disconnect the Removable Terminal Block (RTB) with field side power applied, an electrical arc can occur. This could cause an explosion in hazardous location installations. Be sure that power is removed or the area is nonhazardous before proceeding.

### WARNING



When used in a Class I, Division 2, hazardous location, this equipment must be mounted in a suitable enclosure. All wiring must be in accordance with Class I, Division 2 wiring methods of Article 501 of the National Electrical Code and/or in accordance with Section 18-1J2 of the Canadian Electrical Code, and in accordance with the authority having jurisdiction.

**1766-L32BWA/L32BWAA**

Input Terminal Block

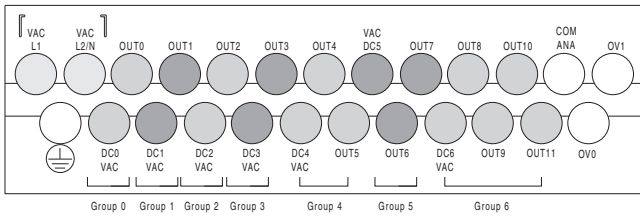
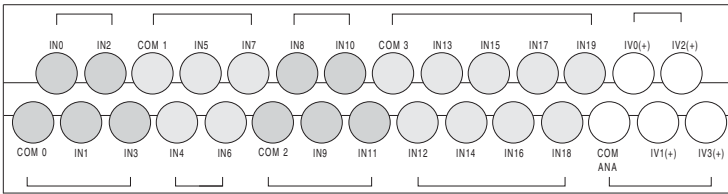

Output Terminal Block

44524

**1766-L32AWA/L32AWAA**

Input Terminal Block

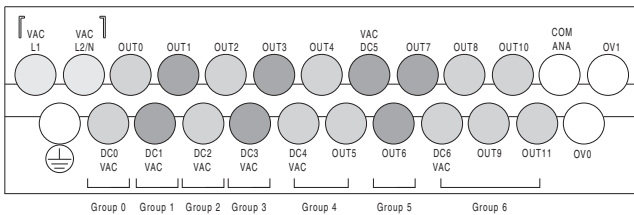
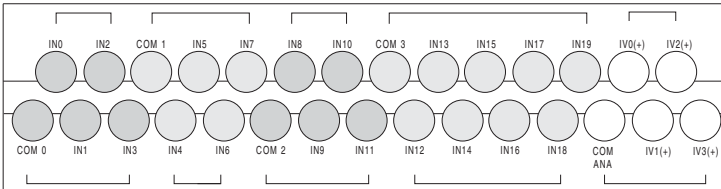

Output Terminal Block

44525

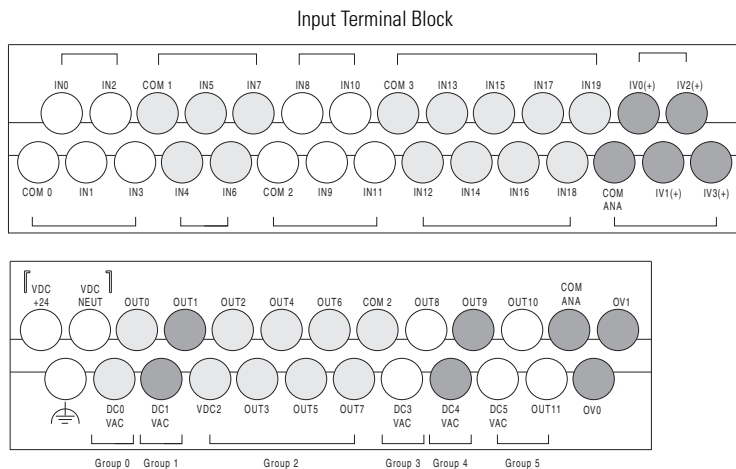
**1766-L32BXB/L32BXBA**

44526

Wire Type		Wire Size
Solid wire	Cu-90°C (194°F)	14...22 AWG
Stranded wire	Cu-90°C (194°F)	16...22 AWG

Wiring torque = 0.791Nm (7 in-lb) rated.

**Output Terminal Grouping**

Controller	Output Group	Description	Outputs Voltage Terminal	Output Terminal
1766-L32BWA 1766--L32BWAA	Group 0	Isolated relay output	VAC/DC0	OUT 0
	Group 1	Isolated relay output	VAC/DC1	OUT 1
	Group 2	Isolated relay output	VAC/DC2	OUT 2
	Group 3	Isolated relay output	VAC/DC3	OUT 3
	Group 4	Isolated relay output	VAC/DC4	OUT 4, OUT 5
	Group 5	Isolated relay output	VAC/DC5	OUT 6, OUT 7
	Group 6	Isolated relay output	VAC/DC6	OUT 8...11

**Output Terminal Grouping**

<b>Controller</b>	<b>Output Group</b>	<b>Description</b>	<b>Outputs Voltage Terminal</b>	<b>Output Terminal</b>
1766-L32AWA 1766-L32AWAA	Group 0	Isolated relay output	VAC/DC0	OUT 0
	Group 1	Isolated relay output	VAC/DC1	OUT 1
	Group 2	Isolated relay output	VAC/DC2	OUT 2
	Group 3	Isolated relay output	VAC/DC3	OUT 3
	Group 4	Isolated relay output	VAC/DC4	OUT 4, OUT 5
	Group 5	Isolated relay output	VAC/DC5	OUT 6, OUT 7
	Group 6	Isolated relay output	VAC/DC6	OUT 8...11
1766-L32BXB 1766-L32BXBAA	Group 0	Isolated relay output	VAC/DC0	OUT 0
	Group 1	Isolated relay output	VAC/DC1	OUT 1
	Group 2	FET output	VDC2/COM 2	OUT 2...7
	Group 3	Isolated relay output	VAC/DC3	OUT 8
	Group 4	Isolated relay output	VAC/DC4	OUT 9
	Group 5	Isolated relay output	VAC/DC5	OUT 10, OUT 11

**WARNING**



If you connect or disconnect wiring while the field-side power is on, an electrical arc can occur. This could cause an explosion in hazardous location installations. Be sure that power is removed or the area is nonhazardous before proceeding

**WARNING**



The local programming terminal port is intended for temporary use only and must not be connected or disconnected unless the area is free of ignitable concentrations of flammable gases or vapors.



## Wiring Recommendation

When wiring without spade lugs, keep the finger-safe covers in place. Loosen the terminal screw and route the wires through the opening in the finger-safe cover. Tighten the terminal screw, making sure the pressure plate secures the wire.

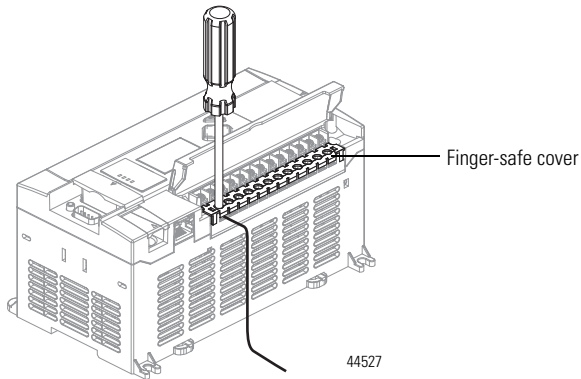

### ATTENTION



Be careful when stripping wires. Wire fragments that fall into the controller could cause damage. Once wiring is complete, be sure the controller is free of all metal fragments before removing the protective debris strip. Failure to remove the strip before operating can cause overheating.

## Spade Lug Recommendation

The diameter of the terminal screw head is 5.5 mm (0.220 in.). The input and output terminals of the MicroLogix 1400 controller are designed for the following spade lugs. The terminals will accept a 6.35mm (0.25 in.) wide spade (standard for #6 screw for up to 14 AWG) or a 4 mm (metric #4) fork terminal.

When using spade lugs, use a small, flat-blade screwdriver to pry the finger-safe cover from the terminal blocks, then loosen the terminal screw.

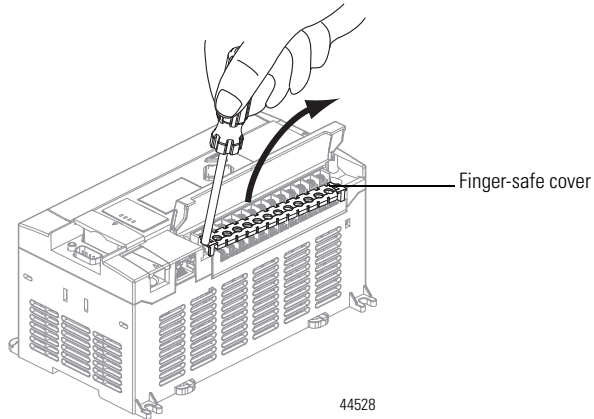

### TIP

If you wire the terminal block with the finger-safe cover removed, you may not be able to put it back on the terminal block if the wires are in the way.

## Surge Suppression

---

### ATTENTION



Inductive load devices such as motor starters and solenoids require the use of some type of surge suppression to protect the controller output. Switching inductive loads without surge suppression can significantly reduce the life of relay contacts or damage transistor outputs. By using suppression, you also reduce the effects of voltage transients caused by interrupting the current to that inductive device, and prevent electrical noise from radiating into system wiring. Refer to the MicroLogix 1400 Programmable Controller User Manual, publication [1766-UM001](#), for more information on surge suppression.

---

## Grounding the Controller

In solid-state control systems, grounding and wire routing helps limit the effects of noise due to electromagnetic interference (EMI). Run the ground connection from the ground screw of the controller to the ground bus prior to connecting any devices. Use AWG #14 wire. For AC-powered controllers, this connection must be made for safety purposes.

You must also provide an acceptable grounding path for each device in your application. For more information on proper grounding guidelines, refer to the Industrial Automation Wiring and Grounding Guidelines, publication [1770-4.1](#).

## Wiring Your Analog Channels

Analog input circuits can monitor voltage signals and convert them to serial digital data as shown in the following illustration.

### Analog Input

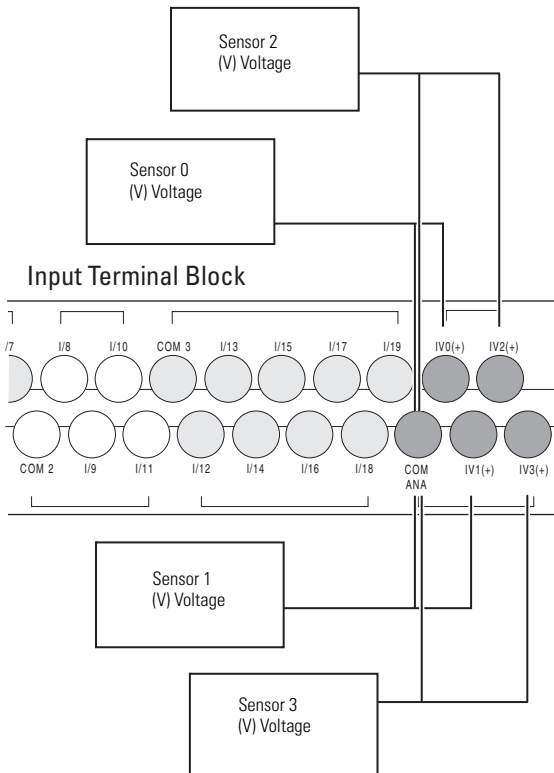

44529

The controller does not provide loop power for analog inputs. Use a power supply that matches the transmitter specifications as shown.

The analog output can support a voltage function as shown in the following illustration.

### Analog Output

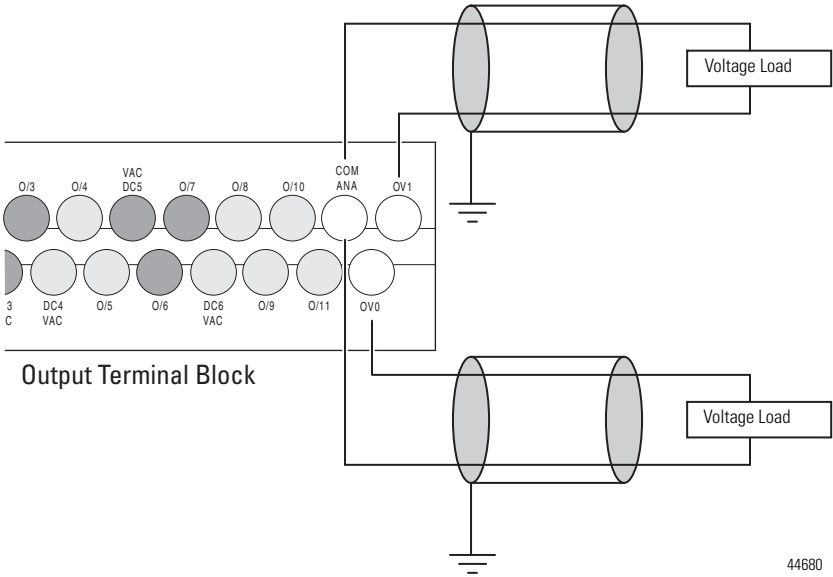

44680

### Analog Input Transmitter Specifications

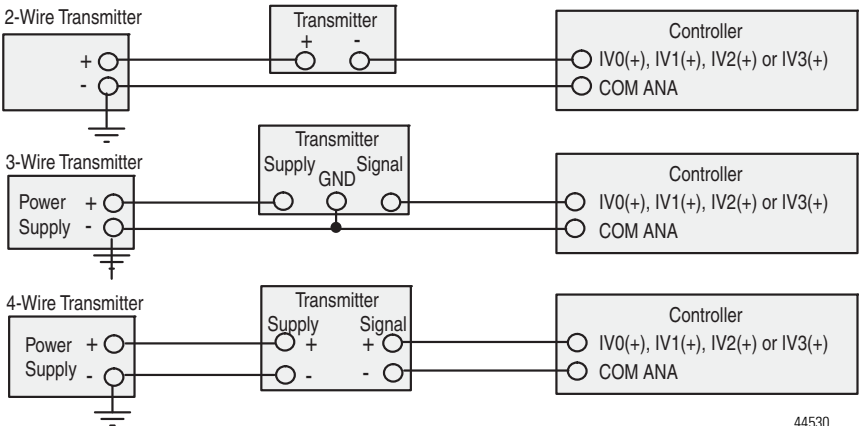

44530



## Minimizing Electrical Noise on Analog Channels

Inputs on analog channels employ digital high-frequency filters that significantly reduce the effects of electrical noise on input signals. However, because of the variety of applications and environments where analog controllers are installed and operated, it is impossible to ensure that all environmental noise will be removed by the input filters.

Several specific steps can be taken to help reduce the effects of environmental noise on analog signals:

- Install the MicroLogix 1400 system in a properly rated (NEMA) enclosure. Make sure that the MicroLogix 1400 system is properly grounded.
- Use Belden cable #8761 for wiring the analog channels, making sure that the drain wire and foil shield are properly earth grounded, (see *Grounding Your Analog Cable* on page 27 for more information).
- Route the Belden cable separately from any AC wiring. Additional noise immunity can be obtained by routing the cables in grounded conduit.

## Grounding Your Analog Cable

Use shielded communication cable (Belden #8761). The Belden cable has two signal wires (black and clear), one drain wire, and a foil shield. The drain wire and foil shield must be grounded at one end of the cable.

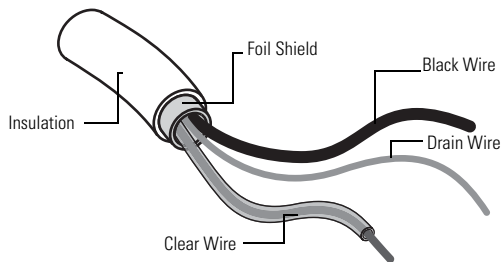

### IMPORTANT

Do not ground the drain wire and foil shield at both ends of the cable.

# Specifications

## General Specifications

Description	1766-L32AWA 1766-L32AWAA	1766-L32BWA 1766-L32BWAA	1766-L32BXB 1766-L32BXBA
Dimensions HxWxD	90 x 180 x 87 mm 3.5 x 7.087 x 3.43 in.		
Shipping weight	0.9 kg (2.0 lbs)		
Number of I/O	24 inputs (20 digital and 4 analog) and 14 outputs (12 digital and 2 analog)		
Power supply voltage	100...240V AC @ 47...63 Hz		24V DC Class 2 SELV
Heat dissipation	Refer to the MicroLogix 1400 Programmable Controllers User Manual, Publication <a href="#">1766-UM001</a> .		
Power supply inrush current	120V AC: 25 A for 8 ms 240V AC: 40A for 4 ms		24V DC: 15 A for 20 ms
Power consumption	100 VA	120 VA	50W 7.5W (with no 1762 expansion I/O)
24V DC sensor power	none	24V DC @ 250 mA 400 µF max.	none
Input circuit type	Digital: 120V AC  Analog: 0...10V DC	Digital: 24V DC sink/source (standard and high-speed) Analog: 0...10V DC	Digital: 24V DC sink/source (standard and high-speed) Analog: 0...10V DC
Output circuit type	Relay		Relay/FET
Relay life - Electrical	2 x 10 <sup>5</sup> operations min (2.5 A, 250V AC / 30V DC)		
Enclosure type rating	None (open-style)		
Wire size	0.25... 2.5 mm <sup>2</sup> (22...14 AWG) solid or stranded copper wire rated @ 90 °C (194 °F) or greater.		
Wiring category <sup>(1)</sup>	2 - on signal ports 2 - on power ports 3 - on communications ports		
Terminal screw torque	0.79 Nm (7.0 in-lb) rated		

## General Specifications

<b>Description</b>	<b>1766-L32AWA 1766-L32AWAA</b>	<b>1766-L32BWA 1766-L32BWAA</b>	<b>1766-L32BXB 1766-L32BXBA</b>
Pilot duty rating	R300, C300		
Expansion bus	Supports up to seven 1762 modules, up to a maximum of 5V, 1500 mA (1300 mA for Series C only) and 24 V, 1500 mA (1300 mA for Series C only).		
North American temp code	T3C		

<sup>(1)</sup> Use this Conductor Category information for planning conductor routing. Refer to Industrial Automation Wiring and Grounding Guidelines, publication [1770-4.1](#).

## Specifications for Inputs

### Digital Inputs

Description	1766-L32AWA 1766-L32AWAA	1766-L32BWA, 1766-L32BWAA, 1766-L32BXB, 1766-L32BXBA	
		Inputs 0 through 11 (12 high-speed DC inputs)	Inputs 12 and higher (8 standard DC inputs)
On-state voltage range	79...132 V AC	4.5...24V DC, Class 2  (4.5...26.4V DC @ 60°C/140°F) (4.5...30V DC @ 30°C/86°F)	10...24V DC, Class 2  (10...26.4V DC @ 60°C/140°F) (10...30V DC @ 30°C/86°F)
Off-state voltage range	0...20 V AC	0...1.5V DC	0...5V DC
Operating frequency	47...63 Hz	0 Hz...100 kHz	0 Hz...1 kHz (scan time dependent)
On-state current min nom max	5.0 mA @ 79 V AC 12 mA @ 120 V AC 16.0 mA @ 132 V AC	7.1 mA @ 4.5V DC 9.9 mA @ 24V DC 10.5 mA @ 30V DC	3.2 mA @ 10V DC 5.3 mA @ 24V DC 5.5 mA @ 30V DC
Off-state leakage current	2.5 mA max.	0.2 mA max.	1.5 mA max.
Nominal impedance	12 kΩ @ 50 Hz 10 kΩ @ 60 Hz	2.4 kΩ	4.5 kΩ
Inrush current (max.) @ 120V AC	250 mA		

### Analog Inputs

Description	1766-L32AWAA, -L32BWAA, -L32BXBA
Voltage input range	0...10.0V DC - 1 LSB
Type of data	12-bit unsigned integer
Input coding (0...10.0V DC - 1 LSB)	0...4,095
Voltage input impedance	>199 kΩ
Input resolution	12 bit
Non-linearity	±1.0% of full scale
Overall accuracy -20...60 °C (-4...140 °F)	±1.0% of full scale
Voltage input overvoltage protection	10.5 V DC
Field wiring to logic isolation	Non-isolated with internal logic

## Analog Outputs

Description	1766-L32AWAA, -L32BWAA, -L32BXBA
Number of inputs	2 single-ended
Voltage output range	0...10 V DC - 1 LSB
Type of data	12 bit unsigned integer
Step response	2.5 ms @ 95%
Load range Voltage output	1 K $\Omega$
Output resolution	12 bit
Analog output setting time	3 ms (max.)
Overall Accuracy -20...60 °C (-4...140 °F)	±1.0% of full scale
Electrical isolation	Non-isolated with internal logic
Cable length	30 m (98 ft) shielded cable

## Relay and FET Outputs

Description		1766-L32AWA, 1766-L32AWAA, 1766-L32BWA, 1766-L32BWAA	1766-L32BXB, 1766-L32XBBA
Maximum controlled load		1440 VA	1080 VA
<b>Maximum Continuous Current:</b>			
Current per channel and group common		2.5 A per channel 8A max channel 8...11 common	2.5 A per channel
Current per controller	at 150V max	28 A or total of per-point loads, whichever is less	
	at 240V max	20 A or total of per-point loads, whichever is less	

## Relay Outputs

Description	1766-L32AWA, 1766-L32AWAA, 1766-L32BWA, 1766-L32BWAA, 1766-L32BXB, 1766-L32XBBA
Turn On Time/Turn Off Time	10 ms (maximum) <sup>(1)</sup>
Load current	10 mA (minimum)

<sup>(1)</sup> Scan time dependent

Maximum Volts	Amperes		Amperes Continuous	Volt-Amperes	
	Make	Break		Make	Break
240V AC	7.5 A	0.75 A	2.5 A	1800 VA	180 VA
120V AC	15.0 A	1.5 A	2.5 A	1800 VA	180 VA
250V DC	0.11 A		1.0 A	28 VA	
125V DC	0.22 A		1.0 A	28 VA	

**1766-L32BXB, 1766-L32BXBA FET Output**

Maximum output current (temperature dependent):

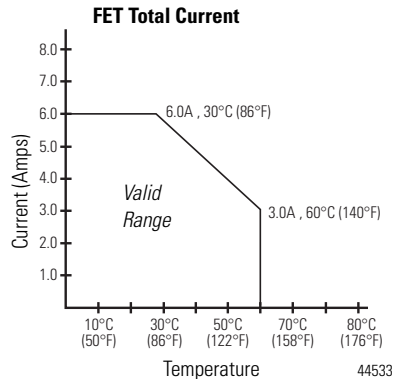
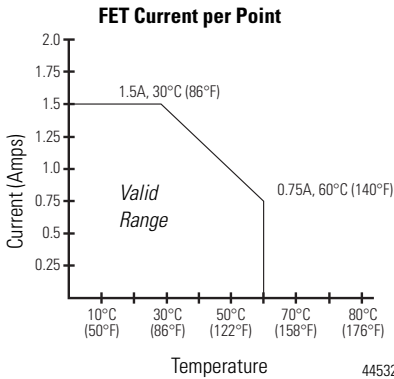

Description	General Operation	High Speed Operation <sup>(1)</sup> (Output 2, 3 and 4 Only)
Power supply voltage	24V DC (-15%, 10%) Class 2	
On-state voltage drop: at max load current at max surge current	1V DC 2.5V DC	Not Applicable Not Applicable
Current rating per point max load min load max leakage	<a href="#">See graphic above</a> 1.0 mA 1.0 mA	100 mA 20 mA 1.0 mA
Surge current per point: peak current max surge duration max rate of repetition @ 30 °C (86 °F) max rate of repetition @ 60 °C (140 °F)	4.0 A 10 ms once every second once every 2 seconds	Not Applicable Not Applicable Not Applicable Not Applicable

Description	General Operation	High Speed Operation <sup>(1)</sup> (Output 2, 3 and 4 Only)
Turn-On Time (maximum)	11 $\mu$ s	28 ns (250 ns for Series C only)
Turn-Off Time (maximum)	89 $\mu$ s	2.3 $\mu$ s (3.5 $\mu$ s for Series C only)

<sup>(1)</sup> Output 2, 3 and 4 are designed to provide increased functionality over the other FET outputs. Output 2, 3 and 4 may be used like the other FET transistor outputs, but in addition, within a limited current range, they may be operated at a higher speed. Output 2, 3 and 4 also provide a pulse train output (PTO) or pulse width modulation output (PWM) function.

## Working Voltage

### Working Voltage for 1766-L32AWA, 1766-L32AWAA

Description	Recommendation
Power supply input to backplane isolation	Verified by one of the following dielectric tests: 1836V AC for 1 second or 2596V DC for 1 second
	265V AC Working Voltage (IEC Class 2 reinforced insulation)
Input group to backplane isolation	Verified by one of the following dielectric tests: 1517V AC for 1 second or 2145V DC for 1 second
	132V AC Working Voltage (IEC Class 2 reinforced insulation)
Input group to input group isolation	Verified by one of the following dielectric tests: 1517V AC for 1 second or 2145V DC for 1 second
	132V AC Working Voltage (basic insulation)
Output group to backplane isolation	Verified by one of the following dielectric tests: 1836V AC for 1 second or 2596V DC for 1 second
	265V AC Working Voltage (IEC Class 2 reinforced insulation)
Output group to output group isolation	Verified by one of the following dielectric tests: 1836V AC for 1 second or 2596V DC for 1 second
	265V AC Working Voltage (basic insulation), 150V AC Working Voltage (IEC Class 2 reinforced insulation)

**Working Voltage for 1766-L32BWA, 1766-L32BWAA**

Description	Recommendation
Power supply input to backplane isolation	Verified by one of the following dielectric tests: 1836V AC for 1 second or 2596V DC for 1 second
	265V AC Working Voltage (IEC Class 2 reinforced insulation)
Input group to backplane isolation and input group to input group isolation	Verified by one of the following dielectric tests: 1100V AC for 1 second or 1697V DC for 1 second
	75V DC Working Voltage (IEC Class 2 reinforced insulation)
Output group to backplane Isolation	Verified by one of the following dielectric tests: 1836V AC for 1 second or 2596V DC for 1 second
	265V AC Working Voltage (IEC Class 2 reinforced insulation).
Output group to output group isolation	Verified by one of the following dielectric tests: 1836V AC for 1 second or 2596V DC for 1 second
	265V AC Working Voltage (basic insulation) 150V Working Voltage (IEC Class 2 reinforced insulation)

**Working Voltage for 1766-L16BXB, 1766-L16BXBA**

Description	Recommendation
Input group to backplane isolation and input group to input group isolation	Verified by one of the following dielectric tests: 1100V AC for 1 second or 1697V DC for 1 second
	75V DC Working Voltage (IEC Class 2 reinforced insulation)
FET output group to backplane isolation	Verified by one of the following dielectric tests: 1100V AC for 1 second or 1697V DC for 1 second
	75V DC Working Voltage (IEC Class 2 reinforced insulation)
Relay output group to backplane isolation	Verified by one of the following dielectric tests: 1836V AC for 1 second or 2596V DC for 1 second
	265V AC Working Voltage (IEC Class 2 reinforced insulation)
Relay output group to relay output group and FET output group isolation	Verified by one of the following dielectric tests: 1836V AC for 1 second or 2596V DC for 1 second
	265V AC Working Voltage (basic insulation), 150V Working Voltage (IEC Class 2 reinforced insulation)





## Environmental Specifications

Description	1766-L32AWA 1766-L32AWAA	1766-L32BWA 1766-L32BWAA	1766-L32BXB 1766-L32BXBA
Temperature, operating	IEC 60068-2-1 (Test Ad, Operating Cold), IEC 60068-2-2 (Test Bd, Operating Dry Heat), IEC 60068-2-14 (Test Nb, Operating Thermal Shock): -20... 60 °C (-4...140 °F)		
Temperature, storage	IEC 60068-2-1 (Test Ab, Unpackaged Non-operating Cold), IEC 60068-2-2 (Test Bb, Unpackaged Non-operating Dry Heat), IEC 60068-2-14 (Test Na, Unpackaged Non-operating Thermal Shock): -40...85 °C (-40...185 °F)		
Relative humidity	IEC 60068-2-30 (Test Db, Unpackaged Damp Heat): 5...95% non-condensing		
Vibration	IEC 60068-2-6 (Test Fc, Operating): 3 g @ 10... 500 Hz		
Shock, operating	IEC 60068-2-27 (Test Ea, Unpackaged Shock): 30 g		
Shock, nonoperating	IEC 60068-2-27 (Test Ea, Unpackaged Shock): Panel mount - 50 g DIN mount - 40 g		
Emissions	CISPR 11 Group 1, Class A		
ESD immunity	IEC 61000-4-2: 6 kV contact discharges 8 kV air discharges		
Radiated RF immunity	IEC 61000-4-3: 10V/m with 1 kHz sine-wave 80% AM from 80...1000 MHz 3 V/m with 1 kHz sine-wave 80% AM from 1.4...2.0 GHz 1 V/m with 1 kHz sine-wave 80% AM from 2.0...2.7 GHz		
EFT/B immunity	IEC 61000-4-4: ±2 kV @ 5 kHz on power ports ±2 kV @ 5 kHz on signal ports ±1 kV @ 5 kHz on communications ports		

Description	1766-L32AWA 1766-L32AWAA	1766-L32BWA 1766-L32BWAA	1766-L32BXB 1766-L32BXBA
Surge transient immunity	IEC 61000-4-5: ±1 kV line-line(DM) and ±2 kV line-earth(CM) on AC power ports ±1 kV line-line(DM) and ±2 kV line-earth(CM) on signal ports ±1 kV line-earth(CM) on communications ports		
Conducted RF immunity	IEC 61000-4-6: 10V rms with 1 kHz sine-wave 80% AM from 150 kHz..80 MHz		
Voltage variation	IEC 6100-4-11: 60% dip for 10 periods on AC supply ports 30% dips for 25 periods @ 0° and 180° on AC supply ports 100% dip for 250 periods @ 0° and 180° on AC supply ports 100% dip for 0.5 periods, arbitrary angle, on AC supply ports		

### Certifications for 1766-L32AWA, 1766-L32AWAA, 1766-L32BWA, 1766-L32BWAA, 1766-L32BXB, 1766-L32BXBA

Certification (when product is marked) <sup>(1)</sup>	Value
UL	UL Listed for Class I, Division 2 Group A,B,C,D Hazardous Locations. See UL File E10314.
c-UL	UL Listed for Class I, Division 2 Group A,B,C,D Hazardous Locations, certified for Canada. See UL File E10314.
CE	European Union 2014/30/EU EMC Directive, compliant with: EN 61000-6-2; Industrial Immunity EN 61000-6-4; Industrial Emissions EN 61131-2; Programmable Controllers (Clause 8, Zone A & B)  European Union 2014/35/EU LVD, compliant with: EN 61131-2; Programmable Controllers (Clause 11)
RCM	Australian Radiocommunications Act, compliant with: AS/NZS CISPR 11; Industrial Emissions
EAC	Russian Customs Union TR CU 020/2011 EMC Technical Regulation
KC	Korean Registration of Broadcasting and Communications Equipment, compliant with: Article 58-2 of Radio Waves Act, Clause 3

<sup>(1)</sup> See the Product Certification link at <http://www.ab.com> for Declaration of Conformity, Certificates, and other certification details.

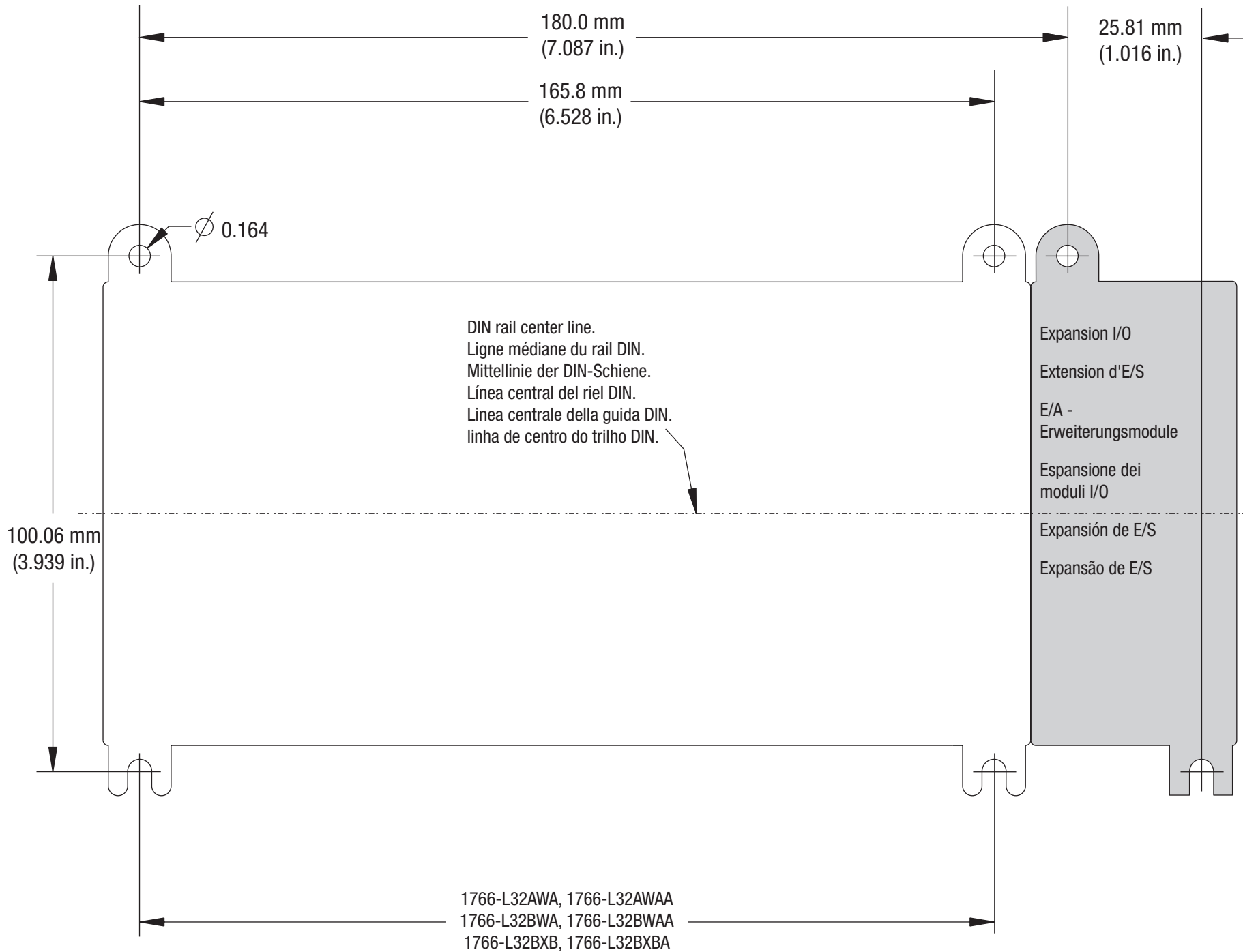

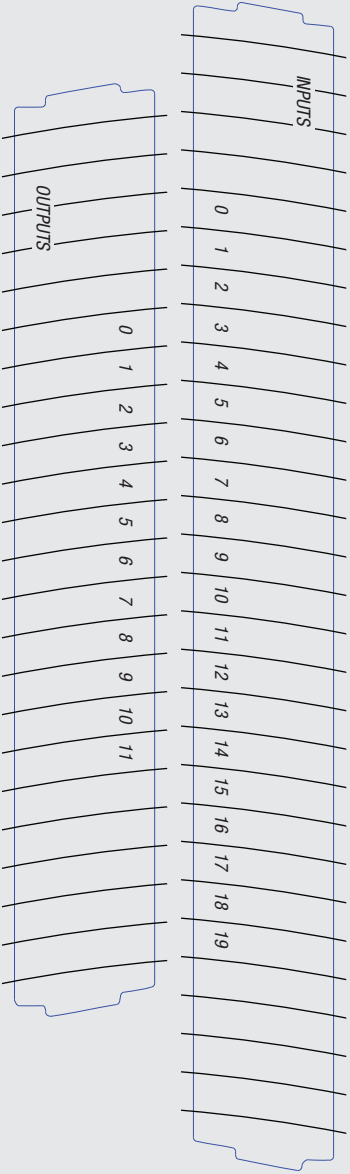

L32AWA

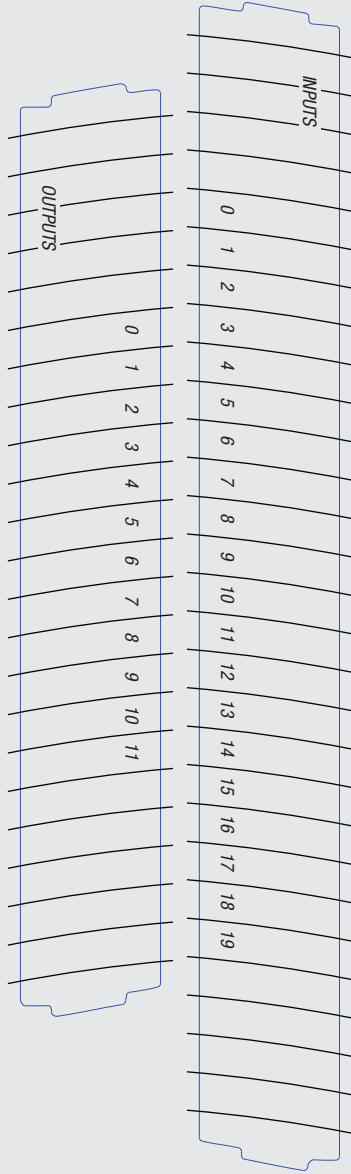

L32AWAA

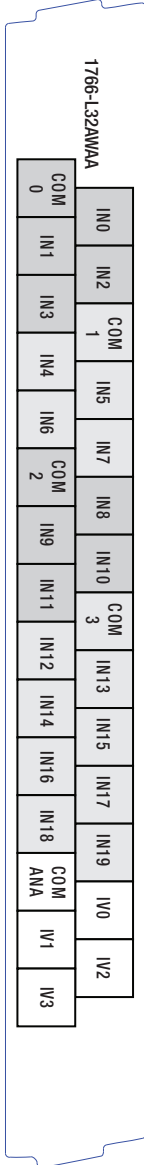
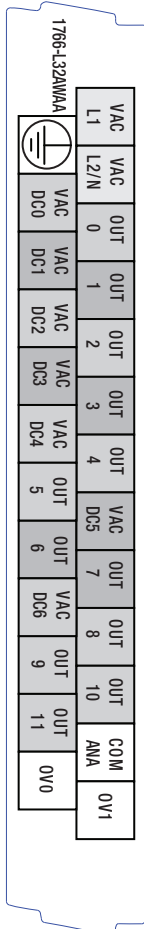
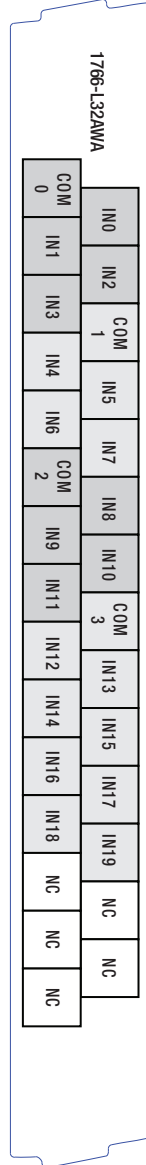
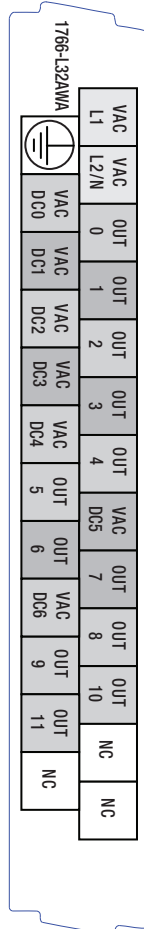

L32AWAA

L32AWA

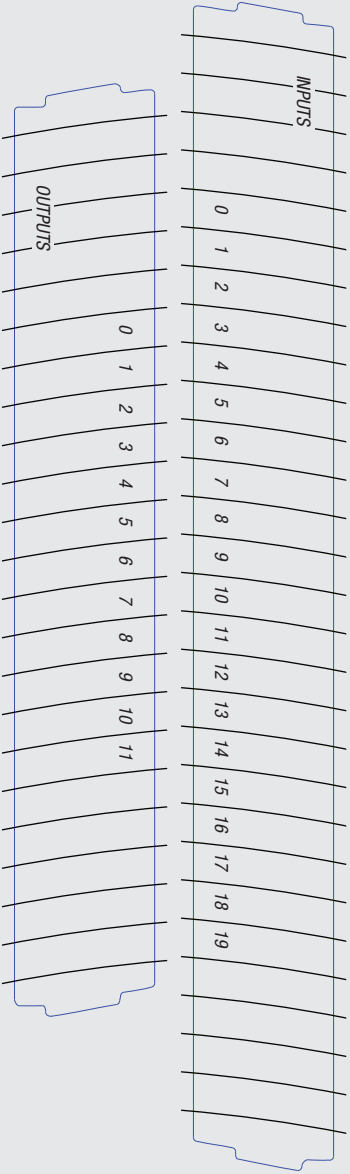

L32BWA



L32BWAA

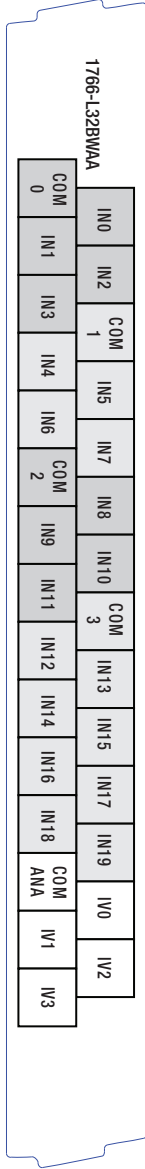
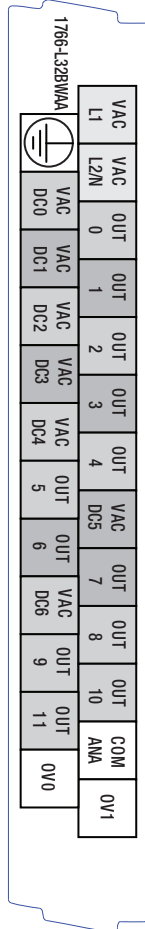
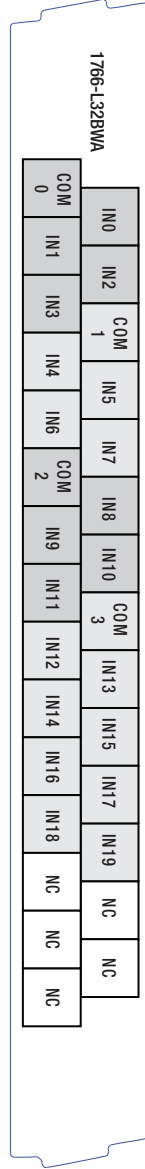
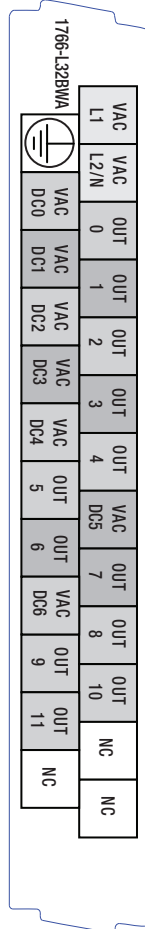

L32BWAA

L32BWA



L32BxB

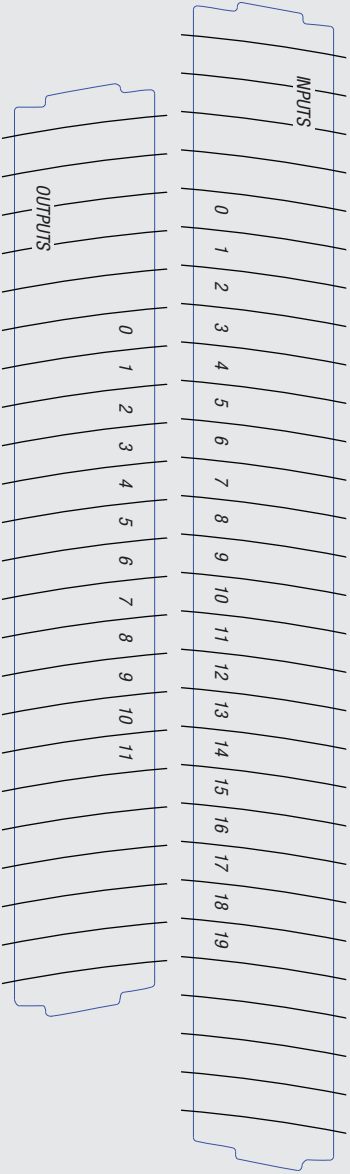

L32BxBA



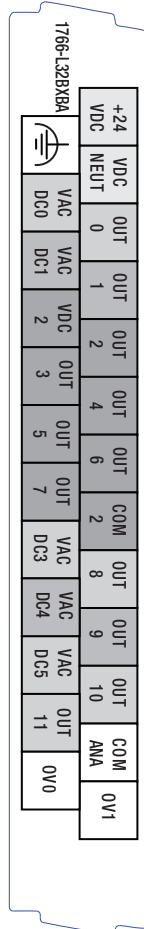

1766-L32BXBA

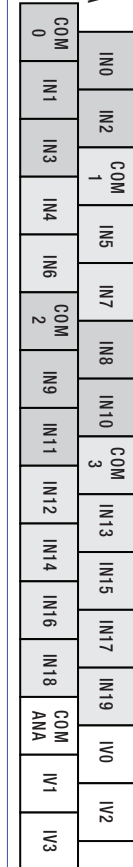

L32BXBA

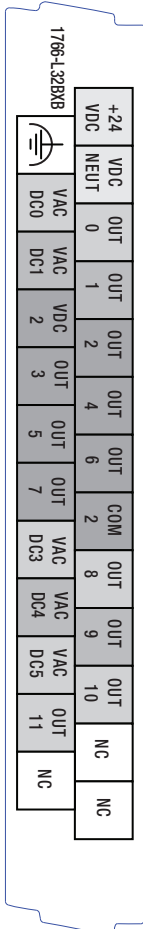

1766-L32BXB

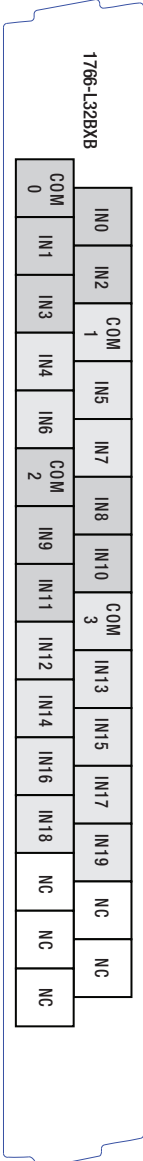

L32BXB

# Rockwell Automation Support

Rockwell Automation provides technical information on the Web to assist you in using its products. At <http://support.rockwellautomation.com>, you can find technical manuals, a knowledge base of FAQs, technical and application notes, sample code and links to software service packs, and a MySupport feature that you can customize to make the best use of these tools.

For an additional level of technical phone support for installation, configuration and troubleshooting, we offer TechConnect support programs. For more information, contact your local distributor or Rockwell Automation representative, or visit <http://support.rockwellautomation.com>.

## Installation Assistance

If you experience a problem within the first 24 hours of installation, please review the information that's contained in this manual. You can also contact a special Customer Support number for initial help in getting your product up and running.

United States	1.440.646.3434 Monday – Friday, 8 a.m. – 5 p.m. EST
Outside United States	Please contact your local Rockwell Automation representative for any technical support issues.

## New Product Satisfaction Return

Rockwell Automation tests all of its products to ensure that they are fully operational when shipped from the manufacturing facility. However, if your product is not functioning and needs to be returned, follow these procedures.

United States	Contact your distributor. You must provide a Customer Support case number (call the phone number above to obtain one) to your distributor in order to complete the return process.
Outside United States	Please contact your local Rockwell Automation representative for the return procedure.

Rockwell Automation maintains current product environmental information on its website at <http://www.rockwellautomation.com/rockwellautomation/about-us/sustainability-ethics/product-environmental-compliance.page>.

Allen-Bradley, Rockwell Automation, MicroLogix, and TechConnect are trademarks of Rockwell Automation, Inc. Trademarks not belonging to Rockwell Automation are property of their respective companies.

Rockwell Otomasyon Ticaret A.Ş., Kar Plaza İş Merkezi E Blok Kat:6 34752 İçerenköy, İstanbul, Tel: +90 (216) 5698400

[www.rockwellautomation.com](http://www.rockwellautomation.com)

### Power, Control and Information Solutions Headquarters

Americas: Rockwell Automation, 1201 South Second Street, Milwaukee, WI 53204-2496 USA, Tel: (1) 414.382.2000, Fax: (1) 414.382.4444  
Europe/Middle East/Africa: Rockwell Automation NV, Pegasus Park, De Kleeflaan 12a, 1831 Diegem, Belgium, Tel: (32) 2 663 0600, Fax: (32) 2 663 0640  
Asia Pacific: Rockwell Automation, Level 14, Core F, Cyberport 3, 100 Cyberport Road, Hong Kong, Tel: (852) 2887 4788, Fax: (852) 2508 1846

Publication 1766-IN001E-EN-P - April 2017

Supersedes Publication 1766-IN001D-EN-P - June 2015

Copyright © 2017 Rockwell Automation, Inc. All rights reserved.