

## PowerMonitor 5000 Unit

Catalog Numbers 1426-M5E, 1426-M5E-DNT, 1426-M5E-CNT, 1426-COMM-DNT, 1426-COMM-CNT, 1426-M6E, 1426-M6E-DNT, 1426-M6E-CNT, 1426-M8E, 1426-M8E-DNT, 1426-M8E-CNT



## Important User Information

Read this document and the documents listed in the additional resources section about installation, configuration, and operation of this equipment before you install, configure, operate, or maintain this product. Users are required to familiarize themselves with installation and wiring instructions in addition to requirements of all applicable codes, laws, and standards.

Activities including installation, adjustments, putting into service, use, assembly, disassembly, and maintenance are required to be carried out by suitably trained personnel in accordance with applicable code of practice.

If this equipment is used in a manner not specified by the manufacturer, the protection provided by the equipment may be impaired.

In no event will Rockwell Automation, Inc. be responsible or liable for indirect or consequential damages resulting from the use or application of this equipment.

The examples and diagrams in this manual are included solely for illustrative purposes. Because of the many variables and requirements associated with any particular installation, Rockwell Automation, Inc. cannot assume responsibility or liability for actual use based on the examples and diagrams.

No patent liability is assumed by Rockwell Automation, Inc. with respect to use of information, circuits, equipment, or software described in this manual.

Reproduction of the contents of this manual, in whole or in part, without written permission of Rockwell Automation, Inc., is prohibited.

Throughout this manual, when necessary, we use notes to make you aware of safety considerations.



**WARNING:** Identifies information about practices or circumstances that can cause an explosion in a hazardous environment, which may lead to personal injury or death, property damage, or economic loss.



**ATTENTION:** Identifies information about practices or circumstances that can lead to personal injury or death, property damage, or economic loss. Attentions help you identify a hazard, avoid a hazard, and recognize the consequence.

---

**IMPORTANT** Identifies information that is critical for successful application and understanding of the product.

---

Labels may also be on or inside the equipment to provide specific precautions.



**SHOCK HAZARD:** Labels may be on or inside the equipment, for example, a drive or motor, to alert people that dangerous voltage may be present.



**BURN HAZARD:** Labels may be on or inside the equipment, for example, a drive or motor, to alert people that surfaces may reach dangerous temperatures.



**ARC FLASH HAZARD:** Labels may be on or inside the equipment, for example, a motor control center, to alert people to potential Arc Flash. Arc Flash will cause severe injury or death. Wear proper Personal Protective Equipment (PPE). Follow ALL Regulatory requirements for safe work practices and for Personal Protective Equipment (PPE).

---

	<b>Preface</b>	
	Summary of Changes .....	7
	About This Manual .....	7
	Intended Audience .....	7
	Catalog Number Explanation .....	8
	Additional Resources .....	8
	<b>Chapter 1</b>	
<b>PowerMonitor 5000 Unit Overview</b>	Safety .....	9
	Product Description.....	9
	PowerMonitor 5000 Unit Features and Functions .....	10
	Before You Begin.....	14
	Product Disposal.....	14
	<b>Chapter 2</b>	
<b>Install the PowerMonitor 5000 Unit</b>	Mounting Considerations .....	15
	Wire the PowerMonitor 5000 Unit.....	18
	Connect Communication .....	31
	<b>Chapter 3</b>	
<b>Setup and Commands</b>	Setup Using the Web Interface .....	49
	Commands .....	58
	Setup Using Custom Add-on Profile.....	59
	Setup Using Optional Software.....	69
	Setup Using Communication .....	69
	<b>Chapter 4</b>	
<b>Metering</b>	Basic Metering .....	71
	Wiring Diagnostics.....	73
	Wiring Correction .....	78
	Metering Overview .....	80
	Energy Metering .....	81
	Demand Metering .....	83
	Power Metering.....	87
	Voltage, Current, Frequency Metering.....	89
	Configuration Lock .....	91
	<b>Chapter 5</b>	
<b>Power Quality Monitoring</b>	Harmonic Analysis .....	96
	Sag and Swell Detection .....	102
	Waveform Recording (M6 and M8 model).....	104

	<b>Chapter 6</b>	
<b>Logging</b>	Logging Overview . . . . .	112
	Waveform Log (M6 and M8 model) . . . . .	118
	Energy Log . . . . .	134
	Data Log . . . . .	138
	Min/Max Log . . . . .	148
	Load Factor Log . . . . .	155
	Time-of-use (TOU) Log . . . . .	156
	Event Log . . . . .	159
	Setpoint Log . . . . .	163
	Alarm Log . . . . .	165
	Power Quality Log (M6 and M8 model) . . . . .	171
	Trigger Data Log (M6 and M8 model) . . . . .	176
	Snapshot Log . . . . .	179
	EN 50160 Weekly and Yearly Logs . . . . .	181
	<b>Chapter 7</b>	
<b>Logic Functions</b>	Relay and KYZ Outputs . . . . .	183
	Status Inputs . . . . .	187
	Setpoints . . . . .	191
	<b>Chapter 8</b>	
<b>Other Functions</b>	Security . . . . .	209
	Date and Time Functions . . . . .	211
	Network Time Synchronization . . . . .	213
	System Error Response . . . . .	217
	Miscellaneous Commands . . . . .	218
	<b>Chapter 9</b>	
<b>Communication</b>	Native Ethernet Communication . . . . .	219
	Optional DeviceNet Communication . . . . .	221
	Optional ControlNet Communication . . . . .	221
	Electronic Data Sheet (EDS) . . . . .	222
	PowerMonitor 5000 Unit Memory Organization . . . . .	223
	Communication Command Summary . . . . .	224
	EtherNet/IP Object Model . . . . .	226
	DeviceNet and ControlNet Object Model . . . . .	227
	Explicit Messaging . . . . .	227
	Examples: Explicit Message Setup . . . . .	228
	SCADA Applications . . . . .	235
	Controller Applications: Class 1 Connection . . . . .	242
	CIP Energy Object . . . . .	260
	<b>Chapter 10</b>	
<b>Maintenance</b>	Update the PowerMonitor 5000 Unit Firmware . . . . .	265

	Upgrading the PowerMonitor 5000 Model and Communication	267
	Use the ControlFLASH Utility to Update Firmware.....	267
<b>PowerMonitor 5000 Unit Data Tables</b>	<b>Appendix A</b>	
	Summary of Data Tables.....	269
	Data Tables.....	272
	Information Tables.....	429
<b>Technical Specifications</b>	<b>Appendix B</b>	
	Certifications .....	434
<b>PowerMonitor 5000 Display Module, Series B Application Summary</b>	<b>Appendix C</b>	
	Introduction.....	437
	Terminal Setup .....	437
<b>PowerMonitor 5000 Display Module, Series A Application Summary</b>	<b>Appendix D</b>	
	Introduction.....	447
	Terminal Setup .....	447
<b>PowerMonitor 5000 Waveform Capture and Compression</b>	<b>Appendix E</b>	
	Compression Algorithm .....	455
<b>IEEE 519 Pass/Fail and TDD</b>	<b>Appendix F</b>	
	IEEE 519 Pass/Fail Capability (M6 and M8 models) .....	459
	IEEE 519 Pass/Fail Results.....	460
	IEEE 519 Short-Term and Long-Term Harmonic Results .....	461
<b>IEEE 1159 Power Quality Event Classification</b>	<b>Appendix G</b>	
	Power Quality Event Classification per IEEE 1159-2009 .....	463
	Transients (Category 1.1.3, 1.2.1)(M8 model).....	464
	Short Duration RMS Variations (Category 2.0 - Sags, Swells, and Interruptions) (M6 and M8 model).....	465
	Long Duration RMS Variations (Category 3.0 - Undervoltage, Overvoltage, Sustained Interruptions) (M6 and M8 model).....	466
	Voltage and Current Imbalance (Category 4.0) .....	467
	Waveform Distortion (Categories 5.1 - DC Offset, 5.2 - Harmonics, and 5.3 - Interharmonics).....	468
	Flicker (Voltage Fluctuations, Category 6.0).....	469
	Power Frequency Variations (Category 7.0) .....	470

<b>EN 50160 Conformance Tracking</b>	<b>Appendix H</b>	
	Introduction.....	473
	Setup.....	473
	Operation .....	474
	Results .....	478
<b>EN 61000-4-30 Metering and Aggregation</b>	<b>Appendix I</b>	
	Introduction.....	483
	Power Quality Parameters .....	484
<b>Installing the Add-on Profile</b>	<b>Appendix J</b>	
	Introduction.....	493
	Download the AOP .....	493
	Install the AOP .....	496
	<b>Glossary</b> .....	499
	<b>Index</b> .....	507

## Summary of Changes

This manual contains new and updated information as indicated in the following table.

Topic	Page
Added information regarding the incompatibility of the open delta metering mode with a 132-phase rotation system to Figure 9.	23
Added information regarding the incompatibility of the open delta metering mode with a 132-phase rotation system to Figure 12.	25
Clarified the operation of the Giga field of the Set kXh Register Command.	82
Added a procedure for waveform data table retrieval.	118
Added a procedure to create a program string.	121
Added a procedure for Common Industrial Protocol method to retrieve waveforms.	123
Added a procedure for the PCCC method to retrieve waveforms.	127
Added a procedure to drive the main program.	130

## About This Manual

This manual contains detailed information on the topics in this list:

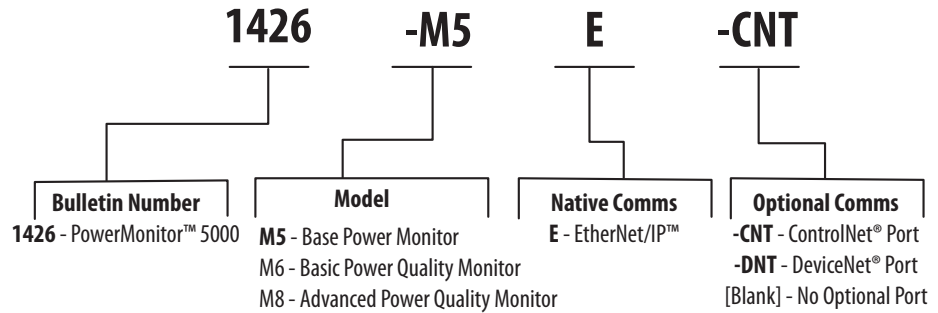
- Mounting and wiring of the unit
- Wiring to native and optional communication port
- Setup and use of the display module
- Information on metering functionality and measurements
- Use of the display module for configuration, monitoring, and commands
- Discussion of communication options, functionality, configuration, and operation
- Setpoint configuration and operation
- Digital I/O configuration and operation
- Data logging, which includes Waveform Log, Event Log, Min/Max Log, Power Quality Log, and Load Factor Log
- Advanced features including Power Quality and Harmonic Analysis
- PowerMonitor™ 5000 data tables

Download firmware, associated files (such as AOP, DTM, and EDS), and access product release notes from the Product Compatibility and Download Center at <http://www.rockwellautomation.com/rockwellautomation/support/pcdc.page>.

## Intended Audience

This manual is intended for qualified personnel with a basic understanding of electric power, energy theory, energy terminology, and alternating-current (AC) metering principles.

## Catalog Number Explanation



## Additional Resources

These documents contain additional information concerning related products from Rockwell Automation.

Resource	Description
PowerMonitor 5000 USB Driver Installation and Configuration, publication <a href="#">1426-IN001</a>	Provides instructions for installing and configuring the USB driver.
FactoryTalk® EnergyMetrix™ User Manual, publication <a href="#">FTEM-UM003</a>	Provides information on the use of FactoryTalk EnergyMetrix software.
PanelView™ 800 HMI Terminals User Manual, publication <a href="#">2711R-UM001</a>	Provides instructions for setup and operation of the PanelView 800 terminal.
PanelView Component HMI Terminals User Manual, publication <a href="#">2711C-UM001</a>	Provides instructions for setup and operation of the PanelView Component terminal.
PanelView™ Plus Terminal User Manual, publication <a href="#">2711P-UM001</a>	Provides instructions for setup and operation of the PanelView Plus terminal.
Industrial Automation Wiring and Grounding Guidelines, publication <a href="#">1770-4.1</a>	Provides general guidelines for installing a Rockwell Automation industrial system.
Product Certifications website: <a href="http://rok.auto/certifications">rok.auto/certifications</a>	Provides declarations of conformity, certificates, and other certification details.

You can view or download publications at <http://www.rockwellautomation.com/global/literature-library/overview.page>.



## PowerMonitor 5000 Unit Overview

### Safety



**ATTENTION:** Only qualified personnel, following accepted safety procedures, can install, wire, and service the PowerMonitor™ 5000 unit and its associated components. Before beginning any work, disconnect all sources of power and verify that they are de-energized and locked out. Failure to follow these instructions can result in personal injury or death, property damage, or economic loss.



**ATTENTION:** Never open a current transformer (CT) secondary circuit with primary current applied. Wiring between the CTs and the PowerMonitor 5000 unit must include a shorting terminal block in the CT secondary circuit. The shorting of the secondary with primary current present allows other connections to be removed if needed. An open CT secondary with primary current applied produces a hazardous voltage, which can lead to personal injury, death, property damage, or economic loss.

**IMPORTANT** The PowerMonitor 5000 unit is not designed for nor intended for use as a circuit protective device. Do not use this equipment in place of a motor overload relay or circuit protective relay.

### Product Description

The PowerMonitor 5000 unit is the next generation of high-end electric metering products from Rockwell Automation. This new family of meters provides advanced technology, new functionality, faster response, and excellent accuracy. The M5 model is the base version and provides an extensive range of metering functionality. The M6 model expands the metering capabilities of the M5 with basic power quality monitoring functionality, including harmonics up to the 63rd, waveforms and logging, and classification of power quality events. The M8 model adds advanced power quality monitoring functions, including flicker that is caused by voltage fluctuations, subcycle transient capture, harmonics up to the 127th order, and interharmonic groups up to the 50th order. The PowerMonitor 5000 unit communicates power and energy parameters to controllers, HMI software, and applications such as FactoryTalk® EnergyMetrix™ software over the Ethernet network or other optional networks.

The PowerMonitor 5000 unit works with controllers or software applications to address key customer applications including the following:

- Load profiling – logging power parameters such as real power, apparent power, and demand, for analysis of power usage by loads over time
- Cost allocation – reports actual energy cost by department or process to integrate energy information into management decisions
- Billing and subbilling – the ability to charge users of energy the actual usage cost rather than allocating by square footage or other arbitrary methods
- Power system monitoring and control – display and control power flow and energy utilization
- Demand management – monitor power usage and controlling loads to reduce demand costs
- Demand response – the controlling and monitoring of usage in response to an instruction to reduce demand from an energy provider
- Power quality - monitors, measures, records, and logs power system irregularities that can result in malfunctions or damage to equipment

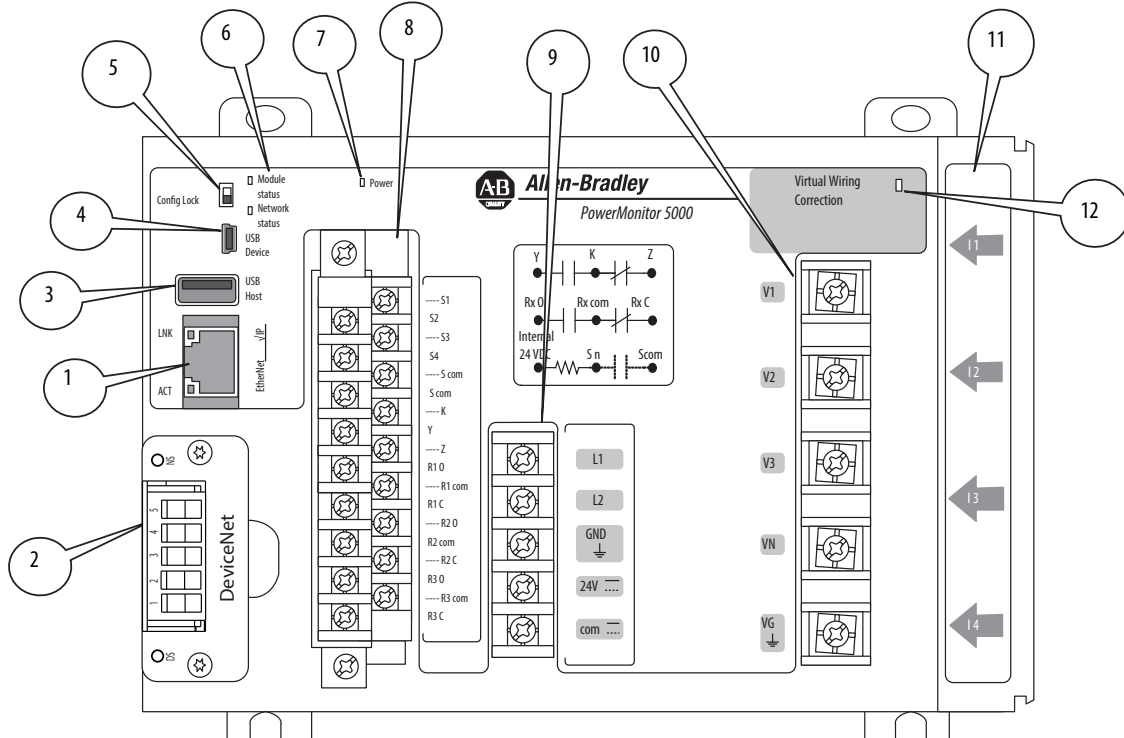
## PowerMonitor 5000 Unit Features and Functions

The PowerMonitor 5000 unit connects to your three-phase or split-phase AC power system directly or through instrument transformers (PTs and CTs). The unit converts instantaneous voltage and current values to digital values, and uses the resulting digital values in calculations of parameters such as voltage, current, power, and energy.

### Features

The PowerMonitor 5000 unit includes a number of hardware features that are common to all models.

**Figure 1 - Hardware Features**



**Table 1 - Hardware Features**

Feature	Description
1. Ethernet port – standard RJ45 jack with status indicators	<p>Ethernet port hardware is included on all models. These protocols and functions are supported:</p> <ul style="list-style-type: none"> <li>EtherNet/IP™ network</li> <li>HTML web page for configuration and data access</li> </ul> <p>Ethernet indicators</p> <ul style="list-style-type: none"> <li>LNK indicator                             <ul style="list-style-type: none"> <li>Solid GREEN: IP link established</li> <li>Off: No link established</li> </ul> </li> <li>ACT indicator                             <ul style="list-style-type: none"> <li>Flashing YELLOW: Data present on Ethernet port</li> <li>Off: No data activity present</li> </ul> </li> </ul>
2. Optional communication port	<p>DeviceNet® and ControlNet® networks</p> <ul style="list-style-type: none"> <li>Module Status                             <ul style="list-style-type: none"> <li>OFF: No control power</li> <li>Flashing GREEN/RED: Self-test</li> <li>Flashing GREEN: Power monitor has not been configured</li> <li>GREEN: Power monitor is running</li> <li>Flashing RED: Power monitor has detected a recoverable minor fault</li> <li>RED: Power monitor has detected a non-recoverable major fault</li> </ul> </li> <li>Network Status                             <ul style="list-style-type: none"> <li>OFF: No control power</li> <li>Flashing GREEN/RED: Self-test</li> <li>Flashing GREEN: No CIP™ connection</li> <li>Solid GREEN: CIP connection established</li> <li>Flashing RED: CIP connection timed out</li> <li>Solid RED: Duplicate address detected</li> </ul> </li> </ul>
3. USB host port	USB standard A receptacle. Not used in this model.
4. USB device port	The USB device port is a USB Mini-B receptacle that accepts standard USB Mini-B plugs, for connection to a host device, such as a notebook computer.
5. Configuration Lock switch	When enabled, this switch helps prevent changes in configuration that can affect revenue accuracy.

**Table 1 - Hardware Features (continued)**

Feature	Description
6. Device and Network status indicators	<ul style="list-style-type: none"> <li>• Device status                             <ul style="list-style-type: none"> <li>– OFF: No control power</li> <li>– Flashing GREEN/RED: Self-test</li> <li>– Flashing GREEN: Power monitor has not been configured</li> <li>– GREEN: Power monitor is running</li> <li>– Flashing RED: Power monitor has detected a recoverable minor fault</li> <li>– RED: Power monitor has detected a non-recoverable major fault</li> </ul> </li> <li>• Network status (Native Ethernet port)                             <ul style="list-style-type: none"> <li>– OFF: No control power</li> <li>– Flashing GREEN/RED: Self-test</li> <li>– Flashing GREEN: No CIP connection</li> <li>– Solid GREEN: CIP connection established</li> <li>– Flashing RED: CIP connection timed out</li> <li>– Solid RED: Duplicate IP address detected</li> </ul> </li> </ul>
7. Power	<ul style="list-style-type: none"> <li>• Power status                             <ul style="list-style-type: none"> <li>– OFF: No control power</li> <li>– GREEN: Control power is present</li> </ul> </li> </ul>
8. Status input, KYZ output, and control relay wiring terminals	<ul style="list-style-type: none"> <li>• Four internally powered (24V DC) status inputs</li> <li>• Status input 2 can be used for demand period synchronization</li> <li>• KYZ DPDT solid-state relay for signaling use</li> <li>• Three DPDT control relays</li> </ul>
9. Control power and ground wiring terminals	<ul style="list-style-type: none"> <li>• 120 . . . 240V AC, 50/60 Hz, or 120 . . . 240V DC</li> <li>• 24V DC</li> </ul>
10. Voltage sensing wiring terminals	<ul style="list-style-type: none"> <li>• Direct connect to up to 690V AC 3-phase line to line</li> <li>• Maximum nominal line to ground voltage 690</li> <li>• Use potential transformers (PTs) for higher voltages</li> <li>• Neutral voltage and ground voltage connections</li> </ul>
11. Current sensing wiring openings	<ul style="list-style-type: none"> <li>• Nominal input current 5 A</li> <li>• Use current transformers (CTs) to connect to power system</li> </ul>
12. Virtual wiring correction indicator	<p>Indicates that a virtual wiring correction command has been applied to resolve wiring errors without rewiring. See <a href="#">Wiring Correction on page 78</a>.</p>

## Functionality

**Table 2 - PowerMonitor 5000 Unit Functions**

Measured Parameters	1426-M5	1426-M6	1426-M8
Voltage, L-L and L-N	•	•	•
Current, per phase and total	•	•	•
Frequency, last cycle and average	•	•	•
Voltage unbalance	•	•	•
Current unbalance	•	•	•
Real power, kW	•	•	•
Symmetrical Component Analysis	•	•	•
Reactive power, kVAR	•	•	•
Apparent power, kVA	•	•	•
True power factor, per phase and total	•	•	•
Displacement power factor, per phase and total	•	•	•
Reactive energy, kVARh	•	•	•
Real energy, kWh	•	•	•
Apparent energy, kVAh	•	•	•
Real power demand, kW	•	•	•
Reactive power demand, kVAR	•	•	•
Apparent power demand, kVA	•	•	•
Projected kW demand	•	•	•
Projected kVAR demand	•	•	•
Projected kVA demand	•	•	•
Demand power factor	•	•	•
Crest factor, V-V, V-N, and I, per phase	•	•	•
EN 61000-4-30 10/12 cycle metering			•

**Table 3 - Logging Functions**

Logging Function	1426-M5	1426-M6	1428-M8
Energy log	•	•	•
Data log	•	•	•
Min/max log	•	•	•
Load factor log	•	•	•
Time of use log	•	•	•
Event log	•	•	•
Setpoint log	•	•	•
Alarm log	•	•	•
Power Quality log		•	•
Waveform log		•	•
Trigger Data log		•	•

**Table 3 - Logging Functions**

Logging Function	1426-M5	1426-M6	1428-M8
Snapshot log		•	•
EN 50160 weekly log			•
EN 50160 yearly log			•

**Table 4 - Other Functions**

Function	1426-M5	1426-M6	1426-M8
Security	•	•	•
Wiring diagnostics	•	•	•
Wiring correction	•	•	•
Network time synchronization	•	•	•
Network demand synchronization	•	•	•
Configuration lock	•	•	•
IEEE 1588 Precision Time Protocol	•	•	•
Waveform synchronization broadcast (WSB)		•	•
Relay (3) and KYZ (1) outputs	•	•	•
Status inputs (4)	•	•	•
Setpoint programming	•	•	•
Sag and swell detection	•	•	•
Logical setpoint programming		•	•
Web page	•	•	•
CIP Energy™ object	•	•	•

See [Power Quality Monitoring on page 93](#) for a listing of power quality functions.

## Before You Begin

Use this document as a guide for installing, wiring, connecting, applying power, and configuring your power monitor to provide electric power, energy, and power quality information through your web browser, FactoryTalk EnergyMetrix software, or other applications. You must already be familiar with AC power and power metering.

## Product Disposal



At the end of its life, this equipment must be collected separately from any unsorted municipal waste.

### Install the PowerMonitor 5000 Unit

Only qualified personnel can install, wire, service, and maintain this equipment. Refer to and follow the safety guidelines and pay attention to all warnings and notices in these instructions.



**ATTENTION:** Electrostatic discharge can damage integrated circuits or semiconductors. Follow these guidelines when you handle the module:

- Touch a grounded object to discharge static potential.
- Wear an approved wriststrap grounding device.
- Do not open the module or attempt to service internal components.
- Use a static safe workstation, if available.
- Keep the module in its static shield bag when not in use.

### Mounting Considerations

Mount the PowerMonitor™ 5000 unit in a suitable protective enclosure. Select an enclosure that helps protect the unit from atmospheric contaminants, such as oil, water, moisture, dust, corrosive vapors, and other harmful airborne substances. Make sure that the enclosure protects against personal contact with energized circuits.

The ambient temperature within the enclosure must remain within the limits that are listed in [Appendix B, Technical Specifications](#). Select an enclosure that provides adequate clearance for ventilation and wiring for the power monitor and other equipment to be installed within the enclosure.

See [PowerMonitor 5000 Unit Dimensions on page 16](#) for dimensions and space guidelines for the power monitor.

When installed within a substation or switchgear lineup, we recommend that the power monitor is mounted within a low-voltage cubicle, which is isolated from medium and high-voltage circuits. Be sure that the mounting panel is properly connected to a low-impedance earth ground.

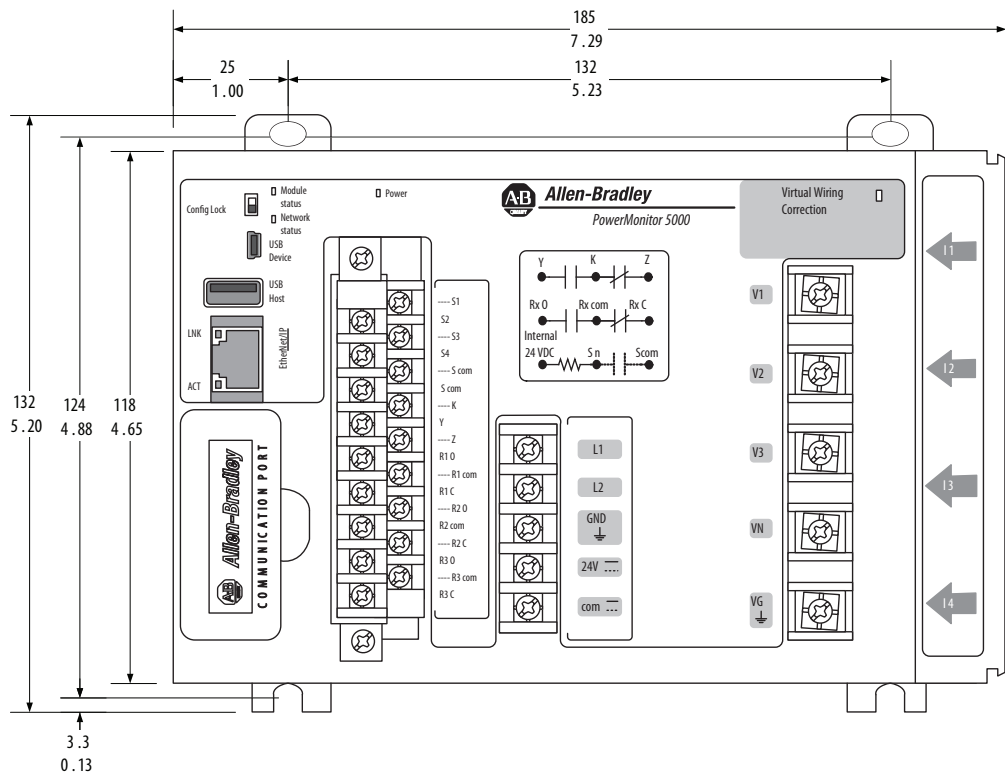
Mount the enclosure in a position that allows full access to the unit. Install the unit with the ventilation slots in the bottom and top of the unit unobstructed to assure adequate free convection air flow to cool the internal electronic components.

**IMPORTANT** Use caution not to block the ventilation slots of the power monitor. All wiring, wireways, enclosure components, and other obstructions must be a minimum of 50 mm (2.0 in.) from the top and bottom of the unit to provide ventilation and electrical isolation. Units can be mounted side by side.

Access to the USB device port is required for initial configuration of the power monitor and can be required for eventual administration and maintenance. Consider safe and convenient access to the power monitor front panel when planning the installation location.

### PowerMonitor 5000 Unit Dimensions

Mounting Hole Tolerance:  
±0.4 mm (0.016 in.)  
Dimensions are in mm/in.  
Depth: 178/7.0

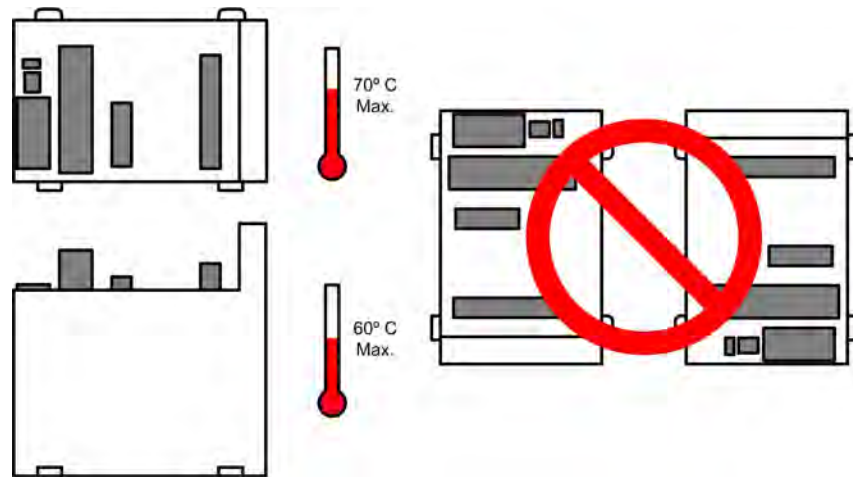




## Mounting Orientation Options

We recommend that you mount the power monitor to a vertical panel with the ventilation slots at the top and bottom. You can also mount the unit on a horizontal surface, however, the maximum ambient operating temperature in this orientation is 60 °C (140 °F). Do not mount the unit with the ventilation slots at the side. See [Figure 2](#).

**Figure 2 - Mounting Orientation**



## Panel Mounting

Follow these steps for panel mounting a PowerMonitor 5000 unit.

1. Use the power monitor as a template and mark pilot holes on your panel.
2. Drill pilot holes for M4 or #8 screws.



**ATTENTION:** During mounting of all devices, make sure that all debris (such as metal chips or wire strands) is kept from falling into the power monitor. Debris, which falls into the module, can cause damage when the device is energized.

3. Use M4 or #8 screws to mount the power monitor to your panel and tighten to 1.16 N•m (10 lb•in).
4. Ground the power monitor on a ground bus with a low-impedance earth ground connection.
5. Connect the ground bus to a functional earth ground on the panel.

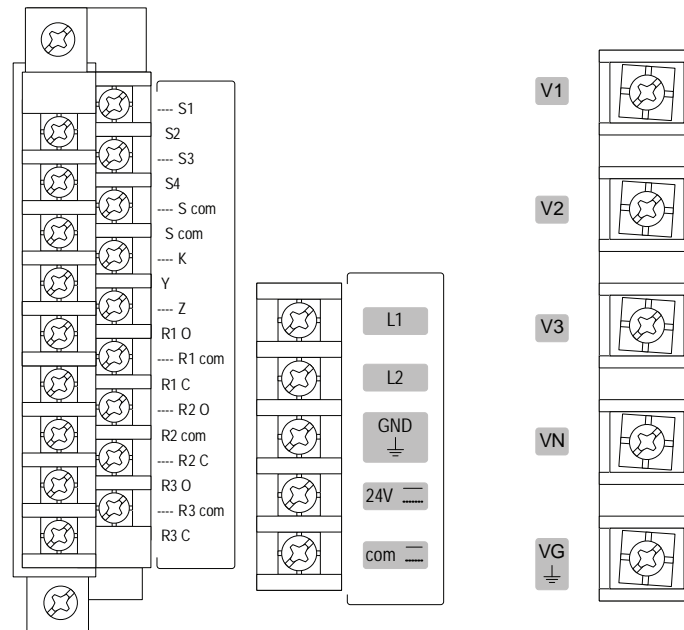
**IMPORTANT** The upper mounting slots are equipped with protective conductor terminals that must make metal-to-metal contact with the grounded mounting panel.

## Wire the PowerMonitor 5000 Unit

The PowerMonitor 5000 unit is equipped with screw terminals with pressure plates and finger protection for the control power, I/O wiring, and voltage connections. The I/O wiring block is removable.

Current sensing conductors are routed through openings in the power monitor housing.

**Figure 3 - Terminal Block Layout**



## Wire Requirements

Wiring Category	Wire Type	Wire Size Range	Wires Per Terminal	Recommended Torque
Control Power	Cu - 75 °C (167 °F)	0.25...2.5 mm <sup>2</sup> (22...14 AWG)	2 Max	1.27 N•m (11.24 lb•in)
Input/output (I/O)		0.5...0.8 mm <sup>2</sup> (20...18 AWG)		0.68 N•m (6 lb•in)
Voltage Sensing		0.75...2.5 mm <sup>2</sup> (18...14 AWG)		1.50 N•m (13.3 lb•in)
Current Sensing		4 mm <sup>2</sup> Max (12 AWG Max)	1 Max	—

## Grounding

This product is intended to be mounted to a well-grounded mounting surface, such as a metal panel. The upper mounting slots are equipped with protective conductor terminals, which must make metal-to-metal contact with the mounting panel. In solid-state systems, grounding helps limit the effects of noise due to electromagnetic interference (EMI).

Connect a 2.5 mm<sup>2</sup> (14 AWG) wire from the GND terminal of the PowerMonitor 5000 unit to the ground bus or other low-impedance earth ground before you connect the control power or any other connections.

You must ground voltage and current sensing circuits to limit the maximum voltage to ground for safety. Ground CT secondary circuits at either the CT or the shorting terminal block. All grounds must be made to a common ground bus or terminal.

See the Industrial Automation Wiring and Grounding Guidelines, publication [1770-4.1](#), for additional information.

## Wiring Accessory Kit

The power monitor accessory kit simplifies the installation of a PowerMonitor 5000 unit by making all required installation accessories available in one catalog number, 1400-PM-ACC. The accessory kit includes the following items:

- Three 10 A fuses and blocks voltage sensing wiring protection
- One 1 A fuse and block for control wiring protection
- One 8-pole shorting terminal block for CT wiring

Contact your local Allen-Bradley distributor or Rockwell Automation sales representative for more information.

## Voltage and Current Sensing Connections

The PowerMonitor 5000 unit can monitor various three-phase, single-phase, and split-phase circuits. Select the voltage sensing connections, current sensing wiring, and metering mode to match the configuration of the circuit being monitored.

[Table 5](#) provides a key to select the proper wiring diagrams and metering modes.

**Table 5 - Selecting Wiring Diagrams and Metering Modes**

Circuit Type	Line - Line Voltage	No. of CTs	No. of PTs	Voltage Sensing	Current Sensing	Metering Mode
3-phase, 4-wire wye	≤690V	3	-	Diagram V1	Diagram I3	Wye
	> 690V		3	Diagram V3		
3-phase, 3-wire grounded wye	≤690V		-	Diagram V2		
	> 690V		3	Diagram V5		
3-phase, 4-wire impedance grounded wye	≤690V		-	Diagram V1		
	> 690V		3 L-N	Diagram V3		
		3 L-N, 1 N-G	Diagram V4			
3-phase, 3-wire Delta, or ungrounded wye	≤690V	2	-	Diagram V2	Diagram I2	Delta 2 CT
		3			Diagram I3	Delta 3 CT
	> 690V	2	2 <sup>(2)</sup>	Diagram V6	Diagram I2	Open delta 2 CT
		3			Diagram I3	Open delta 3 CT

**Table 5 - Selecting Wiring Diagrams and Metering Modes (continued)**

Circuit Type	Line - Line Voltage	No. of CTs	No. of PTs	Voltage Sensing	Current Sensing	Metering_Mode
Split-phase	≤690V	2/1	-	Diagram V7	Diagram I1	Split-phase
	> 690V	2/1	2/1	Diagram V8		
3-phase, 3-wire delta, Grounded B Phase <sup>(1)</sup>	≤690V	2	-	Diagram V9	Diagram I2	Delta Grd B Ph 2 CT
		3	-		Diagram I3	Delta Grd B Ph 3 CT
3-phase, 4-wire high leg <sup>(1)</sup> (wildcat)	≤690V	3	-	Diagram V10	Diagram I3	Delta high leg
Single phase	≤690V	1	-	Diagram V11	Diagram I4	Single phase
	> 690V	1	1	Diagram V12		
For demo use	-	-	-	-	-	Demo

(1) Delta Grounded B Phase and delta high leg are not supported above 690V L-L. Use the 3-phase, 3-wire delta circuit type.  
 (2) 2 PTs used in open-delta configuration.

## Voltage Sensing

Circuits that are rated up to 690V AC line-to-line can be connected directly. Higher voltages require potential transformers (PTs), also known as voltage transformers (VTs), to step the voltage down.

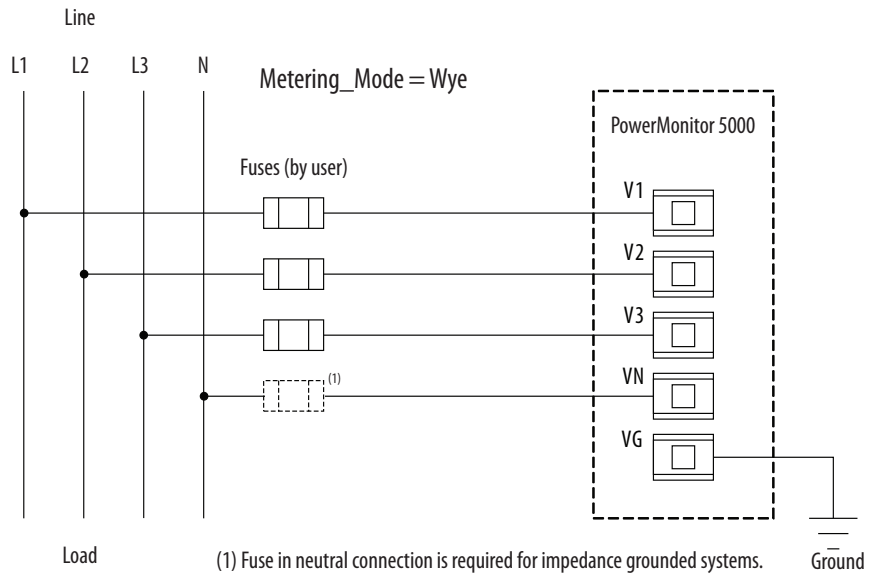
Wiring must conform to all applicable codes and standards. In particular, you provide suitable overcurrent protection, with current and interrupting ratings that are selected to help protect the wiring.

Pay particular attention to correct phasing and polarity of voltage connections. The diagrams use the ‘dot’ convention to indicate transformer polarity. The dot indicates the H1 and X1 terminals on the high side and low side of the transformer respectively.

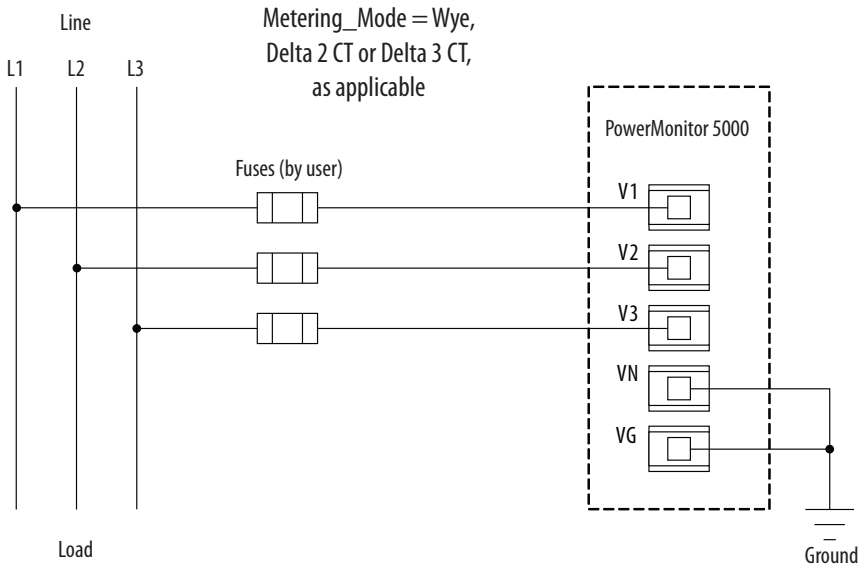
When wiring a PowerMonitor 5000 unit to existing PTs and metering devices, connect the voltage sensing terminals of the PowerMonitor 5000 unit in parallel with the voltage sensing terminals of the existing metering devices.

The following wiring diagrams indicate typical voltage sensing connections to various types of power systems.

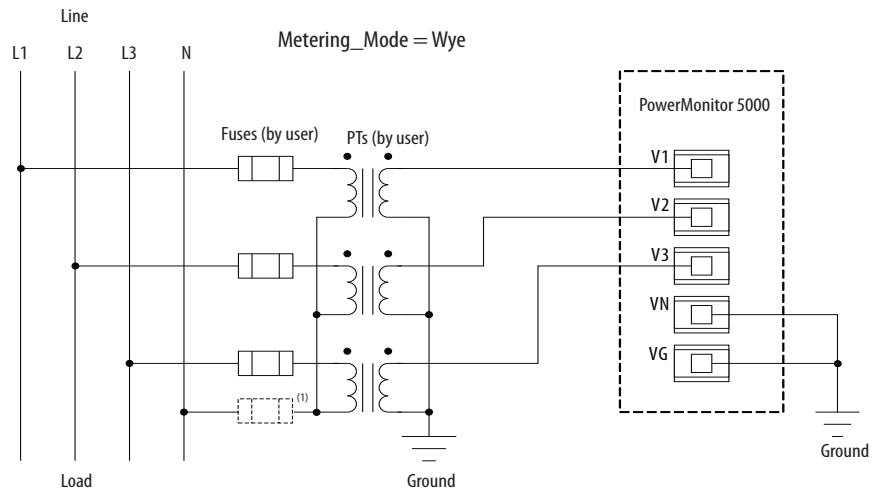
**Figure 4 - Diagram V1 - 3-phase, 4-wire Wye (690V AC Line-to-line Maximum)**



**Figure 5 - Diagram V2 - 3-phase, 3-wire Grounded Wye, or 3-phase, 3-wire Delta (690V AC Line-to-line Maximum)**

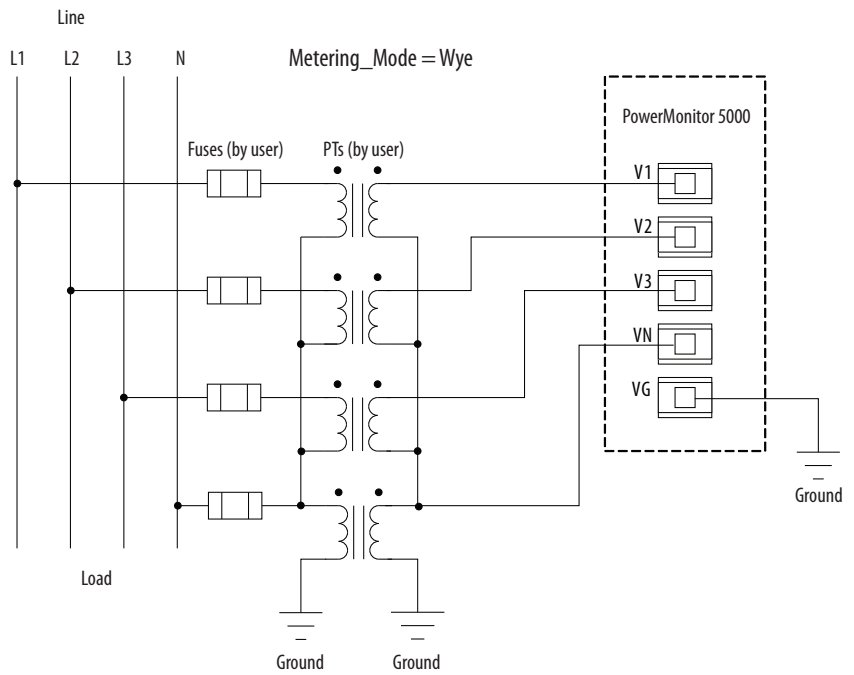


**Figure 6 - Diagram V3 - 3-phase, 4-wire Wye, or Impedance Grounded Wye with PTs (No Neutral PT)**

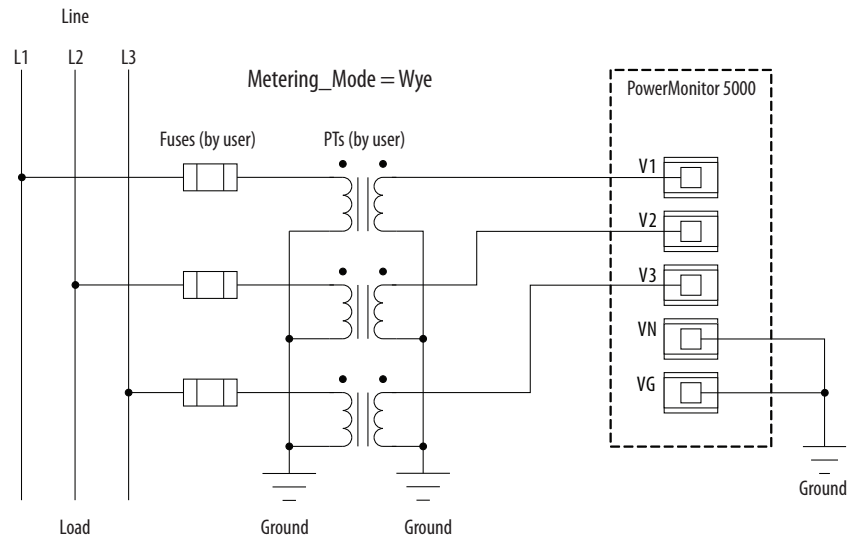


(1) Fuse in neutral connection is required for impedance grounded systems.

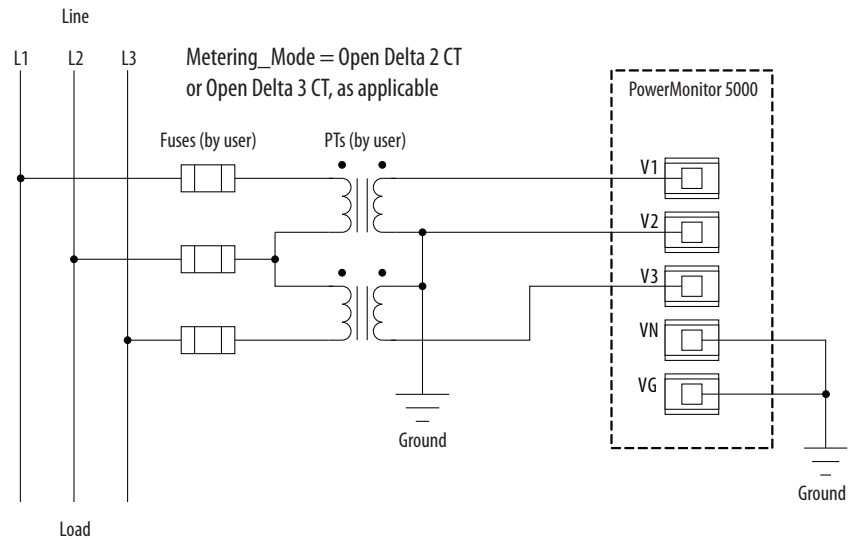
**Figure 7 - Diagram V4 - 3-phase, 4-wire Impedance Grounded Wye with Line and Neutral PTs**



**Figure 8 - Diagram V5 - 3-phase, 3-wire Grounded Wye with PTs**

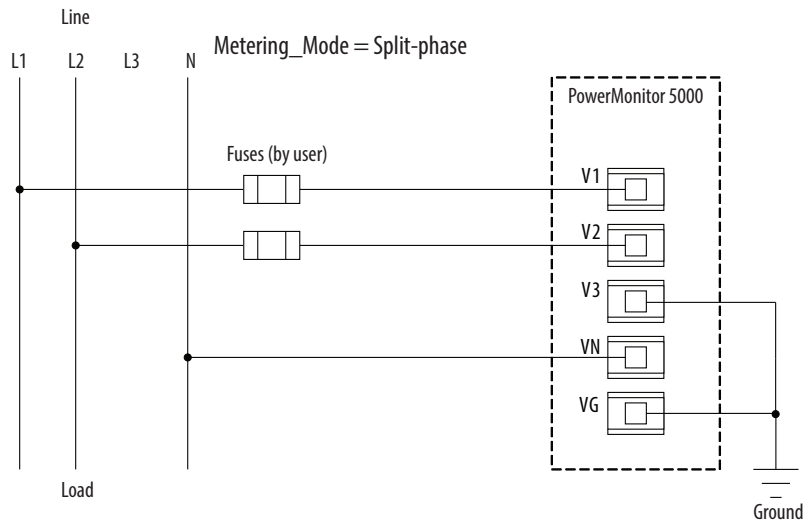


**Figure 9 - Diagram V6 - 3-phase, 3-wire Open Delta with Two PTs**

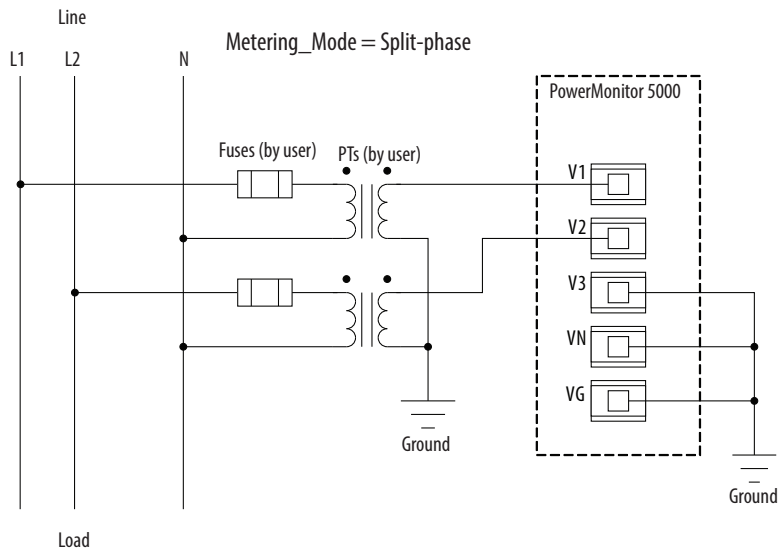


**IMPORTANT** Open Delta metering mode is incompatible with 132-phase rotation systems. Wiring diagnostics may not accurately detect the wiring issues in Open Delta metering mode when the voltage rotation is 132. If the voltage rotation is reported as 132, it is recommended to swap V1 and V3. Then, rerun wiring diagnostics to determine if additional changes are necessary.

**Figure 10 - Diagram V7 - Split-phase (690V AC Line-to-line Maximum)**

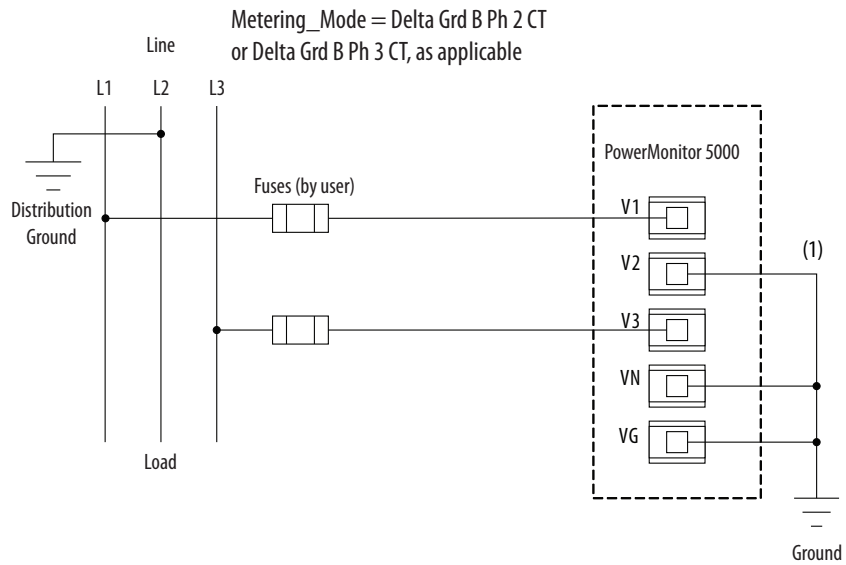


**Figure 11 - Diagram V8 - Split-phase with PTs**





**Figure 12 - Diagram V9 - 3-phase, 3-wire Grounded B-phase (690V AC Line-to-line Maximum)**



**IMPORTANT** Open Delta metering mode is incompatible with 132-phase rotation systems. Wiring diagnostics may not accurately detect the wiring issues in Open Delta metering mode when the voltage rotation is 132. If the voltage rotation is reported as 132, it is recommended to swap V1 and V3. Then, rerun wiring diagnostics to determine if additional changes are necessary.

**Figure 13 - Diagram V10 - 3-phase, 4-wire High Leg Delta (690V AC Line-to-line Maximum)**

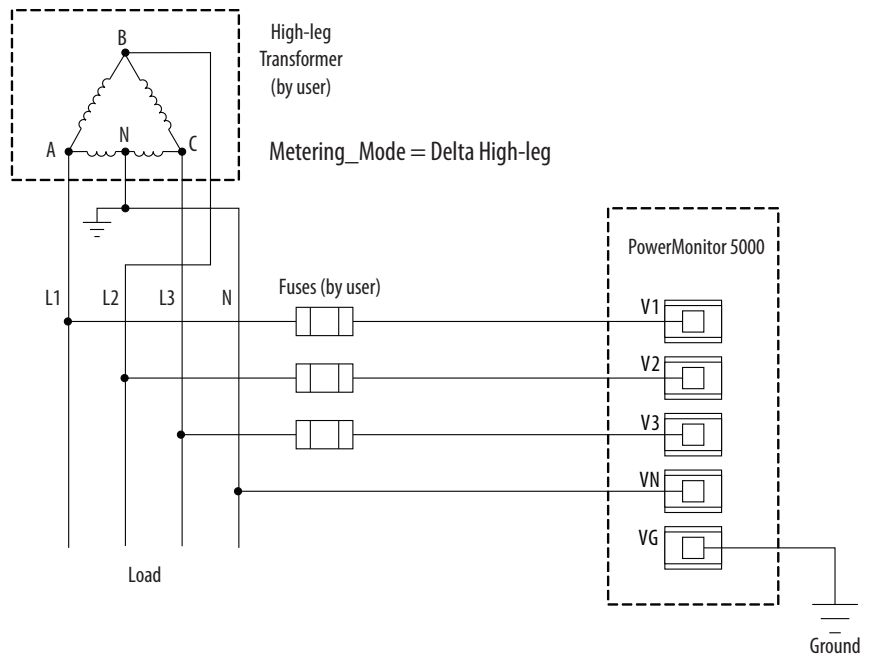


Figure 14 - Diagram V11 - Single-phase (690V AC Line-to-line Maximum)

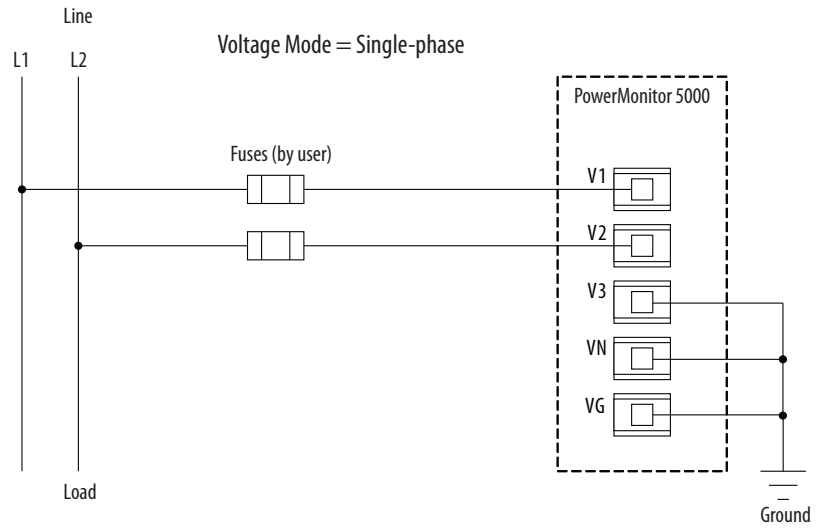
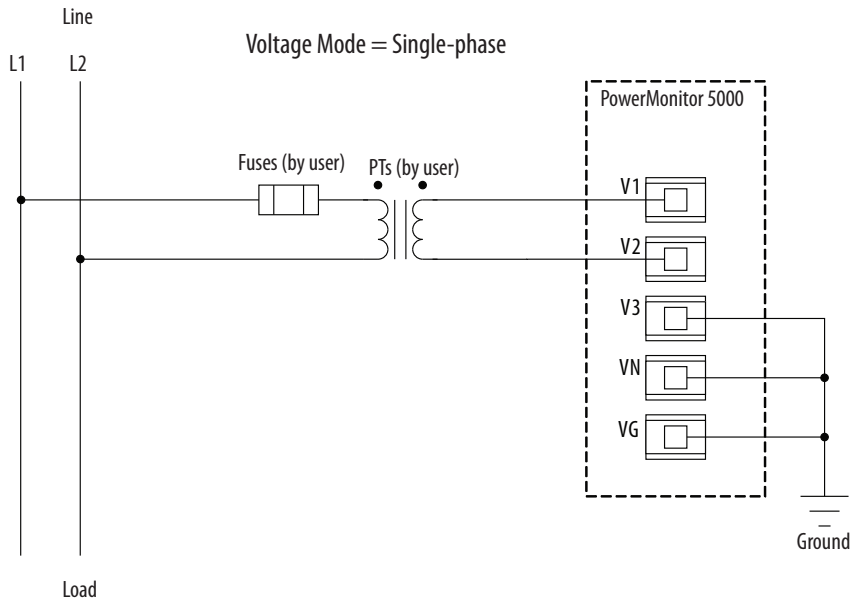
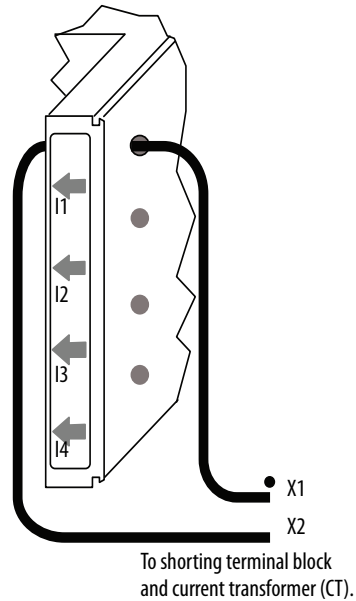


Figure 15 - Diagram V12 - Single-phase with PTs



## Current Sensing

Route the CT secondary wiring through the openings in the PowerMonitor 5000 unit as shown.



Use a shorting terminal block (included in the 1400-PM-ACC accessory kit), test block, or shorting switch (you provide) for CT wiring to permit safely servicing connected equipment such as the PowerMonitor 5000 unit without de-energizing the power system.

Use 2.5 mm<sup>2</sup> (14 AWG) or 3.3 mm<sup>2</sup> (12 AWG) (maximum) wiring between the PowerMonitor 5000 unit and the shorting block. Use 2.5 mm<sup>2</sup> (14 AWG) or larger wire between the shorting block and the CTs, depending on the length of the circuit. Longer circuits require larger wire so that the wiring burden does not exceed the CT burden rating and reduce system accuracy. The diameter of the current sensing wiring openings is 7 mm (0.27 in.).

---

**IMPORTANT** Ring lugs are recommended for making CT secondary connections. Standard ring lugs do not pass through the current sensing openings of the PowerMonitor 5000 unit. We recommend that the installer route the wire from the shorting terminal block through the current sensing opening before crimping on ring lugs.

---

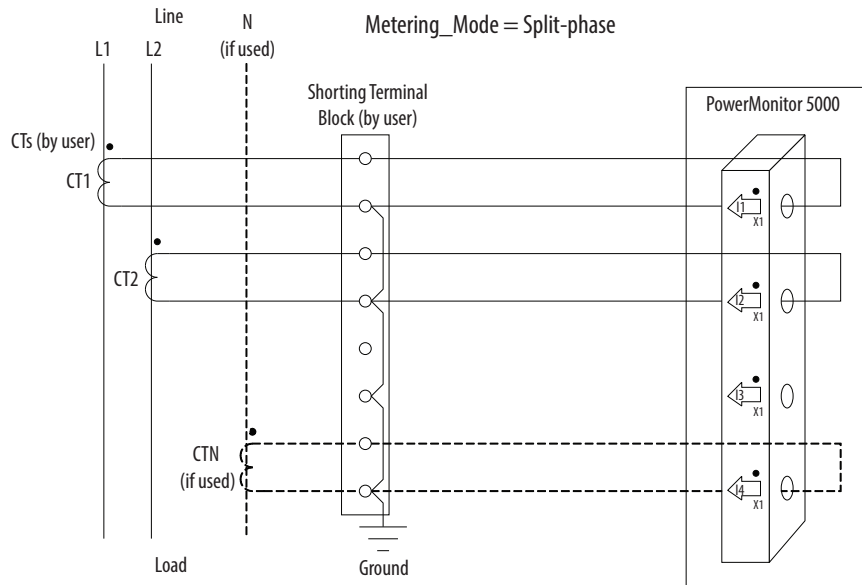
When wiring a PowerMonitor 5000 unit to existing CTs and metering devices, wire the current sensing circuits of the PowerMonitor 5000 unit in series with the CT secondary and current sensing circuits of the existing metering devices.

Do not install overcurrent protection or non-shorting disconnecting means in CT secondary wiring. Connect the current sensing circuit to a low-impedance earth ground at only one point.

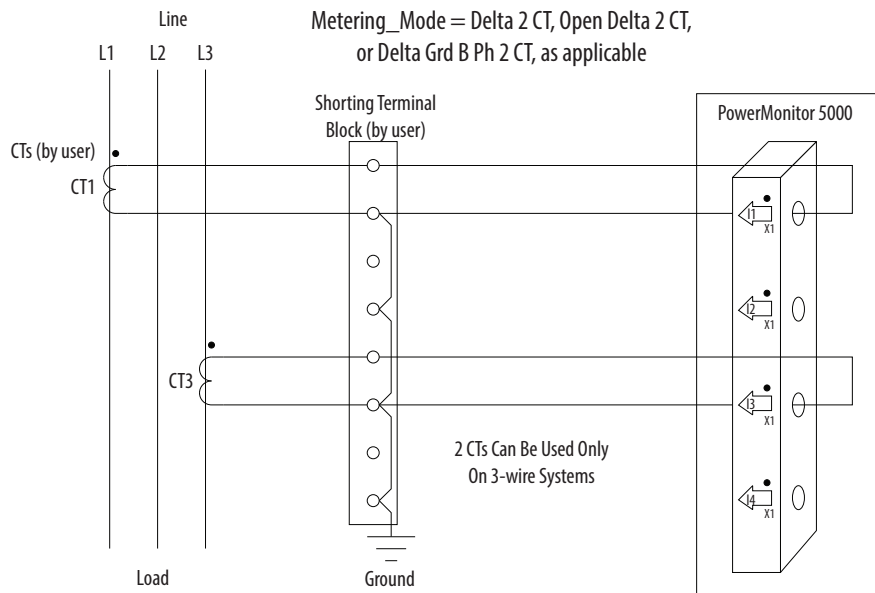
Pay particular attention to the correct phasing and polarity of current sensing connections. The diagrams use the 'dot' convention to indicate transformer polarity. The dot indicates the H1 and X1 terminals on the primary and secondary of the CT respectively. Phasing of the CTs must correspond to the phasing of the voltage sensing connections.

The following wiring diagrams indicate typical current sensing connections to various types of power systems.

**Figure 16 - Diagram I1 - Split-phase, 2 CTs**

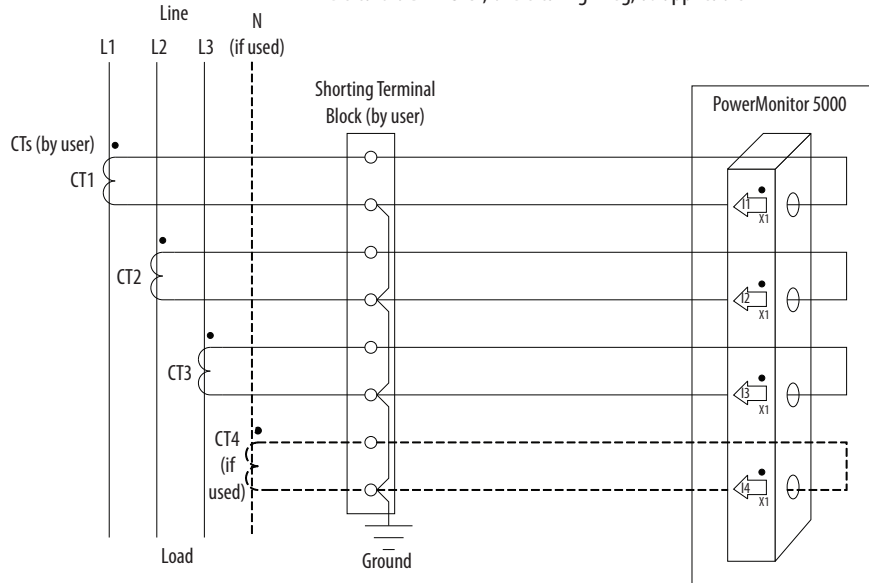


**Figure 17 - Diagram I2 - 3-phase, 3-wire, 2 CTs**



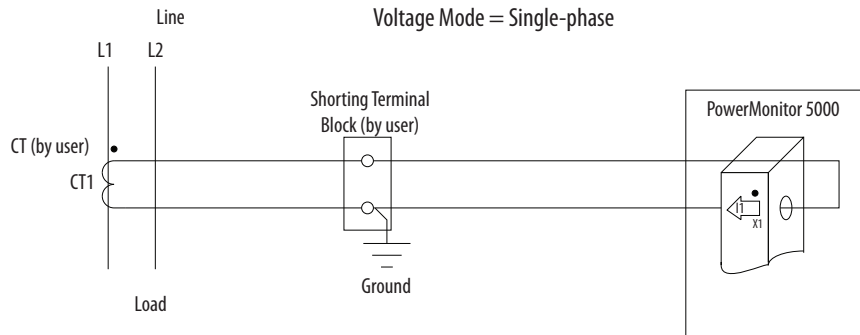
**Figure 18 - Diagram I3 - 3-phase, 3-, or 4-wire, 3 CTs**

Metering\_Mode = Wye, Delta 3 CT, Open Delta 3 CT,  
Delta Grd B Ph 3 CT, or Delta High-leg, as applicable



**Figure 19 - Diagram I4 - Single Phase, 1 CT**

Voltage Mode = Single-phase

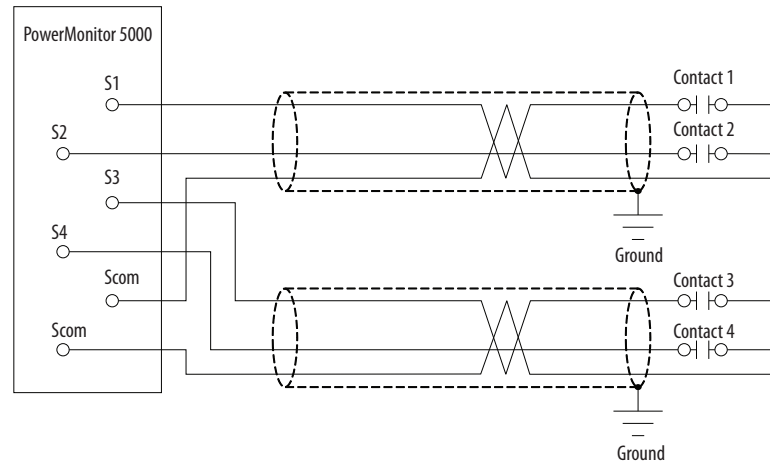


## Status Inputs

Up to four dry (non-powered) contacts can be connected to the PowerMonitor 5000 unit status inputs. The status input derives 24V DC power from its internal power supply.

Connect status inputs by using shielded, twisted-pair cable with the shield connected to the ground bus or other low-impedance earth ground at the contact end only. The diagram indicates typical status input wiring.

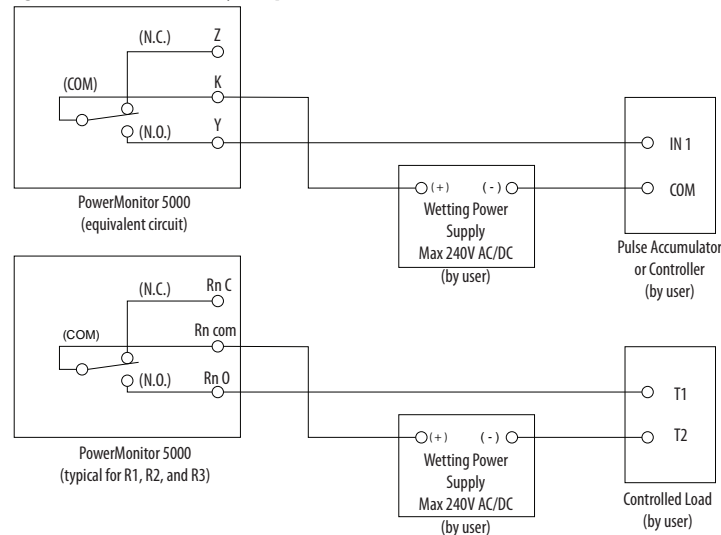
Figure 20 - Status Inputs



## KYZ and Relay Outputs

The KYZ solid-state relay output can be connected to an external pulse accumulator or controller. Relay outputs can be used for control of loads, switching of circuit breakers, signaling, and other applications. The external device or circuit must provide wetting voltage. The KYZ output is designed for low-current switching. The diagram indicates typical KYZ and relay output wiring.

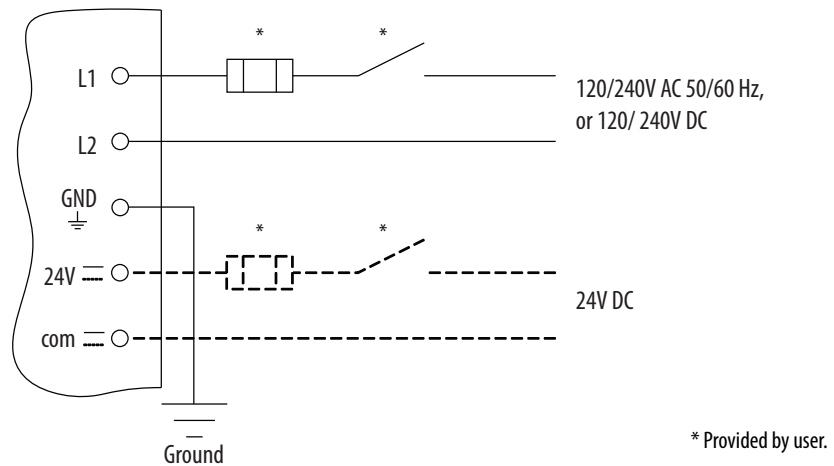
Figure 21 - KYZ and Relay Outputs



## Control Power

Connect the PowerMonitor 5000 unit to a source of 120/240V AC, 120/240V DC, or 24V DC (shown with dashed lines) control power through a user-provided disconnecting means, such as a switch or circuit breaker close to the power monitor. Provide overcurrent protection that is sized to help protect the wiring, for example, a 5 A rated fuse. Overcurrent protection is included in the 1400-PM-ACC accessory kit. The PowerMonitor 5000 unit is internally protected. Apply control power only after all wiring connections are made to the unit.

**Figure 22 - Control Power**



## Connect Communication

This section describes how to connect communication networks.

### USB Communication

The USB Device port can be used to create a temporary, point-to-point connection between a personal computer and the PowerMonitor 5000 unit. This connection is used for configuration, data monitoring, diagnostics, and maintenance by using the built-in web pages of the unit. The USB Device port is a standard USB Mini-B receptacle. Install drivers to enable USB communication.

To connect your personal computer to the PowerMonitor 5000 unit, use a standard USB cable with a Type-A and Mini-B male plugs, Allen-Bradley® catalog number 2711C-CBL-UU02 or equivalent.

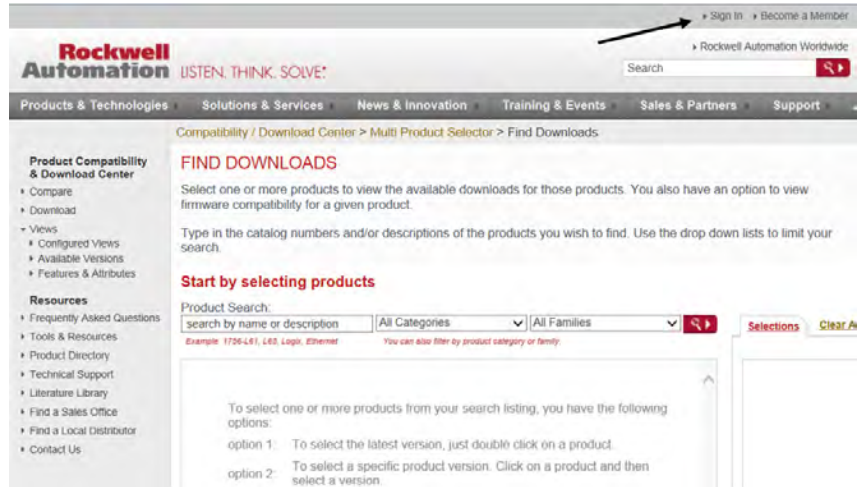
**TIP** You can also display the PowerMonitor 5000 web interface by using a PanelView™ Plus 6 terminal with a 2711P-RP9\_ logic module with extended features. USB communication drivers are already installed in the logic module.

See [Configure the Connection on page 41](#) to continue the setup.

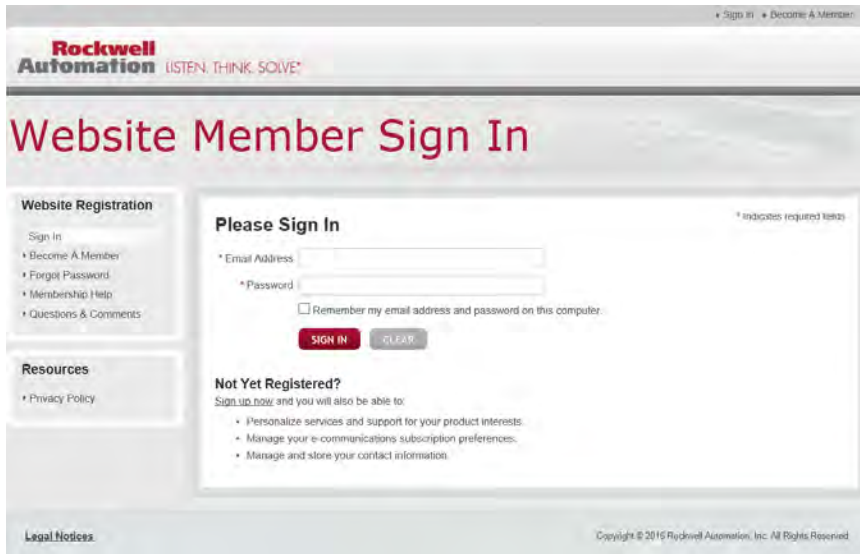
### Download the USB Driver

To download the USB driver, follow these steps.

1. Navigate to <http://compatibility.rockwellautomation.com/Pages/MultiProductDownload.aspx?crumb=112> and click sign in.

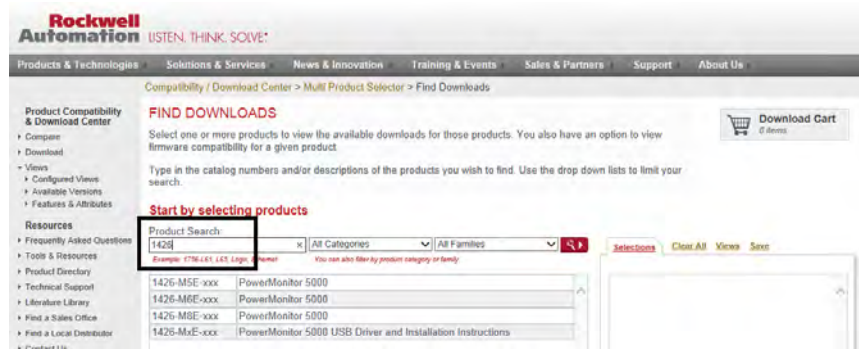


2. Enter your Email Address, Password, and click Sign In.

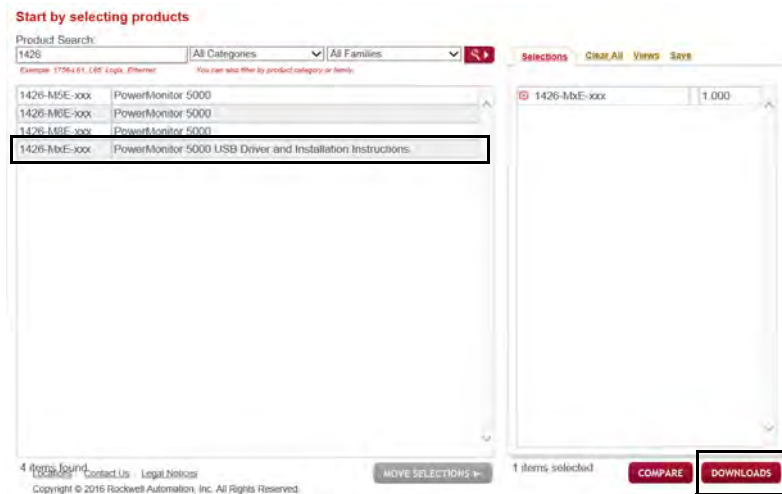




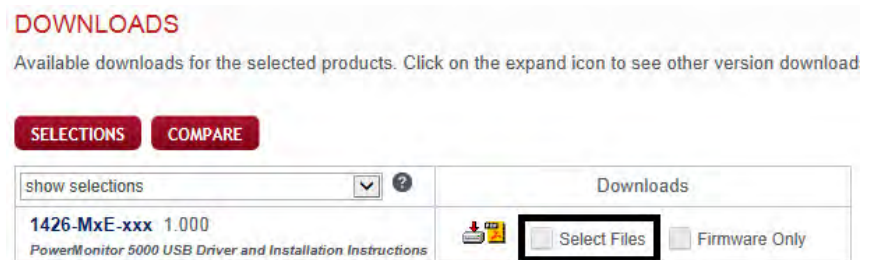
3. Enter 1426 in the Product Search window.



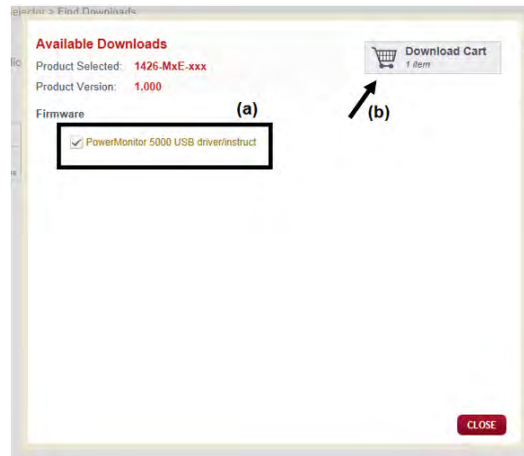
4. Select PowerMonitor 5000 USB Driver and Installation Instructions and then click Downloads.



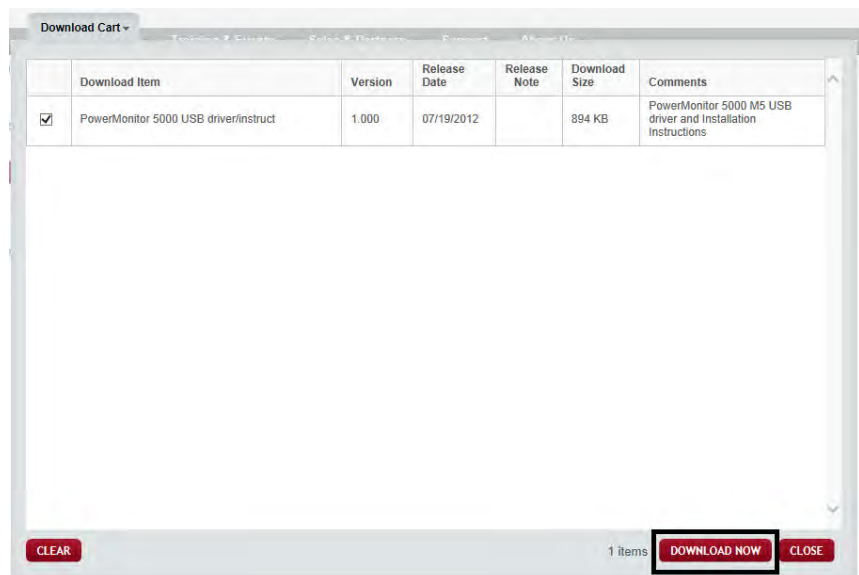
5. Click Select Files.



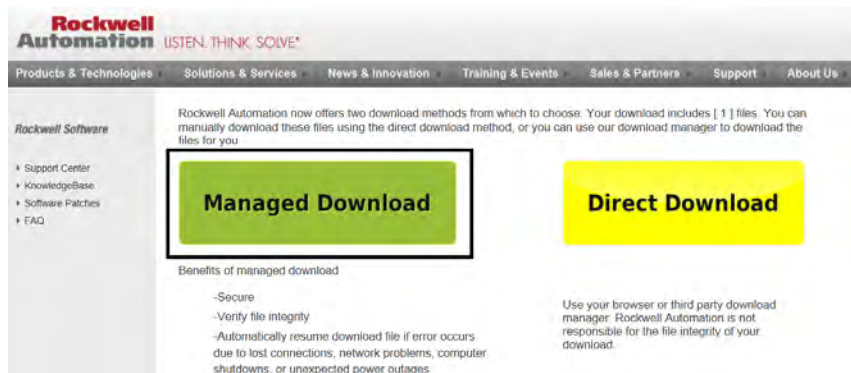
6. Select PowerMonitor 5000 USB driver/instruct (a) and click Download Cart (b).



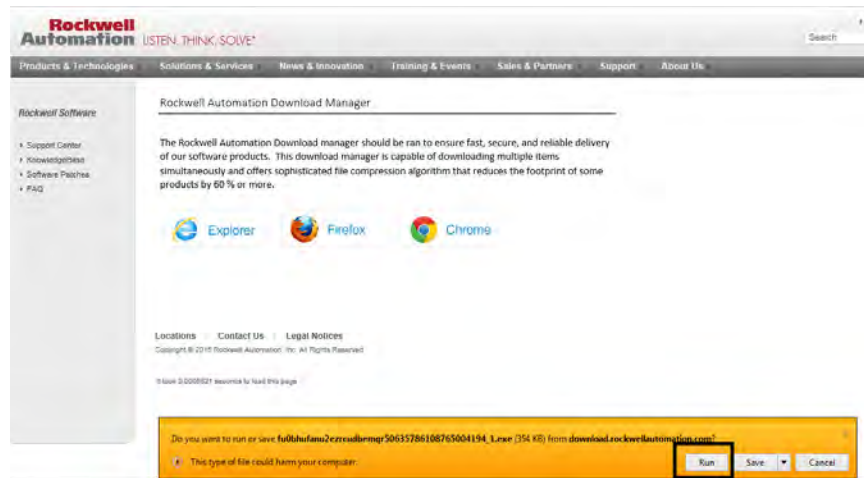
7. Click Download Now.



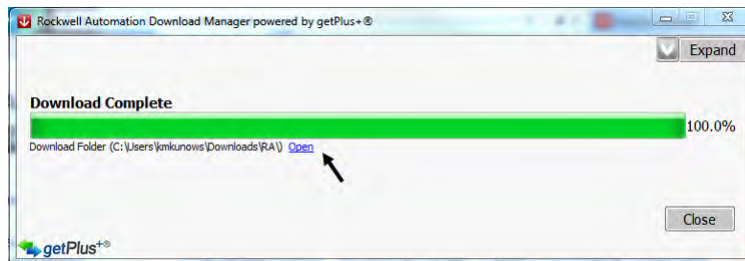
8. Read the End-User Software Agreement and click Accept.
9. Click Managed Download.



**10.** Click Run.

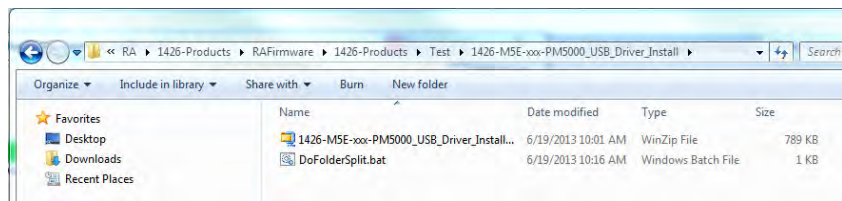


**11.** When download is complete, click Open under the green status bar.

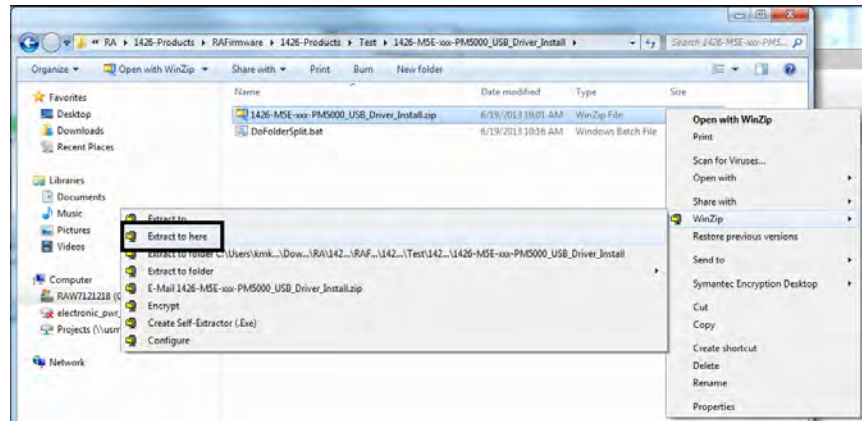


**12.** In the Windows Explorer window that opens, navigate to 1426-Products > RAFirmware > 1426-Products > Test > 1426-M5E-xxx-PM5000\_USB\_Driver\_Install.

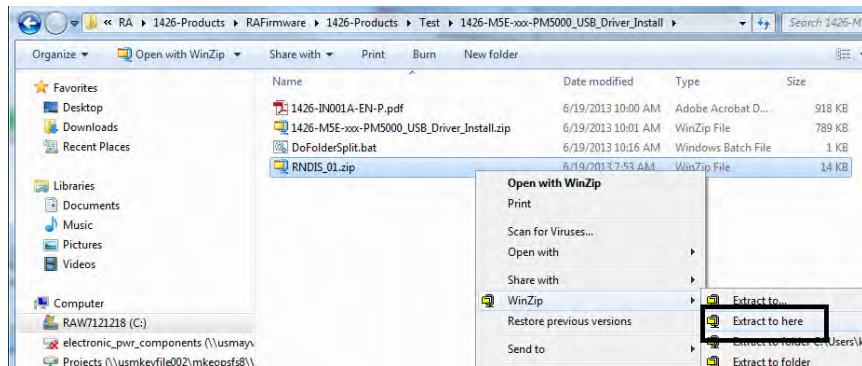
**TIP** The full path to access the file is: Downloads > RA > 1426-Products > RAFirmware > 1426-Products > Test > 1426-M5E-xxx-PM5000\_USB\_Driver\_Install.



- Right-click on the zipped folder and extract the files.



- Right-click on zipped folder RNDIS\_01.zip and extract files.



- Close the Rockwell Automation® Download Manager and sign out of RockwellAutomation.com.

### Install Drivers

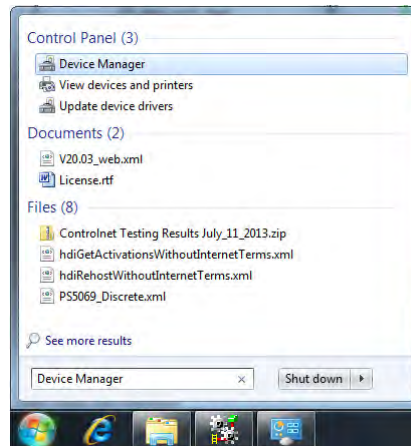
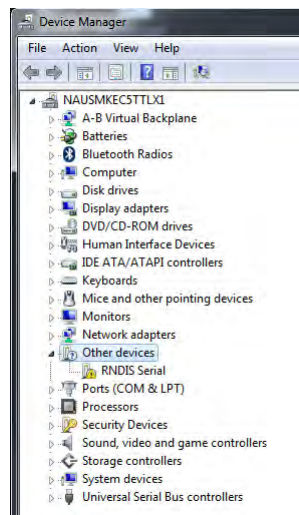
To install the USB driver, follow these steps.

The following procedure applies to the Windows 7 operating system. Installation and connection configuration steps vary with different operating systems.

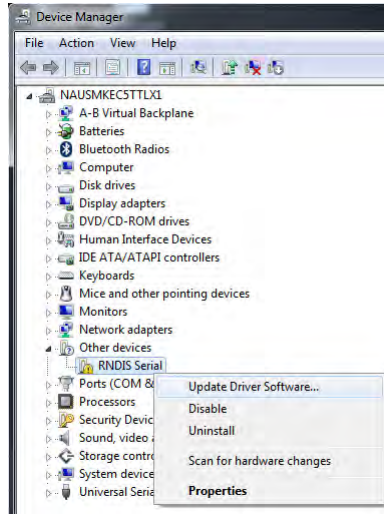
- Connect the PowerMonitor 5000 unit to your computer by using a USB cable and apply power to the power monitor.

If the device does not automatically install or fails to install, follow these steps.

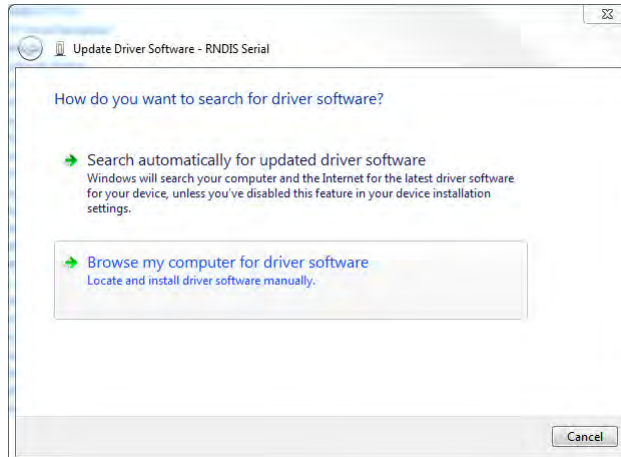
- Open the Start menu and search for Device Manager.

**3.** Click Device Manager to open.**4.** In Device Manager, open Other devices.

5. Right-click RNDIS Serial and select Update Driver Software.

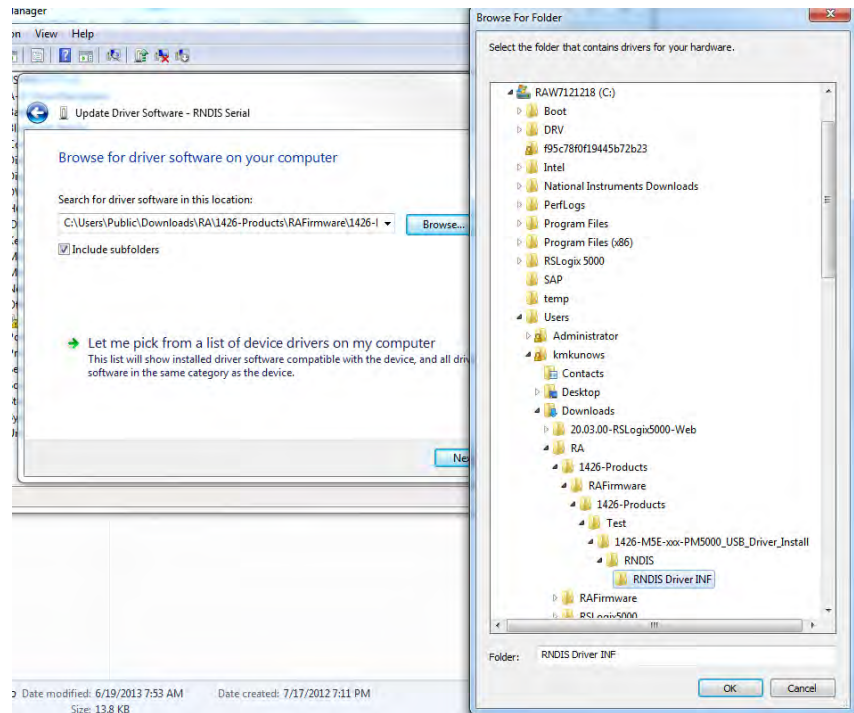


6. Select Browse my computer for driver software.

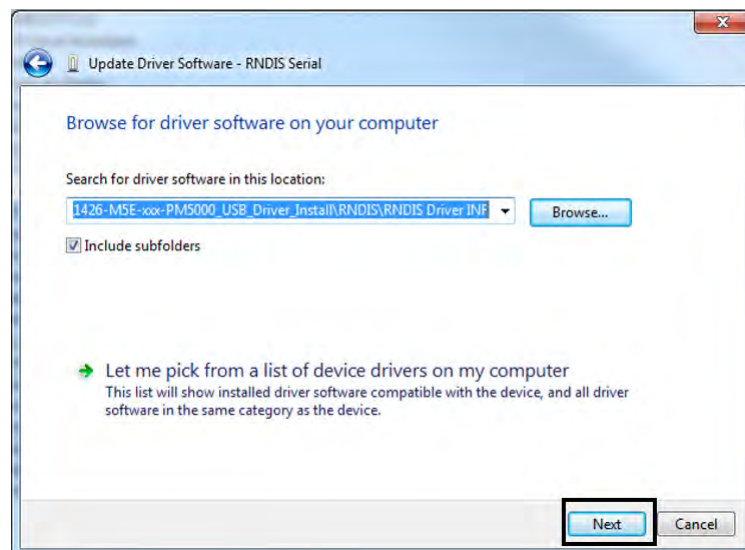


7. Click Browse and navigate to the RNDIS Driver INF folder and click OK.

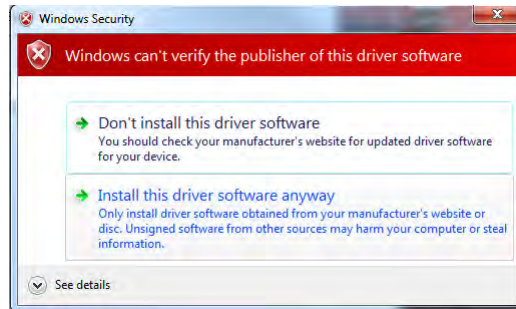
**TIP** The full path to access the file is: Downloads > RA > 1426-Products > RAFirmware > 1426-Products > Test > 1426-MSE-xxx-PM5000\_USB\_Driver\_Install > RNDIS > RNDIS Driver INF.



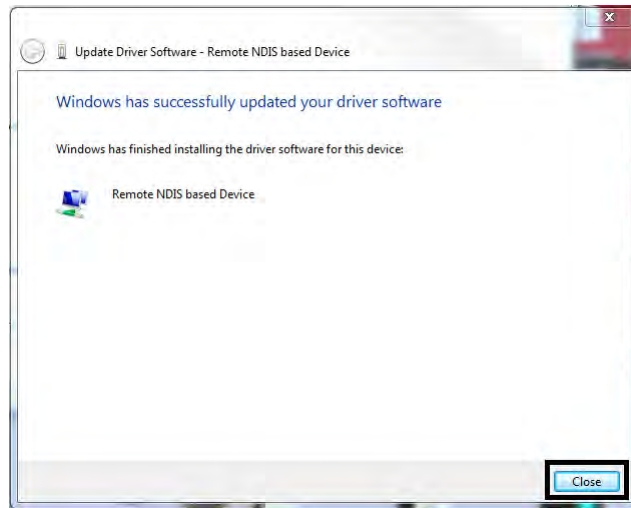
8. Click Next.



9. If a windows security window pops up, click 'Install this driver software anyway'.



10. When the driver successfully installs, click Close.

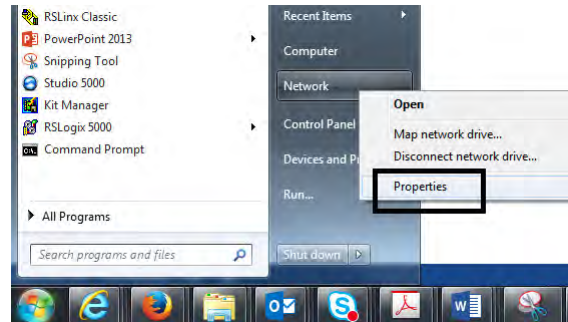




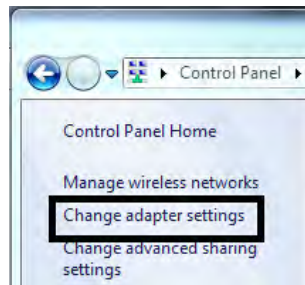
## Configure the Connection

To configure the connection, follow these steps.

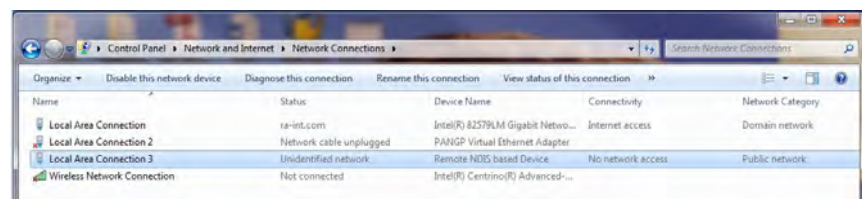
1. From the Start menu on your computer, right-click Network, and select Properties.



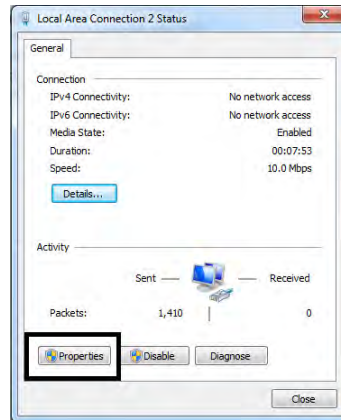
2. Click Change adapter settings.



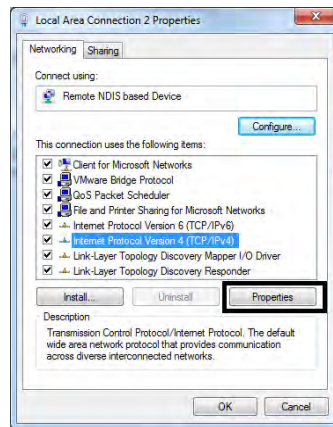
3. Verify that the PowerMonitor 5000 unit is connected to the personal computer by using the USB cable.
4. Double-click Local Area Connection that is associated with the Remote NDIS-based Device.



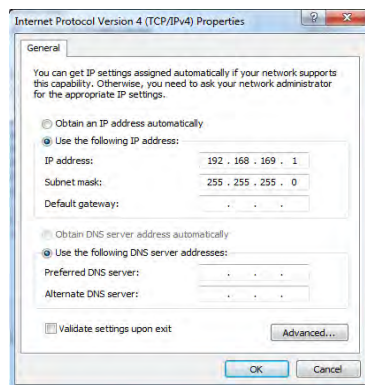
5. Click Properties.



6. Select Internet Protocol Version 4 (TCP/IPv4) and click Properties.



7. Select Use the following IP address, enter the IP address: 192.168.169.1.  
The default subnet mask 255.255.255.0 is correct. Note: The default IP address of the PowerMonitor 5000 unit is 192.168.169.3.



8. Then, click OK.

Your connection has now been configured and you can browse the PowerMonitor 5000 web page by using the USB connection.

### *Browse the PowerMonitor 5000 Web Page by Using the USB Connection*

Follow these steps to browse the PowerMonitor 5000 unit.

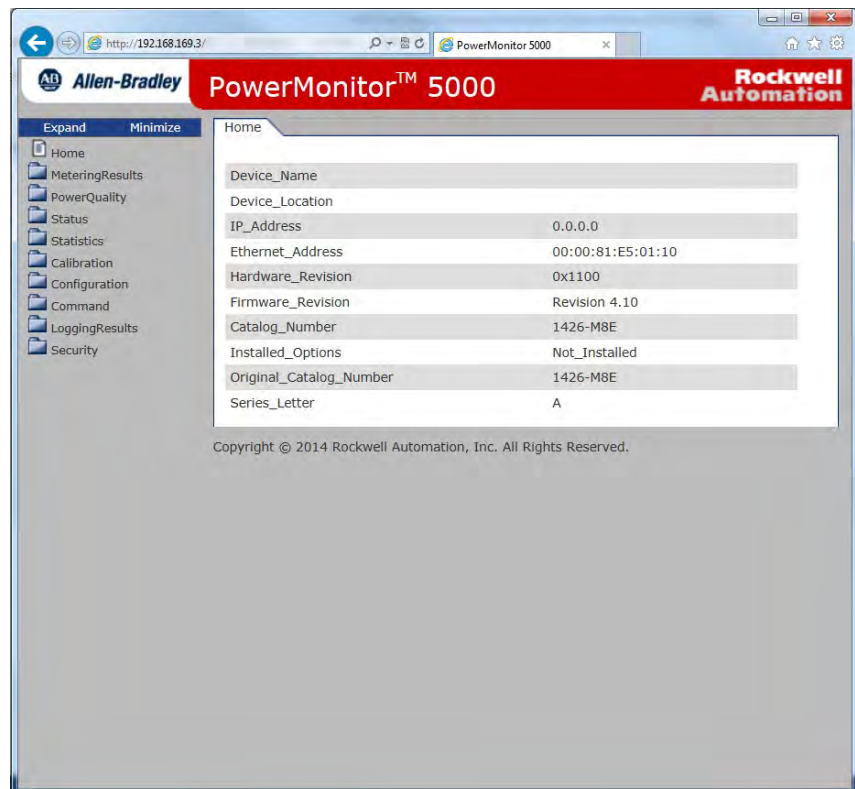
1. Open the Internet Explorer web browser on the computer and browse to the url <http://192.168.169.3>.

The PowerMonitor 5000 web page displays in your browser.

---

**IMPORTANT** Your browser must have Allow Scriptlets set to Enable for the applicable security zone for configuration changes to be made to the power monitor by using the web page.

---



By default the security setting of the power monitor web page is disabled.

2. To enable security, see [Configure Initial Security on page 56](#) for more information.

## Native Ethernet Communication

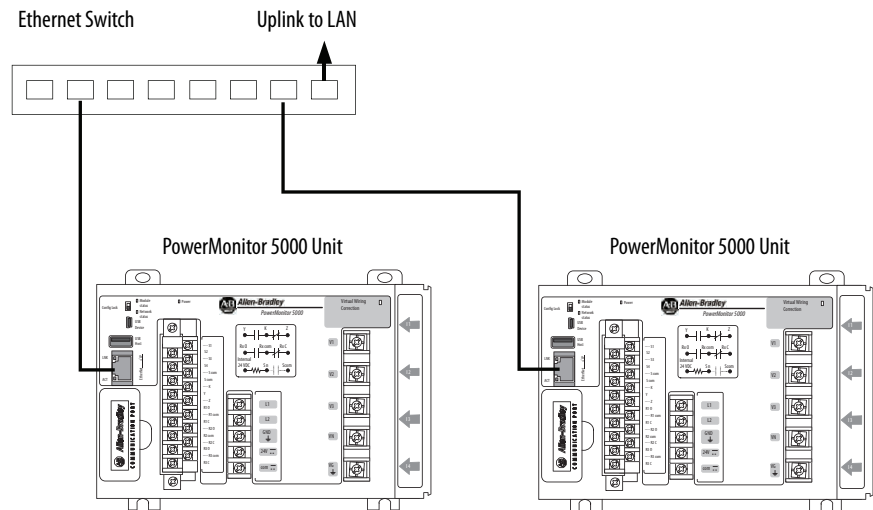
The PowerMonitor 5000 unit connects easily to industry-standard Ethernet hubs and switches by using standard CAT-5 UTP (unshielded twisted-pair) cables with RJ45 connectors. [Table 6](#) shows the cable and connector pin assignments.

**Table 6 - Cable and Connector Pin Assignments**

Terminal	Signal	Function
1	TX+	TX+
2	TX-	TX-
3	RX+	RX+
4		
5		
6	RX-	RX-
7		
8		

Typical Ethernet connections are shown in [Figure 23](#).

**Figure 23 - Typical Ethernet Connections**



## Optional DeviceNet Network Communication

An optional DeviceNet® port can be factory-installed in PowerMonitor 5000 units with a catalog number that end in -DNT, and can also be purchased from Rockwell Automation and installed by you.



**ATTENTION:** Power must be removed from the power monitor before inserting or removing an optional communication card. Inserting or removing an optional communication card under power can damage the card or the power monitor.

For information on the installing of the optional communication card, see the PowerMonitor 5000 Optional Communication Modules Installation Instructions, publication [1426-IN002](#).

For detailed DeviceNet system installation information, including cable lengths, the placement of terminating resistors, power supplies, and other media components, see the DeviceNet Cable System Planning and Installation Manual, publication [DNET-UM072](#).

Install suitable terminating resistors at the ends of the DeviceNet cable.

**IMPORTANT** You must install and wire a suitable 24V DC power supply to the V+ and V- conductors in the DeviceNet cable. The power monitor consumes less than 50 mA from the DeviceNet 24V DC supply.

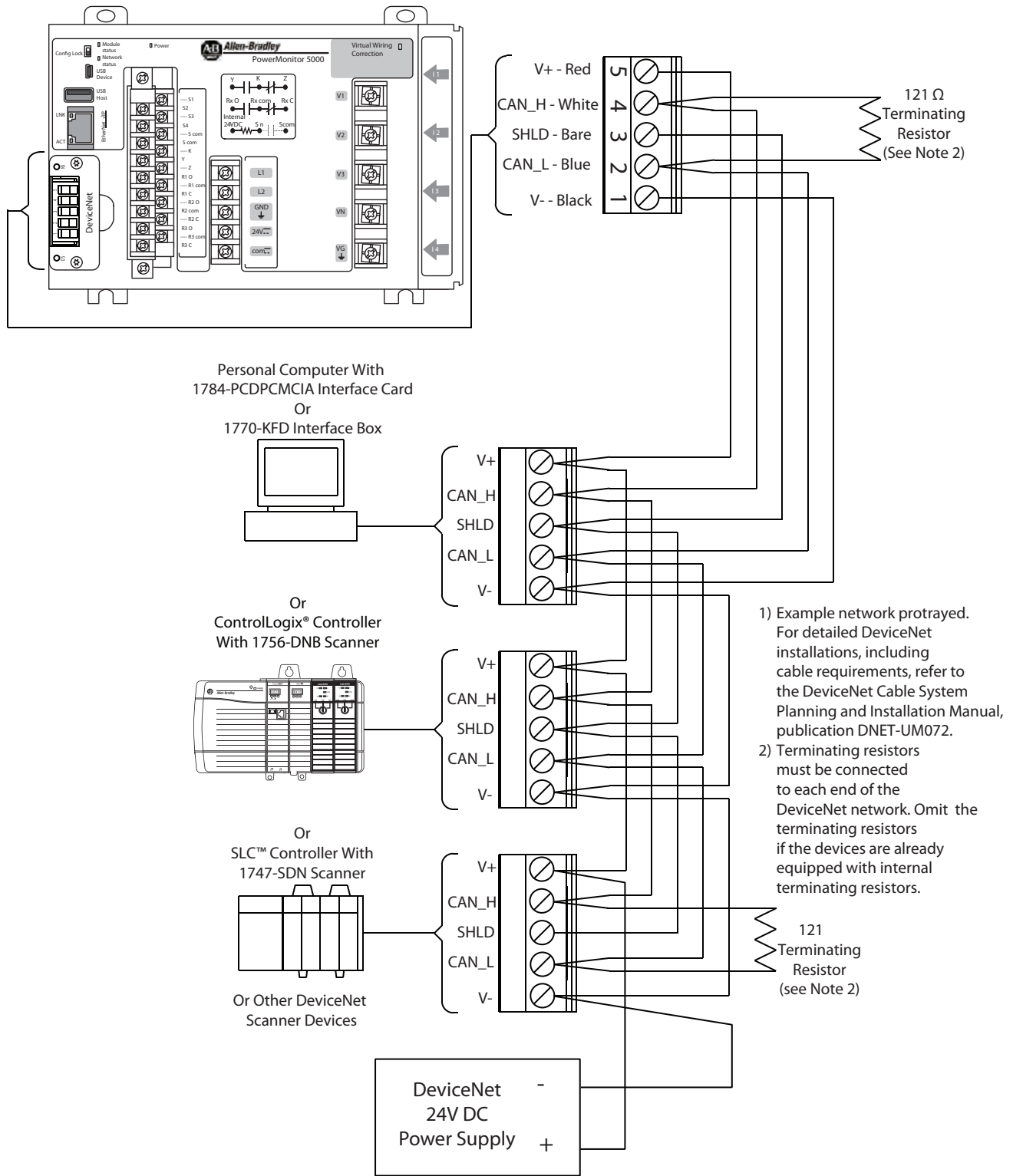
Configuration options for optional DeviceNet communication include the node address (MAC ID) and data rate. Defaults are node 63 Kbps and 125 Kbps.

**Table 7 - DeviceNet Terminal Block Wiring Connections**

Terminal	Signal	Function	Color
5	VDC+ (V+)	Power Supply	Red
4	CAN_H	Signal High	White
3	SHIELD	Shield	Uninsulated
2	CAN_L	Signal Low	Blue
1	COM (V-)	Common	Black

**IMPORTANT** Terminal numbers are listed as they appear on the connector.

Figure 24 - Connecting a PowerMonitor 5000 Unit to Other DeviceNet Devices



## Optional ControlNet Communication

An optional ControlNet® port can be factory-installed in PowerMonitor 5000 units with a catalog number that ends in -CNT, and can also be purchased from Rockwell Automation and installed by you.



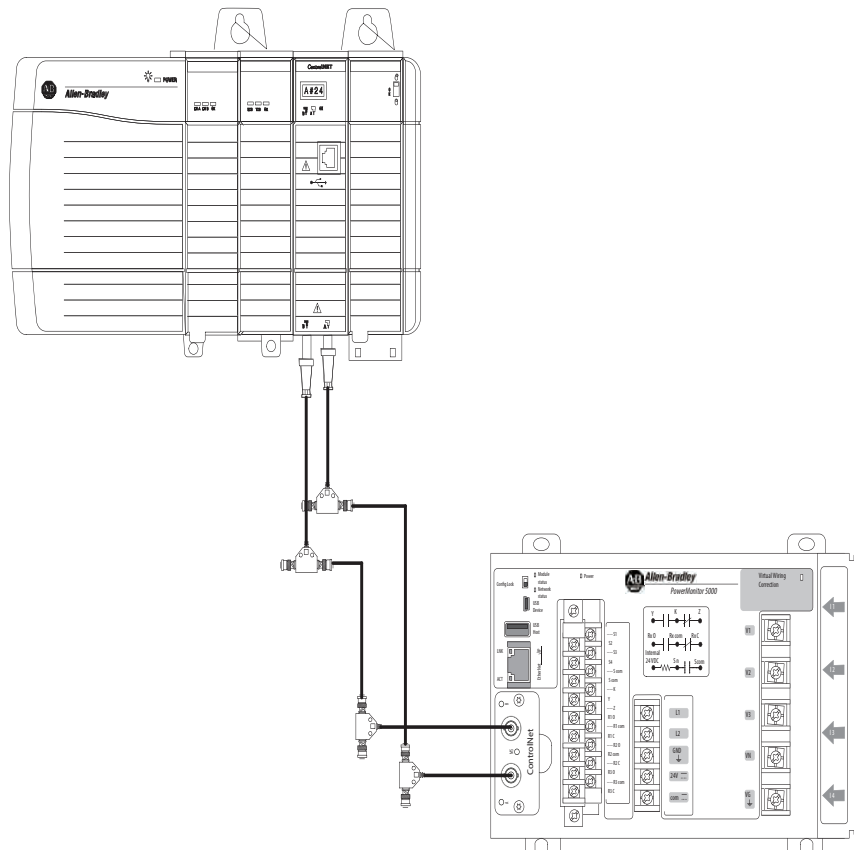
**ATTENTION:** Power must be removed from the power monitor before inserting or removing an optional communication card. Inserting or removing an optional communication card under power can damage the card or the power monitor.

For information on installing the optional communication card, see the PowerMonitor 5000 Optional Communication Modules Installation Instructions, publication [1426-IN002](#).

A ControlNet media installation includes trunk cable, taps and terminators, and can include optional redundant media. For detailed ControlNet system installation information, see the ControlNet Coax Media Planning and Installation Guide, publication [CNET-IN002](#), and the ControlNet Network Configuration User Manual, publication [CNET-UM001](#).

[Figure 25](#) shows a simple ControlNet network installation that uses redundant media.

**Figure 25 - ControlNet Network**



**Notes:**



## Setup and Commands

Although the PowerMonitor™ 5000 unit ships from the factory with default settings, you can configure the unit for your particular requirements. The PowerMonitor 5000 unit provides a built-in web interface for monitoring, configuration, and commands through its native Ethernet communication port and its USB device port. You perform initial configuration by using the power monitor built-in USB web interface. Once initial setup is complete, you can continue configuring the PowerMonitor 5000 unit by using its USB or network web interface, by using optional software, or by communicating with the power monitor data table.

This section describes how to use the USB and Ethernet Web interface for setup. You can find information on the configuration of various functions of the PowerMonitor 5000 unit in the following chapters:

- [Chapter 4, Metering](#).
- [Chapter 5 Power Quality Monitoring](#)
- [Chapter 6 Logging](#)
- [Chapter 7 Logic Functions](#)
- [Chapter 8 Other Functions](#)

If you are using optional software, such as FactoryTalk® EnergyMetrix™ software, see publication [FTEM-UM003](#), for information. If you are using data communication for setup, see [Communication on page 219](#) for information.

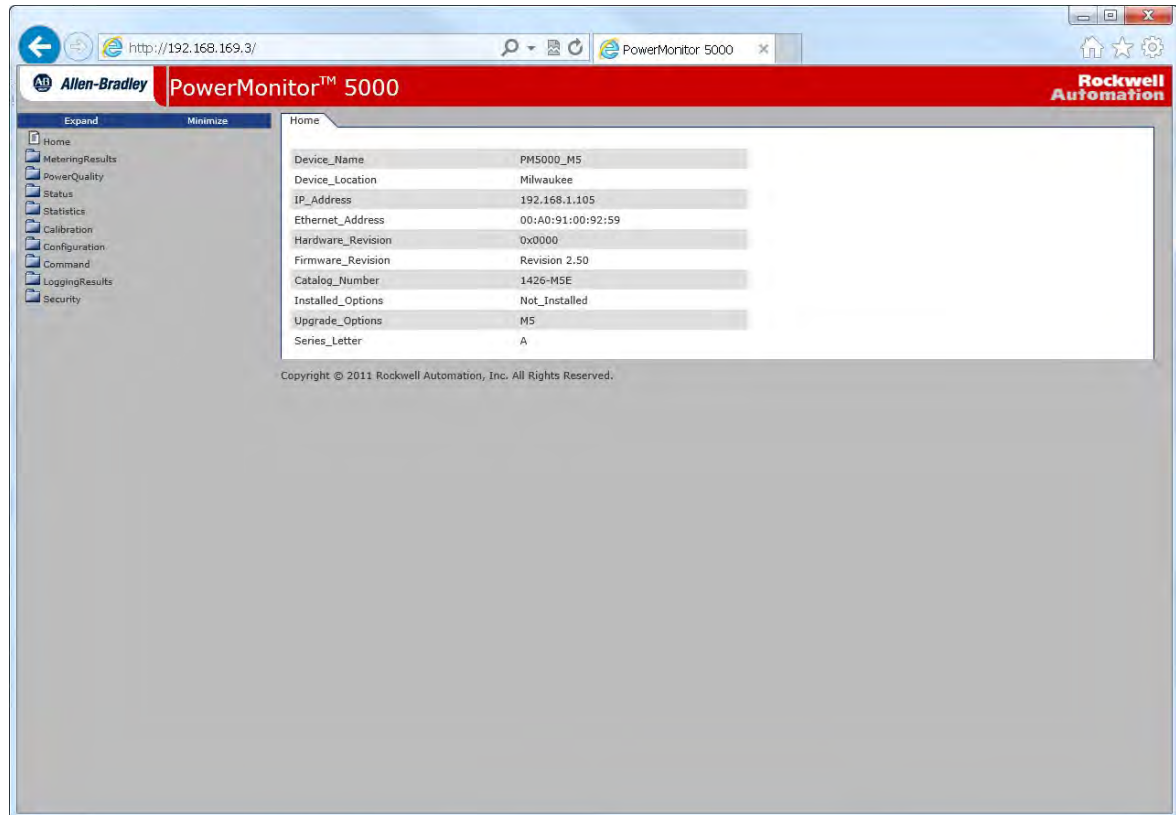
### Setup Using the Web Interface

For initial setup, connect a personal computer to the PowerMonitor 5000 unit by using a USB cable. See [USB Communication on page 31](#).

Initial setup is performed by using the USB web interface and initial security setup can be performed only by using the USB web interface.

Open the Internet Explorer browser and browse to <http://192.168.169.3>. The PowerMonitor 5000 home page displays in your browser as shown in [Figure 26](#). The home page displays general information about the PowerMonitor 5000 unit. You can navigate by clicking folders and pages from the tree on the left.

**Figure 26 - PowerMonitor 5000 Home Page**



Initial setup by using the USB web interface includes at least the following configuration steps:

- Basic Metering - this feature aligns the power monitor metering functionality with the properties of the circuit to which the unit connects
- Wiring Diagnostics and Wiring Correction (if needed) - this feature assesses the wiring of the unit and makes corrections without changing the wiring
- Native Ethernet Network Communication - this feature permits access to the unit for data monitoring and setup through an Ethernet network
- Optional Communication - this feature permits access to the unit for data monitoring and setup through an optional communication card
- Date and Time - this feature sets the unit internal clock so that time stamps in logged data are correct
- Security (if desired) - enable and configure security to guard against unauthorized changes to the power monitor configuration

Once initial setup has been completed, including configuration of the IP address, you can also access the web interface from a computer that is connected through a network to the PowerMonitor 5000 unit native Ethernet port. Open the Internet Explorer browser and browse to the IP address of the unit.

## How to Obtain Access to the Configuration Pages

The PowerMonitor 5000 unit initially has security that is disabled by default. If your power monitor security is disabled, you can continue configuring the unit without logging in.

### *If Security Is Enabled*

If security is enabled, the web page header displays 'Logged in as:' and a Log in link.



If security is enabled, log in as an administrator to configure setup parameters. If not logged in as an administrator, you can view, but not change, configuration parameters. If login is required, click the Log in link.

The USB connection has a special administrator account. Follow these steps to log in with this account.

1. Type in the user name usbadmin.
2. Type in the password usbadmin.
3. Click Log In.

A dialog box reports the result.

To log in from the network web interface, select a previously configured administrator account user name and password. The PowerMonitor 5000 unit does not permit logging in with the USB administrator login from the network.

You remain logged in until you log out or until 30 minutes have passed since configuration changes have been applied.

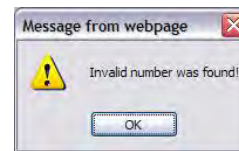
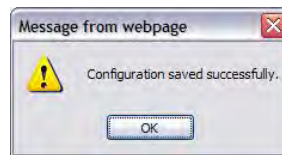


## How to Configure the PowerMonitor 5000 Unit

From any power monitor web page, click the Configuration folder. A list of available configuration pages is displayed in the tree. The steps to enter, edit, and apply configuration parameters are similar for each configuration page. The configuration parameters and their properties are described in the following chapters:

- [Chapter 4, Metering.](#)
- [Chapter 5 Power Quality Monitoring](#)
- [Chapter 6 Logging](#)
- [Chapter 7 Logic Functions](#)
- [Chapter 8 Other Functions](#)

The configuration pages contain text boxes to enter parameter values, pull-down menus for selecting enumerated parameter values, and an Apply Changes button to apply changes to the power monitor. The power monitor checks that parameter values are within their valid range before applying them. A dialog box appears to report the success or reason for failure of an attempt to apply new parameters.



### *Basic Metering Setup*

Follow these steps to configure the basic metering parameters.

1. Click the Metering\_Basic page under the open Configuration folder.

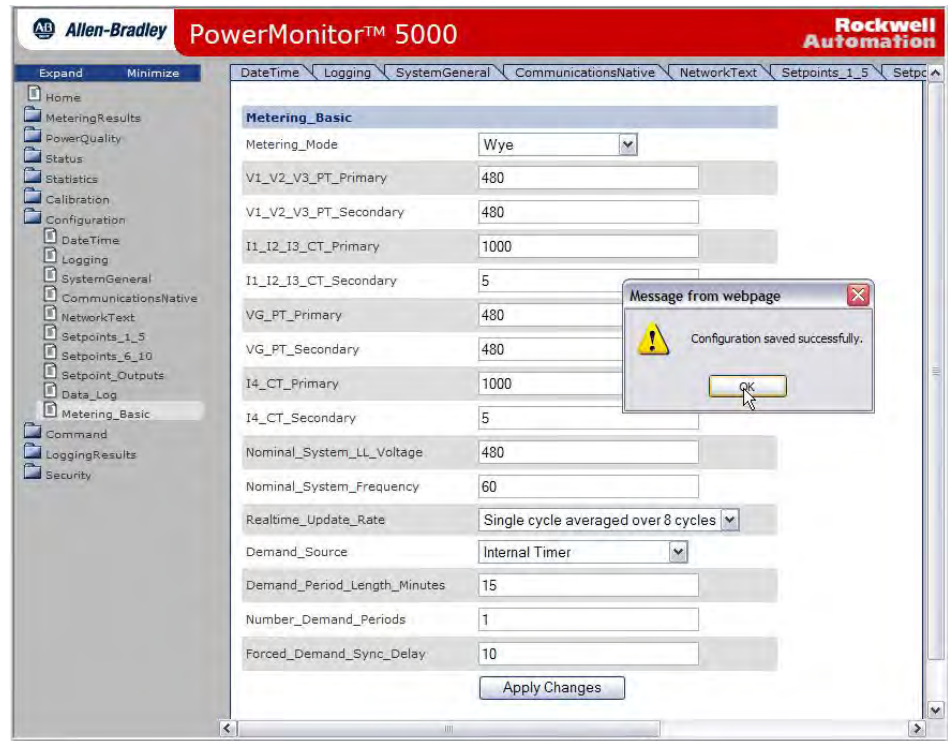
This page displays the existing basic metering configuration of the power monitor, including the metering mode, PT (VT), and CT ratios, nominal voltage and frequency, and demand.

You can select other configuration pages by clicking the desired page in the tree, or by clicking the corresponding tab in the page.

2. To change the basic metering setup, enter the desired values into the text boxes, scroll down, and click Apply Changes.

A dialog box appears to report the result of the setup change.

**EXAMPLE** This Metering\_Basic page illustrates the setup for a 480V, 3-phase system with 1000:5 current transformer (CT) ratios on all phases and the neutral.



### Native Ethernet Communication Setup

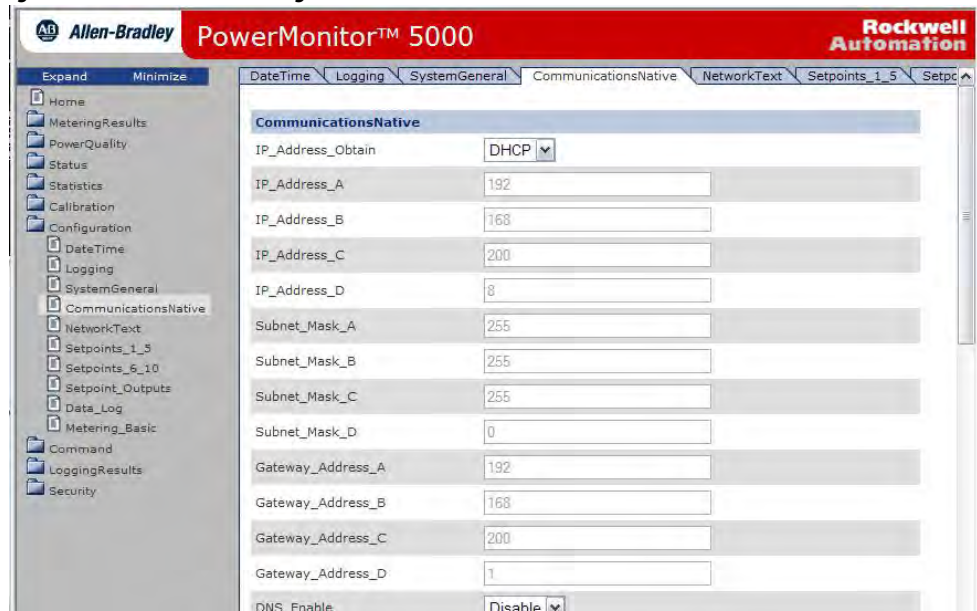
Choose the Configuration folder and choose the CommunicationsNative page. The PowerMonitor 5000 unit is designed by default to obtain an IP address automatically from a DHCP (Dynamic Host Configuration Protocol) server. If your power monitor is on a network that is served by a DHCP server, and the power monitor is connected to the network, the power monitor has probably already been assigned an IP address.

We recommend that each power monitor is assigned a static, or fixed, IP address, because DHCP addresses can change from time to time, which results in loss of communication with client applications. Obtain a fixed IP address, subnet mask, default gateway, and other network setup parameters from your network administrator. Another option can be to configure the power monitor as a reserved client in the DHCP server.

Refer to [Communication on page 219](#) for more information on communication setup parameters.

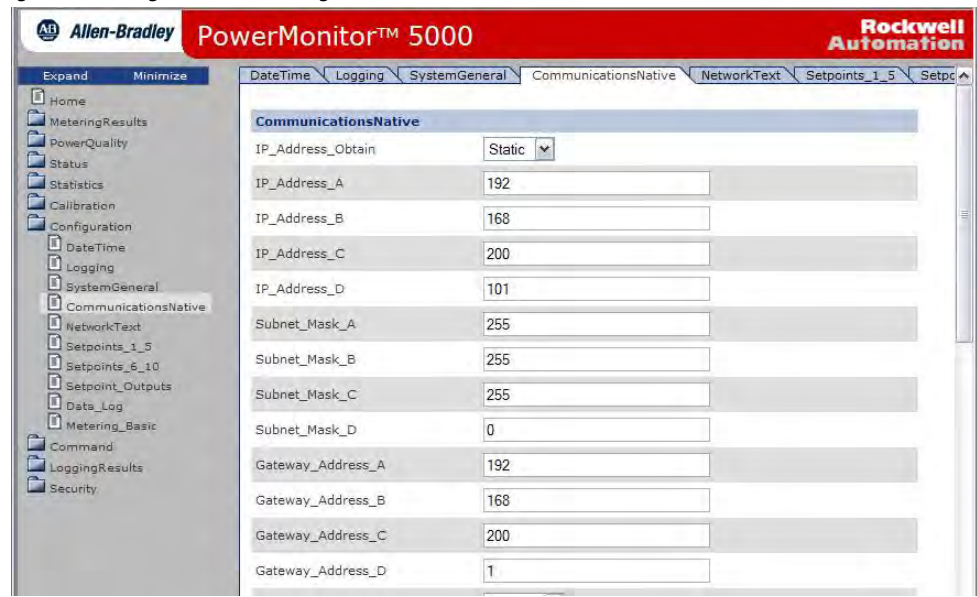
**EXAMPLE** This example explains how to change from a DHCP-assigned to a static IP address. The initial network configuration is shown in [Figure 27](#). The IP address that is assigned is 192.168.200.8. The network administrator has provided a range of static IP addresses in the same subnet, which begin with 192.168.200.100. In this case, the default gateway and DNS servers remain the same for static or DHCP-obtained addresses (verify if this method is true in your case with your network administrator).

**Figure 27 - Initial Network Configuration**



To change the new address, from the IP\_Address\_Obtain pull-down menu choose Static, type in the new IP address, and click Apply Changes.

**Figure 28 - Changed Network Configuration**



**IMPORTANT** You can change the network configuration from the USB or network web pages. If you change the IP address from the network web interface, browse to the new IP address to re-establish communication.

### *Optional DeviceNet Communication Setup*

Choose the Configuration folder and choose the OptionalComm page, which lets you set the address and communication rate to operate in your system. The range for DeviceNet\_Address is 0...63 (default). The selections for DeviceNet\_Baudrate are the following:

- 0 = 125 Kbps (default)
- 1 = 250 Kbps
- 2 = 500 Kbps
- 3 = Autobaud

Refer to [Optional DeviceNet Communication on page 221](#) for more information on optional DeviceNet® communication parameters.

---

**IMPORTANT** You can also configure or change the DeviceNet port parameters by using RSNetWorx™ for DeviceNet software or similar utilities.

---

### *Optional ControlNet Communication Setup*

Choose the Configuration folder and then choose the OptionalComm page. The ControlNet® address is the only configurable parameter. The default is 255.

### *Configure Date and Time*

Follow these steps to set the date and time.

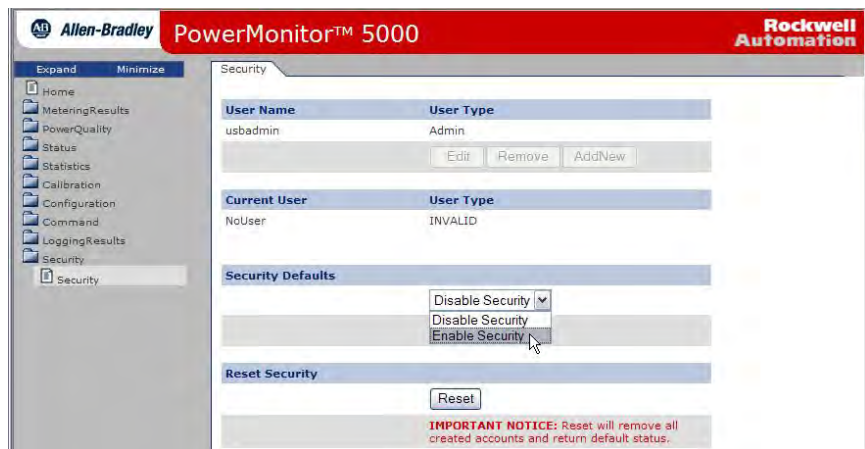
1. Choose the Configuration folder and choose the DateTime page.
2. Enter the year, month, day, hour, and minute into the corresponding input fields and click Apply Changes.

If your power monitor is configured for time synchronization with either an SNTP or IEEE 1588 PTP server, the time is already set.

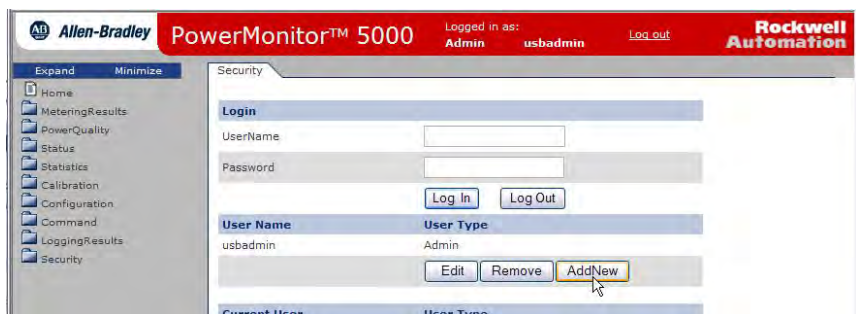
### Configure Initial Security

If you choose to enable security on the power monitor, you must perform the initial security configuration by using the USB web interface.

1. In the USB web page, choose the Security folder and then the Security page.
2. From the Security Defaults pull-down menu, choose Enable Security.



3. Accept the prompt regarding whether to enable security and accept the prompt to reload the web pages.
4. Log in with user name usbadmin and password usbadmin.
5. Accept the prompt that the login was successful.
6. To add a network administrator, click AddNew.





7. Enter a username and password for a network administrator.

The username and password can be any string up to 32 characters in length. This example sets a username of admin with a password of admin. Make a note of the new network administrator login for future use and keep that note in a secure location.

Current User	User Type
usbadmin	Admin

Add New	
User Name	admin
User Type	Admin
Password	.....
Confirm Password	.....
Apply	

Now that the network administrator user has been created, you can continue configuring the PowerMonitor 5000 unit by using the USB web page or by connecting through the native EtherNet/IP™ port and by using the network web interface. This configuration includes the ability to configure additional users, administrators, and application security accounts. Only one administrator class user can be logged in at a time. Be sure to log out when finished editing the unit configuration.

To use security with optional communication, create an application class account by using the USB or Ethernet web page. Security cannot be configured by using optional communication. DeviceNet communication uses application class security, which requires a client application to write the username and password by using Explicit Messaging before writing configuration and commands or reading logged data.

### Test Security

To test the network administrator login, follow these steps.

1. Browse to the network address of the PowerMonitor 5000 unit.
2. Click Log in from the page header and enter the user name and password that is created and click Log In.

User Name	User Type
usbadmin	Admin
admin	Admin

Only the USB web interface can be used to enable, disable, or reset security. If security accounts are lost or forgotten, connect to the USB web interface and log in with the usbadmin account to create network security accounts.

### *Configuring the Remaining Functions of the PowerMonitor 5000 Unit*

The remaining functions are configured in the same way as the examples discussed in this section. This manual lists configuration parameters and options for basic metering, communication, and other functions and features of the PowerMonitor 5000 unit in these chapters:

- [Metering on page 71](#)
- [Power Quality Monitoring on page 93](#)
- [Logging on page 111](#)
- [Logic Functions on page 183](#)
- [Other Functions on page 209](#)

## Commands

Commands let you instruct the power monitor to take various pre-defined actions. Two specialized classes of commands are the following:

- Controller interface command, which allows a controller to provide a demand end-of-interval signal. The use of this command is described in [Demand Metering on page 83](#)
- Wiring corrections commands, which allow you to correct wiring errors virtually. Wiring corrections commands are described in [Wiring Correction on page 78](#)

A third, more general class of commands, is composed of system register commands. These commands can clear or set energy and status counters, force outputs, clear logs, reset the unit, and restore defaults. They can be initiated by using the web page, optional software, or communication. If security is enabled, a logged-in Administrator class user can initiate commands by using the web page; or a logged-in Application class user can initiate commands by using optional software or communication.

The [Command.System\\_Registers](#) data table, on [page 368](#), is the command interface. The value that is written into Command Word One or Command Word Two identifies the command to be executed. The commands in Command Word One are disabled if Configuration Lock is active. Some commands require additional values to be written to specified elements of the [Command.System\\_Registers](#) data table. For example, a value of 18, Clear Setpoint Logic Gate Accumulators, uses the value of Command.System\_Register data table element 3 to determine which logic gate accumulator to clear. The power monitor ignores data table element values that are not associated with a command. The power monitor rejects any attempt to select commands from both Command Word One and Two simultaneously.

---

**IMPORTANT** The commands in Command Word One are disabled if an I/O connection is active and the configuration instance exists in the Studio 5000 Logix Designer application.

---

Chapters [4...8](#) provide additional detail on commands associated with power monitor functions.

## Setup Using Custom Add-on Profile

The Studio 5000® environment is used to configure I/O messaging between a Logix controller and a PowerMonitor 5000 unit. An Add-on Profile is available for the PowerMonitor 5000 unit and can be used with Studio 5000 software, version 20 and later. The PowerMonitor 5000 unit Add-on Profile provides a graphical user interface to modify configuration parameters, create intuitive input and output tag names, and enables Automatic Device Configuration.

Automatic Device Configuration automatically allows the Logix controller to manage device configuration data. Each time the Logix controller establishes a connection with a device, the Logix controller downloads that configuration data to the device. This download lets you save commissioning time by preprogramming a device offline by using RSLogix 5000® or Studio 5000 software. Automatic Device Configuration is enabled by default in the PowerMonitor 5000 Add-on Profile.

If you have a preconfigured PowerMonitor 5000 unit, or if you wish to configure your unit by using the web interface, software, or Explicit Messaging, the AOP gives you the option to disable Automatic Device Configuration. In the module definition, the configuration method can be set to one of the following options:

- This Controller - Configure the unit by using the Module Properties dialog box in RSLogix 5000 software. This option is the default setting.
- External Means - Configure the unit by using the web interface, software, Explicit Messaging, or other means. The Module Properties dialog box does NOT display subcategories specific to the device configuration. Additionally, the connection type does **not** contain a configuration instance. This option effectively disables Automatic Device Configuration.

See [Controller Applications: Class 1 Connection on page 242](#) for more information regarding the AOP connection types.

You can download the PowerMonitor 5000 Add-on Profile from:  
<http://compatibility.rockwellautomation.com/Pages/MultiProductDownload.aspx?crumb=112>

See [Appendix J](#) for download and install instructions.

---

**IMPORTANT** The PowerMonitor 5000 unit must have firmware revision 4.010 or later to support the use of the Custom Add-on Profile in Studio 5000 environment. Firmware downloads can be found at <http://compatibility.rockwellautomation.com/Pages/MultiProductDownload.aspx?crumb=112>.

---

After you install the PowerMonitor 5000 Add-on Profile, you must configure the Add-on Profile. The Logix Designer application can be online or offline when you create a PowerMonitor 5000 module.



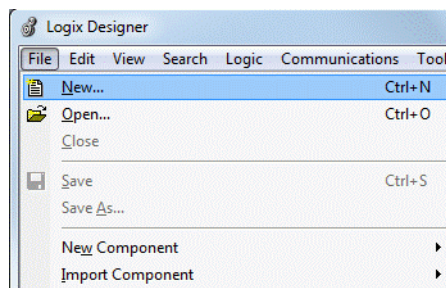
**ATTENTION:** The PowerMonitor 5000 Add-on Profile for Studio 5000 environment enables Automatic Device Configuration by default. When Automatic Device Configuration is enabled, the Logix controller overwrites any existing PowerMonitor 5000 configuration data when the Logix controller establishes a connection to the PowerMonitor 5000 unit.

---

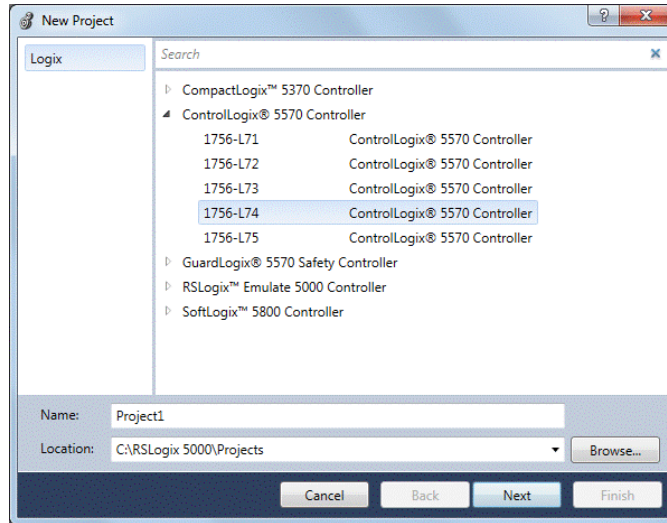
## PowerMonitor 5000 Unit Integration with Add-on Profile

The following is an example of how to add and configure the PowerMonitor 5000 unit in a new Logix project offline. An offline configured PowerMonitor 5000 unit can be quickly copied and pasted to configure multiple PowerMonitor 5000 units.

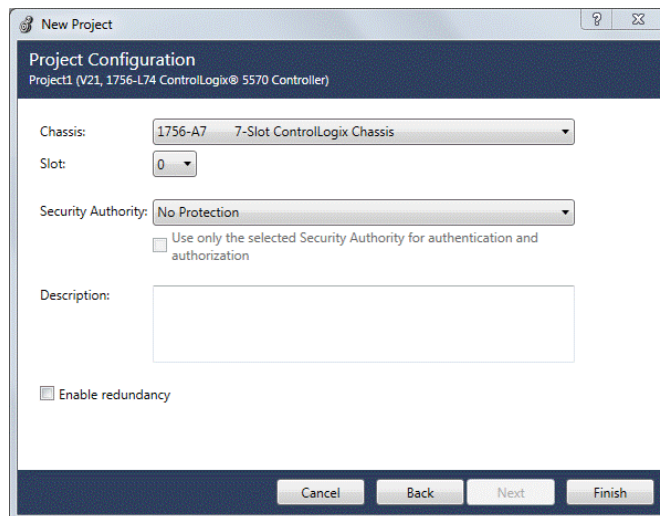
1. Open the Logix Designer application.
2. From the File menu, choose New.



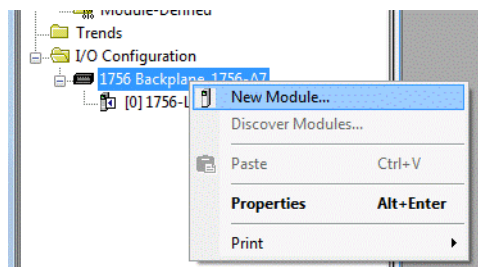
3. Select the controller type and set the project name and location.
4. Click Next.



5. Select the controller information and click Finish.

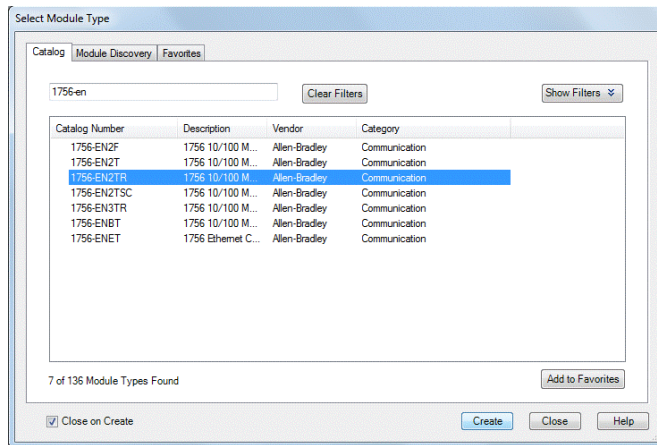


6. Under the I/O Configuration tree, right-click the 1756 Backplane, and choose New Module.



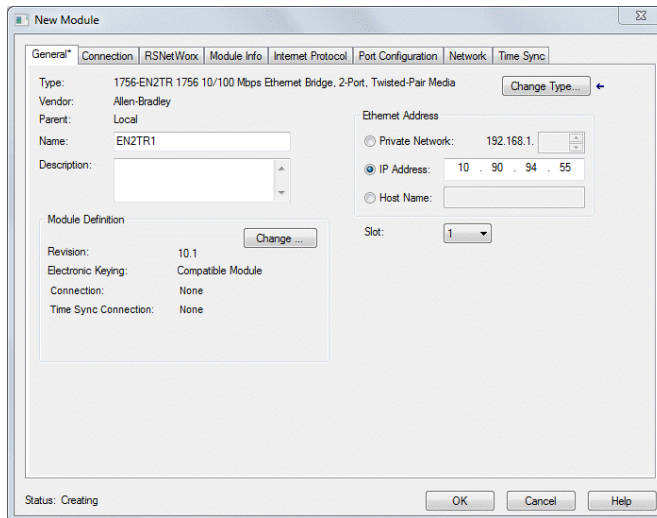
The Select Module Type dialog box appears.

- Choose the EtherNet/IP communication module that is correct for your controller and click Create.

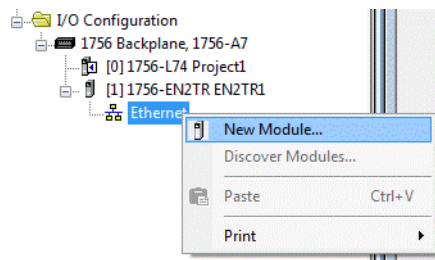


The New Module configuration dialog box appears.

- Configure the Ethernet communication module, and click OK.



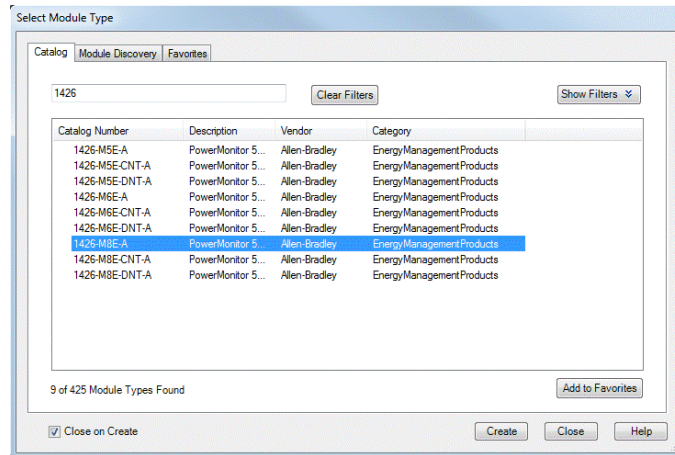
- In the I/O Configuration folder, right-click Ethernet and choose New Module.



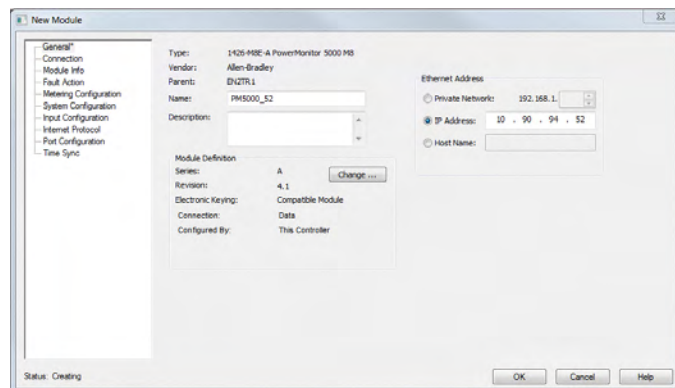
The Select Module Type dialog box appears.

10. Select the PowerMonitor 5000 module that corresponds to the catalog number of your PowerMonitor 5000 unit, then click Create.

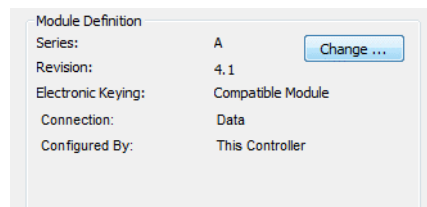
In this example, the module is created for a 1426-M8E device.



11. Enter a name and the IP address for the PowerMonitor 5000 module. The name creates tags in RSLogix 5000 or Studio 5000 software that can be used to read and write data from the PowerMonitor 5000 module.



12. In the Module Definition section, click Change.



The Module Definition dialog box appears.

13. Set the Connection and Configured By selections to the appropriate settings for your application.

---

**IMPORTANT** The default module definition settings for 1426-MxE catalog numbers automatically enables Automatic Device Configuration. When a connection is established, the controller overwrites any existing configuration settings of the PowerMonitor 5000 unit. If you do not wish to allow automatic delivery of the configuration instance by the controller, set the Connection to Data and Configured By to External Means.

---



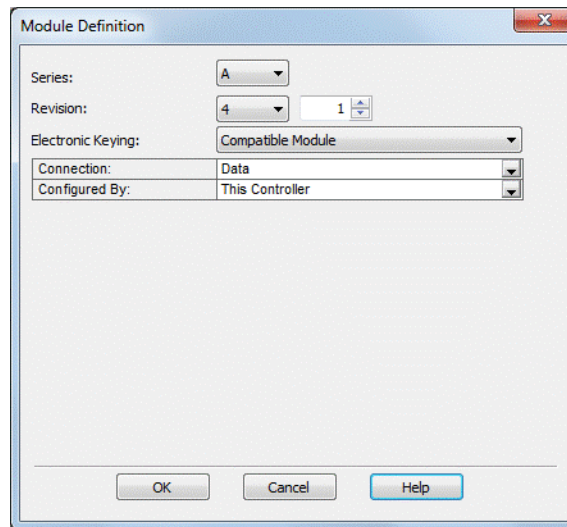
---

**IMPORTANT** Catalog numbers that end in -CNT or -DNT are only permitted to have an Input Only connection type.

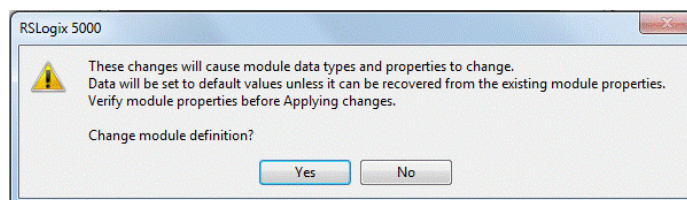
---

See [Controller Applications: Class 1 Connection on page 242](#) for more information.

In this example, the Connection and Configured By fields are left at the default selections of Data and This Controller.

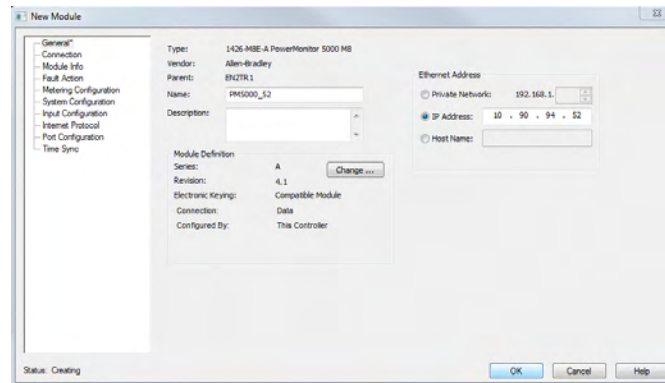


14. To save and close the Module Definition dialog box, click OK.
15. If prompted, click Yes to change the module definition.

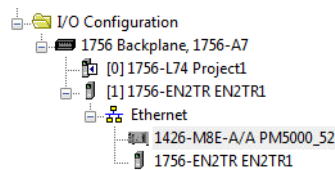




16. To create the module, click OK.



The PowerMonitor 5000 module has been created and added to the I/O tree of the Studio 5000 project and the three controller tags have been added: the input instance, the output instance, and the configuration instance.



Controller Tags - Project1(controller)							
Scope: Project1		Show: All Tags		Enter Name			
Name	Value	For	Style	Data Type	Constant		
PM5000_52.C	{...}	{..}		AB:1426_M8.C:0	<input type="checkbox"/>		
PM5000_52.I	{...}	{..}		AB:1426_M8.I:0	<input type="checkbox"/>		
PM5000_52.O	{...}	{..}		AB:1426_M8.O:0	<input type="checkbox"/>		

## Device Setup

You must configure the PowerMonitor 5000 unit for the unit to meter and function properly. Configuration pages in the module set-up dialog box divide the required information into subcategories. Evaluate the system and application and determine the appropriate configuration settings, select the applicable configuration page from the navigation tree, and use the configuration pages to enter the settings.

### *Applying the Configuration to the PowerMonitor 5000 Unit*

The Module Properties configuration pages provide a simple way for you to enter and edit PowerMonitor 5000 unit configuration parameters. Changes that you make to the configuration are not always immediately sent to the unit. The configuration data is stored in the configuration controller tag, [ModuleName]:C.

Configuration data from the Configuration tag is written automatically to the PowerMonitor 5000 unit when one of the two conditions occurs:

- A connection is first established to the PowerMonitor 5000 unit
- Changes are made in the configuration pages and applied when Online with the Logix Designer application

### *Configuration Pages*

Enter the initial settings (parameters) to match your system application for each of the configuration tabs as shown in the following paragraphs. Review the settings and click Apply when complete.

Descriptions for the configuration pages that are labeled General, Connection, Module Info, Internet Protocol, and Port Configuration are provided in the [EDS AOP Guidelines for Logix Designer](#) publication and EtherNet/IP Network Configuration, publication [ENET-UM001](#).

Each page contains four action buttons at the bottom of the tab. These buttons function as follows:

- OK - Accepts the entered values for each screen and closes the Module Properties dialog box.
- Cancel - Exits the screen without saving any changes.
- Apply - Applies the current settings without leaving the screen.
- Help - Accesses the help menu.

The Logix Designer application performs configuration data checks as specified by the limits that are shown in the data tables. The data checks verify that the entry is within range for the device; however, the check does not verify that the entry is reasonable for the application. You must be sure that the entry is reasonable for the specific application. If you enter an out-of-range parameter in a Configuration tab, a message box reports the error and the appropriate limits.

See [Appendix A](#) for information on the limits that the data tables specify.



**ATTENTION:** Data limit checks do not confirm values that are appropriate for the application.

- **Fault Action Page** - The Fault Action page is used to configure the output state of the relays if the power monitor experiences a loss of communication and the unit action when an internal error occurs.

Output	Output State During Communications Fault
KYZ	Hold Last State and Resume
R1	Hold Last State and Resume
R2	Hold Last State and Resume
R3	Hold Last State and Resume

When an internal Power Monitor failure occurs:

Reset the Power Monitor

Set outputs to off, stop communications with Controller

After communication with the controller has stopped, reset or power cycle the Power Monitor to restore communications.

Status: Offline

- **Metering Configuration Page** - The Metering Configuration page is used to configure the parameters that are related to metering and demand.

Nominal Line – Line Voltage: 480.0 v

Nominal Frequency: 60.0 Hz

Metering Mode: Wye

Realtime Update Rate: Single cycle averaged over 8 cycles

**Potential Transformers**

V1, V2, V3 Primary: 480.0 V

V1, V2, V3 Secondary: 480.0 V

V Neutral Primary: 480.0 V

V Neutral Secondary: 480.0 V

**Current Transformers**

I1, I2, I3 Primary: 5.0 A

I1, I2, I3 Secondary: 5 A

I4 Primary: 5.0 A

I4 Secondary: 5 A

**Demand**

Source: Internal Timer

Number of Periods: 1

Period: 15 min

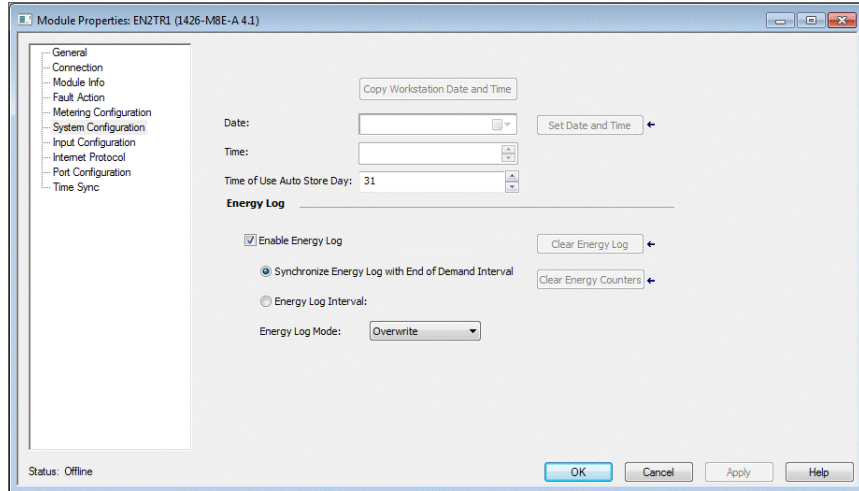
Forced Sync Delay: 10 s

Broadcast Mode: Slave

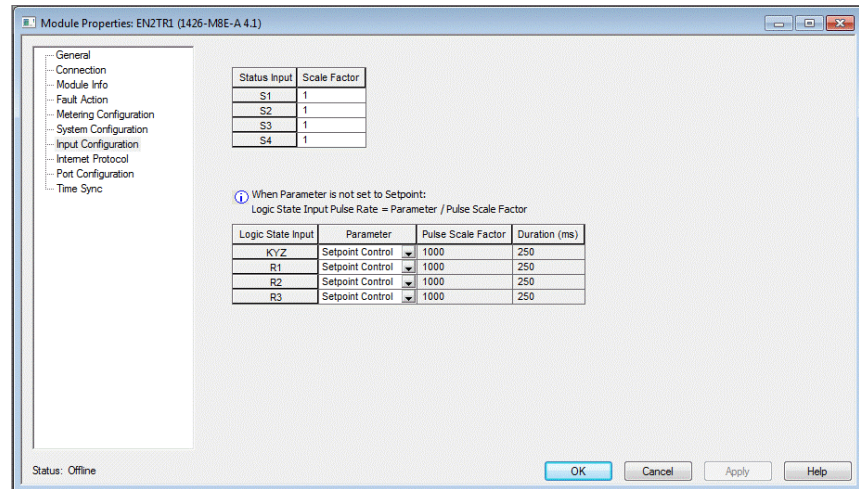
Broadcast Port: 300

Status: Offline

- System Configuration Page - The System Configuration page is used to configure the parameters that are related to the system operation of the power monitor such as the date and time and energy log configuration parameters.



- Input Configuration Page - The Input Configuration page is used to configure the parameters that are related to the operation of the status inputs, KYZ output, and relay outputs.



## Setup Using Optional Software

FactoryTalk® EnergyMetrix™ software, with the RT option, provides a configuration interface for the PowerMonitor 5000 unit, including the ability to upload, edit, download, and back up the unit configuration on a server. See the FactoryTalk EnergyMetrix User Manual, publication [FTEM-UM003](#), or online help topics for information on configuring the PowerMonitor 5000 unit by using FactoryTalk EnergyMetrix software. Contact your local Rockwell Automation sales office or Allen-Bradley distributor, or visit <http://www.software.rockwell.com> for more information on available software packages.

## Setup Using Communication

Refer to [Communication on page 219](#) for detailed information on unit setup by using communication with a programmable controller or custom software application.

**Notes:**

## Metering

Topic	Page
Basic Metering	71
Wiring Diagnostics	73
Wiring Correction	78
Metering Overview	80
Energy Metering	81
Demand Metering	83
Power Metering	87
Voltage, Current, Frequency Metering	89
Configuration Lock	91

This section describes the functions of the PowerMonitor™ 5000 unit. Most functions require you to configure set-up parameters to align the unit with your installation and your application requirements. The set-up parameters are listed by name and described in this section. You can view set-up parameters by using the PowerMonitor 5000 web page, and when logged in to an Admin account, you can change the setup. Set-up parameters are also accessible by using communication.

See the [PowerMonitor 5000 Unit Data Tables](#), in [Appendix A](#), for additional information on setup parameters including the following:

- Range of valid values
- Default values
- Data type

Set-up parameters can be found in data tables with names beginning with 'Configuration', for instance Configuration.Metering\_Basic.

### Basic Metering

The PowerMonitor 5000 unit calculates metering results that are based on the values of a number of set-up parameters. These basic metering parameters are listed in the table that follows. The basic metering setup is necessary to obtain accurate, properly scaled metering results.

Basic metering applies to all models of the PowerMonitor 5000 unit.

## Set-up Parameters

The following set-up parameters specify the configuration of the voltage and current sensing circuit, how the metered values are scaled, nominal values, update rate, and averaging. These parameters are found in the power monitor Configuration > Metering\_Basic web page.

### *Metering\_Mode*

Metering\_Mode must match the external electrical system and how the system is wired to the PowerMonitor voltage and current input terminals. See the wiring diagrams in [Chapter 2](#). The following are the selections for the Metering\_Mode:

- 0 = Demo
- 1 = Split-phase
- 2 = Wye (default)
- 3 = Delta, 2 CT
- 4 = Delta, 3 CT
- 5 = Open Delta, 2 CT
- 6 = Open Delta, 3 CT
- 7 = Delta, Grounded B Phase, 2 CT
- 8 = Delta, Grounded B Phase, 3 CT
- 9 = Delta, High Leg
- 10 = Single Phase

### *V1\_V2\_V3\_PT\_Primary*

### *V1\_V2\_V3\_PT\_Secondary*

### *VN\_PT\_Primary*

### *VN\_PT\_Secondary*

These parameters define the transformation ratios of the potential (voltage) transformers (PTs or VTs) used to connect the power monitor to the measured power circuit. When the power monitor is directly connected to the measured circuit (up to 690V L-L), you can specify any 1:1 ratio.

### *I1\_I2\_I3\_CT\_Primary*

### *I1\_I2\_I3\_CT\_Secondary*

### *I4\_CT\_Primary*

These parameters define the transformation ratios of the current transformers (CTs) used to connect the power monitor to the measured power circuit. The secondary value is permitted to be only 5 A.



*Nominal\_System\_LL\_Voltage**Nominal\_System\_Frequency*

These parameters specify the nominal system (line-to-line) voltage and frequency. The power monitor uses these values to optimize metering accuracy, and the M6 and M8 models use these values to set thresholds for detection of power quality events.

*Realtime\_Update\_Rate*

This parameter specifies the averaging used and the update rate of metering results to the data tables and setpoint calculations. You can select from the following:

- 0 = Single cycle averaged over 8 cycles
- 1 = Single cycle averaged over 4 cycles
- 2 = 1 cycle with no averaging

**Related Functions**

- Voltage and Current Metering
- Power Metering
- Energy Metering
- Demand Metering
- Configuration Lock
- Data Logging
- Power Quality monitoring

**Wiring Diagnostics**

The PowerMonitor 5000 unit provides a means for you to verify proper power monitor connections and diagnose wiring errors. To meter power and energy correctly, voltage and current inputs must be connected to the power circuit with the correct phase rotation and polarity. Indications of wiring errors include the following:

- Indication of negative real power (kW) on a load, or indication of positive power on a generator
- Power factor outside the range of 45% lagging to 80% leading
- Very different power and/or power factor values on different phases

Wiring diagnostics operate on command in any wiring mode, and require a level of measured current at least 5% of the nominal metering scale, or 250 mA of CT secondary current. For example, a power monitor with 600:5 CT ratios that are configured for I1, I2, and I3 requires 30 amps of load current for wiring diagnostics to operate.

---

**IMPORTANT** If insufficient current is available, the wiring diagnostics status shows input level low.

---

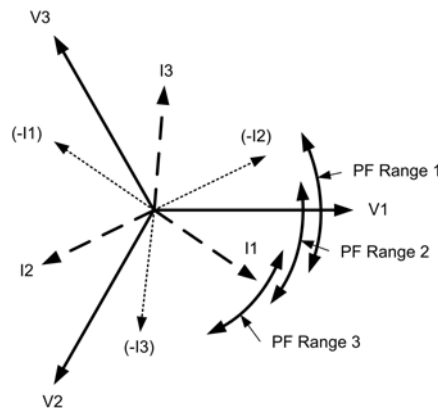
The PowerMonitor 5000 unit calculates phase angles of voltage and current, and checks the phase angles against three distinct ranges of system power factor:

- Range 1: lagging 97% to leading 89%. This range is for very high lagging or significantly leading power factors. Examples of loads in this range include data centers, over-excited synchronous motors, and circuits with power factor correction.
- Range 2: lagging 85% to leading 98%. This range includes most industrial circuits that range from lagging to slightly leading power factors, including circuits feeding AC variable-frequency drives.
- Range 3: lagging 52% to lagging 95%. This range exhibits lower lagging power factors. Examples include lightly loaded motor circuits and DC SCR drives.

The power monitor displays wiring diagnostic status results for all three power factor ranges when a command is issued. You decide which power factor range applies based on your knowledge of the circuit and its load characteristics. You can expect more reliable wiring diagnostic results when the circuit is operating in a normal condition, that is, not especially lightly loaded.

[Figure 29](#) illustrates the part power factor plays in wiring diagnostics. The PF ranges show the I1 phase angle limits for each range. The phasor diagram shows the fundamental voltage and currents in a three-phase, 4-wire system operating with a lagging power factor of roughly 85%. In this example, ranges 2 and 3 wiring diagnostic can return good results, but range 1 can incorrectly indicate that all currents are inverted and displaced by a phase, as shown by the  $-I1$ ,  $-I2$ , and  $-I3$  phasors.

**Figure 29 - Power Factors and Wiring Diagnostics**



In addition to wiring diagnostics on command, the PowerMonitor 5000 unit updates voltage and current magnitude and phase angle data continually. These values are used by FactoryTalk® EnergyMetrix™ RT software to display a system phasor diagram.

Wiring diagnostic results can also be used for automatic virtual wiring correction, as described in the next section.

## **Applications**

Wiring diagnostics applies to all models.

## **Setup**

Only basic metering setup is required.

## **Command**

### *Command Word 2*

Set this command word value to 11 (decimal) or make selection in web page to initiate wiring diagnostics.

## **Wiring Diagnostic Results**

The PowerMonitor 5000 unit returns the following wiring diagnostic results for all three power factor ranges. Results are available for about 30 minutes after the command is received.

### *Command\_Status Values*

- 0 = Command Active
- 1 = Input Level Low
- 2 = Disabled
- 3 = Waiting Command

*RangeN\_Voltage\_Input\_Missing*  
*RangeN\_Current\_Input\_Missing*

These values are for these parameters:

-1 = Test not run  
0 = Test passed  
1 = Phase 1 missing  
2 = Phase 2 missing  
3 = Phase 3 missing  
12 = Phase 1 and 2 missing  
13 = Phase 1 and 3 missing  
23 = Phase 2 and 3 missing  
123 = All phases missing

*Range1\_L97\_C89\_Status*  
*Range2\_L85\_C98\_Status*  
*Range3\_L52\_L95\_Status*

0 = pass  
1 = fail

*RangeN\_Voltage\_Input\_Inverted*  
*RangeN\_Current\_Input\_Inverted*

-1 = Test not run  
0 = Test passed  
1 = Phase 1 inverted  
2 = Phase 2 inverted  
3 = Phase 3 inverted  
12 = Phase 1 and 2 inverted  
13 = Phase 1 and 3 inverted  
23 = Phase 2 and 3 inverted  
123 = All phases inverted

*Voltage\_Rotation*  
*Current\_Rotation*

123...321 designating phase and rotation.  
Example: 213 = Phase 2 then phase 1 then phase 3  
-1 = Test not run  
4 = Invalid Rotation  
5 = Out of range

*Phasor Magnitudes and Angles*

The PowerMonitor 5000 unit updates these values continually.

*Voltage\_Phase\_1\_Angle (always zero)*

*Voltage\_Phase\_1\_Magnitude*

*Voltage\_Phase\_2\_Angle*

*Voltage\_Phase\_2\_Magnitude*

*Voltage\_Phase\_3\_Angle*

*Voltage\_Phase\_3\_Magnitude*

*Current\_Phase\_1\_Angle*

*Current\_Phase\_1\_Magnitude*

*Current\_Phase\_2\_Angle*

*Current\_Phase\_2\_Magnitude*

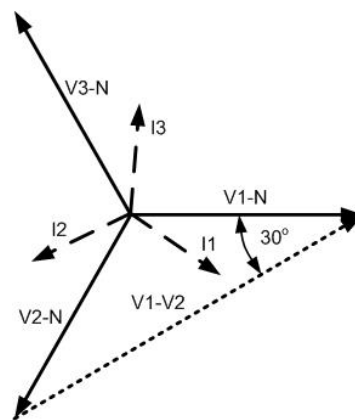
*Current\_Phase\_3\_Angle*

*Current\_Phase\_3\_Magnitude*

The semantics for these parameters:

Magnitudes are the scaled RMS value of the voltage or current. In Wye and split-phase modes, voltages are reported as line-to-neutral. In Delta modes, voltage is reported as line-to-line. Phase angles are referenced to Phase 1 Voltage, which is defined as zero, consistent with the 4-quadrant metering diagram included in [Power Metering on page 87](#).

Current angles in Delta modes include a 30° offset due to the phase angle difference between Wye and Delta modes as shown in the following diagram.



## Related Functions

- Voltage and Current Metering
- Power Metering
- Energy Metering

## Wiring Correction

The PowerMonitor 5000 unit can correct for wiring errors by logically mapping physical voltage and current inputs to voltage and current metering channels. You determine if and when wiring correction occurs by issuing a Wiring Corrections Command.

The wiring corrections command offers a number of options:

- Automatically correct the wiring according to the wiring diagnostics results for the power factor range 1, 2, or 3 that you select.
- Manually apply wiring correction.
- Remove previously applied wiring corrections.

The 'Virtual Wiring Correction' status indicator next to the voltage terminal blocks indicates when wiring corrections are in effect.

---

**IMPORTANT** Only one wiring correction command can be applied (one command can correct for multiple errors). If a change is needed, first remove the previous wiring correction, and then apply the new wiring correction.

---

## Applications

Wiring correction applies to all models.

## Setup

Only basic metering setup is required.

## Command

The [Command.Wiring\\_Corrections](#) table, on [page 371](#), comprises the following parameters.

### *Wiring\_Correction\_Commands*

Wiring\_Correction\_Commands determines the type of wiring correction to be performed when the command executes.

- 0 = No command
- 1 = Correct wiring automatically by using Power Factor Range 1 results
- 2 = Correct wiring automatically by using Power Factor Range 2 results
- 3 = Correct wiring automatically by using Power Factor Range 3 results
- 4 = Correct wiring by using manual input-mapping parameters
- 5 = Remove all wiring corrections.

*Input\_V1\_Mapping**Input\_V2\_Mapping**Input\_V3\_Mapping**Input\_I1\_Mapping**Input\_I2\_Mapping**Input\_I3\_Mapping*

This collection of parameters determines the mapping of physical voltage inputs to logical voltage channels and physical current inputs to logical current channels. The following are the permitted values:

- 1 = Map the physical input to logical channel 1
- 2 = Map the physical input to logical channel 2
- 3 = Map the physical input to logical channel 3
- 1 = Map the physical input to logical channel 1 and invert its polarity
- 2 = Map the physical input to logical channel 2 and invert its polarity
- 3 = Map the physical input to logical channel 3 and invert its polarity

For example, an *Input\_I1\_Mapping* value of -1 inverts the polarity of the secondary connection to the CT on phase 1. The values of these parameters are ignored if automatic wiring correction is selected in the command. If manual input mapping is selected, all mapping parameters are required and the combination is checked for validity (mapping of two physical inputs to the same metering channel is not permitted).

## Status

The [Status.Wiring\\_Corrections](#) table, on [page 358](#), mirrors the parameters of the most recent wiring correction command. In addition, the following parameters report the status of the most recent command.

*Last\_Cmd\_Rejection\_Status*

- 0 = No rejection
- 1 = Rejected; see rejection information

*Rejection\_Information*

- 0 = No information
- 1 = Selected range is incomplete
- 2 = Command is already active. Use command 5 (remove all wiring corrections) to start over
- 3 = Two like inputs that are wired to one terminal
- 4 = Invalid Input parameter

## Related Functions

- Voltage and Current Metering
- Power Metering
- Energy Metering
- Configuration Lock

## Metering Overview

The PowerMonitor 5000 unit performs calculations on scaled, digital voltage, and current values. Signals that are connected to the voltage and current inputs are sampled and their instantaneous values are converted to digital values in an analog-to-digital (A/D) converter section. These values are scaled according to configured PT Primary, PT Secondary, CT Primary, and CT Secondary parameters, and evaluated according to the configured Wiring Mode parameter. All metering results can be viewed by using the Web interface, FactoryTalk EnergyMetrix software, version 2.00.00 or later, or standard CIP™ communication.

## Summary of Measurements

- Current: Average Current, Positive/Negative/Zero Sequence, Percent Unbalance
- Voltage: Line-Line, Line-Neutral, Average, Positive/Negative/Zero Sequence, Percent Unbalance
- Frequency, Average Frequency
- Power: Real (W), Reactive (VARs), Apparent (VA), Total
- Power Factor: True (Full Bandwidth), Displacement (Fundamental), Lead, Lag, Demand
- Real Energy Consumption (kWh, GWH), Forward, Reverse, Net
- Reactive Energy Consumption (kVARh, GVARh) Forward, Reverse, Net
- Apparent Energy Consumption (kVAh, GVAh) Net
- Current Consumption (Amp-h)
- Demand and Projected Demand (kA, kW, kVAR, kVA)
- IEEE Percent Total Harmonic Distortion
- IEC Percent Total Harmonic Distortion
- Crest Factor
- K-Factor
- Phase Rotation (ABC, ACB)
- Time of Use

## Metering Accuracy Class

ANSI C12.20 -2010 (clause 8) Class 0.2 and  
EN 62053-22 - 2003 (clause 5.5.4) Class 0.2



## Energy Metering

The power monitor meters the following energy consumption parameters:

- Real Energy Consumption (kWh, GWh), Forward, Reverse, Net
- Reactive Energy Consumption (kVARh, GVARh) Forward, Reverse, Net
- Apparent Energy Consumption (kVAh, GVAh) Net
- Current Consumption (Amp-h)

## Applications

This function applies to all PowerMonitor 5000 models.

**Table 8 - Energy Metering Metered Parameters**

Parameter	Description	Range	Units
GWh_Fwd	Total real energy consumed	0...9,999,999	GWh
kWh_Fwd	Total real energy consumed	0.000...999,999	kWh
GWh_Rev	Total real energy produced	0...9,999,999	GWh
kWh_Rev	Total real energy produced	0.000...999,999	kWh
GWh_Net	The sum of forward and reverse real energy	±0...9,999,999	GWh
kWh_Net	The sum of forward and reverse real energy	±0.000...999,999	kWh
GVARh_Fwd	Total reactive energy consumed	0...9,999,999	GVARh
kVARh_Fwd	Total reactive energy consumed	0.000...999,999	kVARh
GVARh_Rev	Total reactive energy produced	0...9,999,999	GVARh
kVARh_Rev	Total reactive energy produced	0.000...999,999	kVARh
GVARh_Net	Total sum of forward and reverse reactive energy	±0...9,999,999	GVARh
kVARh_Net	Total sum of forward and reverse reactive energy	±0.000...999,999	kVARh
GVAh	Total apparent energy consumed	0...9,999,999	GVAh
kVAh	Total apparent energy consumed	0.000...999,999	kVAh
GAh	Accumulated amp-hours consumed	0...9,999,999	GAh
kAh	Accumulated amp-hours consumed	0.000...999,999	kAh

### Example

A large energy value could be displayed as 123,456,789,234.567 kWh where 123,456 is the GWh metering result and 789,234.567 is the kWh metering result.

Energy results (kWh, kVARh, and kVAh) roll over to 0 after the value of 9,999,999,999,999 or  $10^{13}-1$  is reached.

### Setup

Only basic metering setup is required for energy metering.

### Commands

The power monitor supports the following commands:

- Set GWh/kWh register
- Set GVARh/kVARh register
- Set GVAh/kVAh register
- Set GAh/kAh register
- Clear all energy registers

---

**IMPORTANT** A Giga counter can be entered that includes digits to the right of the decimal (such as, 345.456) and applied. When the Giga counter is checked, the digits to the right of the decimal (.456) are not seen. This behavior is normal for a Giga counter because any value to the right of the decimal is in the Kilo counter. If the desired consumption value is 345.456 GWh, the correct entry is GWh = 345 and kWh = 456. This applies to all consumption counters.

---

### Related Functions

- KYZ output
- Energy log
- Configuration lock

## Demand Metering

Demand is an electric power term that expresses the average energy usage over a predefined period. Your electrical energy provider specifies how demand is determined in the rate tariff or schedule that is used to calculate your electric bill. The power monitor can be configured to align with how your electric-energy provider measures demand by using a fixed demand period or a sliding time window. The demand period can be configured to be timed internally, synchronized to an external demand end-of-interval contact connected to the S2 status input, or synchronized by using communication. The PowerMonitor 5000 unit, by default, calculates demand on a fixed 15-minute demand period, which is synchronized to the power monitor internal clock.

**Table 9 - Demand Metering Metered Parameters**

Parameter	Description	Range	Units
kW_Demand	The average total real power during the last demand period.	± 0.000...9,999,999	kW
kVAR_Demand	The average total reactive power during the last demand period.	±0.000...9,999,999	kVAR
kVA_Demand	The average total apparent power during the last demand period.	0.000...9,999,999	kVA
Demand_PF	The average PF during the last demand period.	-100.0...100.0	PF
Demand_Amperes	The average demand for amperes during the last demand period.	0.000...9,999,999	A
Projected_kW_Demand	The projected total real power for the current demand period.	± 0.000...9,999,999	kW
Projected_kVAR_Demand	The projected total reactive power for the current demand period.	±0.000...9,999,999	kVAR
Projected_kVA_Demand	The projected total apparent power for the current demand period.	0.000...9,999,999	kVA
Projected_Ampere_Demand	The projected average amperes for the current demand period.	0.000...9,999,999	A

Projected demand calculates an instantaneous or linear projection of demand at the end of a demand interval.

Demand power factor is calculated by using the following formula.

$$\frac{\text{kWDemand}}{\text{kVADemand}}$$

### Demand Calculation

Demand is equal to the average power level during a predefined time interval. This interval continuously repeats and is typically 15 minutes but can be 5...30 minutes in length. The power monitor computes demand levels for watts, VA, amps, and VARs, and provides two different methods for projecting demand. The formula for real power (kW) demand is the following.

$$\text{Demand} = \frac{1}{T} \times \int_t^{(t+T)} P(t) dt$$

$T$  = Demand interval duration

$t$  = Time at beginning of interval

$P(t)$  = Power as a function of time

If your electric utility provides a pulse that indicates the end of each demand interval, the power monitor can be configured to determine its demand interval from the utility pulse.

Some electric service providers use the sliding window method. This method breaks the demand interval into many subintervals and updates the demand value at the end of each subinterval.

For example, a 15 minute interval can be divided into 15 one-minute subintervals. Each minute, the following occurs:

- The demand for the subinterval is calculated and stored.
- The average value of the most recent 15 subintervals is computed to obtain a demand value.
- Subinterval values older than 15 minutes are discarded.

## Projected Demand Calculation

Projected demand calculates an instantaneous (default) or first-order projection of demand at the end of a demand interval. Select the best projection method for your system by comparing the projected values from each method with the actual demand at the end of the interval. The following sections describe the methods of projecting demand.

### *Instantaneous*

The power monitor computes instantaneous demand by substituting the elapsed interval duration for the total interval duration (T) in the demand equation. The power monitor computation is therefore identical to the standard computation. The one exception is that the power monitor integrates the power only over the elapsed interval duration and calculates the average value over the elapsed duration. The modified equation thus becomes:

$$Demand = \frac{1}{t2 - t1} \times \int_{t1}^{t2} P(t) dt$$

$(t2 - t1)$  = Elapsed interval duration and is less than T

### *First Order Projection*

The first order demand projection does the following:

- Uses the instantaneous demand as a starting point
- Computes the trend of the instantaneous demand
- Computes the time remaining in the interval
- Performs a first order projection of what the final demand is at the end of the interval

This method can be useful where your system has a significant base load with additional loads that are switched in and out during the interval.

## Setup

Basic Metering and Date and Time setup are required. If the default demand configuration (15-minute fixed interval based on internal clock) satisfies your demand metering requirements, you do not need to change any demand setup parameters.

If you want to customize the demand calculation to match that of your electric service provider, or to satisfy other application requirements, then there are two groups of setup parameters you can change.

Basic demand set-up parameters are found in the Metering\_Basic tab under the Configuration tab.

### *Demand\_Source*

Selects the source of the demand end-of-interval (EOI) signal.

- 0 = Internal Timer (default)
- 1 = Status Input 2
- 2 = Controller Command (Unit must be configured as a demand sync master)
- 3 = Ethernet Demand Broadcast

The following are the semantics:

- If Demand\_Broadcast\_Mode\_Select is set to master, then a Demand Source value of 0...2 selects the EOI source that is used to trigger the demand-sync master broadcast.
- If Demand\_Broadcast\_Mode\_Select is set to slave, then a Demand Source value of 0...3 selects the EOI source.

### *Demand\_Period\_Length (Minutes)*

Specifies the desired period for demand calculations. These values are for this parameter:

- 0 = See semantics
- 1...99 = Length of time of each demand period in minutes

The following are the semantics:

- When set to 0 there are no projected demand calculations.
- If the internal timer is selected, a setting of 0 turns off the demand function.

### *Number\_Demand\_Periods*

Specifies the number of demand periods to average for demand measurement. These values are for this parameter:

- 1 = Used for fixed demand period
- 2...15 = Used for sliding window demand period

### *Forced\_Demand\_Sync\_Delay*

When configured for an external demand source, this parameter defines how long the unit waits for the expected control input (for example, EOI pulse or network demand broadcast), before the unit starts a new demand period. If this delay occurs, an entry is made in the Event Log. These values are for this parameter:

- 0 = Wait forever
- 1...900 = Wait this many seconds before starting a new demand period

Network demand synchronization is available on units that are connected to an Ethernet network. Network-demand synchronization parameters are found in the Communications\_Native tab under Configuration tab.

### *Demand\_Broadcast\_Mode\_Select*

Demand Ethernet broadcast selection. These values are for this parameter:

- 0 = Slave (default)
- 1 = Master

---

**IMPORTANT** There must be only one master per demand network.

---

### *Demand\_Broadcast\_Port*

The common port for demand broadcast messages. These values are for this parameter:

- 300 (default)...400

## **Commands**

Controller command (EOI signal)

## **Related Functions**

- Status inputs
- Time of use log
- Configuration lock

## Power Metering

This function applies to all PowerMonitor 5000 models.

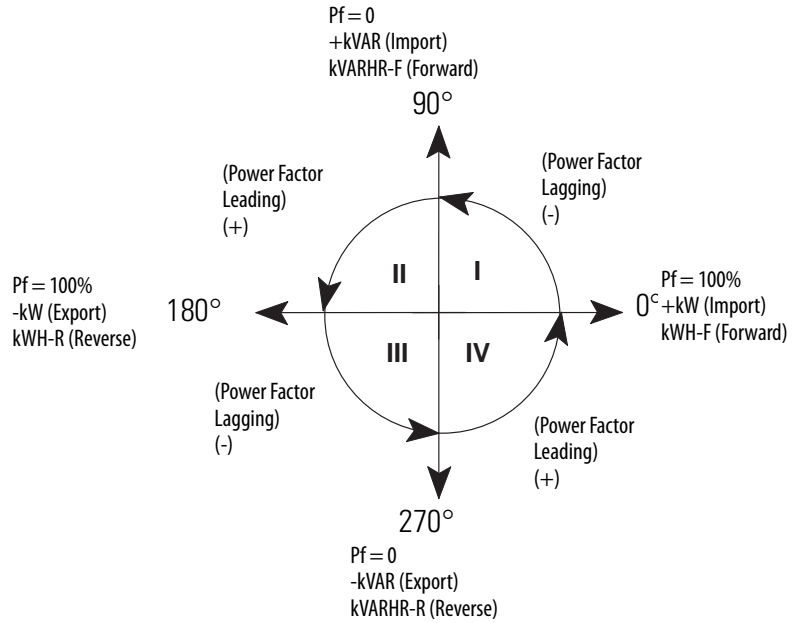
**Table 10 - Power Metering Metered Parameters**

Parameter	Description	Range	Units
L1_kW	Power of individual phase or sum of phases; signed to show direction	-9.999E15...9.999E15	kW
L2_kW			
L3_kW			
Total_kW			
L1_kVAR	Reactive power of individual phase or sum of all phases; signed to show direction	-9.999E15...9.999E15	kVAR
L2_kVAR			
L3_kVAR			
Total_kVAR			
L1_kVA	Apparent power of individual phase or sum of all phases	0...9.999E15	kVA
L2_kVA			
L3_kVA			
Total_kVA			
L1_True_PF_%	The ratio between power and apparent power for individual phase or all phases	0.00...100.00	%
L2_True_PF_%			
L3_True_PF_%			
Avg_True_PF			
L1_Disp_PF	The cosine of the phase angle between the fundamental voltage and current for an individual phase or all phases	0.00...100.00	%
L2_Disp_PF			
L3_Disp_PF			
Avg_Disp_PF			
L1_PF_Lead_Lag_Indicator	Lead or lag indicator for power factor 1 = leading -1 = lagging	-1...+1	-
L2_PF_Lead_Lag_Indicator			
L3_PF_Lead_Lag_Indicator			
Total_PF_Lead_Lag_Indicator			

Only total three-phase power results are provided when Direct Delta or Open Delta wiring modes are selected.

The Magnitude and Direction of Power Quantities chart indicates the relationship between the magnitude and direction of the power quantities and the numeric signs that are used by the power monitor.

**Figure 30 - Magnitude and Direction of Power Quantities**



### Setup

Only basic metering setup is required for power metering.

### Related Functions

- Metering result averaging
- Configuration lock



## Voltage, Current, Frequency Metering

This function applies to all PowerMonitor 5000 models.

**Table 11 - Voltage, Current, and Frequency Metering Metered Parameters**

Parameter	Description	Range	Units
V1_N_Volts	RMS line to neutral voltage of individual phase or average of V1, V2, V3	0...9.999E15	V
V2_N_Volts			
V3_N_Volts			
Avg_V_N_Volts			
VN_G_Volts	RMS ground to neutral voltage	0...9.999E15	V
V1_V2_Volts	RMS line to line voltage of individual phase or average of V1_V2, V2_V3 and V3_V1	0...9.999E15	V
V2_V3_Volts			
V3_V1_Volts			
Avg_VL_VL_Volts			
I1_Amps	RMS line current of individual phase or average of I1, I2, and I3 amps.	0...9.999E15	A
I2_Amps			
I3_Amps			
Avg_Amps			
I4_Amps	RMS current of phase 4, also known as the neutral or zero-sequence current	0...9.999E15	A
Frequency_Hz	The frequency of the voltage	40.00...70.00	Hz
Avg_Frequency_Hz	Average Frequency over 6 cycles	40.00...70.00	Hz
Voltage Rotation	Voltage rotation has the following designations: 0 = Not metering 123 = ABC rotation 132 = ACB rotation 4 = No rotation	0...132	
Pos_Seq_Volts	Positive Sequence Voltage	0...9.999E15	V
Neg_Seq_Volts	Negative Sequence Voltage	0...9.999E15	V
Zero_Seq_Volts	Zero Sequence Voltage	0...9.999E15	V
Pos_Seq_Amps	Positive Sequence Amps	0...9.999E15	A
Neg_Seq_Amps	Negative Sequence Amps	0...9.999E15	A
Zero_Seq_Amps	Zero Sequence Amps	0...9.999E15	A
Voltage_Unbalance_%	Voltage percent unbalance	0.00...100.00	%
Current_Unbalance_%	Current percent unbalance	0.00...100.00	%

Line-to-neutral voltage results are provided in Wye, split-phase, and high-leg Delta metering modes. Line-to-neutral voltage results are not provided in Delta (other than high-leg Delta) and Open Delta metering modes.

Voltage and current unbalance are calculated by using the following formula.

$$\frac{\text{Negative Sequence}}{\text{Positive Sequence}} \times 100$$

## Symmetrical Component Analysis Results

The power monitor calculates sequence voltages and currents for use in symmetrical component analysis, which transforms a set of unbalanced three-phase vectors into three sets of balanced vectors. The positive sequence components are a set of vectors that rotate the same direction as the original power vectors, and represent that portion of the applied voltage or current capable of doing work. Negative sequence components rotate opposite to the original vectors, and represent the portion of the applied power that results in losses due to unbalance. The percent unbalance value is the ratio between the negative and positive current sequence in a three-phase system. This ratio is the most accurate measurement of current unbalance because the measurement accounts for the magnitude of the individual currents and the relative phase displacement. The zero sequence component is a vector that does not rotate, and represents ground or neutral current ( $I_4$ ) or voltage. The component analysis results are included in [Table 11](#).

## Setup

Only basic metering input setup is required for voltage and current metering.

## Related Functions

- Metering result averaging
- Configuration lock

## Viewing Metering Results by Using Web Page

You can view voltage, current, frequency, energy, and power metering results from the PowerMonitor 5000 web page. Browse to the network address of the power monitor. From the home page, choose the MeteringResults folder and then the desired metering results page.



RealTime_VIF_Power	
Metering_Data_Stamp	52412
Metering_Time_Stamp	180327
Metering_Microsecond_Stamp	83333
V1_N_Volts	815.405
V2_N_Volts	823.189
V3_N_Volts	824.950
VN_G_Volts	0
Avg_V_N_Volts	821.181
V1_V2_Volts	1070.467
V2_V3_Volts	1082.885
V3_V1_Volts	1071.598
Avg_V1_V1_Volts	1074.984
I1_Amps	5.758
I2_Amps	5.554
I3_Amps	5.363
I4_Amps	0
Avg_Amps	5.559
Frequency_Hz	60.007
Avg_Frequency_Hz	60.010

You can use the Web interface to view power quality results, power monitor status and statistics, and configuration. CalibrationData links to a printable calibration certificate for the power monitor. Configuration lets you review the configuration parameters, and, if logged in as an administrator, change them. While logged in as an administrator, you can also issue commands to the power monitor from the Command link.

## Viewing Metering Results with a Door-Mounted Display

The PowerMonitor 5000 Display Module (catalog number 1426-DM, purchased separately) can be applied as a panel display for one, two, or three PowerMonitor 5000 units.

[Appendix D](#) provides further information on configuring and using a Display Module for a PowerMonitor 5000 unit.

## Configuration Lock

Unauthorized changes to the PowerMonitor 5000 unit setup are prevented when the configuration lock switch is placed in the lock position.

### Applications

Configuration lock applies to all models.

### Operation

The following setup parameters and commands are locked when the configuration lock is applied.

#### *Configuration.Metering\_Basic*

All parameters.

#### *Configuration.SystemGeneral*

- KYZ and Relay Outputs setup
- Status inputs scale

#### *Configuration.CommunicationsNative*

- Network demand setup

### *Command.System\_Registers*

- Clear all energy registers
- Set status input count
- Force relay or KYZ output on, off, or clear force
- Restore factory defaults
- Reset power monitor

### **Setup**

No setup is needed.

## Power Quality Monitoring

Topic	Page
Harmonic Analysis	96
Sag and Swell Detection	102
Waveform Recording (M6 and M8 model)	104

This section describes the basic Power Quality functions of the PowerMonitor™ 5000 unit. Most functions require you to configure set-up parameters to align the unit with your installation and your application requirements. The set-up parameters are listed by name and described in this section. You can view set-up parameters by using the PowerMonitor 5000 web page, and when logged in to an Admin account, make changes to the setup. Set-up parameters are also accessible by using communication.

See the [PowerMonitor 5000 Unit Data Tables](#), in [Appendix A](#), for additional information on setup parameters including the following:

- Range of valid values
- Default values
- Data type

Set-up parameters can be found in data tables with names beginning with 'Configuration', for instance Configuration.Metering\_Basic.

The term ‘power quality’ is associated with electromagnetic irregularities in voltage and current in a power circuit that can interfere with or cause failures of electronic equipment. The purpose of these functions is to assist users to determine and correct the causes of poor power quality, resulting in more reliable operation and reduced cost.

A number of national and international standards have been developed that define and classify power quality events and issues, and provide guidelines for detecting and reporting these events and issues. The design of the power quality functions in the PowerMonitor 5000 unit has been aligned with these standards. See the following Appendices for further information:

- [Appendix F](#) - IEEE 519
- [Appendix G](#) - IEEE 1159
- [Appendix H](#) - EN 50160
- [Appendix I](#) - EN 61000-4-30

Power quality functions are classified into three broad categories:

- Measurement and reporting the value of power circuit attributes that comprise power quality
- Classification of power quality events according to applicable standards and annunciation of such events
- Recording power quality events and their metadata for statistical and diagnostic purposes

The PowerMonitor 5000 unit provides a range of power quality monitoring functions. The basic M5 model detects sags and swells, and measures THD, crest factor, and K-factor. The M6 model builds upon the M5 functionality, adding IEEE 519 THD/TDD pass/fail reporting, user configurable voltage sag/swell settings, power quality logging, waveform recording, harmonic analysis, and synchronized event recording among multiple power monitors. The M8 model is an advanced power quality meter that expands upon the M6 with subcycle transient detection and capture, flicker monitoring, expanded harmonic analysis, EN 61000-4-30 metering, and EN50160 conformance tracking.

FactoryTalk® EnergyMetrix™ software and its RealTime (RT) option provide comprehensive, web-based software tools for presenting the power quality monitoring data produced by the PowerMonitor 5000.

[Table 12](#) compares the power quality capabilities of the PowerMonitor 5000 models.

**Table 12 - Power Quality Capabilities**

Power Quality Attributes	1426-M5	1426-M6	1426-M8	Per phase	Average / Total
IEEE Voltage THD %	•	•	•	•	•
IEEE Current THD %	•	•	•	•	•
IEC Voltage THD %	•	•	•	•	•
IEC Current THD %	•	•	•	•	•
Crest Factor, Voltage, and Current	•	•	•	•	

**Table 12 - Power Quality Capabilities (continued)**

Power Quality Attributes	1426-M5	1426-M6	1426-M8	Per phase	Average / Total
K-factor, Current	•	•	•	•	
Harmonic voltages DC ... 63rd, magnitude and angle		•	•	•	
Harmonic voltages 64th ... 127th, magnitude and angle			•	•	
Harmonic currents DC ... 63rd, magnitude and angle		•	•	•	
Harmonic currents 64th ... 127th, magnitude and angle			•	•	
Harmonic kW, kVAR, kVA, DC ... 63rd		•	•	•	•
Harmonic kW, kVAR, kVA, 64th ... 127th			•	•	•
Sag and swell detection	•	•	•	•	•
Classification of Power Quality Events Per IEEE 1159		•	•	•	•
IEEE 1159 imbalance and frequency variation		•	•	•	
IEEE 1159 DC offset and THD rolling average, V and I		•	•	•	
IEEE 1159 TID rolling average, V and I			•	•	
IEEE 1159 Flicker Pst, V			•		
IEEE 519 pass/fail and TDD % (2nd through 40th)		•	•	•	•
IEEE 519 short and long-term harmonic %, Ch1, 2, 3		•	•		
Waveform recording		•	•	•	
Network synchronized waveform recording		•	•		
Power quality logging		•	•		
EN61000-4-30 10/12 cycle harmonic subgroups V-N, V-V, I, DC-50th			•	•	
EN61000-4-30 10/12 cycle interharmonic subgroups V-N, V-V, I, DC-50th			•	•	
EN61000-4-30 3 second harmonic subgroups V-N, V-V, DC-50th			•	•	
EN61000-4-30 3 second interharmonic subgroups V-N, V-V, DC-50th			•	•	
EN61000-4-30 10 minute harmonic subgroups V-N, V-V, DC-50th			•	•	
EN61000-4-30 10 minute interharmonic subgroups V-N, V-V, DC-50th			•	•	
EN61000-4-30 2-hour harmonic subgroups V-N, V-V, DC-50th			•	•	
EN61000-4-30 2-hour interharmonic subgroups V-N, V-V, DC-50th			•	•	
EN61000-4-30 interharmonic mag 5 Hz bins, V-N, V-V, I, DC-50th			•	•	
EN61000-4-30 interharmonic angle 5 Hz bins, V-N, V-V, I, DC-50th			•	•	
EN61000-4-30 power frequency variation			•		•
EN61000-4-30 supply voltage measurement			•	•	•
EN61000-4-30 flicker measurement			•	•	
EN61000-4-30 voltage dips and swells			•	•	
EN61000-4-30 voltage interruptions			•	•	
EN61000-4-30 data flagging			•		•
EN61000-4-30 supply voltage imbalance			•		•
EN61000-4-30 time aggregation			•	•	•
EN61000-4-30 Mains signaling voltage on the supply voltage			•		•
EN61000-4-30 rapid voltage changes			•	•	

## Harmonic Analysis

The PowerMonitor 5000 provides harmonic data to help you understand this important element of power quality in your facility. When calculating harmonic analysis results, the M5 and M6 models use DC to the 63rd harmonics, and the M8 model uses DC to 127th. Individual harmonic results are not provided in the M5 model.

For additional harmonic analysis, including interharmonics, see [EN 50160 Conformance Tracking on page 473](#).

### Setup

Only basic metering setup is required.

### Operation

This section describes the methods for measuring harmonics.

#### *IEEE and IEC Total Harmonic Distortion*

These total harmonic distortion calculation methods provide a summary indication of the amount of distortion due to harmonics present in a system.

The standard IEEE definition of harmonic distortion is ‘Total Harmonic Distortion (THD)’ and is computed for each voltage (V1, V2, V3, VN) and current (I1, I2, I3, I4) channel as follows:

$$\text{THD} = \frac{\sqrt{\sum_{n=2}^{\infty} (H_n)^2}}{H_1} \quad \text{Where:}$$

- $H_n$  = magnitude of the  $n^{\text{th}}$  harmonic
- $H_1$  = magnitude of fundamental

The standard IEC definition of harmonic distortion is the Distortion Index (DIN) and is computed for each channel as follows:

$$\text{DIN} = \sqrt{\frac{\sum_{n=2}^{\infty} (H_n)^2}{\sum_{n=1}^{\infty} (H_n)^2}} \quad \text{Where:}$$

- $H_n$  = magnitude of the  $n^{\text{th}}$  harmonic
- DIN is equivalent to IEC THD

#### *Crest Factor*

Crest Factor is another measure of the amount of distortion present in a waveform. This measurement can also be used to express the dynamic range of a measurement device. Crest Factor is the ratio of the peak to the RMS.

$$\text{Crest Factor} = \text{Peak Value} / \text{RMS Value}$$

A pure sinusoid Crest Factor equals  $\sqrt{2}$ .



### *K-factor*

K-factor measures additional heating in a power transformer due to harmonics in the power signal. These harmonics cause additional heating due to increased core losses that occur at higher frequencies.

The increased losses are related to the square of the harmonic frequency. Therefore, a slight harmonic content can significantly increase the heat rise in a power transformer. The additional harmonic heating can cause a transformer to exceed designed temperature limits even though the RMS current is less than the transformer rating. The K-factor is used as justification to oversize a power transformer to allow extra margin for harmonic losses or to select an appropriate K-factor rated transformer. A K-factor rated transformer is the preferred choice because this type of transformer has known performance in the presence of harmonics.

The formula for K-factor is as follows:

$$\text{K-Factor} = \frac{\sum_{n=1}^{\infty} (H_n^2 \cdot n^2)}{\sum_{n=1}^{\infty} (H_n)^2} \quad \text{Where:}$$

•  $H_n$  = magnitude of the  $n^{\text{th}}$  harmonic

### *Harmonic Analysis Results*

The power monitor returns results for IEEE and IEC THD, crest factor and K-factor in the PowerQuality.RealTime\_PowerQuality tab.

**Table 13 - Harmonic Analysis Results**

Tag Name	Units	Range
V1_Crest_Factor		0...9.999E15
V2_Crest_Factor		0...9.999E15
V3_Crest_Factor		0...9.999E15
V1_V2_Crest_Factor		0...9.999E15
V2_V3_Crest_Factor		0...9.999E15
V3_V1_Crest_Factor		0...9.999E15
I1_Crest_Factor		0...9.999E15
I2_Crest_Factor		0...9.999E15
I3_Crest_Factor		0...9.999E15
I4_Crest_Factor		0...9.999E15
V1_IEEE_THD_%	%	0.00...100.00
V2_IEEE_THD_%	%	0.00...100.00
V3_IEEE_THD_%	%	0.00...100.00
VN_G_IEEE_THD_%	%	0.00...100.00
Avg_IEEE_THD_V_%	%	0.00...100.00
V1_V2_IEEE_THD_%	%	0.00...100.00

**Table 13 - Harmonic Analysis Results (continued)**

Tag Name	Units	Range
V2_V3_IEEE_THD_%	%	0.00 . . . 100.00
V3_V1_IEEE_THD_%	%	0.00 . . . 100.00
Avg_IEEE_THD_V_V_%	%	0.00 . . . 100.00
I1_IEEE_THD_%	%	0.00 . . . 100.00
I2_IEEE_THD_%	%	0.00 . . . 100.00
I3_IEEE_THD_%	%	0.00 . . . 100.00
I4_IEEE_THD_%	%	0.00 . . . 100.00
Avg_IEEE_THD_I_%	%	0.00 . . . 100.00
V1_IEC_THD_%	%	0.00 . . . 100.00
V2_IEC_THD_%	%	0.00 . . . 100.00
V3_IEC_THD_%	%	0.00 . . . 100.00
VN_G_IEC_THD_%	%	0.00 . . . 100.00
Avg_IEC_THD_V_%	%	0.00 . . . 100.00
V1_V2_IEC_THD_%	%	0.00 . . . 100.00
V2_V3_IEC_THD_%	%	0.00 . . . 100.00
V3_V1_IEC_THD_%	%	0.00 . . . 100.00
Avg_IEC_THD_V_V_%	%	0.00 . . . 100.00
I1_IEC_THD_%	%	0.00 . . . 100.00
I2_IEC_THD_%	%	0.00 . . . 100.00
I3_IEC_THD_%	%	0.00 . . . 100.00
I4_IEC_THD_%	%	0.00 . . . 100.00
Avg_IEC_THD_I_%	%	0.00 . . . 100.00
I1_K_Factor		1.00 . . . 25000.00
I2_K_Factor		1.00 . . . 25000.00
I3_K_Factor		1.00 . . . 25000.00

*Harmonic Magnitude and Angle*

The power monitor calculates the RMS magnitude and angle of each individual harmonic. Results are calculated for harmonics DC to 63 (DC to 127th for the M8 model) for all voltage and current channels. Each magnitude is expressed in rms volts or rms amps. DC offset is always zero for current channels. Only directly connected voltage channels return non-zero DC offset values.

Angles are expressed in degrees, with zero degrees corresponding to the time stamp of the metering results.

### *Harmonic Power*

The power monitor calculates the magnitudes of real, reactive, and apparent power of each individual harmonic. Results are calculated for harmonics DC to 63 (127 for the M8 model). L1, L2, L3, and total power values are returned for Wye and split-phase wiring modes. Delta wiring modes return only total power values. Each magnitude is expressed in kW, kVAR, or kVA.

### *Individual Harmonics Results*

Individual harmonic results are returned in an array of data tables. You can view any harmonic results table by selecting the table from the PowerQuality > Harmonics\_Results tab in the PowerMonitor 5000 web page. The available harmonic results data tables are listed.

- PowerQuality.Total\_kW\_H1\_RMS (DC...31)
- PowerQuality.Total\_kW\_H2\_RMS (32...63)
- PowerQuality.Total\_kW\_H3\_RMS (64...95, M8 model)
- PowerQuality.Total\_kW\_H4\_RMS (96...127, M8 model)
- PowerQuality.Total\_kVAR\_H1\_RMS (DC...31)
- PowerQuality.Total\_kVAR\_H2\_RMS (32...63)
- PowerQuality.Total\_kVAR\_H3\_RMS (64...95, M8 model)
- PowerQuality.Total\_kVAR\_H4\_RMS (96...127, M8 model)
- PowerQuality.Total\_kVA\_H1\_RMS (DC...31)
- PowerQuality.Total\_kVA\_H2\_RMS (32...63)
- PowerQuality.Total\_kVA\_H3\_RMS (64...95, M8 model)
- PowerQuality.Total\_kVA\_H4\_RMS (96...127, M8 model)
- PowerQuality.V1\_N\_Volts\_H1\_RMS (DC...31)
- PowerQuality.V1\_N\_Volts\_H2\_RMS (32...63)
- PowerQuality.V1\_N\_Volts\_H3\_RMS (64...95, M8 model)
- PowerQuality.V1\_N\_Volts\_H4\_RMS (96...127, M8 model)
- PowerQuality.V2\_N\_Volts\_H1\_RMS (DC...31)
- PowerQuality.V2\_N\_Volts\_H2\_RMS (32...63)
- PowerQuality.V2\_N\_Volts\_H3\_RMS (64...95, M8 model)
- PowerQuality.V2\_N\_Volts\_H4\_RMS (96...127, M8 model)
- PowerQuality.V3\_N\_Volts\_H1\_RMS (DC...31)
- PowerQuality.V3\_N\_Volts\_H2\_RMS (32...63)
- PowerQuality.V3\_N\_Volts\_H3\_RMS (64...95, M8 model)
- PowerQuality.V3\_N\_Volts\_H4\_RMS (96...127, M8 model)
- PowerQuality.VN\_G\_Volts\_H1\_RMS (DC...31)
- PowerQuality.VN\_G\_Volts\_H2\_RMS (32...63)
- PowerQuality.VN\_G\_Volts\_H3\_RMS (64...95, M8 model)
- PowerQuality.VN\_G\_Volts\_H4\_RMS (96...127, M8 model)
- PowerQuality.V1\_V2\_Volts\_H1\_RMS (DC...31)
- PowerQuality.V1\_V2\_Volts\_H2\_RMS (32...63)

- PowerQuality.V1\_V2\_Volts\_H3\_RMS (64...95, M8 model)
- PowerQuality.V1\_V2\_Volts\_H4\_RMS (96...127, M8 model)
- PowerQuality.V2\_V3\_Volts\_H1\_RMS (DC...31)
- PowerQuality.V2\_V3\_Volts\_H2\_RMS (32...63)
- PowerQuality.V2\_V3\_Volts\_H3\_RMS (64...95, M8 model)
- PowerQuality.V2\_V3\_Volts\_H4\_RMS (96...127, M8 model)
- PowerQuality.V3\_V1\_Volts\_H1\_RMS (DC...31)
- PowerQuality.V3\_V1\_Volts\_H2\_RMS (32...63)
- PowerQuality.V3\_V1\_Volts\_H3\_RMS (64...95, M8 model)
- PowerQuality.V3\_V1\_Volts\_H4\_RMS (96...127, M8 model)
- PowerQuality.I1\_Amps\_H1\_RMS (DC...31)
- PowerQuality.I1\_Amps\_H2\_RMS (32...63)
- PowerQuality.I1\_Amps\_H3\_RMS (64...95, M8 model)
- PowerQuality.I1\_Amps\_H4\_RMS (96...127, M8 model)
- PowerQuality.I2\_Amps\_H1\_RMS (DC...31)
- PowerQuality.I2\_Amps\_H2\_RMS (32...63)
- PowerQuality.I2\_Amps\_H3\_RMS (64...95, M8 model)
- PowerQuality.I2\_Amps\_H4\_RMS (96...127, M8 model)
- PowerQuality.I3\_Amps\_H1\_RMS (DC...31)
- PowerQuality.I3\_Amps\_H2\_RMS (32...63)
- PowerQuality.I3\_Amps\_H3\_RMS (64...95, M8 model)
- PowerQuality.I3\_Amps\_H4\_RMS (96...127, M8 model)
- PowerQuality.I4\_Amps\_H1\_RMS (DC...31)
- PowerQuality.I4\_Amps\_H2\_RMS (32...63)
- PowerQuality.I4\_Amps\_H3\_RMS (64...95, M8 model)
- PowerQuality.I4\_Amps\_H4\_RMS (96...127, M8 model)
- PowerQuality.L1\_kW\_H1\_RMS (DC...31)
- PowerQuality.L1\_kW\_H2\_RMS (32...63)
- PowerQuality.L1\_kW\_H3\_RMS (64...95, M8 model)
- PowerQuality.L1\_kW\_H4\_RMS (96...127, M8 model)
- PowerQuality.L2\_kW\_H1\_RMS (DC...31)
- PowerQuality.L2\_kW\_H2\_RMS (32...63)
- PowerQuality.L2\_kW\_H3\_RMS (64...95, M8 model)
- PowerQuality.L2\_kW\_H4\_RMS (96...127, M8 model)
- PowerQuality.L3\_kW\_H1\_RMS (DC...31)
- PowerQuality.L3\_kW\_H2\_RMS (32...63)
- PowerQuality.L3\_kW\_H3\_RMS (64...95, M8 model)
- PowerQuality.L3\_kW\_H4\_RMS (96...127, M8 model)
- PowerQuality.L1\_kVAR\_H1\_RMS (DC...31)
- PowerQuality.L1\_kVAR\_H2\_RMS (32...63)
- PowerQuality.L1\_kVAR\_H3\_RMS (64...95, M8 model)

- PowerQuality.L1\_kVAR\_H4\_RMS (96...127, M8 model)
- PowerQuality.L2\_kVAR\_H1\_RMS (DC...31)
- PowerQuality.L2\_kVAR\_H2\_RMS (32...63)
- PowerQuality.L2\_kVAR\_H3\_RMS (64...95, M8 model)
- PowerQuality.L2\_kVAR\_H4\_RMS (96...127, M8 model)
- PowerQuality.L3\_kVAR\_H1\_RMS (DC...31)
- PowerQuality.L3\_kVAR\_H2\_RMS (32...63)
- PowerQuality.L3\_kVAR\_H3\_RMS (64...95, M8 model)
- PowerQuality.L3\_kVAR\_H4\_RMS (96...127, M8 model)
- PowerQuality.L1\_kVA\_H1\_RMS (DC...31)
- PowerQuality.L1\_kVA\_H2\_RMS (32...63)
- PowerQuality.L1\_kVA\_H3\_RMS (64...95, M8 model)
- PowerQuality.L1\_kVA\_H4\_RMS (96...127, M8 model)
- PowerQuality.L2\_kVA\_H1\_RMS (DC...31)
- PowerQuality.L2\_kVA\_H2\_RMS (32...63)
- PowerQuality.L2\_kVA\_H3\_RMS (64...95, M8 model)
- PowerQuality.L2\_kVA\_H4\_RMS (96...127, M8 model)
- PowerQuality.L3\_kVA\_H1\_RMS (DC...31)
- PowerQuality.L3\_kVA\_H2\_RMS (32...63)
- PowerQuality.L3\_kVA\_H3\_RMS (64...95, M8 model)
- PowerQuality.L3\_kVA\_H4\_RMS (96...127, M8 model)
- PowerQuality.V1\_N\_Volts\_H1\_Ang (DC...31)
- PowerQuality.V1\_N\_Volts\_H2\_Ang (32...63)
- PowerQuality.V1\_N\_Volts\_H3\_Ang (64...95, M8 model)
- PowerQuality.V1\_N\_Volts\_H4\_Ang (96...127, M8 model)
- PowerQuality.V2\_N\_Volts\_H1\_Ang (DC...31)
- PowerQuality.V2\_N\_Volts\_H2\_Ang (32...63)
- PowerQuality.V2\_N\_Volts\_H3\_Ang (64...95, M8 model)
- PowerQuality.V2\_N\_Volts\_H4\_Ang (96...127, M8 model)
- PowerQuality.V3\_N\_Volts\_H1\_Ang (DC...31)
- PowerQuality.V3\_N\_Volts\_H2\_Ang (32...63)
- PowerQuality.V3\_N\_Volts\_H3\_Ang (64...95, M8 model)
- PowerQuality.V3\_N\_Volts\_H4\_Ang (96...127, M8 model)
- PowerQuality.VN\_G\_Volts\_H1\_Ang (DC...31)
- PowerQuality.VN\_G\_Volts\_H2\_Ang (32...63)
- PowerQuality.VN\_G\_Volts\_H3\_Ang (64...95, M8 model)
- PowerQuality.VN\_G\_Volts\_H4\_Ang (96...127, M8 model)
- PowerQuality.V1\_V2\_Volts\_H1\_Ang (DC...31)
- PowerQuality.V1\_V2\_Volts\_H2\_Ang (32...63)
- PowerQuality.V1\_V2\_Volts\_H3\_Ang (64...95, M8 model)
- PowerQuality.V1\_V2\_Volts\_H4\_Ang (96...127, M8 model)

- PowerQuality.V2\_V3\_Volts\_H1\_Ang (DC...31)
- PowerQuality.V2\_V3\_Volts\_H2\_Ang (32...63)
- PowerQuality.V2\_V3\_Volts\_H3\_Ang (64...95, M8 model)
- PowerQuality.V2\_V3\_Volts\_H4\_Ang (96...127, M8 model)
- PowerQuality.V3\_V1\_Volts\_H1\_Ang (DC...31)
- PowerQuality.V3\_V1\_Volts\_H2\_Ang (32...63)
- PowerQuality.V3\_V1\_Volts\_H3\_Ang (64...95, M8 model)
- PowerQuality.V3\_V1\_Volts\_H4\_Ang (96...127, M8 model)
- PowerQuality.I1\_Amps\_H1\_Ang (DC...31)
- PowerQuality.I1\_Amps\_H2\_Ang (32...63)
- PowerQuality.I1\_Amps\_H3\_Ang (64...95, M8 model)
- PowerQuality.I1\_Amps\_H4\_Ang (96...127, M8 model)
- PowerQuality.I2\_Amps\_H1\_Ang (DC...31)
- PowerQuality.I2\_Amps\_H2\_Ang (32...63)
- PowerQuality.I2\_Amps\_H3\_Ang (64...95, M8 model)
- PowerQuality.I2\_Amps\_H4\_Ang (96...127, M8 model)
- PowerQuality.I3\_Amps\_H1\_Ang (DC...31)
- PowerQuality.I3\_Amps\_H2\_Ang (32...63)
- PowerQuality.I3\_Amps\_H3\_Ang (64...95, M8 model)
- PowerQuality.I3\_Amps\_H4\_Ang (96...127, M8 model)
- PowerQuality.I4\_Amps\_H1\_Ang (DC...31)
- PowerQuality.I4\_Amps\_H2\_Ang (32...63)
- PowerQuality.I4\_Amps\_H3\_Ang (64...95, M8 model)
- PowerQuality.I4\_Amps\_H4\_Ang (96...127, M8 model)

## Sag and Swell Detection

The PowerMonitor 5000 unit continually monitors line voltages and sets an alarm flag when the voltage varies below (sag) or above (swell) a predetermined threshold, expressed as a percentage of the nominal system voltage. The PowerMonitor 5000 models detect and report sags and swells in different ways:

- The M5 model detects sags and swells and reports them in the Alarm Log.
- The M6 and M8 models retain the simple sag/swell capabilities of the M5 model but also permit you to adjust sag and swell thresholds. In addition, fixed sag and swell thresholds corresponding to definitions found in IEEE 1159 and EN 50160 independently detect and report sags and swells. When sags or swells are detected, these models record waveforms and record detailed event information in the Power Quality Log.

## Setup

Basic metering configuration is required:

- All models include fixed thresholds for sag and swell alarming: 90% of nominal for sags, 110% of nominal for swells, each with a 2% of nominal hysteresis.
- In the M6 and M8 models, multi-level sag and swell thresholds and hysteresis are user-configurable and can be adjusted by use of the Configuration.PowerQuality web page or data table. The parameters are listed in [Table 14](#). Defaults have been selected to effectively disable user-configurable sag and swell detection, to avoid creating redundant events in the Power Quality Log.

**Table 14 - Multi-level Sag and Swell Configuration Parameters**

Parameter	Default	Range
Sag1_Trip_Point_%	0%	0.00...100.00
Sag1_Hysteresis_%	2%	0.00...10.00
Sag2_Trip_Point_%	0%	0.00...100.00
Sag2_Hysteresis_%	2%	0.00...10.00
Sag3_Trip_Point_%	0%	0.00...100.00
Sag3_Hysteresis_%	2%	0.00...10.00
Sag4_Trip_Point_%	0%	0.00...100.00
Sag4_Hysteresis_%	2%	0.00...10.00
Sag5_Trip_Point_%	0%	0.00...100.00
Sag5_Hysteresis_%	2%	0.00...10.00
Swell1_Trip_Point_%	200%	100.00...200.00
Swell1_Hysteresis_%	2%	0.00...10.00
Swell2_Trip_Point_%	200%	100.00...200.00
Swell2_Hysteresis_%	2%	0.00...10.00
Swell3_Trip_Point_%	200%	100.00...200.00
Swell3_Hysteresis_%	2%	0.00...10.00
Swell4_Trip_Point_%	200%	100.00...200.00
Swell4_Hysteresis_%	2%	0.00...10.00

## Operation

The power monitor detects a sag when any phase voltage varies below the fixed sag threshold. A swell is detected when any phase voltage exceeds a swell threshold.

Sag and swell detection operate on line-to-line voltages in Delta wiring modes, and on line-to-neutral voltages in Wye and split-phase wiring modes.

### Status

The [Status.Alarms Data Table](#), on [page 348](#), provides the following tags for monitoring of sags and swells. A sag or swell indication continues until 90 seconds has elapsed after all phase voltages return to the threshold, providing a more reliable indication of sags and swells when these tags are logged at a 1-minute interval.

- Sag\_Indication\_Detected
- Swell\_Indication\_Detected

Sags and swells are also recorded in the alarm log with alarm type = 4 and alarm code = 1 for sag, 2 for swell. In the M6 and M8 models, sags and swells, their trip points, and references to their associated waveform records are also recorded in the Power Quality log.

### Related Functions

- Basic Metering setup
- Power Quality setup
- Waveform Recording
- Power Quality Log

## Waveform Recording (M6 and M8 model)

The power monitor can capture and record waveforms of all current and voltage channels.

### Setup

Basic metering setup is required. These configuration parameters are found in the Configuration.PowerQuality tab:

- Capture\_Pre\_Event\_Cycles - pre-event cycles for waveform capture, range = 5 (default)...10 cycles
- Capture\_Post\_Event\_Cycles - post-event cycles for waveform capture, range = 2...30 cycles, default 15

These configuration parameters are found in the Configuration.Communications\_Native tab, and specify the synchronized waveform broadcast parameters:

- WSB\_Mode - waveform synchronization broadcast mode. The options are the following:
  - 0 = Disable (default)
  - 1 = Enable
- WSB\_Port - specified UDP port for WSB feature, range = 1001 (default)...1009



To enable WSB capture of waveforms, PTP (IEEE 1588) must be enabled and the power monitor must be synchronized with the PTP clock. See [Network Time Synchronization on page 213](#).

## Operation

Waveforms are recorded as a sequence of single-cycle harmonic data and stored in a compressed file format in the power monitor. The PowerMonitor 5000 unit can store up to 256 waveform files or a total of 21,600 cycles of waveform data. The maximum size of a waveform record is 3600 cycles plus the specified pre-event and post-event numbers of cycles.

Waveform capture is triggered in three ways:

- Manually, through a command
- Automatically by the power monitor when the unit detects a sag, swell, or transient event
- In response to a waveform synchronization broadcast message

Waveform triggers are ignored when insufficient space remains to store a new waveform.

Waveform files can be cleared by using the Clear\_Waveform command. See [Commands on page 107](#).

The waveform voltage source depends on the Metering\_Mode parameter value. For Demo, split-phase, or Wye modes, phase voltage (V-N) is used. For Delta and single phase, line-to-line voltages are used. If the metering mode is changed while a waveform capture is active, the active capture is stopped and saved.

### *Manual Waveform Recording on Command*

A manually triggered waveform recording has a length of 30 cycles plus the pre-event and post-event cycles.

### *Waveform Recording Triggered by Sag, Swell, or Transient*

The length of a waveform recording that is triggered by a power quality event is equal to the duration of the event (but no more than to 3600 cycles) plus the pre-event and post-event cycles.

### *Network Synchronized Waveform Recording*

The power monitor can receive and send remote waveform capture triggers by using Waveform Synchronization Broadcast (WSB) messages through a UDP port by using native Ethernet communication. The two types of WSB messages are start waveform and end waveform. Each type of message also contains a network id (last 3 bytes of the originator's MAC ID), trigger type (sag, swell, or user command) and timestamp information.

WSB is disabled by default. If WSB is disabled, the unit neither sends nor receives WSB messages. If WSB is enabled, and PTP is enabled and synchronized, the unit broadcasts a WSB start message when an internal triggering event begins and broadcast a WSB end message when the event is finished. When a unit receives a WSB message through the selected UDP port, the unit starts recording a waveform that is aligned with the WSB start message timestamp, ending the waveform recording when the WSB end message is received from the originator. If the WSB end message is lost, the recording ends when 3600 cycles have been recorded.

If the PTP clock is not synchronized (IsSynchronized value = 0), WSB messages are not broadcast or acted upon if received.

#### *Waveform Capture Application Considerations*

The PowerMonitor 5000 unit captures one waveform record at a time. There is a possibility that multiple triggering event can occur in a short time. The starting point of a waveform capture is determined by the first triggering event and the defined pre-event cycles. If fewer cycles of data are available, then the first available cycle is the starting point.

If multiple triggering event occurs during a waveform capture, the capture duration extends to include the duration of the event that ends latest, plus the post-trigger cycles. A waveform record that includes multiple triggering event is referenced in all power quality log records of the triggering events.

Pre-event or post-event cycle settings that are changed during a waveform capture do not take effect until the next capture. Any change to Configuration.Metering\_Basic immediately ends a waveform capture that is in process.

In the unlikely event that the PowerMonitor 5000 unit resources are overstressed so that the unit is unable to write a waveform record to non-volatile memory in a timely fashion, the in-process waveform record ends with the latest cycle that is captured in RAM.

## Commands

The following waveform-related commands are found in the [Command.System\\_Registers](#) table on [page 368](#).

### *Command Word Two*

Set this command word value to execute the listed action. The selections for this parameter:

- 14 = Trigger Waveform
- 15 = Clear Waveform

Clear Waveform operates by using the value that is contained in [Clear Waveform File ID](#). The default value is zero.

### *Clear Waveform File ID*

Waveform File ID, the choices are the following:

- 0 = Clear All
- 1...999 = Clear selected; if the ID does not exist, the command is ignored

## Waveform File Names

Waveform files are stored with names that contain file identification and a local timestamp. The file name syntax is:

*Waveform\_ID\_YYYYMMDD\_hhmmss\_MicroS\_HH*, where

- ID = the file identifier, which is used in the Clear\_Waveform command
- YYYYMMDD\_hhmmss = the local date and time stamp of the record, used to associate the waveform file with a power quality log record
- MicroS = the microsecond timestamp of the record, which is used for aligning WSB waveform records
- HH = the UTC hour avoids duplication during daylight-saving time transition

## Retrieving Waveform Records by Using FTP

You can retrieve compressed waveform files by using File Transfer Protocol (FTP) and native Ethernet communication. A number of FTP clients are available many at no cost. This example uses Microsoft® Internet Explorer as the FTP client. To access and download waveform files by using a web browser, follow these steps.

1. Open Internet Explorer and browse to the FTP server of the PowerMonitor 5000. The url is ftp://<ip\_address>/, where <ip\_address> is the one assigned to the native Ethernet port.
2. Browse to the Waveform directory.

### FTP directory /Waveform/ at 192.168.200.102

To view this FTP site in Windows Explorer, click **Page**, and then click **Open FTP Site in Windows Explorer**.

[Up to higher level directory](#)

```

01/01/2000 09:56AM      Directory .
01/01/2000 09:56AM      Directory ..
06/11/2013 01:09PM          76,712 Waveform\_003\_20130609\_204507\_819293\_02.wfm
06/11/2013 01:09PM    2,397,056 Waveform\_005\_20130611\_125429\_223476\_18.wfm
06/11/2013 01:09PM    3,518,904 Waveform\_001\_20130603\_190517\_413128\_01.wfm
06/11/2013 01:09PM    1,323,984 Waveform\_002\_20130604\_090959\_415726\_15.wfm
06/11/2013 01:09PM          76,712 Waveform\_004\_20130609\_204509\_976837\_02.wfm
06/13/2013 06:57PM          76,712 Waveform\_007\_20130613\_185750\_052339\_00.wfm
06/11/2013 01:10PM    12,587,756 Waveform\_006\_20130611\_130948\_411674\_19.wfm
06/15/2013 01:17AM          83,680 Waveform\_008\_20130615\_011748\_786156\_07.wfm

```

3. Select a waveform file name from the list and click the Save to save the file in the location of your choosing

---

**IMPORTANT** If you are using FactoryTalk EnergyMetrix software to log data from your PowerMonitor 5000 unit, the software can automatically download and clear waveform files shortly after they have been recorded. In this case, the file list in the FTP client is empty. Use the software to view and manage waveform files.

---

## Reading Waveform Records by Using the Data Table Interface

The procedure for reading waveform records is similar to the procedure used for reading data logging records. Refer to [Reading Waveform Records by Using the Data Table Interface on page 108](#).

## **Related Functions**

- Sag and Swell Detection
- Network Time Synchronization
- Power Quality Log

## **Application**

Reading waveform records applies only to the M6 and M8 models.

**Notes:**

## Logging

Topic	Page
Logging Overview	112
Waveform Log (M6 and M8 model)	118
Energy Log	134
Data Log	138
Min/Max Log	148
Load Factor Log	155
Time-of-use (TOU) Log	156
Event Log	159
Setpoint Log	163
Alarm Log	165
Power Quality Log (M6 and M8 model)	171
Trigger Data Log (M6 and M8 model)	176
Snapshot Log	179
EN 50160 Weekly and Yearly Logs	181

This section describes the functions of the PowerMonitor™ 5000 unit. Most functions require you to configure set-up parameters to align the unit with your installation and your application requirements. The set-up parameters are listed by name and described in this section. You can view set-up parameters by using the PowerMonitor 5000 web page, and when logged in to an Admin account, make changes to the setup. Set-up parameters are also accessible by using communication.

See the [PowerMonitor 5000 Unit Data Tables](#), in [Appendix A](#), for additional information on setup parameters including the following:

- Range of valid values
- Default values
- Data type

Set-up parameters can be found in data tables with names beginning with 'Configuration', for instance Configuration.Metering\_Basic.

## Logging Overview

The PowerMonitor 5000 unit maintains a number of types of internal data logs and records metering, status, event, and alarm data into these logs as specified in the logging configuration. This table summarizes the data log types and sizes, and how their records can be retrieved.

Log Type	Model	Max Number of Records	Log Data Retrieval Method			
			Read Selected Record	Read Records Sequentially, in Forward or Reverse Order	Web File Download	FTP File Download
Waveform log	M6 and M8	21,600 cycles, 256 files	•	•		•
Energy log	All	90 days (129,600 @ 1 minute log rate)		•	•	•
Data log	All	60,000 @ 32 parameters		•	•	•
Min/Max log	All	82 parameters (M5, M6) 207 parameters (M8)	•	•	•	•
Load Factor log	All	13 Including Current Month	•	•	•	•
Time-of-Use log	All	13 Including Current Month	•	•	•	•
Alarm log	All	100 Alarms		•	•	•
Event log	All	100 Events		•	•	•
Setpoint log	All	100 Setpoint Events		•	•	•
Power Quality log	M6 and M8	100		•	•	•
Trigger Data log	M6 and M8	3600 cycles, 60 files		•	•	•
Snapshot log	M6	2270 parameters 1 file		•	•	•
	M8 group 0	4447 parameters, 1 file		•	•	•
	M8 group 1	1233 parameters, 1 file		•	•	•
	M8 group 2	20,439 parameters, 1 file		•	•	•
EN50160 Weekly Log	M8	8 including current day	•	•	•	•
EN50160 Yearly Log	M8	13 including current month	•	•	•	•

## Setup

The following set-up parameters define the behavior of the data logging functions in the PowerMonitor 5000 unit, except for the Data Log, which has its own set of set-up parameters. These parameters are found in the [Configuration.Logging](#) table on [page 289](#).

### *Energy\_Log\_Interval*

Energy\_Log\_Interval selects how often a record is logged, in minutes:

- 0 = Disables energy logging
- 1...60 = Length of logging interval in minutes
- 1 = Synchronizes energy logging to the end of the demand interval



### *Energy\_Log\_Mode*

Energy\_Log\_Mode defines the log behavior when full:

- 0 = Stop logging
- 1 = Delete oldest energy log file and create a new file

### *Setpoint\_Log\_Mode*

Setpoint\_Log\_Mode defines the log behavior when full.

- 0 = Stop logging
- 1 = Overwrite oldest record

### *Time\_Of\_Use\_AutoStore*

Time\_Of\_Use\_AutoStore defines the day of the month to start a new time-of-use log record.

### *Off\_Peak\_Days*

Off\_Peak\_Days is a bit field that specifies off-peak days of the week.

Bit 0 = Sunday, bit 1 = Monday, and so forth

### *MID\_Peak\_AM\_Hours*

### *MID\_Peak\_PM\_Hours*

### *ON\_Peak\_AM\_Hours*

### *ON\_Peak\_PM\_Hours*

These parameters are bit fields specifying mid-peak and on-peak hours of the weekdays that are not already defined as off-peak. Bit 0 = 12 a.m. ...1 a.m., bit 1 = 1 a.m....2 a.m., and so forth.

### *Load\_Factor\_Auto\_Log\_Setting*

Load\_Factor\_Auto\_Log\_Setting defines the day of month to start a new load factor log record.

### *PowerQuality\_Log\_Mode*

This parameter sets the action of the log once the log has filled to capacity.

- 0 = Stop logging
- 1 = Overwrite oldest record

## Event\_Log\_Mode

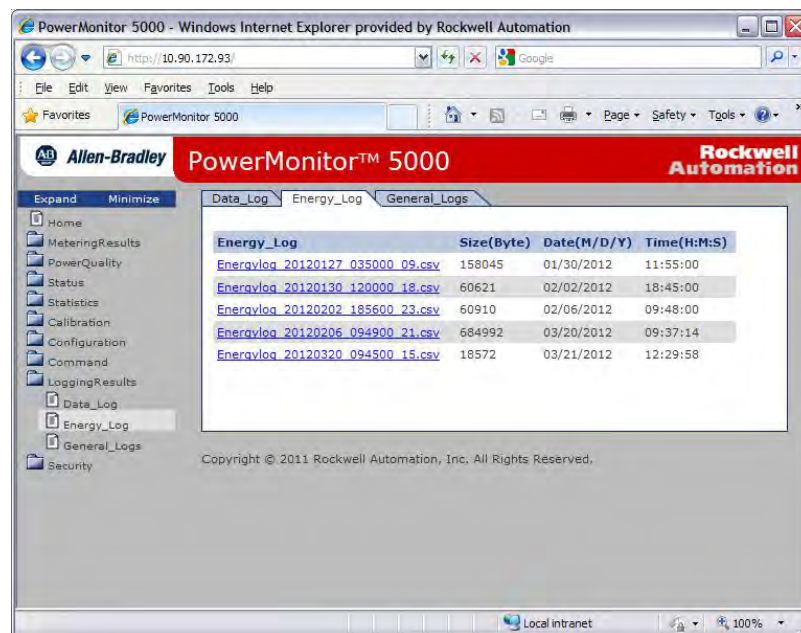
Event\_Log\_Mode defines the log behavior when full.

0 = Stop logging.

1 = Overwrite oldest record.

## Retrieve Logging Results from Web Page

You can retrieve logging results from the PowerMonitor 5000 web page. Browse to the network address of the power monitor. From the home page, choose the LoggingResults folder and then the Data\_Log or another logging results page.



To retrieve a file, click the filename link. A dialog box opens asking if you wish to open the file (in Microsoft® Excel® or another spreadsheet application), or save the file.



Energy and data logs are stored in multiple files. The date and time of the first record of each file is embedded in the file name. The date and time of the most recent record each file is listed in the file creation date and time columns.

## Download Logging Results by Using FTP

You can retrieve logging results by using File Transfer Protocol (FTP). There are many FTP clients available, many at no charge. This example uses the Microsoft Windows command-line FTP client. To access log files by using this client, follow these steps.

1. From the Windows Start menu, choose Run.
2. Type cmd and click OK.
3. At the prompt, type ftp and press Enter (this time and after each command).
4. Type 'open aaa.bbb.ccc.ddd' (the IP address of the power monitor).
5. Log in with a valid user name and password.
6. To view a directory of log files, type 'cd LoggingResults'.
7. Type 'dir'.

```

C:\WINDOWS\system32\cmd.exe - ftp
Microsoft Windows XP [Version 5.1.2600]
(C) Copyright 1985-2001 Microsoft Corp.

C:\Documents and Settings\ranorgan\Desktop>ftp
ftp> open 192.168.200.101
Connected to 192.168.200.101.
220 TracK FTP server ready.
User (192.168.200.101:(none)): rich
331 User name okay, need password.
Password:
230 User logged in, proceed.
ftp> cd LoggingResults
250 CWD requested file action okay, completed.
ftp> dir
200 PORT Command okay.
150 File status okay; about to open data connection.
11-04-66 05:53AM <DIR> .
11-04-66 05:53AM <DIR> ..
02-24-12 09:45AM          31499 DataLog_20120223_073000_19.csv
03-26-12 11:29AM        444458 Energylog_20120223_073000_19.csv
03-26-12 11:29AM        707159 DataLog_20120224_100000_22.csv
03-26-12 09:13AM          5179 Min_Max_Log.csv
03-16-12 12:53PM          968 Time_of_Use_Log.csv
03-21-12 10:54AM          298 Setpoint_Log.csv
03-16-12 12:53PM          801 Event_Log.csv
226 Closing data connection.
ftp> 491 bytes received in 0.00Seconds 491000.00Kbytes/sec.
ftp>

```

8. To download a log file, type 'get' followed by a space and the file name.

The file is saved to the folder where the FTP client was started (typically the Windows desktop).

There are many other FTP commands that you can use. We suggest searching the Web for 'command-line ftp client' for more information.

## Reading Logging Records by Using the Data Table Interface

The Min/Max, Alarm, Event, Load Factor, Time-of-Use, Power Quality, Snapshot, EN50160 Weekly, and EN50160 Yearly logs can be retrieved sequentially, one record at a time, in either forward or reverse order. The Min/Max, Load Factor, Time-of-Use, EN50160 Weekly, and EN50160 Yearly logs also support the retrieval of individually specified records.

The Data, Energy, Waveform, and Trigger Data logs support sequential record retrieval but require additional configuration steps. See [Energy Log on page 134](#), [Waveform Log \(M6 and M8 model\) on page 118](#), [Data Log on page 138](#), and [Trigger Data Log \(M6 and M8 model\) on page 176](#) for more information.

---

**IMPORTANT** Sequential record retrieval is available for networks such as DeviceNet® that do not support FTP. Download speed and performance by using sequential record retrieval is lower than if using FTP.

---

To initiate this type of log retrieval, a controller or application sets parameter values in the [Configuration.Log\\_Read](#) table, writes the table to the power monitor, and then reads the applicable LoggingResults table.

See the [Communication](#) chapter for more information.

### *Selected Log*

Selects the log from which to retrieve information. Once a request has been made, the auto, or sequential, return feature brings back successive records each time the log is read. Some logs support individual record requests. In the Data, Energy, Waveform, and Trigger Logs, the data that are returned are file names of the log files.

Parameter Value	Results Table
1 = Event Log	<a href="#">LoggingResults.Event_Log</a> (sequential only)
2 = Min/Max Log	<a href="#">LoggingResults.MIN_MAX.Log</a>
3 = Load Factor Log	<a href="#">LoggingResults.LoadFactor.Log</a>
4 = Time of Use Log	<a href="#">LoggingResults.TOU.Log</a>
5 = Setpoint Log	<a href="#">LoggingResults.Setpoint_Log</a> (sequential only)
6 = Alarm Log	<a href="#">LoggingResults.Alarm_Log</a> (sequential only)
7 = Data Log File List	<a href="#">LoggingResults.DataLog_FileName</a>
8 = Energy Log File List	<a href="#">LoggingResults.EnergyLog_FileName</a>
9 = Metering Snapshot File	<a href="#">LoggingResults.Snapshot_Log (M6 and M8 model)</a>
10 = Power Quality Log	<a href="#">LoggingResults.Power_Quality_Log (M6 and M8 model)</a>
11 = Waveform Log File	<a href="#">LoggingResults.WaveformFileName (M6 and M8 model)</a>
12 = Trigger Data File	<a href="#">LoggingResults.TriggerData_Log (M6 and M8 model)</a>
13 = Trigger Header File	<a href="#">LoggingResults.TriggerData_Header (M6 and M8 model)</a>
14 = EN50160 Weekly Log	<a href="#">LoggingResults.EN50160_Weekly_Log (M8 only)</a>
15 = EN50160 Yearly Log	<a href="#">LoggingResults.EN50160_Yearly_Log (M8 only)</a>

Requests not supported by the power monitor model are ignored.

### *Chronology of Auto Return Data*

Selects the chronological order of sequentially retrieved records. This parameter is ignored if a specific record is requested from the Min/Max, Load Factor, or TOU log. These values are the choices:

- 0 = Reverse direction (most recent record first)
- 1 = Forward direction (oldest record first)

### *Min/Max Record to be Returned*

These values are the choices:

- 0 = Use sequential return in the order selected
- 1...207 = Retrieve the selected record. See the Min\_Max\_Parameter table for the list

### *Load Factor or TOU Record to be Returned*

These values are the choices:

- 0 = Use sequential return in the order selected
- 1 = Retrieve the current active record
- 2 = Retrieve the latest closed monthly record
- ...
- 13 = Retrieve the earliest closed monthly record

### *EN 50160 Weekly Record to be Returned*

These values are the choices:

- 0 = Use sequential return in the order selected
- 1 = Retrieve the current active record
- 2 = Retrieve the latest closed daily record
- ...
- 8 = Retrieve the earliest closed daily record

### *EN 50160 Yearly Record to be Returned*

These values are the choices:

- 0 = Use sequential return in the order selected
- 1 = Retrieve the current active record
- 2 = Retrieve the latest closed monthly record
- ...
- 13 = Retrieve the earliest closed monthly record

## Waveform Log (M6 and M8 model)

You can retrieve uncompressed waveform records by using the data table interface and optional DeviceNet or ControlNet® network communication.

---

**IMPORTANT** When using native Ethernet network communication, retrieving waveforms by using FTP provides much faster results.

---

Records that are retrieved by using the data table interface are single-cycle harmonic magnitudes and angles from DC to the 63rd (DC to the 127th for the M8 model), returned as REAL values in a sequence of data table reads and writes.

---

**IMPORTANT** Waveform records returned through the data table interface are **not** compressed.

---

To display the record as a waveform, the returned data must be appropriately organized by the client and an inverse FFT performed to obtain a series of time-domain voltage and current data. That data can be plotted in a graphic format.

### Waveform Data Table Retrieval

---

**IMPORTANT** This procedure does not work if Security is enabled. See Security in Chapter 8.

---



---

**IMPORTANT** There are two methods of communication with the device, CIP™ and CSP (PCCC). Whichever method is chosen in the beginning, **MUST BE FOLLOWED THROUGH UNTIL THE END.**

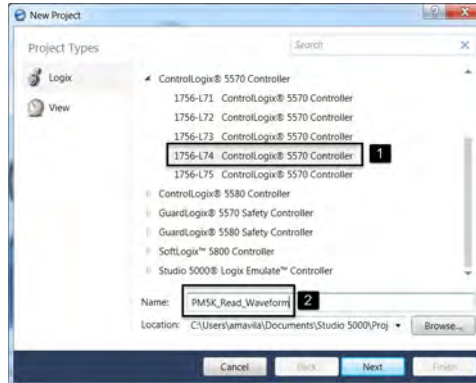
---

A controller or application can sequentially retrieve waveform records. To retrieve waveform records, follow the tasks in this process.

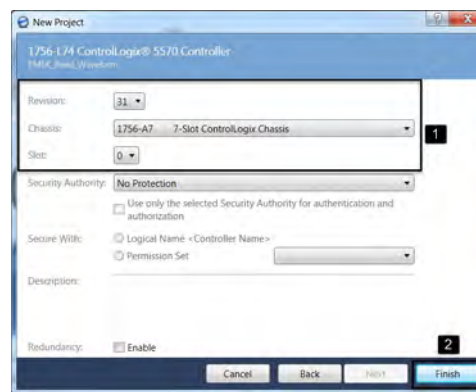
1. Open Studio 5000® environment and select 'New Project'.



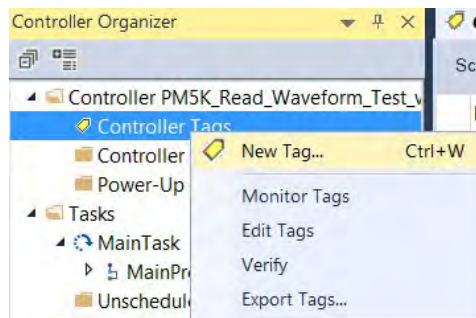
2. Select the controller that is connected with the PowerMonitor device, name your Logix project and click Next.



3. Select the Firmware Revision of the Controller, the Chassis Size, and the slot number where the control module is located, then click Finish.



4. In the Controller Organizer, right-click Controller Tags and choose New Tag.

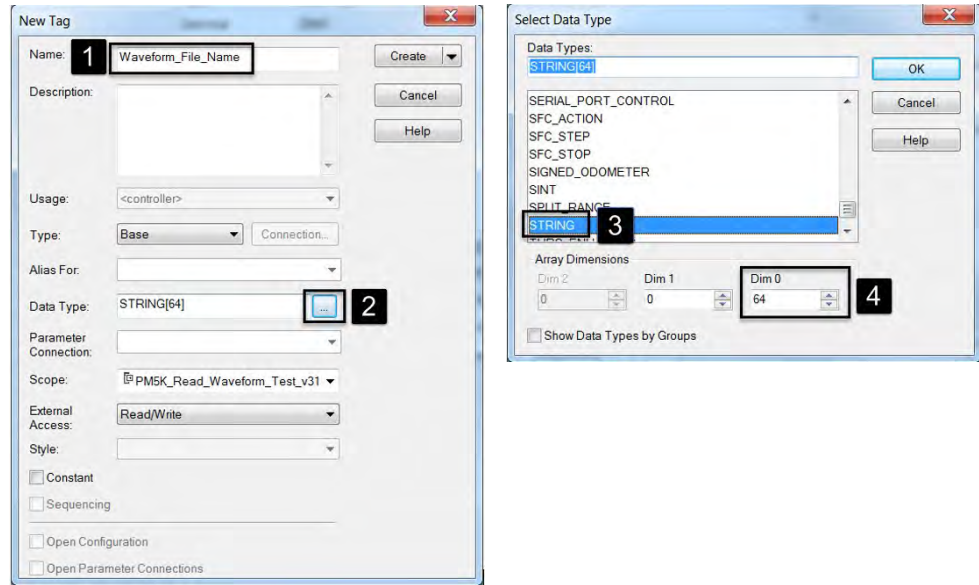


For this example, create the following five tags:

- BITS
- ConfigurationLog\_Read
- Status\_TableWrites
- Waveform\_File\_Name
- Waveform\_LogResults

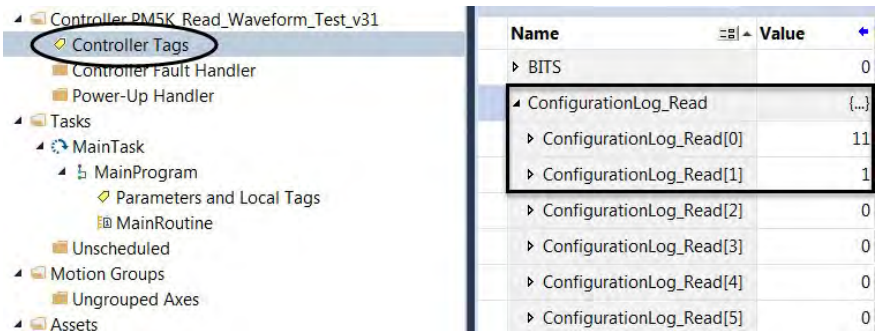
5. From the New Tag dialog box, create the tag.
  - a. Enter a tag name.
  - b. Click the ellipse in the Data Type field.  
The Select Data Type dialog box opens.
  - c. Select the data type.

- d. If necessary, select an Array Dimension for Dim0 by using the arrows.
- e. To close the Select Data Type dialog box, click OK.
- f. To close the New Tag dialog box, click Create.



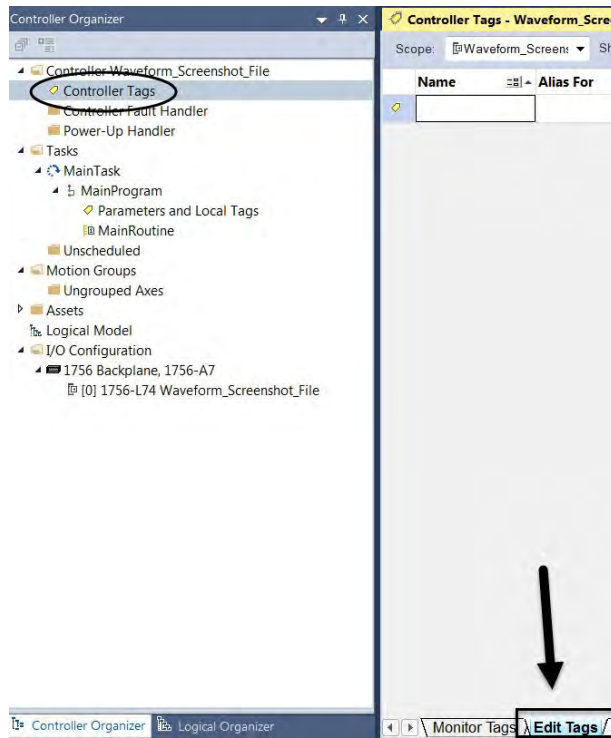
Name	Data Type	Array Dimensions
BITS	DINT	–
Status_TableWrites	INT	15
Waveform_File_Name	STRING	64
Waveform_LogResults	REAL	43
ConfigurationLog_Read	INT	15

6. In the Controller Tags section, set the ConfigurationLog\_Read[0] value to 11 and the ConfigurationLog\_Read[1] value to 1.





7. In the Controller Tags section, click Edit Tags.

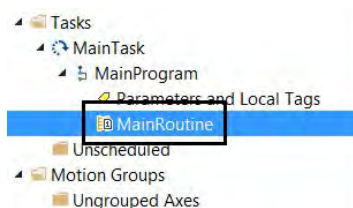


8. Create five message tags with the following descriptions:

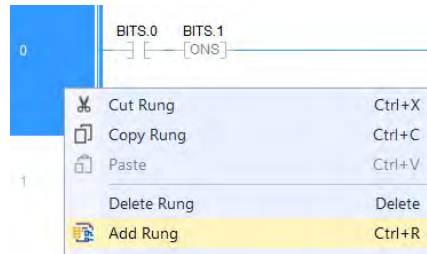
▶ Z_MSG_1		MESSAGE	Config Log Read	Read/Write
▶ Z_MSG_2		MESSAGE	Stat Tbl Write	Read/Write
▶ Z_MSG_3		MESSAGE	Read File Name	Read/Write
▶ Z_MSG_4		MESSAGE	Write File Name	Read/Write
▶ Z_MSG_5		MESSAGE	Read Waveform	Read/Write

### Create a Program String

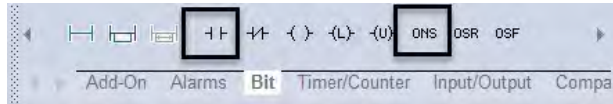
1. From the Controller Organizer under Main Program, double-click 'MainRoutine'.



- To create a routine, right-click and choose Add Rung.

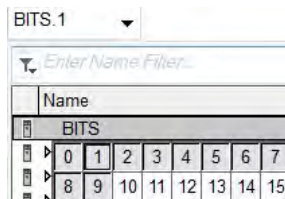


- In the toolbar, select 'Bit' and add 'examine on' and 'one shot' components.

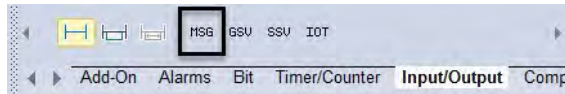


- To name the component, double-click the name and select the BIT of the BITS tag.

- Name the 'examine on' component 'BITS.0'
- Name the 'one shot' component 'BITS.1'



- In the toolbar, select 'Input/Output' and add the MSG component to the same rung.



You create five rungs in total; each with the following components:

- The 'examine on' components are named BITS 0, BITS 2, BITS 4, BITS 6, and BITS 8.
- The 'one shot' components are named BITS 1, BITS 3, BITS 5, BITS 7, and BITS 9.



- For each rung, add a Message Instruction.

These instructions match the description names that are found in [step 8](#) of the [Waveform Data Table Retrieval](#) section. Each message makes use of the Tags that are created in steps [4](#) and [5](#) of the [Waveform Data Table Retrieval](#) section.

---

**IMPORTANT** Two of the Messages share a tag, therefore there are five messages and only four tags.

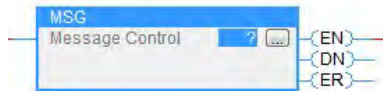
---

- See [Common Industrial Protocol Method to Retrieve Waveforms](#) or [PCCC Method to Retrieve Waveforms](#) to configure the message instruction.

### Common Industrial Protocol Method to Retrieve Waveforms

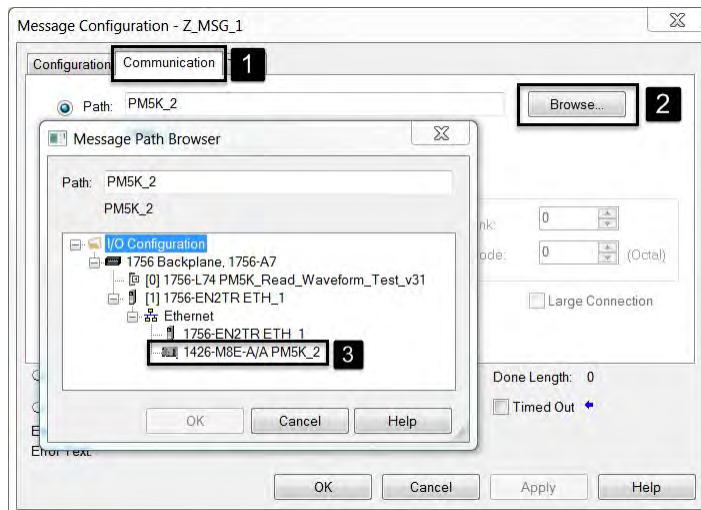
These steps are for the CIP™ method. If you choose this method, continue only with this method until finished.

- To communicate to the device within the I/O tree, click the ellipses on the MSG component and select Communication (1).

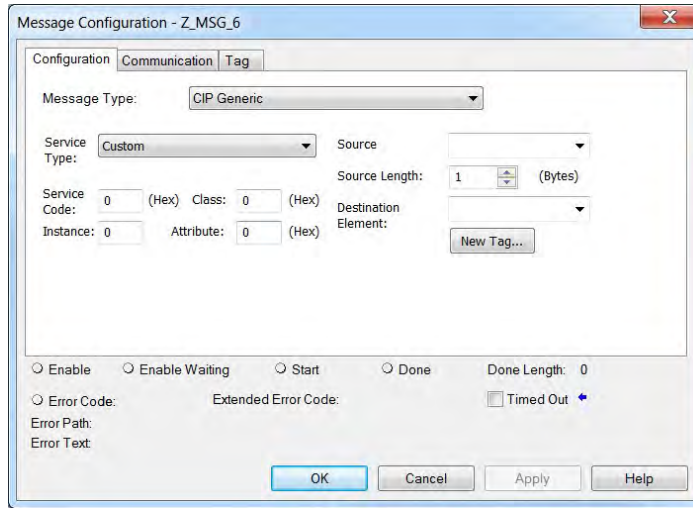


- Click Browse (2), select your device module in the I/O tree (3), and click Apply.

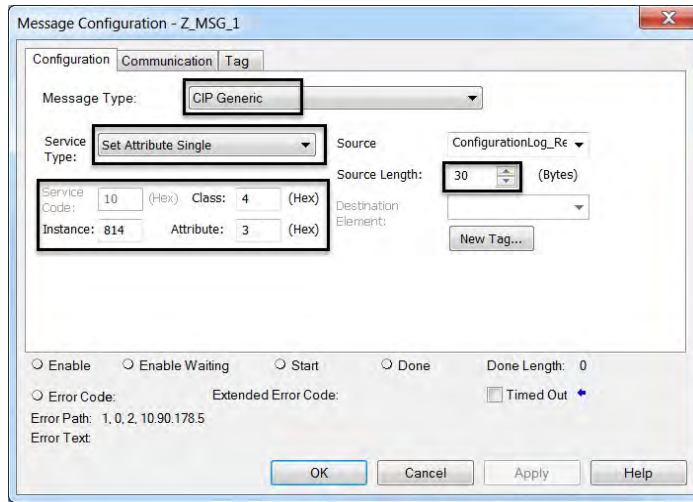
Complete this step for ALL message components.



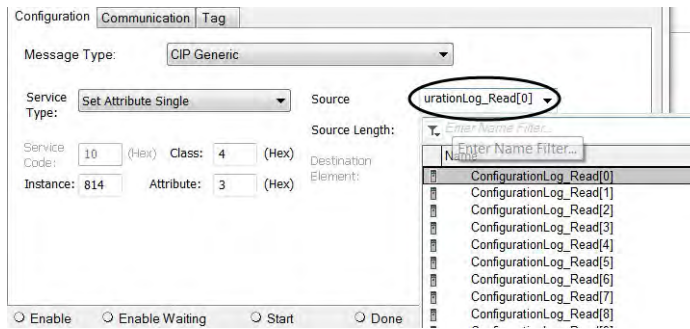
- Click the ellipses and navigate to the Configuration tab. The Configuration tab dialog box opens.



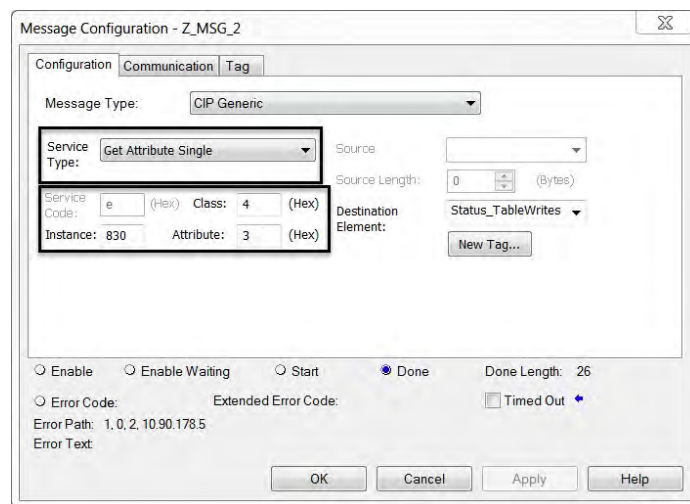
- For the 'Config Log Read' message, verify that the Service type is set to 'Set Attribute Single' and the Source Length set to 30.
- Set the parameters as shown in the dialog box.



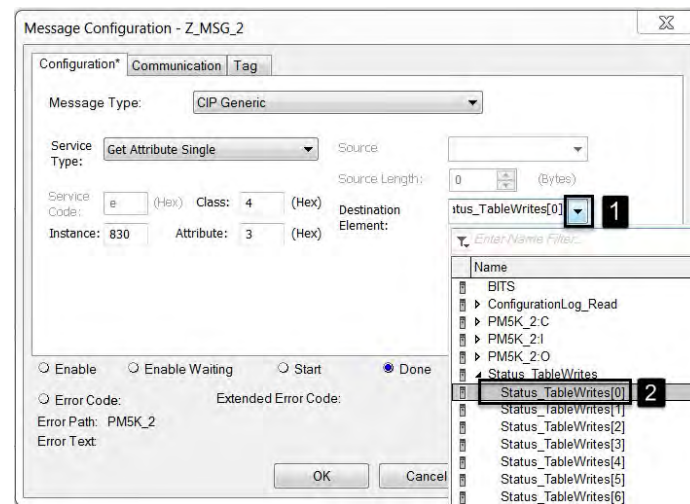
- Set the Source for the Configuration Log Read MSG to 'ConfigurationLog\_Read[0]'.



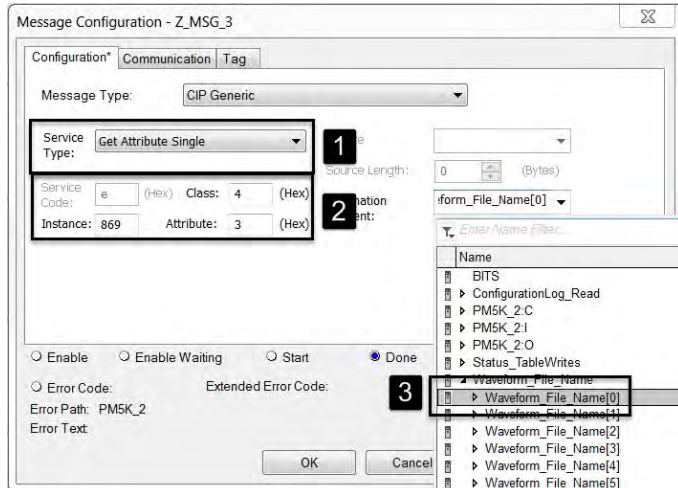
- For the 'Status Table Write' message, set the service type to 'Get Attribute Single' and set the parameters to match the 'Status Table Write' Instance.



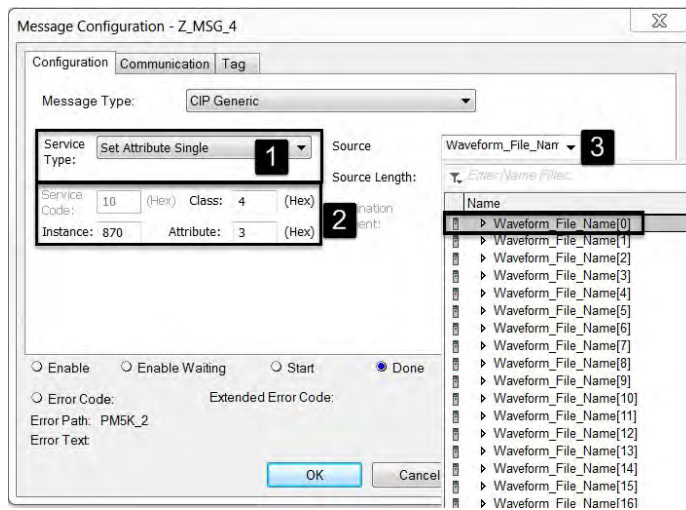
- Set the Destination Element (1) to 'Status\_TableWrites[0]'.



9. For the 'Read File Name' message, set the service type (1) to 'Get Attribute Single' and set the parameters (2) to match the 'Status Table Write' Instance.
10. Set the Destination Element (3) to Waveform\_File\_Name[0].

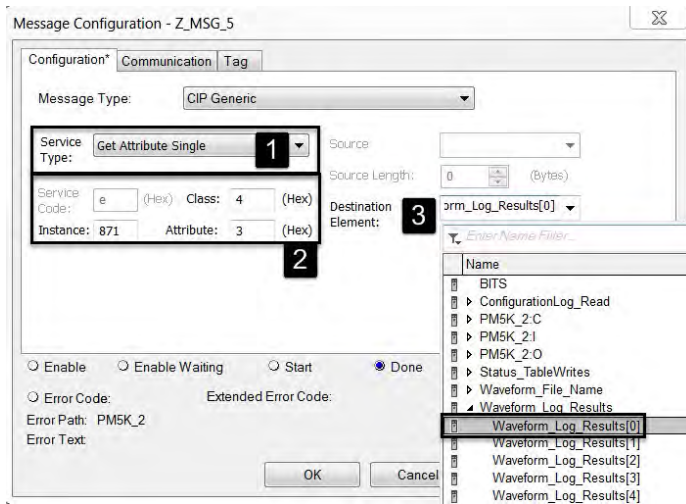


11. For the 'Write File Name' message, set the service type (1) to 'Set Attribute Single' and set the parameters (2) to match the 'Configuration.WaveformFileName' Instance.
12. Set the source (3) to Waveform\_File\_Name[0].



13. For the 'Read Waveform' message, set the Service Type (1) to 'Get Attribute Single' and set the parameters (2) to match the 'LoggingReults.Waveform Log' Instance.

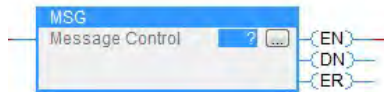
- Set the Destination Element (3) to Waveform\_Log\_Results[0].



### PCCC Method to Retrieve Waveforms

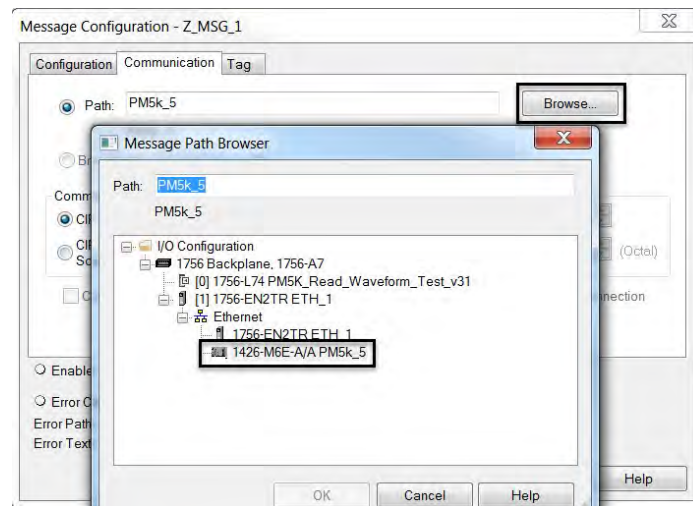
These steps are for the PCCC method. If you choose this method, continue only with this method until finished.

- To communicate to the device within the I/O tree, click the ellipses on the MSG component and select Communication.



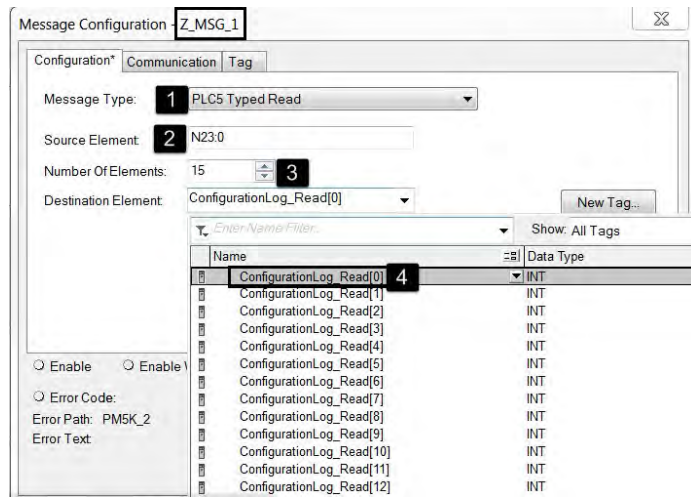
- Click Browse and select your device module in the I/O tree.

Complete this step for ALL message components.

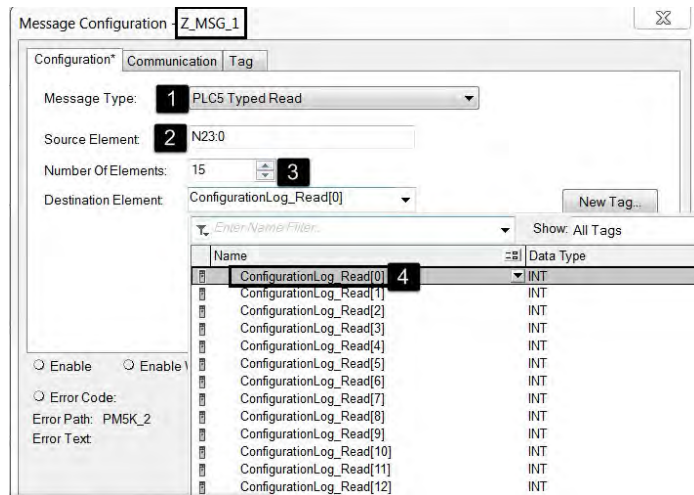


The PCCC method is similar to the CIP method.

- For the 'Config Log Read' message, select 'ConfigurationLog\_Read[0]' as the Destination Element and configure the message as shown in the dialog box.

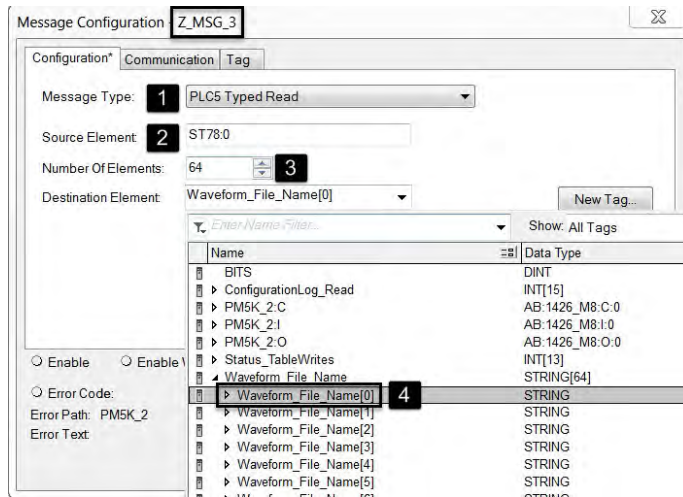


- For the 'Stat Tbl Write' message, select 'Status\_TableWrites[0]' as the Destination Element and configure the message as shown in the dialog box.

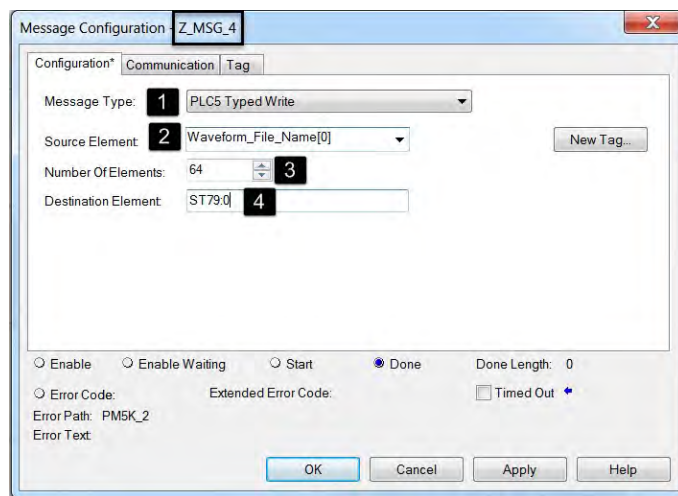




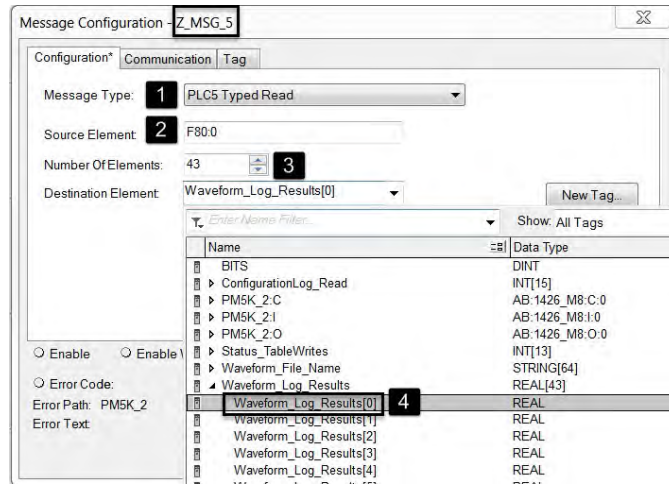
- For the 'Read File Name' message, select 'Waveform\_File\_Name[0]' as the Destination Element and configure the message as shown in the dialog box.



- For the 'Write File Name' message, select 'Waveform\_File\_Name[0]' as the Destination Element and configure the message as shown in the dialog box.

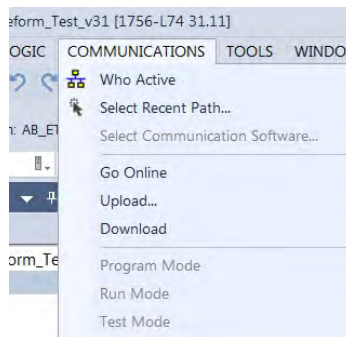


- For the 'Read Waveform' message, select 'Waveform\_Log\_Results[0]' as the Destination Element and configure the message as shown in the dialog box.



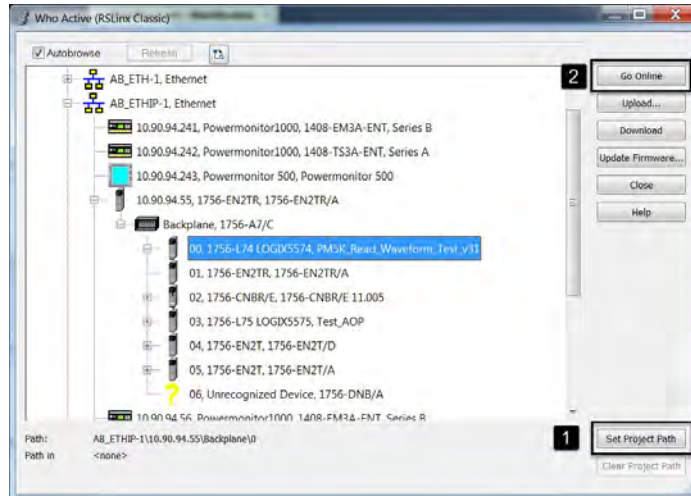
## Driving the Main Program

- In the toolbar at the top of the Logix Designer application, click Communications and select Who Active.



- Navigate to your controller and click 'Set Project Path', then 'Go Online'.

**IMPORTANT** The controller slot is dependent on your controller.



- Within the main program, toggle the bit within each rung in this order.

To toggle the bit, you can either right-click on the bit and click toggle or press Ctrl-T on the keyboard.

RUNG 0 (Config Log Read)

RUNG 1 (Stat Tbl Write)

The use of Rung 1 is optional and can be used to confirm the Wights (RUNG 0 and RUNG 3) were accepted by the Power Monitor 5000. See [Status.TableWrites Table 113 on page 346](#) for additional information.

RUNG 2 (Read File Name)

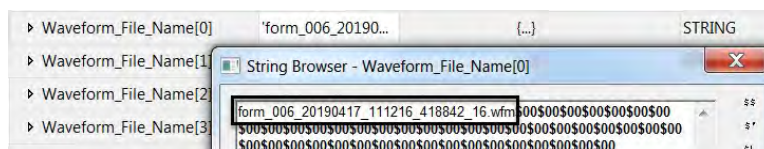
RUNG 3 (Write File Name)

RUNG 1 (Stat Tbl Write)

Rung 2 must be toggled several times until the Waveform file name of interest is read. If an empty File Name is read, you have reached the end of the File Name list. Once read, proceed to Rung 3.

RUNG 4 (Read Waveform)

Rung 4 must toggle on and off several times to read the full file. The number of times depends on the size of the Waveform file. When all zeros (00) are returned the file is complete. This read can take some time.



By toggling Rung 4 multiple times, you are selecting which waveform to retrieve.

*Waveform Data Records*

The [LoggingResults.Waveform\\_Log Data Table](#), on [page 396](#), contains the most recent record that is read from the selected waveform file, and contains the following REAL elements.

Element Number	Tag Name	Description
0	Record_Indicator	Indicates the significance of the data in the record 0 = No record returned 1 = the record contains parameter values 2 = the record contains general information of the log file being retrieved, reference to each item description in the data table; 3 = log file not found.
1	Timestamp_Date	Date of cycle collection MMDDYY
2	Timestamp_Time	Time of cycle collection hhmmss
3	Microsecond_Stamp	Microsecond of cycle collection
4	File_ID	The selected file ID
5	Total_Cycles	Total cycles of the waveform file
6	Cycle_Returned	The current returned cycles
7	Frequency	The frequency of average cycle
8	Mag_Angle	The returned value is magnitude or angle
9	Channel	The channel returned
10	Order	The order of returned values
11	X_(0 + Order * 32)	The returned value X_(h) where X_(h) = the RMS magnitude or angle of the spectral component h. Units are Volts, Amps or degrees, depending on the value of Channel and Mag_Angle elements
12	X_(1 + Order * 32)	
...	...	
42	X_(31 + Order * 32)	

### Waveform Header

If the value of Record\_Indicator is 2, the [LoggingResults.Waveform\\_Log Data Table](#), on [page 396](#), returns the following information. The data type returned is REAL, although some elements (MAC ID) are better interpreted as UINT32.

Element Number	Tag Name	Description
0	Record_Indicator	Indicates the significance of the data in the record 2 = the record contains general information of the log file being retrieved, reference to each item description in the data table;
1	File_ID	The selected file ID
2	Waveform_Identifier_High	File ID (Int16)+ Waveform Identifier(Int48)
3	Waveform_Identifier_Low	typedef struct { unsigned short sFileID; //this id is used for user selection, 1...256 unsigned short sWaveformID; //the Waveform id highest 2 bytes unsigned long lWaveformID; //the Waveform id Lowest 4 bytes }WAVEFORM_ID;
4	Revision	Waveform file format revision
5	Compression	Indicate compression or not and the compression type, high 8 bits is compression flag, low 8 bits is compression type
6	Metering_Mode	Metering mode, indicates that voltages are L-N or L-L
7	Mac_Address_High	Mac address of power monitor - high 3 bytes
8	Mac_Address_Low	Low 3 bytes
9...42	Reserved	Reserved for future use

If the waveform retrieval is interrupted for more than 60 seconds, the sequence must reinitialize by writing the [Configuration.WaveformFileName Data Table](#) on [page 334](#). Appending the filename with selection switches configured for the next record in sequence begins the retrieval where the unit left off before the interruption.

See [Waveform Recording \(M6 and M8 model\) on page 104](#) for more information about waveform setup, operation, commands, related functions, and retrieval via FTP and the native Ethernet port.

## Energy Log

The energy log stores energy, demand, and scaled status input counter values at a time interval defined in parameter Energy\_Log\_Interval. The power monitor can store up to 90 days of energy log data. The default logging interval is 15 minutes.

### Energy Log Results Files

The PowerMonitor 5000 unit stores the energy log in multiple comma-separated-value (.csv) files, and selects a file duration that is based on the value of the Energy\_Log\_Interval parameter.

Interval Setting (minutes)	Log Duration	File End Date	Maximum Records
1	Day	Sunday, 00:00:00	1440
2 or above	Week	1st day of a new month, 00:00:00	5040

In addition, the active energy log file is closed and a new file is created when any of the following events occur:

- Initial powerup of the power monitor
- Subsequent powerup, if the active energy log file is older than the expected duration
- If the Energy\_Log\_Interval parameter is changed

The Energy\_Log\_Mode parameter determines what happens when the log contains 90 days of data:

- If set to 0 = Stop Logging, no new energy log files are created and no more energy data is logged.
- If set to 1 = Delete oldest energy log file and create a new file, a new file is created and energy logging continues uninterrupted. This value is the default setting.

### File Names

Energy log file names have the following semantics:

EnergyLog\_YYYYMMDD\_hhmm\_HH.csv

Where:

- YYYYMMDD\_hhmm - the file creation date and time
- HH - UTC hour avoids duplication during daylight-saving time transition

## Logged Parameters

The energy log records a predefined set of parameters. The first record in each file is a header that indicates the tag name of each parameter. Each subsequent record is a structure of REAL elements containing the following parameters.

**Table 15 - Energy Log Parameters**

Element	Tag Name	Description
0	Record_Indicator	Indicate meanings of the data in the record
1	Energy_Record_Identifier	Internal unique record number
2	Energy_Timestamp_Year	The date and time of the record
3	Energy_Timestamp_Mth_Day	
4	Energy_Timestamp_Hr_Min	
5	Energy_Timestamp_Sec_ms	
6	Status_1_Count_xM	Scaled Status input 1 counter
7	Status_1_Count_x1	
8	Status_2_Count_xM	Scaled Status input 2 counter
9	Status_2_Count_x1	
10	Status_3_Count_xM	Scaled Status input 3 counter
11	Status_3_Count_x1	
12	Status_4_Count_xM	Scaled Status input 4 counter
13	Status_4_Count_x1	
14	GWh_Fwd	Forward real energy
15	kWh_Fwd	
16	GWh_Rev	Reverse real energy
17	kWh_Rev	
18	GWh_Net	Net real energy
19	kWh_Net	
20	GVARH_Fwd	Forward reactive energy
21	kVARh_Fwd	
22	GVARH_Rev	Reverse reactive energy
23	kVARh_Rev	
24	GVARH_Net	Net reactive energy
25	kVARh_Net	
26	GVAh	Net apparent energy
27	kVAh	
28	kW_Demand	The average real, reactive, apparent power and power factor during the last demand period
29	kVAR_Demand	
30	kVA_Demand	
31	Demand_PF	
32	Projected_kW_Demand	The projected average real, reactive, and apparent power for the current demand period
33	Projected_kVAR_Demand	
34	Projected_kVA_Demand	

## Energy Log Single Record Retrieval

A controller or application can sequentially retrieve records from the Energy Log files by following the process that is described in this section, following these general tasks. The tables that are referenced are in [Appendix A](#).

1. Read the number of log files from the [Statistics.Logging](#) table.
2. Write the [Configuration.Log\\_Read](#) table and read the filename from the [LoggingResults.EnergyLog\\_FileName](#) table until the desired log file is selected.
3. Write the selected file name into the [Configuration.EnergyLogFile](#) table.
4. Perform sequential reads of the [LoggingResults.Energy\\_Log](#) table and store the results in a suitable location.

The [Statistics.Logging](#) table contains the following Energy Log information:

- Element 5 and 6, the number of Energy Log records
- Element 10, the number of Energy Log files

The [Configuration.Log\\_Read](#) table contains the following elements:

- Element 0. Write a value of 8 to request the next Energy Log file name
- Element 1: Write a 0 to return the most recent file name first or a 1 to return the oldest file name first

The [LoggingResults.EnergyLog\\_FileName](#) table returns a string containing the requested file name. The file name contains the starting date and time of the log file, as described in [File Names on page 134](#).

The [Configuration.EnergyLogFile](#) table contains the file selection string. Options include the following:

- The desired Energy Log file name from which to return records
- Alternately, 'allfiles', to return records from all Energy Log files
- An appended chronology switch:
  - '/r' to begin with the most recent record
  - '/f' to return the oldest record first (default if no chronology switch is appended)



For example, writing the string 'EnergyLog\_20130112\_0630\_11/r' selects the file EnergyLog\_20130112\_0630\_11. Successive reads of the [LoggingResults.Energy\\_Log](#) table return sequential energy log records, starting with the last record.

The [LoggingResults.Energy\\_Log](#) table contains the most recent record that is read from the selected energy log file, and contains the following elements:

- Element 0 indicates the type of record  
Options are:
  - 0 = No record returned
  - 1 = Parameter values
  - 2 = Reserved
  - 3 = Log file not found
- Element 1 returns a unique record ID.
- Elements 2...5 return the date and time stamp of the record
- Elements 6...34 return parameter values.

Parameter values are listed in the order that is shown in [Energy Log Parameters on page 135](#).

## Setup

The Energy Log requires the following to be configured:

- Basic metering setup
- Logging configuration
- Date and Time setup

## Commands

Clear energy log

## Related Functions

- Energy Metering, Demand Metering
- Data Log
- Configuration lock

## Data Log

The data log stores user-selected values at a time interval that is defined in parameter `Data_Logging_Interval`. The power monitor can store up to 60,000 records of up to 32 parameters. The default logging interval is 15 minutes.

### Setup

The Data Log requires the following to be configured:

- Basic metering setup
- Date and Time setup

The first 22 parameters in the Data Log are configured by default, as listed in the Logged Parameters table. Further configuration of the Data Log is not required if the default selections satisfy your data logging needs.

To customize your Data Log, change the following set-up parameters, which define the behavior of the Data Log. These parameters are found in the [Configuration.Data\\_Log](#) table on [page 324](#).

#### *Data\_Logging\_Interval*

`Data_Logging_Interval` defines the logging interval in seconds. These values are the selections:

- 0 = Disables data logging
- 1 = synchronize log with demand period
- 1...3600 = User-selected data logging interval. Default is 900 (15 minutes)

#### *Logging Mode*

Logging Mode selects how records are saved.

- 0 = Fill and stop recording when log is full.
- 1 = Overwrite when log is full starting with the earliest record.

#### *DataLog\_Parameter\_1*

#### *DataLog\_Parameter\_2*

...

#### *DataLog\_Parameter\_32*

These parameters define the set of records that are maintained in the data log. The [Configuration.Data\\_Log](#) web page includes the descriptions of the default selections for each parameter, even if the selections have been changed from their default value.

## Data Log Parameter List

**Table 16 - Data Log Parameter List**

Parameter Number	Parameter Tag Name	Units
0	None	
1	V1_N_Volts	V
2	V2_N_Volts	V
3	V3_N_Volts	V
4	VGN_N_Volts	V
5	Avg_V_N_Volts	V
6	V1_V2_Volts	V
7	V2_V3_Volts	V
8	V3_V1_Volts	V
9	Avg_VL_VL_Volts	V
10	I1_Amps	A
11	I2_Amps	A
12	I3_Amps	A
13	I4_Amps	A
14	Avg_Amps	A
15	Frequency_Hz	Hz
16	L1_kW	kW
17	L2_kW	kW
18	L3_kW	kW
19	Total_kW	kW
20	L1_kVAR	kVAR
21	L2_kVAR	kVAR
22	L3_kVAR	kVAR
23	Total_kVAR	kVAR
24	L1_kVA	kVA
25	L2_kVA	kVA
26	L3_kVA	kVA
27	Total_kVA	kVA
28	L1_True_PF	%
29	L2_True_PF	%
30	L3_True_PF	%
31	Avg_True_PF	%
32	L1_Disp_PF	%
33	L2_Disp_PF	%
34	L3_Disp_PF	%
35	Avg_Disp_PF	%
36	L1_PF_Lead_Lag_Indicator	-

**Table 16 - Data Log Parameter List (continued)**

Parameter Number	Parameter Tag Name	Units
37	L2_PF_Lead_Lag_Indicator	-
38	L3_PF_Lead_Lag_Indicator	-
39	Total_PF_Lead_Lag_Indicator	-
40	V1_Crest_Factor	-
41	V2_Crest_Factor	-
42	V3_Crest_Factor	-
43	V1_V2_Crest_Factor	-
44	V2_V3_Crest_Factor	-
45	V3_V1_Crest_Factor	-
46	I1_Crest_Factor	-
47	I2_Crest_Factor	-
48	I3_Crest_Factor	-
49	I4_Crest_Factor	-
50	V1_IEEE_THD_%	%
51	V2_IEEE_THD_%	%
52	V3_IEEE_THD_%	%
53	VGN_IEEE_THD_%	%
54	Avg_IEEE_THD_V_%	%
55	V1_V2_IEEE_THD_%	%
56	V2_V3_IEEE_THD_%	%
57	V3_V1_IEEE_THD_%	%
58	Avg_IEEE_THD_V_V_%	%
59	I1_IEEE_THD_%	%
60	I2_IEEE_THD_%	%
61	I3_IEEE_THD_%	%
62	I4_IEEE_THD_%	%
63	Avg_IEEE_THD_I_%	%
64	V1_IEC_THD_%	%
65	V2_IEC_THD_%	%
66	V3_IEC_THD_%	%
67	VGN_IEC_THD_%	%
68	Avg_IEC_THD_V_%	%
69	V1_V2_IEC_THD_%	%
70	V2_V3_IEC_THD_%	%
71	V3_V1_IEC_THD_%	%
72	Avg_IEC_THD_V_V_%	%
73	I1_IEC_THD_%	%
74	I2_IEC_THD_%	%
75	I3_IEC_THD_%	%

Table 16 - Data Log Parameter List (continued)

Parameter Number	Parameter Tag Name	Units
76	I4_IEC_THD_%	%
77	Avg_IEC_THD_I_%	%
78	I1_K_Factor	-
79	I2_K_Factor	-
80	I3_K_Factor	-
81	Pos_Seq_Volts	V
82	Neg_Seq_Volts	V
83	Zero_Seq_Volts	V
84	Pos_Seq_Amps	A
85	Neg_Seq_Amps	A
86	Zero_Seq_Amps	A
87	Voltage_Unbalance_%	%
88	Current_Unbalance_%	%
89	V1_N_Volts_DC_H_RMS	V
90	V1_N_Volts_1st_H_RMS	V
91	V1_N_Volts_2nd_H_RMS	V
92	V1_N_Volts_3rd_H_RMS	V
93	V1_N_Volts_4th_H_RMS	V
94	V1_N_Volts_5th_H_RMS	V
95	V1_N_Volts_6th_H_RMS	V
96	V1_N_Volts_7th_H_RMS	V
97	V1_N_Volts_8th_H_RMS	V
98	V1_N_Volts_9th_H_RMS	V
99	V1_N_Volts_10th_H_RMS	V
100	V1_N_Volts_11th_H_RMS	V
101	V1_N_Volts_12th_H_RMS	V
102	V1_N_Volts_13th_H_RMS	V
103	V1_N_Volts_14th_H_RMS	V
104	V1_N_Volts_15th_H_RMS	V
105	V1_N_Volts_16th_H_RMS	V
106	V1_N_Volts_17th_H_RMS	V
107	V1_N_Volts_18th_H_RMS	V
108	V1_N_Volts_19th_H_RMS	V
109	V1_N_Volts_20th_H_RMS	V
110	V1_N_Volts_21st_H_RMS	V
111	V1_N_Volts_22nd_H_RMS	V
112	V1_N_Volts_23rd_H_RMS	V
113	V1_N_Volts_24th_H_RMS	V
114	V1_N_Volts_25th_H_RMS	V

**Table 16 - Data Log Parameter List (continued)**

<b>Parameter Number</b>	<b>Parameter Tag Name</b>	<b>Units</b>
115	V1_N_Volts_26th_H_RMS	V
116	V1_N_Volts_27th_H_RMS	V
117	V1_N_Volts_28th_H_RMS	V
118	V1_N_Volts_29th_H_RMS	V
119	V1_N_Volts_30th_H_RMS	V
120	V1_N_Volts_31st_H_RMS	V
121	V2_N_Volts_DC_H_RMS	V
122	V2_N_Volts_1st_H_RMS	V
123	V2_N_Volts_2nd_H_RMS	V
124	V2_N_Volts_3rd_H_RMS	V
125	V2_N_Volts_4th_H_RMS	V
126	V2_N_Volts_5th_H_RMS	V
127	V2_N_Volts_6th_H_RMS	V
128	V2_N_Volts_7th_H_RMS	V
129	V2_N_Volts_8th_H_RMS	V
130	V2_N_Volts_9th_H_RMS	V
131	V2_N_Volts_10th_H_RMS	V
132	V2_N_Volts_11th_H_RMS	V
133	V2_N_Volts_12th_H_RMS	V
134	V2_N_Volts_13th_H_RMS	V
135	V2_N_Volts_14th_H_RMS	V
136	V2_N_Volts_15th_H_RMS	V
137	V2_N_Volts_16th_H_RMS	V
138	V2_N_Volts_17th_H_RMS	V
139	V2_N_Volts_18th_H_RMS	V
140	V2_N_Volts_19th_H_RMS	V
141	V2_N_Volts_20th_H_RMS	V
142	V2_N_Volts_21st_H_RMS	V
143	V2_N_Volts_22nd_H_RMS	V
144	V2_N_Volts_23rd_H_RMS	V
145	V2_N_Volts_24th_H_RMS	V
146	V2_N_Volts_25th_H_RMS	V
147	V2_N_Volts_26th_H_RMS	V
148	V2_N_Volts_27th_H_RMS	V
149	V2_N_Volts_28th_H_RMS	V
150	V2_N_Volts_29th_H_RMS	V
151	V2_N_Volts_30th_H_RMS	V
152	V2_N_Volts_31st_H_RMS	V
153	V3_N_Volts_DC_H_RMS	V

**Table 16 - Data Log Parameter List (continued)**

<b>Parameter Number</b>	<b>Parameter Tag Name</b>	<b>Units</b>
154	V3_N_Volts_1st_H_RMS	V
155	V3_N_Volts_2nd_H_RMS	V
156	V3_N_Volts_3rd_H_RMS	V
157	V3_N_Volts_4th_H_RMS	V
158	V3_N_Volts_5th_H_RMS	V
159	V3_N_Volts_6th_H_RMS	V
160	V3_N_Volts_7th_H_RMS	V
161	V3_N_Volts_8th_H_RMS	V
162	V3_N_Volts_9th_H_RMS	V
163	V3_N_Volts_10th_H_RMS	V
164	V3_N_Volts_11th_H_RMS	V
165	V3_N_Volts_12th_H_RMS	V
166	V3_N_Volts_13th_H_RMS	V
167	V3_N_Volts_14th_H_RMS	V
168	V3_N_Volts_15th_H_RMS	V
169	V3_N_Volts_16th_H_RMS	V
170	V3_N_Volts_17th_H_RMS	V
171	V3_N_Volts_18th_H_RMS	V
172	V3_N_Volts_19th_H_RMS	V
173	V3_N_Volts_20th_H_RMS	V
174	V3_N_Volts_21st_H_RMS	V
175	V3_N_Volts_22nd_H_RMS	V
176	V3_N_Volts_23rd_H_RMS	V
177	V3_N_Volts_24th_H_RMS	V
178	V3_N_Volts_25th_H_RMS	V
179	V3_N_Volts_26th_H_RMS	V
180	V3_N_Volts_27th_H_RMS	V
181	V3_N_Volts_28th_H_RMS	V
182	V3_N_Volts_29th_H_RMS	V
183	V3_N_Volts_30th_H_RMS	V
184	V3_N_Volts_31st_H_RMS	V

## Data Log Results Files

The PowerMonitor 5000 unit stores the data log in multiple comma-separated-value (.csv) files, and selects a file duration that is based on the value of the `Data_Logging_Interval` parameter.

Interval, Seconds	Log File Duration	File End Date	Maximum Records
1~30	Hour	New hour, xx:00:00 (hh:mm:ss)	3600
31~90	Day	New day, 00:00:00 (hh:mm:ss)	2788
>90	Week	Sunday of a week, 00:00:00 (hh:mm:ss)	6646

In addition, the active data log file is closed and a new file is created when any of the following events occur:

- Initial powerup of the power monitor
- Subsequent powerup, if the active data log file is older than the expected duration
- If the `Data_Logging_Interval` or any other data log parameter is changed

The `Data_Log_Mode` parameter determines what happens when the log contains 60,000 records:

- If set to 0 = Fill and stop recording when log is full, no new data log files are created and no more data is logged.
- If set to 1 = Overwrite when log is full starting with the earliest record, a new file is created and data logging continues uninterrupted. This value is the default setting.

## File Names

Data log file names have the following semantics:

`DataLog_YYYYMMDD_hhmm_HH.csv`, where:

- `YYYYMMDD_hhmm` - the file creation date and time
- `HH` - UTC hour avoids duplication during daylight-saving time transition



## Logged Parameters

The data log records a user-selected set of parameters. The first record in each file is a header that indicates the tag name of each logged parameter. Each subsequent record is a structure of REAL elements containing the following parameters.

**Table 17 - Data Log Logged Parameters**

Element	Tag Name	Description
0	Record_Indicator	Indicate meanings of the data in the record
1	Data_Record_Identifier	Data log record time stamp
2	Data_Timestamp_Year	
3	Data_Timestamp_Month_Day	
4	Data_Timestamp_Hour_Minute	
5	Data_Timestamp_Sec_ms	
6	DataLog_Parameter_1 (Avg_V_N_Volts)	Values of user-selected or default parameters (Default parameter selection tag name)
7	DataLog_Parameter_2 (Avg_VL_VL_Volts)	
8	DataLog_Parameter_3 (Avg_Amps)	
9	DataLog_Parameter_4 (Frequency_Hz)	
10	DataLog_Parameter_5 (Total_kW)	
11	DataLog_Parameter_6 (Total_kVAR)	
12	DataLog_Parameter_7 (Total_kVA)	
13	DataLog_Parameter_8 (Total_PF_Lead_Lag_Indicator)	
14	DataLog_Parameter_9 (Avg_True_PF)	
15	DataLog_Parameter_10 (Avg_Disp_PF)	
16	DataLog_Parameter_11 (Avg_IEEE_THD_V_%)	
17	DataLog_Parameter_12 (Avg_IEEE_THD_V_V_%)	
18	DataLog_Parameter_13 (Avg_IEEE_THD_I_%)	
19	DataLog_Parameter_14 (Avg_IEC_THD_V_%)	
20	DataLog_Parameter_15 (Avg_IEC_THD_V_V_%)	
21	DataLog_Parameter_16 (Avg_IEC_THD_I_%)	
22	DataLog_Parameter_17 (Voltage_Unbalance_%)	
23	DataLog_Parameter_18 (Current_Unbalance_%)	
24	DataLog_Parameter_19	
25	DataLog_Parameter_20	

**Table 17 - Data Log Logged Parameters**

Element	Tag Name	Description
26	DataLog_Parameter_21	Values of user-selected or default parameters
27	DataLog_Parameter_22	
28	DataLog_Parameter_23	
29	DataLog_Parameter_24	
30	DataLog_Parameter_25	
31	DataLog_Parameter_26	
32	DataLog_Parameter_27	
33	DataLog_Parameter_28	
34	DataLog_Parameter_29	
35	DataLog_Parameter_30	
36	DataLog_Parameter_31	
37	DataLog_Parameter_32	

## Data Log Single Record Retrieval

A controller or application can sequentially retrieve records from the Data Log files by following the process described in this section, following these general tasks. The tables that are referenced are in [Appendix A](#).

1. Read the number of log files from the [Statistics.Logging](#) table.
2. Write the [Configuration.Log\\_Read](#) table and read the filename from the [LoggingResults.DataLog\\_FileName](#) table until the desired log file is selected.
3. Write the selected file name into the [Configuration.DataLogFile](#) table.
4. Perform sequential reads of the [LoggingResults.Data\\_Log](#) table and store the results in a suitable location.

The [Statistics.Logging](#) file contains the following Data Log information:

- Element 7 and 8, the number of Data Log records
- Element 9, the number of Data Log files

The [Configuration.Log\\_Read](#) table contains the following elements:

- Element 0. Write a value of 7 to request the next Data Log file name
- Element 1: Write a 0 to return the most recent file name first or a 1 to return the oldest file name first

The [LoggingResults.DataLog\\_FileName](#) table returns a string containing the requested file name. The file name contains the starting date and time of the log file, as described in [File Names on page 144](#)

The [Configuration.DataLogFile](#) table contains the file selection string. Options include the following:

- The desired Data Log file name from which to return records
- Alternately, 'allfiles', to return records from all Data Log files
- An appended chronology switch:
  - '/r' to begin with the most recent record
  - '/f' to return the oldest record first (default if no chronology switch is appended)

For example, writing the string 'DataLog\_20130112\_0630\_11/r' selects the file DataLog\_20130112\_0630\_11. Successive reads of the [LoggingResults.Data\\_Log](#) table return sequential data log records, starting with the last record.

The [LoggingResults.Data\\_Log](#) table contains the most recent record that is read from the selected data log file, and contains the following elements.

- Element 0 indicates the type of record. Options are:
  - 0 = No record returned
  - 1 = Parameter values
  - 2 = Parameter index values
  - 3 = Log file not found
- Element 1 returns a unique record ID or the total number of records, depending on the value of Element 0.
- Elements 2...5 return the date and time stamp of the record
- Elements 6...37 return parameter values or parameter index values depending on the value of Element 0.

Parameter index values are associated with parameter tag names as listed in the [Data Log Parameter List on page 139](#).

## Commands

Clear data log

## Related Functions

- Voltage, current, frequency, power metering
- Data log
- Configuration lock

## Min/Max Log

The PowerMonitor 5000 unit records time-stamped minimum and maximum values for all real-time metering data (except for energy data).

### Min/Max Log Results

Min/max log records can be retrieved from the PowerMonitor 5000 web page or FTP server. The power monitor generates the log file at the time of the request. Records can also be retrieved individually or sequentially by using the data table interface.

### File Name

The min/max log is named `Min_Max_Log.csv`.

### Logged Parameters

The first record in the min/max log file is a header listing the attribute names for each logged parameter.

**Table 18 - Min/Max Log Logged Parameters**

Attribute Name	Description
MinMax_Parameter_Number	The number of the parameter from the MIN_MAX parameter list.
MIN_Value	The minimum value that is recorded since the last MIN_MIX clear.
MAX_Value	The maximum value that is recorded since the last MIN_MIX clear.
Timestamp_MIN_Year	The year at which this MIN record was logged.
Timestamp_MIN_Mth_Day	The month and day this MIN record was logged.
Timestamp_MIN_Hr_Min	The hour and minute this MIN record was logged.
Timestamp_MIN_Sec_ms	The seconds and milliseconds this MIN record was logged.
Timestamp_MAX_Year	The year at which this MAX record was logged.
Timestamp_MAX_Mth_Day	The month and day this MAX record was logged.
Timestamp_MAX_Hr_Min	The hour and minute this MAX record was logged.
Timestamp_MAX_Sec_ms	The seconds and milliseconds this MAX record was logged.

Each subsequent record is a structure of REAL elements containing the attributes listed [Table 18](#) for each of the metering parameters listed [Table 19](#). Parameters 83...207 are supported by the M8 model only.

**Table 19 - Min/Max Log Parameter Attributes**

Parameter No.	Parameter name	Units
1	V1_N_Volts	V
2	V2_N_Volts	V
3	V3_N_Volts	V
4	V4_N_Volts	V
5	Avg_V_N_Volts	V
6	V1_V2_Volts	V
7	V2_V3_Volts	V
8	V3_V1_Volts	V
9	Avg_VL_VL_Volts	V
10	I1_Amps	A
11	I2_Amps	A
12	I3_Amps	A
13	I4_Amps	A
14	Avg_Amps	A
15	Frequency_Hz	Hz
16	L1_kW	kW
17	L2_kW	kW
18	L3_kW	kW
19	Total_kW	kW
20	L1_kVAR	kVAR
21	L2_kVAR	kVAR
22	L3_kVAR	kVAR
23	Total_kVAR	kVAR
24	L1_kVA	kVA
25	L2_kVA	kVA
26	L3_kVA	kVA
27	Total_kVA	kVA
28	L1_True_PF_Leading	%
29	L2_True_PF_Leading	%
30	L3_True_PF_Leading	%
31	Avg_True_PF_Leading	%
32	L1_True_PF_Lagging	%
33	L2_True_PF_Lagging	%
34	L3_True_PF_Lagging	%
35	Avg_True_PF_Lagging	%
36	L1_Disp_PF	%

Table 19 - Min/Max Log Parameter Attributes (continued)

Parameter No.	Parameter name	Units
37	L2_Disb_PF	%
38	L3_Disb_PF	%
39	Avg_Disb_PF	%
40	V1_Crest_Factor	-
41	V2_Crest_Factor	-
42	V3_Crest_Factor	-
43	I1_Crest_Factor	-
44	I2_Crest_Factor	-
45	I3_Crest_Factor	-
46	I4_Crest_Factor	-
47	V1_IEEE_THD_%	%
48	V2_IEEE_THD_%	%
49	V3_IEEE_THD_%	%
50	VGN_IEEE_THD_%	%
51	Avg_IEEE_THD_V_%	%
52	I1_IEEE_THD_%	%
53	I2_IEEE_THD_%	%
54	I3_IEEE_THD_%	%
55	I4_IEEE_THD_%	%
56	Avg_IEEE_THD_I_%	%
57	V1_IEC_THD_%	%
58	V2_IEC_THD_%	%
59	V3_IEC_THD_%	%
60	VGN_IEC_THD_%	%
61	Avg_IEC_THD_V_%	%
62	I1_IEC_THD_%	%
63	I2_IEC_THD_%	%
64	I3_IEC_THD_%	%
65	I4_IEC_THD_%	%
66	Avg_IEC_THD_I_%	%
67	I1_K_Factor	-
68	I2_K_Factor	-
69	I3_K_Factor	-
70	Pos_Seq_Volts	V
71	Neg_Seq_Volts	V
72	Zero_Seq_Volts	V
73	Pos_Seq_Amps	A
74	Neg_Seq_Amps	A
75	Zero_Seq_Amps	A

Table 19 - Min/Max Log Parameter Attributes (continued)

Parameter No.	Parameter name	Units
76	Voltage_Unbalance_%	%
77	Current_Unbalance_%	%
78	kW Demand	kW
79	kVAR Demand	kVAR
80	kVA Demand	kVA
81	Demand PF	%
82	Demand Amperes	A
83	200mS_V1_N_Magnitude	V
84	200mS_V2_N_Magnitude	V
85	200mS_V3_N_Magnitude	V
86	200mS_VN_G_Magnitude	V
87	200mS_VN_Ave_Magnitude	V
88	200mS_V1_V2_Magnitude	V
89	200mS_V2_V3_Magnitude	V
90	200mS_V3_V1_Magnitude	V
91	200mS_VV_Ave_Magnitude	V
92	200mS_I1_Amps_Magnitude	A
93	200mS_I2_Amps_Magnitude	A
94	200mS_I3_Amps_Magnitude	A
95	200mS_I4_Amps_Magnitude	A
96	200mS_Amps_Ave_Magnitude	A
97	200mS_L1_kW	kW
98	200mS_L2_kW	kW
99	200mS_L3_kW	kW
100	200mS_Total_kW	kW
101	200mS_L1_kVAR	kVAR
102	200mS_L2_kVAR	kVAR
103	200mS_L3_kVAR	kVAR
104	200mS_Total_kVAR	kVAR
105	200mS_L1_kVA	kVA
106	200mS_L2_kVA	kVA
107	200mS_L3_kVA	kVA
108	200mS_Total_kVA	kVA
109	200mS_L1_True_PF	%
110	200mS_L2_True_PF	%
111	200mS_L3_True_PF	%
112	200mS_Total_True_PF	%
113	200mS_L1_Disp_PF	%
114	200mS_L2_Disp_PF	%

Table 19 - Min/Max Log Parameter Attributes (continued)

Parameter No.	Parameter name	Units
115	200mS_L3_DisP_PF	%
116	200mS_Total_DisP_PF	%
117	200mS_V1_N_IEEE_THD_%	%
118	200mS_V2_N_IEEE_THD_%	%
119	200mS_V3_N_IEEE_THD_%	%
120	200mS_VN_G_IEEE_THD_%	%
121	200mS_Avg_IEEE_THD_V_%	%
122	200mS_V1_V2_IEEE_THD_%	%
123	200mS_V2_V3_IEEE_THD_%	%
124	200mS_V3_V1_IEEE_THD_%	%
125	200mS_Avg_IEEE_THD_V_V_%	%
126	200mS_I1_IEEE_THD_%	%
127	200mS_I2_IEEE_THD_%	%
128	200mS_I3_IEEE_THD_%	%
129	200mS_I4_IEEE_THD_%	%
130	200mS_Avg_IEEE_THD_I_%	%
131	200mS_V1_N_IEC_THD_%	%
132	200mS_V2_N_IEC_THD_%	%
133	200mS_V3_N_IEC_THD_%	%
134	200mS_VN_G_IEC_THD_%	%
135	200mS_Avg_IEC_THD_V_%	%
136	200mS_V1_V2_IEC_THD_%	%
137	200mS_V2_V3_IEC_THD_%	%
138	200mS_V3_V1_IEC_THD_%	%
139	200mS_Avg_IEC_THD_V_V_%	%
140	200mS_I1_IEC_THD_%	%
141	200mS_I2_IEC_THD_%	%
142	200mS_I3_IEC_THD_%	%
143	200mS_I4_IEC_THD_%	%
144	200mS_Avg_IEC_THD_I_%	%
145	200mS_V1_N_THDS	%
146	200mS_V2_N_THDS	%
147	200mS_V3_N_THDS	%
148	200mS_VN_G_THDS	%
149	200mS_AVE_VN_THDS	%
150	200mS_V1_V2_THDS	%
151	200mS_V2_V3_THDS	%
152	200mS_V3_V1_THDS	%
153	200mS_AVE_LL_THDS	%



Table 19 - Min/Max Log Parameter Attributes (continued)

Parameter No.	Parameter name	Units
154	200mS_V1_N_TIHDS	%
155	200mS_V2_N_TIHDS	%
156	200mS_V3_N_TIHDS	%
157	200mS_VN_G_TIHDS	%
158	200mS_AVE_VN_TIHDS	%
159	200mS_V1_V2_TIHDS	%
160	200mS_V2_V3_TIHDS	%
161	200mS_V3_V1_TIHDS	%
162	200mS_AVE_LL_TIHDS	%
163	200mS_I1_K_Factor	-
164	200mS_I2_K_Factor	-
165	200mS_I3_K_Factor	-
166	200mS_Pos_Seq_Volts	V
167	200mS_Neg_Seq_Volts	V
168	200mS_Zero_Seq_Volts	V
169	200mS_Pos_Seq_Amps	A
170	200mS_Neg_Seq_Amps	A
171	200mS_Zero_Seq_Amps	A
172	200mS_Voltage_Unbalance_%	%
173	200mS_Current_Unbalance_%	%
174	10s_Power_Frequency	Hz
175	3s_V1_N_Magnitude	V
176	10m_V1_N_Magnitude	V
177	2h_V1_N_Magnitude	V
178	3s_V2_N_Magnitude	V
179	10m_V2_N_Magnitude	V
180	2h_V2_N_Magnitude	V
181	3s_V3_N_Magnitude	V
182	10m_V3_N_Magnitude	V
183	2h_V3_N_Magnitude	V
184	3s_VN_G_Magnitude	V
185	10m_VN_G_Magnitude	V
186	2h_VN_G_Magnitude	V
187	3s_V1_V2_Magnitude	V
188	10m_V1_V2_Magnitude	V
189	2h_V1_V2_Magnitude	V
190	3s_V2_V3_Magnitude	V
191	10m_V2_V3_Magnitude	V
192	2h_V2_V3_Magnitude	V

**Table 19 - Min/Max Log Parameter Attributes (continued)**

Parameter No.	Parameter name	Units
193	3s_V3_V1_Magnitude	V
194	10m_V3_V1_Magnitude	V
195	2h_V3_V1_Magnitude	V
196	CH1_Short_Term_Flicker_Pst	Pst
197	CH1_Long_Term_Flicker_Plt	Plt
198	CH2_Short_Term_Flicker_Pst	Pst
199	CH2_Long_Term_Flicker_Plt	Plt
200	CH3_Short_Term_Flicker_Pst	Pst
201	CH3_Long_Term_Flicker_Plt	Plt
202	200mS_CH1_Mains_Signaling_Voltage	V
203	200mS_CH2_Mains_Signaling_Voltage	V
204	200mS_CH3_Mains_Signaling_Voltage	V
205	3s_Voltage_Unbalance	%
206	10m_Voltage_Unbalance	%
207	2h_Voltage_Unbalance	%

## Setup

The Min/Max Log requires the following to be configured:

- Basic metering setup
- Logging configuration
- Date and Time setup

## Commands

- Clear single min/max log record
- Clear min/max log

## Related Functions

- Demand metering
- Voltage, current, and frequency metering
- Power metering
- Configuration lock

## Load Factor Log

The PowerMonitor 5000 unit maintains a 12-month record of real, reactive, and apparent demand and load factor. Load factor is defined as average demand divided by peak demand and is a measure of load variability.

### Load Factor Log Results

Load factor log records can be retrieved from the PowerMonitor 5000 web page or FTP server. The power monitor generates the log file at the time of the request. Records can also be retrieved individually or sequentially by using the data table interface.

### File Name

The log file is named Load\_Factor\_Log.csv.

### Logged Parameters

The load factor log consists of 14 records. The first is a header naming the logged parameters. The second is an active record for the current month. The remaining records are static and store data for each of the previous 12 months. The monthly records operate in a circular, or FIFO fashion. On a user-selected day each month, the current record is pushed into the stack of monthly records and, if the stack is full, the oldest is deleted. Each record is a structure of REAL elements containing the following parameters:

- LoadFactor\_Record\_Number
- LoadFactor\_End\_Date
- LoadFactor\_Elapsed\_Time
- Peak\_Demand\_kW
- Average\_Demand\_kW
- LoadFactor\_kW
- Peak\_Demand\_kVAR
- Average\_Demand\_kVAR
- LoadFactor\_kVAR
- Peak\_Demand\_kVA
- Average\_Demand\_kVA
- LoadFactor\_kVA

## Setup

The Data Log requires the following to be configured:

- Basic metering setup (including Demand)
- Data logging configuration
- Date and Time setup

## Commands

- Store and clear current Load Factor Record
- Clear Load Factor Log

## Related Functions

- Demand metering
- Configuration lock

## Time-of-use (TOU) Log

The PowerMonitor 5000 unit maintains records of energy and demand that you organize by times of use.

In the PowerMonitor 5000 model, there are three time-of-use (TOU) logs, one each for real, reactive, and apparent energy, and demand. Within each log, energy consumption and peak demand are recorded into off-peak, mid-peak, and on-peak categories. The days and times that define the mid- and on-peak periods are user selectable. All times of use not defined as mid- or on-peak are considered off-peak.

## TOU Log Results

Time-of-use log records can be retrieved from the PowerMonitor 5000 web page or FTP server. The power monitor generates the log file at the time of the request. Records can also be retrieved individually or sequentially by using the data table interface.

## File Name

The log file is named Time\_of\_Use\_Log.csv.

## Logged Parameters

The TOU log consists of 14 records. The first is a header naming the logged parameters. The second is an active record for the current month. The remaining records are static and store data for each of the previous 12 months. The monthly records operate in a circular, or FIFO fashion. On a user-selected day each month, the current record is pushed into the stack of monthly records and, if the stack is full, the oldest is deleted. Each record is a structure of REAL elements containing the following parameters:

- TOU\_Record\_Number
- TOU\_Start\_Date
- TOU\_End\_Date
- Off\_Peak\_GWh\_Net
- Off\_Peak\_kWh\_Net
- Off\_Peak\_kW\_Demand
- Mid\_Peak\_GWh\_Net
- Mid\_Peak\_kWh\_Net
- Mid\_Peak\_kW\_Demand
- On\_Peak\_GWh\_Net
- On\_Peak\_kWh\_Net
- On\_Peak\_kW\_Demand
- Off\_Peak\_GVARh\_Net
- Off\_Peak\_kVARh\_Net
- Off\_Peak\_kVAR\_Demand
- Mid\_Peak\_GVARh\_Net
- Mid\_Peak\_kVARh\_Net
- Mid\_Peak\_kVAR\_Demand
- On\_Peak\_GVARh\_Net
- On\_Peak\_kVARh\_Net
- On\_Peak\_kVAR\_Demand
- Off\_Peak\_GVAh\_Net
- Off\_Peak\_kVAh\_Net
- Off\_Peak\_kVA\_Demand
- Mid\_Peak\_GVAh\_Net
- Mid\_Peak\_kVAh\_Net
- Mid\_Peak\_kVA\_Demand
- On\_Peak\_GVAh\_Net
- On\_Peak\_kVAh\_Net
- On\_Peak\_kVA\_Demand

## Setup

The Time-of-use Log requires the following to be configured:

- Basic metering setup (including Demand)
- Logging configuration
- Date and Time setup

## Commands

- Store and clear current TOU Record
- Clear TOU Log

## Related Functions

- Energy metering
- Demand metering
- Configuration lock

## Event Log

The event log records the date and time of changes that are made to the device and of external events. The event log is up to 100 records deep. The event log cannot be cleared.

The Event\_Log\_Mode parameter determines what happens when log is full:

- If 0 = Stop logging, no more event data is logged.
- If 1 = Overwrite oldest record, event logging continues and oldest events are deleted.

## Event Log Results

Event log records can be retrieved from the PowerMonitor 5000 web page or FTP server. Event log records can also be retrieved sequentially by using the data table interface.

## File Name

The event log is named Event\_Log.csv.

## Logged Parameters

The event log operates in a circular, or FIFO fashion. The first record is a header naming the logged parameters. Each subsequent record is a structure of INT16 elements containing the following parameters.

**Table 20 - Event Log Logged Parameters**

Tag Name	Description
Event_Record_Identifier	Used to verify record sequence when returning multiple records.
Event_Timestamp_Year	The year when the record was recorded.
Event_Timestamp_Mth_Day	The month and day when the record was recorded.
Event_Timestamp_Hr_Min	The hour and minute when the record was recorded.
Event_Timestamp_Sec_ms	The seconds and milliseconds when the record was recorded.
Event Type	Indicates the type of event that has occurred.
General Code	Indicates general information about the status event.
Information Code	Indicates specific information about the status event.

**Table 21 - Event, General, and Information Codes**

Event Type	Event #	General Code	Code	Information Code	Code
Self-Test Status	1	Pass	0		
		Nor Flash Memory	1	Overall Status	1
				Boot Code Checksum	2
				Application Code Checksum	4
				Wrong Application FRN	8
				Invalid Model Type	16
				WIN Mismatch	32
				Missing Upgrade Block	64
		SDRAM	2	Failed Read/Write Test	1
		NAND Flash Memory	4	Read/Write Failed	1
		FRAM	8	Failed Read/Write Test	1
		Real Time Clock	16	Real Time Clock Failed	1
				Real Time Clock not Set	2
		Watchdog Timer	32	Watchdog Time Out	1
		Ethernet communication	64	Ethernet Communication Port Failed	1
				SNTP_Task_init_failed	2
				Demand_Broadcast_task_init_failed	4



**Table 21 - Event, General, and Information Codes (continued)**

Event Type	Event #	General Code	Code	Information Code	Code
Configuration Changed	2	Clock Set	1		
		Status Input Counter Set	2	Status Input 1	1
				Status Input 2	2
				Status Input 3	4
				Status Input 4	8
		Factory Defaults Restored	4		
		Energy Register Set	8	Wh Register	1
				VARh Register	2
				VAh Register	4
				Ah Register	8
				All Energy Registers Cleared	16
Terminal Locked	16				
Terminal Unlocked	32				
Log Cleared or Set	4	Min/Max Log Cleared	1		
		Energy Log Cleared	2		
		LoadFactor Log Cleared	4		
		TOU Log Cleared	8		
		Data Log Cleared	16		
		Setpoint Log Cleared	32		
		Trigger Data Log Cleared	64		
		Power Quality Log Cleared	128		
		Waveform Log Cleared	256		
		Relay/KYZ Output Forced	8	KYZ Forced On	1
KYZ Forced Off	2				
Relay 1 Forced On	4				
Relay 1 Forced Off	8				
Relay 2 Forced On	16				
Relay 2 Forced Off	32				
Relay 3 Forced On	64				
Relay 3 Forced Off	128				
Status Input Activated	16	Status Input 1	1		
		Status Input 2	2		
		Status Input 3	4		
		Status Input 4	8		

**Table 21 - Event, General, and Information Codes (continued)**

Event Type	Event #	General Code	Code	Information Code	Code
Status Input Deactivated	32	Status Input 1	1		
		Status Input 2	2		
		Status Input 3	4		
		Status Input 4	8		
Energy Register Rollover	64	Wh Register	1		
		VARh Register	2		
		VAh Register	4		
		Status Input 1 Register	8		
		Status Input 2 Register	16		
		Status Input 3 Register	32		
		Status Input 4 Register	64		
Device Power Up	128				
Device Power Down	256				
Missed External Demand Sync	512				
Register Set Clear	1024				

### Setup

Logging configuration.

### Commands

None.

### Related Functions

Log status input changes.

## Setpoint Log

The setpoint log records information when a setpoint output activates (asserts) or deactivates (de-asserts). The setpoint log is up to 100 records deep.

The Setpoint\_Log\_Mode parameter determines what happens when log is full:

- If 0 = Stop logging, no more setpoint data is logged.
- If 1 = Overwrite oldest record, logging continues and oldest events are deleted.

## Setpoint Log Results

Setpoint log records can be retrieved from the PowerMonitor 5000 web page or FTP server. Setpoint log records can also be retrieved sequentially by using the data table interface.

## File Name

The setpoint log is named Setpoint\_Log.csv.

## Logged Parameters

The setpoint log operates in a circular, or FIFO fashion. The first record is a header naming the logged parameters. Each subsequent record is a structure of REAL elements containing the following parameters.

**Table 22 - Setpoint Log Logged Parameters**

Item Name	Description
Setpoint_Record_Identifier	Used to verify record sequence when returning multiple records.
Setpoint_Timestamp_Year	The year when the record was recorded.
Setpoint_Timestamp_Mth_Day	The month and day when the record was recorded.
Setpoint_Timestamp_Hr_Min	The hour and minute when the record was recorded.
Setpoint_Timestamp_Sec_ms	The seconds and milliseconds when the record was recorded.
Setpoint_Number	Setpoint number of record.
Setpoint_Status	Setpoint is active or not active.
Input_Parameter	Input test parameter of setpoint.
Test_Condition	Test Condition.
Evaluation_Type	Evaluation type for setpoint.
Threshold_Setting	The threshold setting magnitude or percent.
Hysteresis_Setting	Magnitude or percent.
Assert_Delay	Time delay before actuation.
Deassert_Delay	Time delay before deassert.
Output_Source	Output flag or bit.

**Table 22 - Setpoint Log Logged Parameters (continued)**

Item Name	Description
Output_Action	Configured action when actuated.
Accumulated_Time	Total accumulation in seconds.
Number_Of_Transitions	Number of transitions from off to on.

## Setup

- Basic metering setup
- Setpoints 1...5 configuration
- Setpoints 6...10 configuration
- Setpoints 11...15 configuration
- Setpoints 16...20 configuration
- Setpoint Logic configuration
- Setpoint Outputs configuration
- Date and Time setup
- Logging configuration

## Commands

- Clear Setpoint Log
- Clear Setpoint Accumulators

## Related Functions

Setpoint configuration and operation.

## Alarm Log

The alarm log records information when an alarm occurs. The alarm log is up to 100 records deep. The alarm log cannot be cleared.

### Alarm Log Results

Alarm log records can be retrieved from the PowerMonitor 5000 web page or FTP server. Alarm log records can also be retrieved sequentially by using the data table interface.

### File Name

The alarm log is named Alarm\_Log.csv.

### Logged Parameters

The alarm log operates in a circular, or FIFO fashion. The first is a header naming the logged parameters. Each subsequent record is a structure of INT16 elements containing the following parameters.

**Table 23 - Alarm Log Logged Parameters**

Tag Name	Description
Alarm_Record_Identifier	Used to verify record sequence when returning multiple records.
Alarm_Timestamp_Year	The year when the record was recorded.
Alarm_Timestamp_Mth_Day	The month and day when the record was recorded.
Alarm_Timestamp_Hr_Min	The hour and minute when the record was recorded.
Alarm_Timestamp_Sec_ms	The seconds and milliseconds when the record was recorded.
Alarm Type	Indicates the type of event that has occurred.
Alarm Code	Indicates information about the alarm.

**Table 24 - Alarm Codes and Descriptions**

Alarm Type Description	Type	Alarm Code Description	Code
Metering_Status	1	Virtual_Wiring_Correction	1
		Volts_Loss_V1	2
		Volts_Loss_V2	4
		Volts_Loss_V3	8
		Voltage_Over_Range_Indication	16
		Ampere_Over_Range_Indication	32
		Wiring_Diagnostics_Active	64
Over_Range_Information	2	V1G_Over_Range	1
		V2G_Over_Range	2
		V3G_Over_Range	4
		VNG_Over_Range	8
		I1_Over_Range	16
		I2_Over_Range	32
		I3_Over_Range	64
		I4_Over_Range	128
PowerQuality_Status	4	Sag_Indication_Detected	1
		Swell_Indication_Detected	2
		Transient_Indication	4
		200mS_Sag_Swell_Status_Flag	8
		3s_Sag_Swell_Status_Flag	16
		10m_Sag_Swell_Status_Flag	32
		2h_Sag_Swell_Status_Flag	64
Logs_Status	8	Data_Log_Full_Fill_And_Stop	1
		Event_Log_Full_Fill_And_Stop	2
		Setpoint_Log_Full_Fill_And_Stop	4
		PowerQuality_Log_Full_Fill_And_Stop	8
		Energy_Log_Full_Fill_And_Stop	16
		Waveform_Full	32
		TriggerData_Full_Fill_And_Stop	64
Output_Pulse_Ovrrun	16	KYZ_Pulse_Ovrrun	1
		Relay1_Pulse_Ovrrun	2
		Relay2_Pulse_Ovrrun	4
		Relay3_Pulse_Ovrrun	8

**Table 24 - Alarm Codes and Descriptions (continued)**

Alarm Type Description	Type	Alarm Code Description	Code
IEEE1159_Over/Under_Voltage_Imbalance	32	IEEE1159_Over_Voltage_V1	1
		IEEE1159_Over_Voltage_V2	2
		IEEE1159_Over_Voltage_V3	4
		IEEE1159_Under_Voltage_V1	8
		IEEE1159_Under_Voltage_V2	16
		IEEE1159_Under_Voltage_V3	32
		IEEE1159_Imbalance_Condition_Volts	64
		IEEE1159_Imbalance_Condition_Current	128
IEEE1159_DCOffset_THD_Frequency_Condition	64	IEEE1159_DCOffset_Condition_V1	1
		IEEE1159_DCOffset_Condition_V2	2
		IEEE1159_DCOffset_Condition_V3	4
		IEEE1159_Voltage_THD_Condition_V1	8
		IEEE1159_Voltage_THD_Condition_V2	16
		IEEE1159_Voltage_THD_Condition_V3	32
		IEEE1159_Current_THD_Condition_I1	64
		IEEE1159_Current_THD_Condition_I2	128
		IEEE1159_Current_THD_Condition_I3	256
		IEEE1159_PowerFrequency_Condition	512
		IEEE1159_Current_THD_Condition_I4	1024
IEEE1159_TID_Condition	65	IEEE1159_Voltage_TID_Condition_V1	1
		IEEE1159_Voltage_TID_Condition_V2	2
		IEEE1159_Voltage_TID_Condition_V3	4
		IEEE1159_Current_TID_Condition_I1	8
		IEEE1159_Current_TID_Condition_I2	16
		IEEE1159_Current_TID_Condition_I3	32
		IEEE1159_Current_TID_Condition_I4	64
IEEE519_Overall_Status	128	ShortTerm_TDD_THD_PASS_FAIL	1
		LongTerm_TDD_THD_PASS_FAIL	2
		ShortTerm_Individual_Harmonic_PASS_FAIL	4
		LongTerm_Individual_Harmonic_PASS_FAIL	8

**Table 24 - Alarm Codes and Descriptions (continued)**

Alarm Type Description	Type	Alarm Code Description	Code
ShortTerm_2nd_To_17th_Harmonic_Status	256	2nd_Harmonic_PASS_FAIL	1
		3rd_Harmonic_PASS_FAIL	2
		4th_Harmonic_PASS_FAIL	4
		5th_Harmonic_PASS_FAIL	8
		6th_Harmonic_PASS_FAIL	16
		7th_Harmonic_PASS_FAIL	32
		8th_Harmonic_PASS_FAIL	64
		9th_Harmonic_PASS_FAIL	128
		10th_Harmonic_PASS_FAIL	256
		11th_Harmonic_PASS_FAIL	512
		12th_Harmonic_PASS_FAIL	1024
		13th_Harmonic_PASS_FAIL	2048
		14th_Harmonic_PASS_FAIL	4096
		15th_Harmonic_PASS_FAIL	8192
16th_Harmonic_PASS_FAIL	16384		
17th_Harmonic_PASS_FAIL	32768		
ShortTerm_18th_To_33rd_Harmonic_Status	512	18th_Harmonic_PASS_FAIL	1
		19th_Harmonic_PASS_FAIL	2
		20th_Harmonic_PASS_FAIL	4
		21st_Harmonic_PASS_FAIL	8
		22nd_Harmonic_PASS_FAIL	16
		23rd_Harmonic_PASS_FAIL	32
		24th_Harmonic_PASS_FAIL	64
		25th_Harmonic_PASS_FAIL	128
		26th_Harmonic_PASS_FAIL	256
		27th_Harmonic_PASS_FAIL	512
		28th_Harmonic_PASS_FAIL	1024
		29th_Harmonic_PASS_FAIL	2048
		30th_Harmonic_PASS_FAIL	4096
		31st_Harmonic_PASS_FAIL	8192
32nd_Harmonic_PASS_FAIL	16384		
33rd_Harmonic_PASS_FAIL	32768		
ShortTerm_34th_To_40th_Harmonic_Status	1024	34th_Harmonic_PASS_FAIL	1
		35th_Harmonic_PASS_FAIL	2
		36th_Harmonic_PASS_FAIL	4
		37th_Harmonic_PASS_FAIL	8
		38th_Harmonic_PASS_FAIL	16
		39th_Harmonic_PASS_FAIL	32
		40th_Harmonic_PASS_FAIL	64



**Table 24 - Alarm Codes and Descriptions (continued)**

Alarm Type Description	Type	Alarm Code Description	Code
LongTerm_2nd_To_17th_Harmonic_Status	2048	2nd_Harmonic_PASS_FAIL	1
		3rd_Harmonic_PASS_FAIL	2
		4th_Harmonic_PASS_FAIL	4
		5th_Harmonic_PASS_FAIL	8
		6th_Harmonic_PASS_FAIL	16
		7th_Harmonic_PASS_FAIL	32
		8th_Harmonic_PASS_FAIL	64
		9th_Harmonic_PASS_FAIL	128
		10th_Harmonic_PASS_FAIL	256
		11th_Harmonic_PASS_FAIL	512
		12th_Harmonic_PASS_FAIL	1024
		13th_Harmonic_PASS_FAIL	2048
		14th_Harmonic_PASS_FAIL	4096
		15th_Harmonic_PASS_FAIL	8192
16th_Harmonic_PASS_FAIL	16384		
17th_Harmonic_PASS_FAIL	32768		
LongTerm_18th_To_33rd_Harmonic_Status	4096	18th_Harmonic_PASS_FAIL	1
		19th_Harmonic_PASS_FAIL	2
		20th_Harmonic_PASS_FAIL	4
		21st_Harmonic_PASS_FAIL	8
		22nd_Harmonic_PASS_FAIL	16
		23rd_Harmonic_PASS_FAIL	32
		24th_Harmonic_PASS_FAIL	64
		25th_Harmonic_PASS_FAIL	128
		26th_Harmonic_PASS_FAIL	256
		27th_Harmonic_PASS_FAIL	512
		28th_Harmonic_PASS_FAIL	1024
		29th_Harmonic_PASS_FAIL	2048
		30th_Harmonic_PASS_FAIL	4096
		31st_Harmonic_PASS_FAIL	8192
32nd_Harmonic_PASS_FAIL	16384		
33rd_Harmonic_PASS_FAIL	32768		
LongTerm_34th_To_40th_Harmonic_Status	8192	34th_Harmonic_PASS_FAIL	1
		35th_Harmonic_PASS_FAIL	2
		36th_Harmonic_PASS_FAIL	4
		37th_Harmonic_PASS_FAIL	8
		38th_Harmonic_PASS_FAIL	16
		39th_Harmonic_PASS_FAIL	32
		40th_Harmonic_PASS_FAIL	64

**Table 24 - Alarm Codes and Descriptions (continued)**

Alarm Type Description	Type	Alarm Code Description	Code
IEEE1159_Voltage_Fluctuation_Condition	16384	IEEE1159_Voltage_Fluctuation_Condition_V1	1
		IEEE1159_Voltage_Fluctuation_Condition_V2	2
		IEEE1159_Voltage_Fluctuation_Condition_V3	4
EN61000_4_30_Mains_Signal_Under_Over_Deviation_Condition	32768	EN61000_4_30_Mains_Signal_Condition_V1	1
		EN61000_4_30_Mains_Signal_Condition_V2	2
		EN61000_4_30_Mains_Signal_Condition_V3	4
		EN61000_4_30_Under_Deviation_V1	8
		EN61000_4_30_Under_Deviation_V2	16
		EN61000_4_30_Under_Deviation_V3	32
		EN61000_4_30_Over_Deviation_V1	64
		EN61000_4_30_Over_Deviation_V2	128
		EN61000_4_30_Over_Deviation_V3	256

**Setup**

Basic metering setup.

**Commands**

None.

**Related Functions**

None.

## Power Quality Log (M6 and M8 model)

The power monitor records power quality events that the unit has detected and classified into a Power Quality log.

### Setup

- Basic metering setup
- Date and time setup
- Logging configuration

The `Power_Quality_Log_Mode` parameter in the Configuration.Logging tab determines what happens when the log is full:

- 0 = Stop logging; no more power quality data is logged.
- 1 = Overwrite oldest record; logging continues and oldest events are deleted.

### Operation

A Power Quality log record is composed of the event classification, local and UTC timestamps, duration of event, minimum sag rms voltage and maximum swell rms voltage level, and the trip point setting. Time stamps have a resolution of 1 microsecond. If a sag or swell event has an associated waveform recording, the Power Quality log entry includes the `Association_Timestamp`, a date/time reference to the waveform.

Because the user or software can delete waveform files to make room for more captures, a situation can occur in which a reference appears in a power quality log record but the file no longer exists. In this case, the write status table returns 'Log File Not Found' to the user.

The power quality log is 100 records deep.

### File Name

The power quality log is named `Power_Quality_Log.csv`.

## Logged Parameters

The event log operates in a circular, or FIFO fashion. When accessed as a file, the first record is a header containing the tag names. Each subsequent record is a structure of REAL elements containing the following parameters.

Tag Name	Description
Record_Identifier	Used to verify record sequence when returning multiple records
Event_Type	Power quality event type, see Power Quality Event Code table.
Sub_Event_Code	Indicate the sub event of the event type. For example, a sag event can happen in V1, V2 or V3. See Power Quality Event Code table.
Local_Timestamp_Year	Year of the local time when the record was recorded
Local_Timestamp_Mth_Day	Month and Day of the local time when the record was recorded
Local_Timestamp_Hr_Min	Hour and Minute of the local time when the record was recorded
Local_Timestamp_Sec_mS	Second and Millisecond of the local time when the record was recorded.
Local_Timestamp_uS	Microsecond when the record was recorded
UTC_Timestamp_Year	Year of the UTC when the record was recorded
UTC_Timestamp_Mth_Day	Month and Day of the UTC when the record was recorded
UTC_Timestamp_Hr_Min	Hour and Minute of the UTC when the record was recorded.
UTC_Timestamp_Sec_mS	Second and Millisecond of UTC when the record was recorded.
UTC_Timestamp_uS	Microsecond of UTC when the record was recorded.
Association_Timestamp_Year	Year of the timestamp associated with waveform file if the event can trigger a waveform capture
Association_Timestamp_Mth_Day	Month and Day of the timestamp that is associated with waveform file if the event can trigger a waveform capture
Association_Timestamp_Hr_Min	Hour and Minute of the timestamp that is associated with waveform file if the event can trigger a waveform capture
Association_Timestamp_Sec_mS	Second and Millisecond of the timestamp that is associated with waveform file if the event can trigger a waveform capture
Association_Timestamp_uS	Microsecond of the timestamp associated with waveform file
Event_Duration_mS	Event duration in milliseconds
Min_or_Max	Minimum or maximum value of the related parameter during the event
Trip_Point	The trip point that triggered the event
WSB Originator	ID of the unit that originated the WSB message; the 3 least significant bytes of its MAC ID

## Power Quality Event Codes

Power Quality Event Name	Event Code	Sub Event Name	Sub Event Code	Can Trigger Waveform Capture	Description
Voltage_Swell	1	V1_Swell	1	•	Voltage Swell (4 trip points for V1)
		V2_Swell	2	•	Voltage Swell (4 trip points for V2)
		V3_Swell	3	•	Voltage Swell (4 trip points for V3)
Voltage_Sag	2	V1_Sag	1	•	Voltage Sag (5 trip points for V1)
		V2_Sag	2	•	Voltage Sag (5 trip points for V2)
		V3_Sag	3	•	Voltage Sag (5 trip points for V3)
Imbalance	3	Voltage Imbalance	1		Voltage Imbalance
		Current Imbalance	2		Current Imbalance
Power_Frequency	4	--	--		Power Frequency Deviation
Voltage_DC_Offset	5	V1_DC_Offset	1		V1 DC offset
		V2_DC_Offset	2		V2 DC offset
		V3_DC_Offset	3		V3 DC offset
Voltage THD	6	V1_THD	1		V1 THD
		V2_THD	2		V2 THD
		V3_THD	3		V3 THD
Current THD	7	I1_THD	1		I1 THD
		I2_THD	2		I2 THD
		I3_THD	3		I3 THD
IEEE1159_Over_Voltage	8	V1_Over_Voltage	1		V1 over voltage
		V2_Over_Voltage	2		V2 over voltage
		V3_Over_Voltage	3		V3 over voltage
IEEE1159_Under_Voltage	9	V1_Under_Voltage	1		V1 under voltage
		V2_Under_Voltage	2		V2 under voltage
		V3_Under_Voltage	3		V3 under voltage
Voltage_TID	10	V1_Interharmonics	1		Voltage V1 total interharmonic distortion
		V2_Interharmonics	2		Voltage V2 total interharmonic distortion
		V3_Interharmonics	3		Voltage V3 total interharmonic distortion
Current_TID	11	I1_Interharmonics	1		Current I1 total interharmonic distortion
		I2_Interharmonics	2		Current I2 total interharmonic distortion
		I3_Interharmonics	3		Current I3 total interharmonic distortion
		I4_Interharmonics	4		Current I4 total interharmonic distortion

Power Quality Event Name	Event Code	Sub Event Name	Sub Event Code	Can Trigger Waveform Capture	Description
IEEE1159_Voltage_Fluctuations	12	V1_Pst	1		V1 Pst configured limit has been exceeded
		V2_Pst	2		V2 Pst configured limit has been exceeded
		V3_Pst	3		V3 Pst configured limit has been exceeded
Voltage_Transient	13	V1_Transient	1	•	V1 transient
		V2_Transient	2	•	V2 transient
		V3_Transient	3	•	V3 transient
Command_Trigger	14	--	--	•	Event triggered by the user command
WSB_Sag	15	--	--	•	Sag event from WSB (waveform synchronization broadcast) message.
WSB_Swell	16	--	--	•	Swell event from WSB message
WSB_Transient	17	--	--	•	Transient event from WSB message
WSB_Command	18	--	--	•	User command from WSB message
IEEE1159_Swell	19	V1_Swell	1	•	Voltage Swell greater than 110% of nominal
		V2_Swell	2	•	Voltage Swell greater than 110% of nominal
		V3_Swell	3	•	Voltage Swell greater than 110% of nominal
IEEE1159_Sag	20	V1_Sag	1	•	Voltage Sag less than 90% of nominal
		V2_Sag	2	•	Voltage Sag less than 90% of nominal
		V3_Sag	3	•	Voltage Sag less than 90% of nominal
IEEE1159_Interruption	21	V1_Interruption	1	•	Voltage Interruption less than 10% nominal
		V2_Interruption	2	•	Voltage Interruption less than 10% nominal
		V3_Interruption	3	•	Voltage Interruption less than 10% nominal
EN61000_4_30_Mains_Signaling	22	V1_Mains_Signal	1		V1 mains signaling has exceeded the configured limit
		V2_Mains_Signal	2		V2 mains signaling has exceeded the configured limit
		V3_Mains_Signal	3		V3 mains signaling has exceeded the configured limit
EN61000_4_30_Under_Deviation	23	V1_Under_Deviation	1		An under deviation is detected on V1
		V2_Under_Deviation	2		An under deviation is detected on V2
		V3_Under_Deviation	3		An under deviation is detected on V3
EN61000_4_30_Over_Deviation	24	V1_Over_Deviation	1		An over deviation is detected on V1
		V2_Over_Deviation	2		An over deviation is detected on V2
		V3_Over_Deviation	3		An over deviation is detected on V3

## Power Quality Log Results

Power quality log records can be retrieved in a file from the PowerMonitor 5000 web page or FTP server. The link for the power quality log is found in the LoggingResults.General\_Logs tab in the web page.

General_Logs	Records
<a href="#">Event Log.csv</a>	100
<a href="#">Time of Use Log.csv</a>	2
<a href="#">Load Factor Log.csv</a>	2
<a href="#">Alarm Log.csv</a>	100
<a href="#">Setpoint Log.csv</a>	100
<a href="#">Min Max Log.csv</a>	82
<a href="#">Power Quality Log.csv</a>	100

To retrieve the file, click the link and follow the prompts to save or open the file. The FTP server works in a similar way.

Records can also be retrieved sequentially through the native Ethernet network communication or an optional communication port by using the data table interface. A read of the [Statistics.Logging](#) table, on [page 365](#), returns the number of power quality log records in Element 15.

Select the power quality log and the desired order of record retrieval by writing values to these tags in the [Configuration.Log\\_Read](#) table on [page 326](#).

- Selected Log = 10, Power Quality Log
- Chronology of Auto Return Data = 0 for most recent first (default), 1 for earliest first

Successive reads of the [LoggingResults.Power\\_Quality\\_Log \(M6 and M8 model\)](#) table, on [page 394](#), return records in the selected sequence. After the last record is read, the next read starts again from the end or beginning of the log as was selected.

## Commands

Clear power quality log

## Trigger Data Log (M6 and M8 model)

A trigger data log is enabled as a setpoint or logic gate output action and stores a cycle-by-cycle record of the values of up to eight selected parameters for a selected duration when its associate setpoint activates.

### Setup

The trigger log requires the following to be configured:

- Basic Metering setup
- Date and Time setup
- Setpoint setup

At least one setpoint or logic gate output must be configured with a value of 30 = 'Trigger Data Log', to use the trigger data feature.

For example, to enable the trigger data log when Setpoint 1 goes active, the following parameters must be configured in the Configuration.Setpoint\_Outputs table:

Setpoint\_Output\_X\_Input\_Source = 1

(1 = Setpoint 1)

Setpoint\_Output\_X\_Action = 30

(30 = Trigger Data Log from the [Setpoint Output Action List](#) on [page 205](#))

Setpoint\_Output\_X ties its configured input source (either a setpoint or a logic gate) to its configured action, see the [Setpoint Output Action List](#) for available output actions. Setpoints or logic gates must be configured separately. See [Setpoint Setup on page 195](#) for more information on how to configure setpoints.

The trigger log is configured by default. If the default configuration satisfies your requirements, you do not need to change it. To modify the setup, edit the parameters in the Configuration.TriggerData tab, which contains the following parameters.

Trigger\_Mode - Selects how records are saved. Options are:

- 0 = Fill and stop recording when log is full
- 1 = Overwrite when log is full starting with the earliest record (default)

TriggerData\_Length\_s - Log duration, range = 1 (default) ...10 seconds

Trigger log parameter selection. For each, the range is 1...184, from the [Data Log Parameter List on page 139](#). The default values of the parameters are listed.

- TriggerData\_Parameter\_1 - 5 = Avg\_V\_N\_Volts
- TriggerData\_Parameter\_2 - 9 = Avg\_VL\_VL\_Volts
- TriggerData\_Parameter\_3 - 14 = Avg\_Amps



- TriggerData\_Parameter\_4 - 15 = Frequency\_Hz
- TriggerData\_Parameter\_5 - 19 = Total\_kW
- TriggerData\_Parameter\_6 - 23 = Total\_kVAR
- TriggerData\_Parameter\_7 - 27 = Total\_kVA
- TriggerData\_Parameter\_8 - 39 = Total\_PF\_Lead\_Lag\_Indicator

## Operation

When an associated setpoint activates, the trigger data file stores the selected parameters for the selected duration in a data file and stores the associated setpoint or logic gate identity and configuration parameters in a setpoint information file.

### File Names

Triggerlog\_YYYYMMDD\_hhmmss\_HH, and  
TriggerSetpointInfo\_YYYYMMDD\_hhmmss\_HH, where

- YYYYMMDD\_hhmmss = the local date and time stamp of the record, used to associate the trigger data file with its associated setpoint information
- HH = the UTC hour avoids duplication during daylight-saving time transition

See [Appendix A, LoggingResults.TriggerData\\_Header Data Table](#) for the content and structure of the setpoint information file, and [LoggingResults.TriggerData\\_Log Data Table](#) for the content and structure of the trigger data file.

## Trigger Data Log Results

Trigger data log records can be retrieved from the PowerMonitor 5000 web page or FTP server. Trigger data log records can also be retrieved sequentially by using the data table interface.

**Figure 31 - Trigger Data Log**

TriggerData_Log	Size (Byte)	Date (M/D/Y)	Time (H:M:S)
<a href="#">TriggerSetpointInfo_20130415_154733_07.csv</a>	174	04/15/2013	15:47:32
<a href="#">Triggerlog_20130415_154733_07.csv</a>	4536	04/15/2013	15:47:34
<a href="#">TriggerSetpointInfo_20130415_155338_07.csv</a>	172	04/16/2013	17:30:48
<a href="#">Triggerlog_20130415_155338_07.csv</a>	4536	04/16/2013	17:30:48

When retrieved from the web page or FTP server, the first row in the files is a header row containing parameter names.

### Trigger Data Log Single Record Retrieval

A controller or application can sequentially retrieve trigger data records by following the process that is described in this section, following these general tasks. Tables that are referenced are in [Appendix A](#).

1. Read the number of trigger data files from the [Statistics.Logging](#) table.

The [Statistics.Logging](#) table contains the following trigger data information:

- Element 11, the number of trigger data records (cycles)
- Element 12, the number of trigger data files

2. Write the [Configuration.Log\\_Read](#) table with Selected Log = 12.

The [Configuration.Log\\_Read](#) table contains the following elements:

- Element 0: Write a value of 12 to request the next trigger data log or trigger data setpoint information file name, or a value of 13 to select the trigger data header
- Element 1: Write a 0 to return the most recent file name first or a 1 to return the oldest file name first

3. Read the trigger data setpoint information file name from the [LoggingResults.TriggerLog\\_Setpoint\\_Info\\_File\\_Name Data Table](#) one or more times until the desired file name is returned.

4. Read the trigger data file name from the [LoggingResults.TriggerLog\\_FileName Data Table](#) one or more times until the desired file name is returned.

5. Write the selected file names into the [Configuration.TriggerDataLogFile Data Table](#) and [Configuration.TriggerSetpointInfoFile Data Table](#).

6. Perform a read of the [LoggingResults.TriggerData\\_Header Data Table](#) and store the results in a suitable location.

7. Perform sequential reads of the [LoggingResults.TriggerData\\_Log Data Table](#) and store the results in a suitable location.

The first read returns the total number of cycle data records in the log along with the selected parameter ID numbers. Subsequent reads return each the value of the selected parameters, cycle-by-cycle.

### Commands

- Clear trigger data log

## Snapshot Log

The Snapshot log captures a record of all data from one cycle on command.

### Setup

The Snapshot log requires the following to be configured:

- Basic Metering setup
- Date and Time setup

### Operation

The Snapshot log captures and records the present cycle data when a command is issued. The content and file structure of the Snapshot log differs between the M6 and M8 models. This table depicts the Snapshot log content for each model.

Model	Parameter Group	Results Set	Number of Records
M6	n/a	Date and time stamp to the millisecond All metering data All harmonic data Single harmonic results, DC up to the 63rd for the following - Voltage channels and average - Current channels and average - Real, reactive, and apparent power per phase and total	2270
M8	0 (default)	Parameter Group No. Date and time stamp to the millisecond All metering data All harmonic data Single harmonic results, DC up to the 127th for the following - Voltage channels and average - Current channels and average - Real, reactive, and apparent power per phase and total	4447
	1	Parameter Group No. Date and time stamp to the millisecond EN61000-4-30 Harmonic subgroups up to the 50th for voltage and current EN61000-4-30 Interharmonic subgroups up to the 50th for voltage and current EN61000-4-30 Power Quality parameters table	1233
	2	Parameter Group No. Date and time stamp to the millisecond EN61000-4-30 5 Hz harmonic results, magnitude, and angle for voltage and current EN61000-4-30 5Hz harmonic results, kW, kVAR, kVA magnitude	20,439

For the M8 model, select a Parameter Group by setting the value of the Metering\_Snapshot\_Parameter\_Selection parameter in the [Configuration.PowerQuality](#) table, on [page 327](#), or web page. You can download snapshot log parameter lists from the M6 and M8 model web pages to help interpret the log contents:

- Snapshot\_ParameterList\_Group0.csv
- Snapshot\_ParameterList\_Group1.csv
- Snapshot\_ParameterList\_Group2.csv

The file name includes the local date and time stamp. Subsequent metering data snapshot commands overwrite the previous file.

## File Name

The snapshot log file name is Metering\_Snapshot\_[Group#\_]YYYYMMDD\_hhmmssmmm.csv, where:

- Group# = Group 0, 1, or 2 (M8 model only)
- YYYYMMDD = Year, month, and day
- hhmmssmmm = Hour, minute, seconds, and milliseconds

## Metering Snapshot Log Results

The metering snapshot log results can be retrieved from the PowerMonitor 5000 web page or FTP server. Records are also retrieved sequentially starting from the beginning of the file by using the data table interface.

### Web Interface

Click the link and follow the prompts to save or open the log file. The Snapshot\_ParameterList file lists the parameter IDs and their corresponding tag names. The FTP page is similar.

**Figure 32 - Metering Snapshot Tab for the M6 Model**

Snapshot_Log	Records
<a href="#">Metering_Snapshot_20130624_104886360.csv</a>	2270
<a href="#">Snapshot_ParameterList.csv</a>	2270

**Figure 33 - Metering Snapshot Tab for the M8 Model**

Snapshot_Log	Records
<a href="#">Metering_Snapshot_Group1_20140603_093043098.csv</a>	1233
<a href="#">Snapshot_ParameterList_Group0.csv</a>	4447
<a href="#">Snapshot_ParameterList_Group1.csv</a>	1233
<a href="#">Snapshot_ParameterList_Group2.csv</a>	20439

### Data Table Interface

Successive reads of the [LoggingResults.Snapshot\\_Log Data Table](#), on [page 395](#), return sequential single parameters. The following is the data that is returned:

- Parameter\_Number - the ID number of the parameter. The Snapshot\_ParameterList.csv file contains a listing of tag names that are associated to parameter IDs and can be downloaded from the web page or FTP server.
- Parameter\_Value

## Commands

### Metering data snapshot

For the M8 model, the Parameter Group returned is based on the value of the Metering\_Snapshot\_Parameter\_Selection parameter in the [Configuration.PowerQuality](#) table, on [page 327](#), when the Metering Data Snapshot command is executed.

## EN 50160 Weekly and Yearly Logs

See [Appendix H](#) for information on the EN 50160 logs and compliance record.

**Notes:**

## Logic Functions

Topic	Page
Relay and KYZ Outputs	183
Status Inputs	187
Setpoints	191

This section describes the functions of the PowerMonitor™ 5000 unit. Most functions require you to configure set-up parameters to align the unit with your installation and your application requirements. The set-up parameters are listed by name and described in this section. You can view set-up parameters by using the PowerMonitor 5000 web page, and when logged in to an Admin account, changes the setup. Set-up parameters are also accessible by using communication.

See the [PowerMonitor 5000 Unit Data Tables](#) in [Appendix A](#) for additional information on setup parameters including the following:

- Range of valid values
- Default values
- Data type

Set-up parameters can be found in data tables with names beginning with 'Configuration,' for instance Configuration.Metering.Basic.

## Relay and KYZ Outputs

The PowerMonitor 5000 unit is equipped with three electromechanical Form C relay outputs, typically used for control and annunciation, and one KYZ output solid-state relay designed for low-power, long-life signaling operation. The typical use for the KYZ output is to provide a pulse output proportional to energy consumption to an external totalizer.

## Applications

These outputs apply to all models.

## Operation

The outputs can operate in the following modes:

- Energy pulse operation with fixed pulse width or toggle
- Setpoint operation
- I/O control through a Class 1 connection
- Forced operation

---

**IMPORTANT** I/O control can use relay output contacts and solid-state KYZ outputs on the PowerMonitor 5000 unit to control other devices. You can select the response of these outputs to a loss of the connection. Be sure to evaluate the safety impact of the output configuration on your plant or process.

---

The Default output state on communication loss defines the behavior of the output if the PowerMonitor 5000 unit experiences the loss of a Class 1 (I/O) connection with a Logic controller.

Forced operation of outputs over-rides pulsed operation and setpoint control. Forced operation is not permitted if an I/O (for example, Exclusive Owner or Data) connection exists. Force operations are written to the Status Log.

## Setup

Relay and KYZ output setup parameters specify the operation of each output, and are found in the [Configuration.System.General](#) table on [page 293](#).

*KYZ\_Output\_Parameter*

*Output\_Relay\_1\_Output\_Parameter*

*Output\_Relay\_2\_Output\_Parameter*

*Output\_Relay\_3\_Output\_Parameter*

The output parameter defines how each output is controlled, and for pulsed operation, relates an output pulse rate to a specified energy value. These values are the selections:

- 0 = Disable
- 1 = Wh Fwd
- 2 = Wh Rev
- 3 = VARh Fwd
- 4 = VARh Rev
- 5 = Vah
- 6 = Ah



*KYZ\_Solid\_State\_Output\_Scale*  
*Output\_Relay\_1\_Output\_Scale*  
*Output\_Relay\_2\_Output\_Scale*  
*Output\_Relay\_3\_Output\_Scale*

The output parameter that is divided by the scale is the output pulse rate. Example: Wh is selected for the parameter and 1000 is the scale value. The output is pulsed every 1000 Wh, or 1 kWh. This parameter is ignored for setpoint or communication operation.

*KYZ\_Pulse\_Duration\_Setting*  
*Output\_Relay\_1\_Pulse\_Duration\_Setting*  
*Output\_Relay\_2\_Pulse\_Duration\_Setting*  
*Output\_Relay\_3\_Pulse\_Duration\_Setting*

Defines the duration of each output pulse. These values are the choices:

0 = KYZ-style transition output (toggle)

50...1000 = Pulse duration in milliseconds, rounded to the nearest 10 ms.  
 This parameter is ignored for setpoint or communication operation.

*Default\_KYZ\_State\_On\_Comm\_Loss*  
*Default\_Relay\_1\_State\_On\_Comm\_Loss*  
*Default\_Relay\_2\_State\_On\_Comm\_Loss*  
*Default\_Relay\_3\_State\_On\_Comm\_Loss*

In Class 1 scheduled communication operation, this parameter defines the behavior of the specified output if the power monitor experiences a communication loss/communication recovery. These values are the selections:

0 = Last state/resume  
 1 = Last state/freeze  
 2 = De-energize/resume  
 3 = De-energize/freeze  
 4 = Local control

Semantics of selections:

- Last-state = hold the output in its last state on communication loss
- De-energize = put output into de-energized or normal state on communication loss
- Resume = restore output control when communication recovers
- Freeze = maintain state of output when communication recovers until one of the following occurs:
  - Logic controller enters program mode
  - Power cycle to the power monitor
  - Change the parameter value to ‘resume’
- Local Control = Revert to local power monitor control (pulsed or setpoint) on communication loss. When communication recovers and connection is re-established, output control by the connection host resumes.

## Status

Relay and KYZ output status is reported by the state of the following Boolean tags, found in the [Status.DiscreteIO](#) table on [page 342](#).

For each tag, 0 = False, 1 = True.

*KYZ\_Output\_Energized*  
*KYZ\_Forced\_On*  
*KYZ\_Forced\_Off*  
*Relay\_1\_Output\_Energized*  
*Relay\_1\_Forced\_On*  
*Relay\_1\_Forced\_Off*  
*Relay\_2\_Output\_Energized*  
*Relay\_2\_Forced\_On*  
*Relay\_2\_Forced\_Off*  
*Relay\_3\_Output\_Energized*  
*Relay\_3\_Forced\_On*  
*Relay\_3\_Forced\_Off*

## Commands

The following command parameters are found in the [Command.System\\_Registers](#) table on [page 368](#). These commands are not permitted if an Exclusive Owner connection has been established with a Logix controller.

*Command Word One*

Set this command word value to execute the corresponding action. These values are the selections:

- 10 = Force KYZ Output On
- 11 = Force KYZ Output Off
- 12 = Remove Force from KYZ
- 13 = Force Relay 1 Output On
- 14 = Force Relay 1 Output Off
- 15 = Remove Force from Relay 1
- 16 = Force Relay 2 Output On
- 17 = Force Relay 2 Output Off
- 18 = Remove Force from Relay 2
- 19 = Force Relay 3 Output On
- 20 = Force Relay 3 Output Off
- 21 = Remove Force from Relay 3

*Related Functions*

- Configuration lock
- Status Log
- Setpoints
- EDS add-on profile

**Status Inputs**

The PowerMonitor 5000 unit has four self-powered (24V DC) status inputs. Two typical uses for status inputs are to totalize external pulse meters and to synchronize the demand end of interval (EOI).

**Applications**

These inputs apply to all models.

**Operation**

Each time status input 1 sees an off to on transition, the status input 1 scale factor is added to the status input 1 count. The count continues to increase, rolling over to zero at a value of 9,999,999,999,999 ( $10^{13} - 1$ ). Status inputs 2, 3, and 4 operate in the same fashion. The status input 2 counter operates whether or not the input is used for demand EOI synchronization.

## Setup

The setup parameters for pulse totalizing and scaling are in the [Configuration.System.General](#) table on [page 293](#) and are summarized in the following section.

### *Log\_Status\_Input\_Changes*

These values are the choices:

- 0 = Disable recording of status input changes into the event log
- 1 = Enable recording of event input changes into the event log

### *Status\_Input\_1\_Input\_Scale*

### *Status\_Input\_2\_Input\_Scale*

### *Status\_Input\_3\_Input\_Scale*

### *Status\_Input\_4\_Input\_Scale*

When a status pulse is received, the count is increased by the scale factor. (Input pulse \* input scale) added to total status count.

Setup for demand EOI synchronization is described in [Basic Metering on page 71](#).

## Status

Status input status is reported by the state of the following Boolean tags, found in the [Status.DiscreteIO](#) table on [page 342](#). For each tag, 0 = false, 1 = true.

### *Status\_Input\_1\_Actuated*

### *Status\_Input\_2\_Actuated*

### *Status\_Input\_3\_Actuated*

### *Status\_Input\_4\_Actuated*

The scaled value of status input counters are reported in the following tags, found in the [MeteringResults.Energy\\_Demand](#) table on [page 375](#).

*Status\_1\_Count\_xM*  
*Status\_1\_Count\_x1*  
*Status\_2\_Count\_xM*  
*Status\_2\_Count\_x1*  
*Status\_3\_Count\_xM*  
*Status\_3\_Count\_x1*  
*Status\_4\_Count\_xM*  
*Status\_4\_Count\_x1*

The semantics for these parameters:

X 1 = value time 1, range = 0...999,999

X M = value time 1 million, range = 0...9,999,999

Combined range (X M, X 1) = 0...9,999,999,999,999

## Commands

The following command parameters are found in the [Command.System\\_Registers](#) table on [page 368](#).

### *Command Word One*

Set this command word value to set or reset (to zero) a scaled status input counter value. These values are the selections:

6 = Set Status 1 Count

7 = Set Status 2 Count

8 = Set Status 3 Count

9 = Set Status 4 Count

These commands operate by using the values contained in the tags listed in this section. The default values are zero. The semantics are the same as described in the [Status](#) subclause.

*Status 1 Count x M Register Set Value*  
*Status 1 Count X 1 Register Set Value*  
*Status 2 Count x M Register Set Value*  
*Status 2 Count X 1 Register Set Value*  
*Status 3 Count x M Register Set Value*  
*Status 3 Count X 1 Register Set Value*  
*Status 4 Count x M Register Set Value*  
*Status 4 Count X 1 Register Set Value*

## **Related Functions**

Configuration lock.

## Setpoints

A Setpoint tracks the value of a user-selected parameter and when the value meets user-defined criteria, sets the corresponding Setpoint\_Active flag, and executes an optional user-selected action.

### Applications

- M5 model: 10 simple setpoints
- M6 and M8 models: 20 simple or logical setpoints with 10 logic gates

### Operation

A PowerMonitor 5000 unit setpoint continually monitors the selected parameter and evaluates its value against the configured test condition, evaluation types, threshold, and hysteresis values. The setpoint is armed when the parameter value satisfies the test condition. A setpoint activates when the setpoint has been armed for at least the assert delay time. The setpoint is dis-armed when the parameter value no longer satisfies the test condition (including a dead band that is defined by the hysteresis value), and de-activates when the setpoint has been dis-armed for at least the deassert delay time.

Each setpoint can be tied to an output action, such as energizing a relay output or clearing a value. In the M6 and M8 models, setpoints can also be used as inputs to up to 10 logic gates, which let you combine setpoints to take specified actions.

The power monitor provides setpoint data including status of each setpoint, statistics relating to setpoint operations, and a setpoint history log.

See [Setpoint and Logic Gate Status on page 206](#) for more information.

### *Evaluation Types*

The M5 model provides two evaluation types for setpoints:

- Magnitude - the selected parameter is compared against a fixed value that you configure in the Threshold tag for the setpoint. Magnitude is the default selection and is typically used with metering values that are analog in nature.
- State - the selected parameter is compared against a Boolean value (0...1) configured by you in the Threshold tag for the setpoint. State is typically used with discrete parameter values that are either off (0) or on (1).

The M6 and M8 models provide two additional evaluation types:

- Percent of Reference - the selected parameter is compared against a percentage of a fixed nominal reference value. You configure a nominal value in the Reference Value tag for the setpoint, and configure the percentage in the Threshold tag for the setpoint. This evaluation type operates similar to the Magnitude evaluation type but the power monitor, rather than you, calculates the percentage of the nominal value.

- Percent of Sliding Reference - the selected parameter is compared against the sliding average of that parameter. This evaluation type can identify rapid variations from a nominal value that changes relatively slowly over time. You configure the sliding average interval in minutes by setting the value of the Relative\_Setpoint\_Interval\_m tag, found in the [Configuration.PowerQuality Data Table on page 327](#) which has a range of 1...1440 minutes (24 hours). One Relative\_Setpoint\_Interval is used for all setpoints. The sliding average is updated at a rate of one second per minute of interval. For example, a 5 minute sliding average interval updates every 5 seconds. You configure the percentage of the sliding average in the Threshold tag for each setpoint. The Reference tag is not used in the Percent of Sliding Reference evaluation type.

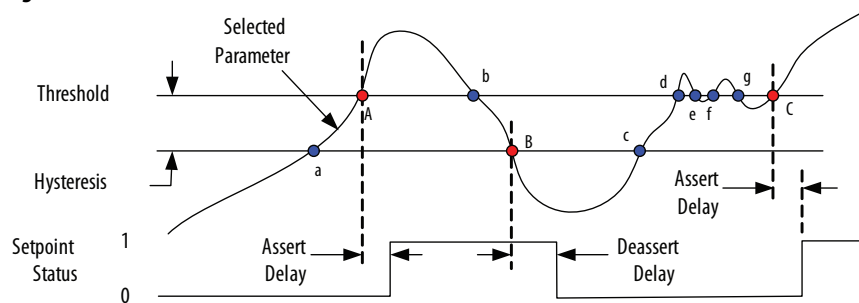
*Simple Setpoint Logic (all models)*

The PowerMonitor 5000 unit provides three test conditions for setpoint logic. Any parameter type is permitted to be used with any test condition. Be sure to test the operation of your setpoint setup to assure the desired operation.

*Greater Than*

A Greater Than setpoint test condition arms the setpoint for activation when the monitored value is greater than the threshold, and dis-arms the setpoint when the value is less than the threshold less the hysteresis value. [Figure 34](#) illustrates this test condition. In [Figure 34](#), the setpoint is armed at point A, dis-armed at point B, and armed at point C. Points d and f also arm the setpoint but the value decreases below the threshold at points e and g before the assert delay time passes.

**Figure 34 - Greater Than Test Condition**

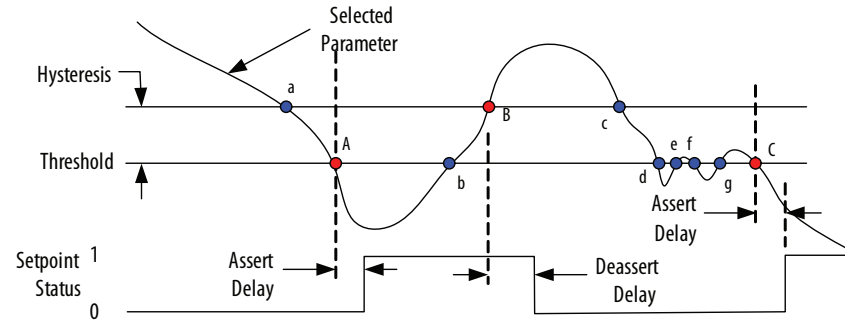




*Less Than*

A Less Than test condition arms the setpoint for activation when the monitored value is less than the threshold, and dis-arms the setpoint when the value is greater than the threshold plus hysteresis. [Figure 35](#) illustrates this test condition. In [Figure 35](#), the setpoint is armed at point A, dis-armed at point B, and armed at point C. Points d and f also arm the setpoint but the value increase above the threshold at points e and g before the assert delay time passes.

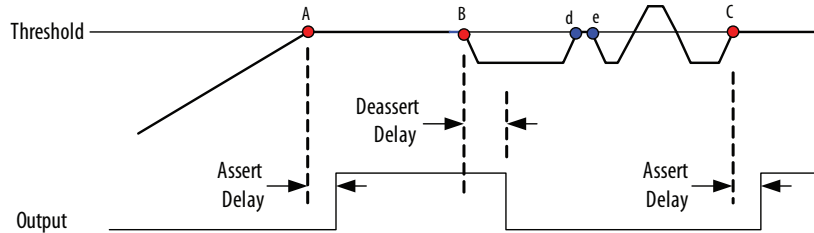
**Figure 35 - Less Than Test Condition**



### Equal To

An Equal To test condition arms the setpoint for activation when the monitored value exactly equals the threshold, and dis-arms the setpoint when the value no longer equals the threshold. Hysteresis is ignored in the Equal To test condition. [Figure 36](#) illustrates this test condition. In [Figure 36](#), the setpoint is armed at point A, dis-armed at point B, and armed at point C. Point d also arms the setpoint but the value changes at point e before the assert delay time passes.

**Figure 36 - Equal To Test Condition**

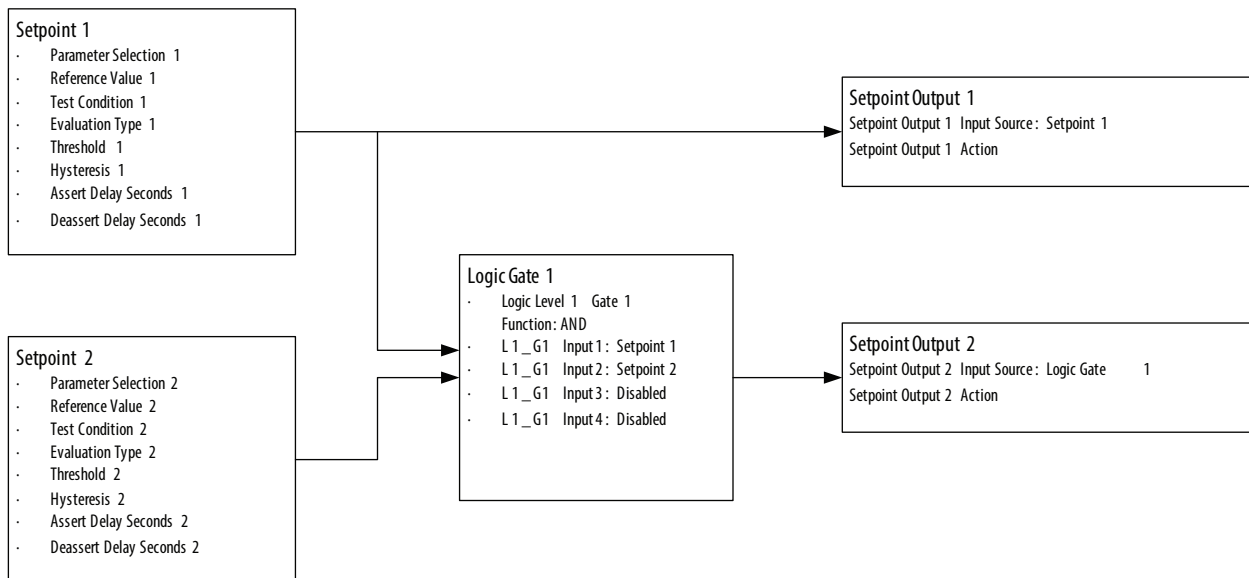


### Setpoint Logic Gates (M6 and M8 models)

Up to 10 logic gates can be used to combine logically the setpoints to enable output actions. Each logic gate can have up to four inputs. Select among AND, NAND, OR, NOR, XOR, or XNOR logic. XOR and XNOR use inputs 1 and 2.

In [Figure 37](#), Setpoint Output 1 activates when Setpoint 1 asserts. Setpoint Output 2 activates when both Setpoint 1 and Setpoint 2 assert.

**Figure 37 - Setpoint Example**



*Operation*

- AND

An AND gate output asserts when ALL of its enabled inputs are asserted. Disabled inputs are ignored. If only one input is enabled, the logic gate output copies the input state.

- NAND

A NAND, or Not-AND, gate output asserts except when ALL of its enabled inputs are asserted. Disabled inputs are ignored. If only one input is enabled, the logic gate output inverts the input state.

- OR

An OR gate output asserts when ANY of its enabled inputs is asserted. Disabled inputs are ignored. If only one input is enabled, the logic gate output copies the input state.

- NOR

A NOR, or Not-OR, gate asserts when NONE of its enabled inputs are asserted. Disabled inputs are ignored. If only one input is enabled, the logic gate output inverts the input state.

- XOR

An XOR, or exclusive-OR, gate asserts when only one of its two inputs is asserted. An XOR gate must have two and only two inputs enabled. Both inputs must be configured simultaneously or an error results.

- XNOR

An XNOR, or exclusive-NOR, gate asserts when either both of its two inputs are asserted or both are de-asserted. An XNOR gate must have two and only two inputs enabled. Both inputs must be configured simultaneously or an error results.

In general, a logic gate is disabled and its output is de-asserted if none of its inputs are enabled. Except for XOR and XNOR gates, any combination of enabled and disabled inputs is accepted. The output of a logic gate is not permitted to be used as the input to a logic gate.

## Setpoint Setup

The tags that are listed in this section configure the operation of each setpoint, and are found in the [Configuration.Setpoints\\_1\\_5](#) and [Configuration.Setpoints\\_6\\_10](#) tables in the M5 model. The M6 and M8 models also have two additional tables for setting up setpoints, [Configuration.Setpoints\\_11\\_15 Data Table](#) and [Configuration.Setpoints\\_16\\_20 Data Table](#), and a Relative\_Setpoint\_Interval tag in the [Configuration.PowerQuality](#) table for configuring the sliding reference for all setpoints. These tables are in [Appendix A](#).

*Parameter Selection n*

Selects a power monitor parameter to track. See [Setpoint Parameter Selection List on page 198](#).

*Reference Value n*

Used only when Evaluation Type n = 2, Percent of Reference; otherwise ignored.

Range = -10,000,000...10,000,000, default = 0

*Test Condition n*

0 = Disable (default)

1 = Less Than

2 = Greater Than

3 = Equals

*Evaluation Type n*

0 = Magnitude (default)

1 = State (0 = off, 1 = on)

2 = Percent of Reference (M6 and M8 models only)

3 = Percent of Sliding Reference (M6 and M8 models only)

*Threshold n*

When Evaluation\_Type is set to 0 = Magnitude or 1 = State, this parameter specifies the value or state that arms the Assert Delay timer to activate the setpoint and trigger the optional output action. When Evaluation\_Type is 2 = Percent of Reference or 3 = Percent of Sliding Reference, this parameter specifies the percentage of Reference\_Value\_n, which then becomes the effective threshold for the setpoint. Range: -10,000,000...10,000,000, default = 0

*Hysteresis n*

The dead band from the Threshold value arms the Deassert Delay timer to deactivate the setpoint and release the optional output action. Hysteresis is ignored when TestCondition n is 'Equals'.

Range = 0...10,000,000, default = 0

*Assert Delay Seconds n*

The amount of time the selected value must satisfy the test condition to activate the setpoint. Range = 0.000 (default)...3600.

Actual minimum time is equal to the setting of the Realtime\_Update\_Rate in [Configuration.Metering.Basic](#) table on [page 291](#).

*Deassert Delay Seconds n*

The amount of time the selected value must no longer satisfy the test condition to activate the setpoint. Range = 0.000...3600.

Actual minimum time is equal to the setting of the Realtime\_Update\_Rate in [Configuration.Metering.Basic](#) table on [page 291](#).

*Relative\_Setpoint\_Interval\_m*

This tag, found in the [Configuration.PowerQuality](#) table on [page 327](#), defines the length of the sliding average interval that is used in all setpoints with Percent of Sliding Reference evaluation type. Range: 1...1440 minutes, default 60.

**Setpoint Logic Gate Setup**

The tags that are listed in this section can be used to configure setpoint logic gates and are found in the [Configuration.Setpoint\\_Logic Data Table](#) on [page 311](#).

*Logic Level 1 Gate n Function*

Selects the logic type for the gate. These values are the choices:

- 0 = disabled
- 1 = AND
- 2 = NAND
- 3 = OR
- 4 = NOR
- 5 = XOR
- 6 = XNOR

*L1\_Gn Input 1**L1\_Gn Input 2**L1\_Gn Input 3**L1\_Gn Input 4*

Selects input parameters for the nth logic gate (n = 1 ... 10). Each AND, NAND, OR, and NOR gate has up to four inputs. These values are the choices:

- 0 = Disabled
- 1 = Setpoint 1; -1 = Setpoint 1 inverted
- 2 = Setpoint 2; -2 = Setpoint 2 inverted
- 3 = Setpoint 3; -3 = Setpoint 3 inverted
- ...
- 20 = Setpoint 20; -20 = Setpoint 20 inverted

---

**IMPORTANT** XOR and XNOR use Inputs 1 and 2; both must be configured simultaneously, otherwise an error is reported and the logic gate configuration is rejected.

---

## Setpoint Output Setup

The [Status.Alarms](#) table on [page 348](#) contains a status bit that is on when each setpoint or logic gate is active and is off when the setpoint or logic gate is not active. You can optionally assign an output action, such as energizing a relay output or clearing a counter. An output action does not have to be assigned. Many applications can monitor the setpoint or logic gate status bits in the [Status.Alarms](#) table. The tags that are listed can optionally be used to tie output actions to setpoints, and are found in the [Configuration.Setpoint\\_Outputs](#) table on [page 320](#).

### Setpoint Output n Input Source

The Setpoint Output n (1, 2, ...) Input Source specifies the setpoint or logic gate to associate with the output action.

1...10 = Setpoints 1...1

11...20 = Setpoints 11...20 (M6 and M8 models)

21...30 = Level 1 Logic Gates 1...10 (M6 and M8 models)

### Setpoint Output n Action

See [Setpoint Output Action List on page 205](#) for selections.

## Setpoint Reference Tables

**Table 25 - Setpoint Parameter Selection List**

Parameter Number	Parameter Tag Name	Units	Range	M5	M6	M8
0	None			X	X	X
1	V1_N_Volts	V	0...9.999E15	X	X	X
2	V2_N_Volts	V	0...9.999E15	X	X	X
3	V3_N_Volts	V	0...9.999E15	X	X	X
4	VGN_N_Volts	V	0...9.999E15	X	X	X
5	Avg_V_N_Volts	V	0...9.999E15	X	X	X
6	V1_V2_Volts	V	0...9.999E15	X	X	X
7	V2_V3_Volts	V	0...9.999E15	X	X	X
8	V3_V1_Volts	V	0...9.999E15	X	X	X
9	Avg_VL_VL_Volts	V	0...9.999E15	X	X	X
10	I1_Amps	A	0...9.999E15	X	X	X
11	I2_Amps	A	0...9.999E15	X	X	X
12	I3_Amps	A	0...9.999E15	X	X	X
13	I4_Amps	A	0...9.999E15	X	X	X

Table 25 - Setpoint Parameter Selection List (continued)

Parameter Number	Parameter Tag Name	Units	Range	M5	M6	M8
14	Avg_Amps	A	0...9.999E15	X	X	X
15	Frequency_Hz	Hz	40.00...70.00	X	X	X
16	L1_kW	kW	-9.999E15...9.999E15	X	X	X
17	L2_kW	kW	-9.999E15...9.999E15	X	X	X
18	L3_kW	kW	-9.999E15...9.999E15	X	X	X
19	Total_kW	kW	-9.999E15...9.999E15	X	X	X
20	L1_kVAR	kVAR	-9.999E15...9.999E15	X	X	X
21	L2_kVAR	kVAR	-9.999E15...9.999E15	X	X	X
22	L3_kVAR	kVAR	-9.999E15...9.999E15	X	X	X
23	Total_kVAR	kVAR	-9.999E15...9.999E15	X	X	X
24	L1_kVA	kVA	0...9.999E15	X	X	X
25	L2_kVA	kVA	0...9.999E15	X	X	X
26	L3_kVA	kVA	0...9.999E15	X	X	X
27	Total_kVA	kVA	0...9.999E15	X	X	X
28	L1_True_PF	%	0.00...100.00	X	X	X
29	L2_True_PF	%	0.00...100.00	X	X	X
30	L3_True_PF	%	0.00...100.00	X	X	X
31	Total_True_PF	%	0.00...100.00	X	X	X
32	L1_Disp_PF	%	0.00...100.00	X	X	X
33	L2_Disp_PF	%	0.00...100.00	X	X	X
34	L3_Disp_PF	%	0.00...100.00	X	X	X
35	Total_Disp_PF	%	0.00...100.00	X	X	X
36	L1_PF_Lead_Lag_Indicator	-	-1 or 1	X	X	X
37	L2_PF_Lead_Lag_Indicator	-	-1 or 1	X	X	X
38	L3_PF_Lead_Lag_Indicator	-	-1 or 1	X	X	X
39	Total_PF_Lead_Lag_Indicator	-	-1 or 1	X	X	X
40	V1_Crest_Factor	-	0...9.999E15	X	X	X
41	V2_Crest_Factor	-	0...9.999E15	X	X	X
42	V3_Crest_Factor	-	0...9.999E15	X	X	X
43	V1_V2_Crest_Factor	-	0...9.999E15	X	X	X
44	V2_V3_Crest_Factor	-	0...9.999E15	X	X	X
45	V3_V1_Crest_Factor	-	0...9.999E15	X	X	X
46	I1_Crest_Factor	-	0...9.999E15	X	X	X
47	I2_Crest_Factor	-	0...9.999E15	X	X	X
48	I3_Crest_Factor	-	0...9.999E15	X	X	X
49	I4_Crest_Factor	-	0...9.999E15	X	X	X
50	V1_IEEE_THD_%	%	0.00...100.00	X	X	X
51	V2_IEEE_THD_%	%	0.00...100.00	X	X	X
52	V3_IEEE_THD_%	%	0.00...100.00	X	X	X

**Table 25 - Setpoint Parameter Selection List (continued)**

Parameter Number	Parameter Tag Name	Units	Range	M5	M6	M8
53	VN_G_IEEE_THD_%	%	0.00...100.00	X	X	X
54	Avg_IEEE_THD_V_%	%	0.00...100.00	X	X	X
55	V1_V2_IEEE_THD_%	%	0.00...100.00	X	X	X
56	V2_V3_IEEE_THD_%	%	0.00...100.00	X	X	X
57	V3_V1_IEEE_THD_%	%	0.00...100.00	X	X	X
58	Avg_IEEE_THD_V_V_%	%	0.00...100.00	X	X	X
59	I1_IEEE_THD_%	%	0.00...100.00	X	X	X
60	I2_IEEE_THD_%	%	0.00...100.00	X	X	X
61	I3_IEEE_THD_%	%	0.00...100.00	X	X	X
62	I4_IEEE_THD_%	%	0.00...100.00	X	X	X
63	Avg_IEEE_THD_I_%	%	0.00...100.00	X	X	X
64	V1_IEC_THD_%	%	0.00...100.00	X	X	X
65	V2_IEC_THD_%	%	0.00...100.00	X	X	X
66	V3_IEC_THD_%	%	0.00...100.00	X	X	X
67	VN_G_IEC_THD_%	%	0.00...100.00	X	X	X
68	Avg_IEC_THD_V_%	%	0.00...100.00	X	X	X
69	V1_V2_IEC_THD_%	%	0.00...100.00	X	X	X
70	V2_V3_IEC_THD_%	%	0.00...100.00	X	X	X
71	V3_V1_IEC_THD_%	%	0.00...100.00	X	X	X
72	Avg_IEC_THD_V_V_%	%	0.00...100.00	X	X	X
73	I1_IEC_THD_%	%	0.00...100.00	X	X	X
74	I2_IEC_THD_%	%	0.00...100.00	X	X	X
75	I3_IEC_THD_%	%	0.00...100.00	X	X	X
76	I4_IEC_THD_%	%	0.00...100.00	X	X	X
77	Avg_IEC_THD_I_%	%	0.00...100.00	X	X	X
78	I1_K_Factor	-	1.00...25000.00	X	X	X
79	I2_K_Factor	-	1.00...25000.00	X	X	X
80	I3_K_Factor	-	1.00...25000.00	X	X	X
81	Pos_Seq_Volts	V	0...9.999E15	X	X	X
82	Neg_Seq_Volts	V	0...9.999E15	X	X	X
83	Zero_Seq_Volts	V	0...9.999E15	X	X	X
84	Pos_Seq_Amps	A	0...9.999E15	X	X	X
85	Neg_Seq_Amps	A	0...9.999E15	X	X	X
86	Zero_Seq_Amps	A	0...9.999E15	X	X	X
87	Voltage_Unbalance_%	%	0.00...100.00	X	X	X
88	Current_Unbalance_%	%	0.00...100.00	X	X	X
89	kW Demand	kW	±0.000...9,999,999	X	X	X
90	kVAR Demand	kVAR	±0.000...9,999,999	X	X	X
91	kVA Demand	kVA	0.000...9,999,999	X	X	X



Table 25 - Setpoint Parameter Selection List (continued)

Parameter Number	Parameter Tag Name	Units	Range	M5	M6	M8
92	Demand PF	%	-100.0...+100.0	X	X	X
93	Demand Amps	A	0.000...9,999,999	X	X	X
94	Projected_kW_Demand	kW	-9,999,999...9,999,999	X	X	X
95	Projected_kVAR_Demand	kVAR	-9,999,999...9,999,999	X	X	X
96	Projected_kVA_Demand	kVA	0.000...9,999,999	X	X	X
97	Projected_Ampere_Demand	A	0.000...9,999,999	X	X	X
98	Status_Input_1_Actuated		0 or 1	X	X	X
99	Status_Input_2_Actuated		0 or 1	X	X	X
100	Status_Input_3_Actuated		0 or 1	X	X	X
101	Status_Input_4_Actuated		0 or 1	X	X	X
102	Log_Status		See <a href="#">Status.Alarms</a> table	X	X	X
103	PowerQuality_Status		See <a href="#">Status.Alarms</a> table	X	X	X
104	Over_Range_Information		See <a href="#">Status.Alarms</a> table	X	X	X
105	Metering_Status		See <a href="#">Status.Alarms</a> table	X	X	X
106	200mS_V1_N_Magnitude	V	0.000...9,999,999			X
107	200mS_V2_N_Magnitude	V	0.000...9,999,999			X
108	200mS_V3_N_Magnitude	V	0.000...9,999,999			X
109	200mS_VN_G_Magnitude	V	0.000...9,999,999			X
110	200mS_VN_Ave_Magnitude	V	0.000...9,999,999			X
111	200mS_V1_V2_Magnitude	V	0.000...9,999,999			X
112	200mS_V2_V3_Magnitude	V	0.000...9,999,999			X
113	200mS_V3_V1_Magnitude	V	0.000...9,999,999			X
114	200mS_VV_Ave_Magnitude	V	0.000...9,999,999			X
115	200mS_I1_Amps_Magnitude	A	0.000...9,999,999			X
116	200mS_I2_Amps_Magnitude	A	0.000...9,999,999			X
117	200mS_I3_Amps_Magnitude	A	0.000...9,999,999			X
118	200mS_I4_Amps_Magnitude	A	0.000...9,999,999			X
119	200mS_Amps_Ave_Magnitude	A	0.000...9,999,999			X
120	200mS_L1_kW	kW	-9.999E15...9.999E15			X
121	200mS_L2_kW	kW	-9.999E15...9.999E15			X
122	200mS_L3_kW	kW	-9.999E15...9.999E15			X
123	200mS_Total_kW	kW	-9.999E15...9.999E15			X
124	200mS_L1_kVAR	kVAR	-9.999E15...9.999E15			X
125	200mS_L2_kVAR	kVAR	-9.999E15...9.999E15			X

**Table 25 - Setpoint Parameter Selection List (continued)**

Parameter Number	Parameter Tag Name	Units	Range	M5	M6	M8
126	200mS_L3_kVAR	kVAR	-9.999E15...9.999E15			X
127	200mS_Total_kVAR	kVAR	-9.999E15...9.999E15			X
128	200mS_L1_kVA	kVA	0.000...9.999E15			X
129	200mS_L2_kVA	kVA	0.000...9.999E15			X
130	200mS_L3_kVA	kVA	0.000...9.999E15			X
131	200mS_Total_kVA	kVA	0.000...9.999E15			X
132	200mS_L1_True_PF	%	0.00...100.00			X
133	200mS_L2_True_PF	%	0.00...100.00			X
134	200mS_L3_True_PF	%	0.00...100.00			X
135	200mS_Total_True_PF	%	0.00...100.00			X
136	200mS_L1_Disb_PF	%	0.00...100.00			X
137	200mS_L2_Disb_PF	%	0.00...100.00			X
138	200mS_L3_Disb_PF	%	0.00...100.00			X
139	200mS_Total_Disb_PF	%	0.00...100.00			X
140	200mS_V1_N_IEEE_THD_%	%	0.00...100.00			X
141	200mS_V2_N_IEEE_THD_%	%	0.00...100.00			X
142	200mS_V3_N_IEEE_THD_%	%	0.00...100.00			X
143	200mS_VN_G_IEEE_THD_%	%	0.00...100.00			X
144	200mS_Avg_IEEE_THD_V_%	%	0.00...100.00			X
145	200mS_V1_V2_IEEE_THD_%	%	0.00...100.00			X
146	200mS_V2_V3_IEEE_THD_%	%	0.00...100.00			X
147	200mS_V3_V1_IEEE_THD_%	%	0.00...100.00			X
148	200mS_Avg_IEEE_THD_V_V_%	%	0.00...100.00			X
149	200mS_I1_IEEE_THD_%	%	0.00...100.00			X
150	200mS_I2_IEEE_THD_%	%	0.00...100.00			X
151	200mS_I3_IEEE_THD_%	%	0.00...100.00			X
152	200mS_I4_IEEE_THD_%	%	0.00...100.00			X
153	200mS_Avg_IEEE_THD_I_%	%	0.00...100.00			X
154	200mS_V1_N_IEC_THD_%	%	0.00...100.00			X
155	200mS_V2_N_IEC_THD_%	%	0.00...100.00			X
156	200mS_V3_N_IEC_THD_%	%	0.00...100.00			X
157	200mS_VN_G_IEC_THD_%	%	0.00...100.00			X
158	200mS_Avg_IEC_THD_V_%	%	0.00...100.00			X
159	200mS_V1_V2_IEC_THD_%	%	0.00...100.00			X
160	200mS_V2_V3_IEC_THD_%	%	0.00...100.00			X
161	200mS_V3_V1_IEC_THD_%	%	0.00...100.00			X
162	200mS_Avg_IEC_THD_V_V_%	%	0.00...100.00			X
163	200mS_I1_IEC_THD_%	%	0.00...100.00			X
164	200mS_I2_IEC_THD_%	%	0.00...100.00			X

Table 25 - Setpoint Parameter Selection List (continued)

Parameter Number	Parameter Tag Name	Units	Range	M5	M6	M8
165	200mS_I3_IEC_THD_%	%	0.00...100.00			X
166	200mS_I4_IEC_THD_%	%	0.00...100.00			X
167	200mS_Avg_IEC_THD_I_%	%	0.00...100.00			X
168	200mS_V1_N_THDS	%	0.00...100.00			X
169	200mS_V2_N_THDS	%	0.00...100.00			X
170	200mS_V3_N_THDS	%	0.00...100.00			X
171	200mS_VN_G_THDS	%	0.00...100.00			X
172	200mS_AVE_VN_THDS	%	0.00...100.00			X
173	200mS_V1_V2_THDS	%	0.00...100.00			X
174	200mS_V2_V3_THDS	%	0.00...100.00			X
175	200mS_V3_V1_THDS	%	0.00...100.00			X
176	200mS_AVE_LL_THDS	%	0.00...100.00			X
177	200mS_V1_N_TIHDS	%	0.00...100.00			X
178	200mS_V2_N_TIHDS	%	0.00...100.00			X
179	200mS_V3_N_TIHDS	%	0.00...100.00			X
180	200mS_VN_G_TIHDS	%	0.00...100.00			X
181	200mS_AVE_VN_TIHDS	%	0.00...100.00			X
182	200mS_V1_V2_TIHDS	%	0.00...100.00			X
183	200mS_V2_V3_TIHDS	%	0.00...100.00			X
184	200mS_V3_V1_TIHDS	%	0.00...100.00			X
185	200mS_AVE_LL_TIHDS	%	0.00...100.00			X
186	200mS_I1_K_Factor	-	1.00...25000.00			X
187	200mS_I2_K_Factor	-	1.00...25000.00			X
188	200mS_I3_K_Factor	-	1.00...25000.00			X
189	200mS_Pos_Seq_Volts	V	0...9.999E15			X
190	200mS_Neg_Seq_Volts	V	0...9.999E15			X
191	200mS_Zero_Seq_Volts	V	0...9.999E15			X
192	200mS_Pos_Seq_Amps	A	0...9.999E15			X
193	200mS_Neg_Seq_Amps	A	0...9.999E15			X
194	200mS_Zero_Seq_Amps	A	0...9.999E15			X
195	200mS_Voltage_Unbalance_%	%	0.00...100.00			X
196	200mS_Current_Unbalance_%	%	0.00...100.00			X
197	10s_Power_Frequency	Hz	40.00...70.00			X
198	3s_V1_N_Magnitude	V	0...9.999E15			X
199	10m_V1_N_Magnitude	V	0...9.999E15			X
200	2h_V1_N_Magnitude	V	0...9.999E15			X
201	3s_V2_N_Magnitude	V	0...9.999E15			X
202	10m_V2_N_Magnitude	V	0...9.999E15			X
203	2h_V2_N_Magnitude	V	0...9.999E15			X

**Table 25 - Setpoint Parameter Selection List (continued)**

Parameter Number	Parameter Tag Name	Units	Range	M5	M6	M8
204	3s_V3_N_Magnitude	V	0...9.999E15			X
205	10m_V3_N_Magnitude	V	0...9.999E15			X
206	2h_V3_N_Magnitude	V	0...9.999E15			X
207	3s_VN_G_Magnitude	V	0...9.999E15			X
208	10m_VN_G_Magnitude	V	0...9.999E15			X
209	2h_VN_G_Magnitude	V	0...9.999E15			X
210	3s_V1_V2_Magnitude	V	0...9.999E15			X
211	10m_V1_V2_Magnitude	V	0...9.999E15			X
212	2h_V1_V2_Magnitude	V	0...9.999E15			X
213	3s_V2_V3_Magnitude	V	0...9.999E15			X
214	10m_V2_V3_Magnitude	V	0...9.999E15			X
215	2h_V2_V3_Magnitude	V	0...9.999E15			X
216	3s_V3_V1_Magnitude	V	0...9.999E15			X
217	10m_V3_V1_Magnitude	V	0...9.999E15			X
218	2h_V3_V1_Magnitude	V	0...9.999E15			X
219	CH1_Short_Term_Flicker_Pst	Pst	0.0...100.00			X
220	CH1_Long_Term_Flicker_Plt	Plt	0.0...100.00			X
221	CH2_Short_Term_Flicker_Pst	Pst	0.0...100.00			X
222	CH2_Long_Term_Flicker_Plt	Plt	0.0...100.00			X
223	CH3_Short_Term_Flicker_Pst	Pst	0.0...100.00			X
224	CH3_Long_Term_Flicker_Plt	Plt	0.0...100.00			X
225	200mS_CH1_Mains_Signaling_Voltage	V	0...9.999E15			X
226	200mS_CH2_Mains_Signaling_Voltage	V	0...9.999E15			X
227	200mS_CH3_Mains_Signaling_Voltage	V	0...9.999E15			X
228	3s_Voltage_Unbalance	%	0.0...100.00			X
229	10m_Voltage_Unbalance	%	0.0...100.00			X
230	2h_Voltage_Unbalance	%	0.0...100.00			X

**Table 26 - Setpoint Output Action List**

<b>Parameter Number</b>	<b>Action Name</b>
0	None
1	Energize Relay 1
2	Energize Relay 2
3	Energize Relay 3
4	Energize KYZ
5	Clear kWh result
6	Clear kVARh result
7	Clear kVAh result
8	Clear Ah result
9	Clear all energy results
10	Clear setpoint #1 time accumulator and transition count
11	Clear setpoint #2 time accumulator and transition count
12	Clear setpoint #3 time accumulator and transition count
13	Clear setpoint #4 time accumulator and transition count
14	Clear setpoint #5 time accumulator and transition count
15	Clear setpoint #6 time accumulator and transition count
16	Clear setpoint #7 time accumulator and transition count
17	Clear setpoint #8 time accumulator and transition count
18	Clear setpoint #9 time accumulator and transition count
19	Clear setpoint #10 time accumulator and transition count
20	Clear setpoint #11 time accumulator and transition count
21	Clear setpoint #12 time accumulator and transition count
22	Clear setpoint #13 time accumulator and transition count
23	Clear setpoint #14 time accumulator and transition count
24	Clear setpoint #15 time accumulator and transition count
25	Clear setpoint #16 time accumulator and transition count
26	Clear setpoint #17 time accumulator and transition count
27	Clear setpoint #18 time accumulator and transition count
28	Clear setpoint #19 time accumulator and transition count
29	Clear setpoint #20 time accumulator and transition count
30	Start Trigger Data logging

## Setpoint and Logic Gate Status

Setpoint status is reported in the following tags, found in the [Status.Alarms](#) table on [page 348](#).

### *Setpoints\_1\_10\_Active*

Bit 0 = Setpoint1\_Active (0 = False, 1 = True)  
 Bit 1 = Setpoint2\_Active  
 ...  
 Bit 9 = Setpoint10\_Active

### *Setpoints\_11\_20\_Active (M6 and M8 models)*

Bit 0 = Setpoint11\_Active (0 = False, 1 = True)  
 Bit 1 = Setpoint12\_Active  
 ...  
 Bit 9 = Setpoint20\_Active

### *Logic\_Level\_1 Gates\_Active (M6 and M8 models)*

Bit 0 = Level1\_Gate1\_Active (0 = False, 1 = True)  
 Bit 1 = Level1\_Gate2\_Active  
 ...  
 Bit 9 = Level1\_Gate10\_Active

## Setpoint and Logic Gate Statistics

Setpoint statistics are reported in the [Statistics.Setpoint\\_Output](#) table on [page 362](#), which includes the following information tags for each setpoint.

*Setpoint n Seconds Accumulator*  
*Setpoint n Minutes Accumulator*  
*Setpoint n Hours Accumulator*  
*Setpoint n Transitions to Active x1*  
*Setpoint n Transitions to Active x1000*

Logic gate statistics are reported in the [Statistics.Setpoint\\_Logic Data Table](#) on [page 366](#), which reports the information that is listed [Setpoint and Logic Gate Status](#) for each logic gate.

## Commands

The following command parameters are found in the [Command.System\\_Registers](#) table on [page 368](#).

### *Command Word Two*

Set this command word value to execute the listed action. These values are the selections:

- 6 = Clear Setpoint Log
- 7 = Clear Setpoint (Time) Accumulators
- 18 = Clear Setpoint Logic Gate (Time) Accumulators

Clear Setpoint Accumulators operates by using the value contained in this tag. The default value is zero.

### *Clear Single Setpoint or Logic Gate Accumulator*

- 0 = Clear all time accumulators
- 1...20 = Clear selected time accumulator

## Related Functions

- Basic Metering
- Status Inputs
- KYZ and Relay Outputs
- Power Quality Monitoring

**Notes:**



## Other Functions

Table	Page
Security	209
Date and Time Functions	211
Network Time Synchronization	213
System Error Response	217
Miscellaneous Commands	218

This section describes the functions of the PowerMonitor™ 5000 unit. Most functions require you to configure set-up parameters to align the unit with your installation and your application requirements. The set-up parameters are listed by name and described in this section. You can view set-up parameters by using the PowerMonitor 5000 web page, and when logged in to an Admin account, make changes to the setup. Set-up parameters are also accessible by using communication.

See the [PowerMonitor 5000 Unit Data Tables](#) in [Appendix A](#) for additional information on setup parameters including the following:

- Range of valid values
- Default values
- Data type

Set-up parameters can be found in data tables with names beginning with 'Configuration', for instance Configuration.Metering\_Basic.

## Security

The PowerMonitor 5000 unit protects access against unauthorized set-up changes through an account-based security system.

---

**IMPORTANT** Security is disabled by default.

---

With security disabled, any application or web page user effectively has admin privileges. We do not recommend operating the unit with security that is disabled except during evaluation, testing, or initial setup.

See [Configure Initial Security on page 56](#) for the procedure to enable security if desired and create one or more Admin class accounts for configuration access from the Ethernet network.

Once security is enabled and an Admin class account is created during initial configuration, the remaining security configuration can be done through the network web page.

If you want to configure power monitors by using software, such as FactoryTalk® EnergyMetrix™ RT software, set up at least one Application class account.

This table summarizes the security classes, privileges, access, and limits that apply to the PowerMonitor 5000 unit.

**Table 27 - Account Classes and Privileges**

Account Class	Privileges	Interface	Maximum Number of Accounts
USB admin	Manage security accounts Read data Write configuration parameters Download log files	USB only web page	1
Admin	Manage security accounts Read data Write configuration parameters Download log files	USB and native Ethernet web page	10
User	Read data Download log files	USB and native Ethernet web page	20
Application	Read data Write configuration parameters Download log files	Native EtherNet/IP™ and optional DeviceNet® communication CIP™ assembly and parameters objects CSP/PCCC data tables	10
Privileges with security disabled (all)	Read data Write configuration parameters Download log files	Any	-
Security that is enabled but no user logged in	Read data	Any	-

The following rules further define security operation:

- The USB Admin account can be accessed only through the web page when connected via USB.
- Only one Admin can be active at a time, including the USB Admin class.
- A logged in account remains active until logged out or until 30 minutes has elapsed without writing a configuration parameter. FTP access to log files remains until the account is logged out.
- Only an Admin class account can add, remove, or edit accounts. An Admin class account cannot delete itself and the default USB Admin account cannot be deleted.
- An Application class account is used for access by using CIP or PCCC protocols via native Ethernet network or optional DeviceNet network communication. An Application class account logs in by writing its username to the [Security.Username](#) table on [page 334](#) and then its password to the [Security.Password](#) table, on [page 335](#), within 30 seconds. An application can obtain security status information by reading the [Status.TableWrites](#) data table on [page 346](#).

If an Exclusive Owner connection has been setup between a Logix controller and the PowerMonitor 5000 unit, configuration of the power monitor is permitted only through the controller. Attempts to change configuration by using the web interface or other means returns an ownership conflict error.

The PowerMonitor 5000 unit does not have a 'backdoor' password. If security accounts are inadvertently deleted or login credentials are lost, connect to the power monitor by using USB and log in to the USB Admin account to edit and/or create accounts to restore security access.

Security configuration using messaging on the optional DeviceNet network is not supported.

## Date and Time Functions

The PowerMonitor 5000 unit internal clock and calendar is used in demand metering and data logging functions. A number of user-selectable options are available for synchronizing and controlling the internal clock and calendar.

Daylight Saving Time is disabled by default. With DST enabled, the power monitor internal clock advances by one hour on the start date and hour that is specified, and is set back by one hour on the return date and hour specified. The defaults represent the common DST start and return date/times in the use in the United States since 2006. The DST function also adjusts the network-time sync offset when used.

### Applications

This function applies to all models.

### Date and Time Parameters

- Date: Year, Month, Day
- Time: Hour, Minute, Seconds, Milliseconds

### Setup

Basic date and time parameters are found in the [Configuration.DateTime](#) table on [page 288](#).

#### *Date\_Year*

These values are for this parameter: 1970...2100 (default = 2010)

#### *Date\_Month*

These values are for this parameter: 1 (default)...12

*Date\_Day*

These values are for this parameter: 1 (default)...31

*Time\_Hour*

These values are for this parameter: 0 (default)...23

*Time\_Minute*

These values are for this parameter: 0 (default)...59

*Time\_Seconds*

These values are for this parameter: 0 (default)...59

*Time\_Milliseconds*

These values are for this parameter: 0 (default)...999

### Daylight Saving Time Setup

Daylight saving time (DST) setup parameters are found in the [Configuration.System.General](#) table on [page 293](#).

The DST format is split into Month/Week/Day:

- Month Settings: 01= January 12= December
- Week Settings: 01=1<sup>st</sup> week 05= last week
- Day Settings: 01= Sunday, 07 = Saturday
- For example: 040107= April/1<sup>st</sup> Week/Saturday

**Table 28 - Daylight Saving Time Parameters**

Parameter	Description	Range	Default
Hour_of_Day_Start		0...23	2 a.m.
Daylight_Savings_Month/Week/Day_Start	Format is Month/Week/Day. (See <a href="#">Daylight Saving Time Setup</a> for clarification)	10101...120507	030201 March, 2nd week, Sunday
Return_from_Daylight_Savings_Month/Week/Day	Format same as start date	10101...120507	110101 November, 1st week, Sunday
Hour_of_Day_End		0...23	2 a.m.

## Network Time Synchronization

The PowerMonitor 5000 unit can be setup to synchronize its system clock by using Network Time Synchronization. Network time synchronization clock sources provide better precision and improved coordination between multiple meters. Two different methods of time synchronization are supported, simple network time protocol (SNTP) or precision time protocol (PTP).

### Applications

This feature applies to all models.

### Operation

With SNTP selected as the time sync source, the power monitor updates its time from a simple network time protocol server or an anycast group of SNTP servers, depending on set-up parameter values. This option requires an available SNTP time server.

When PTP is selected, the power monitor updates its time from a precision time protocol master clock. A PTP master clock source must be available. PTP is the more accurate of the two network time synchronization options.

---

**IMPORTANT** Quality of Service (QoS) is a general term that is applied to mechanisms used to treat traffic streams with different relative priorities or other delivery characteristics. Standard QoS mechanisms include IEEE 802.1D/Q (Ethernet frame priority) and Differentiated Services (DiffServ) in the TCP/IP protocol suite. The QoS Object provides a means to configure certain QoS-related behaviors in EtherNet/IP devices. QoS by default is enabled. We suggest that you do not change the default values.

---

## Setup

The Network Time Synchronization set up parameters for SNTP and PTP are found in the [Configuration.Communications\\_Native](#) table on [page 296](#).

**Table 29 - Network Time Synchronization Set up Parameters**

Parameter	Description	Range	Default
Time_Sync_Source	Selection for Time Sync 0 = Disable 1 = SNTP 2 = PTP_Slave 3 = PTP_Master	0...2	2
SNTP_Mode_Select	0 = Unicast 1 = Anycast Mode The SNTP address is a broadcast address of an anycast group	0...1	0
SNTP_Update_Interval	Number of seconds before next update	1...32766	300
SNTP_Time_Zone	The time zone in which the power monitor is located	0...32	6 (Central Time)
SNTP Time Server IP	Unicast server or anycast group IP address in format aaa.bbb.ccc.ddd	0.0.0.0...255.255.255.255	0.0.0.0
QOS_DSCP_Enable	0 = Disable 1 = Enable	0...1	1
QOS_DSCP_PTP_Event	PTP (IEEE 1588) event messages	0...63	59
QOS_DSCP_PTP_General	PTP (IEEE 1588) general messages	0...63	47
QOS_DSCP_Urgent	CIP transport class 0/1 messages with Urgent priority	0...63	55
QOS_DSCP_Scheduled	CIP transport class 0/1 messages with Scheduled priority	0...63	47
QOS_DSCP_High	CIP transport class 0/1 messages with high priority	0...63	43
QOS_DSCP_Low	CIP transport class 0/1 messages with low priority	0...63	31
QOS_DSCP_Explicit	CIP UCMM CIP class 3	0...63	27

## Time Zones

**Table 30 - Time Zone Information**

Value	Offset from GMT	Time Zone Name	Areas in Time Zone
0	GMT-12:00	Dateline Standard Time	Eniwetok, Kwajalein
1	GMT-11:00	Samoa Standard Time	Midway Island, Samoa
2	GMT-10:00	Hawaiian Standard Time	Hawaii
3	GMT-09:00	Alaskan Standard Time	Alaska
4	GMT-08:00	Pacific Standard Time	Pacific Time (US and Canada; Tijuana)
5	GMT-07:00	Mountain Standard Time	Mountain Time (US and Canada)
		US Mountain Standard Time	Arizona
6	GMT-06:00	Canada Central Standard Time	Saskatchewan
		Central America Standard Time	Central America
		Central Standard Time	Central Time (US and Canada)
		Mexico Standard Time	Mexico City

Table 30 - Time Zone Information (continued)

Value	Offset from GMT	Time Zone Name	Areas in Time Zone
7	GMT-05:00	Eastern Standard Time	Eastern Time (US and Canada)
		SA Pacific Standard Time	Bogota, Lima, Quito
		US Eastern Standard Time	Indiana (East)
8	GMT-04:00	Atlantic Standard Time	Atlantic Time (Canada)
		Pacific SA Standard Time	Santiago
		SA Western Standard Time	Caracas, La Paz
9	GMT-03:30	Newfoundland Standard Time	Newfoundland
10	GMT-03:00	E. South America Standard Time	Brasilia
		Greenland Standard Time	Greenland
		SA Eastern Standard Time	Buenos Aires, Georgetown
11	GMT-02:00	Mid-Atlantic Standard Time	Mid-Atlantic
12	GMT-01:00	Azores Standard Time	Azores
		Cape Verde Standard Time	Cape Verde Is.
13	GMT	Standard Time	Greenwich Mean Time: Dublin, Edinburgh, Lisbon, London
		Greenwich Standard Time	Casablanca, Monrovia
14	GMT+01:00	Central Europe Standard Time	Belgrade, Bratislava, Budapest, Ljubljana, Prague
		Central European Standard Time	Sarajevo, Skopje, Sofija, Vilnius, Warsaw, Zagreb
		Romance Standard Time	Brussels, Copenhagen, Madrid, Paris
		W. Central Africa Standard Time	West Central Africa
		W. Europe Standard Time	Amsterdam, Berlin, Bern, Rome, Stockholm, Vienna
15	GMT+02:00	E. Europe Standard Time	Bucharest
		Egypt Standard Time	Cairo
		FLE Standard Time	Helsinki, Riga, Tallinn
		GTB Standard Time	Athens, Istanbul, Minsk
		Israel Standard Time	Jerusalem
16	GMT+03:00	South Africa Standard Time	Harare, Pretoria
		Arab Standard Time	Kuwait, Riyadh
		Arabic Standard Time	Baghdad
		E. Africa Standard Time	Nairobi
17	GMT+03:30	Russian Standard Time	Moscow, St. Petersburg, Volgograd
		Iran Standard Time	Tehran
18	GMT+04:00	Arabian Standard Time	Abu Dhabi, Muscat
		Caucasus Standard Time	Baku, Tbilisi, Yerevan
19	GMT+04:30	Afghanistan Standard Time	Kabul
20	GMT+05:00	Ekaterinburg Standard Time	Ekaterinburg
		West Asia Standard Time	Islamabad, Karachi, Tashkent
21	GMT+05:30	India Standard Time	Calcutta, Chennai, Mumbai, New Delhi

**Table 30 - Time Zone Information (continued)**

Value	Offset from GMT	Time Zone Name	Areas in Time Zone
22	GMT+05:45	Nepal Standard Time	Kathmandu
23	GMT+06:00	Central Asia Standard Time	Astana, Dhaka
		N. Central Asia Standard Time	Almaty, Novosibirsk
		Sri Lanka Standard Time	Sri Jayawardenepura
24	GMT+06:30	Myanmar Standard Time	Rangoon
25	GMT+07:00	North Asia Standard Time	Krasnoyarsk
		SE Asia Standard Time	Bangkok, Hanoi, Jakarta
26	GMT+08:00	China Standard Time	Beijing, Chongqing, Hong Kong, Urumqi
		North Asia East Standard Time	Irkutsk, Ulaan Bataar
		Singapore Standard Time	Kuala Lumpur, Singapore
		Taipei Standard Time	Taipei
		W. Australia Standard Time	Perth
27	GMT+09:00	Korea Standard Time	Seoul
		Tokyo Standard Time	Osaka, Sapporo, Tokyo
		Yakutsk Standard Time	Yakutsk
28	GMT+09:30	AUS Central Standard Time	Darwin
		Cen. Australia Standard Time	Adelaide
29	GMT+10:00	AUS Eastern Standard Time	Canberra, Melbourne, Sydney
		E. Australia Standard Time	Brisbane
		Tasmania Standard Time	Hobart
		Vladivostok Standard Time	Vladivostok
		West Pacific Standard Time	Guam, Port Moresby
30	GMT+11:00	Central Pacific Standard Time	Magadan, Solomon Is., New Caledonia
31	GMT+12:00	Fiji Standard Time	Fiji, Kamchatka, Marshall Is.
		New Zealand Standard Time	Auckland, Wellington
32	GMT+13:00	Tonga Standard Time	Nuku'alofa

**Related Functions**

- Demand metering
- Data logging



## System Error Response

The PowerMonitor 5000 unit provides options for the handling of critical internal unit run-time errors.

### Operation

The PowerMonitor 5000 unit can be reset or operate in Safe mode.

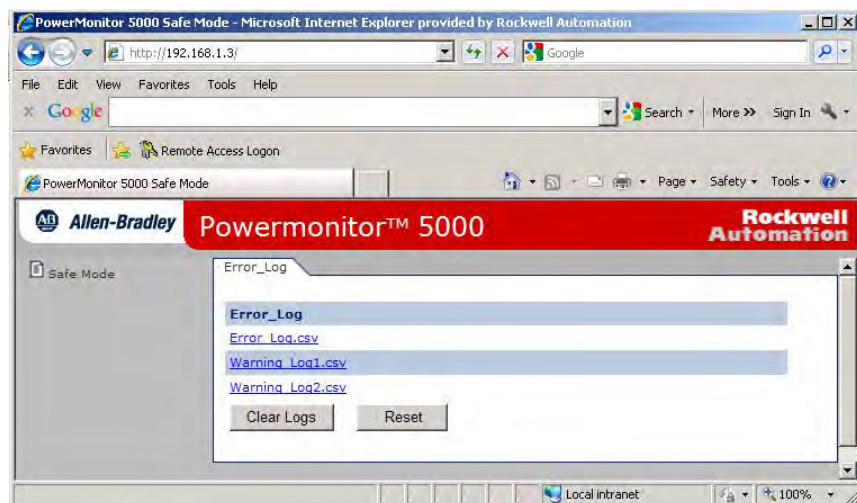
#### *Reset (default)*

Reset performs a warm restart of the power monitor firmware. With Reset selected for unit error action, if a critical error occurs, the power monitor logs the error record to its internal Error Log and then restarts automatically. With Reset selected for the error log full option, the oldest error log record is discarded, and then the power monitor logs the error record to its internal Error Log and then restarts automatically. This option is intended for applications where continuity of metering operation is paramount, and where critical control functionality cannot be affected by an operating error in the power monitor.

#### *Safe Mode*

In Safe mode, each power monitor output is forced to its de-energized state, native Ethernet communication stops, and the power monitor enters a state of minimal function. In safe mode, you can access the Safe mode web page of the unit through the USB device port. The Safe mode web page displays the following:

- Links for downloading error and warning logs
- Control buttons to clear diagnostic logs and reset the unit



From Safe mode, if the error log is full, you need to clear the error log before attempting to reset the unit.

Contact Rockwell Automation Technical Support for assistance with the PowerMonitor 5000 unit diagnostic information.

## Setup

Setup parameters of these functions are in the [Configuration.System.General](#) table on [page 293](#).

### *Unit\_Error\_Action*

These are the selections:

- 0 = Safe mode
- 1 = Reset (default)

### *Software\_Error\_Log\_Full\_Action*

- 0 = Safe mode
- 1 = Reset (default)

## Miscellaneous Commands

The following commands relate to the operation of the power monitor at a system level. These commands are found in the [Command.System\\_Registers](#) table on [page 368](#).

### *Command\_Word\_One*

Set this command word value to execute the listed action. These are the selections:

- 22 = Restore factory defaults
- 23 = Reset power monitor system

The semantics for these parameters:

Restore factory defaults = Clears all user-configured values from the setup menus to their factory default settings.

Reset system = Warm reboot; performs a power-on self-test of the PowerMonitor 5000 unit.

## Related Functions

Configuration lock.

---

## Communication

### Native Ethernet Communication

All PowerMonitor™ 5000 units are equipped with a native EtherNet/IP™ 100 BaseT communication port. This section describes EtherNet/IP communication and the available protocols to use for your application.

The Ethernet communication port allows communication with your power monitor by using a local area network (LAN). You can use the Ethernet port to view the internal web page of the unit.

The PowerMonitor 5000 unit communicates through Ethernet or EtherNet/IP drivers in RSLinx® Classic software, and through explicit messages from Rockwell Automation® controllers that communicate via an EtherNet/IP network.

### Setup

Setup parameters for the Ethernet native communication port are found in the Configuration.Communications\_Native table. Addresses in this list are expressed as A.B.C.D where A is the first octet of the IP address or subnet mask, for example, 192.168.200.101.

#### *IP\_Address\_Obtain*

Selects the IP Address at startup. These values are for this parameter:

- 0 = Static IP
- 1 = DHCP (default)

The semantics for these parameters:

This table displays the setup parameters for the native Ethernet port whether Static or DHCP is selected. If Static is selected, the value of parameters in this table defines the port settings.

*IP\_Address\_A*  
*IP\_Address\_B*  
*IP\_Address\_C*  
*IP\_Address\_D*

Ethernet port Internet Protocol (IP) address.

*Subnet\_Mask\_A*  
*Subnet\_Mask\_B*  
*Subnet\_Mask\_C*  
*Subnet\_Mask\_D*

Ethernet port subnet mask.

*Gateway\_Address\_A*  
*Gateway\_Address\_B*  
*Gateway\_Address\_C*  
*Gateway\_Address\_D*

Ethernet port default gateway address.

*DNS\_Enable*

Selects DNS Option. These values are for this parameter:

0 = Disable  
1 = Enable

*DNS\_Server\_Address\_A*  
*DNS\_Server\_Address\_B*  
*DNS\_Server\_Address\_C*  
*DNS\_Server\_Address\_D*  
*DNS\_Server2\_Address\_A*  
*DNS\_Server2\_Address\_B*  
*DNS\_Server2\_Address\_C*  
*DNS\_Server2\_Address\_D*

Domain Name Server (DNS) addresses

The remaining parameters in the [Configuration.Communications\\_Native](#) table, on [page 296](#), are described in [Date and Time Functions on page 211](#) and [Demand Metering on page 83](#).

## Optional DeviceNet Communication

PowerMonitor 5000 units can be optionally equipped with a DeviceNet® communication port. A DeviceNet communication port can be factory installed or field installed by you. The DeviceNet network is an open-standard, multi-vendor, industrial device data network that uses various physical media. The DeviceNet network also provides 24V DC power to devices connected to the network. The DeviceNet network port and the native Ethernet network port can be used simultaneously.

### Setup

Setup parameters for the optional DeviceNet port are found in the [Configuration.OptionalComm.DNT](#) table on [page 329](#).

#### *Mac ID*

Selects the DeviceNet node address. The range is 0...63 (default).

#### *Communication Rate*

Selects the DeviceNet network communication (data) rate, and must be selected to match the remaining devices on the network. The selections are the following:

- 0 = 125 Kbps
- 1 = 250 Kbps
- 2 = 500 Kbps
- 3 = Autobaud

## Optional ControlNet Communication

PowerMonitor 5000 units can be optionally equipped with a ControlNet® communication port. A ControlNet communication port can be factory installed or field installed by you. The ControlNet network is an open-standard, multi-vendor, industrial device data network that supports scheduled, I/O communication and unscheduled messaging. The ControlNet port and the native Ethernet port can be used simultaneously.

### Setup

The [Configuration.OptionalComm.CNT](#) table, on [page 330](#), contains the Address tag, the only set up parameter. Valid ControlNet addresses range from 1...99. The default value is 255.

## Electronic Data Sheet (EDS)

The EDS file is used to convey device configuration data that is provided by the manufacturer. You can obtain EDS files for the PowerMonitor 5000 unit by downloading the file from the following website.

<http://www.rockwellautomation.com/rockwellautomation/support/networks/eds.page>

**Product Compatibility & Download Center**

Get help determining how different products interact, checking features and capabilities between different series of products as well as associated firmware versions. Locate product related downloads including firmware, release notes, associated software, drivers, tools and utilities.

[Learn More](#)

**QUICK LINKS**

- [DeviceLogix EDS Files](#)
- [PROFIBUS GSD Files](#)

---

**Find EDS Files**

EDS files are simple text files used by network configuration tools to help you identify products and easily commission them on a network\*. To locate a specific EDS file, select the Network, Device Type, and enter any additional information to narrow your search. You MUST select a network and device type.

Network:

Device Type:

Bulletin/Catalog No.:

Major Revision:

Minor Revision:

Keyword:

\*The EDS archives maintain a history of revisions as well as the most up-to-date versions of Rockwell Automation DeviceNet and ControlNet EDS files.

**EDS Search Tips**

- Search major categories rather than specific keywords for best results.
- Check spelling and numbers entered into search fields.
- Complex searches may take more time complete.

**EDS Support**

- Contact Technical Support at 440.648.3434 if you have difficulty locating an EDS file.

You can install EDS files on your computer by using the EDS Hardware Installation Tool that comes with RSLinx Classic software, RSNetWorx™ software, or other tools.

You can also upload the EDS file directly from the PowerMonitor 5000 unit in RSLinx software. Right-click on the unit and select Upload EDS file from device. Follow the steps in the EDS Wizard to install the EDS file.

## PowerMonitor 5000 Unit Memory Organization

Memory is organized like the memory of a ControlLogix® controller, by using symbolic tag addressing. Support for PLC-5® or SLC™ 500 controller type addressing is also provided. Data tables organize individual data items of similar function. For example, real-time metering parameters voltages, current, frequency, and power are grouped in one data table, and billing-related parameters like demand and energy are in a second metering results table.

[Appendix A](#) provides a comprehensive listing of the PowerMonitor 5000 unit data tables.

### Data Table Addressing

Data tables can be addressed in several ways.

#### *Symbolic Addressing*

Status and metering results data can be addressed by their tag names, similar to the manner in which ControlLogix controller tags are addressed. Symbolic tag addresses are displayed in the power monitor web page, and appear in an RSLinx Classic software OPC topic configured for a PowerMonitor 5000 unit.

The following tables can be accessed using symbolic addressing:

- MeteringResults.Energy\_Demand
- MeteringResults.RealTime\_VIF\_Power
- PowerQuality.RealTime\_PowerQuality
- Statistics.Setpoint\_Output
- Statistics.Setpoint\_Logic
- Status.General
- Status.Communications
- Status.RunTime
- Status.Discrete\_IO
- Status.Wiring\_Diagnostics
- Status.TableWrites
- Status.Alarms
- Status.IEEE1588

#### *CIP Addressing*

Addresses are of the form Object:Instance:Attribute. CIP™ addressing allows reading and writing of an entire data table (assembly instance) rather than individual elements. In CIP addressing, the energy metering results table is Object Class 4 (Assembly object), Instance 844 ([MeteringResults.RealTime\\_VIF\\_Power](#) table on [page 373](#)), and Attribute 3 (data).

### *CSP Addressing*

This type of addressing is also known as ‘PLC-5 style’ or ‘PCCC’ addressing. Addresses are written in the form ‘Axx:yy’ where A is a letter describing the function of the data table, xx is the table number, and yy is the element within, or offset into, the table. For example, ‘F53:0’ is the CSP address of the first element in the [MeteringResults.RealTime\\_VIF\\_Power](#) table on [page 373](#). PCCC messaging can be used to read or write a single data element or a range of data elements within a data table.

### **Data Types**

The PowerMonitor 5000 unit stores data by using several data types:

- Int16, in which the 16-bit word can be represented by an integer value or a bitmap
- Int32, a 32-bit integer value
- SINT, an 8-bit (Byte) value
- REAL, using the 32-bit IEEE 754 floating-point format
- String, containing alphanumeric characters used for security and unit descriptive information
- DWORD, a 32-bit structure typically containing bitmap status information
- SINT, INT, and DINT data types are also used as pads for data alignment with the Logix architecture

## **Communication Command Summary**

This section lists the commands that are supported by each communication network type.

### **EtherNet/IP Network**

- CIP Generic Assembly Object (Class 04), Get & Set Attribute Single for Attribute 3 (data)
- CIP Generic Assembly Object (Class 04), Get Attribute Single for Attribute 4 (size)
- PCCC PLC5 Word Range Write Function (CMD = 0x0F, FUNC = 0x00)
- PCCC PLC5 Word Range Read Function (CMD = 0x0F, FUNC = 0x01)
- PCCC PLC5 Typed Write Function (CMD = 0x0F, FUNC = 0x67)
- PCCC PLC5 Typed Read Function (CMD = 0x0F, FUNC = 0x68)
- PCCC Protected Logical Read Function w/2 Address Fields (CMD = 0x0F, FUNC = 0xA1)
- PCCC Protected Logical Write Function w/2 Address Fields (CMD = 0x0F, FUNC = 0xA9)



- PCCC Protected Logical Read Function w/3 Address Fields (CMD = 0x0F, FUNC = 0xA2)
- PCCC Protected Logical Write Function w/3 Address Fields (CMD = 0x0F, FUNC = 0xAA)
- PCCC Status Diagnostics (CMD = 0x06, FUNC = 0x03)

### **DeviceNet and ControlNet Network**

- CIP Generic Assembly Object (Class 04), Get & Set Attribute Single for Attribute 3 (data)
- PCCC PLC5 Word Range Write Function (CMD = 0x0F, FUNC = 0x00)
- PCCC PLC5 Word Range Read Function (CMD = 0x0F, FUNC = 0x01)
- PCCC PLC5 Typed Write Function (CMD = 0x0F, FUNC = 0x67)
- PCCC PLC5 Typed Read Function (CMD = 0x0F, FUNC = 0x68)
- PCCC Protected Logical Read Function w/2 Address Fields (CMD = 0x0F, FUNC = 0xA1)
- PCCC Protected Logical Write Function w/2 Address Fields (CMD = 0x0F, FUNC = 0xA9)
- PCCC Protected Logical Read Function w/3 Address Fields (CMD = 0x0F, FUNC = 0xA2)
- PCCC Protected Logical Write Function w/3 Address Fields (CMD = 0x0F, FUNC = 0xAA)
- PCCC Status Diagnostics (CMD = 0x06, FUNC = 0x03)

## EtherNet/IP Object Model

This section provides the object model for a PowerMonitor 5000 device type on an EtherNet/IP network. [Table 31](#) indicates the following:

- The object classes present in this device
- Whether the class is required
- The number of instances present in each class

### Object Class List

The PowerMonitor 5000 unit supports the following CIP classes.

**Table 31 - CIP Object Class List**

Object Class	Need in Implementation	Number of Instances
Identity (1, 1hex)	Required	1
Message Router (2, 2hex)	Required	1
TCP/IP Interface Object (245, F5hex)	Required	1
Ethernet Link Object (246, F6hex)	Required	1 Required (2 Optional)
Connection Manager Object (6, 6hex)	Required	1
Assembly Object (4, 4 hex)	Required	Minimum of 3
Parameter Object (15, Fhex)	Required	Product Specific
Parameter Group Object (16, 10hex)	Optional	Product Specific
Non-Volatile Storage Object (161, A1hex)	Required	Product Specific
File Object (55, 37hex)	Required	Minimum of 1
Time-Sync Object (67, 43hex)	Optional	1
QoS Object (72, 48hex)	Optional	1
PCCC Object (103, 67hex)	Optional	1
Symbol Object (107, 6Bhex)	Optional	Product Specific
User Defined Template Object (108, 6Chex)	Optional	Product Specific
<a href="#">Base Energy Object (78, 4Ehex)</a> <sup>(1)</sup>	Required	1
<a href="#">Electrical Energy Object (79, 4Fhex)</a> <sup>(2)</sup>	Required	1

(1) See [CIP Base Energy Object on page 261](#).

(2) See [CIP Electrical Energy Object on page 262](#).

## DeviceNet and ControlNet Object Model

This section provides the object model for a PowerMonitor 5000 device type on either a DeviceNet or ControlNet network. [Table 32](#) indicates the following:

- The object classes present in this device
- Whether the class is required
- The number of instances present in each class

### Object Class List

The PowerMonitor 5000 unit supports the following classes.

**Table 32 - DeviceNet and ControlNet Object Model**

Object Class	Need in Implementation	Number of Instances
Identity (1, 1hex)	Required	1
Message Router (2, 2hex)	Required	1
DeviceNet Object (3, 3hex)	Required	1
Assembly Object (4, 4 hex)	Required	Minimum of 3
Connection Object (5, 5hex)	Required	Minimum of 1
Parameter Object (15, Fhex)	Required	Product Specific
Parameter Group Object (16, 10hex)	Optional	Product Specific
Acknowledge HandleObject (43, 28hex)	Required	1
Non-Volatile Storage Object (161, A1hex)	Required	Product Specific
File Object (55, 37hex)	Required	Minimum of 1
PCCC Object (103, 67hex)	Optional	1
<a href="#">Base Energy Object (78, 4Ehex)</a> <sup>(1)</sup>	Required	1
<a href="#">Electrical Energy Object (79, 4Fhex)</a> <sup>(2)</sup>	Required	1
Email Object (815, 32Fhex)	Optional	1

(1) See [CIP Base Energy Object on page 261](#).

(2) See [CIP Electrical Energy Object on page 262](#).

## Explicit Messaging

This section discusses data retrieval and parameter configuration by using explicit messaging from Rockwell Automation controllers. Explicit messaging provides the mechanism for users to program a controller to read and write specific data tables in a power monitor. With explicit messages, you can read real-time metering values, configure metering and communication parameters, and also read certain logs.

The PowerMonitor 5000 unit supports PLC-5 Typed, SLC Typed, and CIP Generic message requests.

## Security Considerations

A controller or application does not need to log in to read real-time metering, configuration, and status data from a PowerMonitor 5000 unit, whether security is disabled or enabled.

If security is enabled, a controller must log in under an Application account class to perform the following:

- Write configuration or commands
- Read log data

To log in, write the username to the [Security.Username](#) table on [page 334](#). Within 30 seconds, write the password to the [Security.Password](#) table on [page 335](#). In the source data, buffer the username and password with null characters so the string length is 32 bytes.

A read of the [Status.TableWrites](#) table, on [page 346](#), verifies success of the login and indicates which account class is active. A login remains active until 30 minutes have elapsed since the last write message.

## Examples: Explicit Message Setup

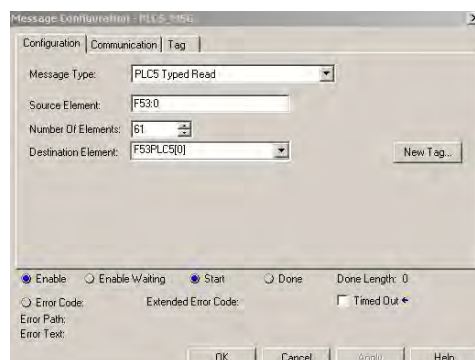
See the following examples for details about configuring an explicit message.

**TIP** The Studio 5000 Automation Engineering & Design Environment™ combines engineering and design elements into a common environment. The first element in the Studio 5000 environment is the Logix Designer application. The Logix Designer application is the rebranding of RSLogix® 5000 software.

## RSLogix 5000 Software – PLC-5 or SLC Typed Read Message Setup

The following is an example of a message instruction to read single or multiple elements from a PowerMonitor 5000 unit by using PLC-5 or SLC Typed messages. This setup applies to ControlLogix and CompactLogix™ programmable logic controllers.

After setting up a message instruction, open the message configuration dialog box. The Configuration tab is selected initially.



### Message Type

These types are the choices:

PLC-5 Typed Read  
SLC Typed Read

### Source Element

Look up the PCCC address of the specific data table address to read. If you are performing a multiple element read, this address specifies the first element in the array.

### Number of Elements

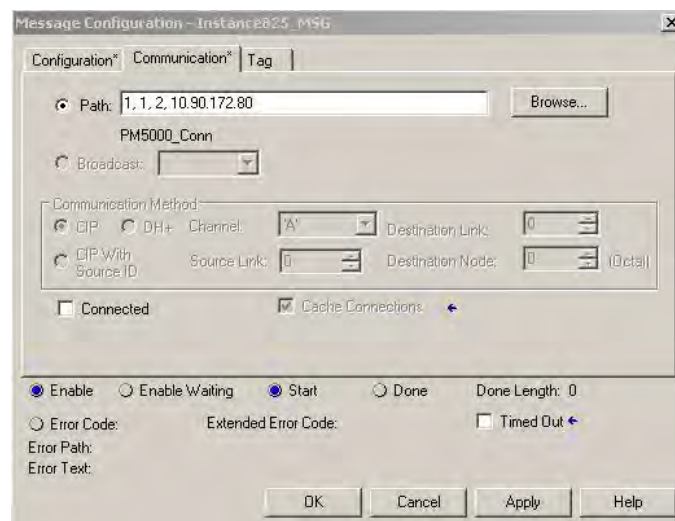
These values are the number of elements being read:

1 = Single element read  
> 1 = Multiple element read, number of elements to read including the first element

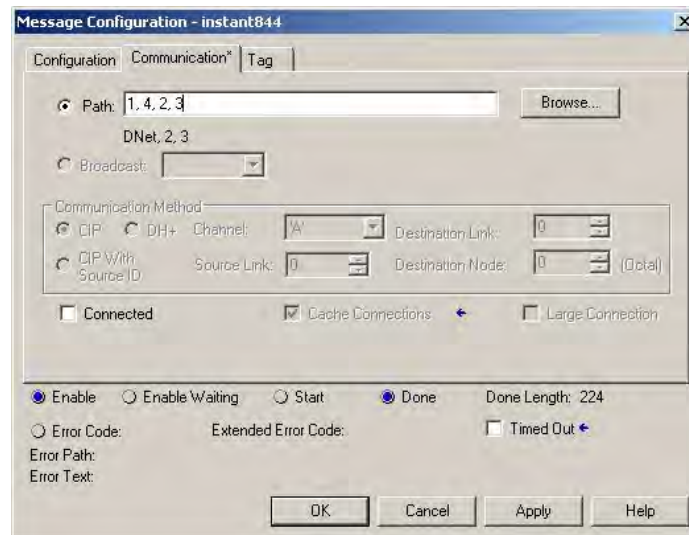
### Destination Element

The controller tag in which to store the data being read.

Click the Communication tab.



For an explicit message using a DeviceNet or ControlNet network, only the communication path changes, as shown.



### *Path*

This field specifies the communication path from the controller to the power monitor. Set up the path as <Backplane (always 1), Slot of Communication Module, Port (2 for Ethernet and DeviceNet networks), power monitor IP Address or DeviceNet address>.

### *Communication Method*

For PLC-5 and SLC Typed Reads, the default is always CIP.

## **RSLogix 5000 Software – PLC-5 or SLC Typed Write Message Setup**

A write message is similar to the PLC-5 and SLC Type read message described on [page 228](#). The changes are in the Configuration tab, as follows.

### *Message Type*

These types are the choices:

PLC-5 Typed Write  
SLC Typed Write

### *Source Element*

This field specifies the controller tag in which to store the data to write to the power monitor.

### Number of Elements

These values are the number of elements being read:

1 = Single element write

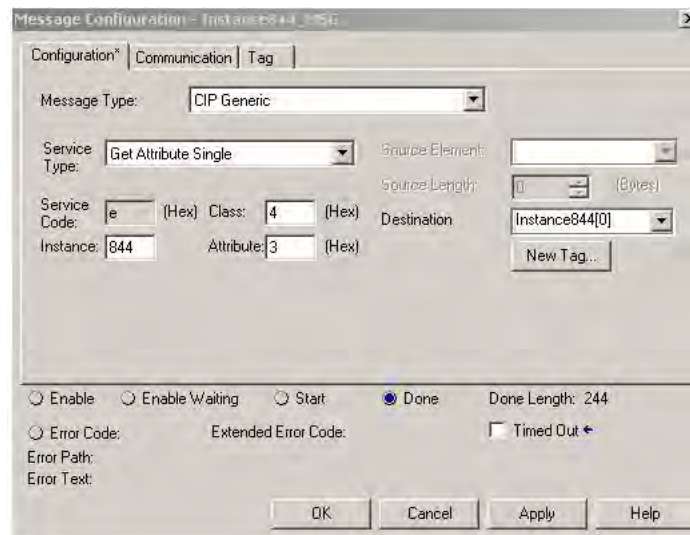
>1 = Multiple element write, number of elements to read including the first element

### Destination Element

Look up the PCCC address (in [Appendix A](#)) of the specific data table address to read. If performing a multiple element read, the data table addresses the first element in the array.

## RSLogix 5000 Software – CIP Generic Messaging Setup

The following example demonstrates a message instruction to read or write a data table in the PowerMonitor 5000 unit by using the CIP Generic message type. This setup applies to ControlLogix and CompactLogix programmable logic controllers.



### Message Type

CIP Generic.

### Service Type

These types are the choices:

Get Attribute Single = Read message

Set Attribute Single = Write message

*Class*

4 = Assembly object

*Instance*

Look up the CIP Instance (in [Appendix A](#)) of the specific data table to read or write. This example uses instance 844, the [MeteringResults.RealTime\\_VIF\\_Power](#) table on [page 373](#).

*Attribute*

3 = Data

*Source Element*

Used with Write messages, this element specifies the controller tag to write to the power monitor.

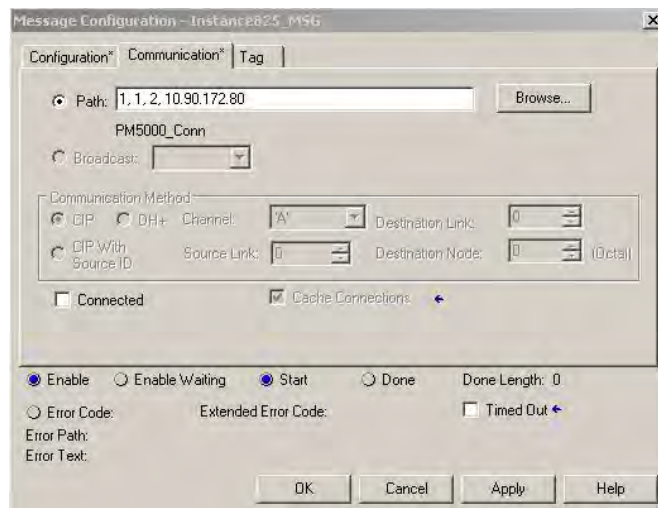
*Source Length*

Used with Write messages, the length is specified in bytes of the data that is written to the power monitor.

*Destination*

Used with Read messages, destination specifies the controller tag in which to store the data read from the power monitor.

Click the Communication tab.





### *Path*

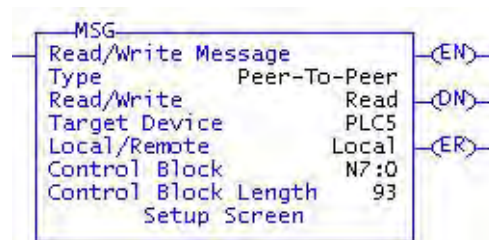
This field specifies the communication path from the controller to the power monitor. Set up the path as <Backplane (always 1), Slot of Ethernet Module, Port (always 2 for Ethernet), power monitor IP Address>.

### *Communication Method*

For CIP Generic messaging, the default is CIP.

## **RSLogix 500 Software - Message Setup by Using PLC-5 or SLC Typed Read/Write**

The following is an example of a message instruction to read or write single or multiple elements in a PowerMonitor 5000 unit by using peer-to-peer PLC-5 or SLC 500 Typed messages in RSLogix 500® software. This setup applies to SLC and MicroLogix™ programmable logic controllers.



### *Read/Write*

Select Read or Write.

### *Target Device*

Select PLC5 or 500CPU as appropriate.

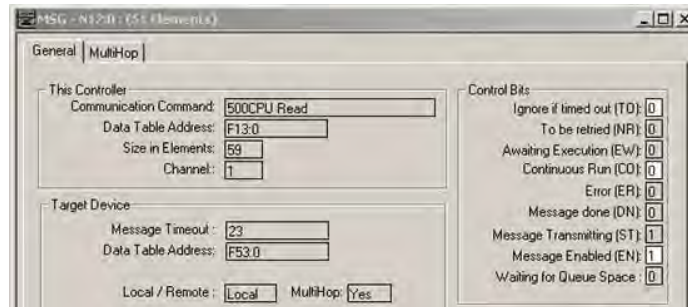
### *Local/Remote*

Select Local.

### Control Block

Select an available Integer word. This example uses N7:0.

Click Setup Screen.



### This Controller Data Table Address

For a Read message, the controller tag in which to store the power monitor data.

For a Write message, the controller tag that stores the value that is written to the power monitor.

### Size in Elements

The number of elements being read or written. These values are for this parameter:

1 = Single element read or write

2...59 = Multiple element read or write, number of elements to read including the first element

---

**IMPORTANT** The maximum size in elements is 59 for a 500CPU target device Read type message.

---

### Channel

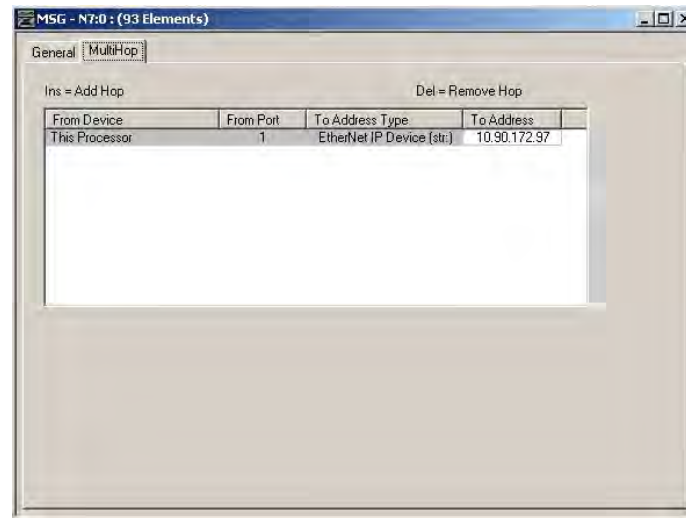
Select 1.

### Target Device Data Table Address

Look up the PCCC address (in [Appendix A](#)) of the specific data table address to read or write. If you are performing a multiple element read or write, this element is the first element in the array.

## MultiHop

Click Yes, then click the MultiHop tab.



Enter the IP Address of the PowerMonitor 5000 unit in the To Address box.

## SCADA Applications

SCADA is short for ‘Supervisory Control and Data Acquisition’, and describes applications in which process data from controllers and other devices is displayed on human-machine interface (HMI) workstations to help system operators monitor operations and make control decisions. HMI applications such as FactoryTalk® View software use communication applications such as RSLinx Classic and RSLinx® Enterprise software to gather data from the process through controller, power monitors, and the like.

This section covers RSLinx Classic software driver setup, and OPC setup by using the RSLinx Classic OPC Server.

### RSLinx Classic Driver Configuration

Install the PowerMonitor 5000 unit EDS (Electronic Data Sheet) file on the computer running RSLinx Classic software. You can use the RSLinx EDS Hardware Installation tool to register EDS file, or they can be uploaded in RSLinx software after configuring drivers by right-clicking on the power monitor icon in RSWho and registering the device.

#### *EtherNet/IP by Using Ethernet Devices Driver*

- Create an Ethernet devices driver in RSLinx software.
- Add the IP address of the PowerMonitor 5000 unit to the driver station mapping.
- Use RSWho to verify that RSLinx software is communicating to the PowerMonitor 5000 unit.

*EtherNet/IP using Ethernet/IP Driver*

- Create an Ethernet/IP network driver in RSLinx software.
- Make selections to browse the local or remote subnet as appropriate.
- Use RSWho to verify that RSLinx software is communicating to the PowerMonitor 5000 unit.

---

**IMPORTANT** The PowerMonitor 5000 unit connects to either the RSLinx Classic Ethernet Devices driver or the Ethernet/IP driver on one computer but not both simultaneously.

---

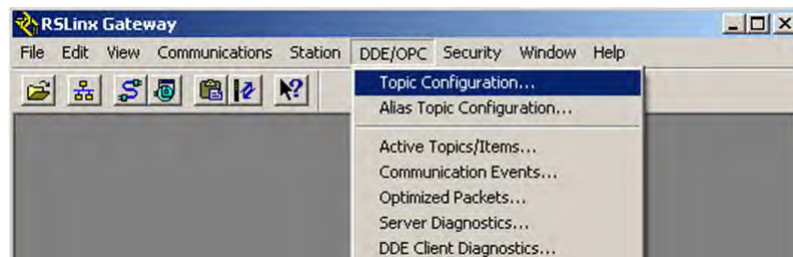
**RSLinx Classic OPC Server Setup**

RSLinx Classic software functions as an OPC Server to serve data from a PowerMonitor 5000 unit to an OPC 2.0 compliant application. To configure the OPC driver, first set up an Ethernet Devices (see [page 235](#)) or EtherNet/IP driver (see [page 236](#)) to communicate to the power monitor. You can then create an OPC topic to serve data to your SCADA application.

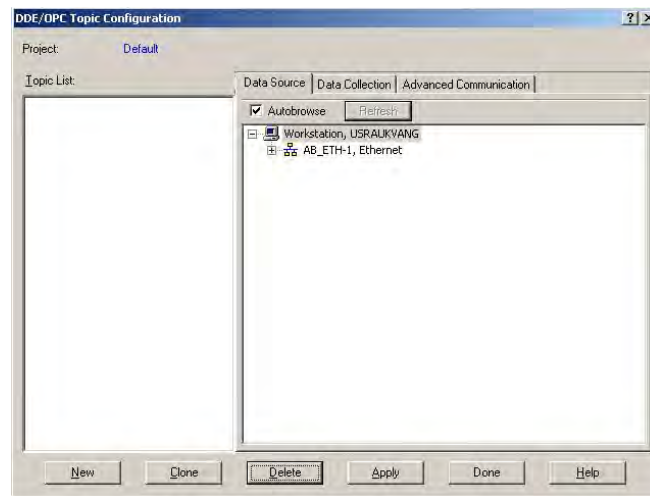
*Setup OPC Topic*

Follow these steps to set up an OPC topic.

1. Open RSLinx software.
2. From the DDE/OPC menu, choose Topic Configuration.

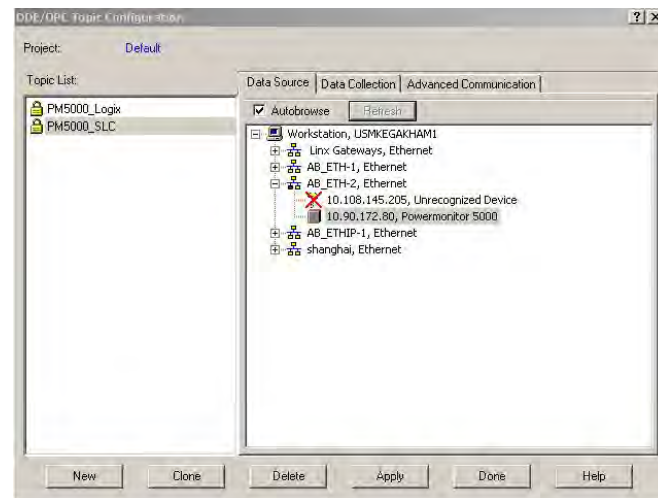


- When the topic configuration window appears, click New.



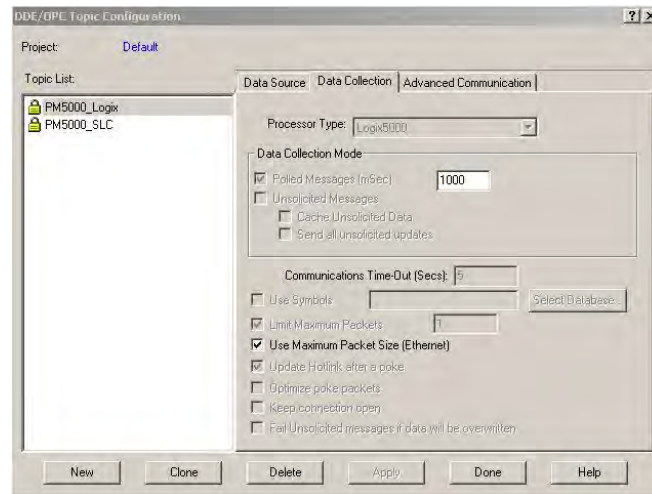
A new, unnamed topic in the left pane is created.

- Give the topic a name pertinent to your application.
- In the right pane, with the Data Source tab selected, browse to the PowerMonitor 5000 unit by using the previously configured driver.



- With the topic highlighted in the left pane, and the PowerMonitor 5000 unit that is highlighted in the right pane, click Apply.
- Click the Data Collection tab.

- From the Processor pull-down menu, choose Logix5000™. This selection provides symbolic tag addressing.



- Click Done.

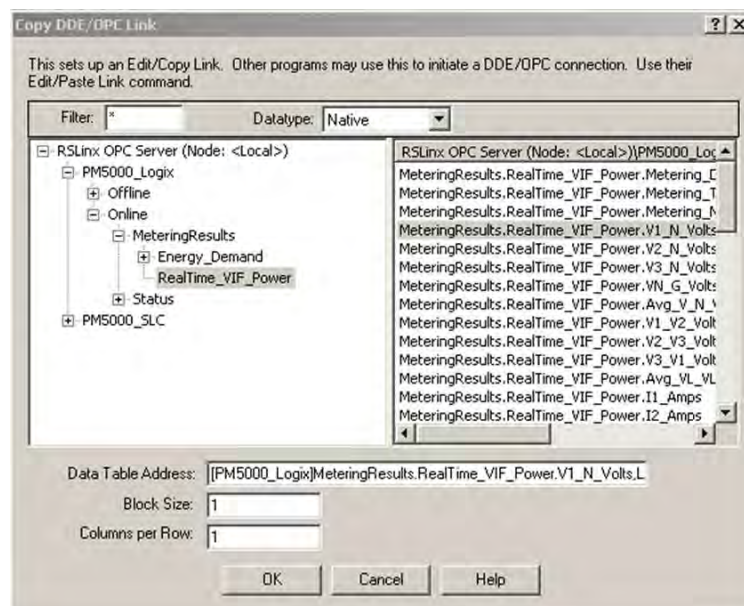
OPC Topic configuration is complete. You can now use the RSLinx OPC Server, and the topic that is just created, to serve data to your application.

**TIP** You can also select the SLC™ 5/03 processor type. The topic that uses this processor type supports PCCC addressing.

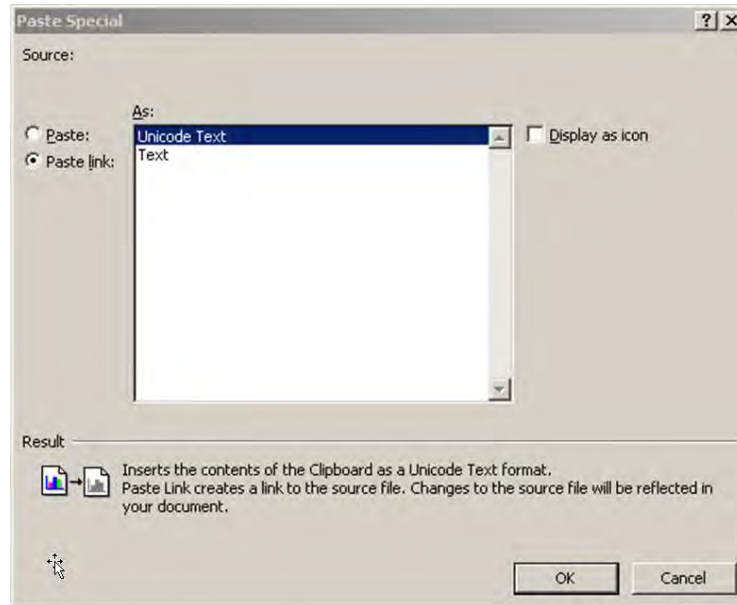
## Testing the OPC Server by Using Microsoft Excel Software

Follow these steps to test the OPC server.

- From the Edit menu, choose Copy DDE/OPC Link to check out the RSLinx Classic OPC server and the new power monitor topic.

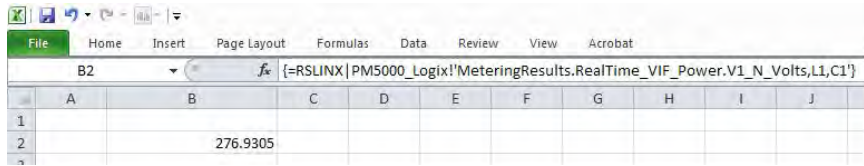


2. In the left pane, browse to Online > MeteringResults > RealTime\_VIF\_Power and select a tag on the right, then click OK.
3. Open Microsoft Excel software.
4. Right-click a cell and choose Paste Special.

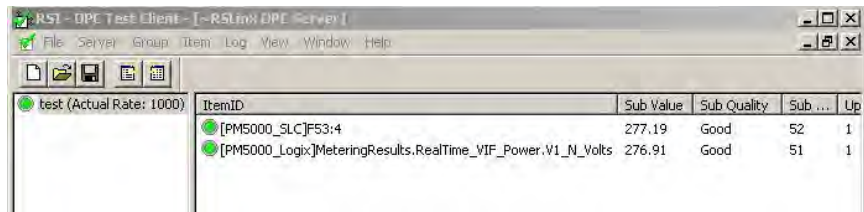


5. Click Paste link, and then click OK.

The value of the selected tag displays in the cell.



You can also check out the OPC topic with the RSLinx OPC Test Client. This figure shows the difference between symbolic and PCCC addressing. The second item uses symbolic addressing.

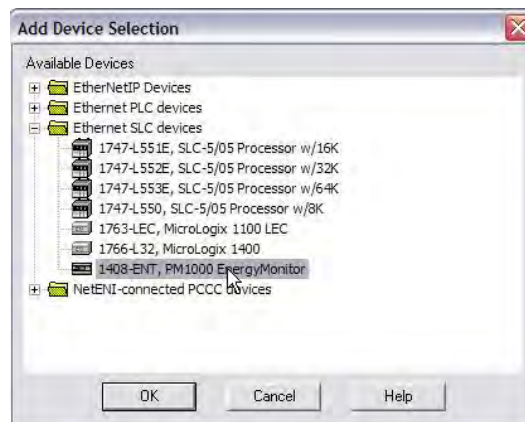


## FactoryTalk Live Data

You can also use RSLinx® Enterprise software to serve power monitor data to other FactoryTalk applications. The PowerMonitor 5000 unit supports PCCC addressing through RSLinx Enterprise software.

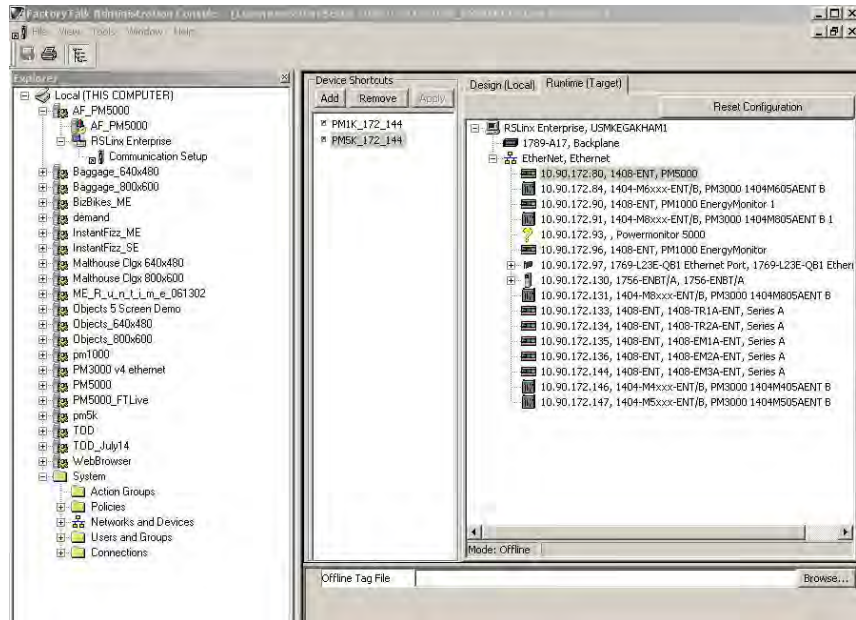
This example illustrates the use of FactoryTalk® Administrator Console. The local FactoryTalk directory is configured for an OPC topic in RSLinx Enterprise software. In the communication setup of the application area, the PowerMonitor 5000 unit initially appears with a yellow question mark icon, its IP address, and its catalog number.

1. Delete this device from the Ethernet driver tree.
2. Create a new device.
3. In the Add Device Selection dialog box, choose Ethernet SLC devices > 1408-ENT PM 1000 EnergyMonitor, and assign the new device its IP address.



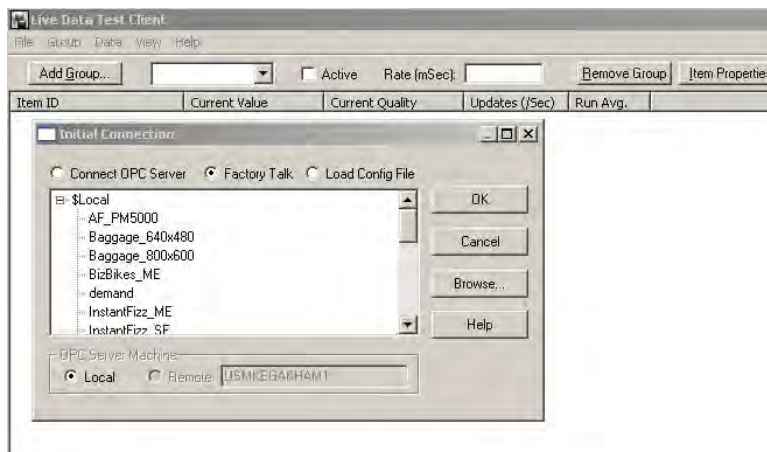


4. Create a device shortcut that references the new device in the tree and click OK when done.



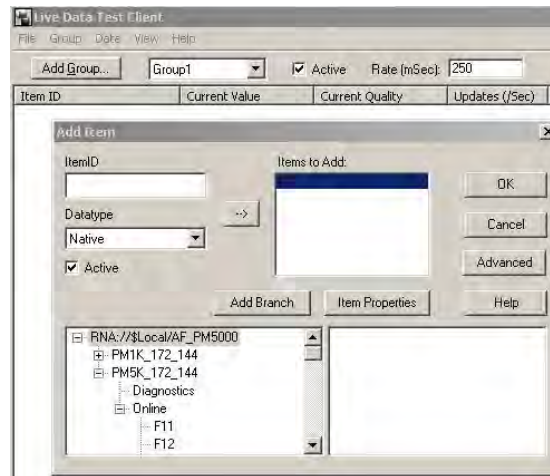
Once the shortcut is created, you can use the Rockwell Live Data Test Client to view PowerMonitor 5000 data.

5. Select the local server and the application area.
6. Select the shortcut, and browse to the Online link.

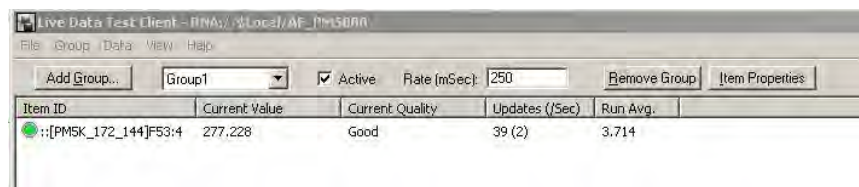


7. In [Appendix A](#), look up the PCCC address of a data point to monitor.

8. Find the address in the list, select it, and click OK.



The Test Client displays the data and other properties of the selected tag. This example uses F53:4, V2\_N\_Volts.



## Controller Applications: Class 1 Connection

This section describes how to configure Class 1 connections with a Logix controller and Studio 5000 Logix Designer® application and RSNetWorx software.

---

**IMPORTANT** Class 1 connections must be inhibited to update the power monitor firmware.

---

### Custom Add-on Profile Connection (Native EtherNet/IP units only)

The PowerMonitor 5000 unit can be configured with a Custom Add-on Profile in Studio 5000 version 20 or later. The Custom Add-on Profile must be downloaded and installed (see [Appendix J](#)). For the setup and configuration of the Add-on Profile, see [Chapter 3](#).

The summary of AOP data types in [Table 33](#) provides an overview of the module-defined Data Types that are created in the Logix project when a PowerMonitor 5000 Add-on Profile is instantiated.

**Table 33 - Summary of AOP Data Tables**

Name	Firmware Revision	Data Access	Module-defined Data Type	Assembly Instance	Size (Bytes)	See Page
Input (Scheduled Read)	4.x	R	AB:1426_Mx:I:0	100	240	234
Output (Scheduled Write)	4.x	W	AB:1426_Mx:O:0	101	4	238
Configuration	4.x	R/W	AB:1426_Mx:C:0	102	172	239

The PowerMonitor 5000 unit and the controller transfer data through controller tags that are added to the Logix application when the Add-on Profile module is created. The connection type and the configuration method of the module definition determine which controller tags are generated (as shown in [Table 34](#)). These controller tags are:

- [ModuleName]:C, the Configuration tag, which is mapped to the Configuration.Instance table
- [ModuleName]:O, the Output or Scheduled Write tag, which is mapped to the ScheduledData.Output table
- [ModuleName]:I, the Input or Scheduled Read tag, which is mapped to the ScheduledData.Input table

See [Chapter 3](#) for information on how to configure and use the Add-on Profile to configure the PowerMonitor 5000 unit.

**Table 34 - Generated Controller Tags**

Connection Type	Module Definition Connection	Module Definition Configured By	Controller Tags Created	Module-defined Data Types Created
Exclusive Owner	Data	This Controller	[ModuleName]:I [ModuleName]:O [ModuleName]:C	AB:1426_Mx:I:0 AB:1426_Mx:O:0 AB:1426_Mx:C:0
	Data	External Means	[ModuleName]:I [ModuleName]:O	AB:1426_Mx:I:0 AB:1426_Mx:O:0
Listen Only	Listen Only	This Controller	[ModuleName]:I	AB:1426_Mx:I:0
Input Only	Input Only	External Means	[ModuleName]:I	AB:1426_Mx:I:0

There are three possible connection types for the PowerMonitor 5000 Add-on Profile.

---

**IMPORTANT** PowerMonitor 5000 devices with optional ControlNet or DeviceNet communication cards are only permitted to have an Input Only connection.

---

#### *Exclusive Owner Connection (Data Connection)*

The Exclusive Owner connection provides complete control of a PowerMonitor 5000 unit to a Logix controller. When you first create an Exclusive Owner connection, the following module-defined controller tags are created:

- [ModuleName]:C, the Configuration tag
- [ModuleName]:O, the Output or Scheduled Write tag

- [ModuleName]:I, the Input or Scheduled Read tag

See [Appendix A](#) for the content of these data tables. When the module is first added to the Logix project, the [ModuleName]:C tag is populated with default configuration values. When the connection is opened, the configuration tag is written to the power monitor and over-writes any existing configuration. The module properties of the Add-on Profile are the interface to view and edit the values in the configuration tag.

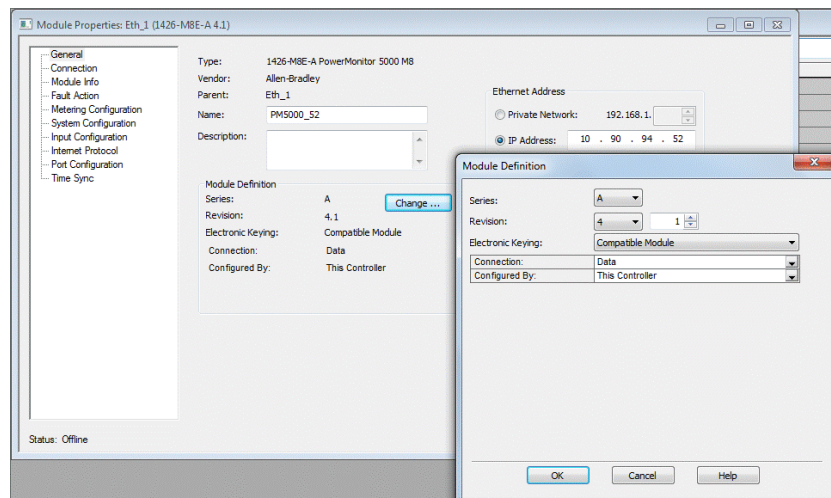
---

**IMPORTANT** If the module definition is set to a data connection, but the configuration method is set to external means, the configuration tag is not created. In this case, the device can be configured by using the web interface, software, or by explicit message to the configuration tables.

---

With an exclusive owner connection active, the following capabilities and restrictions apply:

- Only the owner controller is permitted to modify the power monitor configuration. You can use the Logix Designer application and the module properties dialog box to view and edit the power monitor configuration.
- The owner controller can read the Input tag elements in its logic and write the Output tag elements in its logic.
- You can use Logix Designer application online with the owner controller to force inputs and outputs that are configured for native EtherNet/IP control in the power monitor.
- If the connection is lost, the Default\_State\_on\_Comm\_Loss parameter determines the behavior of each output.



## Listen Only

If an Exclusive Owner connection exists, additional controllers can establish Listen Only connections that permit the controller to read data from the power monitor Input data tables.

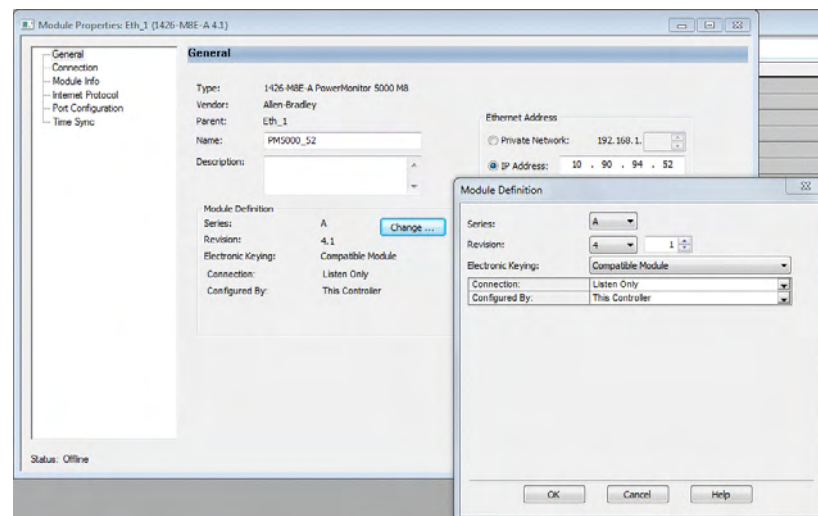
To add a Listen Only connection, the Exclusive Owner connection must be set to Multicast and both connections must be set to the same RPI.

When you first create a Listen Only connection, the following module-defined controller tag is created:

- [ModuleName]:I, the Input tag or Scheduled Read tag

The Input tag is mapped to the ScheduledData.Input table. See [Appendix A](#) for the content of the data table.

If there is no exclusive owner connection, a listen-only connection returns an error code 16#0119 Connection request error: Module not owned.



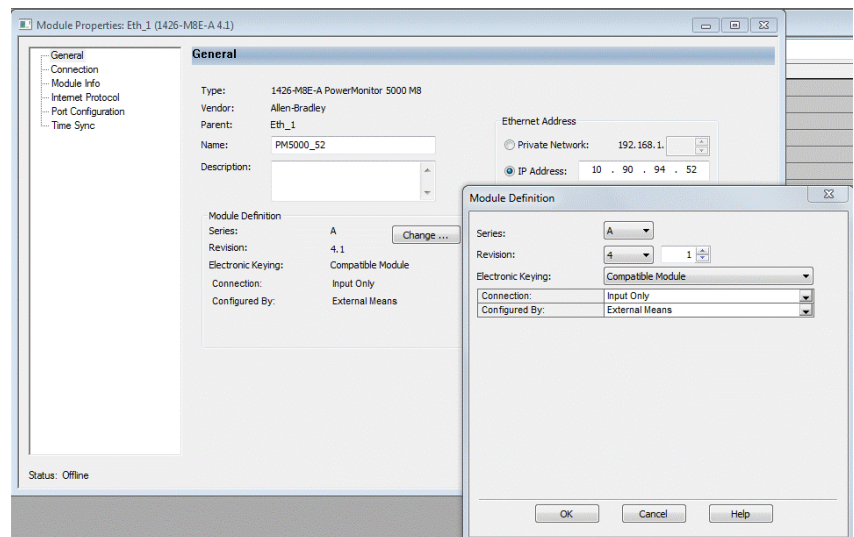
## Input Only

The PowerMonitor 5000 Input Only connection is similar to the Listen Only connection but does not require an Exclusive Owner connection to exist. The Input Only connection permits you to configure the power monitor by using the web interface.

When you first create an Input Only connection, the following module-defined controller tag is created:

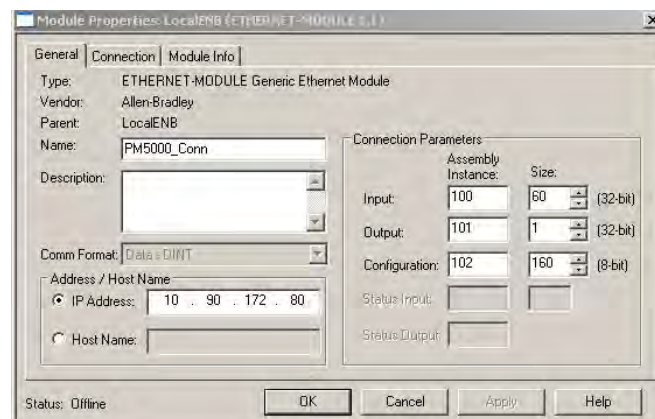
- [ModuleName]:I, the Input tag

The Input tag is mapped to the ScheduledData.Input table. See [Appendix A](#) for the content of the data table.



## Generic Ethernet Module Connection, RSLogix 5000 Software Version 19 and Earlier

1. To create a connection to a PowerMonitor 5000 unit, choose the Ethernet network under the applicable communication adapter in the I/O tree.
2. Right-click and choose New Module from the menu.
3. Enter the power monitor IP address, and the values shown in this figure for the input, output, and configuration instances.
4. Click OK when finished.



The generic Ethernet module connection creates three controller tags in the Logix project, as identified by the Input, Output, and Configuration assembly instances. These assembly instances identify the ScheduledData.Input Data, ScheduledData.Output Data, and Configuration.Instance data tables. These data tables are described in [Appendix A](#). The Input instance and Configuration instances contain various data types. You must create controller tags and write controller logic to copy the Input and Configuration instance data into a usable form.

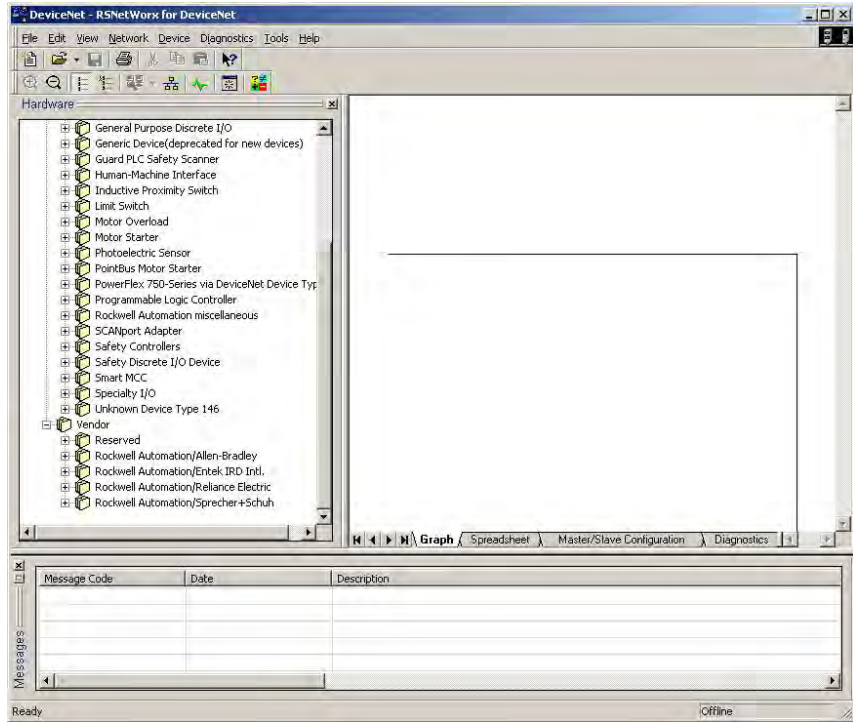
## DeviceNet I/O Connection

The DeviceNet Class 1 connection creates implicit communication between the DeviceNet scanner and the PowerMonitor 5000 unit. With this connection, you can read power monitor parameters into a Logix controller and control the power monitor discrete outputs. The DeviceNet network connection excludes the configuration instance of the PowerMonitor 5000 unit. You can use a web browser for configuring the power monitor, except that when a DeviceNet network connection is active, the web browser is not permitted to change the Configuration.OptionalComm.DNT setup values or execute output forcing commands.

It is not necessary to establish an I/O connection to allow explicit messaging with a DeviceNet PowerMonitor 5000 unit that is connected on a DeviceNet network.

Follow these steps to configure a DeviceNet I/O connection by using RSNetWorx for DeviceNet software.

1. Launch RSNetWorx for DeviceNet software.

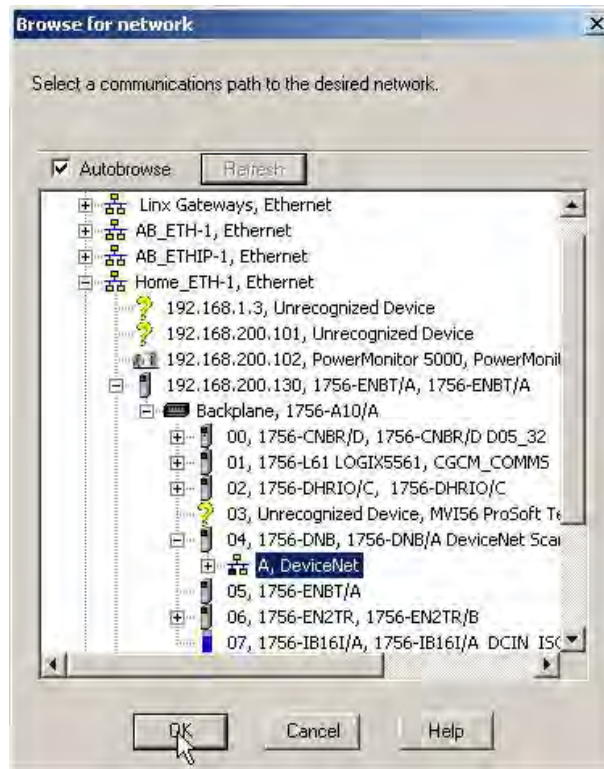


2. Click Online.

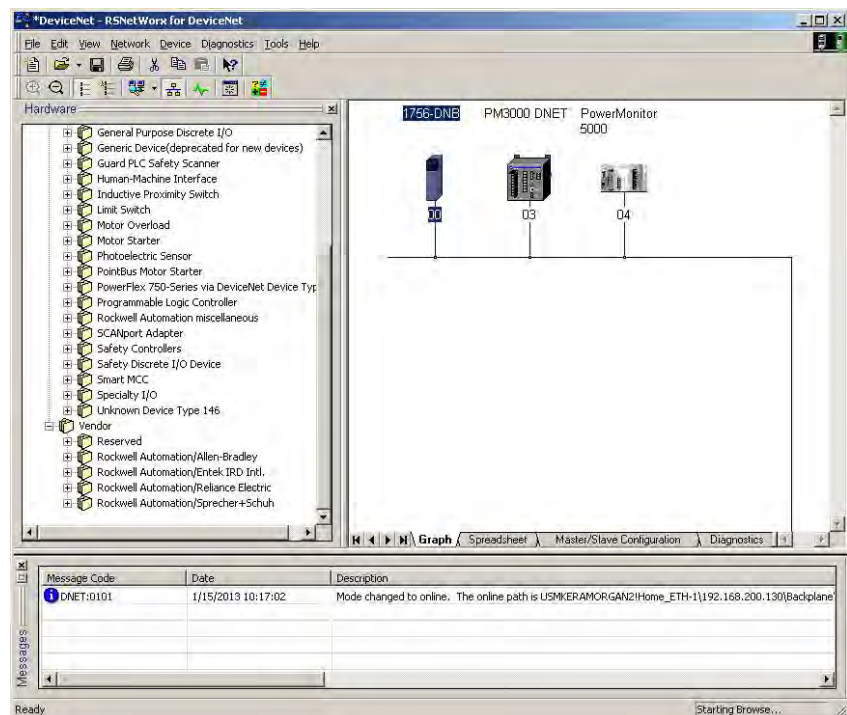




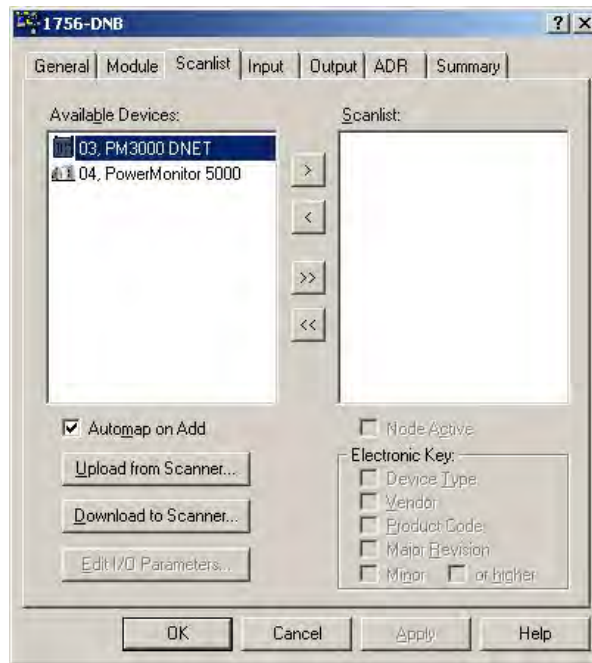
3. Browse to and choose the DeviceNet network.
4. To upload the network data, accept the prompt.



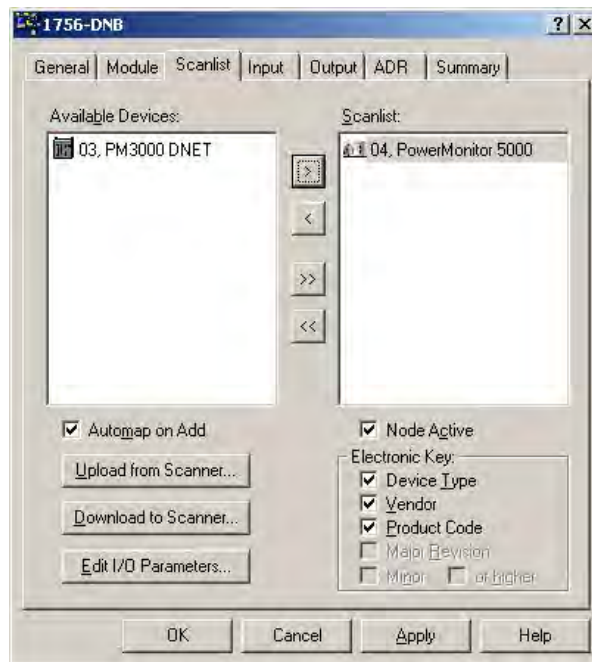
5. If the PowerMonitor 5000 icon does not appear, upload and install the EDS file from the device.



6. Select the scanner and upload its configuration.
7. Open the scanner Properties and click the Scanlist tab.



8. Select the PowerMonitor 5000 unit and click > to add the unit to the scanlist.



9. Click the Input tab.

The Input mapping is now populated with 60 DWORD elements, obtained from the eds file. The Output mapping is similarly set up with one DWORD.

10. To accept the changes and download to the scanner, click OK.

If necessary, place the controller in Program mode.

In the Logix controller, the mapped data now appears in the scanner Local Data tags with a DINT data type. The Local Data tags must be copied into tags with the correct data type so the data can be interpreted correctly.

With a DeviceNet I/O connection active, any attempt to change the DeviceNet communication setting results in an exclusive owner conflict error.

The following example copies the scanner local data first to a SINT array and then to a user-defined tag designed with the correct data types and symbolic addressing.

Name	Value	Force Mask	Style	Data Type	De
DNet_N03_POL_I	{...}	{...}		AB_1426_M6E_DNT_A_I_C25AF480	
DNet_N03_POL_I.Status	0		Decimal	DINT	
DNet_N03_POL_I.Spt_1_10_Active	0		Decimal	INT	
DNet_N03_POL_I.Spt_11_20_Active	0		Decimal	INT	
DNet_N03_POL_I.DiscreteIDStatus	0		Decimal	INT	
DNet_N03_POL_I.Date_Year	2013		Decimal	INT	
DNet_N03_POL_I.Date_Month	1		Decimal	INT	
DNet_N03_POL_I.Date_Day	3		Decimal	INT	
DNet_N03_POL_I.Time_Hour	20		Decimal	INT	
DNet_N03_POL_I.Time_Minute	42		Decimal	INT	
DNet_N03_POL_I.Time_Seconds	16		Decimal	INT	
DNet_N03_POL_I.Time_Millicsec	901		Decimal	INT	
DNet_N03_POL_I.PF_Lead_Lag	0		Decimal	INT	
DNet_N03_POL_I.Reserved	0		Decimal	INT	
DNet_N03_POL_I.V1_N_Volts	0.0		Float	REAL	

You can obtain the user-defined data type (UDT) import files from the resources tab in the PowerMonitor 5000 web page:

<http://ab.rockwellautomation.com/Energy-Monitoring/1426-PowerMonitor-5000>

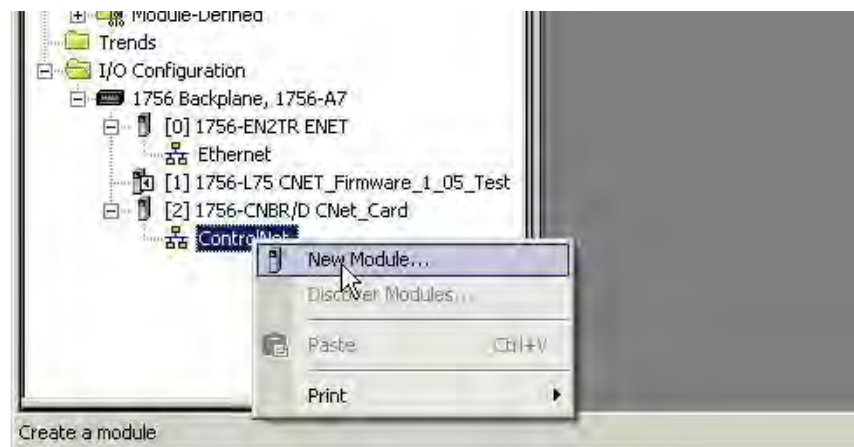
## ControlNet I/O Connection

A ControlNet Class 1 connection sets up the ControlNet scanner in a Logix controller to read implicitly the ScheduledData.Input instance and control outputs without the use of message instructions in logic. The ControlNet connection excludes the power monitor configuration. You can use a web browser, FactoryTalk EnergyMetrix RealTime (RT) software, or other means for power monitor setup. If a ControlNet connection is active, you are not permitted to change the Configuration.OptionalComm.CNT setup or execute output forcing commands.

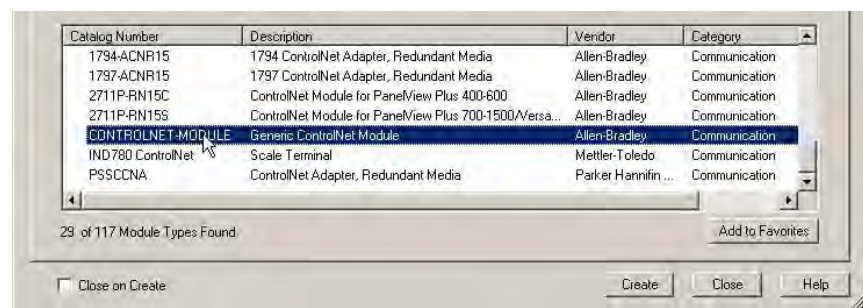
It is not necessary to establish an I/O connection to allow explicit messaging with a ControlNet PowerMonitor 5000 unit that is connected on a ControlNet network.

Follow these steps to configure a ControlNet I/O connection by using the Logix Designer application and RSNetWorx for ControlNet software.

1. Launch the Logix Designer application.
2. Open the project file for your controller in offline mode.
3. Expand the I/O tree and choose the ControlNet network.
4. Right-click the ControlNet item and choose New Module.

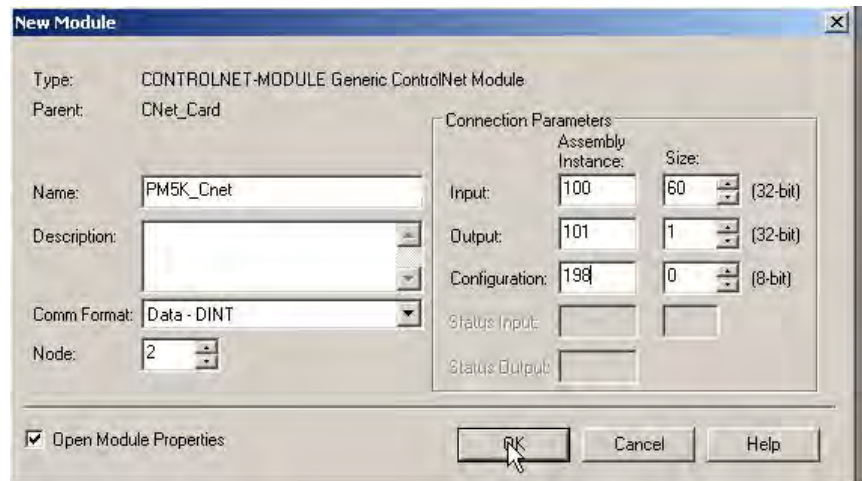


5. Select the Generic ControlNet Module CONTROLNET-MODULE from the list of Communication modules and then click Create.



- Complete the New Module setup as shown in the example and click OK when done.

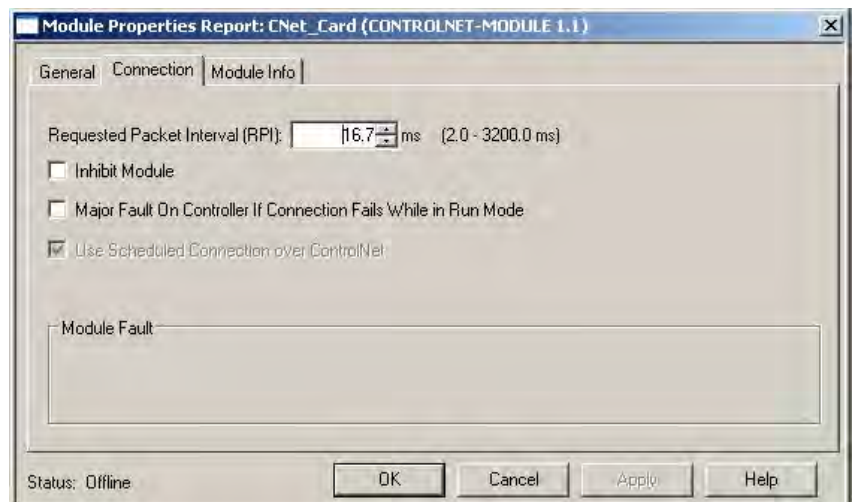
**TIP** The Comm. Format, Input, Output, and Configuration assembly instances and sizes must be entered as shown. Name and optional Description are your choice. Node is the ControlNet address of the power monitor. Click OK when done.



- In the Module Properties dialog box, click the Connection tab and choose a Requested Packet Interval to suit your application.

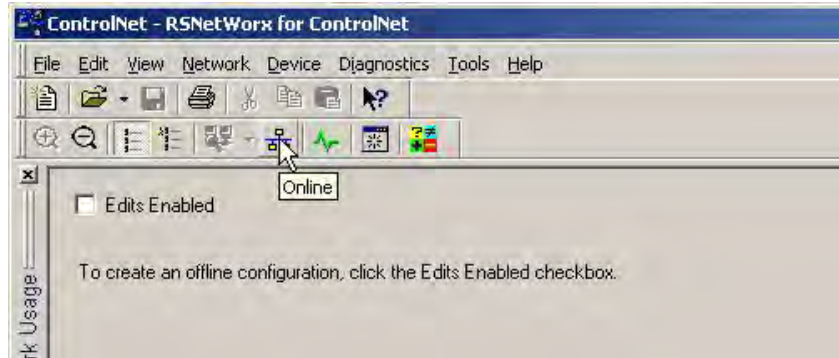
The fastest metering update rate in the PowerMonitor 5000 unit is once per cycle, which is 20 ms for 50 Hz and 16.67 ms for 60 Hz.

- Click OK when done.

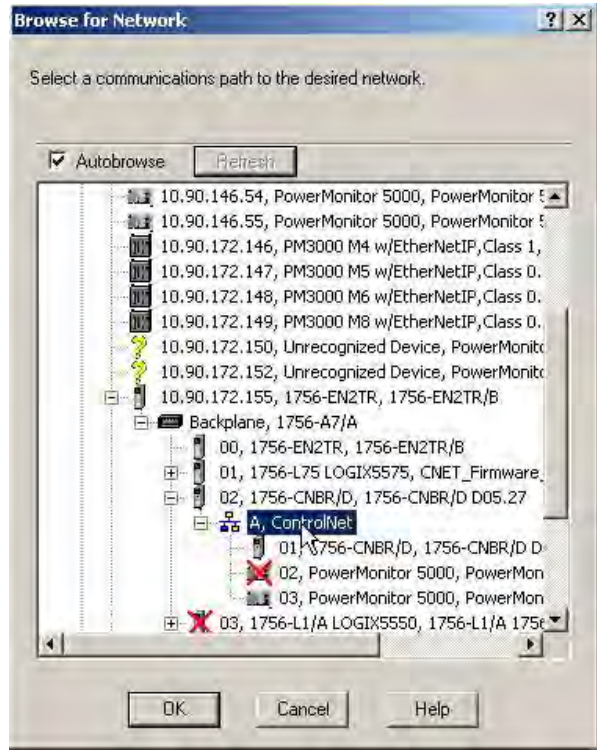


- Download the revised program to the Logix controller.  
You can leave the controller in Remote Program mode for now.

10. Open RSNetWorx for ControlNet software and click Online.

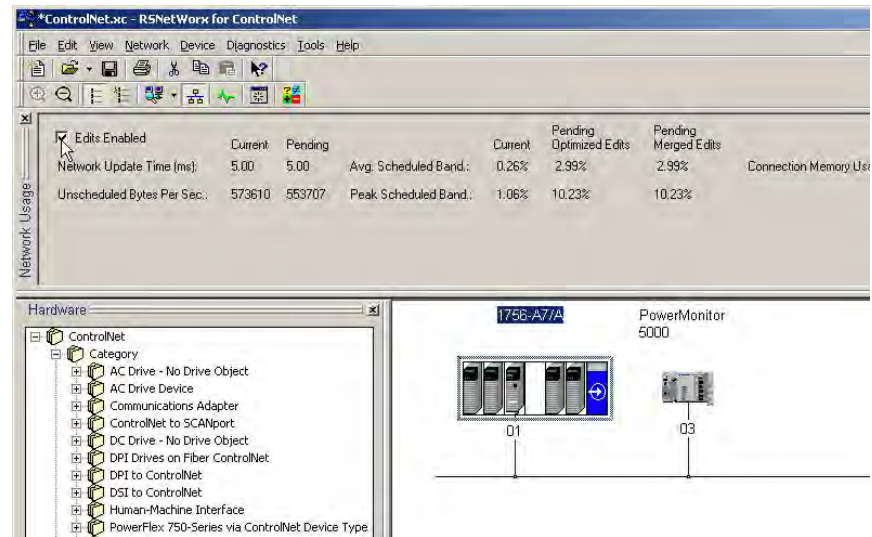


11. Browse to and select the ControlNet network to which the power monitor is connected, and then click OK.



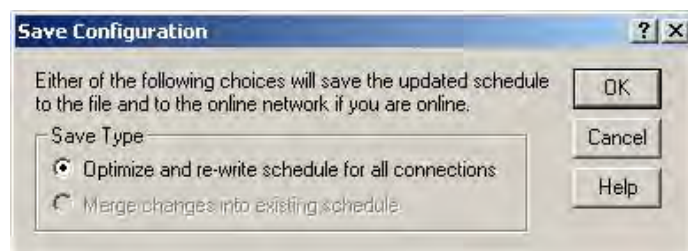
12. Wait until the online browse is complete.

13. If the PowerMonitor 5000 icon does not appear, upload and install the eds file from the device.



14. Check Edits Enabled, and then click OK.
15. To optimize and rewrite schedule for all connections, click the Save icon, then OK.

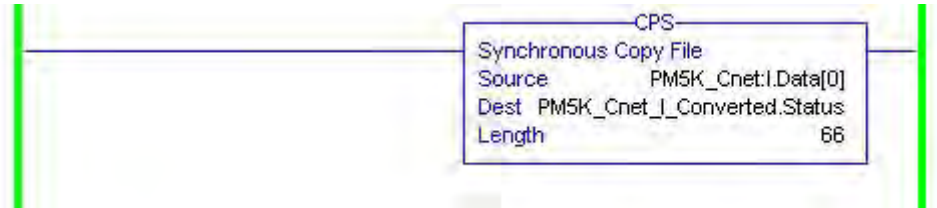
The controller must be in Program mode for the download to happen.



16. Put the Logix controller into Run mode and verify the new I/O connection is running.
17. Close out RSNetWorx software, saving the project if desired.

Data is now being written to the <ModuleName>.I.Data tag in Decimal style. The input tag contains a mixture of different data types. The I.Data tag must be copied into tags with the correct data type so the data can be interpreted correctly.

The following example copies the I.Data tag into a user-defined tag set up with correct data types and symbolic addressing.



PM5K_Cnet_I_Converted.V1_N_Volts	347.24683	Float	REAL
PM5K_Cnet_I_Converted.V2_N_Volts	347.1714	Float	REAL
PM5K_Cnet_I_Converted.V3_N_Volts	348.8039	Float	REAL
PM5K_Cnet_I_Converted.VN_G_Volts	2.40997247e-006	Float	REAL
PM5K_Cnet_I_Converted.Avg_V_N_Volts	347.74072	Float	REAL
PM5K_Cnet_I_Converted.V1_V2_Volts	601.53906	Float	REAL
PM5K_Cnet_I_Converted.V2_V3_Volts	602.1999	Float	REAL
PM5K_Cnet_I_Converted.V3_V1_Volts	602.3936	Float	REAL
PM5K_Cnet_I_Converted.Avg_VL_VL_Volts	602.0442	Float	REAL
PM5K_Cnet_I_Converted.I1_Amps	99.9482	Float	REAL
PM5K_Cnet_I_Converted.I2_Amps	100.00407	Float	REAL

You must create a destination tag with the appropriate data type. You can obtain user-defined data type (UDT) import files from the Resources tab on the PowerMonitor 5000 product web page. The UDT files for DeviceNet input and output instances also work with ControlNet instances.

<http://ab.rockwellautomation.com/Energy-Monitoring/1426-PowerMonitor-5000>



## EDS Add-on Profile Connection (Native EtherNet/IP units only)

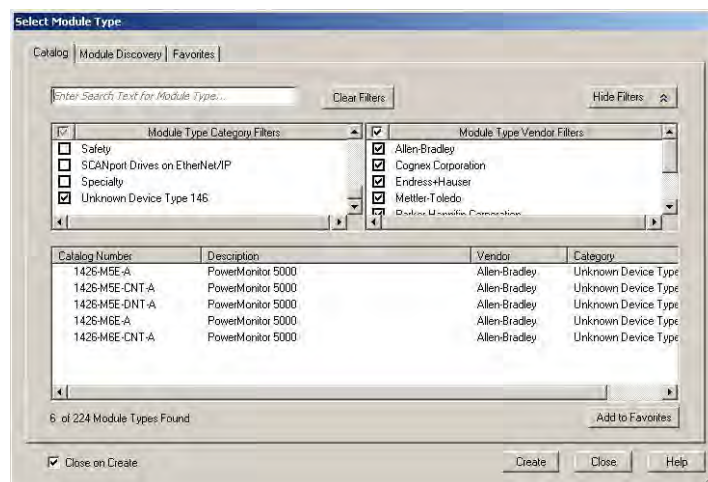
The PowerMonitor 5000 unit can be configured with an electronic data sheet (EDS) based AOP (add-on profile) in RSLogix 5000 software version 20 or Logix Designer application version 21 or later. You need to register the PowerMonitor 5000 EDS file on the computer on which software project development is done.

---

**IMPORTANT** If a connection returns an error code 16#0203 Connection timed out, see Answer 63904 in the Rockwell Automation Knowledgebase.

---

The PowerMonitor 5000 device class is displayed under 'Unknown Device Type 146' when adding a new EtherNet module.



1. Select the desired device and click Create.
2. Enter the name and IP address of the power monitor.
3. In the module definition, select Compatible Module and enter the correct major and minor revisions.

There are three choices for the connection type.

### *PowerMonitor 5000 Unit Exclusive Owner Connection*

The Exclusive Owner connection provides complete control of a PowerMonitor 5000 unit to a Logix controller. When you first set up an Exclusive Owner connection, the following module-defined controller tags are created:

- <ModuleName>:C, the Configuration tag, mapped to the Configuration.Instance table
- <ModuleName>:I, the Input tag, mapped to the ScheduledData.Input table
- <ModuleName>:O, the Output tag, mapped to the ScheduledData.Output table

See [Appendix A](#) for the content of these data tables. The <ModuleName>:C tag is populated with default configuration values. When the connection is opened, the configuration tag is written to the power monitor and over-writes any existing configuration. In most cases, the default Metering\_Basic and SystemGeneral configuration of the power monitor is restored.

With an exclusive owner connection active, the following capabilities and restrictions apply:

- Only the owner controller is permitted to modify the power monitor configuration. You can use the Logix Designer application and the module properties dialog box to view and edit the power monitor configuration, including the native EtherNet/IP communication parameters. Attempts to change the configuration through the web page or other applications is rejected with an 'exclusive ownership conflict' error.
- The owner controller can read the Input tag elements in its logic and write the Output tag elements in its logic.
- You can use Logix Designer application online with the owner controller to force inputs and outputs that are configured for native EtherNet/IP control in the power monitor.
- If the connection is lost, the Default\_State\_on\_Comm\_Loss parameter determines the behavior of each output.

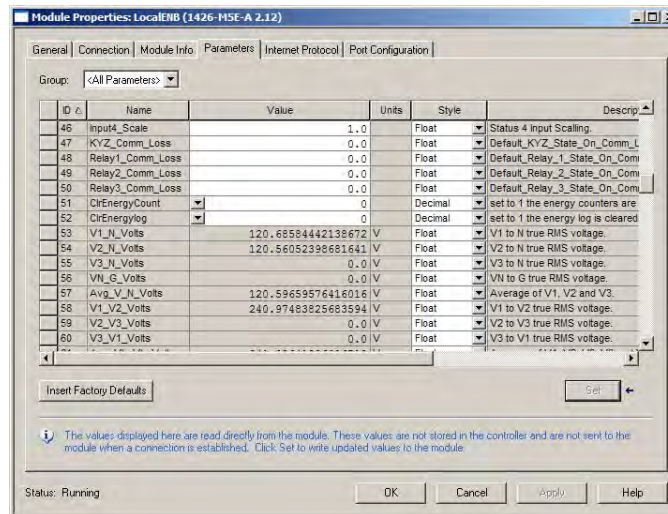
### *Listen Only*

If an Exclusive Owner connection exists, additional controllers can establish Listen Only connections that permit the controller to read data from the power monitor Input data tables. You can also view (but not edit) the power monitor parameters from the module properties dialog box.

To add a Listen Only connection, the Exclusive Owner connection must be set to Multicast and both connections must be set to the same RPI.

When you first set up a Listen Only connection, the following module-defined controller tag is created: <ModuleName>:I, the Input tag, mapped to the [ScheduledData.Input](#) table on [page 272](#).

See [Appendix A](#) for the content of the data table.



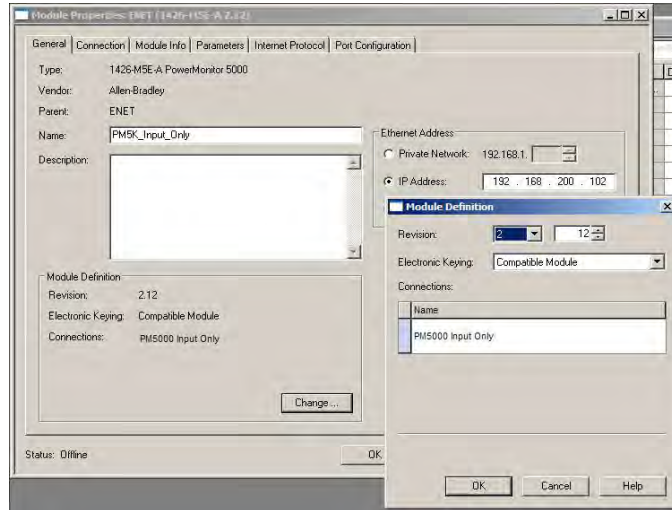
If there is no exclusive owner connection, a listen-only connection returns an error code 16#0119 Connection request error: Module not owned.

### *PowerMonitor 5000 Input Only*

The PowerMonitor 5000 Input Only connection is similar to the Listen Only connection but does not require an Exclusive Owner connection to exist. The Input Only connection permits you to configure the power monitor by using the Web interface and the parameters in the Module Properties dialog box.

When you first set up an Input Only connection, the following module-defined controller tag is created: <ModuleName>:I, the Input tag, mapped to the [ScheduledData.Input](#) table on [page 272](#).

See [Appendix A](#) for the content of the data table.



## CIP Energy Object

The EtherNet/IP communication protocol complies with the Common Industrial Protocol (CIP) and the EtherNet/IP implementation of the CIP specification, which is published by ODVA. The CIP object library includes the following energy-related objects:

- Base Energy Object, Class Code 0x4E
- Electrical Energy Object, Class Code 0x4F

The PowerMonitor 5000 unit provides support of the base and electrical energy objects.

## CIP Base Energy Object

The PowerMonitor 5000 unit supports the following attributes and services of the Base Energy Object, Class Code 0x4E.

**Table 35 - Supported Attributes**

Energy Object Attribute ID	Need in Implementation	Access Rule	Energy Object Attribute Name	PowerMonitor 5000 Implementation
1	Required	Get	Energy/Resource Type	Supported
2	Required	Get	Energy Object Capabilities	Supported
3	Required	Get	Energy Accuracy	Supported
4	Optional	Get/Set	Energy Accuracy Basis	Get only
5	Conditional	Get/Set	Full Scale Reading	Not needed
6	Optional	Get	Device Status	Not supported
7	Optional	Get	Consumed Energy Odometer	Supported
8	Optional	Get	Generated Energy Odometer	Supported
9	Conditional	Get	Total Energy Odometer	Supported
10	Conditional	Get	Energy Transfer Rate	Supported
11	Optional	Set	Energy Transfer Rate User Setting	Not applicable
12	Required	Get	Energy Type Specific Object Path	Supported
13-14	Optional	Set	Energy Aggregation Paths	Not needed
15	Optional	Set	Energy Identifier	Returns Device_Name
16	Optional	Set	Odometer Reset Enable	Not supported
17	Conditional	Get	Metering State	Supported

**Table 36 - Supported Services**

Energy Service Code	Need in Implementation		Service Name	PowerMonitor 5000 Implementation
	Class	Instance		
01hex	Optional	Optional	Get_Attributes_All	Supported
03hex	Optional	Optional	Get_Attribute_List	Supported
04hex	N/A	Optional	Set_Attribute_List	Not supported
05hex	Optional	Required	Reset	Not supported
08hex	Optional	N/A	Create	Not supported
09hex	N/A	Optional	Delete	Not supported
0Ehex	Conditional	Required	Get_Attribute_Single	Supported
10hex	N/A	Required	Set_Attribute_Single	Supported
18hex	N/A	Optional	Get_Member	Not supported
19hex	N/A	Optional	Set_Member	Not supported

## CIP Electrical Energy Object

The PowerMonitor 5000 unit supports the following attributes and services of the Electrical Energy Object, Class Code 0x4F.

**Table 37 - Supported Attributes**

Electrical Energy Object Attribute ID	Need in Implementation	Electrical Energy Object Attribute Name	PM5000 Implementation
1	Optional	Real Energy Consumed Odometer	Supported
2	Optional	Real Energy Generated Odometer	Supported
3	Conditional	Real Energy Net Odometer	Supported
4	Optional	Reactive Energy Consumed Odometer	Supported
5	Optional	Reactive Energy Generated Odometer	Supported
6	Optional	Reactive Energy Net Odometer	Supported
7	Optional	Apparent Energy Odometer	Supported
8	Optional	Kiloampere-Hours Odometer	Supported
9	Optional	Line Frequency	Supported
10	Optional	L1 Current	Supported
11	Optional	L2 Current	Supported
12	Optional	L3 Current	Supported
13	Optional	Average Current	Supported
14	Optional	Percent Current Unbalance	Supported
15	Optional	L1-N Voltage	Supported
16	Optional	L2-N Voltage	Supported
17	Optional	L3-N Voltage	Supported
18	Optional	Average L-N Voltage	Supported
19	Optional	L1-L2 Voltage	Supported
20	Optional	L2-L3 Voltage	Supported
21	Optional	L3-L1 Voltage	Supported
22	Optional	Average L-L Voltage	Supported
23	Optional	Percent Voltage Unbalance	Supported
24	Optional	L1 Real Power	Supported
25	Optional	L2 Real Power	Supported
26	Optional	L3 Real Power	Supported
27	Conditional	Total Real Power	Supported
28	Optional	L1 Reactive Power	Supported
29	Optional	L2 Reactive Power	Supported
30	Optional	L3 Reactive Power	Supported
31	Optional	Total Reactive Power	Supported
32	Optional	L1 Apparent Power	Supported
33	Optional	L2 Apparent Power	Supported
34	Optional	L3 Apparent Power	Supported
35	Optional	Total Apparent Power	Supported

**Table 37 - Supported Attributes (continued)**

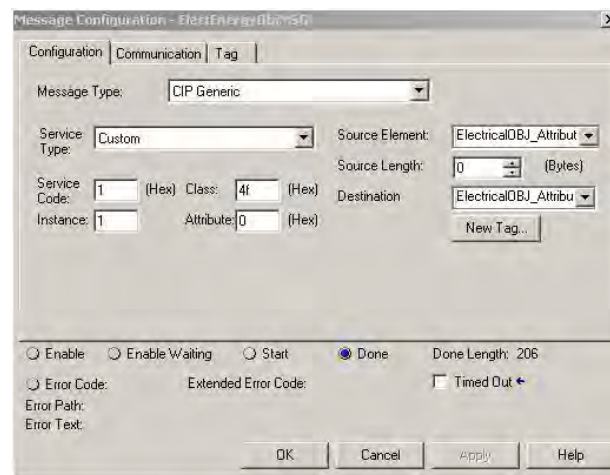
Electrical Energy Object Attribute ID	Need in Implementation	Electrical Energy Object Attribute Name	PM5000 Implementation
36	Optional	L1 True Power Factor	Supported
37	Optional	L2 True Power Factor	Supported
38	Optional	L3 True Power Factor	Supported
39	Optional	Three Phase True Power Factor	Supported
40	Optional	Phase Rotation	Supported
41	Required	Associated Energy Object Path	Supported

**Table 38 - Supported Services**

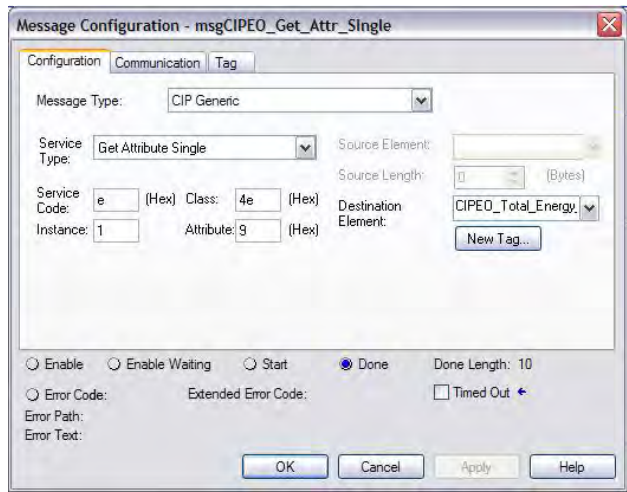
Energy Service Code	Need in Implementation		Service Name	PowerMonitor 5000 Implementation
	Class	Instance		
01hex	Optional	Optional	Get_Attributes_All	Supported
03hex	Optional	Optional	Get_Attribute_List	Supported
0Ehex	Conditional	Required	Get_Attribute_Single	Supported

## Examples of Message Configuration

A sample message instruction configuration dialog box for reading the electrical energy object is shown in this figure. This message calls the Get\_Attributes\_All service (service code 0x01) for the Electrical Energy Object (Class code 0x4F).



The second sample message instruction reads a single value from the electrical energy object. This message calls the Get\_Attribute\_Single service (service code 0x0E) for the Base Energy Object (Class code 0x4E), to read the Total Energy Odometer, attribute 9.



The data is returned in the correct 'odometer' format of five integers that are scaled by powers of 10. In this example, the total energy value is 1,471.371 kWh.

[-] CIPEO_Total_Energy_Odometer	{...}	{...}	Decimal	INT[5]
[+] CIPEO_Total_Energy_Odometer[0]	371		Decimal	INT
[+] CIPEO_Total_Energy_Odometer[1]	471		Decimal	INT
[+] CIPEO_Total_Energy_Odometer[2]	1		Decimal	INT
[+] CIPEO_Total_Energy_Odometer[3]	0		Decimal	INT
[+] CIPEO_Total_Energy_Odometer[4]	0		Decimal	INT



## Maintenance

### Update the PowerMonitor 5000 Unit Firmware

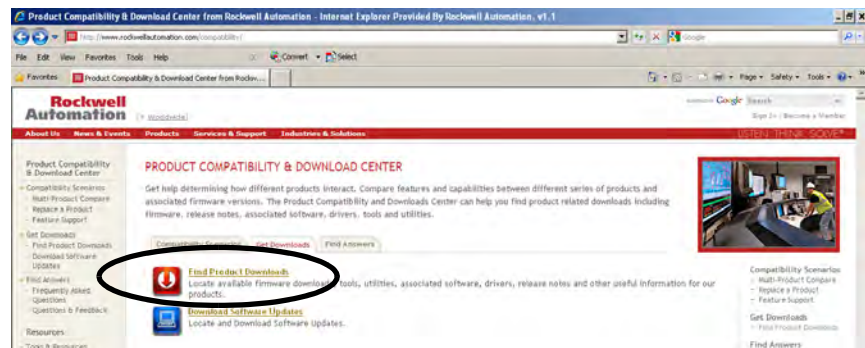
From time to time, firmware updates can be made available for your power monitor. You can also purchase firmware upgrades to add capabilities to your power monitor, for example, promoting an M5 unit to an M6 or M8 unit.

To load firmware, use the ControlFLASH™ utility. You can download firmware updates from the Rockwell Automation technical support website <http://www.rockwellautomation.com/compatibility>.

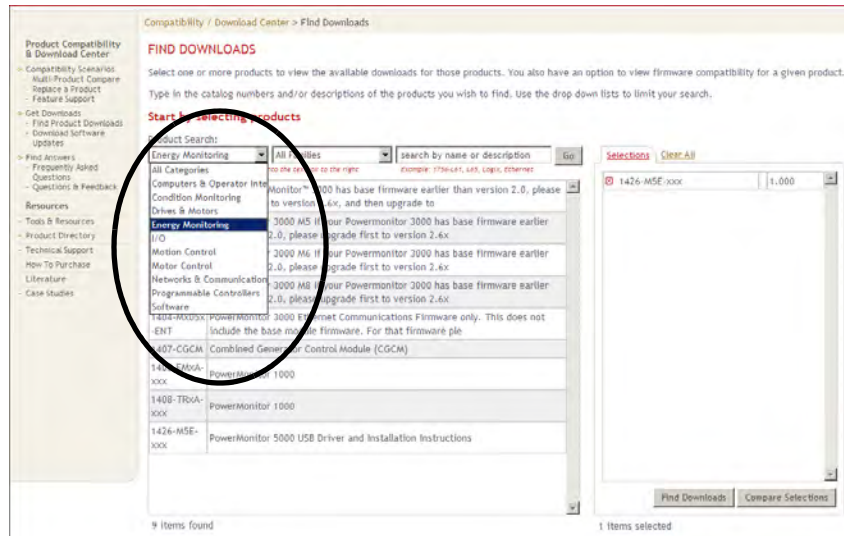
To purchase model upgrades, contact your local Rockwell Automation representative or Allen-Bradley distributor.

Follow these steps to download firmware from the support website.

1. Click Find Product Downloads.



2. From the Product Search pull-down menu, choose Energy Monitoring.

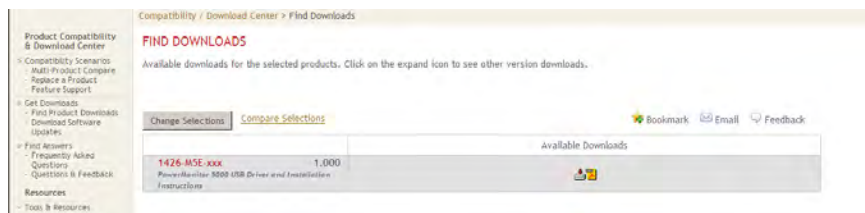


3. Select the 1426-M5E, series and version to download and respond to the prompts.

Your selections appear in the column on the right.

4. Click Find Downloads.

Your download selections appear.



5. Click download  and follow the prompts.

6. After you have downloaded the firmware kit, locate the downloaded ZIP file.

7. Open the ZIP file, and then double-click the ControlFLASH.msi file to install the ControlFLASH utility and the power monitor firmware to your computer

8. Follow the prompts to install the software.

## Upgrading the PowerMonitor 5000 Model and Communication

You can upgrade an M5 model to an M6 or M8 model by installing a firmware upgrade kit. Contact your local Rockwell Automation representative or Allen-Bradley distributor to purchase an upgrade. Provide the catalog and serial numbers of your existing PowerMonitor™ 5000 units. The upgrade is furnished with instructions for installation over the native Ethernet, USB, or optional communication ports.

You can also add an optional DeviceNet® or ControlNet® port. Contact your local Allen-Bradley distributor or Rockwell Automation sales representative to purchase an optional communication port. The port is provided with installation instructions. No firmware update is required to use a newly installed optional communication port. Following installation, the power monitor functions identically to a unit with a factory-installed optional port, except the unit is still identified as the original catalog number for tasks like firmware updates.

## Use the ControlFLASH Utility to Update Firmware

You can use the ControlFLASH utility to load firmware via the Ethernet network.

Make sure that the appropriate network connection is made and that a driver for the network is configured in RSLinx® Classic software before starting.

---

**IMPORTANT** The ControlFLASH utility does not update the firmware if any Class 1 connections (generic, Custom AOP, or EDS AOP connections) exist. A connection exists if the Network status indicator is either solid green (connection active) or blinking red (connection timed out). Use the Studio 5000 Logix Designer® application to connect to the controller that owns each connection and inhibit the connection. After successfully updating the power monitor firmware, you can uninhibit the connections. You can edit connection properties to reflect the new power monitor firmware revision.

---

1. Start the ControlFLASH utility.
2. From the Welcome dialog box, click Next.
3. Select the catalog number of the power monitor, and click Next.
4. Expand the network until you see the power monitor.  
[If the required network is not shown, configure a driver for the network in RSLinx Classic software]
5. Select the power monitor, and click OK.
6. Select the revision level to which you want to update the controller, and click Next.
7. To start the update of the controller, click Finish and Yes.

After the controller is updated, the ControlFLASH utility polls the unit to determine that the unit has restarted. After the unit has restarted, the Status dialog box displays Update complete.

8. Click OK.
9. To close the ControlFLASH utility, click Cancel and Yes.

**TIP** If an error message appears that indicates the target device is not in a proper mode to accept an update, then one or more Class 1 connections exist. See the ControlFLASH utility note for more information.

## PowerMonitor 5000 Unit Data Tables

### Summary of Data Tables

The [Data Table Summary Index](#) table summarizes all data tables available and their general attributes.

**Table 39 - Data Table Summary Index**

Name of Data Table	Read	M5	M6	M8	Write	PCCC File Number	CIP Instance Number	No. of Table Parameters	See Page
<a href="#">ScheduledData.Input</a>	X	X	X	X			100	65	<a href="#">page 272</a>
<a href="#">ScheduledData.Output</a>		X	X	X	X		101	1	<a href="#">page 276</a>
<a href="#">Configuration.Instance</a>	X	X	X	X	X		102	44	<a href="#">page 277</a>
<a href="#">Configuration Parameter Object Table</a>	X	X	X	X	X	NA	NA	52	<a href="#">page 283</a>
<a href="#">Display Parameter Object Table</a>	X	X	X	X		NA	NA	117	<a href="#">page 285</a>
<a href="#">Configuration.DateTime</a>	X	X	X	X	X	N9	800	15	<a href="#">page 288</a>
<a href="#">Configuration.Logging</a>	X	X	X	X	X	N10	801	40	<a href="#">page 289</a>
<a href="#">Configuration.Metering.Basic</a>	X	X	X	X	X	F11	802	33	<a href="#">page 291</a>
<a href="#">Configuration.System.General</a>	X	X	X	X	X	F12	803	50	<a href="#">page 293</a>
<a href="#">Configuration.Communications Native</a>	X	X	X	X	X	N13	804	70	<a href="#">page 296</a>
<a href="#">Configuration.Network.Text</a>	X	X	X	X	X	ST14	805	5	<a href="#">page 298</a>
<a href="#">Configuration.Setpoints 1_5</a>	X	X	X	X	X	F16	807	50	<a href="#">page 299</a>
<a href="#">Configuration.Setpoints 6_10</a>	X	X	X	X	X	F17	808	50	<a href="#">page 302</a>
<a href="#">Configuration.Setpoints 11_15 (M6 and M8 model)</a>	X		X	X	X	F18	809	50	<a href="#">page 305</a>
<a href="#">Configuration.Setpoints 16_20 (M6 and M8 model)</a>	X		X	X	X	F19	810	50	<a href="#">page 308</a>
<a href="#">Configuration.Setpoint Logic (M6 and M8 Model)</a>	X		X	X	X	N20	811	100	<a href="#">page 311</a>
<a href="#">Configuration.Setpoint Outputs</a>	X	X	X	X	X	N21	812	100	<a href="#">page 320</a>
<a href="#">Configuration.Data Log</a>	X	X	X	X	X	N22	813	34	<a href="#">page 324</a>
<a href="#">Configuration.Log Read</a>	X	X	X	X	X	N23	814	15	<a href="#">page 326</a>
<a href="#">Configuration.PowerQuality</a>	X		X	X	X	F24	815	50	<a href="#">page 327</a>
<a href="#">Configuration.OptionalComm.DNT</a>	X	X	X	X	X	N25	816	30	<a href="#">page 329</a>
<a href="#">Configuration.OptionalComm.CNT</a>	X	X	X	X	X	N25	816	30	<a href="#">page 330</a>
<a href="#">Configuration.DataLogFile</a>		X	X	X	X	ST26	817	1	<a href="#">page 330</a>
<a href="#">Configuration.EnergyLogFile</a>		X	X	X	X	ST27	818	1	<a href="#">page 331</a>
<a href="#">Configuration.TriggerDataLogFile (M6 and M8 model)</a>			X	X	X	ST77	868	1	<a href="#">page 331</a>
<a href="#">Configuration.TriggerSetpointInfoFile (M6 and M8 model)</a>			X	X	X	ST76	867	1	<a href="#">page 332</a>
<a href="#">Configuration.TriggerData_Log (M6 and M8 model)</a>	X		X	X	X	N31	822	10	<a href="#">page 332</a>
<a href="#">Configuration.Harmonics Optional Read</a>			X	X	X	N28	819	15	<a href="#">page 333</a>

**Table 39 - Data Table Summary Index (continued)**

Name of Data Table	Read	M5	M6	M8	Write	PCCC File Number	CIP Instance Number	No. of Table Parameters	See Page
<a href="#">Configuration.WaveformFileName (M6 and M8 model)</a>			X	X	X	ST79	870	1	<a href="#">page 334</a>
<a href="#">Security.Username</a>		X	X	X	X	ST29	820	1	<a href="#">page 334</a>
<a href="#">Security.Password</a>		X	X	X	X	ST30	821	1	<a href="#">page 335</a>
<a href="#">Status.General</a>	X	X	X	X		N32	823	55	<a href="#">page 336</a>
<a href="#">Status.Communications</a>	X	X	X	X		N33	824	61	<a href="#">page 338</a>
<a href="#">Status.RunTime</a>	X	X	X	X		N34	825	74	<a href="#">page 339</a>
<a href="#">Status.DiscreteIO</a>	X	X	X	X		N35	826	112	<a href="#">page 342</a>
<a href="#">Status.Wiring_Diagnostics</a>	X	X	X	X		F38	829	33	<a href="#">page 343</a>
<a href="#">Status.TableWrites</a>	X	X	X	X		N39	830	13	<a href="#">page 346</a>
<a href="#">Status.InformationTable</a>	X	X	X	X		ST40	831	10	<a href="#">page 347</a>
<a href="#">Status.Alarms</a>	X	X	X	X		N41	832	32	<a href="#">page 348</a>
<a href="#">Status.OptionalComm</a>	X	X	X	X		N44	835	30	<a href="#">page 356</a>
<a href="#">Status.Wiring_Corrections</a>	X	X	X	X		N43	834	14	<a href="#">page 358</a>
<a href="#">Status.IEEE1588 (M6 and M8 model)</a>	X		X	X		N82	873	45	<a href="#">page 360</a>
<a href="#">Statistics.Setpoint_Output</a>	X	X	X	X		N36	827	112	<a href="#">page 362</a>
<a href="#">Statistics.Logging</a>	X	X	X	X		N42	833	20	<a href="#">page 365</a>
<a href="#">Statistics.Setpoint_Logic (M6 and M8 model)</a>	X		X	X		N37	828	112	<a href="#">page 366</a>
<a href="#">Command.System_Registers</a>		X	X	X	X	F47	838	45	<a href="#">page 368</a>
<a href="#">Command.Controller_Interface</a>		X	X	X	X	N48	839	16	<a href="#">page 370</a>
<a href="#">Command.Wiring_Corrections</a>		X	X	X	X	N49	840	14	<a href="#">page 371</a>
<a href="#">MeteringResults.RealTime_VIF_Power</a>	X	X	X	X		F53	844	56	<a href="#">page 373</a>
<a href="#">MeteringResults.Energy_Demand</a>	X	X	X	X		F55	846	56	<a href="#">page 375</a>
<a href="#">MeteringResults.EN61000_4_30_VIP (M8 only)</a>	X			X		F89	880	43	<a href="#">page 376</a>
<a href="#">LoggingResults.DataLog_FileName</a>	X	X	X	X		ST58	849	1	<a href="#">page 378</a>
<a href="#">LoggingResults.EnergyLog_FileName</a>	X	X	X	X		ST59	850	1	<a href="#">page 378</a>
<a href="#">LoggingResults.Data_Log</a>	X	X	X	X		F60	851	38	<a href="#">page 379</a>
<a href="#">LoggingResults.Energy_Log</a>	X	X	X	X		F61	852	35	<a href="#">page 381</a>
<a href="#">LoggingResults.LoadFactor.Log</a>	X	X	X	X		F62	853	40	<a href="#">page 383</a>
<a href="#">LoggingResults.TOU.Log</a>	X	X	X	X		F63	854	38	<a href="#">page 384</a>
<a href="#">LoggingResults.MIN_MAX.Log</a>	X	X	X	X		F64	855	11	<a href="#">page 385</a>
<a href="#">LoggingResults.Alarm_Log</a>	X	X	X	X		N65	856	7	<a href="#">page 386</a>
<a href="#">LoggingResults.Event_Log</a>	X	X	X	X		N66	857	9	<a href="#">page 387</a>
<a href="#">LoggingResults.Setpoint_Log</a>	X	X	X	X		F67	858	18	<a href="#">page 388</a>
<a href="#">LoggingResults.Error_Log</a>	X	X	X	X		N68	859	24	<a href="#">page 389</a>
<a href="#">LoggingResults.TriggerLogSetpointInfo_FileName (M6 and M8 model)</a>	X		X	X		ST75	866	1	<a href="#">page 391</a>
<a href="#">LoggingResults.TriggerLog_FileName (M6 and M8 model)</a>	X		X	X		ST74	865	1	<a href="#">page 391</a>
<a href="#">LoggingResults.TriggerData_Header (M6 and M8 model)</a>	X		X	X		F71	862	15	<a href="#">page 392</a>


**Table 39 - Data Table Summary Index (continued)**

Name of Data Table	Read	M5	M6	M8	Write	PCCC File Number	CIP Instance Number	No. of Table Parameters	See Page
<a href="#">LoggingResults.TriggerData_Log (M6 and M8 model)</a>	X		X	X		F70	861	14	<a href="#">page 393</a>
<a href="#">LoggingResults.Power_Quality_Log (M6 and M8 model)</a>	X		X	X		F73	864	32	<a href="#">page 394</a>
<a href="#">LoggingResults.Snapshot_Log (M6 and M8 model)</a>	X		X	X		F81	872	2	<a href="#">page 395</a>
<a href="#">LoggingResults.WaveformFileName (M6 and M8 model)</a>	X		X	X		ST78	869	1	<a href="#">page 396</a>
<a href="#">LoggingResults.Waveform_Log (M6 and M8 model)</a>	X		X	X		F80	871	43	<a href="#">page 396</a>
<a href="#">LoggingResults.EN50160_Weekly_Log (M8 only)</a>	X			X		F83	874	13	<a href="#">page 398</a>
<a href="#">LoggingResults.EN50160_Yearly_Log (M8 only)</a>	X			X		F84	875	37	<a href="#">page 399</a>
<a href="#">PowerQuality.RealTime_PowerQuality</a>	X	X	X	X		F54	845	56	<a href="#">page 401</a>
<a href="#">PowerQuality.EN61000_4_30_HSG (M8 only)</a>	X			X		F88	879	23	<a href="#">page 403</a>
<a href="#">PowerQuality.EN61000_4_30_THD (M8 only)</a>	X			X		F90	881	46	<a href="#">page 404</a>
<a href="#">PowerQuality.EN61000_4_30_Sequence (M8 only)</a>	X			X		F91	882	13	<a href="#">page 406</a>
<a href="#">PowerQuality.EN61000_4_30_Aggregation (M8 only)</a>	X			X		F92	883	46	<a href="#">page 407</a>
<a href="#">PowerQuality.EN50160_Compliance_Results (M8 only)</a>	X			X		F93	884	40	<a href="#">page 409</a>
<a href="#">PowerQuality.Harmonics_Results (M6 and M8 model)</a>	X		X	X		F69	860	37	<a href="#">page 411</a>
<a href="#">PowerQuality.IEEE1159_Results (M6 and M8 model)</a>	X		X	X		F72	863	26	<a href="#">page 413</a>
<a href="#">PowerQuality.Synchro_Phase_Results</a>	X		X	X		F103	894	26	<a href="#">page 415</a>
<a href="#">PowerQuality.IEEE519_Results (M6 and M8 model)</a>	X		X	X		Fn (varies)	Varies	44	<a href="#">page 417</a>
<a href="#">PowerQuality.Harmonics_Results (M6 and M8 model)</a>	X		X	X		Fn (varies)	Varies	35	<a href="#">page 422</a>
<a href="#">PowerQuality.EN61000_4_30_Harmonic and Interharmonic Group Results (M8 only)</a>	X			X		Fn (varies)	Varies	54	<a href="#">page 428</a>

## Data Tables

These tables detail each specific data table and its associated elements, such as start bytes, size, default value, ranges, and description.

---

**IMPORTANT** The lock symbol  designates that the parameter that is marked is not able to be written when the hardware lock switch is in the lock position.

---

### ScheduledData.Input

**Table 40 - Table Properties**

<b>CIP Assembly Instance</b>	100
<b>No. of Elements</b>	65
<b>Length in Words</b>	120
<b>Data Type</b>	Shown in table
<b>Data Access</b>	Read Only

**Table 41 - ScheduledData.Input Data Table**

Start Byte	Size	Type	Tag Name	Description	Units	Range
0	4	DWORD	Fault	The status of the connection		
4	2	Int16	SetPoint01_10Status	Actuation Status of Setpoints 1 through 10		0...65535
		Bit 0	SetPoint01Active	1 Indicates the setpoint is Active		0 or 1
		Bit 1	SetPoint02Active	1 Indicates the setpoint is Active		0 or 1
		Bit 2	SetPoint03Active	1 Indicates the setpoint is Active		0 or 1
		Bit 3	SetPoint04Active	1 Indicates the setpoint is Active		0 or 1
		Bit 4	SetPoint05Active	1 Indicates the setpoint is Active		0 or 1
		Bit 5	SetPoint06Active	1 Indicates the setpoint is Active		0 or 1
		Bit 6	SetPoint07Active	1 Indicates the setpoint is Active		0 or 1
		Bit 7	SetPoint08Active	1 Indicates the setpoint is Active		0 or 1
		Bit 8	SetPoint09Active	1 Indicates the setpoint is Active		0 or 1
		Bit 9	SetPoint10Active	1 Indicates the setpoint is Active		0 or 1
		Bit 10...15	Reserved	Future Use		0



**Table 41 - ScheduledData.Input Data Table (continued)**

Start Byte	Size	Type	Tag Name	Description	Units	Range
6	2	Int16	SetPoint11_20Status	Actuation Status of Setpoints 11 through 20		0...65535
		Bit 0	SetPoint11Active	1 Indicates the setpoint is Active		0 or 1
		Bit 1	SetPoint12Active	1 Indicates the setpoint is Active		0 or 1
		Bit 2	SetPoint13Active	1 Indicates the setpoint is Active		0 or 1
		Bit 3	SetPoint14Active	1 Indicates the setpoint is Active		0 or 1
		Bit 4	SetPoint15Active	1 Indicates the setpoint is Active		0 or 1
		Bit 5	SetPoint16Active	1 Indicates the setpoint is Active		0 or 1
		Bit 6	SetPoint17Active	1 Indicates the setpoint is Active		0 or 1
		Bit 7	SetPoint18Active	1 Indicates the setpoint is Active		0 or 1
		Bit 8	SetPoint19Active	1 Indicates the setpoint is Active		0 or 1
		Bit 9	SetPoint20Active	1 Indicates the setpoint is Active		0 or 1
		Bit 10...15	Reserved	Future Use		0
8	2	Int16	DiscreteOutputStatus	Discrete Output status		0...65535
		Bit 0	KYZLogicState	KYZ Logic State		0 or 1
		Bit 1	R1LogicState	Relay 1 Logic State		0 or 1
		Bit 2	R2LogicState	Relay 2 Logic State		0 or 1
		Bit 3	R3LogicState	Relay 3 Logic State		0 or 1
		Bit 4	KYZReadback	Indicates Output KYZ Energized		0 or 1
		Bit 5	KYZForcedOn	Software Control Forced On KYZ		0 or 1
		Bit 6	KYZForcedOff	Software Control Forced Off KYZ		0 or 1
		Bit 7	R1Readback	Indicates Output Relay 1 Energized		0 or 1
		Bit 8	R1ForcedOn	Software Control Forced On Relay 1		0 or 1
		Bit 9	R1ForcedOff	Software Control Forced Off Relay 1		0 or 1
		Bit 10	R2Readback	Indicates Output Relay 2 Energized		0 or 1
		Bit 11	R2ForcedOn	Software Control Forced On Relay 2		0 or 1
		Bit 12	R2ForcedOff	Software Control Forced Off Relay 2		0 or 1
		Bit 13	R3Readback	Indicates Output Relay 3 Energized		0 or 1
		Bit 14	R3ForcedOn	Software Control Forced On Relay 3		0 or 1
Bit 15	R3ForcedOff	Software Control Forced Off Relay 3		0 or 1		
10	2	Int16	Year	The current year	2010	2010...2100
12	2	Int16	Month_Day	The current month and day	101	0101...1231
14	2	Int16	Hour_Minute	The current hour and minute of the day	0	0000...2359
16	2	UInt16	Seconds_Milliseconds	The current seconds and milliseconds	0	00000...59999
18	2	Int16	Reserved	Future Use		0
20	4	Int32	Metering_Iteration_Num	Metering iteration number	0	0...65535
24	2	Int16	PFLoadLag	L1 lead or lag indicator for power factor 1 = leading, -1 = lagging		-1...1

**Table 41 - ScheduledData.Input Data Table (continued)**

Start Byte	Size	Type	Tag Name	Description	Units	Range
26	2	Int16	DiscreteInputStatus	Discrete Input status		
		Bit 0	S1	Indicates Status 1 actuated		0 or 1
		Bit 1	S2	Indicates Status 2 actuated		0 or 1
		Bit 2	S3	Indicates Status 3 actuated		0 or 1
		Bit 3	S4	Indicates Status 4 actuated		0 or 1
		Bit 4...15	Reserved	Future Use		0
28	4	Real	V1ToVNVoltage	V1 to N true RMS voltage	V	0...9.999E15
32	4	Real	V2ToVNVoltage	V2 to N true RMS voltage	V	0...9.999E15
36	4	Real	V3ToVNVoltage	V3 to N true RMS voltage	V	0...9.999E15
40	4	Real	VNToVGVoltage	VN to G true RMS voltage	V	0...9.999E15
44	4	Real	AvgVtoVNVoltage	Average of V1, V2 and V3.	V	0...9.999E15
48	4	Real	V1ToV2Voltage	V1 to V2 true RMS voltage	V	0...9.999E15
52	4	Real	V2ToV3Voltage	V2 to V3 true RMS voltage	V	0...9.999E15
56	4	Real	V3ToV1Voltage	V3 to V1 true RMS voltage	V	0...9.999E15
60	4	Real	AvgVtoVVoltage	Average of V1_V2, V2_V3 and V3_V1.	V	0...9.999E15
64	4	Real	I1Current	I1 true RMS amps	A	0...9.999E15
68	4	Real	I2Current	I2 true RMS amps	A	0...9.999E15
72	4	Real	I3Current	I3 true RMS amps	A	0...9.999E15
76	4	Real	I4Current	I4 true RMS amps	A	0...9.999E15
80	4	Real	IAvgCurrent	Average I1, I2 and I3 amps.	A	0...9.999E15
84	4	Real	LineFreq	Last Line Frequency Calculated.	Hz	0.0...70.0
88	4	Real	Total_kW	L1, L2 and L3 kW Total.	kW	-9.999E15...9.999E15
92	4	Real	Total_kVAR	L1, L2 and L3 kVAR Total.	kVAR	-9.999E15...9.999E15
96	4	Real	Total_kVA	L1, L2 and L3 kVA Total.	kVA	0...9.999E15
100	4	Real	TotalTruePF	Total L1, L2 and L3 True Power Factor.	%	0.00...100.00
104	4	Real	TotalDisplacementPF	Total of L1, L2 and L3 Displacement Power Factor.	%	0.00...100.00
108	4	Real	AvgTHD_VToVN_IEEE	Average V1/V2/V3 to N IEEE Total Harmonic Distortion	%	0.00...100.00
112	4	Real	AvgTHD_VToV_IEEE	Average IEEE THD for V1-V2, V2-V3, V3-V1	%	0.00...100.00
116	4	Real	AvgTHD_Current_IEEE	Average I1/I2/I3 IEEE Total Harmonic Distortion	%	0.00...100.00
120	4	Real	AvgTHD_VToVN_IEC	Average V1/V2/V3 to N IEC Total Harmonic Distortion	%	0.00...100.00
124	4	Real	AvgTHD_VToV_IEC	Average IEC THD for V1-V2, V2-V3, V3-V1	%	0.00...100.00
128	4	Real	AvgTHD_Current_IEC	Average I1/I2/I3 IEC Total Harmonic Distortion	%	0.00...100.00
132	4	Real	VoltagePercentUnbalance	Voltage percent unbalance	%	0.00...100.00
136	4	Real	CurrentPercentUnbalance	Current percent unbalance	%	0.00...100.00
140	4	Real	S1ScaledCount_xM	Status 1 count times 1000000	xM	0...9,999,999
144	4	Real	S1ScaledCount_x1	Status 1 count times 1	x1	0...999,999
148	4	Real	S2ScaledCount_xM	Status 2 count times 1000000	xM	0...9,999,999

**Table 41 - ScheduledData.Input Data Table (continued)**

Start Byte	Size	Type	Tag Name	Description	Units	Range
152	4	Real	S2ScaledCount_x1	Status 2 count times 1	x1	0...999,999
156	4	Real	S3ScaledCount_xM	Status 3 count times 1000000	xM	0...9,999,999
160	4	Real	S3ScaledCount_x1	Status 3 count times 1	x1	0...999,999
164	4	Real	S4ScaledCount_xM	Status 4 count times 1000000	xM	0...9,999,999
168	4	Real	S4ScaledCount_x1	Status 4 count times 1	x1	0...999,999
172	4	Real	GWh	Net gigaWatt hours	GWh	+/- 0...9,999,999
176	4	Real	kWh	Net kiloWatt hours	kWh	+/- 0.000...999,999
180	4	Real	GVARh	Net gigaVAR hours	GVARh	+/- 0...9,999,999
184	4	Real	kVARh	Net kiloVAR hours	kVARh	+/- 0.000...999,999
188	4	Real	GVAh	Total gigaVA hours	GVAh	0.000...9,999,999
192	4	Real	kVAh	Total kiloVA hours	kVAh	0.000...999,999
196	4	Real	GAh	Total giga Ampere hours	GAh	0.000...9,999,999
200	4	Real	kAh	Total kilo Ampere hours	kAh	0.000...999,999
204	4	Real	Demand_kW	The average real power during the last demand period.	kW	+/- 0.000...9,999,999
208	4	Real	Demand_kVAR	The average reactive power during the last demand period.	kVAR	+/- 0.000...9,999,999
212	4	Real	Demand_kVA	The average apparent power during the last demand period.	kVA	0.000...9,999,999
216	4	Real	Demand_PF	The average PF during the last demand period.	%	-100.0...100.0
220	4	Real	Demand_I	The average amperes during the last demand period.	A	0.000...9,999,999
224	4	Real	ProjectedDemand_kW	The projected total real power for the current demand period.	kW	+/- 0.000...9,999,999
228	4	Real	ProjectedDemand_kVAR	The projected total reactive power for the current demand period.	kVAR	+/- 0.000...9,999,999
232	4	Real	ProjectedDemand_kVA	The projected total apparent power for the current demand period.	kVA	0.000...9,999,999
236	4	Real	ProjectedDemand_I	The projected total amperes for the current demand period.	A	0.000...9,999,999

## ScheduledData.Output

Table 42 - Table Properties

<b>CIP Instance Number</b>	101
<b>No. of Elements</b>	1
<b>Length in Words</b>	2
<b>Data Type</b>	DWORD
<b>Data Access</b>	Write Only

Table 43 - ScheduledData.Output Data Table

Start Byte	Size	Type	Tag Name	Description	Range
0	4	DWORD	RelayOut		0...15
		Bit 0	Energize KYZ	1 = Energize; 0 = de-energize	0 or 1
		Bit 1	R1	1 = Energize; 0 = de-energize	0 or 1
		Bit 2	R2	1 = Energize; 0 = de-energize	0 or 1
		Bit 3	R3	1 = Energize; 0 = de-energize	0 or 1
		Bit 4...31	Reserved	Future Use	0 or 1

## Configuration.Instance




**Table 44 - Table Properties**

<b>CIP</b>	102
<b>No. of Elements</b>	44
<b>Length in Words</b>	80
<b>Data Type</b>	Varies
<b>Data Access</b>	Read/Write

**Table 45 - Configuration.Instance Data Table**

Start Byte	Size	Type	Tag Name	Description	Units	Range
0	1	SINT	MeterMode	Configures the input wiring for metering. 0 = Demo 1 = Split Phase 2 = Wye 3 = Delta 2 CT 4 = Delta 3 CT 5 = Open Delta 2 CT 6 = Open Delta 3 CT 7 = Delta Gnd B Ph 2 CT 8 = Delta Gnd B Ph 3 CT 9 = Delta High Leg 10 = Single Phase	Mode	0...10
	1	SINT	Pad01	For alignment purpose		
	2	INT	Pad02	For alignment purpose		
4	4	Real	VLinePTPrimary	The primary voltage value of the PT transformer	V	0...1,000,000
8	4	Real	VLinePTSecondary	The secondary voltage value of the PT transformer	V	0...690
12	4	Real	ILineCTPrimary	The primary ampere value of the CT transformer	A	0...1,000,000
16	1	SINT	ILineCTSecondary	The secondary ampere value of the CT transformer	A	5
	1	SINT	Pad03	For alignment purpose		
	2	INT	Pad04	For alignment purpose		
20	4	Real	VNPTPrimary	The primary voltage value of the PT transformer	V	0...1,000,000
24	4	Real	VNPTSecondary	The secondary voltage value of the PT transformer	V	0...690
28	4	Real	I4CTPrimary	The primary ampere value of the CT transformer	A	0...1,000,000
32	1	SINT	I4CTSecondary	The secondary ampere value of the CT transformer	A	5
	1	SINT	Pad05	For alignment purpose		
	2	INT	Pad06	For alignment purpose		
36	4	Real	NominalVToVVoltage	Nominal voltage value or voltage rating of the system being metered.	V	0...1,000,000
40	4	DINT	Pad07	For alignment purpose	N/A	0...0
44	4	Real	NominalFreq	Nominal frequency of the system. 50 = 50 Hertz 60 = 60 Hertz	Hertz	50 or 60

Table 45 - Configuration.Instance Data Table (continued)

Start Byte	Size	Type	Tag Name	Description	Units	Range
48	1	SINT	RealTimeUpdateRate	Selects the update rate for the realtime table and the setpoint calculations. 0 = Single cycle averaged over 8 cycles 1 = Single cycle averaged over 4 cycles 2 = 1 cycle with no averaging	Meter Averaging	0...2
	1	SINT	Pad08	For alignment purpose		
	2	INT	Pad09	For alignment purpose		
52	2	Int16	DeviceFaultAction	This parameter determines the action when a unit error occurs. 0 = Halt on error and make status indicator solid red 1 = Reset power monitor hardware	Error Action	0...1
54	2	Int16	EnergyLogInterval	Selects how often a record is logged (minutes). A value of 0 disables periodic logging of records. A value of -1 causes the logging of records to be synchronized to the end of the demand Interval.	Energy Interval (Minutes)	-1...60
56	2	Int16	EnergyLogMode	This parameter sets the action of the log once the log has filled to capacity. 0 = Fill and Stop 1 = Overwrite oldest record.	Energy Log Mode	0...1
58	2	Int16	TOU AutoStoreDay	Automatically stores the current record for the month replacing an older record if the log is full. The log holds 12 records plus the current record. 0 = Disable storing records 1 = Store and clear on the first day of the month 2 = 2nd of month 3 = 3rd day of month ... 31 = 31st day of month If set to 29...31 the last day of every month stores a record.	AutoStore	0...31
60 	1	SINT	DemandSource	When item 'Demand Broadcast Master Select' of the Ethernet table is set to a master selection of 0...2 sets the type of master input. In this case item '3' is ignored. When the 'Demand Broadcast Master Select' of the Ethernet table is set to slave, then any of these inputs can set the end of the demand period. 0 = Internal Timer 1 = Status Input 2 2 = Controller Command 3 = Ethernet Demand Broadcast	Demand Period Length	0...3
	1	SINT	Pad10	For alignment purpose		
	2	INT	Pad11	For alignment purpose		
64 	1	SINT	DemandPeriodLength	Specifies the desired period for demand calculations. When set to 0 there is no projected demand calculations. If the internal timer is selected a setting of 0 turns the demand function off.	Number Demand Periods	0...99
	1	SINT	Pad12	For alignment purpose		
	2	INT	Pad13	For alignment purpose		
68 	1	SINT	NumberOfDemandCycles	Specifies the number of demand periods to average for demand measurement.	Demand Sync Delay	1...15
	1	SINT	Pad14	For alignment purpose		
	2	INT	Pad15	For alignment purpose		

**Table 45 - Configuration.Instance Data Table (continued)**







Start Byte	Size	Type	Tag Name	Description	Units	Range
72 	2	Int16	ForcedDemandSyncDelay	When the power monitor is configured for external demand control the unit delays for xxx seconds after the expected control pulse has not been received. The demand period starts over and a record is recorded in the event log 0 = Wait forever 1...900 = Wait this many seconds before starting a new demand period. <b>IMPORTANT:</b> This setting becomes active when an external input is used to end the demand period.	Demand Broadcast Mode	0...900
	2	INT	Pad16	For alignment purpose		
76	1	SINT	DemandBroadcastMode	Demand Ethernet broadcast selection. 0 = Slave 1 = Master <b>IMPORTANT:</b> There can be only one master per demand network.	Demand Broadcast Mode	0...1
	1	SINT	Pad17	For alignment purpose		
78	2	Int16	DemandBroadcastPort	The common port for demand broadcast messages.	Demand Broadcast Port	300...400
80 	1	SINT	KYZOutputMode	The parameter selected pulses the KYZ output at a rate that equals the parameter value divided by KYZ scale. 0 = Setpoint Control 1 = Wh Fwd 2 = Wh Rev 3 = VARh Fwd 4 = VARh Rev 5 = VAh 6 = Ah	KYZ Output Parameter	0...6
	1	SINT	Pad18	For alignment purpose		
	2	INT	Pad19	For alignment purpose		
84 	4	Int32	KYZPulseScale	The KYZ output parameter divided by the scale is the output pulse rate. Example: Wh is selected for the parameter and 1,000 is the scale value. The output is pulsed every kWh.	KYZ Output Scale	1...100,000
88 	2	Int16	KYZPulseDuration	Set as 50...1000 to indicate the duration of the pulse in milliseconds, or set to 0 for KYZ-style transition output. (Toggle) <b>IMPORTANT:</b> The value for delay is rounded off to the nearest 10 ms internally during this function.	KYZ Output Duration	0 or 50...1000
	2	INT	Pad20	For alignment purpose		
92 	1	SINT	R1OutputMode	The parameter selected pulses the relay 1 output at a rate that equals the parameter value divided by relay 1 scale. 0 = Setpoint Control 1 = Wh Fwd 2 = Wh Rev 3 = VARh Fwd 4 = VARh Rev 5 = VAh 6 = Ah	Relay 1 Output Parameter	0...6
	1	SINT	Pad21	For alignment purpose		
	2	INT	Pad22	For alignment purpose		
96 	4	Int32	R1PulseScale	The relay 1 output parameter divided by the relay 1 scale is the output pulse rate. Example: Wh is selected for the parameter and 1,000 is the scale value. The output is pulsed every kWh.	Relay 1 Output Scale	1...100,000

Table 45 - Configuration.Instance Data Table (continued)

Start Byte	Size	Type	Tag Name	Description	Units	Range
100 🔒	2	Int16	R1PulseDuration	Set as 50...1000 to indicate the duration of the pulse in milliseconds, or set to 0 for KYZ-style transition output. (Toggle) <b>IMPORTANT:</b> The value for delay is rounded off to the nearest 10 ms internally during this function.	Relay 1 Output Duration	0 or 50...1000
	2	INT	Pad23	For alignment purpose		
104 🔒	1	SINT	R2OutputMode	The parameter selected pulses the relay 2 output at a rate that equals the parameter value divided by relay 2 scale. 0 = Setpoint Control 1 = Wh Fwd 2 = Wh Rev 3 = VARh Fwd 4 = VARh Rev 5 = VAh 6 = Ah	Relay 2 Output Parameter	0...6
	1	SINT	Pad24	For alignment purpose		
	2	INT	Pad25	For alignment purpose		
108 🔒	4	Int32	R2PulseScale	The relay 2 output parameter divided by the relay 2 scale is the output pulse rate. Example: Wh is selected for the parameter and 1,000 is the scale value. The output is pulsed every kWh.	Relay 2 Output Scale	1...100,000
112 🔒	2	Int16	R2PulseDuration	Set as 50...1000 to indicate the duration of the pulse in milliseconds, or set to 0 for KYZ-style transition output. (Toggle) <b>IMPORTANT:</b> The value for delay is rounded off to the nearest 10 ms internally during this function.	Relay 2 Output Duration	0 or 50...1000
	2	INT	Pad26	For alignment purpose		
116 🔒	1	SINT	R3OutputMode	The parameter selected pulses the relay 3 output at a rate that equals the parameter value divided by relay 3 scale. 0 = Setpoint Control 1 = Wh Fwd 2 = Wh Rev 3 = VARh Fwd 4 = VARh Rev 5 = VAh 6 = Ah	Relay 3 Output Parameter	0...6
	1	SINT	Pad27	For alignment purpose		
	2	INT	Pad28	For alignment purpose		
120 🔒	4	Int32	R3PulseScale	The relay 3 output parameter divided by the relay 3 scale is the output pulse rate. Example: Wh is selected for the parameter and 1,000 is the scale value. The output is pulsed every kWh.	Relay 3 Output Scale	1...100,000
124 🔒	2	Int16	R3PulseDuration	Set as 50...1000 to indicate the duration of the pulse in milliseconds, or set to 0 for KYZ-style transition output. (Toggle) <b>IMPORTANT:</b> The value for delay is rounded off to the nearest 10 ms internally during this function.	Relay 3 Output Duration	0 or 50...1000
	2	INT	Pad29	For alignment purpose		
128 🔒	4	Int32	S1ScaleFactor	When a status pulse is received the count is increased by the scale factor. (Input pulse * input scale) added to total status count.	Status 1 Input Scaling	1...1,000,000
132 🔒	4	Int32	S2ScaleFactor	When a status pulse is received the count is increased by the scale factor. (Input pulse * input scale) added to total status count.	Status 2 Input Scaling	1...1,000,000
136 🔒	4	Int32	S3ScaleFactor	When a status pulse is received the count is increased by the scale factor. (Input pulse * input scale) added to total status count.	Status 3 Input Scaling	1...1,000,000
140 🔒	4	Int32	S4ScaleFactor	When a status pulse is received the count is increased by the scale factor. (Input pulse * input scale) added to total status count.	Status 4 Input Scaling	1...1,000,000



**Table 45 - Configuration.Instance Data Table (continued)**

Start Byte	Size	Type	Tag Name	Description	Units	Range
144	1	SINT	KYZCommFaultMode	The Default output state on communication loss defines the behavior of the output if the power monitor experiences a loss of communication. 0 = Last state/resume 1 = Last state/freeze 2 = De-energize/resume 3 = De-energize/freeze 4 = Local Control	N/A	0...4
	1	SINT	Pad30	For alignment purpose		
	2	INT	Pad31	For alignment purpose		
148	1	SINT	R1CommFaultMode	The Default output state on communication loss defines the behavior of the output if the power monitor experiences a loss of communication. 0 = Last state/resume 1 = Last state/freeze 2 = De-energize/resume 3 = De-energize/freeze 4 = Local Control	N/A	0...4
	1	SINT	Pad32	For alignment purpose		
	2	INT	Pad33	For alignment purpose		
152	1	SINT	R2CommFaultMode	The Default output state on communication loss defines the behavior of the output if the power monitor experiences a loss of communication. 0 = Last state/resume 1 = Last state/freeze 2 = De-energize/resume 3 = De-energize/freeze 4 = Local Control	N/A	0...4
	1	SINT	Pad34	For alignment purpose		
	2	INT	Pad35	For alignment purpose		

Table 45 - Configuration.Instance Data Table (continued)

Start Byte	Size	Type	Tag Name	Description	Units	Range
156	1	SINT	R3CommFaultMode	The Default output state on communication loss defines the behavior of the output if the power monitor experiences a loss of communication. 0 = Last state/resume 1 = Last state/freeze 2 = De-energize/resume 3 = De-energize/freeze 4 = Local Control	N/A	0...4
	1	SINT	Pad36	For alignment purpose		
	2	Int16	CmdWordOne	These commands can be sent to the power monitor. When using the optional elements the command table must be sent complete with all elements present. If the single password table is used to gain access to configuration items then the command can be sent alone without optional settings. The command options are: 0 = No Action 1 = Set kWh Register 2 = Set kVARh Register 3 = Set kVAh Register 4 = Set kAh Register 5 = Clear All Energy Registers 6 = Set Status 1 Count 7 = Set Status 2 Count 8 = Set Status 3 Count 9 = Set Status 4 Count 10 = Force KYZ Output On 11 = Force KYZ Output Off 12 = Remove Force from KYZ 13 = Force Relay 1 Output On 14 = Force Relay 1 Output Off 15 = Remove Force from Relay 1 16 = Force Relay 2 Output On 17 = Force Relay 2 Output Off 18 = Remove Force from Relay 2 19 = Force Relay 3 Output On 20 = Force Relay 3 Output Off 21 = Remove Force from Relay 3 22 = Restore Factory Defaults 23 = Reset Powermonitor System 24 = Reserved for future use. <b>IMPORTANT:</b> If a command is received that is not supported by your catalog number, the command is ignored.	N/A	0...23

## Configuration Parameter Object Table

**Table 46 - Table Properties**

<b>CIP Class Code</b>	0x0F
<b>No. of Parameters</b>	52
<b>Data Type</b>	Varies
<b>Data Access</b>	Read/Write

**TIP** See [Table 45 Configuration.Instance Data Table](#) for descriptions of each parameter.

**Table 47 - Configuration Parameter Object Table**

Instance Number	Parameter Object Name	Type	Units	Range	Default Value
1	Metering_Mode	SINT	N/A	0...10	2
2	V1_V2_V3_PT_Primary	Real	V	0...1,000,000	480
3	V1_V2_V3_PT_Secondary	Real	V	0...690	480
4	I1_I2_I3_CT_Primary	Real	A	0...1,000,000	5
5	I1_I2_I3_CT_Secondary	SINT	A	5	5
6	VN_PT_Primary	Real	V	0...1,000,000	480
7	VN_PT_Secondary	Real	V	0...690	480
8	I4_CT_Primary	Real	A	0...1,000,000	5
9	I4_CT_Secondary	SINT	A	5	5
10	Nominal_System_LL_Voltage	Real	V	0...1,000,000	480
11	Reserved	Real	N/A	0	0
12	Nominal_System_Frequency	Real	Hz	50 or 60	60
13	Realtime_Update_Rate	SINT	N/A	0...2	0
14	Date_Year	Int16	Year	2010...2100	2010
15	Date_Month	Int16	Mon	1...12	1
16	Date_Day	Int16	Day	1...31	1
17	Time_Hour	Int16	Hour	0...23	0
18	Time_Minute	Int16	Min	0...59	0
19	Time_Seconds	Int16	Sec	0...59	0
20	Time_Milliseconds	Int16	Mise	0...999	0
21	Unit_Error_Action	Int16	N/A	0...1	1
22	Energy_Log_Interval	Int16	N/A	-1...60	15
23	Energy_Log_Mode	Int16	N/A	0...1	1
24	Time_Of_Use_AutoStore	Int16	N/A	0...31	31
25	Demand_Source	SINT	N/A	0...3	0
26	Demand_Period_Length	SINT	N/A	0...99	15
27	Number_Demand_Periods	SINT	N/A	1...15	1
28	Forced_Demand_Sync_Delay	Int16	N/A	0...900	10

Table 47 - Configuration Parameter Object Table (continued)

Instance Number	Parameter Object Name	Type	Units	Range	Default Value
29	Demand_Broadcast_Mode_Select	SINT	N/A	0...1	0
30	Demand_Broadcast_Port	Int16	N/A	300...400	300
31	KYZ_Solid_State_Output_Parameter	SINT	N/A	0...6	0
32	KYZ_Solid_State_Output_Scale	Int32	N/A	1...100,000	1000
33	KYZ_Pulse_Duration_Setting	Int16	N/A	0 or 50...1000	250
34	Output_Relay_1_Output_Parameter	SINT	N/A	0...6	0
35	Output_Relay_1_Output_Scale	Int32	N/A	1...100,000	1000
36	Output_Relay_1_Pulse_Duration_Setting	Int16	N/A	0 or 50...1000	250
37	Output_Relay_2_Output_Parameter	SINT	N/A	0...6	0
38	Output_Relay_2_Output_Scale	Int32	N/A	1...100,000	1000
39	Output_Relay_2_Pulse_Duration_Setting	Int16	N/A	0 or 50...1000	250
40	Output_Relay_3_Output_Parameter	SINT	N/A	0...6	0
41	Output_Relay_3_Output_Scale	Int32	N/A	1...100,000	1000
42	Output_Relay_3_Pulse_Duration_Setting	Int16	N/A	0 or 50...1000	250
43	Status_Input_1_Input_Scale	Int32	N/A	1...1,000,000	1
44	Status_Input_2_Input_Scale	Int32	N/A	1...1,000,000	1
45	Status_Input_3_Input_Scale	Int32	N/A	1...1,000,000	1
46	Status_Input_4_Input_Scale	Int32	N/A	1...1,000,000	1
47	Default_KYZ_State_On_Comm_Loss	SINT	N/A	0...4	0
48	Default_Relay_1_State_On_Comm_Loss	SINT	N/A	0...4	0
49	Default_Relay_2_State_On_Comm_Loss	SINT	N/A	0...4	0
50	Default_Relay_3_State_On_Comm_Loss	SINT	N/A	0...4	0
51	Clear Energy Counters	Int16	N/A	0...1	0
52	Clear Energy log	Int16	N/A	0...1	0

## Display Parameter Object Table

**Table 48 - Table Properties**

<b>CIP Class Code</b>	0x0F
<b>No. of Parameters</b>	117
<b>Data Type</b>	Varies
<b>Data Access</b>	Read Only

**Table 49 - Display Parameter Object Table**

Instance Number	Parameter Object Name	Type	Units	Description
53	V1_N_Volts	Real	V	V1 to N true RMS voltage
54	V2_N_Volts	Real	V	V2 to N true RMS voltage
55	V3_N_Volts	Real	V	V3 to N true RMS voltage
56	VGN_N_Volts	Real	V	VGN to N true RMS voltage
57	Avg_V_N_Volts	Real	V	Average of V1, V2 and V3
58	V1_V2_Volts	Real	V	V1 to V2 true RMS voltage
59	V2_V3_Volts	Real	V	V2 to V3 true RMS voltage
60	V3_V1_Volts	Real	V	V3 to V1 true RMS voltage
61	Avg_VL_VL_Volts	Real	V	Average of V1_V2, V2_V3 and V3_V1
62	I1_Amps	Real	A	I1 true RMS amps
63	I2_Amps	Real	A	I2 true RMS amps
64	I3_Amps	Real	A	I3 true RMS amps
65	I4_Amps	Real	A	I4 true RMS amps
66	Avg_Amps	Real	A	Average I1, I2 and I3 amps
67	Frequency_Hz	Real	Hz	Last Line Frequency Calculated
68	L1_kW	Real	kW	L1 real power
69	L2_kW	Real	kW	L2 real power
70	L3_kW	Real	kW	L3 real power
71	Total_kW	Real	kW	Total real power
72	L1_kVAR	Real	kVAR	L1 reactive power
73	L2_kVAR	Real	kVAR	L2 reactive power
74	L3_kVAR	Real	kVAR	L3 reactive power
75	Total_kVAR	Real	kVAR	Total reactive power
76	L1_kVA	Real	kVA	L1 apparent power
77	L2_kVA	Real	kVA	L2 apparent power
78	L3_kVA	Real	kVA	L3 apparent power
79	Total_kVA	Real	kVA	Total apparent power
80	L1_True_PF_%	Real	%	L1 true power factor (full bandwidth)
81	L2_True_PF_%	Real	%	L2 true power factor (full bandwidth)
82	L3_True_PF_%	Real	%	L3 true power factor (full bandwidth)
83	Total_True_PF	Real	%	Total true power factor

Table 49 - Display Parameter Object Table (continued)

Instance Number	Parameter Object Name	Type	Units	Description
84	L1_Displ_PF	Real	%	L1 displacement power factor (fundamental only)
85	L2_Displ_PF	Real	%	L2 displacement power factor (fundamental only)
86	L3_Displ_PF	Real	%	L3 displacement power factor (fundamental only)
87	Total_Displ_PF	Real	%	Total displacement power factor (fundamental only)
88	V1_Crest_Factor	Real	-	V1 crest factor
89	V2_Crest_Factor	Real	-	V2 crest factor
90	V3_Crest_Factor	Real	-	V3 crest factor
91	I1_Crest_Factor	Real	-	I1 crest factor
92	I2_Crest_Factor	Real	-	I2 crest factor
93	I3_Crest_Factor	Real	-	I3 crest factor
94	I4_Crest_Factor	Real	-	I4 crest factor
95	V1_IEEE_THD_%	Real	%	V1-N IEEE Total Harmonic Distortion
96	V2_IEEE_THD_%	Real	%	V2-N IEEE Total Harmonic Distortion
97	V3_IEEE_THD_%	Real	%	V3-N IEEE Total Harmonic Distortion
98	VN_G_IEEE_THD_%	Real	%	VN-G IEEE Total Harmonic Distortion
99	Avg_IEEE_THD_V_%	Real	%	Average V1/V2/V3 to N IEEE Total Harmonic Distortion
100	I1_IEEE_THD_%	Real	%	I1 IEEE Total Harmonic Distortion
101	I2_IEEE_THD_%	Real	%	I2 IEEE Total Harmonic Distortion
102	I3_IEEE_THD_%	Real	%	I3 IEEE Total Harmonic Distortion
103	I4_IEEE_THD_%	Real	%	I4 IEEE Total Harmonic Distortion
104	Avg_IEEE_THD_I_%	Real	%	Average I1/I2/I3 IEEE Total Harmonic Distortion
105	V1_IEC_THD_%	Real	%	V1-N IEC Total Harmonic Distortion
106	V2_IEC_THD_%	Real	%	V2-N IEC Total Harmonic Distortion
107	V3_IEC_THD_%	Real	%	V3-N IEC Total Harmonic Distortion
108	VN_G_IEC_THD_%	Real	%	VN-G IEC Total Harmonic Distortion
109	Avg_IEC_THD_V_%	Real	%	Average V1/V2/V3 to N IEC Total Harmonic Distortion
110	I1_IEC_THD_%	Real	%	I1 IEC Total Harmonic Distortion
111	I2_IEC_THD_%	Real	%	I2 IEC Total Harmonic Distortion
112	I3_IEC_THD_%	Real	%	I3 IEC Total Harmonic Distortion
113	I4_IEC_THD_%	Real	%	I4 IEC Total Harmonic Distortion
114	Avg_IEC_THD_I_%	Real	%	Average I1/I2/I3 IEC Total Harmonic Distortion
115	Pos_Seq_Volts	Real	V	Positive Sequence Voltage
116	Neg_Seq_Volts	Real	V	Negative Sequence Voltage
117	Zero_Seq_Volts	Real	V	Zero Sequence Voltage
118	Pos_Seq_Amps	Real	A	Positive Sequence Amps
119	Neg_Seq_Amps	Real	A	Negative Sequence Amps
120	Zero_Seq_Amps	Real	A	Zero Sequence Amps
121	Voltage_Unbalance_%	Real	%	Voltage percent unbalance
122	Current_Unbalance_%	Real	%	Current percent unbalance

**Table 49 - Display Parameter Object Table (continued)**

Instance Number	Parameter Object Name	Type	Units	Description
123	Status_1_Count_xM	Real	xM	Status 1 Count times 1,000,000
124	Status_1_Count_x1	Real	x1	Status 1 count times 1
125	Status_2_Count_xM	Real	xM	Status 2 Count times 1,000,000
126	Status_2_Count_x1	Real	x1	Status 2 count times 1
127	Status_3_Count_xM	Real	xM	Status 3 Count times 1,000,000
128	Status_3_Count_x1	Real	x1	Status 3 count times 1
129	Status_4_Count_xM	Real	xM	Status 4 Count times 1,000,000
130	Status_4_Count_x1	Real	x1	Status 4 count times 1
131	GWh_Fwd	Real	GWh	Forward gigawatt hours
132	kWh_Fwd	Real	kWh	Forward kilowatt hours
133	GWh_Rev	Real	GWh	Reverse gigawatt hours
134	kWh_Rev	Real	kWh	Reverse kilowatt hours
135	GWh_Net	Real	GWh	Net gigawatt hours
136	kWh_Net	Real	kWh	Net kilowatt hours
137	GVARH_Fwd	Real	GVARh	Forward gigaVAR hours
138	kVARh_Fwd	Real	kVARh	Forward kiloVAR hours
139	GVARH_Rev	Real	GVARh	Reverse gigaVAR hours
140	kVARh_Rev	Real	kVARh	Reverse kiloVAR hours
141	GVARH_Net	Real	GVARh	Net gigaVAR hours
142	kVARh_Net	Real	kVARh	Net kiloVAR hours
143	GVAh	Real	GVAh	Net gigaVA hours
144	kVAh	Real	kVAh	Net kiloVA hours
145	GAh	Real	GAh	Net giga Amp hours
146	kAh	Real	kAh	Net kilo Amp hours
147	kW_Demand	Real	kW	The average real power during the last demand period
148	kVAR_Demand	Real	kVAR	The average reactive power during the last demand period
149	kVA_Demand	Real	kVA	The average apparent power during the last demand period
150	Demand_PF	Real	PF	The average PF during the last demand period
151	Demand_Amps	Real	A	The average demand for amperes during the last demand period
152	Projected_kW_Demand	Real	kW	The projected total real power for the current demand period
153	Projected_kVAR_Demand	Real	kVAR	The projected total reactive power for the current demand period
154	Projected_kVA_Demand	Real	kVA	The projected total apparent power for the current demand period
155	Projected_Ampere_Demand	Real	A	The projected total amperes for the current demand period
156	Elapsed_Demand_Period_Time	Real	Min	The amount of time that has elapsed during the current demand period
157	I1_K_Factor	Real	-	I1 K-factor
158	I2_K_Factor	Real	-	I2 K-factor
159	I3_K_Factor	Real	-	I3 K-factor
160	IEEE_519_TDD_%	Real	%	Total Demand Distortion used for IEEE 519 Pass/Fail Status
161	Setpoints_1_10_Active	Int16	N/A	Actuation Status of Setpoints 1...10

**Table 49 - Display Parameter Object Table (continued)**

Instance Number	Parameter Object Name	Type	Units	Description
162	Setpoints_11_20_Active	Int16	N/A	Actuation Status of Setpoints 11...20
163	Logic_Level_1_Gates_Active	Int16	N/A	Actuation Status of Level 1 Gates
166	Metering_Status	Int16	N/A	Metering Conditions Status
167	Over_Range_Information	Int16	N/A	Indicates which input is over range
168	PowerQuality_Status	Int16	N/A	Power Quality Conditions Status
169	Logs_Status	Int16	N/A	Logs Condition Status

### Configuration.DateTime

**Table 50 - Table Properties**

<b>CIP Instance Number</b>	800
<b>PCCC File Number</b>	N9
<b>No. of Elements</b>	15
<b>Length in Words</b>	15
<b>Data Type</b>	Int16
<b>Data Access</b>	Read/Write

**Table 51 - Configuration.DateTime Data Table**

Element Number	Type	Tag Name	Description	Default	Range
0	Int16	Date_Year	The current year	2010	1970...2100
1	Int16	Date_Month	The current month	1	1...12
2	Int16	Date_Day	The current day	1	1...31
3	Int16	Time_Hour	The current hour	0	0...23
4	Int16	Time_Minute	The current minute of the day	0	0...59
5	Int16	Time_Seconds	The current seconds	0	0...59
6	Int16	Time_Milliseconds	The current milliseconds	0	0...999
7...14	Int16	Reserved		0	0



## Configuration.Logging

**Table 52 - Table Properties**

<b>CIP Instance Number</b>	801
<b>PCCC File Number</b>	N10
<b>No. of Elements</b>	40
<b>Length in Words</b>	40
<b>Data Type</b>	Int16
<b>Data Access</b>	Read/Write

**Table 53 - Configuration.Logging Data Table**

Element Number	Type	Tag Name	Description	Default	Range
0	Int16	Energy_Log_Interval	Selects how often a record is logged (minutes). A value of 0 disables periodic logging of records. A value of -1 causes the logging of records to be synchronized to the end of the demand Interval.	15	-1...60
1	Int16	Energy_Log_Mode	This parameter sets the action of the log once the log has filled to capacity. 0 = Fill and Stop 1 = Overwrite oldest record	1	0...1
2	Int16	Setpoint_Log_Mode	This parameter sets the action of the log once the log has filled to capacity. 0 = Fill and Stop 1 = Overwrite oldest record	1	0...1
3	Int16	Time_Of_Use_AutoStore	Automatically stores the current record for the month replacing an older record if the log is full. The log holds 12 records plus the current record. 0 = Disable storing records 1 = Store and clear on the first day of the month 2 = 2nd of month 3 = 3rd day of month... to 31st day If set to 29...31 the last day of every month stores a record.	31	0...31
4	Int16	Off_Peak_Days	This bit map field selects the off peak days. OFF-PEAK days have only one rate for billing. Bit0 = Sunday Bit1 = Monday Bit2 = Tuesday Bit3 = Wednesday Bit4 = Thursday Bit5 = Friday Bit 6 = Saturday <b>IMPORTANT:</b> Saturday and Sunday are default days.	65	0...127
5	Int16	MID_Peak_AM_Hours	This bit map selects any a.m. hours that are designated as MID Peak. Bit0 = 12 a.m. to 1 a.m. Bit1 = 1 a.m. to 2 a.m. Bit2 = 2 a.m. to 3 a.m. Bit 3 = 3 a.m. to 4 a.m. ... Bit11 = 11 a.m. to 12 a.m. Example: The hours from 8 a.m. to 11 a.m. is designated as Bit 8 through Bit 10 = 1792d.	1792	0...4095

**Table 53 - Configuration.Logging Data Table (continued)**

Element Number	Type	Tag Name	Description	Default	Range
6	Int16	MID_Peak_PM_Hours	This bit map selects any p.m. hours that are designated as MID Peak. Bit0 = 12 p.m. to 1 p.m. Bit1 = 1 p.m. to 2 p.m. Bit2 = 2 p.m. to 3 p.m. Bit 3 = 3 p.m. to 4 p.m. ... Bit11 = 11 p.m. to 12 p.m. Example: The hours from 3 p.m. to 7 p.m. is designated as Bit 3 through Bit 6 = 120d.	120	0...4095
7	Int16	ON_Peak_AM_Hours	This bit map selects any a.m. hours that are designated as ON Peak. Bit0 = 12 a.m. to 1 a.m. Bit1 = 1 a.m. to 2 a.m. Bit2 = 2 a.m. to 3 a.m. Bit 3 = 3 a.m. to 4 a.m. ... Bit11 = 11 a.m. to 12 a.m. Example: The hours from 11 a.m. to 12 p.m. is designated as Bit 11 = 2048d.	2048	0...4095
8	Int16	ON_Peak_PM_Hours	This bit map selects any p.m. hours that are designated as ON Peak. Bit0 = 12 p.m. to 1 p.m. Bit1 = 1 p.m. to 2 p.m. Bit2 = 2 p.m. to 3 p.m. Bit 3 = 3 p.m. to 4 p.m. ... Bit11 = 11 p.m. to 12 p.m. Example: The hours from 12 p.m. to 3 p.m. is designated as Bit 0 through Bit 2 = 7d .	7	0...4095
9	Int16	Load_Factor_Auto_Log_Setting	Automatically stores the current peak, average and load factor results as a record in the non volatile load factor log and resets the log at the specified day of the month. 0 = Disable storing records 1 = Store and clear on the first day of the month 2 = 2nd of month 3 = 3rd day of month... to 31st day If set to 29...31 the last day of every month stores a record.	31	0...31
10	Int16	PowerQuality_Log_Mode	This parameter sets the action of the log once the log has filled to capacity. 0 = Fill and Stop 1 = Overwrite oldest record	1	0...1
11	Int16	Event_Log_Mode	This parameter sets the action of the log once the log has filled to capacity. 0 = Fill and Stop 1 = Overwrite oldest record	1	0...1
12...39	Int16	Reserved		0	0

## Configuration.Metering.Basic




**Table 54 - Table Properties**

<b>CIP Instance Number</b>	802
<b>PCCC File Number</b>	F11
<b>No. of Elements</b>	33
<b>Length in Words</b>	66
<b>Data Type</b>	Real
<b>Data Access</b>	Read/Write

**Table 55 - Configuration.Metering.Basic Data Table**

Element Number	Type	Tag Name	Description	Default	Range
0	Real	Metering_Mode	Configures the input wiring for metering. 0 = Demo 1 = Split-phase 2 = Wye 3 = Delta 2 CT 4 = Delta 3 CT 5 = Open Delta 2 CT 6 = Open Delta 3 CT 7 = Delta Gnd B Ph 2 CT 8 = Delta Gnd B Ph 3 CT 9 = Delta High Leg 10 = Single Phase	2	0...10
1	Real	V1_V2_V3_PT_Primary	The primary voltage value of the PT transformer.	480	0...1,000,000
2	Real	V1_V2_V3_PT_Secondary	The secondary voltage value of the PT transformer.	480	0...690
3	Real	I1_I2_I3_CT_Primary	The primary ampere value of the CT transformer.	5	0...1,000,000
4	Real	I1_I2_I3_CT_Secondary	The secondary ampere value of the CT transformer.	5	5
5	Real	VN_PT_Primary	The primary voltage value of the PT transformer.	480	0...1,000,000
6	Real	VN_PT_Secondary	The secondary voltage value of the PT transformer.	480	0...690
7	Real	I4_CT_Primary	The primary ampere value of the CT transformer.	5	0...1,000,000
8	Real	I4_CT_Secondary	The secondary ampere value of the CT transformer.	5	5
9	Real	Nominal_System_LL_Voltage	Nominal line to line voltage value or line to line voltage rating of the system being metered.	480	0...1,000,000
10	Real	Nominal_System_Frequency	Nominal frequency of the system.	60	50...60
11	Real	Realtime_Update_Rate	Selects the update rate for the realtime table and the setpoint calculations. 0 = Single cycle averaged over 8 cycles 1 = Single cycle averaged over 4 cycles 2 = 1 cycle with no averaging	0	0...2
12	Real	Demand_Source	When item 'Demand Broadcast Master Select' of the Ethernet table is set to master a selection of 0...2 and 4 sets the type of master input. In this case item 3 is ignored. When the 'Demand Broadcast Master Select' of the Ethernet table is set to slave then any of these inputs can set the end of the demand period. 0 = Internal Timer 1 = Status Input 2 2 = Controller Command 3 = Ethernet Demand Broadcast	0	0...3

**Table 55 - Configuration.Metering.Basic Data Table (continued)**

Element Number	Type	Tag Name	Description	Default	Range
13 	Real	Demand_Period_Length (Minutes)	Specifies the desired period for demand calculations. When set to 0 there is no projected demand calculations. If the internal timer is selected a setting of 0 turns the demand function off.	15	0...99
14 	Real	Number_Demand_Periods	Specifies the number of demand periods to average for demand measurement.	1	1...15
15 	Real	Forced_Demand_Sync_Delay	When the power monitor is configured for external demand control the unit delays for xxx seconds after the expected control pulse has not been received. The demand period starts over and a record is recorded in the event log. 0 = Wait forever 1...900 = Wait this many seconds before starting a new demand period <b>IMPORTANT:</b> This setting becomes active when an external input is used to end the demand period.	10	0...900
16...32	Real	Reserved		0	0

## Configuration.System.General

**Table 56 - Table Properties**

<b>CIP Instance Number</b>	803
<b>PCCC File Number</b>	F12
<b>No. of Elements</b>	50
<b>Length in Words</b>	100
<b>Data Type</b>	Real
<b>Data Access</b>	Read/Write

**Table 57 - Configuration.System.General Data Table**






Element Number	Type	Tag Name	Description	Default	Range
0	Real	Log_Status_Input_Changes	0=Disable recording of status input changes into the event log 1=Enable recording of event input changes into the event log	0	0...1
1	Real	Use_Daylight_Savings_Correction	0 = Disable Daylight Savings 1 = Enable Daylight Savings	0	0...1
2	Real	Daylight_Savings_Month/Week/Day_Start	This is the day that the power monitor adds an hour to the time. This feature also looks at Ethernet SNTP offset and corrects for Daylight Savings. Example: 040107 = April/1st week/Saturday Month Settings: 01 = January... 12 = December Week Settings: 01 = 1st week... 05 = Last Week Day of the Week Settings: 01 = Sunday... 07 = Saturday	030201 March, 2nd, Sunday	010101... 120507
3	Real	Hour_of_Day_Start	The hour of day the daylight savings adjustment is made to add an hour.	2	0...23
4	Real	Return_from_Daylight_Savings_Month/Week/Day	This is the day that the power monitor subtracts an hour from the time. This feature also looks at Ethernet SNTP offset and corrects for the return from Daylight Savings. Month Settings: 01 = January... 12 = December Week Settings: 01 = 1st week... 05 = Last Week Day of the Week Settings: 01 = Sunday... 07 = Saturday	110101 November, 1st, Sunday	010101... 120507
5	Real	Hour_of_Day_End	The hour of day the daylight savings adjustment is made to subtract an hour.	2	0...23
6 	Real	KYZ_Solid_State_Output_Parameter	The parameter selected pulses the KYZ output at a rate that equals the parameter value divided by KYZ scale. 0 = Setpoint Control 1 = Wh Fwd 2 = Wh Rev 3 = VARh Fwd 4 = VARh Rev 5 = VAh 6 = Ah	0	0...6

Table 57 - Configuration.System.General Data Table (continued)

Element Number	Type	Tag Name	Description	Default	Range
7	Real	KYZ_Solid_State_Output_Scale	The KYZ output parameter divided by the scale is the output pulse rate. Example: Wh is selected for the parameter and 1,000 is the scale value. The output is pulsed every kWh.	1,000	1... 100,000
8	Real	KYZ_Pulse_Duration_Setting	Set as 50...1000 to indicate the duration of the pulse in milliseconds, or set to 0 for KYZ-style transition output. (Toggle) <b>IMPORTANT:</b> The value for delay is rounded off to the nearest 10 ms internally during this function.	250 (ms)	0 or 50 ...1000
9	Real	Output_Relay_1_Output_Parameter	The parameter selected pulses the relay 1 output at a rate that equals the parameter value divided by relay 1 scale. 0 = Setpoint Control 1 = Wh Fwd 2 = Wh Rev 3 = VARh Fwd 4 = VARh Rev 5 = VAh 6 = Ah	0	0...6
10	Real	Output_Relay_1_Output_Scale	The relay 1 output parameter divided by the relay 1 scale is the output pulse rate. Example: Wh is selected for the parameter and 1,000 is the scale value. The output is pulsed every kWh.	1,000	1... 100,000
11	Real	Output_Relay_1_Pulse_Duration_Setting	Set as 50...1000 to indicate the duration of the pulse in milliseconds, or set to 0 for KYZ-style transition output. (Toggle) <b>IMPORTANT:</b> The value for delay is rounded off to the nearest 10 ms internally during this function.	250 (ms)	0 or 50 ...1000
12	Real	Output_Relay_2_Output_Parameter	The parameter selected pulses the relay 2 output at a rate that equals the parameter value divided by relay 2 scale. 0 = Setpoint Control 1 = Wh Fwd 2 = Wh Rev 3 = VARh Fwd 4 = VARh Rev 5 = VAh 6 = Ah	0	0...6
13	Real	Output_Relay_2_Output_Scale	The relay 2 output parameter divided by the relay 2 scale is the output pulse rate. Example: Wh is selected for the parameter and 1,000 is the scale value. The output is pulsed every kWh.	1,000	1... 100,000
14	Real	Output_Relay_2_Pulse_Duration_Setting	Set as 50...1000 to indicate the duration of the pulse in milliseconds, or set to 0 for KYZ-style transition output. (Toggle) <b>IMPORTANT:</b> the value for delay is rounded off to the nearest 10 ms internally during this function.	250 (ms)	0 or 50 ...1000
15	Real	Output_Relay_3_Output_Parameter	The parameter selected pulses the relay 3 output at a rate that equals the parameter value divided by relay 3 scale. 0 = Setpoint Control 1 = Wh Fwd 2 = Wh Rev 3 = VARh Fwd 4 = VARh Rev 5 = VAh 6 = Ah	0	0...6
16	Real	Output_Relay_3_Output_Scale	The relay 3 output parameter divided by the relay 3 scale is the output pulse rate. Example: Wh is selected for the parameter and 1,000 is the scale value. The output is pulsed every kWh.	1,000	1... 100,000
17	Real	Output_Relay_3_Pulse_Duration_Setting	Set as 50...1000 to indicate the duration of the pulse in milliseconds, or set to 0 for KYZ-style transition output. (Toggle) <b>IMPORTANT:</b> the value for delay is rounded off to the nearest 10ms internally during this function.	250 (ms)	0 or 50 ...1000

**Table 57 - Configuration.System.General Data Table (continued)**

Element Number	Type	Tag Name	Description	Default	Range
18 	Real	Status_Input_1_Input_Scale	When a status pulse is received the count is increased by the scale factor. (Input pulse * input scale) added to total status count.	1	1... 1,000,000
19 	Real	Status_Input_2_Input_Scale	When a status pulse is received the count is increased by the scale factor. (Input pulse * input scale) added to total status count.	1	1... 1,000,000
20 	Real	Status_Input_3_Input_Scale	When a status pulse is received the count is increased by the scale factor. (Input pulse * input scale) added to total status count.	1	1... 1,000,000
21 	Real	Status_Input_4_Input_Scale	When a status pulse is received the count is increased by the scale factor. (Input pulse * input scale) added to total status count.	1	1... 1,000,000
22	Real	Unit_Error_Action	This parameter determines the action when a unit error occurs. 0 = Safe Mode on error and make status LED solid red 1 = Perform a firmware reset.	1	0...1
23	Real	Software_Error_Log_Full_Action	This parameter determines the action when a firmware failure is detected and the error log is full. 0 = Safe Mode on error, make status LED solid red and wait for error collection and clear log command. 1 = Perform a firmware reset.	1	0...1
24	Real	Default_KYZ_State_On_Comm_Loss	The Default output state on communication loss defines the behavior of the output if the power monitor experiences a loss of communication. 0 = Last state/resume 1 = Last state/freeze 2 = De-energize/resume 3 = De-energize/freeze 4 = Local control	0	0...4
25	Real	Default_Relay_1_State_On_Comm_Loss	The Default output state on communication loss defines the behavior of the output if the power monitor experiences a loss of communication. 0 = Last state/resume 1 = Last state/freeze 2 = De-energize/resume 3 = De-energize/freeze 4 = Local control	0	0...4
26	Real	Default_Relay_2_State_On_Comm_Loss	The Default output state on communication loss defines the behavior of the output if the power monitor experiences a loss of communication. 0 = Last state/resume 1 = Last state/freeze 2 = De-energize/resume 3 = De-energize/freeze 4 = Local control	0	0...4
27	Real	Default_Relay_3_State_On_Comm_Loss	The Default output state on communication loss defines the behavior of the output if the power monitor experiences a loss of communication. 0 = Last state/resume 1 = Last state/freeze 2 = De-energize/resume 3 = De-energize/freeze 4 = Local control	0	0...4
28...49	Real	Reserved	Future Use	0	0

## Configuration.Communications\_Native

Table 58 - Table Properties



<b>CIP Instance Number</b>	804
<b>PCCC File Number</b>	N13
<b>No. of Elements</b>	70
<b>Length in Words</b>	70
<b>Data Type</b>	Int16
<b>Data Access</b>	Read/Write

Table 59 - Configuration.Communications\_Native Data Table

Element Number	Type	Tag Name	Description	Default	Range
0	Int16	IP_Address_Obtain	Selects the IP Address at startup 0 = Static IP 1 = DHCP	1	0...1
1	Int16	IP_Address_A	First Octet of Unit IP Address	192	0...255
2	Int16	IP_Address_B	Second Octet of Unit IP Address	168	0...255
3	Int16	IP_Address_C	Third Octet of Unit IP Address	1	0...255
4	Int16	IP_Address_D	Fourth Octet of Unit IP Address	100	0...255
5	Int16	Subnet_Mask_A	First Octet of Subnet Mask	255	0...255
6	Int16	Subnet_Mask_B	Second Octet of Subnet Mask	255	0...255
7	Int16	Subnet_Mask_C	Third Octet of Subnet Mask	255	0...255
8	Int16	Subnet_Mask_D	Fourth Octet of Subnet Mask	0	0...255
9	Int16	Gateway_Address_A	First Octet of Gateway Address	192	0...255
10	Int16	Gateway_Address_B	Second Octet of Gateway Address	168	0...255
11	Int16	Gateway_Address_C	Third Octet of Gateway Address	1	0...255
12	Int16	Gateway_Address_D	Fourth Octet of Gateway Address	1	0...255
13	Int16	DNS_Enable	Selects DNS Option 0 = Disable, 1 = Enable	0	0...1
14	Int16	DNS_Server_Address_A	First Octet of DNS Server Address	0	0...255
15	Int16	DNS_Server_Address_B	Second Octet of DNS Server Address	0	0...255
16	Int16	DNS_Server_Address_C	Third Octet of DNS Server Address	0	0...255
17	Int16	DNS_Server_Address_D	Fourth Octet of DNS Server Address	0	0...255
18	Int16	DNS_Server2_Address_A	First Octet of DNS Server Address	0	0...255
19	Int16	DNS_Server2_Address_B	Second Octet of DNS Server Address	0	0...255
20	Int16	DNS_Server2_Address_C	Third Octet of DNS Server Address	0	0...255
21	Int16	DNS_Server2_Address_D	Fourth Octet of DNS Server Address	0	0...255
22	Int16	Time_Sync_Source	Selection for Time Sync 0 = Disable 1 = SNTP 2 = PTP_Slave 3 = PTP_Master	2	0...3



**Table 59 - Configuration.Communications\_Native Data Table (continued)**

Element Number	Type	Tag Name	Description	Default	Range
23	Int16	SNTP_Mode_Select	This selects the operating mode of SNTP 0 = Unicast - The server address is used to point to a unicast server 1 = Anycast Mode - The SNTP address is a broadcast address of an anycast group	0	0...1
24	Int16	SNTP_Time_Update_Interval	Number of seconds before next update	300	1...32,766
25	Int16	SNTP_Time_Zone	International Time Zone Selection	6	0...32
26	Int16	SNTP_Time_Server_IP_Address_A	First Octet of SNTP Server	0	0...255
27	Int16	SNTP_Time_Server_IP_Address_B	Second Octet of SNTP Server	0	0...255
28	Int16	SNTP_Time_Server_IP_Address_C	Third Octet of SNTP Server	0	0...255
29	Int16	SNTP_Time_Server_IP_Address_D	Fourth Octet of SNTP Server	0	0...255
30 	Int16	Demand_Broadcast_Mode_Select	Demand Ethernet broadcast selection 0 = Slave 1 = Master <b>IMPORTANT:</b> Have only one master per demand network.	0	0...1
31 	Int16	Demand_Broadcast_Port	The common port for demand broadcast messages.	300	300...400
32	Int16	Auto_Negotiate_Enable	Enables or disables the hardware auto negotiation for the link connection 0 = Disable 1 = Enable	1	0...1
33	Int16	Force_Ethernet_Speed	When Auto Negotiate is disabled this selects the connection speed 0 = 100 MHz 1 = 10 MHz	1	0...1
34	Int16	Force_Ethernet_Duplex	When Auto Negotiate is disabled this selects the connection duplex 0 = Half 1 = Full	1	0...1
35	Int16	QOS_DSCP_Enable	0 = Disable 1 = Enable	1	0...1
36	Int16	QOS_DSCP_PTP_Event	QOS DSCP PTP Event Setting	59	0...63
37	Int16	QOS_DSCP_PTP_General	QOS DSCP PTP General Setting	47	0...63
38	Int16	QOS_DSCP_Urgent	QOS DSCP Urgent Setting	55	0...63
39	Int16	QOS_DSCP_Scheduled	QOS DSCP Scheduled Setting	47	0...63
40	Int16	QOS_DSCP_High	QOS DSCP High Setting	43	0...63
41	Int16	QOS_DSCP_Low	QOS DSCP Low Setting	31	0...63
42	Int16	QOS_DSCP_Explicit	QOS DSCP Explicit Setting	27	0...63
43	Int16	PTP_Priority1	Used in the execution of the best master clock algorithm. Lower value takes precedence.	128	0...255
44	Int16	PTP_Priority2	Used in the execution of the best master clock algorithm. Lower value takes precedence.	128	0...255
45	Int16	WSB_Mode	Waveform synchronization broadcast mode 0 = Disable; 1 = Enable;	0	0...1
46	Int16	WSB_Port	UDP port for WSB feature	1001	1001...1009
47...69	Int16	Reserved		0	0

## Configuration.Network.Text

Table 60 - Table Properties

<b>CIP Instance Number</b>	805
<b>PCCC File Number</b>	ST14
<b>No. of Elements</b>	5
<b>Length in Bytes</b>	208
<b>Data Type</b>	String
<b>Data Access</b>	Read/Write

Table 61 - Configuration.Network.Text Data Table

Element Number	Size (bytes)	Type	Tag Name	Description	Default	Range
0	48	String 48	Ethernet_Domain_Name	Domain Name for DNS	0	0...255
1	64	String 64	Ethernet_Host_Name	Host Name for DNS	0	0...255
2	32	String 32	Device_Name	A name the user can provide this device	0	0...255
3	32	String 32	Device_Location	The location for this device	0	0...255
4	32	String 32	Reserved	Future Use	0	0...255

---

**IMPORTANT** ControlLogix® and CompactLogix™ controllers can get and set this data with the short integer (SINT) data type. Data can be displayed as decimal/ASCII in RSLogix 5000® software.

---

## Configuration.Setpoints\_1\_5

**Table 62 - Table Properties**

<b>CIP Instance Number</b>	807
<b>PCCC File Number</b>	F16
<b>No. of Elements</b>	50
<b>Length in Words</b>	100
<b>Data Type</b>	Real
<b>Data Access</b>	Read/Write

**Table 63 - Configuration.Setpoints\_1\_5 Data Table**

Element Number	Type	Tag Name	Description	Default	Range
0	Real	Parameter Selection 1	Selection of the input parameter from the <a href="#">Setpoint Parameter Selection List</a> .	0	0...105 (M5, M6) 0...230 (M8)
1	Real	Reference Value 1	Used when Evaluation type is 2 = Percent of Reference	0	-10,000,000 ...10,000,000
2	Real	Test Condition 1	0 = Disabled 1 = Less Than 2 = Greater Than 3 = Equals	0	0...3
3	Real	Evaluation Type 1	0 = Magnitude 1 = State 2 = Percent of Reference (not supported in the M5 model) 3 = Percent of Sliding Reference (not supported in the M5 model)	0	0...3
4	Real	Threshold 1	The value, percent, or state that triggers the output action.	0	-10,000,000... 10,000,000
5	Real	Hysteresis 1	The value in magnitude or percent of reference at which the output action is deasserted. Example: A less than condition deasserts at (threshold + hysteresis), a greater than condition deasserts at (threshold - hysteresis).	0	0...10,000,000
6	Real	Assert Delay Seconds 1	The amount of time to delay the output action after a setpoint trigger occurs. Minimum equals realtime update rate setting.	0	0.000...3600
7	Real	Deassert Delay Seconds 1	The amount of time to delay deassertion after the setpoint trigger releases. Minimum equals realtime update rate setting.	0	0.000...3600
8	Real	Parameter Selection 2	Selection of the input parameter from the <a href="#">Setpoint Parameter Selection List</a> .	0	0...105 (M5, M6) 0...230 (M8)
9	Real	Reference Value 2	Used when Evaluation type is 2 = Percent of Reference	0	-10,000,000 ...10,000,000
10	Real	Test Condition 2	0 = Disabled 1 = Less Than 2 = Greater Than 3 = Equals	0	0...3
11	Real	Evaluation Type 2	0 = Magnitude 1 = State 2 = Percent of Reference (not supported in the M5 model) 3 = Percent of Sliding Reference (not supported in the M5 model)	0	0...3
12	Real	Threshold 2	The value, percent, or state that triggers the output action.	0	-10,000,000... 10,000,000

**Table 63 - Configuration.Setpoints\_1\_5 Data Table (continued)**

Element Number	Type	Tag Name	Description	Default	Range
13	Real	Hysteresis 2	The value in magnitude or percent of reference at which the output action is deasserted. Example: A less than condition deasserts at (threshold + hysteresis), a greater than condition deasserts at (threshold - hysteresis).	0	0...10,000,000
14	Real	Assert Delay Seconds 2	The amount of time to delay the output action after a setpoint trigger occurs. Minimum equals realtime update rate setting.	0	0.000...3600
15	Real	Deassert Delay Seconds 2	The amount of time to delay deassertion after the setpoint trigger releases. Minimum equals realtime update rate setting.	0	0.000...3600
16	Real	Parameter Selection 3	Selection of the input parameter from the <a href="#">Setpoint Parameter Selection List</a> .	0	0...105 (M5, M6) 0...230 (M8)
17	Real	Reference Value 3	Used when Evaluation type is 2 = Percent of Reference	0	-10,000,000 ...10,000,000
18	Real	Test Condition 3	0 = Disabled 1 = Less Than 2 = Greater Than 3 = Equals	0	0...3
19	Real	Evaluation Type 3	0 = Magnitude 1 = State 2 = Percent of Reference (not supported in the M5 model) 3 = Percent of Sliding Reference (not supported in the M5 model)	0	0...3
20	Real	Threshold 3	The value, percent, or state that triggers the output action.	0	-10,000,000... 10,000,000
21	Real	Hysteresis 3	The value in magnitude or percent of reference at which the output action is deasserted. Example: A less than condition deasserts at (threshold + hysteresis), a greater than condition deasserts at (threshold - hysteresis).	0	0...10,000,000
22	Real	Assert Delay Seconds 3	The amount of time to delay the output action after a setpoint trigger occurs. Minimum equals realtime update rate setting.	0	0.000...3600
23	Real	Deassert Delay Seconds 3	The amount of time to delay deassertion after the setpoint trigger releases. Minimum equals realtime update rate setting.	0	0.000...3600
24	Real	Parameter Selection 4	Selection of the input parameter from the <a href="#">Setpoint Parameter Selection List</a> .	0	0...105 (M5, M6) 0...230 (M8)
25	Real	Reference Value 4	Used when Evaluation type is 2 = Percent of Reference	0	-10,000,000 ...10,000,000
26	Real	Test Condition 4	0 = Disabled 1 = Less Than 2 = Greater Than 3 = Equals	0	0...3
27	Real	Evaluation Type 4	0 = Magnitude 1 = State 2 = Percent of Reference (not supported in the M5 model) 3 = Percent of Sliding Reference (not supported in the M5 model)	0	0...3
28	Real	Threshold 4	The value, percent, or state that triggers the output action.	0	-10,000,000... 10,000,000
29	Real	Hysteresis 4	The value in magnitude or percent of reference at which the output action is deasserted. Example: A less than condition deasserts at (threshold + hysteresis), a greater than condition deasserts at (threshold - hysteresis).	0	0...10,000,000
30	Real	Assert Delay Seconds 4	The amount of time to delay the output action after a setpoint trigger occurs. Minimum equals realtime update rate setting.	0	0.000...3600
31	Real	Deassert Delay Seconds 4	The amount of time to delay deassertion after the setpoint trigger releases. Minimum equals realtime update rate setting.	0	0.000...3600

**Table 63 - Configuration.Setpoints\_1\_5 Data Table (continued)**

Element Number	Type	Tag Name	Description	Default	Range
32	Real	Parameter Selection 5	Selection of the input parameter from the <a href="#">Setpoint Parameter Selection List</a> .	0	0...105 (M5, M6) 0...230 (M8)
33	Real	Reference Value 5	Used when Evaluation type is 2 = Percent of Reference	0	-10,000,000 ...10,000,000
34	Real	Test Condition 5	0 = Disabled 1 = Less Than 2 = Greater Than 3 = Equals	0	0...3
35	Real	Evaluation Type 5	0 = Magnitude 1 = State 2 = Percent of Reference (not supported in the M5 model) 3 = Percent of Sliding Reference (not supported in the M5 model)	0	0...3
36	Real	Threshold 5	The value, percent, or state that triggers the output action.	0	-10,000,000... 10,000,000
37	Real	Hysteresis 5	The value in magnitude or percent of reference at which the output action is deasserted. Example: A less than condition deasserts at (threshold + hysteresis), a greater than condition deasserts at (threshold - hysteresis).	0	0...10,000,000
38	Real	Assert Delay Seconds 5	The amount of time to delay the output action after a setpoint trigger occurs. Minimum equals realtime update rate setting.	0	0.000...3600
39	Real	Deassert Delay Seconds 5	The amount of time to delay deassertion after the setpoint trigger releases. Minimum equals realtime update rate setting.	0	0.000...3600
40...49	Real	Reserved	Future Use	0	0

## Configuration.Setpoints\_6\_10

Table 64 - Table Properties

<b>CIP Instance Number</b>	808
<b>PCCC File Number</b>	F17
<b>No. of Elements</b>	50
<b>Length in Words</b>	100
<b>Data Type</b>	Real
<b>Data Access</b>	Read/Write

Table 65 - Configuration.Setpoints\_6\_10 Data Table

Element Number	Type	Tag Name	Description	Default	Range
0	Real	Parameter Selection 6	Selection of the input parameter from the <a href="#">Setpoint Parameter Selection List</a> .	0	0...105 (M5, M6) 0...230 (M8)
1	Real	Reference Value 6	Used when Evaluation type is 2 = Percent of Reference	0	-10,000,000 ...10,000,000
2	Real	Test Condition 6	0 = Disabled 1 = Less Than 2 = Greater Than 3 = Equals	0	0...3
3	Real	Evaluation Type 6	0 = Magnitude 1 = State 2 = Percent of Reference (not supported in the M5 model) 3 = Percent of Sliding Reference (not supported in the M5 model)	0	0...3
4	Real	Threshold 6	The value, percent or state that triggers the output action.	0	-10,000,000... 10,000,000
5	Real	Hysteresis 6	The value in magnitude or percent of reference at which the output action is deasserted. Example: A less than condition deasserts at (threshold + hysteresis), a greater than condition deasserts at (threshold - hysteresis).	0	0...10,000,000
6	Real	Assert Delay Seconds 6	The amount of time to delay the output action after a setpoint trigger occurs. Minimum equals realtime update rate setting.	0	0.000...3600
7	Real	Deassert Delay Seconds 6	The amount of time to delay deassertion after the setpoint trigger releases. Minimum equals realtime update rate setting.	0	0.000...3600
8	Real	Parameter Selection 7	Selection of the input parameter from the <a href="#">Setpoint Parameter Selection List</a> .	0	0...105 (M5, M6) 0...230 (M8)
9	Real	Reference Value 7	Used when Evaluation type is 2 = Percent of Reference	0	-10,000,000 ...10,000,000
10	Real	Test Condition 7	0 = Disabled 1 = Less Than 2 = Greater Than 3 = Equals	0	0...3
11	Real	Evaluation Type 7	0 = Magnitude 1 = State 2 = Percent of Reference (not supported in the M5 model) 3 = Percent of Sliding Reference (not supported in the M5 model)	0	0...3
12	Real	Threshold 7	The value, percent, or state that triggers the output action.	0	-10,000,000... 10,000,000

**Table 65 - Configuration.Setpoints\_6\_10 Data Table (continued)**

Element Number	Type	Tag Name	Description	Default	Range
13	Real	Hysteresis 7	The value in magnitude or percent of reference at which the output action is deasserted. Example: A less than condition deasserts at (threshold + hysteresis), a greater than condition deasserts at (threshold - hysteresis).	0	0...10,000,000
14	Real	Assert Delay Seconds 7	The amount of time to delay the output action after a setpoint trigger occurs. Minimum equals realtime update rate setting.	0	0.000...3600
15	Real	Deassert Delay Seconds 7	The amount of time to delay deassertion after the setpoint trigger releases. Minimum equals realtime update rate setting.	0	0.000...3600
16	Real	Parameter Selection 8	Selection of the input parameter from the <a href="#">Setpoint Parameter Selection List</a> .	0	0...105 (M5, M6) 0...230 (M8)
17	Real	Reference Value 8	Used when Evaluation type is 2 = Percent of Reference	0	-10,000,000 ...10,000,000
18	Real	Test Condition 8	0 = Disabled 1 = Less Than 2 = Greater Than 3 = Equals	0	0...3
19	Real	Evaluation Type 8	0 = Magnitude 1 = State 2 = Percent of Reference (not supported in the M5 model) 3 = Percent of Sliding Reference (not supported in the M5 model)	0	0...3
20	Real	Threshold 8	The value, percent, or state that triggers the output action.	0	-10,000,000... 10,000,000
21	Real	Hysteresis 8	The value in magnitude or percent of reference at which the output action is deasserted. Example: A less than condition deasserts at (threshold + hysteresis), a greater than condition deasserts at (threshold - hysteresis).	0	0...10,000,000
22	Real	Assert Delay Seconds 8	The amount of time to delay the output action after a setpoint trigger occurs. Minimum equals realtime update rate setting.	0	0.000...3600
23	Real	Deassert Delay Seconds 8	The amount of time to delay deassertion after the setpoint trigger releases. Minimum equals realtime update rate setting.	0	0.000...3600
24	Real	Parameter Selection 9	Selection of the input parameter from the <a href="#">Setpoint Parameter Selection List</a> .	0	0...105 (M5, M6) 0...230 (M8)
25	Real	Reference Value 9	Used when Evaluation type is 2 = Percent of Reference	0	-10,000,000 ...10,000,000
26	Real	Test Condition 9	0 = Disabled 1 = Less Than 2 = Greater Than 3 = Equals	0	0...3
27	Real	Evaluation Type 9	0 = Magnitude 1 = State 2 = Percent of Reference (not supported in the M5 model) 3 = Percent of Sliding Reference (not supported in the M5 model)	0	0...3
28	Real	Threshold 9	The value, percent, or state that triggers the output action.	0	-10,000,000... 10,000,000
29	Real	Hysteresis 9	The value in magnitude or percent of reference at which the output action is deasserted. Example: A less than condition deasserts at (threshold + hysteresis), a greater than condition deasserts at (threshold - hysteresis).	0	0...10,000,000
30	Real	Assert Delay Seconds 9	The amount of time to delay the output action after a setpoint trigger occurs. Minimum equals realtime update rate setting.	0	0.000...3600
31	Real	Deassert Delay Seconds 9	The amount of time to delay deassertion after the setpoint trigger releases. Minimum equals realtime update rate setting.	0	0.000...3600

**Table 65 - Configuration.Setpoints\_6\_10 Data Table (continued)**

Element Number	Type	Tag Name	Description	Default	Range
32	Real	Parameter Selection 10	Selection of the input parameter from the <a href="#">Setpoint Parameter Selection List</a> .	0	0...105 (M5, M6) 0...230 (M8)
33	Real	Reference Value 10	Used when Evaluation type is 2 = Percent of Reference	0	-10,000,000 ...10,000,000
34	Real	Test Condition 10	0 = Disabled 1 = Less Than 2 = Greater Than 3 = Equals	0	0...3
35	Real	Evaluation Type 10	0 = Magnitude 1 = State 2 = Percent of Reference (not supported in the M5 model) 3 = Percent of Sliding Reference (not supported in the M5 model)	0	0...3
36	Real	Threshold 10	The value, percent, or state that triggers the output action.	0	-10,000,000... 10,000,000
37	Real	Hysteresis 10	The value in magnitude or percent of reference at which the output action is deasserted. Example: A less than condition deasserts at (threshold + hysteresis), a greater than condition deasserts at (threshold - hysteresis).	0	0...10,000,000
38	Real	Assert Delay Seconds 10	The amount of time to delay the output action after a setpoint trigger occurs. Minimum equals realtime update rate setting.	0	0.000...3600
39	Real	Deassert Delay Seconds 10	The amount of time to delay deassertion after the setpoint trigger releases. Minimum equals realtime update rate setting.	0	0.000...3600
40...49	Real	Reserved	Future Use	0	0



**Configuration.Setpoints\_11\_15 (M6 and M8 model)****Table 66 - Table Properties**

<b>CIP Instance Number</b>	809
<b>PCCC File Number</b>	F18
<b>No. of Elements</b>	50
<b>Length in Words</b>	100
<b>Data Type</b>	Real
<b>Data Access</b>	Read/Write

**Table 67 - Configuration.Setpoints\_11\_15 Data Table**

<b>Element Number</b>	<b>Type</b>	<b>Tag Name</b>	<b>Description</b>	<b>Default</b>	<b>Range</b>
0	Real	Parameter Selection 11	Selection of the input parameter from the <a href="#">Setpoint Parameter Selection List</a> .	0	0...105 (M5, M6) 0...230 (M8)
1	Real	Reference Value 11	Used when Evaluation type is 2 = Percent of Reference	0	-10,000,000 ...10,000,000
2	Real	Test Condition 11	0 = Disabled 1 = Less Than 2 = Greater Than 3 = Equals	0	0...3
3	Real	Evaluation Type 11	0 = Magnitude 1 = State 2 = Percent of Reference (not supported in the M5 model) 3 = Percent of Sliding Reference (not supported in the M5 model)	0	0...3
4	Real	Threshold 11	The value, percent, or state that triggers the output action.	0	-10,000,000... 10,000,000
5	Real	Hysteresis 11	The value in magnitude or percent of reference at which the output action is deasserted. Example: A less than condition deasserts at (threshold + hysteresis), a greater than condition deasserts at (threshold - hysteresis).	0	0...10,000,000
6	Real	Assert Delay Seconds 11	The amount of time to delay the output action after a setpoint trigger occurs. Minimum equals realtime update rate setting.	0	0.000...3600
7	Real	Deassert Delay Seconds 11	The amount of time to delay deassertion after the setpoint trigger releases. Minimum equals realtime update rate setting.	0	0.000...3600
8	Real	Parameter Selection 12	Selection of the input parameter from the <a href="#">Setpoint Parameter Selection List</a> .	0	0...105 (M5, M6) 0...230 (M8)
9	Real	Reference Value 12	Used when Evaluation type is 2 = Percent of Reference	0	-10,000,000 ...10,000,000
10	Real	Test Condition 12	0 = Disabled 1 = Less Than 2 = Greater Than 3 = Equals	0	0...3
11	Real	Evaluation Type 12	0 = Magnitude 1 = State 2 = Percent of Reference (not supported in the M5 model) 3 = Percent of Sliding Reference (not supported in the M5 model)	0	0...3
12	Real	Threshold 12	The value, percent, or state that triggers the output action.	0	-10,000,000... 10,000,000

**Table 67 - Configuration.Setpoints\_11\_15 Data Table (continued)**

Element Number	Type	Tag Name	Description	Default	Range
13	Real	Hysteresis 12	The value in magnitude or percent of reference at which the output action is deasserted. Example: A less than condition deasserts at (threshold + hysteresis), a greater than condition deasserts at (threshold - hysteresis).	0	0...10,000,000
14	Real	Assert Delay Seconds 12	The amount of time to delay the output action after a setpoint trigger occurs. Minimum equals realtime update rate setting.	0	0.000...3600
15	Real	Deassert Delay Seconds 12	The amount of time to delay deassertion after the setpoint trigger releases. Minimum equals realtime update rate setting.	0	0.000...3600
16	Real	Parameter Selection 13	Selection of the input parameter from the <a href="#">Setpoint Parameter Selection List</a> .	0	0...105 (M5, M6) 0...230 (M8)
17	Real	Reference Value 13	Used when Evaluation type is 2 = Percent of Reference	0	-10,000,000 ...10,000,000
18	Real	Test Condition 13	0 = Disabled 1 = Less Than 2 = Greater Than 3 = Equals	0	0...3
19	Real	Evaluation Type 13	0 = Magnitude 1 = State 2 = Percent of Reference (not supported in the M5 model) 3 = Percent of Sliding Reference (not supported in the M5 model)	0	0...3
20	Real	Threshold 13	The value, percent, or state that triggers the output action.	0	-10,000,000... 10,000,000
21	Real	Hysteresis 13	The value in magnitude or percent of reference at which the output action is deasserted. Example: A less than condition deasserts at (threshold + hysteresis), a greater than condition deasserts at (threshold - hysteresis).	0	0...10,000,000
22	Real	Assert Delay Seconds 13	The amount of time to delay the output action after a setpoint trigger occurs. Minimum equals realtime update rate setting.	0	0.000...3600
23	Real	Deassert Delay Seconds 13	The amount of time to delay deassertion after the setpoint trigger releases. Minimum equals realtime update rate setting.	0	0.000...3600
24	Real	Parameter Selection 14	Selection of the input parameter from the <a href="#">Setpoint Parameter Selection List</a> .	0	0...105 (M5, M6) 0...230 (M8)
25	Real	Reference Value 14	Used when Evaluation type is 2 = Percent of Reference	0	-10,000,000 ...10,000,000
26	Real	Test Condition 14	0 = Disabled 1 = Less Than 2 = Greater Than 3 = Equals	0	0...3
27	Real	Evaluation Type 14	0 = Magnitude 1 = State 2 = Percent of Reference (not supported in the M5 model) 3 = Percent of Sliding Reference (not supported in the M5 model)	0	0...3
28	Real	Threshold 14	The value, percent, or state that triggers the output action.	0	-10,000,000... 10,000,000
29	Real	Hysteresis 14	The value in magnitude or percent of reference at which the output action is deasserted. Example: A less than condition deasserts at (threshold + hysteresis), a greater than condition deasserts at (threshold - hysteresis).	0	0...10,000,000
30	Real	Assert Delay Seconds 14	The amount of time to delay the output action after a setpoint trigger occurs. Minimum equals realtime update rate setting.	0	0.000...3600
31	Real	Deassert Delay Seconds 14	The amount of time to delay deassertion after the setpoint trigger releases. Minimum equals realtime update rate setting.	0	0.000...3600

**Table 67 - Configuration.Setpoints\_11\_15 Data Table (continued)**

Element Number	Type	Tag Name	Description	Default	Range
32	Real	Parameter Selection 15	Selection of the input parameter from the <a href="#">Setpoint Parameter Selection List</a> .	0	0...105 (M5, M6) 0...230 (M8)
33	Real	Reference Value 15	Used when Evaluation type is 2 = Percent of Reference	0	-10,000,000 ...10,000,000
34	Real	Test Condition 15	0 = Disabled 1 = Less Than 2 = Greater Than 3 = Equals	0	0...3
35	Real	Evaluation Type 15	0 = Magnitude 1 = State 2 = Percent of Reference (not supported in the M5 model) 3 = Percent of Sliding Reference (not supported in the M5 model)	0	0...3
36	Real	Threshold 15	The value, percent, or state that triggers the output action.	0	-10,000,000... 10,000,000
37	Real	Hysteresis 15	The value in magnitude or percent of reference at which the output action is deasserted. Example: A less than condition deasserts at (threshold + hysteresis), a greater than condition deasserts at (threshold - hysteresis).	0	0...10,000,000
38	Real	Assert Delay Seconds 15	The amount of time to delay the output action after a setpoint trigger occurs. Minimum equals realtime update rate setting.	0	0.000...3600
39	Real	Deassert Delay Seconds 15	The amount of time to delay deassertion after the setpoint trigger releases. Minimum equals realtime update rate setting.	0	0.000...3600
40...49	Real	Reserved	Future Use	0	0

### Configuration.Setpoints\_16\_20 (M6 and M8 model)

Table 68 - Table Properties

<b>CIP Instance Number</b>	810
<b>PCCC File Number</b>	F19
<b>No. of Elements</b>	50
<b>Length in Words</b>	100
<b>Data Type</b>	Real
<b>Data Access</b>	Read/Write

Table 69 - Configuration.Setpoints\_16\_20 Data Table

Element Number	Type	Tag Name	Description	Default	Range
0	Real	Parameter Selection 16	Selection of the input parameter from the <a href="#">Setpoint Parameter Selection List</a> .	0	0...105 (M5, M6) 0...230 (M8)
1	Real	Reference Value 16	Used when Evaluation type is 2 = Percent of Reference	0	-10,000,000 ...10,000,000
2	Real	Test Condition 16	0 = Disabled 1 = Less Than 2 = Greater Than 3 = Equals	0	0...3
3	Real	Evaluation Type 16	0 = Magnitude 1 = State 2 = Percent of Reference (not supported in the M5 model) 3 = Percent of Sliding Reference (not supported in the M5 model)	0	0...3
4	Real	Threshold 16	The value, percent or state that triggers the output action.	0	-10,000,000... 10,000,000
5	Real	Hysteresis 16	The value in magnitude or percent of reference at which the output action is deasserted. Example: A less than condition deasserts at (threshold + hysteresis), a greater than condition deasserts at (threshold - hysteresis).	0	0...10,000,000
6	Real	Assert Delay Seconds 16	The amount of time to delay the output action after a setpoint trigger occurs. Minimum equals realtime update rate setting.	0	0.000...3600
7	Real	Deassert Delay Seconds 16	The amount of time to delay deassertion after the setpoint trigger releases. Minimum equals realtime update rate setting.	0	0.000...3600
8	Real	Parameter Selection 17	Selection of the input parameter from the <a href="#">Setpoint Parameter Selection List</a> .	0	0...105 (M5, M6) 0...230 (M8)
9	Real	Reference Value 17	Used when Evaluation type is 2 = Percent of Reference	0	-10,000,000 ...10,000,000
10	Real	Test Condition 17	0 = Disabled 1 = Less Than 2 = Greater Than 3 = Equals	0	0...3
11	Real	Evaluation Type 17	0 = Magnitude 1 = State 2 = Percent of Reference (not supported in the M5 model) 3 = Percent of Sliding Reference (not supported in the M5 model)	0	0...3
12	Real	Threshold 17	The value, percent, or state that triggers the output action.	0	-10,000,000... 10,000,000

**Table 69 - Configuration.Setpoints\_16\_20 Data Table (continued)**

Element Number	Type	Tag Name	Description	Default	Range
13	Real	Hysteresis 17	The value in magnitude or percent of reference at which the output action is deasserted. Example: A less than condition deasserts at (threshold + hysteresis), a greater than condition deasserts at (threshold - hysteresis).	0	0...10,000,000
14	Real	Assert Delay Seconds 17	The amount of time to delay the output action after a setpoint trigger occurs. Minimum equals realtime update rate setting.	0	0.000...3600
15	Real	Deassert Delay Seconds 17	The amount of time to delay deassertion after the setpoint trigger releases. Minimum equals realtime update rate setting.	0	0.000...3600
16	Real	Parameter Selection 18	Selection of the input parameter from the <a href="#">Setpoint Parameter Selection List</a> .	0	0...105 (M5, M6) 0...230 (M8)
17	Real	Reference Value 18	Used when Evaluation type is 2 = Percent of Reference	0	-10,000,000 ...10,000,000
18	Real	Test Condition 18	0 = Disabled 1 = Less Than 2 = Greater Than 3 = Equals	0	0...3
19	Real	Evaluation Type 18	0 = Magnitude 1 = State 2 = Percent of Reference (not supported in the M5 model) 3 = Percent of Sliding Reference (not supported in the M5 model)	0	0...3
20	Real	Threshold 18	The value, percent, or state that triggers the output action.	0	-10,000,000... 10,000,000
21	Real	Hysteresis 18	The value in magnitude or percent of reference at which the output action is deasserted. Example: A less than condition deasserts at (threshold + hysteresis), a greater than condition deasserts at (threshold - hysteresis).	0	0...10,000,000
22	Real	Assert Delay Seconds 18	The amount of time to delay the output action after a setpoint trigger occurs. Minimum equals realtime update rate setting.	0	0.000...3600
23	Real	Deassert Delay Seconds 18	The amount of time to delay deassertion after the setpoint trigger releases. Minimum equals realtime update rate setting.	0	0.000...3600
24	Real	Parameter Selection 19	Selection of the input parameter from the <a href="#">Setpoint Parameter Selection List</a> .	0	0...105 (M5, M6) 0...230 (M8)
25	Real	Reference Value 19	Used when Evaluation type is 2 = Percent of Reference	0	-10,000,000 ...10,000,000
26	Real	Test Condition 19	0 = Disabled 1 = Less Than 2 = Greater Than 3 = Equals	0	0...3
27	Real	Evaluation Type 19	0 = Magnitude 1 = State 2 = Percent of Reference (not supported in the M5 model) 3 = Percent of Sliding Reference (not supported in the M5 model)	0	0...3
28	Real	Threshold 19	The value, percent, or state that triggers the output action.	0	-10,000,000... 10,000,000
29	Real	Hysteresis 19	The value in magnitude or percent of reference at which the output action is deasserted. Example: A less than condition deasserts at (threshold + hysteresis), a greater than condition deasserts at (threshold - hysteresis).	0	0...10,000,000
30	Real	Assert Delay Seconds 19	The amount of time to delay the output action after a setpoint trigger occurs. Minimum equals realtime update rate setting.	0	0.000...3600
31	Real	Deassert Delay Seconds 19	The amount of time to delay deassertion after the setpoint trigger releases. Minimum equals realtime update rate setting.	0	0.000...3600

**Table 69 - Configuration.Setpoints\_16\_20 Data Table (continued)**

Element Number	Type	Tag Name	Description	Default	Range
32	Real	Parameter Selection 20	Selection of the input parameter from the <a href="#">Setpoint Parameter Selection List</a> .	0	0...105 (M5, M6) 0...230 (M8)
33	Real	Reference Value 20	Used when Evaluation type is 2 = Percent of Reference	0	-10,000,000 ...10,000,000
34	Real	Test Condition 20	0 = Disabled 1 = Less Than 2 = Greater Than 3 = Equals	0	0...3
35	Real	Evaluation Type 20	0 = Magnitude 1 = State 2 = Percent of Reference (not supported in the M5 model) 3 = Percent of Sliding Reference (not supported in the M5 model)	0	0...3
36	Real	Threshold 20	The value, percent, or state that triggers the output action.	0	-10,000,000... 10,000,000
37	Real	Hysteresis 20	The value in magnitude or percent of reference at which the output action is deasserted. Example: A less than condition deasserts at (threshold + hysteresis), a greater than condition deasserts at (threshold - hysteresis).	0	0...10,000,000
38	Real	Assert Delay Seconds 20	The amount of time to delay the output action after a setpoint trigger occurs. Minimum equals realtime update rate setting.	0	0.000...3600
39	Real	Deassert Delay Seconds 20	The amount of time to delay deassertion after the setpoint trigger releases. Minimum equals realtime update rate setting.	0	0.000...3600
40...49	Real	Reserved	Future Use	0	0

**Configuration.Setpoint\_Logic (M6 and M8 Model)****Table 70 - Table Properties**

<b>CIP Instance Number</b>	811
<b>PCCC File Number</b>	N20
<b>No. of Elements</b>	100
<b>Length in Words</b>	100
<b>Data Type</b>	Int16
<b>Data Access</b>	Read/Write

**Table 71 - Configuration.Setpoint\_Logic Data Table**

<b>Element Number</b>	<b>Type</b>	<b>Tag Name</b>	<b>Description</b>	<b>Default</b>	<b>Range</b>
0	Int16	Logic Level 1 Gate 1 Function	Selects the logic type 0 = disabled 1 = AND 2 = NAND 3 = OR 4 = NOR 5 = XOR 6 = XNOR <b>IMPORTANT:</b> XOR and XNOR use Inputs 1 and 2 only.	0	0...6
1	Int16	L1_G1 Input 1	Selects the first input parameter for the gate. Each gate has four inputs. 0 = Disabled 1 = Setpoint 1 2 = Setpoint 2 3 = Setpoint 3 ... 20 = Setpoint 20 <b>IMPORTANT:</b> Negative numbers invert the input.	0	-20...20
2	Int16	L1_G1 Input 2	Selects the second input parameter for the gate. Each gate has four inputs. 0 = Disabled 1 = Setpoint 1 2 = Setpoint 2 3 = Setpoint 3 ... 20 = Setpoint 20 <b>IMPORTANT:</b> Negative numbers invert the input.	0	-20...20
3	Int16	L1_G1 Input 3	Selects the third input parameter for the gate. Each gate has four inputs. 0 = Disabled 1 = Setpoint 1 2 = Setpoint 2 3 = Setpoint 3 ... 20 = Setpoint 20 <b>IMPORTANT:</b> Negative numbers invert the input.	0	-20...20
4	Int16	L1_G1 Input 4	Selects the fourth input parameter for the gate. Each gate has four inputs. 0 = Disabled 1 = Setpoint 1 2 = Setpoint 2 3 = Setpoint 3 ... 20 = Setpoint 20 <b>IMPORTANT:</b> Negative numbers invert the input.	0	-20...20

**Table 71 - Configuration.Setpoint\_Logic Data Table (continued)**

Element Number	Type	Tag Name	Description	Default	Range
5	Int16	Logic Level 1 Gate 2 Function	<p>Selects the logic type</p> <p>0 = disabled</p> <p>1 = AND</p> <p>2 = NAND</p> <p>3 = OR</p> <p>4 = NOR</p> <p>5 = XOR</p> <p>6 = XNOR</p> <p><b>IMPORTANT:</b> XOR and XNOR use Inputs 1 and 2 only.</p>	0	0...6
6	Int16	L1_G2 Input 1	<p>Selects the first input parameter for the gate. Each gate has four inputs.</p> <p>0 = Disabled</p> <p>1 = Setpoint 1</p> <p>2 = Setpoint 2</p> <p>3 = Setpoint 3</p> <p>...</p> <p>20 = Setpoint 20</p> <p><b>IMPORTANT:</b> Negative numbers invert the input.</p>	0	-20...20
7	Int16	L1_G2 Input 2	<p>Selects the second input parameter for the gate. Each gate has four inputs.</p> <p>0 = Disabled</p> <p>1 = Setpoint 1</p> <p>2 = Setpoint 2</p> <p>3 = Setpoint 3</p> <p>...</p> <p>20 = Setpoint 20</p> <p><b>IMPORTANT:</b> Negative numbers invert the input.</p>	0	-20...20
8	Int16	L1_G2 Input 3	<p>Selects the third input parameter for the gate. Each gate has four inputs.</p> <p>0 = Disabled</p> <p>1 = Setpoint 1</p> <p>2 = Setpoint 2</p> <p>3 = Setpoint 3</p> <p>...</p> <p>20 = Setpoint 20</p> <p><b>IMPORTANT:</b> Negative numbers invert the input.</p>	0	-20...20
9	Int16	L1_G2 Input 4	<p>Selects the fourth input parameter for the gate. Each gate has four inputs.</p> <p>0 = Disabled</p> <p>1 = Setpoint 1</p> <p>2 = Setpoint 2</p> <p>3 = Setpoint 3</p> <p>...</p> <p>20 = Setpoint 20</p> <p><b>IMPORTANT:</b> Negative numbers invert the input.</p>	0	-20...20
10	Int16	Logic Level 1 Gate 3 Function	<p>Selects the logic type</p> <p>0 = disabled</p> <p>1 = AND</p> <p>2 = NAND</p> <p>3 = OR</p> <p>4 = NOR</p> <p>5 = XOR</p> <p>6 = XNOR</p> <p><b>IMPORTANT:</b> XOR and XNOR use Inputs 1 and 2 only.</p>	0	0...6



**Table 71 - Configuration.Setpoint\_Logic Data Table (continued)**

Element Number	Type	Tag Name	Description	Default	Range
11	Int16	L1_G3 Input 1	Selects the first input parameter for the gate. Each gate has four inputs. 0 = Disabled 1 = Setpoint 1 2 = Setpoint 2 3 = Setpoint 3 ... 20 = Setpoint 20 <b>IMPORTANT:</b> Negative numbers invert the input.	0	-20...20
12	Int16	L1_G3 Input 2	Selects the second input parameter for the gate. Each gate has four inputs. 0 = Disabled 1 = Setpoint 1 2 = Setpoint 2 3 = Setpoint 3 ... 20 = Setpoint 20 <b>IMPORTANT:</b> Negative numbers invert the input.	0	-20...20
13	Int16	L1_G3 Input 3	Selects the third input parameter for the gate. Each gate has four inputs. 0 = Disabled 1 = Setpoint 1 2 = Setpoint 2 3 = Setpoint 3 ... 20 = Setpoint 20 <b>IMPORTANT:</b> Negative numbers invert the input.	0	-20...20
14	Int16	L1_G3 Input 4	Selects the fourth input parameter for the gate. Each gate has four inputs. 0 = Disabled 1 = Setpoint 1 2 = Setpoint 2 3 = Setpoint 3 ... 20 = Setpoint 20 <b>IMPORTANT:</b> Negative numbers invert the input.	0	-20...20
15	Int16	Logic Level 1 Gate 4 Function	Selects the logic type 0 = disabled, 1 = AND 2 = NAND 3 = OR 4 = NOR 5 = XOR 6 = XNOR <b>IMPORTANT:</b> XOR and XNOR use Inputs 1 and 2 only.	0	0...6
16	Int16	L1_G4 Input 1	Selects the first input parameter for the gate. Each gate has four inputs. 0 = Disabled 1 = Setpoint 1 2 = Setpoint 2 3 = Setpoint 3 ... 20 = Setpoint 20 <b>IMPORTANT:</b> Negative numbers invert the input.	0	-20...20

**Table 71 - Configuration.Setpoint\_Logic Data Table (continued)**

Element Number	Type	Tag Name	Description	Default	Range
17	Int16	L1_G4 Input 2	Selects the second input parameter for the gate. Each gate has four inputs. 0 = Disabled 1 = Setpoint 1 2 = Setpoint 2 3 = Setpoint 3 ... 20 = Setpoint 20 <b>IMPORTANT:</b> Negative numbers invert the input.	0	-20...20
18	Int16	L1_G4 Input 3	Selects the third input parameter for the gate. Each gate has four inputs. 0 = Disabled 1 = Setpoint 1 2 = Setpoint 2 3 = Setpoint 3 ... 20 = Setpoint 20 <b>IMPORTANT:</b> Negative numbers invert the input.	0	-20...20
19	Int16	L1_G4 Input 4	Selects the fourth input parameter for the gate. Each gate has four inputs. 0 = Disabled 1 = Setpoint 1 2 = Setpoint 2 3 = Setpoint 3 ... 20 = Setpoint 20 <b>IMPORTANT:</b> Negative numbers invert the input.	0	-20...20
20	Int16	Logic Level 1 Gate 5 Function	Selects the logic type 0 = disabled 1 = AND 2 = NAND 3 = OR 4 = NOR 5 = XOR 6 = XNOR <b>IMPORTANT:</b> XOR and XNOR use Inputs 1 and 2 only.	0	0...6
21	Int16	L1_G5 Input 1	Selects the first input parameter for the gate. Each gate has four inputs. 0 = Disabled 1 = Setpoint 1 2 = Setpoint 2 3 = Setpoint 3 ... 20 = Setpoint 20 <b>IMPORTANT:</b> Negative numbers invert the input.	0	-20...20
22	Int16	L1_G5 Input 2	Selects the second input parameter for the gate. Each gate has four inputs. 0 = Disabled 1 = Setpoint 1 2 = Setpoint 2 3 = Setpoint 3 ... 20 = Setpoint 20 <b>IMPORTANT:</b> Negative numbers invert the input.	0	-20...20

**Table 71 - Configuration.Setpoint\_Logic Data Table (continued)**

Element Number	Type	Tag Name	Description	Default	Range
23	Int16	L1_G5 Input 3	Selects the third input parameter for the gate. Each gate has four inputs. 0 = Disabled 1 = Setpoint 1 2 = Setpoint 2 3 = Setpoint 3 ... 20 = Setpoint 20 <b>IMPORTANT:</b> Negative numbers invert the input.	0	-20...20
24	Int16	L1_G5 Input 4	Selects the fourth input parameter for the gate. Each gate has four inputs. 0 = Disabled 1 = Setpoint 1 2 = Setpoint 2 3 = Setpoint 3 ... 20 = Setpoint 20 <b>IMPORTANT:</b> Negative numbers invert the input.	0	-20...20
25	Int16	Logic Level 1 Gate 6 Function	Selects the logic type 0 = disabled 1 = AND 2 = NAND 3 = OR 4 = NOR 5 = XOR 6 = XNOR <b>IMPORTANT:</b> XOR and XNOR use Inputs 1 and 2 only.	0	0...6
26	Int16	L1_G6 Input 1	Selects the first input parameter for the gate. Each gate has four inputs. 0 = Disabled 1 = Setpoint 1 2 = Setpoint 2 3 = Setpoint 3 ... 20 = Setpoint 20 <b>IMPORTANT:</b> Negative numbers invert the input.	0	-20...20
27	Int16	L1_G6 Input 2	Selects the second input parameter for the gate. Each gate has four inputs. 0 = Disabled 1 = Setpoint 1 2 = Setpoint 2 3 = Setpoint 3 ... 20 = Setpoint 20 <b>IMPORTANT:</b> Negative numbers invert the input.	0	-20...20
28	Int16	L1_G6 Input 3	Selects the third input parameter for the gate. Each gate has four inputs. 0 = Disabled, 1 = Setpoint 1, 2 = Setpoint 2, 3 = Setpoint 3 ... 20 = Setpoint 20 <b>IMPORTANT:</b> Negative numbers invert the input.	0	-20...20

**Table 71 - Configuration.Setpoint\_Logic Data Table (continued)**

Element Number	Type	Tag Name	Description	Default	Range
29	Int16	L1_G6 Input 4	Selects the fourth input parameter for the gate. Each gate has four inputs. 0 = Disabled 1 = Setpoint 1 2 = Setpoint 2 3 = Setpoint 3 ... 20 = Setpoint 20 <b>IMPORTANT:</b> Negative numbers invert the input.	0	-20...20
30	Int16	Logic Level 1 Gate 7 Function	Selects the logic type 0 = disabled 1 = AND 2 = NAND 3 = OR 4 = NOR 5 = XOR 6 = XNOR <b>IMPORTANT:</b> XOR and XNOR use Inputs 1 and 2 only.	0	0...6
31	Int16	L1_G7 Input 1	Selects the first input parameter for the gate. Each gate has four inputs. 0 = Disabled 1 = Setpoint 1 2 = Setpoint 2 3 = Setpoint 3 ... 20 = Setpoint 20 <b>IMPORTANT:</b> Negative numbers invert the input.	0	-20...20
32	Int16	L1_G7 Input 2	Selects the second input parameter for the gate. Each gate has four inputs. 0 = Disabled 1 = Setpoint 1 2 = Setpoint 2 3 = Setpoint 3 ... 20 = Setpoint 20 <b>IMPORTANT:</b> Negative numbers invert the input.	0	-20...20
33	Int16	L1_G7 Input 3	Selects the third input parameter for the gate. Each gate has four inputs. 0 = Disabled 1 = Setpoint 1 2 = Setpoint 2 3 = Setpoint 3 ... 20 = Setpoint 20 <b>IMPORTANT:</b> Negative numbers invert the input.	0	-20...20
34	Int16	L1_G7 Input 4	Selects the fourth input parameter for the gate. Each gate has four inputs. 0 = Disabled 1 = Setpoint 1 2 = Setpoint 2 3 = Setpoint 3 ... 20 = Setpoint 20 <b>IMPORTANT:</b> Negative numbers invert the input.	0	-20...20

**Table 71 - Configuration.Setpoint\_Logic Data Table (continued)**

Element Number	Type	Tag Name	Description	Default	Range
35	Int16	Logic Level 1 Gate 8 Function	Selects the logic type 0 = disabled 1 = AND 2 = NAND 3 = OR 4 = NOR 5 = XOR 6 = XNOR <b>IMPORTANT:</b> XOR and XNOR use Inputs 1 and 2 only.	0	0...6
36	Int16	L1_G8 Input 1	Selects the first input parameter for the gate. Each gate has four inputs. 0 = Disabled 1 = Setpoint 1 2 = Setpoint 2 3 = Setpoint 3 ... 20 = Setpoint 20 <b>IMPORTANT:</b> Negative numbers invert the input.	0	-20...20
37	Int16	L1_G8 Input 2	Selects the second input parameter for the gate. Each gate has four inputs. 0 = Disabled 1 = Setpoint 1 2 = Setpoint 2 3 = Setpoint 3 ... 20 = Setpoint 20 <b>IMPORTANT:</b> Negative numbers invert the input.	0	-20...20
38	Int16	L1_G8 Input 3	Selects the third input parameter for the gate. Each gate has four inputs. 0 = Disabled 1 = Setpoint 1 2 = Setpoint 2 3 = Setpoint 3 ... 20 = Setpoint 20 <b>IMPORTANT:</b> Negative numbers invert the input.	0	-20...20
39	Int16	L1_G8 Input 4	Selects the fourth input parameter for the gate. Each gate has four inputs. 0 = Disabled 1 = Setpoint 1 2 = Setpoint 2 3 = Setpoint 3 ... 20 = Setpoint 20 <b>IMPORTANT:</b> Negative numbers invert the input.	0	-20...20
40	Int16	Logic Level 1 Gate 9 Function	Selects the logic type 0 = disabled 1 = AND 2 = NAND 3 = OR 4 = NOR 5 = XOR 6 = XNOR <b>IMPORTANT:</b> XOR and XNOR use Inputs 1 and 2 only.	0	0...6

Table 71 - Configuration.Setpoint\_Logic Data Table (continued)

Element Number	Type	Tag Name	Description	Default	Range
41	Int16	L1_G9 Input 1	Selects the first input parameter for the gate. Each gate has four inputs. 0 = Disabled 1 = Setpoint 1 2 = Setpoint 2 3 = Setpoint 3 ... 20 = Setpoint 20 <b>IMPORTANT:</b> Negative numbers invert the input.	0	-20...20
42	Int16	L1_G9 Input 2	Selects the second input parameter for the gate. Each gate has four inputs. 0 = Disabled 1 = Setpoint 1 2 = Setpoint 2 3 = Setpoint 3 ... 20 = Setpoint 20 <b>IMPORTANT:</b> Negative numbers invert the input.	0	-20...20
43	Int16	L1_G9 Input 3	Selects the third input parameter for the gate. Each gate has four inputs. 0 = Disabled 1 = Setpoint 1 2 = Setpoint 2 3 = Setpoint 3 ... 20 = Setpoint 20 <b>IMPORTANT:</b> Negative numbers invert the input.	0	-20...20
44	Int16	L1_G9 Input 4	Selects the fourth input parameter for the gate. Each gate has four inputs. 0 = Disabled 1 = Setpoint 1 2 = Setpoint 2 3 = Setpoint 3 ... 20 = Setpoint 20 <b>IMPORTANT:</b> Negative numbers invert the input.	0	-20...20
45	Int16	Logic Level 1 Gate 10 Function	Selects the logic type 0 = disabled 1 = AND 2 = NAND 3 = OR 4 = NOR 5 = XOR 6 = XNOR <b>IMPORTANT:</b> XOR and XNOR use Inputs 1 and 2 only.	0	0...6
46	Int16	L1_G10 Input 1	Selects the first input parameter for the gate. Each gate has four inputs. 0 = Disabled 1 = Setpoint 1 2 = Setpoint 2 3 = Setpoint 3 ... 20 = Setpoint 20 <b>IMPORTANT:</b> Negative numbers invert the input.	0	-20...20

**Table 71 - Configuration.Setpoint\_Logic Data Table (continued)**

Element Number	Type	Tag Name	Description	Default	Range
47	Int16	L1_G10 Input 2	Selects the second input parameter for the gate. Each gate has four inputs. 0 = Disabled 1 = Setpoint 1 2 = Setpoint 2 3 = Setpoint 3 ... 20 = Setpoint 20 <b>IMPORTANT:</b> Negative numbers invert the input.	0	-20...20
48	Int16	L1_G10 Input 3	Selects the third input parameter for the gate. Each gate has four inputs. 0 = Disabled 1 = Setpoint 1 2 = Setpoint 2 3 = Setpoint 3 ... 20 = Setpoint 20 <b>IMPORTANT:</b> Negative numbers invert the input.	0	-20...20
49	Int16	L1_G10 Input 4	Selects the fourth input parameter for the gate. Each gate has four inputs. 0 = Disabled 1 = Setpoint 1 2 = Setpoint 2 3 = Setpoint 3 ... 20 = Setpoint 20 <b>IMPORTANT:</b> Negative numbers invert the input.	0	-20...20
50 ... 99	Int16	Reserved	Future Use	0	0

## Configuration.Setpoint\_Outputs

Table 72 - Table Properties

<b>CIP Instance Number</b>	812
<b>PCCC File Number</b>	N21
<b>No. of Elements</b>	100
<b>Length in Words</b>	100
<b>Data Type</b>	Int16
<b>Data Access</b>	Read/Write

Table 73 - Configuration.Setpoint\_Outputs Data Table

Element Number	Type	Tag Name	Description	Default	Range
0	Int16	Setpoint Output 1 Input Source	Selects the source for output. Setpoint or gate output state. 0 = No source 1 = Setpoint 1 2 = Setpoint 2... 20 = Setpoint 20 21 = Level1_G1 ... 30 = Level1_G10	1	0...10 (M5) 0...30 (M6, M8)
1	Int16	Setpoint Output 1 Action	Selects the output action to perform when setpoint is asserted. See the <a href="#">Setpoint Output Action List</a> .	0	0...19 (M5) 0...30 (M6, M8)
2	Int16	Setpoint Output 2 Input Source	Selects the source for output. Setpoint or gate output state. 0 = No source 1 = Setpoint1 2 = Setpoint 2... 20 = Setpoint 20 21 = Level1_G1 ... 30 = Level1_G10	2	0...10 (M5) 0...30 (M6, M8)
3	Int16	Setpoint Output 2 Action	Selects the output action to perform when setpoint is asserted. See the <a href="#">Setpoint Output Action List</a> .	0	0...19 (M5) 0...30 (M6, M8)
4	Int16	Setpoint Output 3 Input Source	Selects the source for output. Setpoint or gate output state. 0 = No source 1 = Setpoint1 2 = Setpoint 2... 20 = Setpoint 20 21 = Level1_G1 ... 30 = Level1_G10	3	0...10 (M5) 0...30 (M6, M8)
5	Int16	Setpoint Output 3 Action	Selects the output action to perform when setpoint is asserted. See the <a href="#">Setpoint Output Action List</a> .	0	0...19 (M5) 0...30 (M6, M8)
6	Int16	Setpoint Output 4 Input Source	Selects the source for output. Setpoint or gate output state. 0 = No source 1 = Setpoint1 2 = Setpoint 2... 20 = Setpoint 20 21 = Level1_G1 ... 30 = Level1_G10	4	0...10 (M5) 0...30 (M6, M8)
7	Int16	Setpoint Output 4 Action	Selects the output action to perform when setpoint is asserted. See the <a href="#">Setpoint Output Action List</a> .	0	0...19 (M5) 0...30 (M6, M8)



**Table 73 - Configuration.Setpoint\_Outputs Data Table (continued)**

Element Number	Type	Tag Name	Description	Default	Range
8	Int16	Setpoint Output 5 Input Source	Selects the source for output. Setpoint or gate output state. 0 = No source 1 = Setpoint1 2 = Setpoint 2... 20 = Setpoint 20 21 = Level1_G1 ... 30 = Level1_G10	5	0...10 (M5) 0...30 (M6, M8)
9	Int16	Setpoint Output 5 Action	Selects the output action to perform when setpoint is asserted. See the <a href="#">Setpoint Output Action List</a> .	0	0...19 (M5) 0...30 (M6, M8)
10	Int16	Setpoint Output 6 Input Source	Selects the source for output. Setpoint or gate output state. 0 = No source 1 = Setpoint1 2 = Setpoint 2... 20 = Setpoint 20 21 = Level1_G1 ... 30 = Level1_G10	6	0...10 (M5) 0...30 (M6, M8)
11	Int16	Setpoint Output 6 Action	Selects the output action to perform when setpoint is asserted. See the <a href="#">Setpoint Output Action List</a> .	0	0...19 (M5) 0...30 (M6, M8)
12	Int16	Setpoint Output 7 Input Source	Selects the source for output. Setpoint or gate output state. 0 = No source 1 = Setpoint1 2 = Setpoint 2... 20 = Setpoint 20 21 = Level1_G1 ... 30 = Level1_G10	7	0...10 (M5) 0...30 (M6, M8)
13	Int16	Setpoint Output 7 Action	Selects the output action to perform when setpoint is asserted. See the <a href="#">Setpoint Output Action List</a> .	0	0...19 (M5) 0...30 (M6, M8)
14	Int16	Setpoint Output 8 Input Source	Selects the source for output. Setpoint or gate output state. 0 = No source 1 = Setpoint1 2 = Setpoint 2... 20 = Setpoint 20 21 = Level1_G1 ... 30 = Level1_G10	8	0...10 (M5) 0...30 (M6, M8)
15	Int16	Setpoint Output 8 Action	Selects the output action to perform when setpoint is asserted. See the <a href="#">Setpoint Output Action List</a> .	0	0...19 (M5) 0...30 (M6, M8)
16	Int16	Setpoint Output 9 Input Source	Selects the source for output. Setpoint or gate output state. 0 = No source 1 = Setpoint1 2 = Setpoint 2... 20 = Setpoint 20 21 = Level1_G1 ... 30 = Level1_G10	9	0...10 (M5) 0...30 (M6, M8)
17	Int16	Setpoint Output 9 Action	Selects the output action to perform when setpoint is asserted. See the <a href="#">Setpoint Output Action List</a> .	0	0...19 (M5) 0...30 (M6, M8)

**Table 73 - Configuration.Setpoint\_Outputs Data Table (continued)**

Element Number	Type	Tag Name	Description	Default	Range
18	Int16	Setpoint Output 10 Input Source	Selects the source for output. Setpoint or gate output state. 0 = No source 1 = Setpoint1 2 = Setpoint 2... 20 = Setpoint 20 21 = Level1_G1 ... 30 = Level1_G10	10	0...10 (M5) 0...30 (M6, M8)
19	Int16	Setpoint Output 10 Action	Selects the output action to perform when setpoint is asserted. See the <a href="#">Setpoint Output Action List</a> .	0	0...19 (M5) 0...30 (M6, M8)
20	Int16	Setpoint Output 11 Input Source	Selects the source for output. Setpoint or gate output state. 0 = No source 1 = Setpoint 1 2 = Setpoint 2... 20 = Setpoint 20 21 = Level1_G1 ... 30 = Level1_G10	11	0...30 (M6, M8)
21	Int16	Setpoint Output 11 Action	Selects the output action to perform when setpoint is asserted. See the <a href="#">Setpoint Output Action List</a> .	0	0...30 (M6, M8)
22	Int16	Setpoint Output 12 Input Source	Selects the source for output. Setpoint or gate output state. 0 = No source 1 = Setpoint 1 2 = Setpoint 2... 20 = Setpoint 20 21 = Level1_G1 ... 30 = Level1_G10	12	0...30 (M6, M8)
23	Int16	Setpoint Output 12 Action	Selects the output action to perform when setpoint is asserted. See the <a href="#">Setpoint Output Action List</a> .	0	0...30 (M6, M8)
24	Int16	Setpoint Output 13 Input Source	Selects the source for output. Setpoint or gate output state. 0 = No source 1 = Setpoint 1 2 = Setpoint 2... 20 = Setpoint 20 21 = Level1_G1 ... 30 = Level1_G10	13	0...30 (M6, M8)
25	Int16	Setpoint Output 13 Action	Selects the output action to perform when setpoint is asserted. See the <a href="#">Setpoint Output Action List</a> .	0	0...30 (M6, M8)
26	Int16	Setpoint Output 14 Input Source	Selects the source for output. Setpoint or gate output state. 0 = No source 1 = Setpoint 1 2 = Setpoint 2... 20 = Setpoint 20 21 = Level1_G1 ... 30 = Level1_G10	14	0...30 (M6, M8)
27	Int16	Setpoint Output 14 Action	Selects the output action to perform when setpoint is asserted. See the <a href="#">Setpoint Output Action List</a> .	0	0...30 (M6, M8)
28	Int16	Setpoint Output 15 Input Source	Selects the source for output. Setpoint or gate output state. 0 = No source 1 = Setpoint 1 2 = Setpoint 2... 20 = Setpoint 20 21 = Level1_G1 ... 30 = Level1_G10	15	0...30 (M6, M8)

**Table 73 - Configuration.Setpoint\_Outputs Data Table (continued)**

Element Number	Type	Tag Name	Description	Default	Range
29	Int16	Setpoint Output 15 Action	Selects the output action to perform when setpoint is asserted. See the <a href="#">Setpoint Output Action List</a> .	0	0...30 (M6, M8)
30	Int16	Setpoint Output 16 Input Source	Selects the source for output. Setpoint or gate output state. 0 = No source 1 = Setpoint 1 2 = Setpoint 2... 20 = Setpoint 20 21 = Level1_G1 ... 30 = Level1_G10	16	0...30 (M6, M8)
31	Int16	Setpoint Output 16 Action	Selects the output action to perform when setpoint is asserted. See the <a href="#">Setpoint Output Action List</a> .	0	0...30 (M6, M8)
32	Int16	Setpoint Output 17 Input Source	Selects the source for output. Setpoint or gate output state. 0 = No source 1 = Setpoint 1 2 = Setpoint 2... 20 = Setpoint 20 21 = Level1_G1 ... 30 = Level1_G10	17	0...30 (M6, M8)
33	Int16	Setpoint Output 17 Action	Selects the output action to perform when setpoint is asserted. See the <a href="#">Setpoint Output Action List</a> .	0	0...30 (M6, M8)
34	Int16	Setpoint Output 18 Input Source	Selects the source for output. Setpoint or gate output state. 0 = No source 1 = Setpoint 1 2 = Setpoint 2... 20 = Setpoint 20 21 = Level1_G1 ... 30 = Level1_G10	18	0...30 (M6, M8)
35	Int16	Setpoint Output 18 Action	Selects the output action to perform when setpoint is asserted. See the <a href="#">Setpoint Output Action List</a> .	0	0...30 (M6, M8)
36	Int16	Setpoint Output 19 Input Source	Selects the source for output. Setpoint or gate output state. 0 = No source 1 = Setpoint 1 2 = Setpoint 2... 20 = Setpoint 20 21 = Level1_G1 ... 30 = Level1_G10	19	0...30 (M6, M8)
37	Int16	Setpoint Output 19 Action	Selects the output action to perform when setpoint is asserted. See the <a href="#">Setpoint Output Action List</a> .	0	0...30 (M6, M8)
38	Int16	Setpoint Output 20 Input Source	Selects the source for output. Setpoint or gate output state. 0 = No source 1 = Setpoint 1 2 = Setpoint 2... 20 = Setpoint 20 21 = Level1_G1 ... 30 = Level1_G10	20	0...30 (M6, M8)
39	Int16	Setpoint Output 20 Action	Selects the output action to perform when setpoint is asserted. See the <a href="#">Setpoint Output Action List</a> .	0	0...30 (M6, M8)
40...99	Int16	Reserved	Future Use	0	0

## Configuration.Data\_Log

Table 74 - Table Properties

<b>CIP Instance Number</b>	813
<b>PCCC File Number</b>	N22
<b>No. of Elements</b>	34
<b>Length in Words</b>	34
<b>Data Type</b>	Int16
<b>Data Access</b>	Read/Write

Table 75 - Configuration.Data\_Log Data Table

Element Number	Type	Tag Name (default tag name)	Description	Default	Range
0	Int16	Data_Logging_Interval	Logging Interval in seconds. 0=Disables data logging -1= synchronize log with demand period	900 (15 min)	-1...3600
1	Int16	Logging Mode	Selects how records are saved. 0= Fill and stop recording when log is full 1= Overwrite when log is full starting with the earliest record.	1	0...1
2	Int16	DataLog_Parameter_1 (Avg_V_N_Volts)	Selection of parameter or default to be logged in the data log.	5	0...88 (M5) 1...184 (M6, M8)
3	Int16	DataLog_Parameter_2 (Avg_VL_VL_Volts)	Selection of parameter or default to be logged in the data log.	9	0...88 (M5) 1...184 (M6, M8)
4	Int16	DataLog_Parameter_3 (Avg_Amps)	Selection of parameter or default to be logged in the data log.	14	0...88 (M5) 1...184 (M6, M8)
5	Int16	DataLog_Parameter_4 (Frequency_Hz)	Selection of parameter or default to be logged in the data log.	15	0...88 (M5) 1...184 (M6, M8)
6	Int16	DataLog_Parameter_5 (Total_kW)	Selection of parameter or default to be logged in the data log.	19	0...88 (M5) 1...184 (M6, M8)
7	Int16	DataLog_Parameter_6 (Total_kVAR)	Selection of parameter or default to be logged in the data log.	23	0...88 (M5) 1...184 (M6, M8)
8	Int16	DataLog_Parameter_7 (Total_kVA)	Selection of parameter or default to be logged in the data log.	27	0...88 (M5) 1...184 (M6, M8)
9	Int16	DataLog_Parameter_8 (Total_PF_Lead_Lag_Indicator)	Selection of parameter or default to be logged in the data log.	39	0...88 (M5) 1...184 (M6, M8)
10	Int16	DataLog_Parameter_9 (Avg_True_PF)	Selection of parameter or default to be logged in the data log.	31	0...88 (M5) 1...184 (M6, M8)
11	Int16	DataLog_Parameter_10 (Avg_Disp_PF)	Selection of parameter or default to be logged in the data log.	35	0...88 (M5) 1...184 (M6, M8)
12	Int16	DataLog_Parameter_11 (Avg_IEEE_THD_V_%)	Selection of parameter or default to be logged in the data log.	54	0...88 (M5) 1...184 (M6, M8)
13	Int16	DataLog_Parameter_12 (Avg_IEEE_THD_V_V_%)	Selection of parameter or default to be logged in the data log.	58	0...88 (M5) 1...184 (M6, M8)
14	Int16	DataLog_Parameter_13 (Avg_IEEE_THD_I_%)	Selection of parameter or default to be logged in the data log.	63	0...88 (M5) 1...184 (M6, M8)
15	Int16	DataLog_Parameter_14 (Avg_IEC_THD_V_%)	Selection of parameter or default to be logged in the data log.	68	0...88 (M5) 1...184 (M6, M8)

**Table 75 - Configuration.Data\_Log Data Table (continued)**

Element Number	Type	Tag Name (default tag name)	Description	Default	Range
16	Int16	DataLog_Parameter_15 (Avg_IEC_THD_V_V_%)	Selection of parameter or default to be logged in the data log.	72	0...88 (M5) 1...184 (M6, M8)
17	Int16	DataLog_Parameter_16 (Avg_IEC_THD_I_%)	Selection of parameter or default to be logged in the data log.	77	0...88 (M5) 1...184 (M6, M8)
18	Int16	DataLog_Parameter_17 (Voltage_Unbalance_%)	Selection of parameter or default to be logged in the data log.	87	0...88 (M5) 1...184 (M6, M8)
19	Int16	DataLog_Parameter_18 (Current_Unbalance_%)	Selection of parameter or default to be logged in the data log.	88	0...88 (M5) 1...184 (M6, M8)
20	Int16	DataLog_Parameter_19	Selection of parameter or default to be logged in the data log.	0	0...88 (M5) 1...184 (M6, M8)
21	Int16	DataLog_Parameter_20	Selection of parameter or default to be logged in the data log.	0	0...88 (M5) 1...184 (M6, M8)
22	Int16	DataLog_Parameter_21	Selection of parameter or default to be logged in the data log.	0	0...88 (M5) 1...184 (M6, M8)
23	Int16	DataLog_Parameter_22	Selection of parameter or default to be logged in the data log.	0	0...88 (M5) 1...184 (M6, M8)
24	Int16	DataLog_Parameter_23	Selection of parameter or default to be logged in the data log.	0	0...88 (M5) 1...184 (M6, M8)
25	Int16	DataLog_Parameter_24	Selection of parameter or default to be logged in the data log.	0	0...88 (M5) 1...184 (M6, M8)
26	Int16	DataLog_Parameter_25	Selection of parameter or default to be logged in the data log.	0	0...88 (M5) 1...184 (M6, M8)
27	Int16	DataLog_Parameter_26	Selection of parameter or default to be logged in the data log.	0	0...88 (M5) 1...184 (M6, M8)
28	Int16	DataLog_Parameter_27	Selection of parameter or default to be logged in the data log.	0	0...88 (M5) 1...184 (M6, M8)
29	Int16	DataLog_Parameter_28	Selection of parameter or default to be logged in the data log.	0	0...88 (M5) 1...184 (M6, M8)
30	Int16	DataLog_Parameter_29	Selection of parameter or default to be logged in the data log.	0	0...88 (M5) 1...184 (M6, M8)
31	Int16	DataLog_Parameter_30	Selection of parameter or default to be logged in the data log.	0	0...88 (M5) 1...184 (M6, M8)
32	Int16	DataLog_Parameter_31	Selection of parameter or default to be logged in the data log.	0	0...88 (M5) 1...184 (M6, M8)
33	Int16	DataLog_Parameter_32	Selection of parameter or default to be logged in the data log.	0	0...88 (M5) 1...184 (M6, M8)

## Configuration.Log\_Read

Table 76 - Table Properties

<b>CIP Instance Number</b>	814
<b>PCCC File Number</b>	N23
<b>No. of Elements</b>	15
<b>Length in Words</b>	15
<b>Data Type</b>	Int16
<b>Data Access</b>	Read/Write

Table 77 - Configuration.Log\_Read Data Table

Element Number	Type	Tag Name	Description	Default	Range
0	Int16	Selected Log	<p>Selects the log that information is returned from. Once a single request has been made the auto return feature brings back successive records each time the log is read. Some logs support individual record requests.</p> <p>1 = Unit Event Log                      2 = Min/Max Log                      3 = Load Factor Log                      4 = Time of Use Log                      5 = Setpoint Log                      6 = Alarm Log                      7 = Data Log File List                      8 = Energy Log File List                      9 = Snapshot Log File                      10 = Power Quality Log                      11 = Waveform Log File                      12 = Trigger Data File                      13 = Trigger Header File                      14 = EN50160 Weekly Log                      15 = EN50160 Yearly Log</p> <p>Important: If your catalog number does not support the requested log item, the power monitor ignores the request. Check the Write Status Table.</p>	Initial value = 0	1...15
1	Int16	Chronology of Auto Return Data	<p>The date chronology of the returned records.</p> <p>0 = Reverse direction                      1 = Forward direction.</p>	1	0...1
2	Int16	The Min/Max record to be returned	Selects the Min/Max record number to be returned. See the table for Min/Max record list.	0	0...82 (M5,M6) 0...207 (M8)
3	Int16	Load Factor or TOU record to be returned.	<p>Selects the Load Factor or TOU record number to be returned.</p> <p>0 = Use incremental return and the chronology selected.                      1...13 selects an individual record.                      1 = Current record being calculated.</p>	0	0...13
4	Int16	EN50160 weekly record to be returned	<p>Selects the EN50160 weekly record number to be returned.</p> <p>0 = Use incremental return and the chronology selected.                      1...8 selects an individual record.                      1 = Current record being calculated.</p>	0	0...8
5	Int16	EN50160 yearly record to be returned	<p>Selects the EN50160 yearly record number to be returned.</p> <p>0 = Use incremental return and the chronology selected.                      1...13 selects an individual record.                      1 = Current record being calculated.</p>	0	0...13
6...14	Int16	Reserved	Reserved for future use.	0	0

## Configuration.PowerQuality

**Table 78 - Table Properties**

<b>CIP Instance Number</b>	815
<b>PCCC File Number</b>	F24
<b>No. of Elements</b>	50
<b>Length in Words</b>	100
<b>Data Type</b>	Real
<b>Data Access</b>	Read/Write

**Table 79 - Configuration.PowerQuality Data Table**

Element Number	Type	Tag Name	Description	Default	Range
0	Real	Sag1_Trip_Point_%	The percent of Nominal System Voltage that creates a level 1 sag condition.	0	0.00...100.00
1	Real	Sag1_Hysteresis_%	The percent of hysteresis for sag 1 condition.	2	0.00...10.00
2	Real	Sag2_Trip_Point_%	The percent of Nominal System Voltage that creates a level 2 sag condition.	0	0.00...100.00
3	Real	Sag2_Hysteresis_%	The percent of hysteresis for sag 2 condition.	2	0.00...10.00
4	Real	Sag3_Trip_Point_%	The percent of Nominal System Voltage that creates a level 3 sag condition.	0	0.00...100.00
5	Real	Sag3_Hysteresis_%	The percent of hysteresis for sag 3 condition.	2	0.00...10.00
6	Real	Sag4_Trip_Point_%	The percent of Nominal System Voltage that creates a level 4 sag condition.	0	0.00...100.00
7	Real	Sag4_Hysteresis_%	The percent of hysteresis for sag 4 condition.	2	0.00...10.00
8	Real	Sag5_Trip_Point_%	The percent of Nominal System Voltage that creates a level 5 sag condition.	0	0.00...100.00
9	Real	Sag5_Hysteresis_%	The percent of hysteresis for sag 5 condition.	2	0.00...10.00
10	Real	Swell1_Trip_Point_%	The percent of Nominal System Voltage that creates a level 1 swell condition.	200	100.00...200.00
11	Real	Swell1_Hysteresis_%	The percent of hysteresis for swell 1 condition.	2	0.00...10.00
12	Real	Swell2_Trip_Point_%	The percent of Nominal System Voltage that creates a level 2 swell condition.	200	100.00...200.00
13	Real	Swell2_Hysteresis_%	The percent of hysteresis for swell 2 condition.	2	0.00...10.00
14	Real	Swell3_Trip_Point_%	The percent of Nominal System Voltage that creates a level 3 swell condition.	200	100.00...200.00
15	Real	Swell3_Hysteresis_%	The percent of hysteresis for swell 3 condition.	2	0.00...10.00
16	Real	Swell4_Trip_Point_%	The percent of Nominal System Voltage that creates a level 4 swell condition.	200	100.00...200.00
17	Real	Swell4_Hysteresis_%	The percent of hysteresis for swell 4 condition.	2	0.00...10.00
18	Real	Capture_Pre_Event_Cycles	The pre-event cycles for waveform capture	5	5...10
19	Real	Capture_Post_Event_Cycles	The post-event cycles for waveform capture	15	2...30
20	Real	Relative_Setpoint_Intvl_m	The interval setting in minutes for the rolling average of all relative setpoints.	60	1...1440
21	Real	IEEE1159_Parameter_Hysteresis_%	The percent of hysteresis for IEEE1159 output parameters.	2	0.00...10.00
22	Real	IEEE1159_Imbalance_Averaging_Intvl_m	The rolling average interval for Imbalance in minutes	15	15...60

**Table 79 - Configuration.PowerQuality Data Table (continued)**

Element Number	Type	Tag Name	Description	Default	Range
23	Real	IEEE1159_Voltage_Imbalance_Limit_%	The percent of voltage imbalance to create an imbalance event	3	1.00...10.00
24	Real	IEEE1159_Current_Imbalance_Limit_%	The percent of current imbalance to create an imbalance event	25	1.00...50.00
25	Real	IEEE1159_DCOffset_Harmonic_Avg_Intvl_m	The rolling average interval for DC offset and Harmonics in minutes	5	1...15
26	Real	IEEE1159_Voltage_DCOffset_Limit_%	The percent of DC offset limitation	0.1	0.00...1.00
27	Real	IEEE1159_Voltage_THD_Limit_%	The percent of voltage THD limitation	5	0.00...20.00
28	Real	IEEE1159_Current_THD_Limit_%	The percent of current THD limitation	10	0.00...20.00
29	Real	IEEE1159_PowerFrequency_Avg_Intvl_s	The rolling average interval for power frequency in seconds.	1	1...10
30	Real	IEEE1159_PowerFrequency_Limit_Hz	The limitation on power frequency variation in Hz.	0.1	0.1...0.2
31	Real	IEEE1159_PowerFrequency_Hysteresis_Hz	Hysteresis of power frequency	0.02	0.01...0.05
32	Real	IEEE519_Compliance_Parameter	IEEE 519 Compliance Parameter 0 = Current 1 = Voltage	0	0...1
33	Real	IEEE519_MAX_Isc_Amps	Short circuit current available at the point of common coupling. (PCC) IMPORTANT: When Isc is '0' or IL is '0', the first row in IEEE 519 Current Distortion Limits table is selected for compliance.	0	0.00...1,000,000.00
34	Real	IEEE 519 MAX_IL_Amps	Average maximum demand for current for the preceding 12 months. IMPORTANT: When IL is '0' the current THD instead of TDD is used for compliance.	0	0.00...1,000,000.00
35	Real	IEEE1159_Voltage_TID_Limit_%	The percent of Voltage TID limitation	5	0.00...20.00 (M8_Only)
36	Real	IEEE1159_Current_TID_Limit_%	The percent of Current TID limitation	10	0.00...20.00 (M8_Only)
37	Real	IEEE1159_Short_Term_Perceptability_Limit_P <sub>st</sub>	The P <sub>st</sub> limit configuration for Voltage Fluctuations	1	0.2...4.0 (M8_Only)
38	Real	Metering_Snapshot_Parameter_Selection	This option configures what set of parameters is used when the metering snapshot command is issued: 0 = Single cycle parameters 1 = Harmonics voltage and current HDS and IHDS parameters 2 = 5 Hz harmonic results through the 50th harmonic	0	0...2 (M8_Only)
39	Real	Transient_Detection_Threshold_%	The threshold setting for the percent of transient detection. 0% = disable function 0.1...50% sets the threshold for transient recording.	4	0.0...50.0 (M8_Only)
40	Real	Mains_Signaling_Frequency_Hz	The monitoring frequency of the control signal in Hz	500	5...3000 (M8_Only)
41	Real	Mains_Signaling_Recording_Length	The maximum recording length in seconds.	120	1...120 (M8_Only)
42	Real	Mains_Signaling_Threshold_%	The threshold in percent of signal level to the mains voltage. A value of 0% disables the mains signal recording.	0	0...15 (M8_Only)
43	Real	Under_Over_Voltage_Deviation_Threshold_%	The percent under voltage or overvoltage of the mains connection to start recording deviation. 0% disables.	5	0...15 (M8_Only)
44	Real	PowerFrequency_Synchronization	Sets the environment of the metering system. 0 = Synchronous connection to an interconnected system 1 = Not synchronous to an interconnected system. (Islanded).	0	0...1 (M8_Only)
45...49	Real	Reserved	Reserved for future use.	0	0



## Configuration.OptionalComm.DNT

**Table 80 - Table Properties**

<b>CIP Instance Number</b>	816
<b>PCCC File Number</b>	N25
<b>No. of Elements</b>	30
<b>Length in Words</b>	30
<b>Data Type</b>	Int16
<b>Data Access</b>	Read/Write

**Table 81 - Configuration.OptionalComm.DNT Data Table**

Element Number	Type	Tag Name	Description	Default	Range
0	Int16	DeviceNet_Address	DeviceNet® optional card device address	63	0...63
1	Int16	DeviceNet_Baudrate	DeviceNet optional card communication rate. 0 - 125k 1 - 250k 2 - 500k 3 - AutoBaud	3	0...3
2...29	Int16	Reserved	Future Use	0	0

## Configuration.OptionalComm.CNT

**Table 82 - Table Properties (instance and file #s the same as DNT because only 1 can be present)**

<b>CIP Instance Number</b>	816
<b>PCCC File Number</b>	N25
<b>No. of Elements</b>	30
<b>Length in Words</b>	30
<b>Data Type</b>	Int16
<b>Data Access</b>	Read/Write

**Table 83 - Configuration.OptionalComm.CNT Data Table**

Element Number	Type	Tag Name	Description	Default	Range
0	Int16	ControlNet_Address	ControlNet® optional card device address. (Valid values 1...99; Invalid values: 0, 100...255)	255	0...255
1...29	Int16	Reserved	Future Use	0	0

## Configuration.DataLogFile

**Table 84 - Table Properties**

<b>CIP Instance Number</b>	817
<b>PCCC File Number</b>	ST26
<b>No. of Elements</b>	1
<b>Length in Words</b>	32
<b>Data Type</b>	String
<b>Data Access</b>	Write Only

**Table 85 - Configuration.DataLogFile Data Table**

Element Number	Type	Tag Name	Description	Default	Range
0	String	Data_Log_File_Name	A single entry table for a 64 character Filename entry	0	64 bytes

## Configuration.EnergyLogFile

**Table 86 - Table Properties**

<b>CIP Instance Number</b>	818
<b>PCCC File Number</b>	ST27
<b>No. of Elements</b>	1
<b>Length in Words</b>	32
<b>Data Type</b>	String
<b>Data Access</b>	Write

**Table 87 - Configuration.EnergyLogFile Data Table**

Element Number	Type	Tag Name	Description	Default	Range
0	String	Energy_Log_File_Name	A single entry table for a 64 character Filename entry	0	64 bytes

## Configuration.TriggerDataLogFile (M6 and M8 model)

**Table 88 - Table Properties**

<b>CIP Instance Number</b>	868
<b>PCCC File Number</b>	ST77
<b>No. of Elements</b>	1
<b>Length in Words</b>	32
<b>Data Type</b>	String
<b>Data Access</b>	Write Only

**Table 89 - Configuration.TriggerDataLogFile Data Table**

Element Number	Type	Tag Name	Description	Default	Range
0	String	Trigger_Log_File	A single entry table for a 64 character Filename entry	0	64 bytes

### Configuration.TriggerSetpointInfoFile (M6 and M8 model)

Table 90 - Table Properties

CIP Instance Number	867
PCCC File Number	5T76
No. of Elements	1
Length in Words	32
Data Type	String
Data Access	Write Only

Table 91 - Configuration.TriggerSetpointInfoFile Data Table

Element Number	Type	Tag Name	Description	Default	Range
0	String	Trigger_Setpoint_Log_File	A single entry table for a 64 character Filename entry	0	64 bytes

### Configuration.TriggerData\_Log (M6 and M8 model)

Table 92 - Table Properties

CIP Instance Number	822
PCCC File Number	N31
No. of Elements	10
Length in Words	10
Data Type	Int16
Data Access	Read/Write

Table 93 - Configuration.TriggerData\_Log Data Table

Element Number	Type	Tag Name	Description	Default	Range
0	Int16	Trigger_Mode	Selects how records are saved. 0= Fill and stop recording when log is full. 1= Overwrite when log is full starting with the earliest record.	1	0...1
1	Int16	TriggerData_Length_s	TriggerData log length from 1s to 10s	1s	1...10s
2	Int16	TriggerData_Parameter_1	Selection of parameter or default to be logged in the trigger data log.	5	1...184
3	Int16	TriggerData_Parameter_2		9	0...184
4	Int16	TriggerData_Parameter_3		14	0...184
5	Int16	TriggerData_Parameter_4		15	0...184
6	Int16	TriggerData_Parameter_5		19	0...184
7	Int16	TriggerData_Parameter_6		23	0...184
8	Int16	TriggerData_Parameter_7		27	0...184
9	Int16	TriggerData_Parameter_8		39	0...184

**Configuration.Harmonics\_Optional\_Read****Table 94 - Table Properties**

<b>CIP Instance Number</b>	819
<b>PCCC File Number</b>	N28
<b>No. of Elements</b>	15
<b>Length in Words</b>	15
<b>Data Type</b>	Int16
<b>Data Access</b>	Write

**Table 95 - Configuration.Harmonics\_Optional\_Read Data Table**

<b>Element Number</b>	<b>Type</b>	<b>Tag Name</b>	<b>Description</b>	<b>Default</b>	<b>Range</b>
0	Int16	Channel_Parameter	Selects the channel associated with the data returned in a subsequent read of Table PowerQuality.Harmonics_Results. 0 = No Selection      1 = V1-N RMS, 2 = V2-N RMS        3 = V3-N, 4 = VN-G RMS        5 = V1-V2 RMS, 6 = V2-V3 RMS       7 = V3-V1 RMS 8 = I1 RMS            9 = I2 RMS 10 = I3 RMS           11 = I4 RMS 12 = L1 kW RMS      13 = L2 kW RMS 14 = L3 kW RMS      15 = L1 kVAR RMS 16 = L2 kVAR RMS    17 = L3 kVAR RMS 18 = L1 kVA RMS     19 = L2 kVA RMS 20 = L3 kVA RMS     21 = Total kW RMS 22 = Total kVAR RMS 23 = Total kVA RMS 24 = V1-N Angle     25 = V2-N Angle 26 = V3-N Angle     27 = VN-G Angle 28 = V1-V2 Angle    29 = V2-V3 Angle 30 = V3-V1 Angle    31 = I1 Angle 32 = I2 Angle        33 = I3 Angle 34 = I4 Angle	0	0...34
1	Int16	Harmonics Order Range Selection	Selects harmonics order range. 0 = DC...31st 1 = 32nd...63rd 2 = 64th...95th 3 = 96th...127th	0	0...1 (M6) 0...3 (M8)
2...14	Int16	Reserved	Reserved for future use.	0	0

### Configuration.WaveformFileName (M6 and M8 model)

Table 96 - Table Properties

<b>CIP Instance Number</b>	870
<b>PCCC File Number</b>	ST79
<b>No. of Elements</b>	1
<b>Length in Words</b>	32
<b>Data Type</b>	String
<b>Data Access</b>	Write Only

Table 97 - Configuration.WaveformFileName Data Table

Element Number	Type	Tag Name	Description	Default	Range
0	String	Waveform_File_Name	A single entry table for a 64 character Filename entry 'Waveform_ID_YYYYMMDD_HHMMSS_MicroS_hh/cycle/ magorang/channel/iorder' Where, YYYYMMDD_HHMMSS is local date_time; hh is GMT hour; cycle = current cycle offset returned (range is from 0 to total cycles - 1 in the waveform) magorang = 0 is mag and 1 is angle channel = the current channel returned (range is from 0 to 7) iorder = 0 is DC to 31st, 1 is 32nd to 63rd, 2 is 64th to 95th and 3 is 96th to 127th if only the file name is written, the retrieval is returned from the start of waveform;	0	64 bytes

### Security.Username

Table 98 - Table Properties

<b>CIP Instance Number</b>	820
<b>PCCC File Number</b>	ST29
<b>No. of Elements</b>	1
<b>Length in Words</b>	16
<b>Data Type</b>	String
<b>Data Access</b>	Write Only

Table 99 - Security.Username Data Table

Element Number	Size	Type	Tag Name	Description	Default	Range
0	32	String	Username	A single entry table for a 32 character Username entry	0	32 bytes

## Security.Password

**Table 100 - Table Properties**

<b>CIP Instance Number</b>	821
<b>PCCC File Number</b>	ST30
<b>No. of Elements</b>	1
<b>Length in Words</b>	16
<b>Data Type</b>	String
<b>Data Access</b>	Write Only

**Table 101 - Security.Password Data Table**

<b>Element Number</b>	<b>Size</b>	<b>Type</b>	<b>Tag Name</b>	<b>Description</b>	<b>Default</b>	<b>Range</b>
0	32	String	Password	A single entry table for a 32 character Username entry	0	32 bytes

## Status.General

**Table 102 - Table Properties**

<b>CIP Instance Number</b>	823
<b>PCCC File Number</b>	N32
<b>No. of Elements</b>	55
<b>Length in Words</b>	55
<b>Data Type</b>	Int16
<b>Data Access</b>	Read Only

**Table 103 - Status.General Data Table**

Element Number	Type	Tag Name	Description	Range
0	Int16	Bulletin_Number	1426	0 or 1426
1	Int16	Device_Class	Describes the product device type. 5 = PM_PowerMonitor 5000	5
2	Int16	Model	Indicates the feature set included in the catalog number. 1 = M5 2 = M6 4 = M8	1, 2, or 4
3	Int16	Communication_Options	Displays the communication hardware options. 0 = NAT (Native Ethernet) 1 = CNT (Optional ControlNet) 3 = DNT (Optional DeviceNet)	0, 1, 3
4	Int16	Nominal_Input_Current	5 = 5 Ampere	5
5	Int16	Metering_Class_Designation	Designation for the metering accuracy. 2 = Class Designation 0.2	2
6	Int16	Series_Letter	The current hardware revision. A...Z.	0...26
7	Int16	Manufacture_Month	Month the Unit was manufactured.	1...12
8	Int16	Manufacture_Day	Day the Unit was manufactured.	1...31
9	Int16	Manufacture_Year	Year the Unit was manufactured.	2010...2100
10	Int16	Overall_System_Status	Reports the overall system status of each system assembly. 0 = Status PASS Bit 0 = 1: Assembly_Slot_0_inst_1_Error Bit 1 = 1: Assembly_Slot_0_inst_2_Error Bit 2 = 1: Assembly_Slot_1_inst_1_Error Bit 3 = 1: Assembly_Slot_1_inst_2_Error Bit 4 = 1: Assembly_Slot_2_inst_1_Error Bit 5 = 1: Assembly_Slot_2_inst_2_Error Bit 6 = 1: Assembly_Slot_3_inst_1_Error Bit 7 = 1: Assembly_Slot_3_inst_2_Error For the detailed error code, see <a href="#">Status.RunTime</a> table.	0...65,535
11	Int16	Error_Log_Contents	Number of records in the Error Log.	0...65,535



**Table 103 - Status.General Data Table (continued)**

<b>Element Number</b>	<b>Type</b>	<b>Tag Name</b>	<b>Description</b>	<b>Range</b>
12	Int16	Metering_Configuration_Locked	The hardware switch for configuration is locked.	0...1
13	Int16	PTP_Status	Indicates PTP status 0 = PTP Listening 1 = PTP Slave 2 = PTP Master	0...2
14...54	Int16	Reserved	Future Use.	0

## Status.Communications

**Table 104 - Table Properties**

<b>CIP Instance Number</b>	824
<b>PCCC File Number</b>	N33
<b>No. of Elements</b>	61
<b>Length in Words</b>	61
<b>Data Type</b>	Int16
<b>Data Access</b>	Read Only

**Table 105 - Status.Communications Data Table**

Element Number	Type	Tag Name	Description	Range
0	Int16	Ethernet_Overall_Status	Ethernet Communication Overall Status 0 = Pass 1...32766 = Fail	0...32,766
	bit 0	IP_and_Subnet	Invalid IP Address or Subnet Mask 0 = PASS 1 = FAIL	0 or 1
	bit 1	Gateway_Address	Invalid Gateway Address 0 = PASS 1 = FAIL	0 or 1
	bit 2	DNS_Server_Address	Invalid DNS server Address 0 = PASS 1 = FAIL	0 or 1
	bit 3	DNS_Server2_Address	Invalid DNS server2 Address 0 = PASS 1 = FAIL	0 or 1
	bit 4	SNTP_Server_Address	Invalid Timer Server Address 0 = PASS 1 = FAIL	0 or 1
	bit 5	DHCP_Server_Timeout_Test	DHCP Server Timeout 0 = PASS 1 = FAIL	0 or 1
	bit 6	Duplicate_IP_Address_Test	Duplicate IP Address 0 = PASS 1 = FAIL	0 or 1
	bit 7	Time_Server_Timeout_Test	Time Server Timeout 0 = PASS 1 = FAIL	0 or 1
	bit 8	DNS_Server_Timeout_Test	DNS Server Timeout 0 = PASS 1 = FAIL	0 or 1
	bit 9...15	Reserved	Future Use	0
1...60	Int16	Reserved	Future Use	0

## Status.RunTime

**Table 106 - Table Properties**

<b>CIP Instance Number</b>	825
<b>PCCC File Number</b>	N34
<b>No. of Elements</b>	74
<b>Length in Words</b>	74
<b>Data Type</b>	Int16
<b>Data Access</b>	Read Only

**Table 107 - Status.RunTime Data Table**

Element Number	Type	Tag Name	Description	Range
0	Int16	Assembly_Slot_0_Status_inst_1	Backplane Processor (BF518) Status MPC 0 = Status PASS	0...65,535
	Bit0	Nor Flash	BF518 Nor flash read write failure	
	Bit1	SDRAM Memory	BF518 SDRAM memory failure	
	Bit2	Ethernet MAC	BF518 Ethernet MAC failure	
	Bit3	SPORT Interface	BF518 SPORT communication failure	
	Bit4	ARM9 Heartbeat message Timeout	ARM9 Heartbeat message Timeout	
	Bit5	Backplane info. message Timeout	Backplane info. message Timeout	
	Bit6	Create Connection Message Not Received	MPC BF518 did not receive create connection	
	Bit7	Backplane Connection Status	Backplane connection status 0 = OK 1 = Fail	
1	Int16	Assembly_Slot_0_Status_Inst_2	ARM Processor Status MPC 0 = Status PASS	0...65,535
	Bit0	Nor Flash	ARM9 Nor flash read write failure	
	Bit1	Nand Flash	ARM9 Nand flash read write failure	
	Bit2	SDRAM Memory	ARM9 SDRAM memory failure	
	Bit3	FRAM Memory	ARM9 EEPROM storage failure	
	Bit4	Synchronous Serial Controller (SSC)	ARM9 serial intercommunication failure	
	Bit5	Real Time Clock	ARM9 Real time clock failure	
	Bit6	Ethernet MAC	ARM9 Arm9 Ethernet MAC failure	
	Bit7	Anybus Interface	ARM9 HMS Anybus interface failure	
	Bit8	SPI Serial Interface	ARM9 SPI Intercommunication failure	
	Bit9	USB Memory Stick Failure	ARM9 USB Memory Stick read write failure	
	Bit10	MPC BF518 Heartbeat message Timeout	MPC BF518 Heartbeat message Timeout	
	Bit11	Create Connection Message Not Send	ARM9 did not send create connection to MPC BF518	
	Bit12	SPORT HandShake Not Received	ARM9 did not get MPC BF518 Handshake Signal	
Bit13	No Production Test Data	Production test data not programmed or corrupted		

Table 107 - Status.RunTime Data Table (continued)

Element Number	Type	Tag Name	Description	Range
2	Int16	Assembly_Slot_1_Status_Inst1	Backplane Processor(BF518) of Assembly in slot 1 Status 0 = Status PASS	0...65,535
	Bit0	NOR Flash	BF518 Nor flash read write failure	
	Bit1	SDRAM Memory	BF518 SDRAM memory failure	
	Bit2	Ethernet MAC	BF518 Ethernet MAC failure	
	Bit3	SPORT Communication	BF518 SPORT communication failure	
	Bit4	Sharc Heartbeat message Timeout	Sharc Heartbeat message Timeout	
	Bit5	Backplane info. message Timeout	Backplane info. message Timeout	
	Bit6	ForwardOpen Message Not Received	PDA BF518 did not receive forward open message	
	Bit7	Real Time Data Not Received	PDA BF518 did not receive SHARC message	
3	Int16	Assembly_Slot_1_Status_Inst2	Host Processor(Sharc) of Assembly in slot 1 Status 0 = Status PASS	0...65,535
	Bit0	SDRAM Memory	Sharc SDRAM Memory failure	
	Bit1	AD7606	AD7606 failure	
	Bit2	SPORT Communication	Sharc SPORT communication failure	
	Bit3	MAN_CODE		
	Bit4	DEV_CODE		
	Bit5	NORFLASH	Sharc Nor flash read write failure	
	Bit6	RESET	Sharc Reset failure	
4	Int16	Assembly_Slot_2_Status_Inst1	Backplane Processor of Assembly in slot 2 Status 0 = Status PASS	0...65,535
5	Int16	Assembly_Slot_2_Status_Inst2	Host Processor of Assembly in slot 2 Status 0 = Status PASS	0...65,535
6	Int16	Assembly_Slot_3_Status_Inst1	Backplane Processor of Assembly in slot 3 Status 0 = Status PASS	0...65,535
7	Int16	Assembly_Slot_3_Status_Inst2	Host Processor of Assembly in slot 3 Status 0 = Status PASS	0...65,535
8	Int16	Bootloader_FRN_Slot_0_Inst_1	MPC BF518 bootloader image revision number	0...65,535
9	Int16	Application_FRN_Slot_0_Inst_1	MPC BF518 application image revision number, if the system is running the boot loader image because of application image checksum error, this number is zero	0...65,535
10	Int16	Upgrader_FRN_Slot_0_Inst_1	MPC BF518 boot kernel image revision number	0...65,535
11	Int16	Bootloader_FRN_Slot_0_Inst_2	ARM9 boot level 0 image revision number	0...65,535
12	Int16	Application_FRN_Slot_0_Inst_2	ARM9 application image revision number	0...65,535
13	Int16	Upgrader_FRN_Slot_0_Inst_2	ARM9 boot level 1 image revision number	0...65,535
14	Int16	Bootloader_FRN_Slot_1_Inst_1	PDA BF518 bootloader image revision number	0...65,535
15	Int16	Application_FRN_Slot_1_Inst_1	PDA BF518 application image revision number, if the system is running the boot loader image because of application image checksum error, this number is zero	0...65,535
16	Int16	Upgrader_FRN_Slot_1_Inst_1	PDA BF518 boot kernel image revision number	0...65,535
17	Int16	Bootloader_FRN_Slot_1_Inst_2	SHARC boot loader image revision number	0...65,535
18	Int16	Application_FRN_Slot_1_Inst_2	SHARC application image revision number	0...65,535

**Table 107 - Status.RunTime Data Table (continued)**

<b>Element Number</b>	<b>Type</b>	<b>Tag Name</b>	<b>Description</b>	<b>Range</b>
19	Int16	Upgrader_FRN_Slot_1_Inst_2	SHARC upgrader image revision number	0..65,535
20	Int16	Bootloader_FRN_Slot_2_Inst_1	Current revision level for the slot and instance of processor	0..65,535
21	Int16	Application_FRN_Slot_2_Inst_1	Current revision level for the slot and instance of processor	0..65,535
22	Int16	Upgrader_FRN_Slot_2_Inst_1	Current revision level for the slot and instance of processor	0..65,535
23	Int16	Bootloader_FRN_Slot_2_Inst_2	Current revision level for the slot and instance of processor	0..65,535
24	Int16	Application_FRN_Slot_2_Inst_2	Current revision level for the slot and instance of processor	0..65,535
25	Int16	Upgrader_FRN_Slot_2_Inst_2	Current revision level for the slot and instance of processor	0..65,535
26	Int16	Bootloader_FRN_Slot_3_Inst_1	Current revision level for the slot and instance of processor	0..65,535
27	Int16	Application_FRN_Slot_3_Inst_1	Current revision level for the slot and instance of processor	0..65,535
28	Int16	Upgrader_FRN_Slot_3_Inst_1	Current revision level for the slot and instance of processor	0..65,535
29	Int16	Bootloader_FRN_Slot_3_Inst_2	Current revision level for the slot and instance of processor	0..65,535
30	Int16	Application_FRN_Slot_3_Inst_2	Current revision level for the slot and instance of processor	0..65,535
31	Int16	Upgrader_FRN_Slot_3_Inst_2	Current revision level for the slot and instance of processor	0..65,535
32...73	Int16	Reserved	Future Use.	0

## Status.Discretel0

**Table 108 - Table Properties**

<b>CIP Instance Number</b>	826
<b>PCCC File Number</b>	N35
<b>No. of Elements</b>	112
<b>Length in Words</b>	112
<b>Data Type</b>	Int16
<b>Data Access</b>	Read Only

**Table 109 - Status.Discretel0 Data Table**

Element Number	Type	Tag Name	Description	Range
0	Int16	Status_Input_States	Indicates the overall Status Input Condition	65,535
	Bit 0	Status_Input_1_Actuated	Indicates Status 1 actuated	0 or 1
	Bit 1	Status_Input_2_Actuated	Indicates Status 2 actuated	0 or 1
	Bit 2	Status_Input_3_Actuated	Indicates Status 3 actuated	0 or 1
	Bit 3	Status_Input_4_Actuated	Indicates Status 4 actuated	0 or 1
	Bit 4	KYZ_Output_Energized	Indicates Output KYZ Energized	0 or 1
	Bit 5	KYZ_Forced_On	Software Control Forced On KYZ	0 or 1
	Bit 6	KYZ_Forced_Off	Software Control Forced Off KYZ	0 or 1
	Bit 7	Relay_1_Output_Energized	Indicates Output Relay 1 Energized	0 or 1
	Bit 8	Relay_1_Forced_On	Software Control Forced On Relay 1	0 or 1
	Bit 9	Relay_1_Forced_Off	Software Control Forced Off Relay 1	0 or 1
	Bit 10	Relay_2_Output_Energized	Indicates Output Relay 2 Energized	0 or 1
	Bit 11	Relay_2_Forced_On	Software Control Forced On Relay 2	0 or 1
	Bit 12	Relay_2_Forced_Off	Software Control Forced Off Relay 2	0 or 1
	Bit 13	Relay_3_Output_Energized	Indicates Output Relay 3 Energized	0 or 1
	Bit 14	Relay_3_Forced_On	Software Control Forced On Relay 3	0 or 1
Bit 15	Relay_3_Forced_Off	Software Control Forced Off Relay 3	0 or 1	
1...111	Int16	Reserved	Future Use	0

## Status.Wiring\_Diagnostics

**Table 110 - Table Properties**

<b>CIP Instance Number</b>	829
<b>PCCC File Number</b>	F38
<b>No. of Elements</b>	33
<b>Length in Words</b>	66
<b>Data Type</b>	Real
<b>Data Access</b>	Read Only

**Table 111 - Status.Wiring\_Diagnostics Data Table**

<b>Element Number</b>	<b>Type</b>	<b>Tag Name</b>	<b>Description</b>	<b>Range</b>
0	Real	Command_Status	This is the wiring diagnostics command status. 0 = Command Active 1 = Input Level Low 2 = Disabled 3 = Waiting Command	0...3
1	Real	Voltage_Input_Missing	Reports on all three phases. -1 = Test not run 0 = Test passed 1 = Phase 1 missing 2 = Phase 2 missing 3 = Phase 3 missing 12 = Phase 1 and 2 missing 13 = Phase 1 and 3 missing 23 = Phase 2 and 3 missing 123 = All phases missing	-1...123
2	Real	Current_Input_Missing	Reports on all three phases. -1 = Test not run 0 = Test passed 1 = Phase 1 missing 2 = Phase 2 missing 3 = Phase 3 missing 12 = Phase 1 and 2 missing 13 = Phase 1 and 3 missing 23 = Phase 2 and 3 missing 123 = All phases missing	-1...123
3	Real	Range1_L97_C89_Status	This is the pass fail status for Range 1 diagnostics. 0 = Pass 1 = Failed	0 or 1
4	Real	Range1_Voltage_Input_Inverted	Reports on all three phases. -1 = Test not run 0 = Test passed 1 = Phase 1 inverted 2 = Phase 2 inverted 3 = Phase 3 inverted 12 = Phase 1 and 2 inverted 13 = Phase 1 and 3 inverted 23 = Phase 2 and 3 inverted 123 = All phases inverted	-1...123

**Table 111 - Status.Wiring\_Diagnostics Data Table (continued)**

Element Number	Type	Tag Name	Description	Range
5	Real	Range1_Current_Input_Inverted	Reports on all three phases. -1 = Test not run 0 = Test passed 1 = Phase 1 inverted 2 = Phase 2 inverted 3 = Phase 3 inverted 12 = Phase 1 and 2 inverted 13 = Phase 1 and 3 inverted 23 = Phase 2 and 3 inverted 123 = All phases inverted	-1...123
6	Real	Range1_Voltage_Rotation	Reports on all three phases. The reported sequence represents each phase. 1...321 designating phase and rotation. Example: 123 = Phase 1 then phase 2 then phase 3 -1 = Test not run 4 = Invalid Rotation 5 = Out of range	-1...132
7	Real	Range1_Current_Rotation	Reports on all three phases. The reported sequence represents each phase. 1...321 designating phase and rotation. Example: 123 = Phase 1 then phase 2 then phase 3 -1 = Test not run 4 = Invalid Rotation 5 = Out of range	-1...321
8	Real	Range2_L85_C98_Status	This is the pass fail status for Range 2 diagnostics. 0 = Pass 1 = Failed	0 or 1
9	Real	Range2_Voltage_Input_Inverted	Reports on all three phases. -1 = Test not run 0 = Test passed 1 = Phase 1 inverted 2 = Phase 2 inverted 3 = Phase 3 inverted 12 = Phase 1 and 2 inverted 13 = Phase 1 and 3 inverted 23 = Phase 2 and 3 inverted 123 = All phases inverted	-1...123
10	Real	Range2_Current_Input_Inverted	Reports on all three phases. -1 = Test not run 0 = Test passed 1 = Phase 1 inverted 2 = Phase 2 inverted 3 = Phase 3 inverted 12 = Phase 1 and 2 inverted 13 = Phase 1 and 3 inverted 23 = Phase 2 and 3 inverted 123 = All phases inverted	-1...123
11	Real	Range2_Voltage_Rotation	Reports on all three phases. The reported sequence represents each phase. 1...321 designating phase and rotation. Example: 123 = Phase 1 then phase 2 then phase 3 -1 = Test not run 4 = Invalid Rotation 5 = Out of range	-1...132



**Table 111 - Status.Wiring\_Diagnostics Data Table (continued)**

Element Number	Type	Tag Name	Description	Range
12	Real	Range2_Current_Rotation	Reports on all three phases. The reported sequence represents each phase. 1...321 designating phase and rotation. Example: 123 = Phase 1 then phase 2 then phase 3 -1 = Test not run 4 = Invalid Rotation 5 = Out of range	-1...321
13	Real	Range3_L52_L95_Status	This is the pass fail status for Range 3 diagnostics. 0 = Pass 1 = Failed	0 or 1
14	Real	Range3_Voltage_Input_Inverted	Reports on all three phases. -1 = Test not run 0 = Test passed 1 = Phase 1 inverted 2 = Phase 2 inverted 3 = Phase 3 inverted 12 = Phase 1 and 2 inverted 13 = Phase 1 and 3 inverted 23 = Phase 2 and 3 inverted 123 = All phases inverted	-1...123
15	Real	Range3_Current_Input_Inverted	Reports on all three phases. -1 = Test not run 0 = Test passed 1 = Phase 1 inverted 2 = Phase 2 inverted 3 = Phase 3 inverted 12 = Phase 1 and 2 inverted 13 = Phase 1 and 3 inverted 23 = Phase 2 and 3 inverted 123 = All phases inverted	-1...123
16	Real	Range3_Voltage_Rotation	Reports on all three phases. The reported sequence represents each phase. 1...321 designating phase and rotation. Example: 123 = Phase 1 then phase 2 then phase 3 -1 = Test not run 4 = Invalid Rotation 5 = Out of range	-1...132
17	Real	Range3_Current_Rotation	Reports on all three phases. The reported sequence represents each phase. 1...321 designating phase and rotation. Example: 123 = Phase 1 then phase 2 then phase 3 -1 = Test not run 4 = Invalid Rotation 5 = Out of range	-1...321
18	Real	Voltage_Phase_1_Angle	Shows the present phase angle of this channel. Always 0 degrees for voltage phase 1.	0...359.99
19	Real	Voltage_Phase_1_Magnitude	Shows the present magnitude of this phase.	0...9,999,999
20	Real	Voltage_Phase_2_Angle	Shows the present phase angle of this channel.	0...359.99
21	Real	Voltage_Phase_2_Magnitude	Shows the present magnitude of this phase.	0...9,999,999
22	Real	Voltage_Phase_3_Angle	Shows the present phase angle of this channel.	0...359.99
23	Real	Voltage_Phase_3_Magnitude	Shows the present magnitude of this phase.	0...9,999,999
24	Real	Current_Phase_1_Angle	Shows the present phase angle of this channel.	0...359.99
25	Real	Current_Phase_1_Magnitude	Shows the present magnitude of this phase.	0...9,999,999
26	Real	Current_Phase_2_Angle	Shows the present phase angle of this channel.	0...359.99

**Table 111 - Status.Wiring\_Diagnostics Data Table (continued)**

Element Number	Type	Tag Name	Description	Range
27	Real	Current_Phase_2_Magnitude	Shows the present magnitude of this phase.	0...9,999,999
28	Real	Current_Phase_3_Angle	Shows the present phase angle of this channel.	0...359.99
29	Real	Current_Phase_3_Magnitude	Shows the present magnitude of this phase.	0...9,999,999
30...32	Real	Reserved	Reserved for future use.	0

## Status.TableWrites

**Table 112 - Table Properties**

<b>CIP Instance Number</b>	830
<b>PCCC File Number</b>	N39
<b>No. of Elements</b>	13
<b>Length in Words</b>	13
<b>Data Type</b>	Int16
<b>Data Access</b>	Read Only

**Table 113 - Status.TableWrites Data Table**

Element Number	Type	Tag Name	Description	Range
0	Int16	Table_Number_or_Instance	Indicates the last table that was written.	0...1136
1	Int16	Offending_Element	If the most recent write was successful this returns a (-1). If the write was unsuccessful this is the first rejected element in the table write.	-1...256
2	Int16	Configuration_Lock_On	If a write was made to a table that has elements that are locked this value is 1.	0 or 1
3	Int16	Password_is_not_validated	A write to a table could not be performed because the password is not validated or active.	0 or 1
4	Int16	Password_Activated	The password is active by user. Bit 0 set: AdminType Activated Bit 1 set: ApplicationType Activated Bit 2 set: UserType Activated	0...7
5	Int16	Admin_Name_Or_Password_Rejected	Admin type account rejected.	0 or 1
6	Int16	Admin_Password_Active	Admin type account active.	0 or 1
7	Int16	Application_Name_Or_Password_Rejected	Application type account rejected.	0 or 1
8	Int16	Application_Password_Active	Application type account active.	0 or 1
9	Int16	UserType_Name_Or_Password_Rejected	User type account rejected.	0 or 1
10	Int16	User_Password_Active	User type account active.	0 or 1
11	Int16	Security_Status	0 = disabled 1 = enabled	0 or 1
12	Int16	Exclusive_Ownership_Conflict	Bit 0 = 0: No Exclusive ownership conflict Bit 0 = 1: Exclusive ownership conflict, IO configuration only controlled by logix controller Bit 1: File deletion conflict	0...3

## Status.InformationTable

**Table 114 - Table Properties**

<b>CIP Instance Number</b>	831
<b>PCCC File Number</b>	ST40
<b>No. of Elements</b>	10
<b>Length in Words</b>	112
<b>Data Type</b>	String
<b>Data Access</b>	Read Only

**Table 115 - Status.InformationTable Data Table**

<b>Element Number</b>	<b>Size Bytes</b>	<b>Type</b>	<b>Tag Name</b>	<b>Description</b>	<b>Range</b>
0	20	String	Catalog Number	The unit catalog number example.	0...255
1	20	String	Serial Number	The serial number for warranty information.	0...255
2	32	String	Device Name	A name the user can provide this device.	0...255
3	32	String	Device Location	The location for this device.	0...255
4	20	String	Original_Catalog_Number	The unit catalog number in production	0...255
5...9	20	String	Reserved	Reserved for future use	0

## Status.Alarms

**Table 116 - Table Properties**

<b>CIP Instance Number</b>	832
<b>PCCC File Number</b>	N41
<b>No. of Elements</b>	32
<b>Length in Words</b>	32
<b>Data Type</b>	Int16
<b>Data Access</b>	Read Only

**Table 117 - Status.Alarms Data Table**

Element Number	Type	Tag Name	Description	Range
0	Int16	Setpoints_1_10_Active	Actuation Status of Setpoints 1...10	0...65,535
	Bit 0	Setpoint1_Active	1 Indicates the setpoint 1 is Active	0 or 1
	Bit 1	Setpoint2_Active	1 Indicates the setpoint 2 is Active	0 or 1
	Bit 2	Setpoint3_Active	1 Indicates the setpoint 3 is Active	0 or 1
	Bit 3	Setpoint4_Active	1 Indicates the setpoint 4 is Active	0 or 1
	Bit 4	Setpoint5_Active	1 Indicates the setpoint 5 is Active	0 or 1
	Bit 5	Setpoint6_Active	1 Indicates the setpoint 6 is Active	0 or 1
	Bit 6	Setpoint7_Active	1 Indicates the setpoint 7 is Active	0 or 1
	Bit 7	Setpoint8_Active	1 Indicates the setpoint 8 is Active	0 or 1
	Bit 8	Setpoint9_Active	1 Indicates the setpoint 9 is Active	0 or 1
	Bit 9	Setpoint10_Active	1 Indicates the setpoint 10 is Active	0 or 1
	Bit 10...15	Reserved	Reserved for future use	0
1	Int16	Setpoints_11_20_Active (M6 and M8)	Actuation Status of Setpoints 11...20	0...65,535
	Bit 0	Setpoint11_Active	1 Indicates the setpoint 11 is Active	0 or 1
	Bit 1	Setpoint12_Active	1 Indicates the setpoint 12 is Active	0 or 1
	Bit 2	Setpoint13_Active	1 Indicates the setpoint 13 is Active	0 or 1
	Bit 3	Setpoint14_Active	1 Indicates the setpoint 14 is Active	0 or 1
	Bit 4	Setpoint15_Active	1 Indicates the setpoint 15 is Active	0 or 1
	Bit 5	Setpoint16_Active	1 Indicates the setpoint 16 is Active	0 or 1
	Bit 6	Setpoint17_Active	1 Indicates the setpoint 17 is Active	0 or 1
	Bit 7	Setpoint18_Active	1 Indicates the setpoint 18 is Active	0 or 1
	Bit 8	Setpoint19_Active	1 Indicates the setpoint 19 is Active	0 or 1
	Bit 9	Setpoint20_Active	1 Indicates the setpoint 20 is Active	0 or 1
	Bit 10...15	Reserved	Future Use	0

**Table 117 - Status.Alarms Data Table (continued)**

Element Number	Type	Tag Name	Description	Range
2	Int16	Logic_Level_1_Gates_Active (M6 and M8)	Actuation Status of Level 1 Gates	0 ... 65535
	Bit 0	Level1_Gate1_Output	1 Indicates gate logic output is true	0 or 1
	Bit 1	Level1_Gate2_Output	1 Indicates gate logic output is true	0 or 1
	Bit 2	Level1_Gate3_Output	1 Indicates gate logic output is true	0 or 1
	Bit 3	Level1_Gate4_Output	1 Indicates gate logic output is true	0 or 1
	Bit 4	Level1_Gate5_Output	1 Indicates gate logic output is true	0 or 1
	Bit 5	Level1_Gate6_Output	1 Indicates gate logic output is true	0 or 1
	Bit 6	Level1_Gate7_Output	1 Indicates gate logic output is true	0 or 1
	Bit 7	Level1_Gate8_Output	1 Indicates gate logic output is true	0 or 1
	Bit 8	Level1_Gate9_Output	1 Indicates gate logic output is true	0 or 1
	Bit 9	Level1_Gate10_Output	1 Indicates gate logic output is true	0 or 1
	Bit 10 ... 15	Reserved	Future Use	0
3	Int16	Metering_Status	Metering Conditions Status	0...65,535
	Bit 0	Virtual_Wiring_Correction	1 = Virtual Wiring Correction ON	0...1
	Bit 1	Volts_Loss_V1	1 = Loss of V1 metering voltage	0...1
	Bit 2	Volts_Loss_V2	1 = Loss of V2 metering voltage	0...1
	Bit 3	Volts_Loss_V3	1 = Loss of V3 metering voltage	0...1
	Bit 4	Volts_Over_Range_Indication	1 = A Voltage over range status condition exists	0...1
	Bit 5	Amps_Over_Range_Indication	1 = An Amperage over range status condition exists	0...1
	Bit 6	Wiring_Diagnostics_Active	1 = The wiring diagnostics is currently calculating wiring condition	0...1
	Bit 7...15	Reserved	Reserved for future use	0
4	Int16	Over_Range_Information	Indicates which input is over range	0...65,535
	Bit 0	V1G_Over_Range	1 = V1G input is over input range	0...1
	Bit 1	V2G_Over_Range	1 = V2G input is over input range	0...1
	Bit 2	V3G_Over_Range	1 = V3G input is over input range	0...1
	Bit 3	VNG_Over_Range	1 = VNG input is over input range	0...1
	Bit 4	I1_Over_Range	1 = I1 input is over input range	0...1
	Bit 5	I2_Over_Range	1 = I2 input is over input range	0...1
	Bit 6	I3_Over_Range	1 = I3 input is over input range	0...1
	Bit 7	I4_Over_Range	1 = I4 input is over input range	0...1
	Bit 8...15	Reserved	Reserved for future use	0

**Table 117 - Status.Alarms Data Table (continued)**

Element Number	Type	Tag Name	Description	Range
5	Int16	PowerQuality_Status	Power Quality Conditions Status	0...65,535
	Bit 0	Sag_Indication_Detected	1 = A sag event was detected in the last metering cycle	0...1
	Bit 1	Swell_Indication_Detected	1 = A Swell event was detected in the last metering cycle	0...1
	Bit 2	Transient_Indication	A transient occurred	0...1
	Bit 3	200mS_Sag_Swell_Status_Flag	A flag indicating 200 ms result has been calculated during a Sag, Swell, or Interruption	0...1
	Bit 4	3s_Sag_Swell_Status_Flag	A flag indicating the 3 s result has been calculated during a Sag, Swell, or Interruption	0...1
	Bit 5	10m_Sag_Swell_Status_Flag	A flag indicating the 10 min result has been calculated during a Sag, Swell, or Interruption	0...1
	Bit 6	2h_Sag_Swell_Status_Flag	A flag indicating the 2h result has been calculated during a Sag, Swell, or Interruption	0...1
Bit 7...15	Reserved	Reserved for future use	0	
6	Int16	Logs_Status	Logs Condition Status	0... 65,535
	Bit 0	Data_Log_Full_Fill_And_Stop	Is Set when fill and stop is configured and log is at least 80% filled	0...1
	Bit 1	Event_Log_Full_Fill_And_Stop	Is Set when fill and stop is configured and log is at least 80% filled	0...1
	Bit 2	Setpoint_Log_Full_Fill_And_Stop	Is Set when fill and stop is configured and log is at least 80% filled	0...1
	Bit 3	PowerQuality_Log_Full_Fill_And_Stop	Is Set when fill and stop is configured and log is at least 80% filled	0...1
	Bit 4	Energy_Log_Full_Fill_And_Stop	Is Set when fill and stop is configured and log is at least 80% filled	0...1
	Bit 5	Waveform_Full	Is Set when log is at least 80% filled	0...1
	Bit 6	TriggerData_Full_Fill_And_Stop	Is Set when fill and stop is configured and log is at least 80% filled	0...1
	Bit 7...15	Reserved	Reserved for future use	0
7	Int16	Output_Pulse_Ovrrun	The output pulse rate exceeds the configured capability	0...65535
	Bit 0	KYZ_Pulse_Ovrrun	The KYZ output pulse rate exceeds the configured capability	0...1
	Bit 1	Relay1_Pulse_Ovrrun	The Relay 1 output pulse rate exceeds the configured capability	
	Bit 2	Relay2_Pulse_Ovrrun	The Relay 2 output pulse rate exceeds the configured capability	
	Bit 3	Relay3_Pulse_Ovrrun	The Relay 3 output pulse rate exceeds the configured capability	
	Bit 4...15	Reserved	Reserved for future use	0
8	Int16	IEEE1159_Over_Voltage	Over Voltage Condition	0...65535
	Bit 0	IEEE1159_Over_Voltage_V1	1 = An over voltage is detected on V1	0...1
	Bit 1	IEEE1159_Over_Voltage_V2	1 = An over voltage is detected on V2	0...1
	Bit 2	IEEE1159_Over_Voltage_V3	1 = An over voltage is detected on V3	0...1
	Bit 3...15	Reserved	Reserved for future use	0

**Table 117 - Status.Alarms Data Table (continued)**

Element Number	Type	Tag Name	Description	Range
9	Int16	IEEE1159_Under_Voltage	Under Voltage Condition	0...65535
	Bit 0	IEEE1159_Under_Voltage_V1	1 = An under voltage is detected on V1	0...1
	Bit 1	IEEE1159_Under_Voltage_V2	1 = An under voltage is detected on V2	0...1
	Bit 2	IEEE1159_Under_Voltage_V3	1 = An under voltage is detected on V3	0...1
	Bit 3...15	Reserved	Reserved for future use	0
10	Int16	IEEE1159_Imbalance_Condition	IEEE1159 Imbalance	0...65535
	Bit 0	IEEE1159_Imbalance_Condition_Volts	1 = An Imbalance is detected on Voltage	0...1
	Bit 1	IEEE1159_Imbalance_Condition_Current	1 = An Imbalance is detected on Current	0...1
	Bit 2...15	Reserved	Reserved for future use	0
11	Int16	IEEE1159_DCOffset_Condition	IEEE1159 DC Offset Condition	0...65535
	Bit 0	IEEE1159_DCOffset_Condition_V1	1 = A DC offset exceed limitation is detected on V1	0...1
	Bit 1	IEEE1159_DCOffset_Condition_V2	1 = A DC offset exceed limitation is detected on V2	0...1
	Bit 2	IEEE1159_DCOffset_Condition_V3	1 = A DC offset exceed limitation is detected on V3	0...1
	Bit 3...15	Reserved	Reserved for future use	0
12	Int16	IEEE1159_Voltage_THD_Condition	IEEE1159 Voltage THD Condition	0...65535
	Bit 0	IEEE1159_Voltage_THD_Condition_V1	1 = A THD exceed limitation is detected on V1	0...1
	Bit 1	IEEE1159_Voltage_THD_Condition_V2	1 = A THD exceed limitation is detected on V2	0...1
	Bit 2	IEEE1159_Voltage_THD_Condition_V3	1 = A THD exceed limitation is detected on V3	0...1
	Bit 3	IEEE1159_Voltage_TID_Condition_V1	1 = A TID exceed limitation is detected on V1	0...1
	Bit 4	IEEE1159_Voltage_TID_Condition_V2	1 = A TID exceed limitation is detected on V2	0...1
	Bit 5	IEEE1159_Voltage_TID_Condition_V3	1 = A TID exceed limitation is detected on V3	0...1
	Bit 6...15	Reserved	Reserved for future use	0
13	Int16	IEEE1159_Current_THD_Condition	IEEE1159 Current THD Condition	0...65535
	Bit 0	IEEE1159_Current_THD_Condition_I1	1 = A THD exceed limitation is detected on I1	0...1
	Bit 1	IEEE1159_Current_THD_Condition_I2	1 = A THD exceed limitation is detected on I2	0...1
	Bit 2	IEEE1159_Current_THD_Condition_I3	1 = A THD exceed limitation is detected on I3	0...1
	Bit 3	IEEE1159_Current_THD_Condition_I4	1 = A THD exceed limitation is detected on I4	0...1
	Bit 4	IEEE1159_Current_TID_Condition_I1	1 = A TID exceed limitation is detected on I1	0...1
	Bit 5	IEEE1159_Current_TID_Condition_I2	1 = A TID exceed limitation is detected on I2	0...1
	Bit 6	IEEE1159_Current_TID_Condition_I3	1 = A TID exceed limitation is detected on I3	0...1
	Bit 7	IEEE1159_Current_TID_Condition_I4	1 = A TID exceed limitation is detected on I4	0...1
Bit 8...15	Reserved	Reserved for future use	0	
14	Int16	IEEE1159_PowerFrequency_Condition	IEEE1159 Power Frequency Condition	0...65535
	Bit 0	IEEE1159_PowerFrequency_Condition	1 = Frequency exceed limitation is detected	0...1
	Bit 1...15	Reserved	Reserved for future use	0

**Table 117 - Status.Alarms Data Table (continued)**

Element Number	Type	Tag Name	Description	Range
15	Int16	IEEE519_Overall_Status	IEEE519 Overall Status	0...65535
	Bit 0	ShortTerm_TDD_THD_PASS_FAIL	1= Fail, 0=Pass	0...1
	Bit 1	LongTerm_TDD_THD_PASS_FAIL	1= Fail, 0=Pass	0...1
	Bit 2	ShortTerm_Individual_Harmonic_PASS_FAIL	1= Fail, 0=Pass	0...1
	Bit 3	LongTerm_Individual_Harmonic_PASS_FAIL	1= Fail, 0=Pass	0...1
	Bit 4...15	Reserved	Reserved for future use	0
16	Int16	ShortTerm_2nd_To_17th_Harmonic_Status	ShortTerm 2nd To 17th Harmonic Status	0...65535
	Bit 0	2nd_Harmonic_PASS_FAIL	1= Fail, 0=Pass	0...1
	Bit 1	3rd_Harmonic_PASS_FAIL	1= Fail, 0=Pass	0...1
	Bit 2	4th_Harmonic_PASS_FAIL	1= Fail, 0=Pass	0...1
	Bit 3	5th_Harmonic_PASS_FAIL	1= Fail, 0=Pass	0...1
	Bit 4	6th_Harmonic_PASS_FAIL	1= Fail, 0=Pass	0...1
	Bit 5	7th_Harmonic_PASS_FAIL	1= Fail, 0=Pass	0...1
	Bit 6	8th_Harmonic_PASS_FAIL	1= Fail, 0=Pass	0...1
	Bit 7	9th_Harmonic_PASS_FAIL	1= Fail, 0=Pass	0...1
	Bit 8	10th_Harmonic_PASS_FAIL	1= Fail, 0=Pass	0...1
	Bit 9	11th_Harmonic_PASS_FAIL	1= Fail, 0=Pass	0...1
	Bit 10	12th_Harmonic_PASS_FAIL	1= Fail, 0=Pass	0...1
	Bit 11	13th_Harmonic_PASS_FAIL	1= Fail, 0=Pass	0...1
	Bit 12	14th_Harmonic_PASS_FAIL	1= Fail, 0=Pass	0...1
	Bit 13	15th_Harmonic_PASS_FAIL	1= Fail, 0=Pass	0...1
	Bit 14	16th_Harmonic_PASS_FAIL	1= Fail, 0=Pass	0...1
Bit 15	17th_Harmonic_PASS_FAIL	1= Fail, 0=Pass	0...1	



**Table 117 - Status.Alarms Data Table (continued)**

Element Number	Type	Tag Name	Description	Range
17	Int16	ShortTerm_18th_To_33rd_Harmonic_Status	ShortTerm 18th To 33rd Harmonic Status	0...65535
	Bit 0	18th_Harmonic_PASS_FAIL	1= Fail, 0=Pass	0...1
	Bit 1	19th_Harmonic_PASS_FAIL	1= Fail, 0=Pass	0...1
	Bit 2	20th_Harmonic_PASS_FAIL	1= Fail, 0=Pass	0...1
	Bit 3	21st_Harmonic_PASS_FAIL	1= Fail, 0=Pass	0...1
	Bit 4	22nd_Harmonic_PASS_FAIL	1= Fail, 0=Pass	0...1
	Bit 5	23rd_Harmonic_PASS_FAIL	1= Fail, 0=Pass	0...1
	Bit 6	24th_Harmonic_PASS_FAIL	1= Fail, 0=Pass	0...1
	Bit 7	25th_Harmonic_PASS_FAIL	1= Fail, 0=Pass	0...1
	Bit 8	26th_Harmonic_PASS_FAIL	1= Fail, 0=Pass	0...1
	Bit 9	27th_Harmonic_PASS_FAIL	1= Fail, 0=Pass	0...1
	Bit 10	28th_Harmonic_PASS_FAIL	1= Fail, 0=Pass	0...1
	Bit 11	29th_Harmonic_PASS_FAIL	1= Fail, 0=Pass	0...1
	Bit 12	30th_Harmonic_PASS_FAIL	1= Fail, 0=Pass	0...1
	Bit 13	31st_Harmonic_PASS_FAIL	1= Fail, 0=Pass	0...1
	Bit 14	32nd_Harmonic_PASS_FAIL	1= Fail, 0=Pass	0...1
Bit 15	33rd_Harmonic_PASS_FAIL	1= Fail, 0=Pass	0...1	
18	Int16	ShortTerm_34th_To_40th_Harmonic_Status	ShortTerm 34th To 40th Harmonic Status	0...65535
	Bit 0	34th_Harmonic_PASS_FAIL	1= Fail, 0=Pass	0...1
	Bit 1	35th_Harmonic_PASS_FAIL	1= Fail, 0=Pass	0...1
	Bit 2	36th_Harmonic_PASS_FAIL	1= Fail, 0=Pass	0...1
	Bit 3	37th_Harmonic_PASS_FAIL	1= Fail, 0=Pass	0...1
	Bit 4	38th_Harmonic_PASS_FAIL	1= Fail, 0=Pass	0...1
	Bit 5	39th_Harmonic_PASS_FAIL	1= Fail, 0=Pass	0...1
	Bit 6	40th_Harmonic_PASS_FAIL	1= Fail, 0=Pass	0...1
	Bit 7...15	Reserved	Reserved for future use	0

**Table 117 - Status.Alarms Data Table (continued)**

Element Number	Type	Tag Name	Description	Range
19	Int16	LongTerm_2nd_To_17th_Harmonic_Status	LongTerm 2nd To 17th Harmonic Status	0...65535
	Bit 0	2nd_Harmonic_PASS_FAIL	1= Fail, 0=Pass	0...1
	Bit 1	3rd_Harmonic_PASS_FAIL	1= Fail, 0=Pass	0...1
	Bit 2	4th_Harmonic_PASS_FAIL	1= Fail, 0=Pass	0...1
	Bit 3	5th_Harmonic_PASS_FAIL	1= Fail, 0=Pass	0...1
	Bit 4	6th_Harmonic_PASS_FAIL	1= Fail, 0=Pass	0...1
	Bit 5	7th_Harmonic_PASS_FAIL	1= Fail, 0=Pass	0...1
	Bit 6	8th_Harmonic_PASS_FAIL	1= Fail, 0=Pass	0...1
	Bit 7	9th_Harmonic_PASS_FAIL	1= Fail, 0=Pass	0...1
	Bit 8	10th_Harmonic_PASS_FAIL	1= Fail, 0=Pass	0...1
	Bit 9	11th_Harmonic_PASS_FAIL	1= Fail, 0=Pass	0...1
	Bit 10	12th_Harmonic_PASS_FAIL	1= Fail, 0=Pass	0...1
	Bit 11	13th_Harmonic_PASS_FAIL	1= Fail, 0=Pass	0...1
	Bit 12	14th_Harmonic_PASS_FAIL	1= Fail, 0=Pass	0...1
	Bit 13	15th_Harmonic_PASS_FAIL	1= Fail, 0=Pass	0...1
Bit 14	16th_Harmonic_PASS_FAIL	1= Fail, 0=Pass	0...1	
Bit 15	17th_Harmonic_PASS_FAIL	1= Fail, 0=Pass	0...1	
20	Int16	LongTerm_18th_To_33rd_Harmonic_Status	LongTerm 18th To 33rd Harmonic Status	0...65535
	Bit 0	18th_Harmonic_PASS_FAIL	1= Fail, 0=Pass	0...1
	Bit 1	19th_Harmonic_PASS_FAIL	1= Fail, 0=Pass	0...1
	Bit 2	20th_Harmonic_PASS_FAIL	1= Fail, 0=Pass	0...1
	Bit 3	21st_Harmonic_PASS_FAIL	1= Fail, 0=Pass	0...1
	Bit 4	22nd_Harmonic_PASS_FAIL	1= Fail, 0=Pass	0...1
	Bit 5	23rd_Harmonic_PASS_FAIL	1= Fail, 0=Pass	0...1
	Bit 6	24th_Harmonic_PASS_FAIL	1= Fail, 0=Pass	0...1
	Bit 7	25th_Harmonic_PASS_FAIL	1= Fail, 0=Pass	0...1
	Bit 8	26th_Harmonic_PASS_FAIL	1= Fail, 0=Pass	0...1
	Bit 9	27th_Harmonic_PASS_FAIL	1= Fail, 0=Pass	0...1
	Bit 10	28th_Harmonic_PASS_FAIL	1= Fail, 0=Pass	0...1
	Bit 11	29th_Harmonic_PASS_FAIL	1= Fail, 0=Pass	0...1
	Bit 12	30th_Harmonic_PASS_FAIL	1= Fail, 0=Pass	0...1
	Bit 13	31st_Harmonic_PASS_FAIL	1= Fail, 0=Pass	0...1
Bit 14	32nd_Harmonic_PASS_FAIL	1= Fail, 0=Pass	0...1	
Bit 15	33rd_Harmonic_PASS_FAIL	1= Fail, 0=Pass	0...1	

**Table 117 - Status.Alarms Data Table (continued)**

Element Number	Type	Tag Name	Description	Range
21	Int16	LongTerm_34th_To_40th_Harmonic_Status	LongTerm 34th To 40th Harmonic Status	0...65535
	Bit 0	34th_Harmonic_PASS_FAIL	1= Fail, 0=Pass	0...1
	Bit 1	35th_Harmonic_PASS_FAIL	1= Fail, 0=Pass	0...1
	Bit 2	36th_Harmonic_PASS_FAIL	1= Fail, 0=Pass	0...1
	Bit 3	37th_Harmonic_PASS_FAIL	1= Fail, 0=Pass	0...1
	Bit 4	38th_Harmonic_PASS_FAIL	1= Fail, 0=Pass	0...1
	Bit 5	39th_Harmonic_PASS_FAIL	1= Fail, 0=Pass	0...1
	Bit 6	40th_Harmonic_PASS_FAIL	1= Fail, 0=Pass	0...1
	Bit 7...15	Reserved	Reserved for future use	0
22	Int16	IEEE1159_Voltage_Fluctuation_Condition	Voltage fluctuation for short term exceeds Pst limit	0...65535
	Bit 0	IEEE1159_Voltage_Fluctuation_V1	1 = Pst limit exceeded on V1	0...1
	Bit 1	IEEE1159_Voltage_Fluctuation_V2	1 = Pst limit exceeded on V2	0...1
	Bit 2	IEEE1159_Voltage_Fluctuation_V3	1 = Pst limit exceeded on V3	0...1
	Bit 3...15	Reserved	Reserved for future use	0
23	Int16	EN61000_4_30_Mains_Signaling_Condition	The mains signaling voltage exceeds the set limit	0...65535
	Bit 0	EN61000_4_30_Mains_Signaling_V1	1 = Mains signaling voltage exceeded on V1	0...1
	Bit 1	EN61000_4_30_Mains_Signaling_V2	1 = Mains signaling voltage exceeded on V2	0...1
	Bit 2	EN61000_4_30_Mains_Signaling_V3	1 = Mains signaling voltage exceeded on V3	0...1
	Bit 3...15	Reserved	Reserved for future use	0
24	Int16	EN61000_4_30_Under_Deviation_Condition	Deviation is under the configured limit	0...65535
	Bit 0	EN61000_4_30_Under_Deviation_V1	1 = An under deviation is detected on V1	0...1
	Bit 1	EN61000_4_30_Under_Deviation_V2	1 = An under deviation is detected on V2	0...1
	Bit 2	EN61000_4_30_Under_Deviation_V3	1 = An under deviation is detected on V3	0...1
	Bit 3...15	Reserved	Reserved for future use	0
25	Int 16	EN61000_4_30_Over_Deviation_Condition	Deviation is over the configured limit	0...65535
	Bit 0	EN61000_4_30_Over_Deviation_V1	1 = An over deviation is detected on V1	0...1
	Bit 1	EN61000_4_30_Over_Deviation_V2	1 = An over deviation is detected on V2	0...1
	Bit 2	EN61000_4_30_Over_Deviation_V3	1 = An over deviation is detected on V3	0...1
	Bit 3...15	Reserved	Reserved for future use	0
26...31	Int16	Reserved	Reserved for future use	0

## Status.OptionalComm

Table 118 - Table Properties

<b>CIP Instance Number</b>	835
<b>PCCC File Number</b>	N44
<b>No. of Elements</b>	30
<b>Length in Words</b>	30
<b>Data Type</b>	Int16
<b>Data Access</b>	Read Only

Table 119 - Status.OptionalComm Data Table

Element Number	Type	Tag Name	Description	Units	Range
0	Int16	Network_Type	0x25 = DeviceNet 0x65 = ControlNet 0x85 = EtherNet/IP™	-	0 ... 255
1	Int16	Firmware_Version	Optional communication firmware version	Network_Type dependent	0 ... 255
2	Int16	Firmware_Build	Optional communication firmware build	Network_Type dependent	0
3	Int16	Serial_Low_Word	Low 16-bit serial number	-	0
4	Int16	Serial_High_Word	High 16-bit serial number	-	0
5	Int16	Optional_Port_Status	Bit 0 ... 2: Current status of Anybus module 000: SETUP 001: NW_INIT 010: WAIT_PROCESS 011: IDLE 100: PROCESS_ACTIVE 101: ERROR 110: reserved 111: EXCEPTION	-	0 ... 7
			Bit 3: SUP bit 0: Module is not supervised 1: Module is supervised		0 or 1
			Bit 4 ... 14 reserved for future use		0
			Bit 15: Watchdog Timeout indicator 0: The application and ABCC communicate normally 1: The application lost the communication with ABCC module		0 or 1
6	Int16	Exception_Code	Last exception 0 = No exception 1 = Application timeout 2 = Invalid device address 3 = Invalid communication setting 4 = Major unrecoverable app event 5 = wait for reset 6 = Invalid process data config 7 = Invalid application response 8 = Non-volatile memory checksum error Other value = reserved	-	0 ... 8

**Table 119 - Status.OptionalComm Data Table (continued)**

Element Number	Type	Tag Name	Description	Units	Range
7	Int16	Event 1 Severity	Severity data for Events 1...6: 0x00 = Minor, recoverable 0x10 = Minor, unrecoverable 0x20 = Major, recoverable 0x30 = Major, unrecoverable	-	0x00...0x30
8	Int16	Event 1 Code	Event code for Events 1...6: 10h Generic Error	-	0x10...0xF0
9	Int16	Event 2 Severity	20h Current	-	0x00...0x30
10	Int16	Event 2 Code	21h Current, device input side	-	0x10...0xF0
11	Int16	Event 3 Severity	22h Current, inside the device 23h Current, device output side	-	0x00...0x30
12	Int16	Event 3 Code	30h Voltage	-	0x10...0xF0
13	Int16	Event 4 Severity	31h Mains Voltage - 32h Voltage inside the device	-	0x00...0x30
14	Int16	Event 4 Code	33h Output Voltage	-	0x10...0xF0
15	Int16	Event 5 Severity	40h Temperature	-	0x00...0x30
16	Int16	Event 5 Code	41h Ambient Temperature 42h Device Temperature	-	0x10...0xF0
17	Int16	Event 6 Severity	50h Device Hardware	-	0x00...0x30
18	Int16	Event 6 Code	60h Device Software 61h Internal Software 62h User Software 63h Data Set - 70h Additional Modules 80h Monitoring 81h Communication 82h Protocol Error 90h External Error F0h Additional Functions	-	0x10...0xF0
19...29	Int16	Reserved	Future Use	0	0

## Status.Wiring\_Corrections

Table 120 - Table Properties

<b>CIP Instance Number</b>	834
<b>PCCC File Number</b>	N43
<b>No. of Elements</b>	14
<b>Length in Words</b>	14
<b>Data Type</b>	Int16
<b>Data Access</b>	Read Only

Table 121 - Status.Wiring\_Corrections Data Table

Element Number	Type	Tag Name	Description	Default	Range
0	Int16	Wiring_Correction_Commands	0 = No command 1 = Correct wiring by using Range 1 results, Lagging 97 PF to Leading 89 PF 2 = Correct wiring by using Range 2 results, Lagging 85 PF to leading 98 PF 3 = Correct wiring by using Range 3 results, Lagging 52 PF to lagging 95 PF 4 = Correct wiring by using manual input parameters 5 = Remove all wiring corrections	0	0...5
1	Int16	Input_V1_Mapping	This parameter logically maps a physical voltage channel to V1. 1 = V1 2 = V2 3 = V3 -1 = V1 inverted -2 = V2 inverted -3 = V3 inverted	1	-3...-1 1...3
2	Int16	Input_V2_Mapping	This parameter logically maps a physical voltage channel to V2. 1 = V1 2 = V2 3 = V3 -1 = V1 inverted -2 = V2 inverted -3 = V3 inverted	2	-3...-1 1...3
3	Int16	Input_V3_Mapping	This parameter logically maps a physical voltage channel to V3. 1 = V1 2 = V2 3 = V3 -1 = V1 inverted -2 = V2 inverted -3 = V3 inverted	3	-3...-1 1...3
4	Int16	Input_I1_Mapping	This parameter logically maps a physical current channel to I1. 1 = I1 2 = I2 3 = I3 -1 = I1 inverted -2 = I2 inverted -3 = I3 inverted	1	-3...-1 1...3

**Table 121 - Status.Wiring\_Corrections Data Table (continued)**

Element Number	Type	Tag Name	Description	Default	Range
5	Int16	Input_I2_Mapping	This parameter logically maps a physical current channel to I2. 1 = I1 2 = I2 3 = I3 -1 = I1 inverted -2 = I2 inverted -3 = I3 inverted	2	-3...-1 1...3
6	Int16	Input_I3_Mapping	This parameter logically maps a physical current channel to I3. 1 = I1 2 = I2 3 = I3 -1 = I1 inverted -2 = I2 inverted -3 = I3 inverted	3	-3...-1 1...3
7	Int16	Last_Cmd_Rejection_Status	0 = No rejection 1 = Rejected see rejection status	0	0...1
8	Int16	Rejection_Information	0 = No information 1 = Selected range is incomplete 2 = Command is already active. Use command 5 to start over 3 = Two like inputs wired to one terminal 4 = Invalid Input parameter	0	0...4
9...13	Int16	Reserved	Future Use	0	0

## Status.IEEE1588 (M6 and M8 model)

Table 122 - Table Properties

<b>CIP Instance Number</b>	873
<b>PCCC File Number</b>	N82
<b>No. of Elements</b>	45
<b>Length in Words</b>	45
<b>Data Type</b>	INT16
<b>Data Access</b>	Read Only

Table 123 - Status.IEEE1588 Data Table (M6 and M8 model)

Element Number	Type	Tag Name	Description	Range
0	Int16	IEEE1588_Version	IEEE1588 Version 2	2
1	Int16	PTPEnable	PTPEnable specifies the enable status for the Precision Time Protocol on the device.	0,1
2	Int16	IsSynchronized	IsSynchronized specifies whether the local clock is synchronized with a master reference clock. The value is 1 if the local clock is synchronized and 0 if the local clock is not synchronized. A clock is synchronized if it has one port in the slave state and is receiving updates from the time master.	0,1
3	Int16	SystemTimeNanoseconds_A	SystemTimeNanoseconds specifies a 64-bit value of the current system time in units of nanoseconds. (Bit 0 to bit 15)	0...0xffff
4	Int16	SystemTimeNanoseconds_B	SystemTimeNanoseconds specifies a 64-bit value of the current system time in units of nanoseconds. (Bit 16 to bit 31)	0...0xffff
5	Int16	SystemTimeNanoseconds_C	SystemTimeNanoseconds specifies a 64-bit value of the current system time in units of nanoseconds. (Bit 32 to bit 47)	0...0xffff
6	Int16	SystemTimeNanoseconds_D	SystemTimeNanoseconds specifies a 64-bit value of the current system time in units of nanoseconds. (Bit 48 to bit 63)	0...0xffff
7	Int16	OffsetFromMaster_A	OffsetFromMaster specifies the amount of deviation between the local clock and its master clock in nanoseconds. (Bit 0 to bit 15)	0...0xffff
8	Int16	OffsetFromMaster_B	OffsetFromMaster specifies the amount of deviation between the local clock and its master clock in nanoseconds. (Bit 16 to bit 31)	0...0xffff
9	Int16	OffsetFromMaster_C	OffsetFromMaster specifies the amount of deviation between the local clock and its master clock in nanoseconds. (Bit 32 to bit 47)	0...0xffff
10	Int16	OffsetFromMaster_D	OffsetFromMaster specifies the amount of deviation between the local clock and its master clock in nanoseconds. (Bit 48 to bit 63)	0...0xffff
11	Int16	MaxOffsetFromMaster_A	MaxOffsetFromMaster specifies the absolute value of the maximum amount of deviation between the local clock and the master clock in nanoseconds since last set. (Bit 0 to bit 15)	0...0xffff
12	Int16	MaxOffsetFromMaster_B	MaxOffsetFromMaster specifies the absolute value of the maximum amount of deviation between the local clock and the master clock in nanoseconds since last set. (Bit 16 to bit 31)	0...0xffff
13	Int16	MaxOffsetFromMaster_C	MaxOffsetFromMaster specifies the absolute value of the maximum amount of deviation between the local clock and the master clock in nanoseconds since last set. (Bit 32 to bit 47)	0...0xffff
14	Int16	MaxOffsetFromMaster_D	MaxOffsetFromMaster specifies the absolute value of the maximum amount of deviation between the local clock and the master clock in nanoseconds since last set. (Bit 48 to bit 63)	0...0xffff
15	Int16	MeanPathDelayToMaster_A	MeanPathDelayToMaster specifies the average path delay between the local clock and master clock in nanoseconds. (Bit 0 to bit 15)	0...0xffff
16	Int16	MeanPathDelayToMaster_B	MeanPathDelayToMaster specifies the average path delay between the local clock and master clock in nanoseconds. (Bit 16 to bit 31)	0...0xffff
17	Int16	MeanPathDelayToMaster_C	MeanPathDelayToMaster specifies the average path delay between the local clock and master clock in nanoseconds. (Bit 32 to bit 47)	0...0xffff
18	Int16	MeanPathDelayToMaster_D	MeanPathDelayToMaster specifies the average path delay between the local clock and master clock in nanoseconds. (Bit 48 to bit 63)	0...0xffff



**Table 123 - Status.IEEE1588 Data Table (M6 and M8 model) (continued)**

Element Number	Type	Tag Name	Description	Range
19	Int16	MasterClockIdentity_AB	MAC address 0xA:0xB:0xC:0xD:0xE:0xF for the Master Clock.	0...0xffff
20	Int16	MasterClockIdentity_CD	MAC address 0xA:0xB:0xC:0xD:0xE:0xF for the Master Clock.	0...0xffff
21	Int16	MasterClockIdentity_EF	MAC address 0xA:0xB:0xC:0xD:0xE:0xF for the Master Clock.	0...0xffff
22	Int16	LocalClockIdentity_AB	MAC address 0xA:0xB:0xC:0xD:0xE:0xF for the Local Clock.	0...0xffff
23	Int16	LocalClockIdentity_CD	MAC address 0xA:0xB:0xC:0xD:0xE:0xF for the Local Clock.	0...0xffff
24	Int16	LocalClockIdentity_EF	MAC address 0xA:0xB:0xC:0xD:0xE:0xF for the Local Clock.	0...0xffff
25	Int16	LocalClockClass	An attribute defining a clock's TAI traceability	0...255
26	Int16	LocalTimeAccuracy	An attribute defining the accuracy of a clock	0...255
27	Int16	LocalOffsetScaledLogVariance	An attribute defining the stability of a clock	0...0xffff
28	Int16	NumberOfPorts	NumberOfPorts specifies the number of PTP ports on the device.	1
29	Int16	PortState	PortStateInfo specifies the current state of each PTP port on the device	1...9
30	Int16	DomainNumber	DomainNumber specifies the PTP clock domain.	0...255
31	Int16	ClockType	The value of ClockType shall indicate the type of PTP node as defined in Table 5-47.13 in CIP™ specification Volume 1.	0...0xffff
32	Int16	Steps_removed	StepsRemoved specifies the number of communication paths traversed between the local clock and the grandmaster clock.	0...0xffff
33...44	Int16	Reserved	For future use	

## Statistics.Setpoint\_Output

Table 124 - Table Properties

<b>CIP Instance Number</b>	827
<b>PCCC File Number</b>	N36
<b>No. of Elements</b>	112
<b>Length in Words</b>	112
<b>Data Type</b>	Int16
<b>Data Access</b>	Read Only

Table 125 - Statistics.Setpoint\_Output Data Table

Element Number	Type	Tag Name	Description	Units	Range
0	Int16	Setpoint_1_Seconds_Accumulator	Time accumulator counter for seconds part of total accumulated time.	Sec	0...999
1	Int16	Setpoint_1_Minutes_Accumulator	Time accumulator counter for minutes part of total accumulated time.	Min	0...59
2	Int16	Setpoint_1_Hours_Accumulator	Time accumulator counter for total hours of accumulated time.	Hr	0...9999
3	Int16	Setpoint_1_Transitions_to_Active_x1	The number of actuations for setpoint times 1.	x1	0...999
4	Int16	Setpoint_1_Transitions_to_Active_x1000	The number of actuations for setpoint times 1000.	x1000	0...9999
5	Int16	Setpoint_2_Seconds_Accumulator	Time accumulator counter for seconds part of total accumulated time.	Sec	0...999
6	Int16	Setpoint_2_Minutes_Accumulator	Time accumulator counter for minutes part of total accumulated time.	Min	0...59
7	Int16	Setpoint_2_Hours_Accumulator	Time accumulator counter for total hours of accumulated time.	Hr	0...9999
8	Int16	Setpoint_2_Transitions_to_Active_x1	The number of actuations for setpoint times 1.		0...999
9	Int16	Setpoint_2_Transitions_to_Active_x1000	The number of actuations for setpoint times 1000.		0...9999
10	Int16	Setpoint_3_Seconds_Accumulator	Time accumulator counter for seconds part of total accumulated time.	Sec	0...999
11	Int16	Setpoint_3_Minutes_Accumulator	Time accumulator counter for minutes part of total accumulated time.	Min	0...59
12	Int16	Setpoint_3_Hours_Accumulator	Time accumulator counter for total hours of accumulated time.	Hr	0...9999
13	Int16	Setpoint_3_Transitions_to_Active_x1	The number of actuations for setpoint times 1.		0...999
14	Int16	Setpoint_3_Transitions_to_Active_x1000	The number of actuations for setpoint times 1000.		0...9999
15	Int16	Setpoint_4_Seconds_Accumulator	Time accumulator counter for seconds part of total accumulated time.	Sec	0...999
16	Int16	Setpoint_4_Minutes_Accumulator	Time accumulator counter for minutes part of total accumulated time.	Min	0...59
17	Int16	Setpoint_4_Hours_Accumulator	Time accumulator counter for total hours of accumulated time.	Hr	0...9999
18	Int16	Setpoint_4_Transitions_to_Active_x1	The number of actuations for setpoint times 1.		0...999
19	Int16	Setpoint_4_Transitions_to_Active_x1000	The number of actuations for setpoint times 1000.		0...9999
20	Int16	Setpoint_5_Seconds_Accumulator	Time accumulator counter for seconds part of total accumulated time.	Sec	0...999
21	Int16	Setpoint_5_Minutes_Accumulator	Time accumulator counter for minutes part of total accumulated time.	Min	0...59
22	Int16	Setpoint_5_Hours_Accumulator	Time accumulator counter for total hours of accumulated time.	Hr	0...9999
23	Int16	Setpoint_5_Transitions_to_Active_x1	The number of actuations for setpoint times 1.		0...999
24	Int16	Setpoint_5_Transitions_to_Active_x1000	The number of actuations for setpoint times 1000.		0...9999
25	Int16	Setpoint_6_Seconds_Accumulator	Time accumulator counter for seconds part of total accumulated time.	Sec	0...999
26	Int16	Setpoint_6_Minutes_Accumulator	Time accumulator counter for minutes part of total accumulated time.	Min	0...59
27	Int16	Setpoint_6_Hours_Accumulator	Time accumulator counter for total hours of accumulated time.	Hr	0...9999
28	Int16	Setpoint_6_Transitions_to_Active_x1	The number of actuations for setpoint times 1.		0...999

**Table 125 - Statistics.Setpoint\_Output Data Table (continued)**

Element Number	Type	Tag Name	Description	Units	Range
29	Int16	Setpoint_6_Transitions_to_Active_x1000	The number of actuations for setpoint times 1000.		0...9999
30	Int16	Setpoint_7_Seconds_Accumulator	Time accumulator counter for seconds part of total accumulated time.	Sec	0...999
31	Int16	Setpoint_7_Minutes_Accumulator	Time accumulator counter for minutes part of total accumulated time.	Min	0...59
32	Int16	Setpoint_7_Hours_Accumulator	Time accumulator counter for total hours of accumulated time.	Hr	0...9999
33	Int16	Setpoint_7_Transitions_to_Active_x1	The number of actuations for setpoint times 1.		0...999
34	Int16	Setpoint_7_Transitions_to_Active_x1000	The number of actuations for setpoint times 1000.		0...9999
35	Int16	Setpoint_8_Seconds_Accumulator	Time accumulator counter for seconds part of total accumulated time.	Sec	0...999
36	Int16	Setpoint_8_Minutes_Accumulator	Time accumulator counter for minutes part of total accumulated time.	Min	0...59
37	Int16	Setpoint_8_Hours_Accumulator	Time accumulator counter for total hours of accumulated time.	Hr	0...9999
38	Int16	Setpoint_8_Transitions_to_Active_x1	The number of actuations for setpoint times 1.		0...999
39	Int16	Setpoint_8_Transitions_to_Active_x1000	The number of actuations for setpoint times 1000.		0...9999
40	Int16	Setpoint_9_Seconds_Accumulator	Time accumulator counter for seconds part of total accumulated time.	Sec	0...999
41	Int16	Setpoint_9_Minutes_Accumulator	Time accumulator counter for minutes part of total accumulated time.	Min	0...59
42	Int16	Setpoint_9_Hours_Accumulator	Time accumulator counter for total hours of accumulated time.	Hr	0...9999
43	Int16	Setpoint_9_Transitions_to_Active_x1	Time accumulator counter for total hours of accumulated time.		0...999
44	Int16	Setpoint_9_Transitions_to_Active_x1000	The number of actuations for setpoint times 1000.		0...9999
45	Int16	Setpoint_10_Seconds_Accumulator	Time accumulator counter for seconds part of total accumulated time.	Sec	0...999
46	Int16	Setpoint_10_Minutes_Accumulator	Time accumulator counter for minutes part of total accumulated time.	Min	0...59
47	Int16	Setpoint_10_Hours_Accumulator	Time accumulator counter for total hours of accumulated time.	Hr	0...9999
48	Int16	Setpoint_10_Transitions_to_Active_x1	The number of actuations for setpoint times 1.		0...999
49	Int16	Setpoint_10_Transitions_to_Active_x1000	The number of actuations for setpoint times 1000.		0...9999
50	Int16	Setpoint_11_Seconds_Accumulator	Time accumulator counter for seconds part of total accumulated time.	Sec	0...999
51	Int16	Setpoint_11_Minutes_Accumulator	Time accumulator counter for minutes part of total accumulated time.	Min	0...59
52	Int16	Setpoint_11_Hours_Accumulator	Time accumulator counter for total hours of accumulated time.	Hr	0...9999
53	Int16	Setpoint_11_Transitions_to_Active_x1	The number of actuations for setpoint times 1	x1	0...999
54	Int16	Setpoint_11_Transitions_to_Active_x1000	The number of actuations for setpoint times 1000.	x1000	0...9999
55	Int16	Setpoint_12_Seconds_Accumulator	Time accumulator counter for seconds part of total accumulated time.	Sec	0...999
56	Int16	Setpoint_12_Minutes_Accumulator	Time accumulator counter for minutes part of total accumulated time.	Min	0...59
57	Int16	Setpoint_12_Hours_Accumulator	Time accumulator counter for total hours of accumulated time.	Hr	0...9999
58	Int16	Setpoint_12_Transitions_to_Active_x1	The number of actuations for setpoint times 1	x1	0...999
59	Int16	Setpoint_12_Transitions_to_Active_x1000	The number of actuations for setpoint times 1000.	x1000	0...9999
60	Int16	Setpoint_13_Seconds_Accumulator	Time accumulator counter for seconds part of total accumulated time.	Sec	0...999
61	Int16	Setpoint_13_Minutes_Accumulator	Time accumulator counter for minutes part of total accumulated time.	Min	0...59
62	Int16	Setpoint_13_Hours_Accumulator	Time accumulator counter for total hours of accumulated time.	Hr	0...9999
63	Int16	Setpoint_13_Transitions_to_Active_x1	The number of actuations for setpoint times 1	x1	0...999
64	Int16	Setpoint_13_Transitions_to_Active_x1000	The number of actuations for setpoint times 1000.	x1000	0...9999
65	Int16	Setpoint_14_Seconds_Accumulator	Time accumulator counter for seconds part of total accumulated time.	Sec	0...999
66	Int16	Setpoint_14_Minutes_Accumulator	Time accumulator counter for minutes part of total accumulated time.	Min	0...59
67	Int16	Setpoint_14_Hours_Accumulator	Time accumulator counter for total hours of accumulated time.	Hr	0...9999

**Table 125 - Statistics.Setpoint\_Output Data Table (continued)**

Element Number	Type	Tag Name	Description	Units	Range
68	Int16	Setpoint_14_Transitions_to_Active_x1	The number of actuations for setpoint times 1	x1	0...999
69	Int16	Setpoint_14_Transitions_to_Active_x1000	The number of actuations for setpoint times 1000.	x1000	0...9999
70	Int16	Setpoint_15_Seconds_Accumulator	Time accumulator counter for seconds part of total accumulated time.	Sec	0...999
71	Int16	Setpoint_15_Minutes_Accumulator	Time accumulator counter for minutes part of total accumulated time.	Min	0...59
72	Int16	Setpoint_15_Hours_Accumulator	Time accumulator counter for total hours of accumulated time.	Hr	0...9999
73	Int16	Setpoint_15_Transitions_to_Active_x1	The number of actuations for setpoint times 1	x1	0...999
74	Int16	Setpoint_15_Transitions_to_Active_x1000	The number of actuations for setpoint times 1000.	x1000	0...9999
75	Int16	Setpoint_16_Seconds_Accumulator	Time accumulator counter for seconds part of total accumulated time.	Sec	0...999
76	Int16	Setpoint_16_Minutes_Accumulator	Time accumulator counter for minutes part of total accumulated time.	Min	0...59
77	Int16	Setpoint_16_Hours_Accumulator	Time accumulator counter for total hours of accumulated time.	Hr	0...9999
78	Int16	Setpoint_16_Transitions_to_Active_x1	The number of actuations for setpoint times 1	x1	0...999
79	Int16	Setpoint_16_Transitions_to_Active_x1000	The number of actuations for setpoint times 1000.	x1000	0...9999
80	Int16	Setpoint_17_Seconds_Accumulator	Time accumulator counter for seconds part of total accumulated time.	Sec	0...999
81	Int16	Setpoint_17_Minutes_Accumulator	Time accumulator counter for minutes part of total accumulated time.	Min	0...59
82	Int16	Setpoint_17_Hours_Accumulator	Time accumulator counter for total hours of accumulated time.	Hr	0...9999
83	Int16	Setpoint_17_Transitions_to_Active_x1	The number of actuations for setpoint times 1	x1	0...999
84	Int16	Setpoint_17_Transitions_to_Active_x1000	The number of actuations for setpoint times 1000.	x1000	0...9999
85	Int16	Setpoint_18_Seconds_Accumulator	Time accumulator counter for seconds part of total accumulated time.	Sec	0...999
86	Int16	Setpoint_18_Minutes_Accumulator	Time accumulator counter for minutes part of total accumulated time.	Min	0...59
87	Int16	Setpoint_18_Hours_Accumulator	Time accumulator counter for total hours of accumulated time.	Hr	0...9999
88	Int16	Setpoint_18_Transitions_to_Active_x1	The number of actuations for setpoint times 1	x1	0...999
89	Int16	Setpoint_18_Transitions_to_Active_x1000	The number of actuations for setpoint times 1000.	x1000	0...9999
90	Int16	Setpoint_19_Seconds_Accumulator	Time accumulator counter for seconds part of total accumulated time.	Sec	0...999
91	Int16	Setpoint_19_Minutes_Accumulator	Time accumulator counter for minutes part of total accumulated time.	Min	0...59
92	Int16	Setpoint_19_Hours_Accumulator	Time accumulator counter for total hours of accumulated time.	Hr	0...9999
93	Int16	Setpoint_19_Transitions_to_Active_x1	The number of actuations for setpoint times 1	x1	0...999
94	Int16	Setpoint_19_Transitions_to_Active_x1000	The number of actuations for setpoint times 1000.	x1000	0...9999
95	Int16	Setpoint_20_Seconds_Accumulator	Time accumulator counter for seconds part of total accumulated time.	Sec	0...999
96	Int16	Setpoint_20_Minutes_Accumulator	Time accumulator counter for minutes part of total accumulated time.	Min	0...59
97	Int16	Setpoint_20_Hours_Accumulator	Time accumulator counter for total hours of accumulated time.	Hr	0...9999
98	Int16	Setpoint_20_Transitions_to_Active_x1	The number of actuations for setpoint times 1	x1	0...999
99	Int16	Setpoint_20_Transitions_to_Active_x1000	The number of actuations for setpoint times 1000.	x1000	0...9999
100...111	Int16	Reserved	Future Use.		0

## Statistics.Logging

**Table 126 - Table Properties**

<b>CIP Instance Number</b>	833
<b>PCCC File Number</b>	N42
<b>No. of Elements</b>	20
<b>Length in Words</b>	20
<b>Data Type</b>	Int16
<b>Data Access</b>	Read Only

**Table 127 - Statistics.Logging Data Table**

<b>Element Number</b>	<b>Type</b>	<b>Tag Name</b>	<b>Description</b>	<b>Range</b>
0	Int16	Number_of_Unit_Event_Log_Records	On a read of this table the value of this parameter is the number of Unit Event Records available. This log is returned only by using the incremental return method.	0...100
1	Int16	Number_of_Time_of_Use_Log_Records	On a read of this table the value of this parameter is the number of Time of Use Log Records available. 1 is the current record being updated before logging.	0...13
2	Int16	Number_of_Load_Factor_Log_Records	On a read of this table the value of this parameter is the number of Load Factor Log Records available. 1 is the current record being updated before logging.	0...13
3	Int16	Number_of_Setpoint_Log_Records	On a read of this table the value of this parameter is the number of setpoint event records available.	0...100
4	Int16	Number_of_Alarm_Log_Records	On a read of this table the value of this parameter is the number of Alarm event records available.	0...100
5	Int16	Number_of_Energy_Log_Records_x1000	On a read of this table the value of this parameter is the x1000 number of Energy Log Records available.	0...30,000
6	Int16	Number_of_Energy_Log_Records_x1	On a read of this table the value of this parameter is the x1 number of Energy Log Records available.	0...999
7	Int16	Number_of_Data_Log_Records_x1000	On a read of this table the value of this parameter is the x1000 number of data log records available.	0...30,000
8	Int16	Number_of_Data_Log_Records_x1	On a read of this table the value of this parameter is the x1 number of data log records available.	0...999
9	Int16	Number_of_Data_Log_Files	Total Data Log files that have been saved	0...256
10	Int16	Number_of_Energy_Log_Files	Total Energy Log files that have been saved	0...256
11	Int16	Number_of_TriggerData_Log_Records	On a read of this table the value of this parameter is the number of Trigger data records available.	0...3600
12	Int16	Number_of_TriggerData_Log_Files	Total trigger data files have been saved	0...60
13	Int16	Number_of_Waveform_Cycles	On a read of this table the value of this parameter is the number of waveform data cycles available.	0...21600
14	Int16	Number_of_Waveform_Files	Total waveform files have been saved	0...256
15	Int16	Number_of_Power_Quality_Log_Records	On a read of this table the value of this parameter is the number of power quality records available.	0...100
16	Int16	Number_of_EN50160_Weekly_Log_Records	On a read of this table, the value of this parameter is the number of EN50160 Weekly Log Records available. '1' is the current record being updated before logging.	0...8
17	Int16	Number_of_EN50160_Yearly_Log_Records	On a read of this table the value of this parameter is the number of EN50160 Yearly Log Records available. '1' is the current record being updated before logging.	0...13
18...19	Int16	Reserved	Reserved for future use.	0

## Statistics.Setpoint\_Logic (M6 and M8 model)

Table 128 - Table Properties

<b>CIP Instance Number</b>	828
<b>PCCC File Number</b>	N37
<b>No. of Elements</b>	112
<b>Length in Words</b>	112
<b>Data Type</b>	Int16
<b>Data Access</b>	Read Only

Table 129 - Statistics.Setpoint\_Logic Data Table

Element Number	Type	Tag Name	Description	Units	Range
0	Int16	Level1_Gate1_Seconds_Accumulator	Time accumulator counter for seconds part of total accumulated time.	Sec	0...999
1	Int16	Level1_Gate1_Minutes_Accumulator	Time accumulator counter for minutes part of total accumulated time.	Min	0...59
2	Int16	Level1_Gate1_Hours_Accumulator	Time accumulator counter for total hours of accumulated time.	Hr	0...9999
3	Int16	Level1_Gate1_Transitions_to_Active_x1	The number of actuations for setpoint times 1	x1	0...999
4	Int16	Level1_Gate1_Transitions_to_Active_x1000	The number of actuations for setpoint times 1000.	x1000	0...9999
5	Int16	Level1_Gate2_Seconds_Accumulator	Time accumulator counter for seconds part of total accumulated time.	Sec	0...999
6	Int16	Level1_Gate2_Minutes_Accumulator	Time accumulator counter for minutes part of total accumulated time.	Min	0...59
7	Int16	Level1_Gate2_Hours_Accumulator	Time accumulator counter for total hours of accumulated time.	Hr	0...9999
8	Int16	Level1_Gate2_Transitions_to_Active_x1	The number of actuations for setpoint times 1	x1	0...999
9	Int16	Level1_Gate2_Transitions_to_Active_x1000	The number of actuations for setpoint times 1000.	x1000	0...9999
10	Int16	Level1_Gate3_Seconds_Accumulator	Time accumulator counter for seconds part of total accumulated time.	Sec	0...999
11	Int16	Level1_Gate3_Minutes_Accumulator	Time accumulator counter for minutes part of total accumulated time.	Min	0...59
12	Int16	Level1_Gate3_Hours_Accumulator	Time accumulator counter for total hours of accumulated time.	Hr	0...9999
13	Int16	Level1_Gate3_Transitions_to_Active_x1	The number of actuations for setpoint times 1	x1	0...999
14	Int16	Level1_Gate3_Transitions_to_Active_x1000	The number of actuations for setpoint times 1000.	x1000	0...9999
15	Int16	Level1_Gate4_Seconds_Accumulator	Time accumulator counter for seconds part of total accumulated time.	Sec	0...999
16	Int16	Level1_Gate4_Minutes_Accumulator	Time accumulator counter for minutes part of total accumulated time.	Min	0...59
17	Int16	Level1_Gate4_Hours_Accumulator	Time accumulator counter for total hours of accumulated time.	Hr	0...9999
18	Int16	Level1_Gate4_Transitions_to_Active_x1	The number of actuations for setpoint times 1	x1	0...999
19	Int16	Level1_Gate4_Transitions_to_Active_x1000	The number of actuations for setpoint times 1000.	x1000	0...9999
20	Int16	Level1_Gate5_Seconds_Accumulator	Time accumulator counter for seconds part of total accumulated time.	Sec	0...999
21	Int16	Level1_Gate5_Minutes_Accumulator	Time accumulator counter for minutes part of total accumulated time.	Min	0...59
22	Int16	Level1_Gate5_Hours_Accumulator	Time accumulator counter for total hours of accumulated time.	Hr	0...9999
23	Int16	Level1_Gate5_Transitions_to_Active_x1	The number of actuations for setpoint times 1	x1	0...999
24	Int16	Level1_Gate5_Transitions_to_Active_x1000	The number of actuations for setpoint times 1000.	x1000	0...9999
25	Int16	Level1_Gate6_Seconds_Accumulator	Time accumulator counter for seconds part of total accumulated time.	Sec	0...999
26	Int16	Level1_Gate6_Minutes_Accumulator	Time accumulator counter for minutes part of total accumulated time.	Min	0...59
27	Int16	Level1_Gate6_Hours_Accumulator	Time accumulator counter for total hours of accumulated time.	Hr	0...9999
28	Int16	Level1_Gate6_Transitions_to_Active_x1	The number of actuations for setpoint times 1	x1	0...999

**Table 129 - Statistics.Setpoint\_Logic Data Table (continued)**


Element Number	Type	Tag Name	Description	Units	Range
29	Int16	Level1_Gate6_Transitions_to_Active_x1000	The number of actuations for setpoint times 1000.	x1000	0...9999
30	Int16	Level1_Gate7_Seconds_Accumulator	Time accumulator counter for seconds part of total accumulated time.	Sec	0...999
31	Int16	Level1_Gate7_Minutes_Accumulator	Time accumulator counter for minutes part of total accumulated time.	Min	0...59
32	Int16	Level1_Gate7_Hours_Accumulator	Time accumulator counter for total hours of accumulated time.	Hr	0...9999
33	Int16	Level1_Gate7_Transitions_to_Active_x1	The number of actuations for setpoint times 1	x1	0...999
34	Int16	Level1_Gate7_Transitions_to_Active_x1000	The number of actuations for setpoint times 1000.	x1000	0...9999
35	Int16	Level1_Gate8_Seconds_Accumulator	Time accumulator counter for seconds part of total accumulated time.	Sec	0...999
36	Int16	Level1_Gate_Minutes_Accumulator	Time accumulator counter for minutes part of total accumulated time.	Min	0...59
37	Int16	Level1_Gate8_Hours_Accumulator	Time accumulator counter for total hours of accumulated time.	Hr	0...9999
38	Int16	Level1_Gate8_Transitions_to_Active x1	The number of actuations for setpoint times 1	x1	0...999
39	Int16	Level1_Gate8_Transitions_to_Active_x1000	The number of actuations for setpoint times 1000.	x1000	0...9999
40	Int16	Level1_Gate9_Seconds_Accumulator	Time accumulator counter for seconds part of total accumulated time.	Sec	0...999
41	Int16	Level1_Gate9_Minutes_Accumulator	Time accumulator counter for minutes part of total accumulated time.	Min	0...59
42	Int16	Level1_Gate9_Hours_Accumulator	Time accumulator counter for total hours of accumulated time.	Hr	0...9999
43	Int16	Level1_Gate9_Transitions_to_Active_x1	The number of actuations for setpoint times 1	x1	0...999
44	Int16	Level1_Gate9_Transitions_to_Active_x1000	The number of actuations for setpoint times 1000.	x1000	0...9999
45	Int16	Level1_Gate10_Seconds_Accumulator	Time accumulator counter for seconds part of total accumulated time.	Sec	0...999
46	Int16	Level1_Gate10_Minutes_Accumulator	Time accumulator counter for minutes part of total accumulated time.	Min	0...59
47	Int16	Level1_Gate10_Hours_Accumulator	Time accumulator counter for total hours of accumulated time.	Hr	0...9999
48	Int16	Level1_Gate10_Transitions_to_Active_x1	The number of actuations for setpoint times 1	x1	0...999
49	Int16	Level1_Gate10_Transitions_to_Active_x1000	The number of actuations for setpoint times 1000.	x1000	0...9999
50...111	Int16	Reserved	Future Use		0

## Command.System\_Registers

Table 130 - Table Properties

<b>CIP Instance Number</b>	838
<b>PCCC File Number</b>	F47
<b>No. of Elements</b>	45
<b>Length in Words</b>	90
<b>Data Type</b>	Real
<b>Data Access</b>	Write Only

Table 131 - Command.System\_Registers Data Table

Element Number	Type	Tag Name	Description	Default	Range																								
0 	Real	Command Word One	<p>These commands can be sent to the power monitor. When using the optional elements the command table must be sent complete with all elements present. If the single password table is used to gain access to configuration items then the command can be sent alone without optional settings. The command options are:</p> <table border="0"> <tr> <td>0 = No Action</td> <td>1=Set kWh Register</td> </tr> <tr> <td>2=Set kVARh Register</td> <td>3=Set kVAh Register</td> </tr> <tr> <td>4= Set kWh Register</td> <td>5= Clear All Energy Registers</td> </tr> <tr> <td>6=Set Status 1 Count</td> <td>7=Set Status 2 Count</td> </tr> <tr> <td>8=Set Status 3 Count</td> <td>9=Set Status 4 Count</td> </tr> <tr> <td>10=Force KYZ Output On</td> <td>11=Force KYZ Output Off</td> </tr> <tr> <td>12=Remove Force from KYZ</td> <td>13=Force Relay 1 Output On</td> </tr> <tr> <td>14=Force Relay 1 Output Off</td> <td>15=Remove Force from Relay 1</td> </tr> <tr> <td>16=Force Relay 2 Output On</td> <td>17=Force Relay 2 Output Off</td> </tr> <tr> <td>18=Remove Force from Relay 2</td> <td>19=Force Relay 3 Output On</td> </tr> <tr> <td>20=Force Relay 3 Output Off</td> <td>21=Remove Force from Relay 3</td> </tr> <tr> <td>22=Restore Factory Defaults</td> <td>23=Reset Power Monitor System</td> </tr> </table> <p><b>IMPORTANT:</b> If a command is received that is not supported by your catalog number the command is ignored.</p> <p><b>IMPORTANT:</b> Output forcing (command options 10...21) is not permitted if an I/O connection (for example, Exclusive Owner, Data) is active. If an I/O connection is active and the configuration instance exists in the Logix Designer application, Command Word One options 1...23 are not permitted.</p>	0 = No Action	1=Set kWh Register	2=Set kVARh Register	3=Set kVAh Register	4= Set kWh Register	5= Clear All Energy Registers	6=Set Status 1 Count	7=Set Status 2 Count	8=Set Status 3 Count	9=Set Status 4 Count	10=Force KYZ Output On	11=Force KYZ Output Off	12=Remove Force from KYZ	13=Force Relay 1 Output On	14=Force Relay 1 Output Off	15=Remove Force from Relay 1	16=Force Relay 2 Output On	17=Force Relay 2 Output Off	18=Remove Force from Relay 2	19=Force Relay 3 Output On	20=Force Relay 3 Output Off	21=Remove Force from Relay 3	22=Restore Factory Defaults	23=Reset Power Monitor System	0	0...23
0 = No Action	1=Set kWh Register																												
2=Set kVARh Register	3=Set kVAh Register																												
4= Set kWh Register	5= Clear All Energy Registers																												
6=Set Status 1 Count	7=Set Status 2 Count																												
8=Set Status 3 Count	9=Set Status 4 Count																												
10=Force KYZ Output On	11=Force KYZ Output Off																												
12=Remove Force from KYZ	13=Force Relay 1 Output On																												
14=Force Relay 1 Output Off	15=Remove Force from Relay 1																												
16=Force Relay 2 Output On	17=Force Relay 2 Output Off																												
18=Remove Force from Relay 2	19=Force Relay 3 Output On																												
20=Force Relay 3 Output Off	21=Remove Force from Relay 3																												
22=Restore Factory Defaults	23=Reset Power Monitor System																												
1	Real	Command Word Two	<table border="0"> <tr> <td>0 = No Action</td> <td>1 = Clear Min/Max Records</td> </tr> <tr> <td>2 = Store and clear current Load Factor Record</td> <td>3 = Clear Load Factor Log</td> </tr> <tr> <td>4 = Store and clear current TOU Record</td> <td>5 = Clear TOU Log</td> </tr> <tr> <td>6 = Clear Setpoint Log</td> <td>7 = Clear Setpoint accumulators</td> </tr> <tr> <td>8 = Clear Error Log</td> <td>9 = Clear Energy Log</td> </tr> <tr> <td>10 = Clear Data Log</td> <td>11 = Perform Wiring Diagnostics</td> </tr> <tr> <td>12 = Log Off</td> <td>13 = Clear Trigger Data Log</td> </tr> <tr> <td>14 = Trigger Waveform</td> <td>15 = Clear Waveform</td> </tr> <tr> <td>16 = Metering Data Snapshot</td> <td>17 = Clear Power Quality Log</td> </tr> <tr> <td>18 = Clear Setpoint Logic Gate Accumulators</td> <td>19 = Reserved for future use</td> </tr> </table> <p><b>IMPORTANT:</b> If a command is received that is not supported by your catalog number the command is ignored.</p>	0 = No Action	1 = Clear Min/Max Records	2 = Store and clear current Load Factor Record	3 = Clear Load Factor Log	4 = Store and clear current TOU Record	5 = Clear TOU Log	6 = Clear Setpoint Log	7 = Clear Setpoint accumulators	8 = Clear Error Log	9 = Clear Energy Log	10 = Clear Data Log	11 = Perform Wiring Diagnostics	12 = Log Off	13 = Clear Trigger Data Log	14 = Trigger Waveform	15 = Clear Waveform	16 = Metering Data Snapshot	17 = Clear Power Quality Log	18 = Clear Setpoint Logic Gate Accumulators	19 = Reserved for future use	0	0...18				
0 = No Action	1 = Clear Min/Max Records																												
2 = Store and clear current Load Factor Record	3 = Clear Load Factor Log																												
4 = Store and clear current TOU Record	5 = Clear TOU Log																												
6 = Clear Setpoint Log	7 = Clear Setpoint accumulators																												
8 = Clear Error Log	9 = Clear Energy Log																												
10 = Clear Data Log	11 = Perform Wiring Diagnostics																												
12 = Log Off	13 = Clear Trigger Data Log																												
14 = Trigger Waveform	15 = Clear Waveform																												
16 = Metering Data Snapshot	17 = Clear Power Quality Log																												
18 = Clear Setpoint Logic Gate Accumulators	19 = Reserved for future use																												
2	Real	Clear Single Min/Max Records	<p>When invoking the Min/Max Clear command, this value can be sent to specify a single parameter. If clearing all values this is not required.</p> <p>0 = Clear All Parameters                      1= Clear the 1st Min/Max Record                      2= Clear the 2nd Min/Max Record... To the end of the Min/Max Parameters</p>	0	0...82 (M5, M6) 0...207 (M8)																								



**Table 131 - Command.System\_Registers Data Table (continued)**

Element Number	Type	Tag Name	Description	Default	Range
3	Real	Clear Single Setpoint or Logic Gate Accumulator	When invoking the Setpoint or Setpoint Logic Gate Accumulator Clear command this value can be sent to specify a single parameter. If clearing all values this is not required. 0 = Clear All Accumulators 1= Clear the 1st time accumulator 2= Clear the 2nd time accumulator... 20= Clear the 20th time accumulator	0	0...10 (M5); 0...10, logic gate accumulator, 0...20 setpoints (M6 and M8)
4	Real	Status 1 Count x M Register Set Value	Status 1 Count Register Start Value x 1,000,000	0	0...9,999,999
5	Real	Status 1 Count X 1 Register Set Value	Status 1 Count Register Start Value x 1	0	0...999,999
6	Real	Status 2 Count x M Register Set Value	Status 2 Count Register Start Value x 1,000,000	0	0...9,999,999
7	Real	Status 2 Count X 1 Register Set Value	Status 2 Count Register Start Value x 1	0	0...999,999
8	Real	Status 3 Count x M Register Set Value	Status 3 Count Register Start Value x 1,000,000	0	0...9,999,999
9	Real	Status 3 Count X 1 Register Set Value	Status 3 Count Register Start Value x 1	0	0...999,999
10	Real	Status 4 Count x M Register Set Value	Status 4 Count Register Start Value x 1,000,000	0	0...9,999,999
11	Real	Status 4 Count X 1 Register Set Value	Status 4 Count Register Start Value x 1	0	0...999,999
12	Real	GWh Fwd Register Set Value	Sets the GWh Fwd Register to the desired Value	0	0...9,999,999
13	Real	kWh Fwd Register Set Value	Sets the kWh Fwd Register to the desired Value	0	0...999,999
14	Real	GWh Rev Register Set Value	Sets the GWh Rev Register to the desired Value	0	0...9,999,999
15	Real	kWh Rev Register Set Value	Sets the kWh Rev Register to the desired Value	0	0...999,999
16	Real	GVARh Fwd Register Set Value	Sets the GVARh Fwd Register to the desired Value	0	0...9,999,999
17	Real	kVARh Fwd Register Set Value	Sets the kVARh Fwd Register to the desired Value	0	0...999,999
18	Real	GVARh Rev Register Set Value	Sets the GVARh Rev Register to the desired Value	0	0...9,999,999
19	Real	kVARh Rev Register Set Value	Sets the kVARh Rev Register to the desired Value	0	0...999,999
20	Real	GVAh Register Set Value	Sets the GVAh Register to the desired Value	0	0...9,999,999
21	Real	kVAh Register Set Value	Sets the kVAh Register to the desired Value	0	0...999,999
22	Real	GAh Register Set Value	Sets the GAh Register to the desired Value	0	0...9,999,999
23	Real	kAh Register Set Value	Sets the kAh Register to the desired Value	0	0...999,999
24	Real	Clear Waveform File ID	Waveform file identity 0 = Clear All If the identity is not known, the command is ignored.	0	0...999
25	Real	GWh Net Register Set Value	Sets the GWh Net Register to the desired Value.	0	±0...9,999,999
26	Real	kWh Net Register Set Value	Sets the kWh Net Register to the desired Value.	0	±0...999,999

**Table 131 - Command.System\_Registers Data Table (continued)**

Element Number	Type	Tag Name	Description	Default	Range
27	Real	GVARh Net Register Set Value	Sets the GVARh Net Register to the desired Value.	0	±0...9,999,999
28	Real	kVARh Net Register Set Value	Sets the kVARh Net Register to the desired Value.	0	±0...999,999
29...44	Real	Reserved	For future use.	0	0

## Command.Controller\_Interface

**Table 132 - Table Properties**

<b>CIP Instance Number</b>	839
<b>PCCC File Number</b>	N48
<b>No. of Elements</b>	16
<b>Length in Words</b>	16
<b>Data Type</b>	Int16
<b>Data Access</b>	Write Only

**Table 133 - Command.Controller\_Interface Data Table**


Element Number	Type	Tag Name	Description	Default	Range
0	Int16	Controller_Command_Word	Bit 0 = When this bit is written to the power monitor it signals the end of the demand period. The power monitor resets the bit to 0 and sends the end of demand broadcast to all of the slaves configured for the master/slave demand system. The power monitor must be configured as a 'Master' for external demand pulse input. Bit 1...Bit 15 = Reserved	0	0...1
1...15	Int16	Reserved	Future Use	0	0

## Command.Wiring\_Corrections

**Table 134 - Table Properties**

<b>CIP Instance Number</b>	840
<b>PCCC File Number</b>	N49
<b>No. of Elements</b>	14
<b>Length in Words</b>	14
<b>Data Type</b>	Int16
<b>Data Access</b>	Write Only

**Table 135 - Command.Wiring\_Corrections Data Table**

Element Number	Type	Tag Name	Description	Default	Range
0 	Int16	Wiring_Correction_Commands	0 = No command 1 = Correct wiring by using Range 1 results, Lagging 97 PF to Leading 89 PF 2 = Correct wiring by using Range 2 results, Lagging 85 PF to leading 98 PF 3 = Correct wiring by using Range 3 results, Lagging 52 PF to lagging 95 PF 4 = Correct wiring by using manual input parameters 5 = Remove all wiring corrections.	0	0...5
1	Int16	Input_V1_Mapping	This parameter logically maps a physical voltage channel to V1. 1 = V1 2 = V2 3 = V3 -1 = V1 inverted -2 = V2 inverted -3 = V3 inverted	1	-3...-1 1...3
2	Int16	Input_V2_Mapping	This parameter logically maps a physical voltage channel to V2. 1 = V1 2 = V2 3 = V3 -1 = V1 inverted -2 = V2 inverted -3 = V3 inverted	2	-3...-1 1...3
3	Int16	Input_V3_Mapping	This parameter logically maps a physical voltage channel to V3. 1 = V1 2 = V2 3 = V3 -1 = V1 inverted -2 = V2 inverted -3 = V3 inverted	3	-3...-1 1...3
4	Int16	Input_I1_Mapping	This parameter logically maps a physical current channel to I1. 1 = I1 2 = I2 3 = I3 -1 = I1 inverted -2 = I2 inverted -3 = I3 inverted	1	-3...-1 1...3

**Table 135 - Command.Wiring\_Corrections Data Table (continued)**

Element Number	Type	Tag Name	Description	Default	Range
5	Int16	Input_I2_Mapping	This parameter logically maps a physical current channel to I2. 1 = I1 2 = I2 3 = I3 -1 = I1 inverted -2 = I2 inverted -3 = I3 inverted	2	-3...-1 1...3
6	Int16	Input_I3_Mapping	This parameter logically maps a physical current channel to I3. 1 = I1 2 = I2 3 = I3 -1 = I1 inverted -2 = I2 inverted -3 = I3 inverted	3	-3...-1 1...3
7...13	Int16	Reserved	Future Use	0	0

## MeteringResults.RealTime\_VIF\_Power

**Table 136 - Table Properties**

<b>CIP Instance Number</b>	844
<b>PCCC File Number</b>	F53
<b>No. of Elements</b>	56
<b>Length in Words</b>	112
<b>Data Type</b>	Real
<b>Data Access</b>	Read Only

**Table 137 - MeteringResults.RealTime\_VIF\_Power Data Table**

Element Number	Type	Tag Name	Description	Units	Range
0	Real	Metering Date Stamp	Date of cycle collection MM:DD:YY	MM:DD:YY	0...123199
1	Real	Metering Time Stamp	Time of cycle collection HH:MM:SS	HH:MM:SS	0...235959
2	Real	Metering Microsecond Stamp	Microsecond of cycle collection	uS	0.000...999,999
3	Real	V1_N_Volts	V1 to N true RMS voltage	V	0...9.999E15
4	Real	V2_N_Volts	V2 to N true RMS voltage	V	0...9.999E15
5	Real	V3_N_Volts	V3 to N true RMS voltage	V	0...9.999E15
6	Real	VN_G_Volts	VN to G true RMS voltage	V	0...9.999E15
7	Real	Avg_V_N_Volts	Average of V1, V2 and V3	V	0...9.999E15
8	Real	V1_V2_Volts	V1 to V2 true RMS voltage	V	0...9.999E15
9	Real	V2_V3_Volts	V2 to V3 true RMS voltage	V	0...9.999E15
10	Real	V3_V1_Volts	V3 to V1 true RMS voltage	V	0...9.999E15
11	Real	Avg_VL_VL_Volts	Average of V1_V2, V2_V3 and V3_V1	V	0...9.999E15
12	Real	I1_Amps	I1 true RMS amps	A	0...9.999E15
13	Real	I2_Amps	I2 true RMS amps	A	0...9.999E15
14	Real	I3_Amps	I3 true RMS amps	A	0...9.999E15
15	Real	I4_Amps	I4 true RMS amps	A	0...9.999E15
16	Real	Avg_Amps	Average I1, I2 and I3 amps	A	0...9.999E15
17	Real	Frequency_Hz	Last Line Frequency Calculated	Hz	40.00...70.00
18	Real	Avg_Frequency_Hz	Average Frequency over 6 cycles	Hz	40.00...70.00
19	Real	L1_kW	L1 real power	kW	-9.999E15...9.999E15
20	Real	L2_kW	L2 real power	kW	-9.999E15...9.999E15
21	Real	L3_kW	L3 real power	kW	-9.999E15...9.999E15
22	Real	Total_kW	Total real power	kW	-9.999E15...9.999E15
23	Real	L1_kVAR	L1 reactive power	kVAR	-9.999E15...9.999E15
24	Real	L2_kVAR	L2 reactive power	kVAR	-9.999E15...9.999E15
25	Real	L3_kVAR	L3 reactive power	kVAR	-9.999E15...9.999E15
26	Real	Total_kVAR	Total reactive power	kVAR	-9.999E15...9.999E15
27	Real	L1_kVA	L1 apparent power	kVA	0...9.999E15
28	Real	L2_kVA	L2 apparent power	kVA	0...9.999E15

**Table 137 - MeteringResults.RealTime\_VIF\_Power Data Table (continued)**

Element Number	Type	Tag Name	Description	Units	Range
29	Real	L3_kVA	L3 apparent power	kVA	0...9.999E15
30	Real	Total_kVA	Total apparent power	kVA	0...9.999E15
31	Real	L1_True_PF_%	L1 true power factor (full bandwidth)	%	0.00...100.00
32	Real	L2_True_PF_%	L2 true power factor (full bandwidth)	%	0.00...100.00
33	Real	L3_True_PF_%	L3 true power factor (full bandwidth)	%	0.00...100.00
34	Real	Total_True_PF	Total true power factor	%	0.00...100.00
35	Real	L1_Displacement_PF	L1 displacement power factor (fundamental only)	%	0.00...100.00
36	Real	L2_Displacement_PF	L2 displacement power factor (fundamental only)	%	0.00...100.00
37	Real	L3_Displacement_PF	L3 displacement power factor (fundamental only)	%	0.00...100.00
38	Real	Total_Displacement_PF	Total displacement power factor (fundamental only)	%	0.00...100.00
39	Real	L1_PF_Lead_Lag_Indicator	L1 lead or lag indicator for power factor 1 = leading -1 = lagging		-1...1
40	Real	L2_PF_Lead_Lag_Indicator	L2 lead or lag indicator for power factor 1 = leading -1 = lagging		-1...1
41	Real	L3_PF_Lead_Lag_Indicator	L3 lead or lag indicator for power factor 1 = leading -1 = lagging		-1...1
42	Real	Total_PF_Lead_Lag_Indicator	Total lead or lag indicator for power factor 1 = leading -1 = lagging		-1...1
43	Real	Voltage Rotation	Voltage rotation has the following designations: 0 = Not metering 123 = ABC rotation 132 = ACB rotation 4 = No rotation		0...132
44	Real	Metering_Iteration	A number 0...9,999,999 that indicates that the metering functions and internal communication are updating		0...9,999,999
45...55	Real	Resvd	Reserved		

## MeteringResults.Energy\_Demand

**Table 138 - Table Properties**

<b>CIP Instance Number</b>	846
<b>PCCC File Number</b>	F55
<b>No. of Elements</b>	56
<b>Length in Words</b>	112
<b>Data Type</b>	Real
<b>Data Access</b>	Read Only

**Table 139 - MeteringResults.Energy\_Demand Data Table**

Element Number	Type	Tag Name	Description	Units	Range
0	Real	Status_1_Count_xM	Status 1 Count times 1,000,000		0...9,999,999
1	Real	Status_1_Count_x1	Status 1 count times 1		0...999,999
2	Real	Status_2_Count_xM	Status 2 Count times 1,000,000		0...9,999,999
3	Real	Status_2_Count_x1	Status 2 count times 1		0...999,999
4	Real	Status_3_Count_xM	Status 3 Count times 1,000,000		0...9,999,999
5	Real	Status_3_Count_x1	Status 3 count times 1		0...999,999
6	Real	Status_4_Count_xM	Status 4 Count times 1,000,000		0...9,999,999
7	Real	Status_4_Count_x1	Status 4 count times 1		0...999,999
8	Real	GWh_Fwd	Forward gigawatt hours	GWh	0...9,999,999
9	Real	kWh_Fwd	Forward kilowatt hours	kWh	0.000...999,999
10	Real	GWh_Rev	Reverse gigawatt hours	GWh	0...9,999,999
11	Real	kWh_Rev	Reverse kilowatt hours	kWh	0.000...999,999
12	Real	GWh_Net	Net gigawatt hours	GWh	±0...9,999,999
13	Real	kWh_Net	Net kilowatt hours	kWh	±0.000...999,999
14	Real	GVARH_Fwd	Forward gigaVAR hours	GVARh	0...9,999,999
15	Real	kVARh_Fwd	Forward kiloVAR hours	kVARh	0.000...999,999
16	Real	GVARH_Rev	Reverse gigaVAR hours	GVARh	0...9,999,999
17	Real	kVARh_Rev	Reverse kiloVAR hours	kVARh	0.000...999,999
18	Real	GVARH_Net	Net gigaVAR hours	GVARh	±0...9,999,999
19	Real	kVARh_Net	Net kiloVAR hours	kVARh	±0.000...999,999
20	Real	GVAh	Net gigaVA hours	GVAh	0...9,999,999
21	Real	kVAh	Net kiloVA hours	kVAh	0.000...999,999
22	Real	GAh	Net giga Amp hours	GAh	0...9,999,999
23	Real	kAh	Net kilo Amp hours	kAh	0.000...999,999
24	Real	kW_Demand	The average real power during the last demand period	kW	±0.000...9,999,999
25	Real	kVAR_Demand	The average reactive power during the last demand period	kVAR	±0.000...9,999,999
26	Real	kVA_Demand	The average apparent power during the last demand period	kVA	0.000...9,999,999
27	Real	Demand_PF	The average PF during the last demand period	PF	-100.0...100.0
28	Real	Demand_Amps	The average demand for amperes during the last demand period	A	0.000...9,999,999

**Table 139 - MeteringResults.Energy\_Demand Data Table (continued)**

Element Number	Type	Tag Name	Description	Units	Range
29	Real	Projected_kW_Demand	The projected total real power for the current demand period	kW	±0.000...9,999,999
30	Real	Projected_kVAR_Demand	The projected total reactive power for the current demand period	kVAR	±0.000...9,999,999
31	Real	Projected_kVA_Demand	The projected total apparent power for the current demand period	kVA	0.000...9,999,999
32	Real	Projected_Ampere_Demand	The projected total amperes for the current demand period	A	0.000...9,999,999
33	Real	Elapsed_Demand_Period_Time	The amount of time that has elapsed during the current demand period	Min	0.00...59.99
34...55	Real	Reserved	For future use	0	0

### MeteringResults.EN61000\_4\_30\_VIP (M8 only)

**Table 140 - Table Properties**

<b>CIP Instance Number</b>	880
<b>PCCC File Number</b>	F89
<b>No. of Elements</b>	43
<b>Length in Words</b>	86
<b>Data Type</b>	Real
<b>Data Access</b>	Read only
<b>Applies to</b>	M8 only

**Table 141 - MeteringResults.EN61000\_4\_30\_VIP**

Element Number	Type	Tag Name	Description	Units	Range
0	Real	200mS_Metering_Date_Stamp	Date of cycle collection MM:DD:YY	MMDDYY	0...123199
1	Real	200mS_Metering_Time_Stamp	Time of cycle collection HH:MM:SS	hhmmss	0...235959
2	Real	200mS_Metering_uSecond_Stamp	Microsecond of cycle collection	uS	0.000...999,999
3	Real	200mS_V1_N_Magnitude	V1 to N true RMS voltage	V	0...9.999E15
4	Real	200mS_V2_N_Magnitude	V2 to N true RMS voltage	V	0...9.999E15
5	Real	200mS_V3_N_Magnitude	V3 to N true RMS voltage	V	0...9.999E15
6	Real	200mS_VN_G_Magnitude	VN to G true RMS voltage	V	0...9.999E15
7	Real	200mS_VN_Ave_Magnitude	Average of V1, V2 and V3.	V	0...9.999E15
8	Real	200mS_V1_V2_Magnitude	V1 to V2 true RMS voltage	V	0...9.999E15
9	Real	200mS_V2_V3_Magnitude	V2 to V3 true RMS voltage	V	0...9.999E15
10	Real	200mS_V3_V1_Magnitude	V3 to V1 true RMS voltage	V	0...9.999E15
11	Real	200mS_VV_Ave_Magnitude	Average of V1_V2, V2_V3 and V3_V1	V	0...9.999E15
12	Real	200mS_I1_Amps_Magnitude	I1 true RMS amps	A	0...9.999E15
13	Real	200mS_I2_Amps_Magnitude	I2 true RMS amps	A	0...9.999E15
14	Real	200mS_I3_Amps_Magnitude	I3 true RMS amps	A	0...9.999E15
15	Real	200mS_I4_Amps_Magnitude	I4 true RMS amps	A	0...9.999E15
16	Real	200mS_Amps_Ave_Magnitude	Average I1, I2 and I3 amps.	A	0...9.999E15



**Table 141 - MeteringResults.EN61000\_4\_30\_VIP (continued)**

Element Number	Type	Tag Name	Description	Units	Range
17	Real	200mS_L1_kW	L1 real power	kW	-9.999E15... 9.999E15
18	Real	200mS_L2_kW	L2 real power	kW	-9.999E15... 9.999E15
19	Real	200mS_L3_kW	L3 real power	kW	-9.999E15... 9.999E15
20	Real	200mS_Total_kW	Total real power	kW	-9.999E15... 9.999E15
21	Real	200mS_L1_kVAR	L1 reactive power	kVAR	-9.999E15... 9.999E15
22	Real	200mS_L2_kVAR	L2 reactive power	kVAR	-9.999E15... 9.999E15
23	Real	200mS_L3_kVAR	L3 reactive power	kVAR	-9.999E15... 9.999E15
24	Real	200mS_Total_kVAR	Total reactive power	kVAR	-9.999E15... 9.999E15
25	Real	200mS_L1_kVA	L1 apparent power	kVA	0...9.999E15
26	Real	200mS_L2_kVA	L2 apparent power	kVA	0...9.999E15
27	Real	200mS_L3_kVA	L3 apparent power	kVA	0...9.999E15
28	Real	200mS_Total_kVA	Total apparent power	kVA	0...9.999E15
29	Real	200mS_L1_True_PF	L1 true power factor (full bandwidth)	%	0.00...100.00
30	Real	200mS_L2_True_PF	L2 true power factor (full bandwidth)	%	0.00...100.00
31	Real	200mS_L3_True_PF	L3 true power factor (full bandwidth)	%	0.00...100.00
32	Real	200mS_Total_True_PF	Average true power factor	%	0.00...100.00
33	Real	200mS_L1_Disp_PF	L1 displacement power factor (fundamental only)	%	0.00...100.00
34	Real	200mS_L2_Disp_PF	L2 displacement power factor (fundamental only)	%	0.00...100.00
35	Real	200mS_L3_Disp_PF	L3 displacement power factor (fundamental only)	%	0.00...100.00
36	Real	200mS_Total_Disp_PF	Average displacement power factor (fundamental only)	%	0.00...100.00
37	Real	200mS_L1_PF_LeadLag_Indicator	L1 lead or lag indicator for power factor 1 = leading, -1 = lagging.	-	-1...1
38	Real	200mS_L2_PF_LeadLag_Indicator	L2 lead or lag indicator for power factor 1 = leading, -1 = lagging.	-	-1...1
39	Real	200mS_L3_PF_LeadLag_Indicator	L3 lead or lag indicator for power factor 1 = leading, -1 = lagging.	-	-1...1
40	Real	200mS_Total_PF_LeadLag_Indicator	Total lead or lag indicator for power factor 1 = leading, -1 = lagging	-	-1...1
41	Real	200mS_Sag_Swell_Status_Flag	A flag indicating 200 ms result has been calculated during a Sag, Swell, or Interruption.	#	0...1
42	Real	200mS_Metering_Iteration	A number 0...9,999,999 that indicates that the metering functions and internal communications are updating.	#	9,999,999

## LoggingResults.DataLog\_FileName

Table 142 - Table Properties

<b>CIP Instance Number</b>	849
<b>PCCC File Number</b>	ST58
<b>No. of Elements</b>	1
<b>Length in Words</b>	32
<b>Data Type</b>	String
<b>Data Access</b>	Read Only

Table 143 - LoggingResults.DataLog\_FileName Data Table

Element Number	Type	Tag Name	Description	Default	Range
0	String	Data_Log_File_Name	64 character file name: Datalog_YYYYMMDD_HHMMSS_hh '/0' indicates no more file names to return.	'/0'	File name or '/0'

## LoggingResults.EnergyLog\_FileName

Table 144 - Table Properties

<b>CIP Instance Number</b>	850
<b>PCCC File Number</b>	ST59
<b>No. of Elements</b>	1
<b>Length in Words</b>	32
<b>Data Type</b>	String
<b>Data Access</b>	Read Only

Table 145 - LoggingResults.EnergyLog\_FileName Data Table

Element Number	Type	Tag Name	Description	Default	Range
0	String	Energy_Log_File_Name	64 character file name: Energylog_YYYYMMDD_HHMMSS_hh '/0' indicates no more file names to return.	'/0'	File name or '/0'

## LoggingResults.Data\_Log

**Table 146 - Table Properties**

<b>CIP Instance Number</b>	851
<b>PCCC File Number</b>	F60
<b>No. of Elements</b>	38
<b>Length in Words</b>	76
<b>Data Type</b>	Real
<b>Data Access</b>	Read Only

**Table 147 - LoggingResults.Data\_Log Data Table**

Element Number	Type	Tag Name	Description	Unit	Range
0	Real	Record_Indicator	Indicates the meaning of the data in the record		0 = No record returned 1 = the record contains parameter values 2 = the record contains a reference to the item description 3 = log file not found.
1	Real	Data_Record_Identifier	If Record_Indicator =1, internal unique record number If Record_Indicator =2, total records number in the log file	#	±0...9.999E15
2	Real	Data_Timestamp_Year	If Record_Indicator =1, the date and time when the record was recorded otherwise 0	YYYY	2010...2100
3	Real	Data_Timestamp_Month_Day		MMDD	0101...1231
4	Real	Data_Timestamp_Hour_Minute		HHMM	0000...2359
5	Real	Data_Timestamp_Sec_ms		SSms	00000...59999
6	Real	DataLog_Parameter_1	If Record_Indicator =1, parameter value If Record_Indicator =2 = parameter index: reference to Data Log Parameter List table <sup>(1)</sup>		±0...9.999E15
7	Real	DataLog_Parameter_2		±0...9.999E15	
8	Real	DataLog_Parameter_3		±0...9.999E15	
9	Real	DataLog_Parameter_4		±0...9.999E15	
10	Real	DataLog_Parameter_5		±0...9.999E15	
11	Real	DataLog_Parameter_6		±0...9.999E15	
12	Real	DataLog_Parameter_7		±0...9.999E15	
13	Real	DataLog_Parameter_8		±0...9.999E15	
14	Real	DataLog_Parameter_9		±0...9.999E15	
15	Real	DataLog_Parameter_10		±0...9.999E15	
16	Real	DataLog_Parameter_11		±0...9.999E15	
17	Real	DataLog_Parameter_12		±0...9.999E15	
18	Real	DataLog_Parameter_13		±0...9.999E15	
19	Real	DataLog_Parameter_14		±0...9.999E15	
20	Real	DataLog_Parameter_15		±0...9.999E15	
21	Real	DataLog_Parameter_16		±0...9.999E15	
22	Real	DataLog_Parameter_17		±0...9.999E15	
23	Real	DataLog_Parameter_18		±0...9.999E15	

**Table 147 - LoggingResults.Data\_Log Data Table (continued)**

Element Number	Type	Tag Name	Description	Unit	Range
24	Real	DataLog_Parameter_19	If Record_Indicator =1, parameter value If Record_Indicator =2 = parameter index: reference to Data Log Parameter List table <sup>(1)</sup>		±0...9.999E15
25	Real	DataLog_Parameter_20			±0...9.999E15
26	Real	DataLog_Parameter_21			±0...9.999E15
27	Real	DataLog_Parameter_22			±0...9.999E15
28	Real	DataLog_Parameter_23			±0...9.999E15
29	Real	DataLog_Parameter_24			±0...9.999E15
30	Real	DataLog_Parameter_25			±0...9.999E15
31	Real	DataLog_Parameter_26			±0...9.999E15
32	Real	DataLog_Parameter_27			±0...9.999E15
33	Real	DataLog_Parameter_28			±0...9.999E15
34	Real	DataLog_Parameter_29			±0...9.999E15
35	Real	DataLog_Parameter_30			±0...9.999E15
36	Real	DataLog_Parameter_31			±0...9.999E15
37	Real	DataLog_Parameter_32		±0...9.999E15	

(1) The selectable Data Log parameters and their indexes are listed in the Data\_Log\_Parameter\_Table .

## LoggingResults.Energy\_Log

**Table 148 - Table Properties**

<b>CIP Instance Number</b>	852
<b>PCCC File Number</b>	F61
<b>No. of Elements</b>	35
<b>Length in Words</b>	70
<b>Data Type</b>	Real
<b>Data Access</b>	Read Only

**Table 149 - LoggingResults.Energy\_Log Data Table**

Element Number	Type	Tag Name	Description	Unit	Range
0	Real	Record_Indicator	Indicate meanings of the data in the record		0 = No record returned 1 = the record contains parameter values 2 = Reserved 3 = log file not found.
1	Real	Energy_Record_Identifier.	Internal unique record number	#	±0...9.999E15
2	Real	Energy_Timestamp_Year	The date and time when the record was recorded	YYYY	2010...2100
3	Real	Energy_Timestamp_Mth_Day		MMDD	0101...1231
4	Real	Energy_Timestamp_Hr_Min		HHMM	0000...2359
5	Real	Energy_Timestamp_Sec_ms		SSms	00000...59999
6	Real	Status 1 Count xM	Status 1 Count	xM	0...9,999,999
7	Real	Status 1 Count x1		x1	0...999,999
8	Real	Status 2 Count xM	Status 2 Count	xM	0...9,999,999
9	Real	Status 2 Count x1		x1	0...999,999
10	Real	Status 3 Count xM	Status 3 Count	xM	0...9,999,999
11	Real	Status 3 Count x1		x1	0...999,999
12	Real	Status 4 Count xM	Status 4 Count	xM	0...9,999,999
13	Real	Status 4 Count x1		x1	0...999,999
14	Real	GWh Fwd	Forward gigawatt hours	GWh	0...9,999,999
15	Real	kWh Fwd	Forward kilowatt hours	kWh	0.000...999,999
16	Real	GWh Rev.	Reverse gigawatt hours	GWh	0...9,999,999
17	Real	kWh Rev.	Reverse kilowatt hours	kWh	0.000...999,999
18	Real	GWh Net	Net gigawatt hours	GWh	±0...9,999,999
19	Real	kWh Net	Net kilowatt hours	kWh	±0.000...999,999
20	Real	GVARH Fwd	Forward gigaVAR hours	GVARh	0...9,999,999
21	Real	kVARH Fwd	Forward kiloVAR hours	kVARh	0.000...999,999
22	Real	GVARH Rev.	Reverse gigaVAR hours	GVARh	0...9,999,999
23	Real	kVARH Rev.	Reverse kiloVAR hours	kVARh	0.000...999.1000
24	Real	GVARH Net	Net gigaVAR hours	GVARh	±0...9,999,999
25	Real	kVARH Net	Net kiloVAR hours	kVARh	±0.000...999,999

**Table 149 - LoggingResults.Energy\_Log Data Table (continued)**

Element Number	Type	Tag Name	Description	Unit	Range
26	Real	GVAh Net	Net gigaVA hours	GVAh	0...9,999,999
27	Real	kVAh	Net kiloVA hours	kVAh	0.000...999,999
28	Real	kW Demand	The average real power during the last demand period	kW	± 0.000...9,999,999
29	Real	kVAR Demand	The average reactive power during the last demand period	kVAR	± 0.000...9,999,999
30	Real	kVA Demand	The average apparent power during the last demand period	kVA	0.000...9,999,999
31	Real	Demand PF	The average PF during the last demand period	PF	-100.0...100.0
32	Real	Projected kW Demand	The projected total real power for the current demand period	kW	± 0.000...9,999,999
33	Real	Projected kVAR Demand	The projected total reactive power for the current demand period	kVAR	± 0.000...9,999,999
34	Real	Projected kVA Demand	The projected total apparent power for the current demand period	kVA	0.000...9,999,999

## LoggingResults.LoadFactor.Log

**Table 150 - Table Properties**

<b>CIP Instance Number</b>	853
<b>PCCC File Number</b>	F62
<b>No. of Elements</b>	40
<b>Length in Words</b>	80
<b>Data Type</b>	Real
<b>Data Access</b>	Read Only

**Table 151 - LoggingResults.LoadFactor.Log Data Table**

Element Number	Type	Tag Name	Description	Units	Range
0	Real	LoadFactor_Record_Number	The record number of this data.	#	1...13
1	Real	LoadFactor_End_Date	The date that this record was stored.	YYMMDD	0...999,999
2	Real	LoadFactor_Elapsed_Time	Amount of time (in hours) that has elapsed since the last clear of the peak and average values. Updated at the end of each demand interval.	Hr	0.000... 9,999,999
3	Real	Peak_Demand_kW	The largest magnitude demand for kwatts that occurred over all of the demand intervals since the last clear command or auto-clear day.	kW	±0.000... 9,999,999
4	Real	Average_Demand_kW	A running average of demand for kwatts from the end of each demand period since the last clear command or auto-clear day.	kW	±0.000... 9,999,999
5	Real	LoadFactor_kW	Average Demand kW/Peak Demand kW. This is a demand management metric that indicates how 'spiky' (or 'level') a load is over a period of time (usually 1 month). A value approaching 100% indicates a constant load.	%	0...100 %
6	Real	Peak_Demand_kVAR	The largest magnitude demand for kVAR that occurred over all of the demand intervals since the last clear command or auto-clear day.	kVAR	±0.000... 9,999,999
7	Real	Average_Demand_kVAR	A running average of demand for kVAR from the end of each demand period since the last clear command or auto-clear day.	kVAR	±0.000... 9,999,999
8	Real	LoadFactor_kVAR	Average Demand kVAR/Peak Demand kVAR. This is a demand management metric that indicates how 'spiky' (or 'level') a load is over a period of time (usually 1 month). A value approaching 100% indicates a constant load.	%	0...100 %
9	Real	Peak_Demand_kVA	The largest magnitude demand for kVA that occurred over all of the demand intervals since the last clear command or auto-clear day.	kVA	0.000... 9,999,999
10	Real	Average_Demand_kVA	A running average of demand for kVA from the end of each demand period since the last clear command or auto-clear day.	kVA	0.000... 9,999,999
11	Real	LoadFactor_kVA	Average Demand kVA / Peak Demand kVA. This is a demand management metric that indicates how 'spiky' (or 'level') a load is over a period of time (usually 1 month). A value approaching 100% indicates a constant load.	%	0...100 %
12...39	Real	Resvd	Reserved		0

## LoggingResults.TOU.Log

**Table 152 - Table Properties**

<b>CIP Instance Number</b>	854
<b>PCCC File Number</b>	F63
<b>No. of Elements</b>	38
<b>Length in Words</b>	76
<b>Data Type</b>	Real
<b>Data Access</b>	Read Only

**Table 153 - LoggingResults.TOU.Log Data Table**

Element Number	Type	Tag Name	Description	Units	Range
0	Real	TOU_Record_Number	The record number of the log. Record 1 is always the current record before being logged		1...13
1	Real	TOU_Start_Date	The Date this record was started	YYMMDD	0...999,999
2	Real	TOU_End_Date	The Date this record was ended	YYMMDD	0...999,999
3	Real	Off_Peak_GWh_Net	Net Off Peak gigawatt hours	GWh	±0...9,999,999
4	Real	Off_Peak_kWh_Net	Net Off Peak kilowatt hours	kWh	±0.000...999,999
5	Real	Off_Peak_kW_Demand	Off Peak Demand for kilowatts	kW	±0.000...9,999,999
6	Real	Mid_Peak_GWh_Net	Net Mid Peak gigawatt hours	GWh	±0...9,999,999
7	Real	Mid_Peak_kWh_Net	Net Mid Peak kilowatt hours	kWh	±0.000...999,999
8	Real	Mid_Peak_kW_Demand	Mid Peak Demand for kilowatts	kW	±0.000...9,999,999
9	Real	On_Peak_GWh_Net	Net On Peak gigawatt hours	GWh	±0.000...9,999,999
10	Real	On_Peak_kWh_Net	Net On Peak kilowatt hours	kWh	±0...999,999
11	Real	On_Peak_kW_Demand	On Peak Demand for kilowatts	kW	±0.000...9,999,999
12	Real	Off_Peak_GVARh_Net	Net Off peak gigaVAR hours	GVARh	±0...9,999,999
13	Real	Off_Peak_kVARh_Net	Net Off Peak kiloVAR hours	kVARh	±0.000...999,999
14	Real	Off_Peak_kVAR_Demand	Off Peak Demand for kiloVAR	kVAR	±0.000...9,999,999
15	Real	Mid_Peak_GVARh_Net	Net Mid Peak gigaVAR hours	GVARh	±0...9,999,999
16	Real	Mid_Peak_kVARh_Net	Net Mid Peak kiloVAR hours	kVARh	±0.000...999,999
17	Real	Mid_Peak_kVAR_Demand	Mid Peak Demand for kiloVAR	kVAR	±0.000...9,999,999
18	Real	On_Peak_GVARh_Net	Net On Peak gigaVAR hours	GVARh	±0.000...9,999,999
19	Real	On_Peak_kVARh_Net	Net On Peak kiloVAR hours	kVARh	±0...999,999
20	Real	On_Peak_kVAR_Demand	On Peak Demand for kiloVAR	kVAR	±0.000...9,999,999
21	Real	Off_Peak_GVAh_Net	Net Off peak gigaVA hours	GVAh	0...9,999,999
22	Real	Off_Peak_kVAh_Net	Net Off Peak kiloVA hours	kVAh	0.000...999,999
23	Real	Off_Peak_kVA_Demand	Off Peak Demand for kiloVA	kVA	0.000...9,999,999
24	Real	Mid_Peak_GVAh_Net	Net Mid Peak gigaVA hours	GVAh	0...9,999,999
25	Real	Mid_Peak_kVAh_Net	Net Mid Peak kiloVA hours	kVAh	0.00...999,999
26	Real	Mid_Peak_kVA_Demand	Mid Peak Demand for kiloVA	kVA	0.000...9,999,999
27	Real	On_Peak_GVAh_Net	Net On Peak gigaVA hours	GVAh	0.000...9,999,999



**Table 153 - LoggingResults.TOU.Log Data Table (continued)**

Element Number	Type	Tag Name	Description	Units	Range
28	Real	On_Peak_kVAh_Net	Net On Peak kiloVA hours	kVAh	0...999,999
29	Real	On_Peak_kVA_Demand	On Peak Demand for kiloVA	kVA	0.000...9,999,999
30...37	Real	Resvd	Reserved		0

## LoggingResults.MIN\_MAX.Log

**Table 154 - Table Properties**

<b>CIP Instance Number</b>	855
<b>PCCC File Number</b>	F64
<b>No. of Elements</b>	11
<b>Length in Words</b>	22
<b>Data Type</b>	Real
<b>Data Access</b>	Read Only

**Table 155 - LoggingResults.MIN\_MAX.Log Data Table**

Element Number	Type	Tag Name	Description	Units	Range
0	Real	MinMax_Parameter_Number	The number of the parameter from the MIN_MAX parameter list.		1...82 (M5, M6) 1...207 (M8)
1	Real	MIN_Value	The minimum value recorded since the last MIN_MIX clear.		-9.999E15...9.999E15
2	Real	MAX_Value	The maximum value recorded since the last MIN_MIX clear.		-9.999E15...9.999E15
3	Real	Timestamp_MIN_Year	The year at which this MIN record was logged.	YYYY	0...9999
4	Real	Timestamp_MIN_Mth_Day	The month and day this MIN record was logged.	MMDD	0...1231
5	Real	Timestamp_MIN_Hr_Min	The hour and minute this MIN record was logged.	hhmm	0...2359
6	Real	Timestamp_MIN_Sec_ms	The seconds and milliseconds this MIN record was logged.	SSms	0...59,999
7	Real	Timestamp_MAX_Year	The year at which this MAX record was logged.	YYYY	0...9999
8	Real	Timestamp_MAX_Mth_Day	The month and day this MAX record was logged.	MMDD	0...1231
9	Real	Timestamp_MAX_Hr_Min	The hour and minute this MAX record was logged.	hhmm	0...2359
10	Real	Timestamp_MAX_Sec_ms	The seconds and milliseconds this MAX record was logged.	SSms	0...59,999

## LoggingResults.Alarm\_Log

Table 156 - Table Properties

<b>CIP Instance Number</b>	856
<b>PCCC File Number</b>	N65
<b>No. of Elements</b>	7
<b>Length in Words</b>	7
<b>Data Type</b>	Int16
<b>Data Access</b>	Read Only

Table 157 - LoggingResults.Alarm\_Log Data Table

Element Number	Type	Tag Name	Description	Unit	Range
0	Int16	Alarm_Record_Identifier	Used to verify record sequence when returning multiple records.		1...100
1	Int16	Alarm_Timestamp_Year	The year when the record was recorded.	YYYY	2010...2100
2	Int16	Alarm_Timestamp_Mth_Day	The month and day when the record was recorded.	MMDD	11...1231
3	Int16	Alarm_Timestamp_Hr_Min	The hour and minute when the record was recorded.	HHMM	0...2359
4	Int16	Alarm_Timestamp_Sec_ms	The seconds and milliseconds when the record was recorded.	SSms	0...59,999
5	Int16	Alarm Type	Indicates the type of event that has occurred.		0...65535
6	Int16	Alarm Code	Indicates information about the alarm.		0...65535

**LoggingResults.Event\_Log****Table 158 - Table Properties**

<b>CIP Instance Number</b>	857
<b>PCCC File Number</b>	N66
<b>No. of Elements</b>	9
<b>Length in Words</b>	9
<b>Data Type</b>	Int16
<b>Data Access</b>	Read Only

**Table 159 - LoggingResults.Event\_Log Data Table**

<b>Element Number</b>	<b>Type</b>	<b>Tag Name</b>	<b>Description</b>	<b>Unit</b>	<b>Range</b>
0	Int16	Event_Record_Identifier	Used to verify record sequence when returning multiple records.		0...100
1	Int16	Event_Timestamp_Year	The year when the record was recorded.	YYYY	2010...2100
2	Int16	Event_Timestamp_Mth_Day	The month and day when the record was recorded.	MMDD	11...1231
3	Int16	Event_Timestamp_Hr_Min	The hour and minute when the record was recorded.	HHMM	0...2359
4	Int16	Event_Timestamp_Sec_ms	The seconds and milliseconds when the record was recorded.	SSms	0...59,999
5	Int16	Event Type	Indicates the type of event that has occurred.		0...65535
6	Int16	General Code	Indicates general information about the status event.		0...65535
7	Int16	Information Code	Indicates specific information about the status event.		0...65535
8	Int16	Reserved	Reserved		0

## LoggingResults.Setpoint\_Log

**Table 160 - Table Properties**

<b>CIP Instance Number</b>	858
<b>PCCC File Number</b>	F67
<b>No. of Elements</b>	18
<b>Length in Words</b>	36
<b>Data Type</b>	Real
<b>Data Access</b>	Read Only

**Table 161 - LoggingResults.Setpoint\_Log Data Table**

Element Number	Type	Tag Name	Description	Unit	Range
0	Real	Setpoint_Record_Identifier	Used to verify record sequence when returning multiple records.		1...100
1	Real	Setpoint_Timestamp_Year	The year when the record was recorded.	YYYY	2010...2100
2	Real	Setpoint_Timestamp_Mth_Day	The month and day when the record was recorded.	MMDD	11...1231
3	Real	Setpoint_Timestamp_Hr_Min	The hour and minute when the record was recorded.	HHMM	0...2359
4	Real	Setpoint_Timestamp_Sec_ms	The seconds and milliseconds when the record was recorded.	SSms	0...59,999
5	Real	Setpoint_Number	Setpoint number of record.		0...20
6	Real	Setpoint_Status	Setpoint is active (1) or not active (0).		0...1
7	Real	Input_Parameter	Input test parameter of setpoint.		0...105 (M5, M6) 0...230 (M8)
8	Real	Test_Condition	Test Condition.		0...3
9	Real	Evaluation_Type	Evaluation type for setpoint.		1...3
10	Real	Threshold_Setting	The threshold setting magnitude or percent.		0.000... 10,000,000
11	Real	Hysteresis_Setting	Magnitude or percent		0.000... 10,000,000
12	Real	Assert_Delay	Time delay before actuation.	seconds	0.000...3600
13	Real	Deassert_Delay	Time delay before deassert.	seconds	0.000...3600
14	Real	Output_Source	Output flag or bit.		0...40
15	Real	Output_Action	Configured action when actuated.		0...30
16	Real	Accumulated_Time	Total accumulation in seconds.	seconds	0.000... 10,000,000
17	Real	Number_Of_Transitions	Number of transitions from off to on.		0...10,000,000

## LoggingResults.Error\_Log

**Table 162 - Table Properties**

<b>CIP Instance Number</b>	859
<b>PCCC File Number</b>	N68
<b>No. of Elements</b>	24
<b>Length in Words</b>	24
<b>Data Type</b>	Int16
<b>Data Access</b>	Read Only

**Table 163 - LoggingResults.Error\_Log Data Table**

Element Number	Type	Tag Name	Description	Unit	Range
0	Int16	Error_Record_Number	The record number of the log. Record 0 is always the current record before being logged		1...20
1	Int16	Error_Timestamp_Year	The year when the record was recorded	YYYY	2010...2100
2	Int16	Error_Timestamp_Mth_Day	The month and day when the record was recorded	MMDD	11...1231
3	Int16	Error_Timestamp_Hr_Min	The hour and minute when the record was recorded	HHMM	0...2359
4	Int16	Error_Timestamp_Sec_ms	The seconds and milliseconds when the record was recorded	SSms	0...59,999
5	Int16	Error_SlotID_ProcessorID	The slot number and the instance number of the processor	SSII	0...9999
6	Int16	Error_Version_Number	Firmware version		0...65,535
7	Int16	Error_Level_And_BreakSource	The high byte is level: 0 - fatal error 1 - warning The low bytes is break source: 0 - exception 1 - application 2 - OS kernel		0...65,535
8	Int16	Error_File_Number/ExceptionType	The file number where the error occurs or the exception type if the break source is exception		0...65,535
9	Int16	Error_Line Number//LR_Word0	The line number where the error occurs or Link register high word		0...65,535
10	Int16	Error_ThreadStatus_0/LR_Word1	The process ID Group 0 Bit 0...Bit 15 or Link register low word		0...65,535
11	Int16	Error_ThreadStatus_1/ExcauseCode	The process ID Group 1 Bit 0...Bit 15 or exception cause if it is an error from BF518		0...65,535
12	Int16	Error_ThreadStatus_2/Reserved1	The process ID Group 2 Bit 0...Bit 15		0...65,535
13	Int16	Error_ThreadStatus_3/Reserved2	The process ID Group 3 Bit 0...Bit 15		0...65,535
14	Int16	Error_ThreadStatus_4/Reserved3	The process ID Group 4 Bit 0...Bit 15		0...65,535
15	Int16	Error_ThreadStatus_5/Reserved4	The process ID Group 5 Bit 0...Bit 15		0...65,535
16	Int16	Error_ThreadStatus_6/Reserved5	The process ID Group 6 Bit 0...Bit 15		0...65,535
17	Int16	Error_ThreadStatus_7/Reserved6	The process ID Group 7 Bit 0...Bit 15		0...65,535

**Table 163 - LoggingResults.Error\_Log Data Table (continued)**

Element Number	Type	Tag Name	Description	Unit	Range
18	Int16	Error_Active_Process_ID/Reserved7	The process No. of the error occurred thread		0...65,535
19	Int16	Error_No0/Reserved8	Error code high word		0...65,535
20	Int16	Error_No1/Reserved9	Error code low word		0...65,535
21	Int16	Error_Reserved_10	Reserved		0...65,535
22	Int16	Error_Reserved_11	Reserved		0...65,535
23	Int16	Error_Reserved_12	Reserved		0...65,535

## LoggingResults.TriggerLogSetpointInfo\_FileName (M6 and M8 model)

**Table 164 - Table Properties**

<b>CIP Instance Number</b>	866
<b>PCCC File Number</b>	ST75
<b>No. of Elements</b>	1
<b>Length in Words</b>	32
<b>Data Type</b>	String
<b>Data Access</b>	Read Only

**Table 165 - LoggingResults.TriggerLog\_Setpoint\_Info\_File\_Name Data Table**

Element Number	Type	Tag Name	Description	Default	Range
0	String	TriggerLog_Setpoint_Info_File_Name	A single entry table for a 64 character Filename entry	0	64 bytes

## LoggingResults.TriggerLog\_FileName (M6 and M8 model)

**Table 166 - Table Properties**

<b>CIP Instance Number</b>	865
<b>PCCC File Number</b>	ST74
<b>No. of Elements</b>	1
<b>Length in Words</b>	32
<b>Data Type</b>	String
<b>Data Access</b>	Read Only

**Table 167 - LoggingResults.TriggerLog\_FileName Data Table**

Element Number	Type	Tag Name	Description	Default	Range
0	String	Trigger_Log_File_Name	A single entry table for a 64 character Filename entry	0	64 bytes

## LoggingResults.TriggerData\_Header (M6 and M8 model)

**Table 168 - Table Properties**

<b>CIP Instance Number</b>	862
<b>PCCC File Number</b>	F71
<b>No. of Elements</b>	15
<b>Length in Words</b>	30
<b>Data Type</b>	Real
<b>Data Access</b>	Read Only

**Table 169 - LoggingResults.TriggerData\_Header Data Table**

Element Number	Type	Tag Name	Description	Unit	Range
0	Real	Record_Indicator	Indicates the significance of data in the record		0 = No record returned 1 = the record contains parameter values 2 = the record contains general information of the log file being retrieved, reference to each item description in the data table 3 = log file not found
1	Real	TriggerHeader_Record_Identifier	Internal unique record number, if Record_Indicator = 1 Total records number in the log file, if Record_Indicator = 2.	#	+/- 0...9.999E15
2	Real	TriggerAction_Timestamp_Year	The year when the trigger action occurred.	YYYY	2010...2100
3	Real	TriggerAction_Timestamp_Month_Day	The month and day when the trigger action occurred.	MMDD	0101...1231
4	Real	TriggerAction_Timestamp_Hour_Minute	The hour and minute when the trigger action occurred.	hhmm	0000...2359
5	Real	TriggerAction_Timestamp_Sec_mS	The seconds and milliseconds when the trigger action occurred.	ssmS	00000...59999
6	Real	SetpointNumber	Setpoint number of trigger	#	1...30
7	Real	ParameterSelection or Logic_Gate_Type	ParameterSelection if SetpointNumber = (1...20) Logic_Gate_Type if SetpointNumber = (21...30)	#	See description
8	Real	ReferenceValue or Logic_Input_1	ReferenceValue if SetpointNumber = (1...20) Logic_Input_1 if SetpointNumber = (21...30)	#	See description
9	Real	TestCondition or Logic_Input_2	TestCondition if SetpointNumber = (1...20) Logic_Input_2 if SetpointNumber = (21...30)	#	See description
10	Real	EvaluationType or Logic_Input_3	EvaluationType if SetpointNumber = (1...20) Logic_Input_3 if SetpointNumber = (21...30)	#	See description
11	Real	Threshold or Logic_Input_4	Threshold if SetpointNumber = (1...20) Logic_Input_4 if SetpointNumber = (21...30)	#	See description
12	Real	Hysteresis	Hysteresis for setpoint	#	0...10,000,000
13	Real	AssertDelay_s	AssertDelay for setpoint	s	0.000...3600
14	Real	DeassertDelay_s	DeassertDelay for setpoint	s	0.000...3600



**LoggingResults.TriggerData\_Log (M6 and M8 model)****Table 170 - Table Properties**

<b>CIP Instance Number</b>	861
<b>PCCC File Number</b>	F70
<b>No. of Elements</b>	14
<b>Length in Words</b>	28
<b>Data Type</b>	Real
<b>Data Access</b>	Read Only

**Table 171 - LoggingResults.TriggerData\_Log Data Table**

<b>Element Number</b>	<b>Type</b>	<b>Tag Name</b>	<b>Description</b>	<b>Unit</b>	<b>Range</b>
0	Real	Record_Indicator	Indicates the significance of data in the record		0 = No record returned 1 = the record contains parameter values 2 = the record contains general information of the log file being retrieved, reference to each item description in the data table 3 = log file not found
1	Real	TriggerData_Record_Identifier	Internal unique record number, if Record_Indicator = 1 Total records number in the log file, if Record_Indicator = 2.	#	0 ... 3600
2	Real	TriggerData_Timestamp_Year	The year when the record was recorded if Record_Indicator = 1.	YYYY	2010 ... 2100
3	Real	TriggerData_Timestamp_Month_Day	The month and day when the record was recorded Record_Indicator = 1.	MMDD	0101 ... 1231
4	Real	TriggerData_Timestamp_Hour_Minute	The hour and minute when the record was recorded Record_Indicator = 1.	hhmm	0000 ... 2359
5	Real	TriggerData_Timestamp_Sec_mS	The seconds and milliseconds when the record was recorded Record_Indicator = 1.	ssmS	00000 ... 59999
6	Real	TriggerDataLog_Parameter_1	Parameter value if Record_Indicator = 1 Parameter index (reference to Trigger Data Log Parameter List table) if Record_Indicator = 2;	#	+/- 0 ... 9.999E15
7	Real	TriggerDataLog_Parameter_2		#	+/- 0 ... 9.999E15
8	Real	TriggerDataLog_Parameter_3		#	+/- 0 ... 9.999E15
9	Real	TriggerDataLog_Parameter_4		#	+/- 0 ... 9.999E15
10	Real	TriggerDataLog_Parameter_5		#	+/- 0 ... 9.999E15
11	Real	TriggerDataLog_Parameter_6		#	+/- 0 ... 9.999E15
12	Real	TriggerDataLog_Parameter_7		#	+/- 0 ... 9.999E15
13	Real	TriggerDataLog_Parameter_8		#	+/- 0 ... 9.999E15

## LoggingResults.Power\_Quality\_Log (M6 and M8 model)

**Table 172 - Table Properties**

<b>CIP Instance Number</b>	864
<b>PCCC File Number</b>	F73
<b>No. of Elements</b>	32
<b>Length in Words</b>	64
<b>Data Type</b>	Real
<b>Data Access</b>	Read Only

**Table 173 - LoggingResults. Power\_Quality\_Log Data Table**

Element Number	Type	Tag Name	Description	Unit	Range
0	Real	Record_Identifier	Used to verify record sequence when returning multiple records	#	1...100
1	Real	Event_Type	Power quality event type, see 'Power Quality Event List' data table of the document	#	1...24
2	Real	Sub_Event_Code	Indicate the sub event of the event type. For example, a sag event can happen in V1, V2 or V3. see 'Power Quality Event List' data table of the document	#	1...4
3	Real	Local_Timestamp_Year	Year of the local time when the record was recorded	YYYY	2010...2100
4	Real	Local_Timestamp_Mth_Day	Month and Day of the local time when the record was recorded	MMDD	0101...1231
5	Real	Local_Timestamp_Hr_Min	Hour and Minute of the local time when the record was recorded	hhmm	0000...2359
6	Real	Local_Timestamp_Sec_mS	Second and Millisecond of the local time when the record was recorded.	ssmS	00000...59999
7	Real	Local_Timestamp_uS	Microsecond when the record was recorded	uS	000...999
8	Real	UTC_Timestamp_Year	Year of the UTC when the record was recorded	YYYY	2010...2100
9	Real	UTC_Timestamp_Mth_Day	Month and Day of the UTC when the record was recorded	MMDD	0101...1231
10	Real	UTC_Timestamp_Hr_Min	Hour and Minute of the UTC when the record was recorded.	hhmm	0000...2359
11	Real	UTC_Timestamp_Sec_mS	Second and Millisecond of UTC when the record was recorded.	ssmS	00000...59999
12	Real	UTC_Timestamp_uS	Microsecond of UTC when the record was recorded.	uS	000...999
13	Real	Association_Timestamp_Year	Year of the timestamp associated with waveform file if the event can trigger a waveform capture	YYYY	2010...2100
14	Real	Association_Timestamp_Mth_Day	Month and Day of the timestamp associated with waveform file if the event can trigger a waveform capture	MMDD	0101...1231
15	Real	Association_Timestamp_Hr_Min	Hour and Minute of the timestamp associated with waveform file if the event can trigger a waveform capture	hhmm	0000...2359
16	Real	Association_Timestamp_Sec_mS	Second and Millisecond of the timestamp associated with waveform file if the event can trigger a waveform capture	ssmS	00000...59999
17	Real	Association_Timestamp_uS	Microsecond of the timestamp associated with waveform file	uS	000...999

**Table 173 - LoggingResults. Power\_Quality\_Log Data Table (continued)**

Element Number	Type	Tag Name	Description	Unit	Range
18	Real	Event_Duration_mS	Event duration in millisecond.	mS	0...60000
19	Real	Min_or_Max	Min value of the event or Max value of the event.	Volts	+/- 0...9.999e15
20	Real	Trip_Point	The trip point that triggered the event	#	+/- 0...9.999e15
21	Real	WSB_Originator	ID of the WSB message generator, the 3 least significant bytes of MAC ID.	#	0...16777215 (0x0...0xFFFFF)
22...31	Real	Reserved	Future Use		0

### LoggingResults.Snapshot\_Log (M6 and M8 model)

**Table 174 - Table Properties**

<b>CIP Instance Number</b>	872
<b>PCCC File Number</b>	F81
<b>No. of Elements</b>	2
<b>Length in Words</b>	4
<b>Data Type</b>	Real
<b>Data Access</b>	Read Only

**Table 175 - LoggingResults. Snapshot\_Log Data Table**

Element Number	Type	Tag Name	Description	Unit	Range
0	Real	Parameter_Number	The number of the parameter from the metering snapshot parameter list.	#	1...2270 (M6) 1...4447 (M8, Group 0) 1...1233 (M8, Group 1) 1...20,439 (M8, Group 2)
1	Real	Parameter_Value	The value recorded when metering data snapshot		-9.999E15...9.999E15

### LoggingResults.WaveformFileName (M6 and M8 model)

Table 176 - Table Properties

<b>CIP Instance Number</b>	869
<b>PCCC File Number</b>	ST78
<b>No. of Elements</b>	1
<b>Length in Words</b>	32
<b>Data Type</b>	String
<b>Data Access</b>	Read Only

Table 177 - LoggingResults.WaveformFileName Data Table

Element Number	Type	Tag Name	Description	Default	Range
0	String	Waveform_File_Name	A single entry table for a 64 character Filename entry	0	64 bytes

### LoggingResults.Waveform\_Log (M6 and M8 model)

Table 178 - Table Properties

<b>CIP Instance Number</b>	871
<b>PCCC File Number</b>	F80
<b>No. of Elements</b>	43
<b>Length in Words</b>	86
<b>Data Type</b>	Real
<b>Data Access</b>	Read Only

Table 179 - LoggingResults.Waveform\_Log Data Table

Element Number	Type	Tag Name	Description	Unit	Range
0	Real	Record_Indicator	Indicates the significance of the data in the record		0 = No record returned 1= the record contains parameter values 2 = the record contains general information of the log file being retrieved, reference to each item description in the data table 3 = log file not found.
1	Real	Timestamp_Date	Date of cycle collection MMDDYY	MMDDYY	0...123199
2	Real	Timestamp_Time	Time of cycle collection hhmmss	hhmmss	0...235959
3	Real	Microsecond_Stamp	Microsecond of cycle collection	uS	0.000...999,999
4	Real	File_ID	The selected file ID	#	1...256
5	Real	Total_Cycles	Total cycles of the waveform file	#	0...3640
6	Real	Cycle_Returned	The current returned cycle	#	0...(Total cycles - 1)
7	Real	Frequency	The frequency of average cycle	Hz	50 or 60
8	Real	Mag_Angle	The returned value is mag or angle	#	0 = Mag, 1 = Angle

**Table 179 - LoggingResults. Waveform\_Log Data Table (continued)**

Element Number	Type	Tag Name	Description	Unit	Range
9	Real	Channel	The channel returned	#	0 = V1 1 = V2 2 = V3 3 = V4 4 = I1 5 = I2 6 = I3 7 = I4
10	Real	Order	The range of harmonic orders of returned values	#	0 = DC...31st 1 = 32nd...63rd 2 = 64th...95th (M8 only) 3 = 96th...127th (M8 only)
11	Real	X_(0 + Order * 32)	The returned value X_(h) for the spectral component specified by Channel at harmonic h X_(h) = RMS magnitude if Mag_Angle = 0 X_(h) = Angle if Mag_Angle = 1	V, A, or degrees, depending on value of Channel and Mag_Angle	+/- 0...9.999E15
12	Real	X_(1 + Order * 32)			+/- 0...9.999E15
13	Real	X_(2 + Order * 32)			+/- 0...9.999E15
14	Real	X_(3 + Order * 32)			+/- 0...9.999E15
15	Real	X_(4 + Order * 32)			+/- 0...9.999E15
16	Real	X_(5 + Order * 32)			+/- 0...9.999E15
17	Real	X_(6 + Order * 32)			+/- 0...9.999E15
18	Real	X_(7 + Order * 32)			+/- 0...9.999E15
19	Real	X_(8 + Order * 32)			+/- 0...9.999E15
20	Real	X_(9 + Order * 32)			+/- 0...9.999E15
21	Real	X_(10 + Order * 32)			+/- 0...9.999E15
22	Real	X_(11 + Order * 32)			+/- 0...9.999E15
23	Real	X_(12 + Order * 32)			+/- 0...9.999E15
24	Real	X_(13 + Order * 32)			+/- 0...9.999E15
25	Real	X_(14 + Order * 32)			+/- 0...9.999E15
26	Real	X_(15 + Order * 32)			+/- 0...9.999E15
27	Real	X_(16 + Order * 32)			+/- 0...9.999E15
28	Real	X_(17 + Order * 32)			+/- 0...9.999E15
29	Real	X_(18 + Order * 32)			+/- 0...9.999E15
30	Real	X_(19 + Order * 32)			+/- 0...9.999E15
31	Real	X_(20 + Order * 32)			+/- 0...9.999E15
32	Real	X_(21 + Order * 32)			+/- 0...9.999E15
33	Real	X_(22 + Order * 32)			+/- 0...9.999E15
34	Real	X_(23 + Order * 32)			+/- 0...9.999E15
35	Real	X_(24 + Order * 32)			+/- 0...9.999E15
36	Real	X_(25 + Order * 32)			+/- 0...9.999E15
37	Real	X_(26 + Order * 32)			+/- 0...9.999E15
38	Real	X_(27 + Order * 32)			+/- 0...9.999E15

**Table 179 - LoggingResults.Waveform\_Log Data Table (continued)**

Element Number	Type	Tag Name	Description	Unit	Range
39	Real	X_(28 + Order * 32)	The returned value X_(h) for the spectral component specified by Channel at harmonic h X_(h) = RMS magnitude if Mag_Angle = 0 X_(h) = Angle if Mag_Angle = 1		+/- 0...9.999E15
40	Real	X_(29 + Order * 32)			+/- 0...9.999E15
41	Real	X_(30 + Order * 32)			+/- 0...9.999E15
42	Real	X_(31 + Order * 32)			+/- 0...9.999E15

### LoggingResults.EN50160\_Weekly\_Log (M8 only)

**Table 180 - Table Properties**

<b>CIP Instance Number</b>	874
<b>PCCC File Number</b>	F83
<b>No. of Elements</b>	13
<b>Length in Words</b>	26
<b>Data Type</b>	Real
<b>Data Access</b>	Read only
<b>Applies to</b>	M8 only

**Table 181 - LoggingResults.EN50160\_Weekly\_Log Data Table**

Element Number	Type	Tag Name	Description	Units	Range
0	Real	Record_Number	The record number of the log. Record 1 is always the current record before being logged.	#	1...8
1	Real	Log_Date	The Date this record was started.	YYMMDD	0...999,999
2	Real	Supply Voltage Range 1	Metering interval is 10 minutes; Conformance limit is +10% / - 10%; Conformance recommendation is 95%	%	0.00...100.00
3	Real	Supply Voltage Range 2	Metering interval is 10 minutes; Conformance limit is +10% / - 15%; Conformance recommendation is 100%	%	0.00...100.00
4	Real	Flicker Severity Plt	Metering interval is 2 hours; Conformance limit is 1 or less; Conformance recommendation is 95%	%	0.00...100.00
5	Real	Supply Voltage Unbalance	Metering interval is 10 minutes; Conformance limit is 0% to 2%; Conformance recommendation is 95%	%	0.00...100.00
6	Real	Individual Harmonic Voltage	Metering interval is 10 minutes; Conformance limit is the table 1 of the EN50160 standard; Conformance recommendation is 95%	%	0.00...100.00
7	Real	Voltage THD	Metering interval is 10 minutes; Conformance limit is 8% or less; Conformance recommendation is 100%	%	0.00...100.00
8	Real	Non Synchronous Power Freq. Range 1	Metering interval is 10 seconds; Conformance limit is +2% / -2%; Conformance recommendation is 95%	%	0.00...100.00
9	Real	Non Synchronous Power Freq. Range 2	Metering interval is 10 seconds; Conformance limit is +15% / -15%; Conformance recommendation is 100%	%	0.00...100.00
10	Real	10_Minutes_Valid_Data_Counts	Number of 10 minutes intervals without interruption flag set during 1 day	#	0...999,999
11	Real	2_Hours_Valid_Data_Counts	Number of 2 hours intervals without interruption flag set during 1 day	#	0...999,999
12	Real	10_Seconds_Valid_Data_Counts	Number of 10 seconds intervals without interruption flag set during 1 day	#	0...999,999

**LoggingResults.EN50160\_Yearly\_Log (M8 only)****Table 182 - Table Properties**

<b>CIP Instance Number</b>	875
<b>PCCC File Number</b>	F84
<b>No. of Elements</b>	37
<b>Length in Words</b>	74
<b>Data Type</b>	Real
<b>Data Access</b>	Read only
<b>Applies to</b>	M8 only

**Table 183 - LoggingResults.EN50160\_Yearly\_Log Data Table**

<b>Element Number</b>	<b>Type</b>	<b>Tag Name</b>	<b>Description</b>	<b>Units</b>	<b>Range</b>
0	Real	Record_Number	The record number of the log. Record 1 is always the current record before being logged.	#	1...13
1	Real	Log_Start_Date	The Date this record was started.	YYMMDD	0...999,999
2	Real	Log_End_Date	The Date this record was completed.	YYMMDD	0...999,999
3	Real	Synchronous Power Frequency Range 1	Metering interval is 10 seconds; Conformance limit is +1% / - 1%; Conformance recommendation is 99.5%	%	0.00...100.00
4	Real	Synchronous Power Frequency Range 2	Metering interval is 10 seconds; Conformance limit is +4% / - 6%; Conformance recommendation is 100%	%	0.00...100.00
5	Real	Sag 90...80% u, 10...200 mS Duration	Number of sag incidence in the assigned cell. Aggregated result from yearly log.	#	0...9,999,999
6	Real	Sag 90...80% u, 200...500 mS Duration	Number of sag incidence in the assigned cell. Aggregated result from yearly log.	#	0...9,999,999
7	Real	Sag 90...80% u, 500...1000 mS Duration	Number of sag incidence in the assigned cell. Aggregated result from yearly log.	#	0...9,999,999
8	Real	Sag 90...80% u, 1000...5000 mS Duration	Number of sag incidence in the assigned cell. Aggregated result from yearly log.	#	0...9,999,999
9	Real	Sag 90...80%u,5000...60,000mS Duration	Number of sag incidence in the assigned cell. Aggregated result from yearly log.	#	0...9,999,999
10	Real	Sag 80...70% u, 10...200 mS Duration	Number of sag incidence in the assigned cell. Aggregated result from yearly log.	#	0...9,999,999
11	Real	Sag 80...70% u, 200...500 mS Duration	Number of sag incidence in the assigned cell. Aggregated result from yearly log.	#	0...9,999,999
12	Real	Sag 80...70% u, 500...1000 mS Duration	Number of sag incidence in the assigned cell. Aggregated result from yearly log.	#	0...9,999,999
13	Real	Sag 80...70% u, 1000...5000 mS Duration	Number of sag incidence in the assigned cell. Aggregated result from yearly log.	#	0...9,999,999
14	Real	Sag 80...70% u, 5000...60,000 mS Duration	Number of sag incidence in the assigned cell. Aggregated result from yearly log.	#	0...9,999,999
15	Real	Sag 70...40% u, 10...200 mS Duration	Number of sag incidence in the assigned cell. Aggregated result from yearly log.	#	0...9,999,999
16	Real	Sag 70...40% u, 200...500 mS Duration	Number of sag incidence in the assigned cell. Aggregated result from yearly log.	#	0...9,999,999

**Table 183 - LoggingResults.EN50160\_Yearly\_Log Data Table (continued)**

Element Number	Type	Tag Name	Description	Units	Range
17	Real	Sag 70...40% u, 500...1000 mS Duration	Number of sag incidence in the assigned cell. Aggregated result from yearly log.	#	0...9,999,999
18	Real	Sag 70...40% u, 1000...5000 mS Duration	Number of sag incidence in the assigned cell. Aggregated result from yearly log.	#	0...9,999,999
19	Real	Sag 70...40% u, 5000...60,000 mS Duration	Number of sag incidence in the assigned cell. Aggregated result from yearly log.	#	0...9,999,999
20	Real	Sag 40...5% u, 10...200 mS Duration	Number of sag incidence in the assigned cell. Aggregated result from yearly log.	#	0...9,999,999
21	Real	Sag 40...5% u, 200...500 mS Duration	Number of sag incidence in the assigned cell. Aggregated result from yearly log.	#	0...9,999,999
22	Real	Sag 40...5% u, 500...1000 mS Duration	Number of sag incidence in the assigned cell. Aggregated result from yearly log.	#	0...9,999,999
23	Real	Sag 40...5% u, 1000...5000 mS Duration	Number of sag incidence in the assigned cell. Aggregated result from yearly log.	#	0...9,999,999
24	Real	Sag 40...5% u, 5000...60,000 mS Duration	Number of sag incidence in the assigned cell. Aggregated result from yearly log.	#	0...9,999,999
25	Real	Sag less than 5% u, 10...200 mS Duration	Number of sag incidence in the assigned cell. Aggregated result from yearly log.	#	0...9,999,999
26	Real	Sag less than 5% u, 200...500 mS Duration	Number of sag incidence in the assigned cell. Aggregated result from yearly log.	#	0...9,999,999
27	Real	Sag less than 5% u, 500...1000 mS Duration	Number of sag incidence in the assigned cell. Aggregated result from yearly log.	#	0...9,999,999
28	Real	Sag less than 5% u, 1000...5000 mS Duration	Number of sag incidence in the assigned cell. Aggregated result from yearly log.	#	0...9,999,999
29	Real	Sag less than 5% u, 5000...60,000 mS Duration	Number of sag incidence in the assigned cell. Aggregated result from yearly log.	#	0...9,999,999
30	Real	Swell 120% u or greater, 10...500 mS Duration	Number of swell incidence in the assigned cell. Aggregated result from yearly log.	#	0...9,999,999
31	Real	Swell 120% u or greater, 500...5000 mS Duration	Number of swell incidence in the assigned cell. Aggregated result from yearly log.	#	0...9,999,999
32	Real	Swell 120% u or greater, 5000...60,000 mS Duration	Number of swell incidence in the assigned cell. Aggregated result from yearly log.	#	0...9,999,999
33	Real	Swell 120...110% u, 10...500 mS Duration	Number of swell incidence in the assigned cell. Aggregated result from yearly log.	#	0...9,999,999
34	Real	Swell 120...110% u, 500...5000 mS Duration	Number of swell incidence in the assigned cell. Aggregated result from yearly log.	#	0...9,999,999
35	Real	Swell 120...110% u, 5000...60,000 mS Duration	Number of swell incidence in the assigned cell. Aggregated result from yearly log.	#	0...9,999,999
36	Real	10_Seconds_Valid_Data_Counts	Number of 10 seconds intervals without interruption flag set during 1 month.	#	0...9,999,999



**PowerQuality.RealTime\_PowerQuality****Table 184 - Table Properties**

<b>CIP Instance Number</b>	845
<b>PCCC File Number</b>	F54
<b>No. of Elements</b>	56
<b>Length in Words</b>	112
<b>Data Type</b>	Real
<b>Data Access</b>	Read Only

**Table 185 - PowerQuality.RealTime\_PowerQuality Data Table**

<b>Element Number</b>	<b>Type</b>	<b>Tag Name</b>	<b>Description</b>	<b>Units</b>	<b>Range</b>
0	Real	Metering Date Stamp	Date of cycle collection MM:DD:YY	MM:DD:YY	0...123,199
1	Real	Metering Time Stamp	Time of cycle collection HH:MM:SS	HH:MM:SS	0...235,959
2	Real	Metering Microsecond Stamp	Microsecond of cycle collection	uS	0.000...999,999
3	Real	V1_Crest_Factor	V1 crest factor		0...9.999E15
4	Real	V2_Crest_Factor	V2 crest factor		0...9.999E15
5	Real	V3_Crest_Factor	V3 crest factor		0...9.999E15
6	Real	V1_V2_Crest_Factor	V1 V2 crest factor		0...9.999E15
7	Real	V2_V3_Crest_Factor	V2 V3 crest factor		0...9.999E15
8	Real	V3_V1_Crest_Factor	V3 V1 crest factor		0...9.999E15
9	Real	I1_Crest_Factor	I1 crest factor		0...9.999E15
10	Real	I2_Crest_Factor	I2 crest factor		0...9.999E15
11	Real	I3_Crest_Factor	I3 crest factor		0...9.999E15
12	Real	I4_Crest_Factor	I4 crest factor		0...9.999E15
13	Real	V1_IEEE_THD_%	V1-N IEEE Total Harmonic Distortion	%	0.00...100.00
14	Real	V2_IEEE_THD_%	V2-N IEEE Total Harmonic Distortion	%	0.00...100.00
15	Real	V3_IEEE_THD_%	V3-N IEEE Total Harmonic Distortion	%	0.00...100.00
16	Real	VN_G_IEEE_THD_%	VGN-N IEEE Total Harmonic Distortion	%	0.00...100.00
17	Real	Avg_IEEE_THD_V_%	Average V1/V2/V3 to N IEEE Total Harmonic Distortion	%	0.00...100.00
18	Real	V1_V2_IEEE_THD_%	V1-V2 IEEE Total Harmonic Distortion	%	0.00...100.00
19	Real	V2_V3_IEEE_THD_%	V2-V3 IEEE Total Harmonic Distortion	%	0.00...100.00
20	Real	V3_V1_IEEE_THD_%	V3-V1 IEEE Total Harmonic Distortion	%	0.00...100.00
21	Real	Avg_IEEE_THD_V_V_%	Average IEEE THD for V1-V2, V2-V3, V3-V1	%	0.00...100.00
22	Real	I1_IEEE_THD_%	I1 IEEE Total Harmonic Distortion	%	0.00...100.00
23	Real	I2_IEEE_THD_%	I2 IEEE Total Harmonic Distortion	%	0.00...100.00
24	Real	I3_IEEE_THD_%	I3 IEEE Harmonic Distortion	%	0.00...100.00
25	Real	I4_IEEE_THD_%	I4 IEEE Harmonic Distortion	%	0.00...100.00
26	Real	Avg_IEEE_THD_I_%	Average I1/I2/I3 IEEE Total Harmonic Distortion	%	0.00...100.00
27	Real	V1_IEC_THD_%	V1-N IEC Total Harmonic Distortion	%	0.00...100.00
28	Real	V2_IEC_THD_%	V2-N IEC Total Harmonic Distortion	%	0.00...100.00

**Table 185 - PowerQuality.RealTime\_PowerQuality Data Table (continued)**

Element Number	Type	Tag Name	Description	Units	Range
29	Real	V3_IEC_THD_%	V3-N IEC Total Harmonic Distortion	%	0.00...100.00
30	Real	VN_G_IEC_THD_%	VGN-N IEC Total Harmonic Distortion	%	0.00...100.00
31	Real	Avg_IEC_THD_V_%	Average V1/V2/V3 to N IEC Total Harmonic Distortion	%	0.00...100.00
32	Real	V1_V2_IEC_THD_%	V1-V2 IEC Total Harmonic Distortion	%	0.00...100.00
33	Real	V2_V3_IEC_THD_%	V2-V3 IEC Total Harmonic Distortion	%	0.00...100.00
34	Real	V3_V1_IEC_THD_%	V3-V1 IEC Total Harmonic Distortion	%	0.00...100.00
35	Real	Avg_IEC_THD_V_V_%	Average IEC THD for V1-V2, V2-V3, V3-V1	%	0.00...100.00
36	Real	I1_IEC_THD_%	I1 IEC Total Harmonic Distortion	%	0.00...100.00
37	Real	I2_IEC_THD_%	I2 IEC Total Harmonic Distortion	%	0.00...100.00
38	Real	I3_IEC_THD_%	I3 IEC Total Harmonic Distortion	%	0.00...100.00
39	Real	I4_IEC_THD_%	I4 IEC Total Harmonic Distortion	%	0.00...100.00
40	Real	Avg_IEC_THD_I_%	Average I1/I2/I3 IEC Total Harmonic Distortion	%	0.00...100.00
41	Real	Pos_Seq_Volts	Positive Sequence Voltage	V	0...9.999E15
42	Real	Neg_Seq_Volts	Negative Sequence Voltage	V	0...9.999E15
43	Real	Zero_Seq_Volts	Zero Sequence Voltage	V	0...9.999E15
44	Real	Pos_Seq_Amps	Positive Sequence Amps	A	0...9.999E15
45	Real	Neg_Seq_Amps	Negative Sequence Amps	A	0...9.999E15
46	Real	Zero_Seq_Amps	Zero Sequence Amps	A	0...9.999E15
47	Real	Voltage_Unbalance_%	Voltage percent unbalance	%	0.00...100.00
48	Real	Current_Unbalance_%	Current percent unbalance	%	0.00...100.00
49	Real	I1_K_Factor	I1 K-factor	-	1.00... 25,000.00
50	Real	I2_K_Factor	I2 K-factor	-	1.00... 25,000.00
51	Real	I3_K_Factor	I3 K-factor	-	1.00... 25,000.00
52...55	Real	Resvd	Reserved		

**PowerQuality.EN61000\_4\_30\_HSG (M8 only)****Table 186 - Table Properties**

<b>CIP Instance Number</b>	879
<b>PCCC File Number</b>	F88
<b>No. of Elements</b>	23
<b>Length in Words</b>	46
<b>Data Type</b>	Real
<b>Data Access</b>	Read only
<b>Applies to</b>	M8 only

**Table 187 - PowerQuality.EN61000\_4\_30\_HSG Data Tables**

<b>Element Number</b>	<b>Type</b>	<b>Tag Name</b>	<b>Description</b>	<b>Units</b>	<b>Range</b>
0	Real	200mS_Metering_Date_Stamp	Date of cycle collection MM:DD:YY	MMDDYY	0...123199
1	Real	200mS_Metering_Time_Stamp	Time of cycle collection HH:MM:SS	hhmmss	0...235959
2	Real	200mS_Metering_uSecond_Stamp	Microsecond of cycle collection	uS	0.000...999,999
3	Real	200mS_V1_N_THDS_%	Total distortion of the EN61000-4-30 harmonic distortion subgroups.	%	0.00...100.00
4	Real	200mS_V2_N_THDS_%	Total distortion of the EN61000-4-30 harmonic distortion subgroups.	%	0.00...100.00
5	Real	200mS_V3_N_THDS_%	Total distortion of the EN61000-4-30 harmonic distortion subgroups.	%	0.00...100.00
6	Real	200mS_VN_G_THDS_%	Total distortion of the EN61000-4-30 harmonic distortion subgroups.	%	0.00...100.00
7	Real	200mS_AVE_VN_THDS_%	Total distortion of the EN61000-4-30 harmonic distortion subgroups.	%	0.00...100.00
8	Real	200mS_V1_V2_THDS_%	Total distortion of the EN61000-4-30 harmonic distortion subgroups.	%	0.00...100.00
9	Real	200mS_V2_V3_THDS_%	Total distortion of the EN61000-4-30 harmonic distortion subgroups.	%	0.00...100.00
10	Real	200mS_V3_V1_THDS_%	Total distortion of the EN61000-4-30 harmonic distortion subgroups.	%	0.00...100.00
11	Real	200mS_AVE_LL_THDS_%	Total distortion of the EN61000-4-30 harmonic distortion subgroups.	%	0.00...100.00
12	Real	200mS_V1_N_TIHDS_%	Total distortion of the EN61000-4-30 harmonic distortion subgroups.	%	0.00...100.00
13	Real	200mS_V2_N_TIHDS_%	Total distortion of the EN61000-4-30 harmonic distortion subgroups.	%	0.00...100.00
14	Real	200mS_V3_N_TIHDS_%	Total distortion of the EN61000-4-30 harmonic distortion subgroups.	%	0.00...100.00
15	Real	200mS_VN_G_TIHDS_%	Total distortion of the EN61000-4-30 harmonic distortion subgroups.	%	0.00...100.00
16	Real	200mS_AVE_VN_TIHDS_%	Total distortion of the EN61000-4-30 harmonic distortion subgroups.	%	0.00...100.00
17	Real	200mS_V1_V2_TIHDS_%	Total distortion of the EN61000-4-30 harmonic distortion subgroups.	%	0.00...100.00
18	Real	200mS_V2_V3_TIHDS_%	Total distortion of the EN61000-4-30 harmonic distortion subgroups.	%	0.00...100.00
19	Real	200mS_V3_V1_TIHDS_%	Total distortion of the EN61000-4-30 harmonic distortion subgroups.	%	0.00...100.00
20	Real	200mS_AVE_LL_TIHDS_%	Total distortion of the EN61000-4-30 harmonic distortion subgroups.	%	0.00...100.00
21	Real	200mS_Sag_Swell_Status_Flag	A flag indicating 200 ms result has been calculated during a Sag, Swell or Interruption.	#	0...1
22	Real	200mS_Metering_Iteration	A number 0...9,999,999 that indicates that the metering functions and internal communications are updating.	#	0...9,999,999

### PowerQuality.EN61000\_4\_30\_THD (M8 only)

Table 188 - Table Properties

<b>CIP Instance Number</b>	881
<b>PCCC File Number</b>	F90
<b>No. of Elements</b>	46
<b>Length in Words</b>	92
<b>Data Type</b>	Real
<b>Data Access</b>	Read only
<b>Applies to</b>	M8 only

Table 189 - PowerQuality.EN61000\_4\_30\_THD

Element Number	Type	Tag Name	Description	Units	Range
0	Real	200mS_Metering_Date_Stamp	Date of cycle collection MM:DD:YY	MMDDYY	0...123,199
1	Real	200mS_Metering_Time_Stamp	Time of cycle collection HH:MM:SS	hhmmss	0...235,959
2	Real	200mS_Metering_uSecond_Stamp	Microsecond of cycle collection	uS	0.000...999,999
3	Real	200mS_V1_Crest_Factor	V1 crest factor	-	0...9.999E15
4	Real	200mS_V2_Crest_Factor	V2 crest factor	-	0...9.999E15
5	Real	200mS_V3_Crest_Factor	V3 crest factor	-	0...9.999E15
6	Real	200mS_V1_V2_Crest_Factor	V1 V2 crest factor	-	0...9.999E15
7	Real	200mS_V2_V3_Crest_Factor	V2 V3 crest factor	-	0...9.999E15
8	Real	200mS_V3_V1_Crest_Factor	V3 V1 crest factor	-	0...9.999E15
9	Real	200mS_I1_Crest_Factor	I1 crest factor	-	0...9.999E15
10	Real	200mS_I2_Crest_Factor	I2 crest factor	-	0...9.999E15
11	Real	200mS_I3_Crest_Factor	I3 crest factor	-	0...9.999E15
12	Real	200mS_I4_Crest_Factor	I4 crest factor	-	0...9.999E15
13	Real	200mS_V1_N_IEEE_THD_%	V1-N IEEE Total Harmonic Distortion	%	0.00...100.00
14	Real	200mS_V2_N_IEEE_THD_%	V2-N IEEE Total Harmonic Distortion	%	0.00...100.00
15	Real	200mS_V3_N_IEEE_THD_%	V3-N IEEE Total Harmonic Distortion	%	0.00...100.00
16	Real	200mS_VN_G_IEEE_THD_%	VN-G IEEE Total Harmonic Distortion	%	0.00...100.00
17	Real	200mS_Avg_IEEE_THD_V_%	Average V1/V2/V3 to N IEEE Total Harmonic Distortion	%	0.00...100.00
18	Real	200mS_V1_V2_IEEE_THD_%	V1-V2 IEEE Total Harmonic Distortion	%	0.00...100.00
19	Real	200mS_V2_V3_IEEE_THD_%	V2-V3 IEEE Total Harmonic Distortion	%	0.00...100.00
20	Real	200mS_V3_V1_IEEE_THD_%	V3-V1 IEEE Total Harmonic Distortion	%	0.00...100.00
21	Real	200mS_Avg_IEEE_THD_V_V_%	Average IEEE THD for V1-V2, V2-V3, V3-V1	%	0.00...100.00
22	Real	200mS_I1_IEEE_THD_%	I1 IEEE Total Harmonic Distortion	%	0.00...100.00
23	Real	200mS_I2_IEEE_THD_%	I2 IEEE Total Harmonic Distortion	%	0.00...100.00
24	Real	200mS_I3_IEEE_THD_%	I3 IEEE Total Harmonic Distortion	%	0.00...100.00
25	Real	200mS_I4_IEEE_THD_%	I4 IEEE Total Harmonic Distortion	%	0.00...100.00
26	Real	200mS_Avg_IEEE_THD_I_%	Average I1/I2/I3 IEEE Total Harmonic Distortion	%	0.00...100.00
27	Real	200mS_V1_N_IEC_THD_%	V1-N IEC Total Harmonic Distortion	%	0.00...100.00

**Table 189 - PowerQuality.EN61000\_4\_30\_THD (continued)**

Element Number	Type	Tag Name	Description	Units	Range
28	Real	200mS_V2_N_IEC_THD_%	V2-N IEC Total Harmonic Distortion	%	0.00...100.00
29	Real	200mS_V3_N_IEC_THD_%	V3-N IEC Total Harmonic Distortion	%	0.00...100.00
30	Real	200mS_VN_G_IEC_THD_%	VN-G IEC Total Harmonic Distortion	%	0.00...100.00
31	Real	200mS_Avg_IEC_THD_V_%	Average V1/V2/V3 to N IEC Total Harmonic Distortion	%	0.00...100.00
32	Real	200mS_V1_V2_IEC_THD_%	V1-V2 IEC Total Harmonic Distortion	%	0.00...100.00
33	Real	200mS_V2_V3_IEC_THD_%	V2-V3 IEC Total Harmonic Distortion	%	0.00...100.00
34	Real	200mS_V3_V1_IEC_THD_%	V3-V1 IEC Total Harmonic Distortion	%	0.00...100.00
35	Real	200mS_Avg_IEC_THD_V_V_%	Average IEC THD for V1-V2, V2-V3, V3-V1	%	0.00...100.00
36	Real	200mS_I1_IEC_THD_%	I1 IEC Total Harmonic Distortion	%	0.00...100.00
37	Real	200mS_I2_IEC_THD_%	I2 IEC Total Harmonic Distortion	%	0.00...100.00
38	Real	200mS_I3_IEC_THD_%	I3 IEC Total Harmonic Distortion	%	0.00...100.00
39	Real	200mS_I4_IEC_THD_%	I4 IEC Total Harmonic Distortion	%	0.00...100.00
40	Real	200mS_Avg_IEC_THD_I_%	Average I1/I2/I3 IEC Total Harmonic Distortion	%	0.00...100.00
41	Real	200mS_I1_K_Factor	I1 K-factor	-	1.00...25,000.00
42	Real	200mS_I2_K_Factor	I2 K-factor	-	1.00...25,000
43	Real	200mS_I3_K_Factor	I3 K-factor	-	1.00...25,000.00
44	Real	200mS_Sag_Swell_Status_Flag	A flag indicating 200 ms result has been calculated during a Sag, Swell, or Interruption.	#	0...1
45	Real	200mS_Metering_Iteration	A number 0...9,999,999 that indicates that the metering functions and internal communications are updating.	#	0...9,999,999

### PowerQuality.EN61000\_4\_30\_Sequence (M8 only)

Table 190 - Table Properties

<b>CIP Instance Number</b>	882
<b>PCCC File Number</b>	F91
<b>No. of Elements</b>	13
<b>Length in Words</b>	26
<b>Data Type</b>	Real
<b>Data Access</b>	Read only
<b>Applies to</b>	M8 only

Table 191 - PowerQuality.EN61000\_4\_30\_Sequence Data Table

Element Number	Type	Tag Name	Description	Units	Range
0	Real	200mS_Metering_Date_Stamp	Date of cycle collection MM:DD:YY	MMDDYY	0...123,199
1	Real	200mS_Metering_Time_Stamp	Time of cycle collection HH:MM:SS	hhmmss	0...235,959
2	Real	200mS_Metering_uSecond_Stamp	Microsecond of cycle collection	uS	0.000...999,999
3	Real	200mS_Pos_Seq_Volts	Positive Sequence Voltage	V	0...9.999E15
4	Real	200mS_Neg_Seq_Volts	Negative Sequence Voltage	V	0...9.999E15
5	Real	200mS_Zero_Seq_Volts	Zero Sequence Voltage	V	0...9.999E15
6	Real	200mS_Pos_Seq_Amps	Positive Sequence Amps	A	0...9.999E15
7	Real	200mS_Neg_Seq_Amps	Negative Sequence Amps	A	0...9.999E15
8	Real	200mS_Zero_Seq_Amps	Zero Sequence Amps	A	0...9.999E15
9	Real	200mS_Voltage_Unbalance_%	Voltage percent unbalance	%	0.00...100.00
10	Real	200mS_Current_Unbalance_%	Current percent unbalance	%	0.00...100.00
11	Real	200mS_Sag_Swell_Status_Flag	A flag indicating 200 ms result has been calculated during a Sag, Swell, or Interruption.	%	0...1
12	Real	200mS_Metering_Iteration	A number 0...9,999,999 that indicates that the metering functions and internal communications are updating.	%	0...9,999,999

**PowerQuality.EN61000\_4\_30\_Aggregation (M8 only)****Table 192 - Table Properties**

<b>CIP Instance Number</b>	883
<b>PCCC File Number</b>	F92
<b>No. of Elements</b>	46
<b>Length in Words</b>	92
<b>Data Type</b>	Real
<b>Data Access</b>	Read only
<b>Applies to</b>	M8 only

**Table 193 - PowerQuality.EN61000\_4\_30\_Aggregation Data Table**

<b>Element Number</b>	<b>Type</b>	<b>Tag Name</b>	<b>Description</b>	<b>Units</b>	<b>Range</b>
0	Real	3s_Metering_Date_Stamp	Date of interval collection MM:DD:YY	MMDDYY	0...123199
1	Real	3s_Metering_Time_Stamp	Time of interval collection HH:MM:SS	hhmmss	0...235959
2	Real	3s_Metering_uSecond_Stamp	Microsecond of interval collection	uS	0.000...999999
3	Real	10m_Metering_Date_Stamp	Date of interval collection MM:DD:YY	MMDDYY	0...123199
4	Real	10m_Metering_Time_Stamp	Time of interval collection HH:MM:SS	hhmmss	0...235959
5	Real	10m_Metering_uSecond_Stamp	Microsecond of interval collection	uS	0.000...999999
6	Real	2h_Metering_Date_Stamp	Date of interval collection MM:DD:YY	MMDDYY	0...123199
7	Real	2h_Metering_Time_Stamp	Time of interval collection HH:MM:SS	hhmmss	0...235959
8	Real	2h_Metering_uSecond_Stamp	Microsecond of interval collection	uS	0.000...999999
9	Real	10s_Power_Frequency	10 second frequency update	Hz	40.00...70.00
10	Real	3s_V1_N_Magnitude	Aggregated 3 second result	V	0...9.999E15
11	Real	10m_V1_N_Magnitude	Aggregated 10 minute result	V	0...9.999E15
12	Real	2h_V1_N_Magnitude	Aggregated 2 hour result	V	0...9.999E15
13	Real	3s_V2_N_Magnitude	Aggregated 3 second result	V	0...9.999E15
14	Real	10m_V2_N_Magnitude	Aggregated 10 minute result	V	0...9.999E15
15	Real	2h_V2_N_Magnitude	Aggregated 2 hour result	V	0...9.999E15
16	Real	3s_V3_N_Magnitude	Aggregated 3 second result	V	0...9.999E15
17	Real	10m_V3_N_Magnitude	Aggregated 10 minute result	V	0...9.999E15
18	Real	2h_V3_N_Magnitude	Aggregated 2 hour result	V	0...9.999E15
19	Real	3s_VN_G_Magnitude	Aggregated 3 second result	V	0...9.999E15
20	Real	10m_VN_G_Magnitude	Aggregated 10 minute result	V	0...9.999E15
21	Real	2h_VN_G_Magnitude	Aggregated 2 hour result	V	0...9.999E15
22	Real	3s_V1_V2_Magnitude	Aggregated 3 second result	V	0...9.999E15
23	Real	10m_V1_V2_Magnitude	Aggregated 10 minute result	V	0...9.999E15
24	Real	2h_V1_V2_Magnitude	Aggregated 2 hour result	V	0...9.999E15
25	Real	3s_V2_V3_Magnitude	Aggregated 3 second result	V	0...9.999E15
26	Real	10m_V2_V3_Magnitude	Aggregated 10 minute result	V	0...9.999E15
27	Real	2h_V2_V3_Magnitude	Aggregated 2 hour result	V	0...9.999E15

**Table 193 - PowerQuality.EN61000\_4\_30\_Aggregation Data Table (continued)**

Element Number	Type	Tag Name	Description	Units	Range
28	Real	3s_V3_V1_Magnitude	Aggregated 3 second result	V	0...9.999E15
29	Real	10m_V3_V1_Magnitude	Aggregated 10 minute result	V	0...9.999E15
30	Real	2h_V3_V1_Magnitude	Aggregated 2 hour result	V	0...9.999E15
31	Real	CH1_Short_Term_Flicker_Pst	Flicker short term result	Pst	0.00...100.00
32	Real	CH1_Long_Term_Flicker_Plt	Flicker long term result	Plt	0.00...100.00
33	Real	CH2_Short_Term_Flicker_Pst	Flicker short term result	Pst	0.00...100.00
34	Real	CH2_Long_Term_Flicker_Plt	Flicker long term result	Plt	0.00...100.00
35	Real	CH3_Short_Term_Flicker_Pst	Flicker short term result	Pst	0.00...100.00
36	Real	CH3_Long_Term_Flicker_Plt	Flicker long term result	Plt	0.00...100.00
37	Real	CH1_Mains_Signaling_Voltage	3 second aggregation used for EN50160	V	0...9.999E15
38	Real	CH2_Mains_Signaling_Voltage	3 second aggregation used for EN50160	V	0...9.999E15
39	Real	CH3_Mains_Signaling_Voltage	3 second aggregation used for EN50160	V	0...9.999E15
40	Real	3s_Voltage_Unbalance	Aggregated 3 second result	%	0.00...100.00
41	Real	10m_Voltage_Unbalance	Aggregated 10 minute result	%	0.00...100.00
42	Real	2h_Voltage_Unbalance	Aggregated 2 hour result	%	0.00...100.00
43	Real	3s_Sag_Swell_Status_Flag	A flag indicating the 3s result has been calculated during a Sag, Swell, or Interruption.	#	0...1
44	Real	10m_Sag_Swell_Status_Flag	A flag indicating the 10min result has been calculated during a Sag, Swell, or Interruption.	#	0...1
45	Real	2h_Sag_Swell_Status_Flag	A flag indicating the 2hr result has been calculated during a Sag, Swell, or Interruption.	#	0...1



**PowerQuality.EN50160\_Combpliance\_Results (M8 only)****Table 194 - Table Properties**

<b>CIP Instance Number</b>	884
<b>PCCC File Number</b>	F93
<b>No. of Elements</b>	40
<b>Length in Words</b>	80
<b>Data Type</b>	Real
<b>Data Access</b>	Read only
<b>Applies to</b>	M8 only

**Table 195 - PowerQuality.EN50160\_Combpliance\_Results Data Table**

<b>Element Number</b>	<b>Type</b>	<b>Tag Name</b>	<b>Description</b>	<b>Units</b>	<b>Range</b>
0	Real	Mains Signaling Voltage	(Not logged and updated once per day.) 3 Sec. Interval, this parameter is the percentage of compliance for the day calculated from the 3 second aggregation values during the day	%	0.00...100.00
1	Real	Supply Voltage Range 1	Aggregated result from weekly log	%	0.00...100.00
2	Real	Supply Voltage Range 2	Aggregated result from weekly log	%	0.00...100.00
3	Real	Flicker Severity Plt	Aggregated result from weekly log	Plt	0.00...100.00
4	Real	Supply Voltage Unbalance	Aggregated result from weekly log	%	0.00...100.00
5	Real	Individual Harmonic Voltage	Aggregated result from weekly log	%	0.00...100.00
6	Real	Voltage THD	Aggregated result from weekly log	%	0.00...100.00
7	Real	Power Frequency Range 1	Synchronous is yearly aggregation, Non-synchronous is weekly aggregation	%	0.00...100.00
8	Real	Power Frequency Range 2	Synchronous is yearly aggregation, Non-synchronous is weekly aggregation	%	0.00...100.00
9	Real	Sag 90%u to 80%u,10mS to 200mS Duration	Number of sag incidence in the assigned cell. Aggregated result from yearly log.	#	0...9,999,999
10	Real	Sag 90%u to 80%u,200mS to 500mS Duration	Number of sag incidence in the assigned cell. Aggregated result from yearly log.	#	0...9,999,999
11	Real	Sag 90%u to 80%u,500mS to 1000mS Duration	Number of sag incidence in the assigned cell. Aggregated result from yearly log.	#	0...9,999,999
12	Real	Sag 90%u to 80%u,1000mS to 5000mS Duration	Number of sag incidence in the assigned cell. Aggregated result from yearly log.	#	0...9,999,999
13	Real	Sag 90%u to 80%u,5000mS to 60000mS Duration	Number of sag incidence in the assigned cell. Aggregated result from yearly log.	#	0...9,999,999
14	Real	Sag 80%u to 70%u,10mS to 200mS Duration	Number of sag incidence in the assigned cell. Aggregated result from yearly log.	#	0...9,999,999
15	Real	Sag 80%u to 70%u,200mS to 500mS Duration	Number of sag incidence in the assigned cell. Aggregated result from yearly log.	#	0...9,999,999
16	Real	Sag 80%u to 70%u,500mS to 1000mS Duration	Number of sag incidence in the assigned cell. Aggregated result from yearly log.	#	0...9,999,999
17	Real	Sag 80%u to 70%u,1000mS to 5000mS Duration	Number of sag incidence in the assigned cell. Aggregated result from yearly log.	#	0...9,999,999
18	Real	Sag 80%u to 70%u,5000mS to 60000mS Duration	Number of sag incidence in the assigned cell. Aggregated result from yearly log.	#	0...9,999,999

**Table 195 - PowerQuality.EN50160\_Combpliance\_Results Data Table (continued)**

Element Number	Type	Tag Name	Description	Units	Range
19	Real	Sag 70%u to 40%u,10mS to 200mS Duration	Number of sag incidence in the assigned cell. Aggregated result from yearly log.	#	0...9,999,999
20	Real	Sag 70%u to 40%u,200mS to 500mS Duration	Number of sag incidence in the assigned cell. Aggregated result from yearly log.	#	0...9,999,999
21	Real	Sag 70%u to 40%u,500mS to 1000mS Duration	Number of sag incidence in the assigned cell. Aggregated result from yearly log.	#	0...9,999,999
22	Real	Sag 70%u to 40%u,1000mS to 5000mS Duration	Number of sag incidence in the assigned cell. Aggregated result from yearly log.	#	0...9,999,999
23	Real	Sag 70%u to 40%u,5000mS to 60000mS Duration	Number of sag incidence in the assigned cell. Aggregated result from yearly log.	#	0...9,999,999
24	Real	Sag 40%u to 5%u,10mS to 200mS Duration	Number of sag incidence in the assigned cell. Aggregated result from yearly log.	#	0...9,999,999
25	Real	Sag 40%u to 5%u,200mS to 500mS Duration	Number of sag incidence in the assigned cell. Aggregated result from yearly log.	#	0...9,999,999
26	Real	Sag 40%u to 5%u,500mS to 1000mS Duration	Number of sag incidence in the assigned cell. Aggregated result from yearly log.	#	0...9,999,999
27	Real	Sag 40%u to 5%u,1000mS to 5000mS Duration	Number of sag incidence in the assigned cell. Aggregated result from yearly log.	#	0...9,999,999
28	Real	Sag 40%u to 5%u,5000mS to 60000mS Duration	Number of sag incidence in the assigned cell. Aggregated result from yearly log.	#	0...9,999,999
29	Real	Sag less than 5%u,10mS to 200mS Duration	Number of sag incidence in the assigned cell. Aggregated result from yearly log.	#	0...9,999,999
30	Real	Sag less than 5%u,200mS to 500mS Duration	Number of sag incidence in the assigned cell. Aggregated result from yearly log.	#	0...9,999,999
31	Real	Sag less than 5%u,500mS to 1000mS Duration	Number of sag incidence in the assigned cell. Aggregated result from yearly log.	#	0...9,999,999
32	Real	Sag less than 5%u,1000mS to 5000mS Duration	Number of sag incidence in the assigned cell. Aggregated result from yearly log.	#	0...9,999,999
33	Real	Sag less than 5%u,5000mS to 60000mS Duration	Number of sag incidence in the assigned cell. Aggregated result from yearly log.	#	0...9,999,999
34	Real	Swell 120%u or greater, 10mS to 500mS Duration	Number of swell incidence in the assigned cell. Aggregated result from yearly log.	#	0...9,999,999
35	Real	Swell 120%u or greater, 500mS to 5000mS Duration	Number of swell incidence in the assigned cell. Aggregated result from yearly log.	#	0...9,999,999
36	Real	Swell 120%u or greater, 5000mS to 60000mS Duration	Number of swell incidence in the assigned cell. Aggregated result from yearly log.	#	0...9,999,999
37	Real	Swell 120%u to 110%u, 10mS to 500mS Duration	Number of swell incidence in the assigned cell. Aggregated result from yearly log.	#	0...9,999,999
38	Real	Swell 120%u to 110%u, 500mS to 5000mS Duration	Number of swell incidence in the assigned cell. Aggregated result from yearly log.	#	0...9,999,999
39	Real	Swell 120%u to 110%u, 5000mS to 60000mS Duration	Number of swell incidence in the assigned cell. Aggregated result from yearly log.	#	0...9,999,999

**PowerQuality.Harmonics\_Results (M6 and M8 model)****Table 196 - Table Properties**

<b>CIP Instance Number</b>	860
<b>PCCC File Number</b>	F69
<b>No. of Elements</b>	37
<b>Length in Words</b>	74
<b>Data Type</b>	Real
<b>Data Access</b>	Read Only

**Table 197 - PowerQuality.Harmonics\_Results Data Table**

<b>Element Number</b>	<b>Type</b>	<b>Tag Name</b>	<b>Description</b>	<b>Units</b>	<b>Range</b>
0	Real	Metering_Date_Stamp	Date of cycle collection MM:DD:YY	MMDDYY	0...123199
1	Real	Metering_Time_Stamp	Time of cycle collection hhmmss	hhmmss	0...235959
2	Real	Metering_Microsecond_Stamp	Microsecond of cycle collection	uS	0.000...999,999
3	Real	Channel_Parameter	Indicates the channel selected in the most recent write of Table Configuration.Harmonics_Optional_Read 0 = No Selection 1 = V1-N RMS 2 = V2-N RMS 3 = V3-N RMS 4 = VN-G RMS 5 = V1-V2 RMS 6 = V2-V3 RMS 7 = V3-V1 RMS 8 = I1 RMS 9 = I2 RMS 10 = I3 RMS 11 = I4 RMS 12 = L1 kW RMS 13 = L2 kW RMS 14 = L3 kW RMS 15 = L1 kVAR RMS 16 = L2 kVAR RMS 17 = L3 kVAR RMS 18 = L1 kVA RMS 19 = L2 kVA RMS 20 = L3 kVA RMS 21 = Total kW RMS 22 = Total kVAR RMS 23 = Total kVA RMS 24 = V1-N Angle 25 = V2-N Angle 26 = V3-N Angle 27 = VN-G Angle 28 = V1-V2 Angle 29 = V2-V3 Angle 30 = V3-V1 Angle 31 = I1 Angle 32 = I2 Angle 33 = I3 Angle 34 = I4 Angle		1...34
4	Real	Order	Selected harmonics order range. 0 = DC...31st 1 = 32nd...63rd 2 = 64th...95th 3 = 96th...127th		0...1 (M6) 0...3 (M8)

**Table 197 - PowerQuality.Harmonics\_Results Data Table (continued)**

Element Number	Type	Tag Name	Description	Units	Range
5	Real	X_(0 + Order * 32)	The returned value X_(h) (RMS magnitude or angle) for the spectral component specified by Channel at harmonic h	V, A, kW, kVAR, kVA, or degrees, depending on value of Channel	-9.999E15...9.999E15
6	Real	X_(1 + Order * 32)			-9.999E15...9.999E15
7	Real	X_(2 + Order * 32)			-9.999E15...9.999E15
8	Real	X_(3 + Order * 32)			-9.999E15...9.999E15
9	Real	X_(4 + Order * 32)			-9.999E15...9.999E15
10	Real	X_(5 + Order * 32)			-9.999E15...9.999E15
11	Real	X_(6 + Order * 32)			-9.999E15...9.999E15
12	Real	X_(7 + Order * 32)			-9.999E15...9.999E15
13	Real	X_(8 + Order * 32)			-9.999E15...9.999E15
14	Real	X_(9 + Order * 32)			-9.999E15...9.999E15
15	Real	X_(10 + Order * 32)			-9.999E15...9.999E15
16	Real	X_(11 + Order * 32)			-9.999E15...9.999E15
17	Real	X_(12 + Order * 32)			-9.999E15...9.999E15
18	Real	X_(13 + Order * 32)			-9.999E15...9.999E15
19	Real	X_(14 + Order * 32)			-9.999E15...9.999E15
20	Real	X_(15 + Order * 32)			-9.999E15...9.999E15
21	Real	X_(16 + Order * 32)			-9.999E15...9.999E15
22	Real	X_(17 + Order * 32)			-9.999E15...9.999E15
23	Real	X_(18 + Order * 32)			-9.999E15...9.999E15
24	Real	X_(19 + Order * 32)			-9.999E15...9.999E15
25	Real	X_(20 + Order * 32)			-9.999E15...9.999E15
26	Real	X_(21 + Order * 32)			-9.999E15...9.999E15
27	Real	X_(22 + Order * 32)			-9.999E15...9.999E15
28	Real	X_(23 + Order * 32)			-9.999E15...9.999E15
29	Real	X_(24 + Order * 32)			-9.999E15...9.999E15
30	Real	X_(25 + Order * 32)			-9.999E15...9.999E15
31	Real	X_(26 + Order * 32)			-9.999E15...9.999E15
32	Real	X_(27 + Order * 32)			-9.999E15...9.999E15
33	Real	X_(28 + Order * 32)			-9.999E15...9.999E15
34	Real	X_(29 + Order * 32)			-9.999E15...9.999E15
35	Real	X_(30 + Order * 32)			-9.999E15...9.999E15
36	Real	X_(31 + Order * 32)			-9.999E15...9.999E15

## PowerQuality.IEEE1159\_Results (M6 and M8 model)

**Table 198 - Table Properties**

<b>CIP Instance Number</b>	863
<b>PCCC File Number</b>	F72
<b>No. of Elements</b>	26
<b>Length in Words</b>	52
<b>Data Type</b>	Real
<b>Data Access</b>	Read Only

**Table 199 - PowerQuality.IEEE1159\_Results Data Table**

Element Number	Type	Tag Name	Description	Units	Range
0	Real	Metering_Date_Stamp	Date of cycle collection MMDDYY	MMDDYY	0...123199
1	Real	Metering_Time_Stamp	Time of cycle collection hhmmss	hhmmss	0...235959
2	Real	Metering Microsecond Stamp	Microsecond of cycle collection	uS	0.000...999,999
3	Real	IEEE1159_Volts_Imbalance_%	The rolling average for IEEE1159 voltage imbalance	%	0.0...100.00
4	Real	IEEE1159_Current_Imbalance_%	The rolling average for IEEE1159 current imbalance	%	0.0...100.00
5	Real	IEEE1159_Power_Frequency_Hz	The rolling variation from nominal frequency setting.	Hz	0.0...70.00
6	Real	IEEE1159_V1_DC_Offset_%	The rolling average for V1 voltage dc offset	%	0.0...100.00
7	Real	IEEE1159_V2_DC_Offset_%	The rolling average for V2 voltage dc offset	%	0.0...100.00
8	Real	IEEE1159_V3_DC_Offset_%	The rolling average for V3 voltage dc offset	%	0.0...100.00
9	Real	IEEE1159_V1_THD_%	The rolling average for V1 Voltage THD	%	0.0...100.00
10	Real	IEEE1159_V2_THD_%	The rolling average for V2 Voltage THD	%	0.0...100.00
11	Real	IEEE1159_V3_THD_%	The rolling average for V3 Voltage THD	%	0.0...100.00
12	Real	IEEE1159_I1_THD_%	The rolling average for I1 Current THD	%	0.0...100.00
13	Real	IEEE1159_I2_THD_%	The rolling average for I2 Current THD	%	0.0...100.00
14	Real	IEEE1159_I3_THD_%	The rolling average for I3 Current THD	%	0.0...100.00
15	Real	IEEE1159_I4_THD_%	The rolling average for I4 Current THD	%	0.0...100.00
16	Real	IEEE1159_V1_TID_%	The rolling average for V1 Interharmonic Voltage TID	%	0.0...100.00 (M8 Only)
17	Real	IEEE1159_V2_TID_%	The rolling average for V2 Interharmonic Voltage TID	%	0.0...100.00 (M8 Only)
18	Real	IEEE1159_V3_TID_%	The rolling average for V3 Interharmonic Voltage TID	%	0.0...100.00 (M8 Only)
19	Real	IEEE1159_I1_TID_%	The rolling average for I1 Interharmonic Current TID	%	0.0...100.00 (M8 Only)
20	Real	IEEE1159_I2_TID_%	The rolling average for I2 Interharmonic Current TID	%	0.0...100.00 (M8 Only)
21	Real	IEEE1159_I3_TID_%	The rolling average for I3 Interharmonic Current TID	%	0.0...100.00 (M8 Only)
22	Real	IEEE1159_I4_TID_%	The rolling average for I4 Interharmonic Current TID	%	0.0...100.00 (M8 Only)

**Table 199 - PowerQuality.IEEE1159\_Results Data Table (continued)**

Element Number	Type	Tag Name	Description	Units	Range
23	Real	IEEE1159_V1_Fluctuation_Pst	The index value for V1 short term duration flicker.	Pst	0.0...100.00 (M8 Only)
24	Real	IEEE1159_V2_Fluctuation_Pst	The index value for V2 short term duration flicker.	Pst	0.0...100.00 (M8 Only)
25	Real	IEEE1159_V3_Fluctuation_Pst	The index value for V3 short term duration flicker.	Pst	0.0...100.00 (M8 Only)

## PowerQuality.Synchro\_Phazor\_Results

**Table 200 - Table Properties**

<b>CIP Instance Number</b>	894
<b>PCCC File Number</b>	F103
<b>No. of Elements</b>	26
<b>Length in Words</b>	52
<b>Data Type</b>	Real
<b>Data Access</b>	Read Only

**Table 201 - PowerQuality.Synchro\_Phazor\_Results Data Table**

<b>Element Number</b>	<b>Type</b>	<b>Tag Name</b>	<b>Description</b>	<b>Units</b>	<b>Range</b>
0	Real	Metering_Date_Stamp	Date of cycle collection MMDDYY	MMDDYY	0...123199
1	Real	Metering_Time_Stamp	Time of cycle collection hhmmss	hhmmss	0...235959
2	Real	Metering_Microsecond_Stamp	Microsecond of cycle collection	uS	0.000...999,999
3	Real	Frequency_Hz	Last Line Frequency Calculated.	Hz	40.00...70.00
4	Real	V1_N_Volts_Fundamental_RMS	Volts to neutral fundamental magnitude.	V	0...9.999E15
5	Real	V1_N_Volts_Fundamental_Ang	Volts to neutral fundamental angle.	Degrees	0...9.999E15
6	Real	V2_N_Volts_Fundamental_RMS	Volts to neutral fundamental magnitude.	V	0...9.999E15
7	Real	V2_N_Volts_Fundamental_Ang	Volts to neutral fundamental angle.	Degrees	0...9.999E15
8	Real	V3_N_Volts_Fundamental_RMS	Volts to neutral fundamental magnitude.	V	0...9.999E15
9	Real	V3_N_Volts_Fundamental_Ang	Volts to neutral fundamental angle.	Degrees	0...9.999E15
10	Real	VN_G_Volts_Fundamental_RMS	VN to G fundamental magnitude.	V	0...9.999E15
11	Real	VN_G_Volts_Fundamental_Ang	VN to G fundamental angle.	Degrees	0...9.999E15
12	Real	V1_V2_Volts_Fundamental_RMS	Line to Line fundamental magnitude.	V	0...9.999E15
13	Real	V1_V2_Volts_Fundamental_Ang	Line to Line fundamental angle.	Degrees	0...9.999E15
14	Real	V2_V3_Volts_Fundamental_RMS	Line to Line fundamental magnitude.	V	0...9.999E15
15	Real	V2_V3_Volts_Fundamental_Ang	Line to Line fundamental angle.	Degrees	0...9.999E15
16	Real	V3_V1_Volts_Fundamental_RMS	Line to Line fundamental magnitude.	V	0...9.999E15
17	Real	V3_V1_Volts_Fundamental_Ang	Line to Line fundamental angle.	Degrees	0...9.999E15
18	Real	I1_Amps_Fundamental_RMS	I1 current fundamental magnitude.	A	0...9.999E15
19	Real	I1_Amps_Fundamental_Ang	I1 current fundamental angle.	Degrees	0...9.999E15
20	Real	I2_Amps_Fundamental_RMS	I2 current fundamental magnitude.	A	0...9.999E15
21	Real	I2_Amps_Fundamental_Ang	I2 current fundamental angle.	Degrees	0...9.999E15
22	Real	I3_Amps_Fundamental_RMS	I3 current fundamental magnitude.	A	0...9.999E15
23	Real	I3_Amps_Fundamental_Ang	I3 current fundamental angle.	Degrees	0...9.999E15
24	Real	I4_Amps_Fundamental_RMS	I4 current fundamental magnitude.	A	0...9.999E15
25	Real	I4_Amps_Fundamental_Ang	I4 current fundamental angle.	Degrees	0...9.999E15

## PowerQuality.IEEE519\_ Results (M6 and M8 model)

The PowerMonitor 5000 M6 and M8 models return short- and long-term rolling average harmonic distortion data for the fundamental and the first 40 harmonic frequencies. These results are presented in six similar data tables.

**Table 202 - Table Properties**

Data Table Name	CIP Instance Number	PCCC File No.
PowerQuality.IEEE519_CH1_ShortTerm_Results	895	F104
PowerQuality.IEEE519_CH2_ShortTerm_Results	896	F105
PowerQuality.IEEE519_CH3_ShortTerm_Results	897	F106
PowerQuality.IEEE519_CH1_LongTerm_Results	898	F107
PowerQuality.IEEE519_CH2_LongTerm_Results	899	F108
PowerQuality.IEEE519_CH3_LongTerm_Results	900	F109

These tables share the following properties.

<b>No. of Elements</b>	44
<b>Length in Words</b>	88
<b>Data Type</b>	Real
<b>Data Access</b>	Read Only

---

**IMPORTANT** Channel assignments are based on the value of the tag IEEE519\_Compliance\_Parameter found in the [Configuration.PowerQuality](#) table.

---

IEEE519_Compliance_Parameter	Channel 1	Channel 2	Channel 3
0 = Current	I1	I2	I3
1 = Voltage (Wye, Split Phase, and Single Phase)	V1-N	V2-N	V3-N
1 = Voltage (Delta)	V1-V2	V2-V3	V3-V1

The IEEE519 Results data tables share a common structure. In the data table template shown, substitute the following into the Data Table Name and Tag Name strings to obtain the specific names:

- For '<CH>', substitute 'CH1', 'CH2', or 'CH3'.
- For '<Term>', substitute 'ShortTerm' or 'LongTerm'.

For example, the tag CH3\_5th\_Harmonic\_IEEE519\_ShortTerm in the PowerQuality.IEEE519\_CH3\_ShortTerm\_Results table returns the short-term 5th harmonic value for Channel 3.



**Table 203 - PowerQuality.IEEE519 Results Data Table Template**

Element Number	Type	Tag Name	Description	Units	Range
0	Real	Metering_Date_Stamp	Date of cycle collection MMDDYY	MMDDYY	0...123199
1	Real	Metering_Time_Stamp	Time of cycle collection hhmmss	hhmmss	0...235959
2	Real	Metering_Microsecond_Stamp	Microsecond of cycle collection	uS	0.000...999,999
3	Real	<CH>_Fundamental_IEEE519_<Term>_RMS	The fundamental RMS magnitude.	Volts or Amps RMS	0...9.999E15
4	Real	<CH>_2nd_Harmonic_IEEE519_<Term>_%	Percent of Fundamental or Maximum Demand Current	%	0.000...100.000
5	Real	<CH>_3rd_Harmonic_IEEE519_<Term>_%			
6	Real	<CH>_4th_Harmonic_IEEE519_<Term>_%			
7	Real	<CH>_5th_Harmonic_IEEE519_<Term>_%			
8	Real	<CH>_6th_Harmonic_IEEE519_<Term>_%			
9	Real	<CH>_7th_Harmonic_IEEE519_<Term>_%			
10	Real	<CH>_8th_Harmonic_IEEE519_<Term>_%			
11	Real	<CH>_9th_Harmonic_IEEE519_<Term>_%			
12	Real	<CH>_10th_Harmonic_IEEE519_<Term>_%			
13	Real	<CH>_11th_Harmonic_IEEE519_<Term>_%			
14	Real	<CH>_12th_Harmonic_IEEE519_<Term>_%			
15	Real	<CH>_13th_Harmonic_IEEE519_<Term>_%			
16	Real	<CH>_14th_Harmonic_IEEE519_<Term>_%			
17	Real	<CH>_15th_Harmonic_IEEE519_<Term>_%			
18	Real	<CH>_16th_Harmonic_IEEE519_<Term>_%			
19	Real	<CH>_17th_Harmonic_IEEE519_<Term>_%			
20	Real	<CH>_18th_Harmonic_IEEE519_<Term>_%			
21	Real	<CH>_19th_Harmonic_IEEE519_<Term>_%			
22	Real	<CH>_20th_Harmonic_IEEE519_<Term>_%			
23	Real	<CH>_21st_Harmonic_IEEE519_<Term>_%			
24	Real	<CH>_22nd_Harmonic_IEEE519_<Term>_%			
25	Real	<CH>_23rd_Harmonic_IEEE519_<Term>_%			
26	Real	<CH>_24th_Harmonic_IEEE519_<Term>_%			
27	Real	<CH>_25th_Harmonic_IEEE519_<Term>_%			
28	Real	<CH>_26th_Harmonic_IEEE519_<Term>_%			
29	Real	<CH>_27th_Harmonic_IEEE519_<Term>_%			
30	Real	<CH>_28th_Harmonic_IEEE519_<Term>_%			
31	Real	<CH>_29th_Harmonic_IEEE519_<Term>_%			
32	Real	<CH>_30th_Harmonic_IEEE519_<Term>_%			
33	Real	<CH>_31st_Harmonic_IEEE519_<Term>_%			
34	Real	<CH>_32nd_Harmonic_IEEE519_<Term>_%			
35	Real	<CH>_33rd_Harmonic_IEEE519_<Term>_%			
36	Real	<CH>_34th_Harmonic_IEEE519_<Term>_%			
37	Real	<CH>_35th_Harmonic_IEEE519_<Term>_%			

**Table 203 - PowerQuality.IEEE519 Results Data Table Template (continued)**

Element Number	Type	Tag Name	Description	Units	Range
38	Real	<CH>_36th_Harmonic_IEEE519_<Term>_%	Percent of Fundamental	%	0.000...100.000
39	Real	<CH>_37th_Harmonic_IEEE519_<Term>_%			
40	Real	<CH>_38th_Harmonic_IEEE519_<Term>_%			
41	Real	<CH>_39th_Harmonic_IEEE519_<Term>_%			
42	Real	<CH>_40th_Harmonic_IEEE519_<Term>_%			
43	Real	<CH>_IEEE519_Total_Distortion_<Term>_%	Percent of Fundamental <b>IMPORTANT:</b> Value reported is THD or TDD based on configuration setting of IEEE_519_MAX_Isc and IEEE_519_MAX_IL on the <a href="#">Configuration.PowerQuality</a> table for Current. The value is always THD for Voltage.		

**IMPORTANT** Data Table Name: PowerQuality.IEEE519\_<CH>\_<Term>\_Results

### PowerQuality.Harmonics Results (M6 and M8 model)

These tables share the following properties.

**Table 204 - Table Properties**

<b>No. of Elements</b>	35
<b>Length in Words</b>	70
<b>Data Type</b>	Real
<b>Data Access</b>	Read Only
<b>Applies to</b>	M6 and M8 only

The individual harmonic results are not assigned PCCC file numbers.

The Harmonics Results data tables share a common structure. Four data table templates are shown below, one for DC through the 31st order, the second for the 32nd through the 63rd order, the third for the 64th through the 95th, and the fourth for the 96th through the 127th order. The data table name and tag name structures are:

- Data Table Name:
  - PowerQuality.<CH>\_<Units>\_H1\_<Mag/Angle> (DC...31)
  - PowerQuality.<CH>\_<Units>\_H2\_<Mag/Angle> (32...63)
  - PowerQuality.<CH>\_<Units>\_H3\_<Mag/Angle>(64...95)
  - PowerQuality.<CH>\_<Units>\_H4\_<Mag/Angle>(96...127)
- Tag Name: <CH>\_<Units>\_h#\_H\_<Mag/Angle>

Substitute the following into the Data Table Name and Tag Name strings to obtain the specific names.

**Table 205 - Substitution Table**

<b>For:</b>	<b>Substitute:</b>	<b>To return these harmonic results:</b>
<CH>	Total	Total (3-phase) power
	L1	Line (Phase) 1 power
	L2	Line (Phase) 2 power
	L3	Line (Phase) 3 power
	V1_N	Line 1 to Neutral voltage
	V2_N	Line 2 to Neutral voltage
	V3_N	Line 3 to Neutral voltage
	VN_G	Neutral to Ground voltage
	V1_V2	Line 1 to Line 2 voltage
	V2_V3	Line 2 to Line 3 voltage
	V3_V1	Line 3 to Line 1 voltage
	I1	Line 1 current
	I2	Line 2 current
	I3	Line 3 current
<Units>	kW	Real power
	kVAR	Reactive power
	kVA	Apparent power
	Volts	Voltage
	Amps	Current
<Mag/Angle>	RMS	RMS magnitude
	Ang	Angle referenced to the metering time stamp

For example, the tag I1\_Amps\_h5\_H\_RMS in the PowerQuality.I1\_Amps\_H1\_RMS (DC...31) table returns the RMS magnitude of the 5th harmonic for Line 1 current.

**Table 206 - Harmonics Results Assembly Instance Lookup Table**

PowerQuality. Harmonics Results	Results table assembly instance ID:							
	DC...31st Magnitude	32nd...63rd Magnitude	64th...95th Magnitude	96th...127th Magnitude	DC...31st Angle	32nd...63rd Angle	64th...95th Angle	96th...127th Angle
Total (3-phase) real power, kW	1001	1002	1003	1004	n/a	n/a	n/a	n/a
Total (3-phase) reactive power, kVAR	1005	1006	1007	1008				
Total (3-phase) apparent power, kVA	1009	1010	1011	1012				
Line 1 (Phase) real power, kW	1057	1058	1059	1060				
Line 1 (Phase) reactive power, kVAR	1069	1070	1071	1072				
Line 1 (Phase) apparent power, kVA	1081	1082	1083	1084				
Line 2 (Phase) real power, kW	1061	1062	1063	1064				
Line 2 (Phase) reactive power, kVAR	1073	1074	1075	1076				
Line 2 (Phase) apparent power, kVA	1085	1086	1087	1088				
Line 3 (Phase) real power, kW	1065	1066	1067	1068				
Line 3 (Phase) reactive power, kVAR	1077	1078	1079	1080				
Line 3 (Phase) apparent power, kVA	1089	1090	1091	1092				
Line 1 to Neutral voltage	1013	1014	1015	1016				
Line 2 to Neutral voltage	1017	1018	1019	1020	1097	1098	1099	1100
Line 3 to Neutral voltage	1021	1022	1023	1024	1101	1102	1103	1104
Neutral to Ground voltage	1025	1026	1027	1028	1105	1106	1107	1108
Line 1 to Line 2 voltage	1029	1030	1031	1032	1109	1110	1111	1112
Line 2 to Line 3 voltage	1033	1034	1035	1036	1113	1114	1115	1116
Line 3 to Line 1 voltage	1037	1038	1039	1040	1117	1118	1119	1120
Line 1 current	1041	1042	1043	1044	1121	1122	1123	1124
Line 2 current	1045	1046	1047	1048	1125	1126	1127	1128
Line 3 current	1049	1050	1051	1052	1129	1130	1131	1132
Line 4 current	1053	1054	1055	1056	1133	1134	1135	1136

**Table 207 - PowerQuality.Harmonic Results Data Table template, H1 Order Range (DC ...31)**

Element Number	Type	Tag Name	Description	Units	Range
0	Real	Metering_Date_Stamp	Date of cycle collection MMDDYY	MMDDYY	0...123199
1	Real	Metering_Time_Stamp	Time of cycle collection hhmmss	hhmmss	0...235959
2	Real	Metering_Microsecond_Stamp	Microsecond of cycle collection	uS	0.000...999,999
3	Real	<CH>_<Units>_DC_H_<Mag/Angle>	The value of the specified harmonic component: RMS magnitude or Angle	Same as <Units> string in Tag Name: kW kVAR kVA Volts Amps; if Angle, Degrees.	-9.999E15...9.999E15
4	Real	<CH>_<Units>_h1_H_<Mag/Angle>			-9.999E15...9.999E15
5	Real	<CH>_<Units>_h2_H_<Mag/Angle>			-9.999E15...9.999E15
6	Real	<CH>_<Units>_h3_H_<Mag/Angle>			-9.999E15...9.999E15
7	Real	<CH>_<Units>_h4_H_<Mag/Angle>			-9.999E15...9.999E15
8	Real	<CH>_<Units>_h5_H_<Mag/Angle>			-9.999E15...9.999E15
9	Real	<CH>_<Units>_h6_H_<Mag/Angle>			-9.999E15...9.999E15
10	Real	<CH>_<Units>_h7_H_<Mag/Angle>			-9.999E15...9.999E15
11	Real	<CH>_<Units>_h8_H_<Mag/Angle>			-9.999E15...9.999E15
12	Real	<CH>_<Units>_h9_H_<Mag/Angle>			-9.999E15...9.999E15
13	Real	<CH>_<Units>_h10_H_<Mag/Angle>			-9.999E15...9.999E15
14	Real	<CH>_<Units>_h11_H_<Mag/Angle>			-9.999E15...9.999E15
15	Real	<CH>_<Units>_h12_H_<Mag/Angle>			-9.999E15...9.999E15
16	Real	<CH>_<Units>_h13_H_<Mag/Angle>			-9.999E15...9.999E15
17	Real	<CH>_<Units>_h14_H_<Mag/Angle>			-9.999E15...9.999E15
18	Real	<CH>_<Units>_h15_H_<Mag/Angle>			-9.999E15...9.999E15
19	Real	<CH>_<Units>_h16_H_<Mag/Angle>			-9.999E15...9.999E15
20	Real	<CH>_<Units>_h17_H_<Mag/Angle>			-9.999E15...9.999E15
21	Real	<CH>_<Units>_h18_H_<Mag/Angle>			-9.999E15...9.999E15
22	Real	<CH>_<Units>_h19_H_<Mag/Angle>			-9.999E15...9.999E15
23	Real	<CH>_<Units>_h20_H_<Mag/Angle>			-9.999E15...9.999E15
24	Real	<CH>_<Units>_h21_H_<Mag/Angle>			-9.999E15...9.999E15
25	Real	<CH>_<Units>_h22_H_<Mag/Angle>			-9.999E15...9.999E15
26	Real	<CH>_<Units>_h23_H_<Mag/Angle>			-9.999E15...9.999E15
27	Real	<CH>_<Units>_h24_H_<Mag/Angle>			-9.999E15...9.999E15
28	Real	<CH>_<Units>_h25_H_<Mag/Angle>			-9.999E15...9.999E15
29	Real	<CH>_<Units>_h26_H_<Mag/Angle>			-9.999E15...9.999E15
30	Real	<CH>_<Units>_h27_H_<Mag/Angle>			-9.999E15...9.999E15
31	Real	<CH>_<Units>_h28_H_<Mag/Angle>			-9.999E15...9.999E15
32	Real	<CH>_<Units>_h29_H_<Mag/Angle>			-9.999E15...9.999E15
33	Real	<CH>_<Units>_h30_H_<Mag/Angle>			-9.999E15...9.999E15
34	Real	<CH>_<Units>_h31_H_<Mag/Angle>			-9.999E15...9.999E15

**IMPORTANT** Data Table Name: PowerQuality.<CH>\_<Units>\_H1\_<Mag/Angle> (DC...31)

**Table 208 - PowerQuality.Harmonic Results Data Table template, H2 Order Range (32...63)**

Element Number	Type	Tag Name	Description	Units	Range
0	Real	Metering_Date_Stamp	Date of cycle collection MMDDYY	MM:DD:YY	0...123199
1	Real	Metering_Time_Stamp	Time of cycle collection hhmmss	hhmmss	0...235959
2	Real	Metering_Microsecond_Stamp	Microsecond of cycle collection	uS	0.000...999,999
3	Real	<CH>_<Units>_h32_H_<Mag/Angle>	The value of the specified harmonic component: RMS magnitude or Angle	Same as <Units> string in Tag Name: kW kVAR kVA Volts Amps	-9.999E15...9.999E15
4	Real	<CH>_<Units>_h33_H_<Mag/Angle>			-9.999E15...9.999E15
5	Real	<CH>_<Units>_h34_H_<Mag/Angle>			-9.999E15...9.999E15
6	Real	<CH>_<Units>_h35_H_<Mag/Angle>			-9.999E15...9.999E15
7	Real	<CH>_<Units>_h36_H_<Mag/Angle>			-9.999E15...9.999E15
8	Real	<CH>_<Units>_h37_H_<Mag/Angle>			-9.999E15...9.999E15
9	Real	<CH>_<Units>_h38_H_<Mag/Angle>			-9.999E15...9.999E15
10	Real	<CH>_<Units>_h39_H_<Mag/Angle>			-9.999E15...9.999E15
11	Real	<CH>_<Units>_h40_H_<Mag/Angle>			-9.999E15...9.999E15
12	Real	<CH>_<Units>_h41_H_<Mag/Angle>			-9.999E15...9.999E15
13	Real	<CH>_<Units>_h42_H_<Mag/Angle>			-9.999E15...9.999E15
14	Real	<CH>_<Units>_h43_H_<Mag/Angle>			-9.999E15...9.999E15
15	Real	<CH>_<Units>_h44_H_<Mag/Angle>			-9.999E15...9.999E15
16	Real	<CH>_<Units>_h45_H_<Mag/Angle>			-9.999E15...9.999E15
17	Real	<CH>_<Units>_h46_H_<Mag/Angle>			-9.999E15...9.999E15
18	Real	<CH>_<Units>_h47_H_<Mag/Angle>			-9.999E15...9.999E15
19	Real	<CH>_<Units>_h48_H_<Mag/Angle>			-9.999E15...9.999E15
20	Real	<CH>_<Units>_h49_H_<Mag/Angle>			-9.999E15...9.999E15
21	Real	<CH>_<Units>_h50_H_<Mag/Angle>			-9.999E15...9.999E15
22	Real	<CH>_<Units>_h51_H_<Mag/Angle>			-9.999E15...9.999E15
23	Real	<CH>_<Units>_h52_H_<Mag/Angle>			-9.999E15...9.999E15
24	Real	<CH>_<Units>_h53_H_<Mag/Angle>			-9.999E15...9.999E15
25	Real	<CH>_<Units>_h54_H_<Mag/Angle>			-9.999E15...9.999E15
26	Real	<CH>_<Units>_h55_H_<Mag/Angle>			-9.999E15...9.999E15
27	Real	<CH>_<Units>_h56_H_<Mag/Angle>			-9.999E15...9.999E15
28	Real	<CH>_<Units>_h57_H_<Mag/Angle>			-9.999E15...9.999E15
29	Real	<CH>_<Units>_h58_H_<Mag/Angle>			-9.999E15...9.999E15
30	Real	<CH>_<Units>_h59_H_<Mag/Angle>			-9.999E15...9.999E15
31	Real	<CH>_<Units>_h60_H_<Mag/Angle>			-9.999E15...9.999E15
32	Real	<CH>_<Units>_h61_H_<Mag/Angle>			-9.999E15...9.999E15
33	Real	<CH>_<Units>_h62_H_<Mag/Angle>			-9.999E15...9.999E15
34	Real	<CH>_<Units>_h63_H_<Mag/Angle>			-9.999E15...9.999E15

**IMPORTANT** Data Table Name: PowerQuality.<CH>\_<Units>\_H2\_<Mag/Angle> (32...63)

**Table 209 - PowerQuality.Harmonic Results Data Table template, H3 Order Range (64...95) (M8 only)**

Element Number	Type	Tag Name	Description	Units	Range
0	Real	Metering_Date_Stamp	Date of cycle collection MMDDYY	MMDDYY	0...123199
1	Real	Metering_Time_Stamp	Time of cycle collection hhmmss	hhmmss	0...235959
2	Real	Metering_Microsecond_Stamp	Microsecond of cycle collection	uS	0.000...999,999
3	Real	<CH>_<Units>_h64_H_<Mag/Angle>	The value of the specified harmonic component: RMS magnitude or Angle.	Same as <Units> string in Tag Name: kW kVAR kVA Volts Amps	-9.999E15...9.999E15
4	Real	<CH>_<Units>_h65_H_<Mag/Angle>			-9.999E15...9.999E15
5	Real	<CH>_<Units>_h66_H_<Mag/Angle>			-9.999E15...9.999E15
6	Real	<CH>_<Units>_h67_H_<Mag/Angle>			-9.999E15...9.999E15
7	Real	<CH>_<Units>_h68_H_<Mag/Angle>			-9.999E15...9.999E15
8	Real	<CH>_<Units>_h69_H_<Mag/Angle>			-9.999E15...9.999E15
9	Real	<CH>_<Units>_h70_H_<Mag/Angle>			-9.999E15...9.999E15
10	Real	<CH>_<Units>_h71_H_<Mag/Angle>			-9.999E15...9.999E15
11	Real	<CH>_<Units>_h72_H_<Mag/Angle>			-9.999E15...9.999E15
12	Real	<CH>_<Units>_h73_H_<Mag/Angle>			-9.999E15...9.999E15
13	Real	<CH>_<Units>_h74_H_<Mag/Angle>			-9.999E15...9.999E15
14	Real	<CH>_<Units>_h75_H_<Mag/Angle>			-9.999E15...9.999E15
15	Real	<CH>_<Units>_h76_H_<Mag/Angle>			-9.999E15...9.999E15
16	Real	<CH>_<Units>_h77_H_<Mag/Angle>			-9.999E15...9.999E15
17	Real	<CH>_<Units>_h78_H_<Mag/Angle>			-9.999E15...9.999E15
18	Real	<CH>_<Units>_h79_H_<Mag/Angle>			-9.999E15...9.999E15
19	Real	<CH>_<Units>_h80_H_<Mag/Angle>			-9.999E15...9.999E15
20	Real	<CH>_<Units>_h81_H_<Mag/Angle>			-9.999E15...9.999E15
21	Real	<CH>_<Units>_h82_H_<Mag/Angle>			-9.999E15...9.999E15
22	Real	<CH>_<Units>_h83_H_<Mag/Angle>			-9.999E15...9.999E15
23	Real	<CH>_<Units>_h84_H_<Mag/Angle>			-9.999E15...9.999E15
24	Real	<CH>_<Units>_h85_H_<Mag/Angle>			-9.999E15...9.999E15
25	Real	<CH>_<Units>_h86_H_<Mag/Angle>			-9.999E15...9.999E15
26	Real	<CH>_<Units>_h87_H_<Mag/Angle>			-9.999E15...9.999E15
27	Real	<CH>_<Units>_h88_H_<Mag/Angle>			-9.999E15...9.999E15
28	Real	<CH>_<Units>_h89_H_<Mag/Angle>			-9.999E15...9.999E15
29	Real	<CH>_<Units>_h90_H_<Mag/Angle>			-9.999E15...9.999E15
30	Real	<CH>_<Units>_h91_H_<Mag/Angle>			-9.999E15...9.999E15
31	Real	<CH>_<Units>_h92_H_<Mag/Angle>			-9.999E15...9.999E15
32	Real	<CH>_<Units>_h93_H_<Mag/Angle>			-9.999E15...9.999E15
33	Real	<CH>_<Units>_h94_H_<Mag/Angle>			-9.999E15...9.999E15
34	Real	<CH>_<Units>_h95_H_<Mag/Angle>			-9.999E15...9.999E15

**Table 210 - PowerQuality.Harmonic Results Data Table template, H4 order range (96...127) (M8 only)**

Element Number	Type	Tag Name	Description	Units	Range
0	Real	Metering_Date_Stamp	Date of cycle collection MMDDYY	MMDDYY	0...123199
1	Real	Metering_Time_Stamp	Time of cycle collection hhmss	hhmss	0...235959
2	Real	Metering_Microsecond_Stamp	Microsecond of cycle collection	uS	0.000...999,999
3	Real	<CH>_<Units>_h96_H_<Mag/Angle>	The value of the specified harmonic component: RMS magnitude or Angle	Same as <Units> string in Tag Name: kW kVAR kVA Volts Amps	-9.999E15...9.999E15
4	Real	<CH>_<Units>_h97_H_<Mag/Angle>			-9.999E15...9.999E15
5	Real	<CH>_<Units>_h98_H_<Mag/Angle>			-9.999E15...9.999E15
6	Real	<CH>_<Units>_h99_H_<Mag/Angle>			-9.999E15...9.999E15
7	Real	<CH>_<Units>_h100_H_<Mag/Angle>			-9.999E15...9.999E15
8	Real	<CH>_<Units>_h101_H_<Mag/Angle>			-9.999E15...9.999E15
9	Real	<CH>_<Units>_h102_H_<Mag/Angle>			-9.999E15...9.999E15
10	Real	<CH>_<Units>_h103_H_<Mag/Angle>			-9.999E15...9.999E15
11	Real	<CH>_<Units>_h104_H_<Mag/Angle>			-9.999E15...9.999E15
12	Real	<CH>_<Units>_h105_H_<Mag/Angle>			-9.999E15...9.999E15
13	Real	<CH>_<Units>_h106_H_<Mag/Angle>			-9.999E15...9.999E15
14	Real	<CH>_<Units>_h107_H_<Mag/Angle>			-9.999E15...9.999E15
15	Real	<CH>_<Units>_h108_H_<Mag/Angle>			-9.999E15...9.999E15
16	Real	<CH>_<Units>_h109_H_<Mag/Angle>			-9.999E15...9.999E15
17	Real	<CH>_<Units>_h110_H_<Mag/Angle>			-9.999E15...9.999E15
18	Real	<CH>_<Units>_h111_H_<Mag/Angle>			-9.999E15...9.999E15
19	Real	<CH>_<Units>_h112_H_<Mag/Angle>			-9.999E15...9.999E15
20	Real	<CH>_<Units>_h113_H_<Mag/Angle>			-9.999E15...9.999E15
21	Real	<CH>_<Units>_h114_H_<Mag/Angle>			-9.999E15...9.999E15
22	Real	<CH>_<Units>_h115_H_<Mag/Angle>			-9.999E15...9.999E15
23	Real	<CH>_<Units>_h116_H_<Mag/Angle>			-9.999E15...9.999E15
24	Real	<CH>_<Units>_h117_H_<Mag/Angle>			-9.999E15...9.999E15
25	Real	<CH>_<Units>_h118_H_<Mag/Angle>			-9.999E15...9.999E15
26	Real	<CH>_<Units>_h119_H_<Mag/Angle>			-9.999E15...9.999E15
27	Real	<CH>_<Units>_h120_H_<Mag/Angle>			-9.999E15...9.999E15
28	Real	<CH>_<Units>_h121_H_<Mag/Angle>			-9.999E15...9.999E15
29	Real	<CH>_<Units>_h122_H_<Mag/Angle>			-9.999E15...9.999E15
30	Real	<CH>_<Units>_h123_H_<Mag/Angle>			-9.999E15...9.999E15
31	Real	<CH>_<Units>_h124_H_<Mag/Angle>			-9.999E15...9.999E15
32	Real	<CH>_<Units>_h125_H_<Mag/Angle>			-9.999E15...9.999E15
33	Real	<CH>_<Units>_h126_H_<Mag/Angle>			-9.999E15...9.999E15
34	Real	<CH>_<Units>_h127_H_<Mag/Angle>			-9.999E15...9.999E15



## PowerQuality.EN61000\_4\_30 Harmonic and Interharmonic Group Results (M8 only)

These tables share the following properties.

**Table 211 - Table Properties**

<b>No. of Elements</b>	54
<b>Length in Words</b>	108
<b>Data Type</b>	Real
<b>Data Access</b>	Read only
<b>Applies to</b>	M8 only

The EN61000-4-30 Harmonic and Interharmonic Results data tables share a common structure.

- Data Table Name:  
PowerQuality.<Interval>\_<CH>\_<Units>\_RMS\_<HDS/IHDS>
- Tag Name: <Interval>\_<CH>\_<Units>\_RMS\_<HDS/IHDS>  
(DC...50)

**Table 212 - Substitution Table**

<b>For:</b>	<b>Substitute:</b>	<b>To return these EN61000_4_30 results:</b>
<Interval>	200mS	200mS interval group
	3s	3 second interval group
	10m	10 minute interval group
	2h	2 hour interval group
<CH>	V1_N	Line 1 to Neutral voltage
	V2_N	Line 2 to Neutral voltage
	V3_N	Line 3 to Neutral voltage
	VN_G	Neutral to Ground voltage
	V1_V2	Line 1 to Line 2 voltage
	V2_V3	Line 2 to Line 3 voltage
	V3_V1	Line 3 to Line 1 voltage
	I1	Line 1 current
	I2	Line 2 current
	I3	Line 3 current
<Units>	Volts	Voltage
	Amps	Current
<HDS/IHDS>	HDS	Harmonic distortion subgroup
	IHDS	Interharmonic distortion subgroup

**Table 213 - EN61000-4-30 Harmonic and Interharmonic Group Results Instance Lookup Table**

Data Table Name	CIP Assembly Instance Number	PCCC File No.
PowerQuality.200mS_V1_N_Volts_RMS_HDS	901	F110
PowerQuality.200mS_V2_N_Volts_RMS_HDS	902	F111
PowerQuality.200mS_V3_N_Volts_RMS_HDS	903	F112
PowerQuality.200mS_VN_G_Volts_RMS_HDS	904	F113
PowerQuality.200mS_V1_V2_Volts_RMS_HDS	905	F114
PowerQuality.200mS_V2_V3_Volts_RMS_HDS	906	F115
PowerQuality.200mS_V3_V1_Volts_RMS_HDS	907	F116
PowerQuality.200mS_I1_Amps_RMS_HDS	908	F117
PowerQuality.200mS_I2_Amps_RMS_HDS	909	F118
PowerQuality.200mS_I3_Amps_RMS_HDS	910	F119
PowerQuality.200mS_I4_Amps_RMS_HDS	911	F120
PowerQuality.200mS_V1_N_Volts_RMS_IHDS	912	F121
PowerQuality.200mS_V2_N_Volts_RMS_IHDS	913	F122
PowerQuality.200mS_V3_N_Volts_RMS_IHDS	914	F123
PowerQuality.200mS_VN_G_Volts_RMS_IHDS	915	F124
PowerQuality.200mS_V1_V2_Volts_RMS_IHDS	916	F125
PowerQuality.200mS_V2_V3_Volts_RMS_IHDS	917	F126
PowerQuality.200mS_V3_V1_Volts_RMS_IHDS	918	F127
PowerQuality.200mS_I1_Amps_RMS_IHDS	919	F128
PowerQuality.200mS_I2_Amps_RMS_IHDS	920	F129
PowerQuality.200mS_I3_Amps_RMS_IHDS	921	F130
PowerQuality.200mS_I4_Amps_RMS_IHDS	922	F131
PowerQuality.3s_V1_N_Volts_RMS_HDS	923	F132
PowerQuality.3s_V2_N_Volts_RMS_HDS	924	F133
PowerQuality.3s_V3_N_Volts_RMS_HDS	925	F134
PowerQuality.3s_VN_G_Volts_RMS_HDS	926	F135
PowerQuality.3s_V1_V2_Volts_RMS_HDS	927	F136
PowerQuality.3s_V2_V3_Volts_RMS_HDS	928	F137
PowerQuality.3s_V3_V1_Volts_RMS_HDS	929	F138
PowerQuality.3s_V1_N_Volts_RMS_IHDS	930	F139
PowerQuality.3s_V2_N_Volts_RMS_IHDS	931	F140
PowerQuality.3s_V3_N_Volts_RMS_IHDS	932	F141
PowerQuality.3s_VN_G_Volts_RMS_IHDS	933	F142
PowerQuality.3s_V1_V2_Volts_RMS_IHDS	934	F143
PowerQuality.3s_V2_V3_Volts_RMS_IHDS	935	F144
PowerQuality.3s_V3_V1_Volts_RMS_IHDS	936	F145
PowerQuality.10m_V1_N_Volts_RMS_HDS	937	F146
PowerQuality.10m_V2_N_Volts_RMS_HDS	938	F147

**Table 213 - EN61000-4-30 Harmonic and Interharmonic Group Results Instance Lookup Table**

<b>Data Table Name</b>	<b>CIP Assembly Instance Number</b>	<b>PCCC File No.</b>
PowerQuality.10m_V3_N_Volts_RMS_HDS	939	F148
PowerQuality.10m_VN_G_Volts_RMS_HDS	940	F149
PowerQuality.10m_V1_V2_Volts_RMS_HDS	941	F150
PowerQuality.10m_V2_V3_Volts_RMS_HDS	942	F151
PowerQuality.10m_V3_V1_Volts_RMS_HDS	943	F152
PowerQuality.10m_V1_N_Volts_RMS_IHDS	944	F153
PowerQuality.10m_V2_N_Volts_RMS_IHDS	945	F154
PowerQuality.10m_V3_N_Volts_RMS_IHDS	946	F155
PowerQuality.10m_VN_G_Volts_RMS_IHDS	947	F156
PowerQuality.10m_V1_V2_Volts_RMS_IHDS	948	F157
PowerQuality.10m_V2_V3_Volts_RMS_IHDS	949	F158
PowerQuality.10m_V3_V1_Volts_RMS_IHDS	950	F159
PowerQuality.2h_V1_N_Volts_RMS_HDS	951	F160
PowerQuality.2h_V2_N_Volts_RMS_HDS	952	F161
PowerQuality.2h_V3_N_Volts_RMS_HDS	953	F162
PowerQuality.2h_VN_G_Volts_RMS_HDS	954	F163
PowerQuality.2h_V1_V2_Volts_RMS_HDS	955	F164
PowerQuality.2h_V2_V3_Volts_RMS_HDS	956	F165
PowerQuality.2h_V3_V1_Volts_RMS_HDS	957	F166
PowerQuality.2h_V1_N_Volts_RMS_IHDS	958	F167
PowerQuality.2h_V2_N_Volts_RMS_IHDS	959	F168
PowerQuality.2h_V3_N_Volts_RMS_IHDS	960	F169
PowerQuality.2h_VN_G_Volts_RMS_IHDS	961	F170
PowerQuality.2h_V1_V2_Volts_RMS_IHDS	962	F171
PowerQuality.2h_V2_V3_Volts_RMS_IHDS	963	F172
PowerQuality.2h_V3_V1_Volts_RMS_IHDS	964	F173

**Table 214 - PowerQuality.EN61000\_4\_30 HDS and IHDS Results Data Table template (DC...50)**

Element Number	Type	Tag Name	Description	Units	Range
0	Real	<Interval>_Metering_Date_Stamp	Date of cycle collection MM:DD:YY	MMDDYY	0...123199
1	Real	<Interval>_Metering_Time_Stamp	Time of cycle collection HH:MM:SS	hhmmss	0...235959
2	Real	<Interval>_Metering_uSecond_Stamp	Microsecond of cycle collection	uS	0.000...999,999
3	Real	<Interval>_<CH>_<Units>_DC_RMS	The individual RMS magnitude	Same as <Units> string in Tag Name: Volts Amps	0...9.999E15
4	Real	<Interval>_<CH>_<Units>_RMS_<HDS/IHDS>1			0...9.999E15
5	Real	<Interval>_<CH>_<Units>_RMS_<HDS/IHDS>2			0...9.999E15
6	Real	<Interval>_<CH>_<Units>_RMS_<HDS/IHDS>3			0...9.999E15
7	Real	<Interval>_<CH>_<Units>_RMS_<HDS/IHDS>4			0...9.999E15
8	Real	<Interval>_<CH>_<Units>_RMS_<HDS/IHDS>5			0...9.999E15
9	Real	<Interval>_<CH>_<Units>_RMS_<HDS/IHDS>6			0...9.999E15
10	Real	<Interval>_<CH>_<Units>_RMS_<HDS/IHDS>7			0...9.999E15
11	Real	<Interval>_<CH>_<Units>_RMS_<HDS/IHDS>8			0...9.999E15
12	Real	<Interval>_<CH>_<Units>_RMS_<HDS/IHDS>9			0...9.999E15
13	Real	<Interval>_<CH>_<Units>_RMS_<HDS/IHDS>10			0...9.999E15
14	Real	<Interval>_<CH>_<Units>_RMS_<HDS/IHDS>11			0...9.999E15
15	Real	<Interval>_<CH>_<Units>_RMS_<HDS/IHDS>12			0...9.999E15
16	Real	<Interval>_<CH>_<Units>_RMS_<HDS/IHDS>13			0...9.999E15
17	Real	<Interval>_<CH>_<Units>_RMS_<HDS/IHDS>14			0...9.999E15
18	Real	<Interval>_<CH>_<Units>_RMS_<HDS/IHDS>15			0...9.999E15
19	Real	<Interval>_<CH>_<Units>_RMS_<HDS/IHDS>16			0...9.999E15
20	Real	<Interval>_<CH>_<Units>_RMS_<HDS/IHDS>17			0...9.999E15
21	Real	<Interval>_<CH>_<Units>_RMS_<HDS/IHDS>18			0...9.999E15
22	Real	<Interval>_<CH>_<Units>_RMS_<HDS/IHDS>19			0...9.999E15
23	Real	<Interval>_<CH>_<Units>_RMS_<HDS/IHDS>20			0...9.999E15
24	Real	<Interval>_<CH>_<Units>_RMS_<HDS/IHDS>21			0...9.999E15
25	Real	<Interval>_<CH>_<Units>_RMS_<HDS/IHDS>22			0...9.999E15
26	Real	<Interval>_<CH>_<Units>_RMS_<HDS/IHDS>23			0...9.999E15
27	Real	<Interval>_<CH>_<Units>_RMS_<HDS/IHDS>24			0...9.999E15
28	Real	<Interval>_<CH>_<Units>_RMS_<HDS/IHDS>25			0...9.999E15
29	Real	<Interval>_<CH>_<Units>_RMS_<HDS/IHDS>26			0...9.999E15
30	Real	<Interval>_<CH>_<Units>_RMS_<HDS/IHDS>27			0...9.999E15
31	Real	<Interval>_<CH>_<Units>_RMS_<HDS/IHDS>28			0...9.999E15
32	Real	<Interval>_<CH>_<Units>_RMS_<HDS/IHDS>29			0...9.999E15
33	Real	<Interval>_<CH>_<Units>_RMS_<HDS/IHDS>30			0...9.999E15
34	Real	<Interval>_<CH>_<Units>_RMS_<HDS/IHDS>31			0...9.999E15
35	Real	<Interval>_<CH>_<Units>_RMS_<HDS/IHDS>32			0...9.999E15

**Table 214 - PowerQuality.EN61000\_4\_30 HDS and IHDS Results Data Table template (DC...50) (continued)**

Element Number	Type	Tag Name	Description	Units	Range
36	Real	<Interval>_<CH>_<Units>_RMS_<HDS/IHDS>33	The individual RMS magnitude	Same as <Units> string in Tag Name: Volts Amps	0...9.999E15
37	Real	<Interval>_<CH>_<Units>_RMS_<HDS/IHDS>34			0...9.999E15
38	Real	<Interval>_<CH>_<Units>_RMS_<HDS/IHDS>35			0...9.999E15
39	Real	<Interval>_<CH>_<Units>_RMS_<HDS/IHDS>36			0...9.999E15
40	Real	<Interval>_<CH>_<Units>_RMS_<HDS/IHDS>37			0...9.999E15
41	Real	<Interval>_<CH>_<Units>_RMS_<HDS/IHDS>38			0...9.999E15
42	Real	<Interval>_<CH>_<Units>_RMS_<HDS/IHDS>39			0...9.999E15
43	Real	<Interval>_<CH>_<Units>_RMS_<HDS/IHDS>40			0...9.999E15
44	Real	<Interval>_<CH>_<Units>_RMS_<HDS/IHDS>41			0...9.999E15
45	Real	<Interval>_<CH>_<Units>_RMS_<HDS/IHDS>42			0...9.999E15
46	Real	<Interval>_<CH>_<Units>_RMS_<HDS/IHDS>43			0...9.999E15
47	Real	<Interval>_<CH>_<Units>_RMS_<HDS/IHDS>44			0...9.999E15
48	Real	<Interval>_<CH>_<Units>_RMS_<HDS/IHDS>45			0...9.999E15
49	Real	<Interval>_<CH>_<Units>_RMS_<HDS/IHDS>46			0...9.999E15
50	Real	<Interval>_<CH>_<Units>_RMS_<HDS/IHDS>47			0...9.999E15
51	Real	<Interval>_<CH>_<Units>_RMS_<HDS/IHDS>48			0...9.999E15
52	Real	<Interval>_<CH>_<Units>_RMS_<HDS/IHDS>49			0...9.999E15
53	Real	<Interval>_<CH>_<Units>_RMS_<HDS/IHDS>50			0...9.999E15

## Information Tables

Refer to [Time Zone Information on page 200](#).

Refer to [Min/Max Log on page 136](#).

Refer to [Setpoint Parameter Selection List on page 185](#).

Refer to [Setpoint Output Action List on page 192](#).

**Notes:**

## Technical Specifications

**Table 215 - Accuracy and Range**

Parameter	Accuracy in % of Reading at 25 °C (77 °F) 50/60 Hz Unity Power Factor	Nom Metering Value/Metering range, min...max
Voltage Sense Inputs: V1, V2, V3, VN	±0.1%	Line-neutral RMS: 398V AC/15...660V AC Line-line RMS: 690V AC /26...1144V AC
VG		Connect to power system earth ground only. This connection is a functional ground.
Current Sense Input: I1, I2, I3, I4	±0.1%	5 A / 0.05...15.6 A RMS
Frequency	±0.05 Hz	50 Hz or 60 Hz / 40...70 Hz
Power Functions: kW, kVA, kVAR Demand Functions: kW, kVA, kVAR Energy Functions: kWh, kVAh, kVARh	<ul style="list-style-type: none"> <li>ANSI C12.20-2010 Class 0.2<sup>(1)</sup> Clause 5.5.4</li> <li>EN 62053-22-2003 Class 0.2 Accuracy<sup>(1)</sup> Clause 8</li> </ul>	
Metering Update Rates	One update per line cycle; 1024 samples per cycle per channel	

(1) For catalog number 1426-MSE (PN-54351) units manufactured from July 2012...January 2013, the accuracy is Class 0.5 **not** Class 0.2. All other characteristics and products are not impacted. The impacted units are those units with manufacturing date codes of 0712, 0812, 0912, 1012, 1112, 1212, 0113.

**Table 216 - Power Quality**

Standard	Category	Remarks	M5	M6	M8
IEEE 519	Pass/Fail, TDD			•	•
IEEE 1159	1.0 Transients	1.1.3 and 1.2.1 only			•
	2.0 Short-duration root-mean-square (rms) variations			•	•
	3.0 Long duration rms variations			•	•
	4.0 Imbalance		•	•	•
	5.0 Waveform distortion	THD, K-factor, crest factor Individual harmonic results	•	•	•
	6.0 Voltage fluctuations	Calculated per IEC 61000-4-15:2003			•
	7.0 Power frequency variations			•	•
EN 50160	4 - Low Voltage Supply Characteristics	< 1 kV			•
	5 - Medium Voltage Supply Characteristics	1 kV ... 36 kV			•
	6 - High-Voltage Supply Characteristics	> 36 kV, not supported			

**Table 217 - EN 61000-4-30 Class Designations (M8 model only)**

61000-4-30 Section Power Quality Parameter	PowerMonitor 5000 Class Designation		Remarks
	Metering	Aggregation	
5.1 Power frequency	A	S	
5.2 Magnitude of the supply voltage	A	S	
5.3 Flicker	A	S	Pst range 0.1 to 12
5.4 Supply voltage dips and swells	A		
5.5 Voltage interruptions	A		
5.7 Supply voltage unbalance	A	S	
5.8 Voltage harmonics	A	S	
5.9 Voltage interharmonics	A	S	
5.10 Mains signaling voltage	A		
5.12 Underdeviation and overdeviation	A	S	
4.4 Measurement aggregation intervals		S	
4.6 Real-time-clock uncertainty	A w/external sync,		
S with internal RTC			
4.7 Flagging	Yes		
6.1 Transient influence quantities	Yes		

**Table 218 - Input and Output Ratings**

Parameter	Rating, nom	Range, max
Control Power (L1, L2)	120/240V AC 50/60 Hz (38VA) Or 120/240V DC (26VA)	85...264V AC 47...63 Hz Or 106...275V DC
Control Power (24V DC)	24V DC (12VA)	22.8...25.2V DC



**Table 219 - Input and Output Ratings**

Parameter	Rating
Voltage Sense Inputs: V1, V2, V3, VN	Input Impedance: 5M ohm min Input current: 1 mA max
Current Sense Inputs: I1, I2, I3, I4	Overload Withstand: 22 A Continuous, 200 A for one second Burden: Negligible Impedance: Negligible Maximum Crest Factor at 5 A is 4.0 Starting Current: 5 mA
Status Inputs	Contact Closure (Internal 24V DC)
KYZ Output	Solid-State KYZ: 80 mA at 240V AC/V DC
Control Relay	ANSI C37.90 trip duty: 2005

**Table 220 - Control Relay**

Rating	50/60 Hz AC RMS	DC
Max Resistive Load Switching	10 A at 240V (2400VA)	10 A at 24V and 0.25 A at 125V
Min Load Switching	100 mA at 5V	10 mA at 5V
UL 508, CSA 22.2, IC Rating Class	B300	Q300
Max Make Values (Inductive Load)	30 A at 120V 15 A at 240V (3600VA)	0.55 A at 125V 0.27 A at 240V (69VA)
Max Break Values (Inductive Load)	3 A at 120V 1.5 A at 240V (360VA)	0.55 A at 125V 0.27 A at 240V (69VA)
Max Motor Load Switching	1/3 HP at 125V 1/2 HP at 240V	

**Table 221 - General Specifications**

Parameter	Maximum Rating
Voltage Terminal Blocks	18...14 AWG (0.75...2.5 mm <sup>2</sup> ), 75 °C Minimum Copper Wire only Recommended torque 1.5 N·m (13.3 lb·in)
Current Sensing Input	12 AWG (4 mm <sup>2</sup> ), 75 °C Minimum Copper Wire only Recommended torque: N/A
Control Power Terminal Block	22...14 AWG (0.25...2.5 mm <sup>2</sup> ), 75 °C Minimum Copper Wire only Recommended torque 0.63 N·m (5.6 lb·in)
Input/Output (I/O) Terminal Block	20...14 AWG (0.5...2.5 mm <sup>2</sup> ), 75 °C Minimum Copper Wire only Recommended torque 0.63 N·m (5.6 lb·in)
Temperature, Operating	-20...+70 °C (4...158 °F)
Temperature, Storage	-40...+85 °C (-40...+185 °F)
Humidity	5...95%, Noncondensing
Vibration	2 g
Shock, Operating	30 g
Shock, Nonoperating	50 g
Dielectric Withstand	UL61010, EN61010
Installation Location	Indoor use only
Altitude	Max 2000 m (6560 ft.)

## Certifications

The PowerMonitor 5000 unit adheres to the following certifications and approvals.

### UL/CUL

UL 61010 listed, File E345550, for Measuring, Testing and Signal-generation Equipment and CUL Certified.

### CE Certification

If this product bears the CE marking, the product is approved for installation within the European Union and EEA regions. This product has been designed to meet the following directives.

## EMC Directive

This product is tested to meet Council Directive 2004/108/EC Electromagnetic Compatibility (EMC) and the following standards, in whole, which is documented in a technical construction file.

*EN 61326-1:2006*



**WARNING:** This product is a class A product that is intended for use in an industrial environment. In a residential, commercial, or light industrial environment, this product can cause radio interference. This product is not intended to be installed in a residential environment. In a commercial and light industrial environment with connection to the public mains supply, you can take adequate measures to reduce interference.

---

## *Low Voltage Directive*

This product is tested to meet Council Directive 2006/95/EC Low Voltage, by applying the safety requirements of EN61010-1: 2001.

This equipment is classified as open equipment and must be installed (mounted) in an enclosure during operation as a means of providing safety protection.

## *International Standard IEC 60529 / NEMA / UL 61010 Degree of Protection*

The Bulletin 1426 PowerMonitor 5000 unit is rated as IP10 degree of protection per International Standard IEC 60529. The unit is considered an open device per NEMA and UL 61010 Follow the recommended installation guidelines to maintain these ratings.

## ANSI/IEEE Tested

Meets or exceeds the C37.90 Trip Duty: 2005 for protective relays and relay systems on all power-connection circuit terminations.

**Notes:**

## PowerMonitor 5000 Display Module, Series B Application Summary

### Introduction

The PowerMonitor™ 5000 Display Module Series B, catalog number 1426-DM, is a PanelView™ 800 terminal with factory-installed applications.

This display module displays key information from one, two, or three PowerMonitor 5000 units. Minimal setup for communication is required.

See the PanelView 800 HMI Terminals User Manual, publication [2711R-UM001](#), for additional information on the performance of the steps outlined in this Appendix.

### Terminal Setup

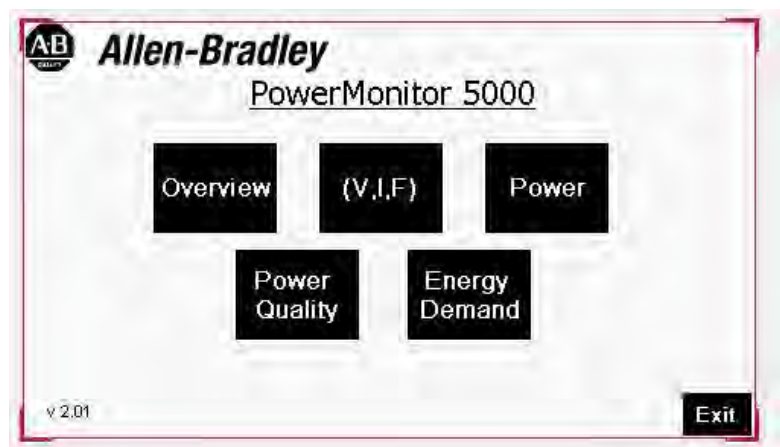
---

**IMPORTANT** For the PanelView 800 terminal application to communicate with a power monitor, both need their own unique IP address on the same network and subnet.

---

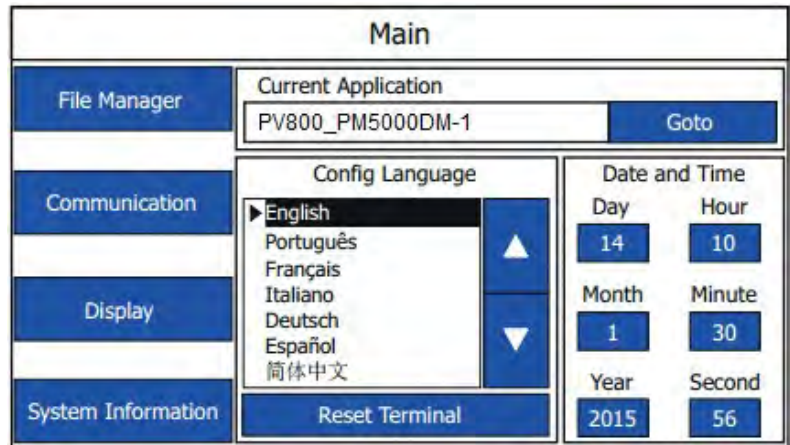
**TIP** You cannot change the Ethernet settings from PanelView Explorer. If you want to change this setting, you must do so from the terminal configuration screens.

To configure the PanelView 800 terminal, follow these instructions. This screen displays on startup of the PowerMonitor 5000 Display Module.



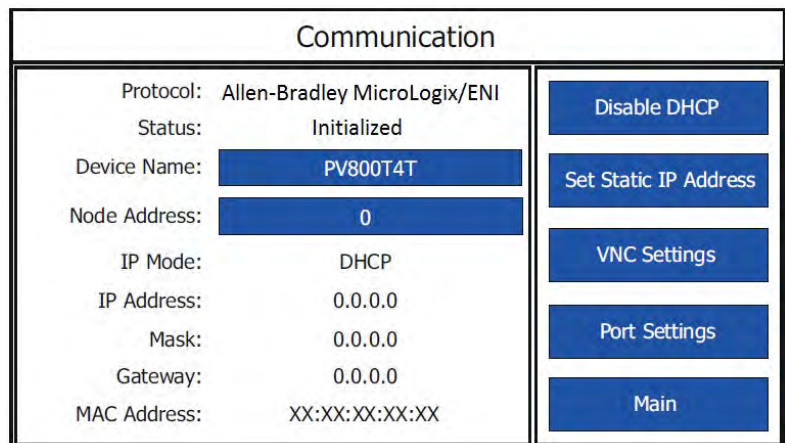
1. To exit the application, press Exit.

The Main screen displays.



2. Press Communication.

The Communication screen displays.



3. To disable DHCP, press Disable DHCP.

**IMPORTANT** If a terminal is set for DHCP and is not on a network or is on a network that does not have a DHCP server (or the server is not available), it automatically assigns itself an Automatic Private IP address (or auto IP address). The auto IP address is in the range of 169.254.0.0 through 169.254.255.255. The terminal makes sure that the auto IP address is unique from any other auto IP address of other devices on the network. The terminal can now communicate with other devices on the network that have IP addresses in the 169.254.xxx.xxx range (and a subnet mask of 255.255.0.0).

4. Obtain an IP address for the PanelView 800 terminal.
5. Press Set Static IP Address and enter the IP address for the PanelView 800 terminal.
6. After the IP address of the PanelView 800 terminal has been configured, return to the Main screen.

7. Press File Manager.

The File Manager screen displays.

File Manager			
Source:		To:	
▲	Internal	▼	
▲	Internal	▼	
PV800_PM5000DM-3 PV800_PM5000DM-2 PV800_PM5000DM-1			▲ ▼
Recipe	Copy Alarm History	Controller Settings	
Startup Application			
PV800_PM5000DM-1			Reset
			Main
			Copy
			Delete
			Set As Startup
			Run
			Stop Application

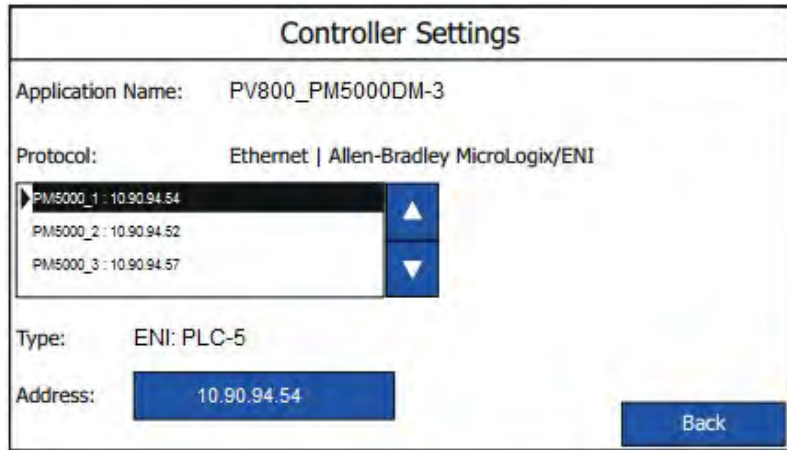
8. Use the up and down arrows to select the desired application file PV800\_PM5000DM-#.

The # is either 1, 2, or 3 depending on the number of power monitors being used.

9. Press Controller Settings.

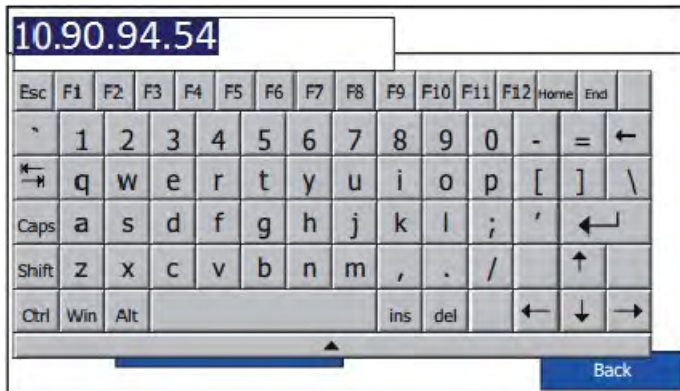
File Manager			
Source:		To:	
▲	Internal	▼	
▲	Internal	▼	
PV800_PM5000DM-3 PV800_PM5000DM-2 PV800_PM5000DM-1			▲ ▼
Recipe	Copy Alarm History	Controller Settings	
Startup Application			
PV800_PM5000DM-1			Reset
			Main
			Copy
			Delete
			Set As Startup
			Run
			Stop Application

The Controller Settings screen displays to let you configure the IP addresses of the power monitors.



10. Use the up or down arrows to select PM5000\_# to update the IP addresses. The # is either 1, 2, or 3 corresponding to the target power monitor.
11. To modify the IP address of the power monitor, press the address field in the blue box.

A keyboard appears.



Type in the IP address of the PowerMonitor unit and then press the Return key to enter.



12. After configuring the IP addresses of the power monitors, press Back to return to the File Manager screen.

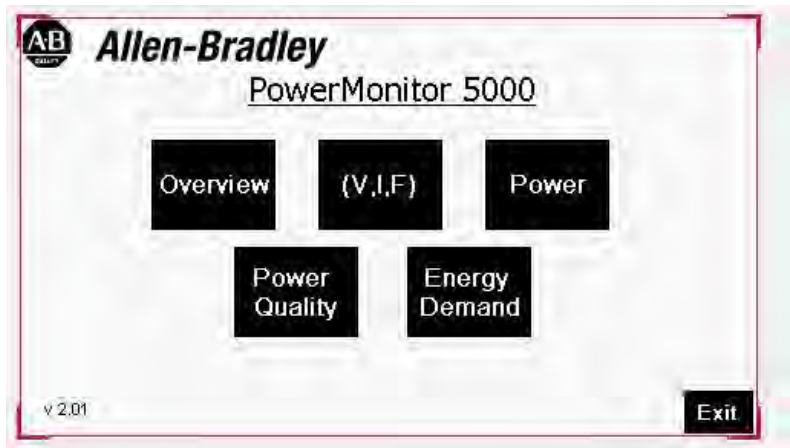
13. Use the up and down arrows to select the desired application and press Run to run the application.

**TIP** To change the application that runs on the terminal each time the terminal starts up, select the application from the name list and click Set As Startup.

## Navigation

This section describes the navigation for the PowerMonitor 5000 Display Module application. All screen captures in this section are for the application that uses three power monitors. The Main screen is displayed upon running the application file from the File Manager. From this screen, you can select any of the five other screens.

Figure 38 - Main

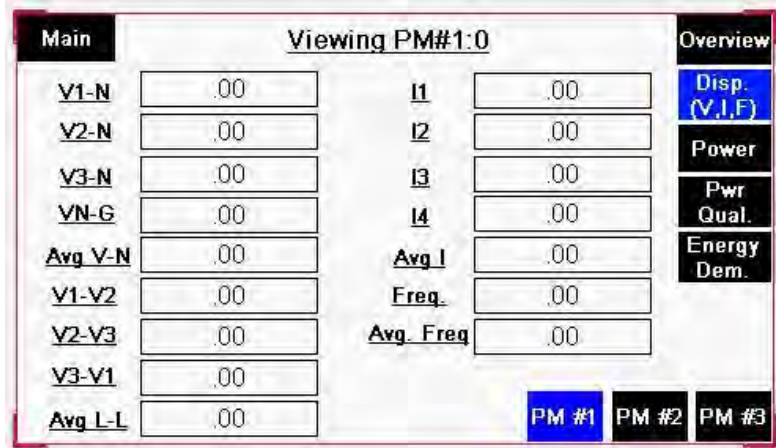


- Press Overview to display the Overview screen. This screen is unique as the screen displays values for up to three power monitors simultaneously

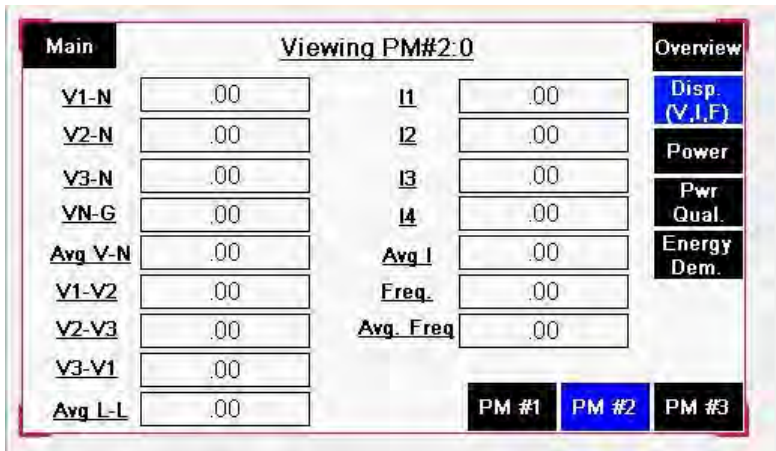
Figure 39 - Overview

Main	Overview			Overview
	PM5000 #1	PM5000 #2	PM5000 #3	Disp. (V,I,F)
Avg V-N	.00	.00	.00	Power
Avg I	.00	.00	.00	Pwr Qual.
Tot. KW	.00	.00	.00	Energy Dem.
Avg. TPF	0	0	0	

- Press V,I,F to open the following screen.

**Figure 40 - Metering\_VIF**

By default, pressing any button displays data from the power monitor whose IP address was entered first. The buttons along the bottom select another power monitor. Any button that is highlighted in blue indicates the selected screen and power monitor. The VIF screen for PM#2 is shown in [Figure 41](#).

**Figure 41 - Metering\_VIFPM2**

- [Figure 42](#) shows the Power screen

Figure 42 - Power

Main	Viewing PM#1:0						Overview
	kW		kVA		kVAR		Disp. (V,I,F)
L1	.00	.00	.00	.00	.00		Power
L2	.00	.00	.00	.00	.00		Pwr Qual.
L3	.00	.00	.00	.00	.00		Energy Dem.
Tot.	.00	.00	.00	.00	.00		
	Lead/Lag		Disp	True			
Power L1	0	0	0	0	0		
Factor L2	0	0	0	0	0		
L3	0	0	0	0	0		
Tot.	0	Avg.	0	0	0	PM #1	PM #2
						PM #3	

- [Figure 43](#) shows the Power Quality screen.

Figure 43 - Power Quality

Main	Viewing PM#1:0						Overview
	Volts		Amps		K-Factor		Disp. (V,I,F)
Pos. Seq.	.00	.00	.00	.00	I1	0	Power
Neg. Seq.	.00	.00	.00	.00	I2	0	Pwr Qual.
Zero Seq.	.00	.00	.00	.00	I3	0	Energy Dem.
% Unbal.	.00	.00	.00	.00			
	THD		IEEE	IEC			
Avg V L-N	0	0	0	0	0		
Avg V-V	0	0	0	0	0		
Avg I	0	0	0	0	0	PM #1	PM #2
						PM #3	

- [Figure 44](#) shows the Energy Demand screen.

**Figure 44 - NRG-Demand**

Main	Viewing PM#1:0			Overview
	FWD	REV	Net	
<b>KWh</b>	.00	.00	.00	Disp. (V.I.F)
<b>kVARh</b>	.00	.00	.00	Power
			<b>kVAh</b>	Pwr Qual.
			<b>kAh</b>	Energy Dem.
	<b>Demand</b>	<b>Proj. Demand</b>		
<b>KW</b>	.00	.00		
<b>kVAR</b>	.00	.00		
<b>kVA</b>	.00	.00		
<b>Amps</b>	.00	.00		
<b>PF</b>	.00			
				PM #1 PM #2 PM #3

## Notes:

## PowerMonitor 5000 Display Module, Series A Application Summary

### Introduction

The PowerMonitor™ 5000 Display Module, catalog number 1426-DM, is a PanelView™ Component C400 terminal with factory-installed applications. This display module displays key information from one, two, or three PowerMonitor 5000 units. Minimal setup for communication is required.

See the PanelView Component HMI Terminals User Manual, publication [2711C-UM001](#), for additional information on performing the steps outlined in this Appendix.

### Terminal Setup

---

**IMPORTANT** In order for the C400 terminal application to communicate with a power monitor, both need their own unique IP address on the same network and subnet. The computer that you use for setup must also access the same network.

---

Follow these instructions for configuring the C400 terminal.

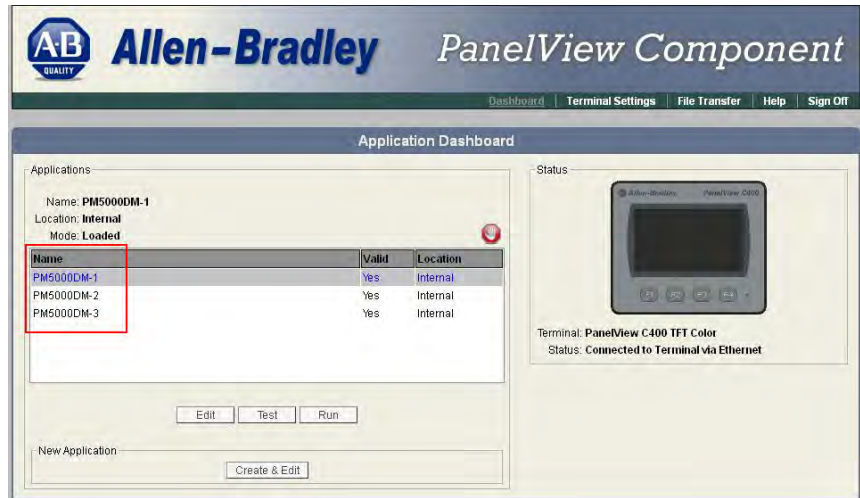
1. Obtain an IP address for the C400 terminal and set the address as a static IP address in the C400 terminal.
2. Open a compatible web browser and type the terminal IP address into the address bar.

The PanelView Explorer Startup window appears.

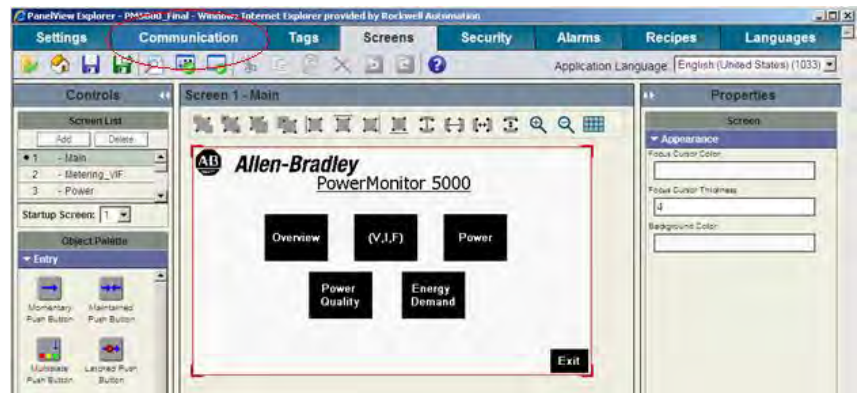
3. Disable the web browser pop-up blocker, if necessary.

4. Select PM5000DM-# and click Edit.

The # is either 1, 2, or 3 depending on the number of power monitors being monitored.



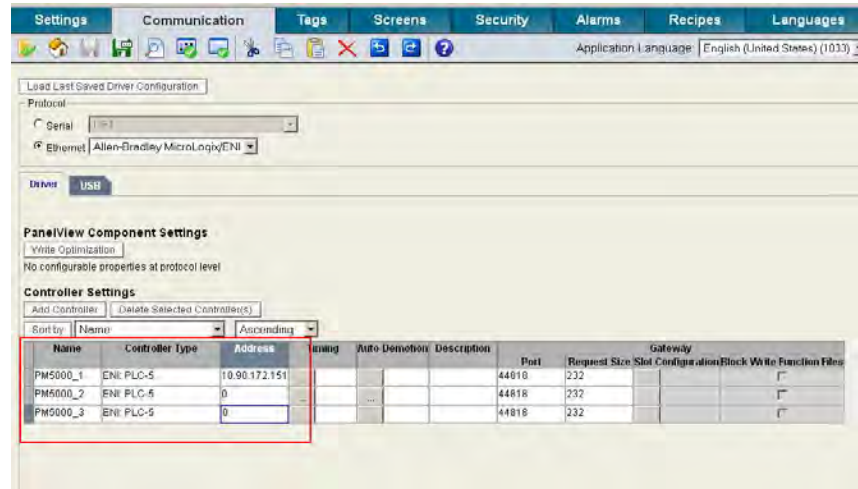
5. Once the PanelView Explorer window opens, click the Communication tab.



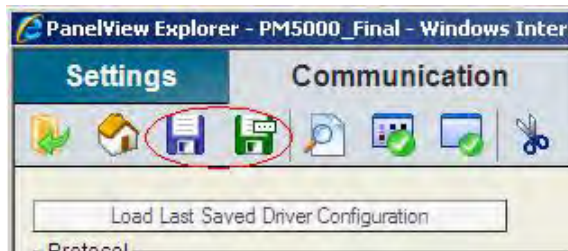
On the Communication tab is a Controller Settings heading listing the power monitors in the application.



6. To validate the application update the IP addresses and click the Validate Application icon.

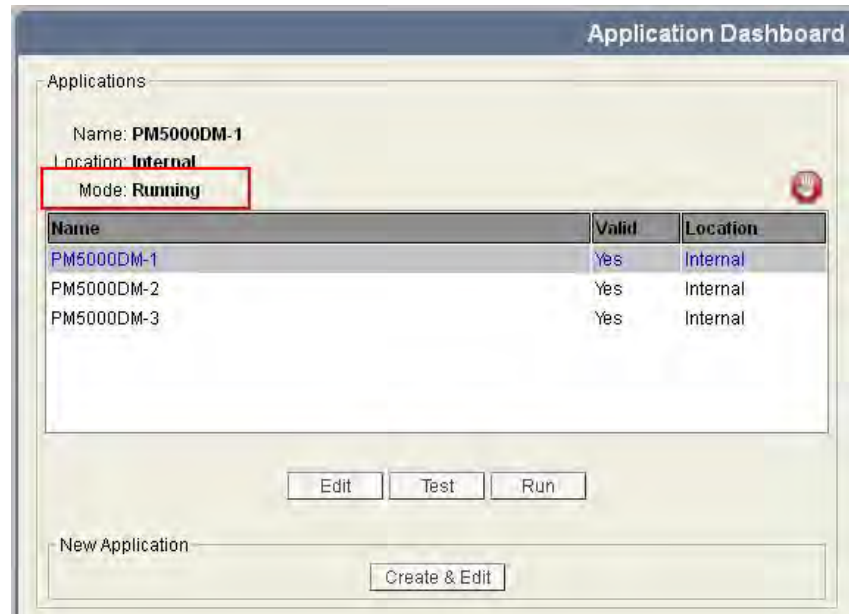


7. Once the application has been validated, click the blue floppy disk icon to save the program.



8. Close the dialog box to return to the PanelView Explorer Startup window.

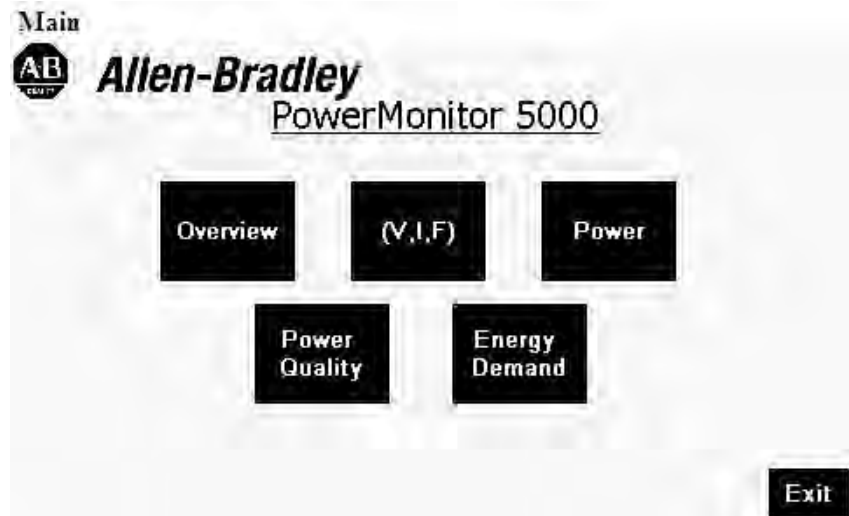
9. In the start-up window, select PM5000DM-1 and click Run.
10. Once the Application Mode changes to 'Running', click Sign Off in the upper right to close the dialog box.



## Navigation

This section describes the navigation for the PowerMonitor 5000 Display Module application. All screen captures in this section are for the application that uses three power monitors. The Main screen is displayed on startup. From this screen, you can select any of the five other screens.

**Figure 45 - Main**



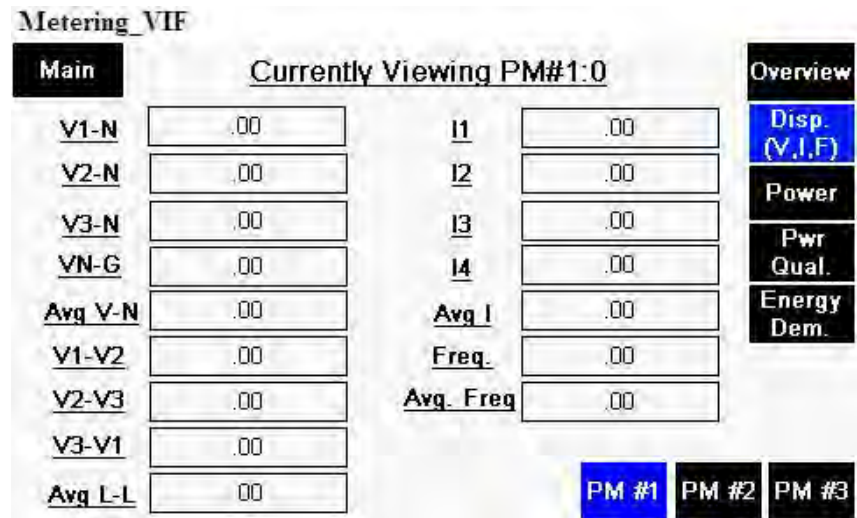
- Press Overview to display the Overview screen. This screen is unique as the screen displays values for up to three power monitors simultaneously.

**Figure 46 - Overview**

Overview				Overview
	<b>Main</b>	<b>Overview</b>		<b>Disp. (V,I,F)</b>
		<b>PM5000 #1</b>	<b>PM5000 #2</b>	<b>Power</b>
<b>Avg V-N</b>		.00	.00	<b>Pwr Qual.</b>
<b>Avg I</b>		.00	.00	<b>Energy Dem.</b>
<b>Tot. KW</b>		.00	.00	
<b>Avg. TPF</b>		0	0	

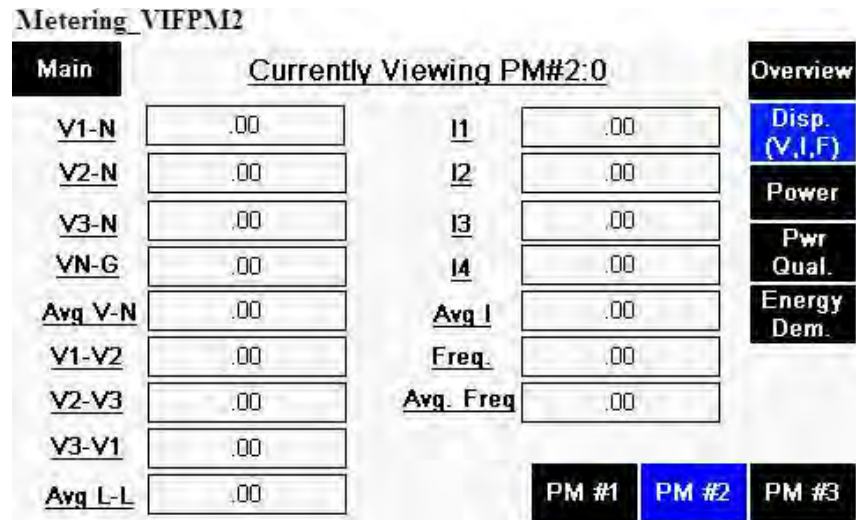
- Press V,I,F to open the following screen.

Figure 47 - Metering\_VIF



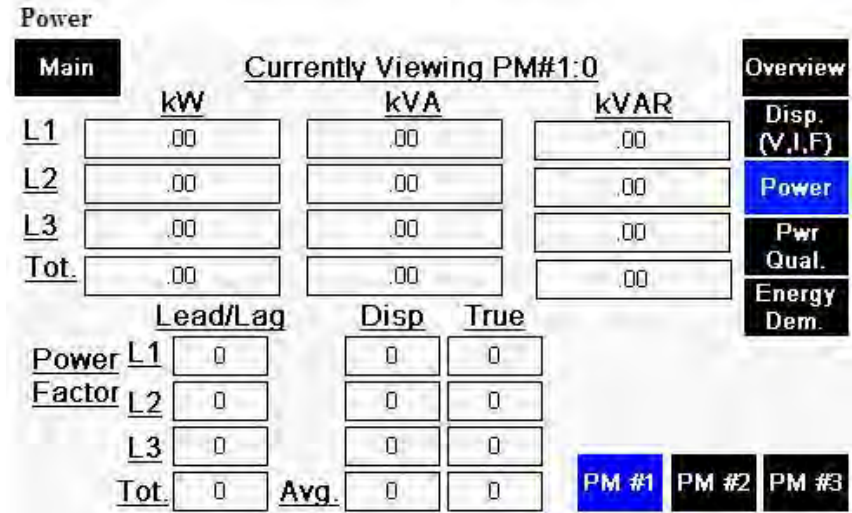
By default, pressing any button displays data from the power monitor whose IP address was entered first. The buttons along the bottom select another power monitor. Any button that is highlighted in blue indicates the selected screen and power monitor. The VIF screen for PM#2 is shown in [Figure 48](#).

Figure 48 - Metering\_VIFPM2



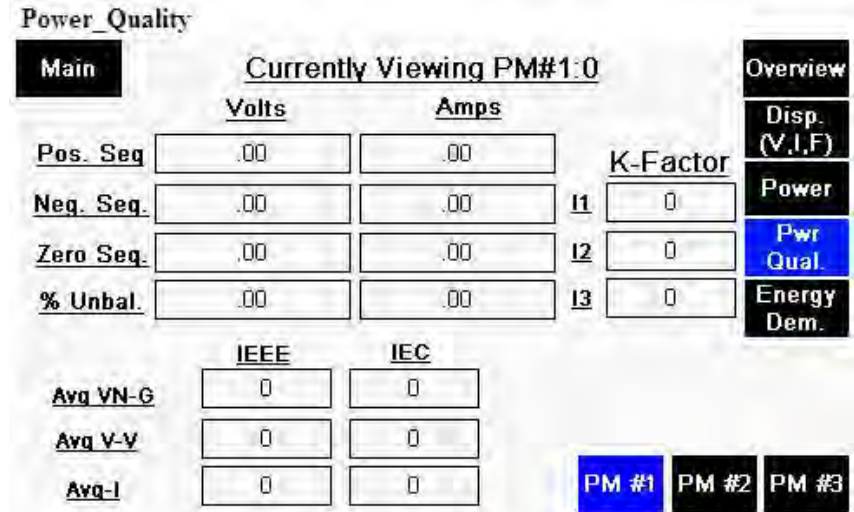
- [Figure 49](#) shows the Power screen.

**Figure 49 - Power**



- [Figure 50](#) shows the Power Quality screen.

**Figure 50 - Power Quality**



- [Figure 51](#) shows the Energy Demand screen.

Figure 51 - NRG-Demand

NRG-Demand				Currently Viewing PM#1:0			Overview		
Main	FWD	REV	Net				Disp. (V,I,F)	Power	Pwr Qual.
<u>KWh</u>	.00	.00	.00						
<u>kVARh</u>	.00	.00	.00						
				kVAh					
				kAh					
									<b>Energy Dem.</b>
<u>KW</u>	Demand		Proj. Demand						
	.00		.00						
<u>kVAR</u>	.00		.00						
<u>kVA</u>	.00		.00						
<u>Amps</u>	.00		.00						
<u>PF</u>	.00								
							<b>PM #1</b>	<b>PM #2</b>	<b>PM #3</b>

## PowerMonitor 5000 Waveform Capture and Compression

Waveform recordings in the power monitor consist of a series of cycle-by-cycle magnitude and angle data for each spectral component (harmonic) from DC through the 127th harmonic. To reduce the size of waveform records without losing significant resolution, the data is compressed before writing to the waveform file. To display the record as a waveform, the file data must be decompressed, and then an inverse FFT performed to obtain a series of time-domain voltage and current data that can then be plotted in a graphic format.

### Compression Algorithm

Three types of floating point number representations are used, with 32 bits, 16 bits, and 12 bits. The formats are summarized in the table.

Type	Total bits	Bits precision	Sign bits	Exponent bits	Significand bits	Exponent bias
IEEE 754 Single	32	24	1	8	23	127
16 bit encoded	16	12	1	4	11	TBD
12 bit encoded	12	8	1	4	7	TBD

This table defines how compression is applied to magnitude and angle values of specific harmonic orders.

Data / encoding	32-bit	16-bit	12-bit
Magnitude	DC thru 15th	-	16th thru 127th
Angle	-	DC thru 15th	16th thru 127th

The various number encodings are packed into the file in the following way:

**Table 222 - 32 bit (IEEE 754)**

Byte offset 0	Byte offset 1	Byte offset 2	Byte offset 3
Low byte	Next lowest byte	Next highest byte	High byte

**Table 223 - 16-bit Encoding**

Byte offset 0	Byte offset 1
Low byte	High byte

**Table 224 - 12-bit Encoding**

Byte offset 0	Byte offset 1	Byte offset 3	
Low 8 bits of X(h)	High 4 bits of X(h)	Low 4 bits of X(h+1)	High eight bits of X(h+1)

Where X(h) is the value (magnitude or angle) of the harmonic at order h.

### Magnitude Data

Bytes 0...63 contain 32-bit encoded magnitudes V(h) and I(h) for h = DC thru 15. Byte 64 contains the exponent offset for use in the 12-bit encoded data that follows. The remaining bytes hold the remaining harmonic magnitude values in 12-bit encoding.

Byte offset	0	1	2	3	4	5	6	7	8	9	10	11	12	13	14	15
Data Info	DC				1st Harmonics RMS				2nd				3rd			
Byte offset	16	17	18	19	20	21	22	23	24	25	26	27	28	29	30	31
Data Info	4th				5th				6th				7th			
Byte offset	32	33	34	35	36	37	38	39	40	41	42	43	44	45	46	47
Data Info	8th				9th				10th				11th			
Byte offset	48	49	50	51	52	53	54	55	56	57	58	59	60	61	62	63
Data Info	12th				13th				14th				15th			
Byte offset	64	65	66	67	68	69	70	71	72	73	74	75	76	77	78	79
Data Info	Exp	16th & 17th			18th & 19th			20th & 21st			22nd & 23rd			24th & 25th		
Byte offset	80	81	82	83	84	85	86	87	88	89	90	91	92	93	94	95
Data Info	26th & 27th			28th & 29th			30th & 31st			32nd & 33rd			34th & 35th			36th
Byte offset	96	97	98	99	100	101	102	103	104	105	106	107	108	109	110	111
Data Info	& 37th		38th & 39th			40th & 41st			42nd & 43rd			44th & 45th			46th &	
Byte offset	112	113	114	115	116	117	118	119	120	121	122	123	124	125	126	127
Data Info	47th	48th & 49th			50th & 51st			52nd & 53rd			54th & 55th			56th & 57th		
Byte offset	128	129	130	131	132	133	134	135	136	137	138	139	140	141	142	143
Data Info	58th & 59th			60th & 61st			62nd & 63rd			64th & 65th			66th & 67th			68th
Byte offset	144	145	146	147	148	149	150	151	152	153	154	155	156	157	158	159
Data Info	& 69th		70th & 71st			72nd & 73rd			74th & 75th			76th & 77th			78th &	
Byte offset	160	161	162	163	164	165	166	167	168	169	170	171	172	173	174	175
Data Info	79th	80th & 81st			82nd & 83rd			84th & 85th			86th & 87th			88th & 89th		
Byte offset	176	177	178	179	180	181	182	183	184	185	186	187	188	189	190	191
Data Info	90th & 91st			92nd & 93rd			94th & 95th			96th & 97th			98th & 99th			100th
Byte offset	192	193	194	195	196	197	198	199	200	201	202	203	204	205	206	207
Data Info	& 101st		102nd & 103rd			104th & 105th			106th & 107th			108th & 109th			110th &	
Byte offset	208	209	210	211	212	213	214	215	216	217	218	219	220	221	222	223
Data Info	111th	112th & 113th			114th & 115th			116th & 117th			118th & 119th			120th & 121st		
Byte offset	224	225	226	227	228	229	230	231	232							
Data Info	122nd & 123rd			124th & 125th			126th & 127th									



## Angle Data

Byte 0 contains the exponent offset for use in the 16-bit and 12-bit encoded data that follows. Bytes 1...32 contain 16-bit encoded magnitudes  $V(h)$  and  $I(h)$  for  $h = DC...15$ . The remaining bytes hold the remaining harmonic magnitude values in 12-bit encoding.

Byte offset	0	1	2	3	4	5	6	7	8	9	10	11	12	13	14	15
Data Info	Exp	DC Ang		1st Ang		2nd Ang		3rd Ang		4th		5th		6th		7th
Byte offset	16	17	18	19	20	21	22	23	24	25	26	27	28	29	30	31
Data Info	8th		9th		10th		11th		12th		13th		14th		15th	
Byte offset	32	33	34	35	36	37	38	39	40	41	42	43	44	45	46	47
Data Info	16th & 17th			18th & 19th			20th & 21st			22nd & 23rd			24th & 25th			
Byte offset	48	49	50	51	52	53	54	55	56	57	58	59	60	61	62	63
Data Info	26th & 27th			28th & 29th			30th & 31st			32nd & 33rd			34th & 35th		36th	
Byte offset	64	65	66	67	68	69	70	71	72	73	74	75	76	77	78	79
Data Info	& 37th		38th & 39th			40th & 41st			42nd & 43rd			44th & 45th		46th &		
Byte offset	80	81	82	83	84	85	86	87	88	89	90	91	92	93	94	95
Data Info	47th	48th & 49th			50th & 51st			52nd & 53rd			54th & 55th		56th & 57th			
Byte offset	96	97	98	99	100	101	102	103	104	105	106	107	108	109	110	111
Data Info	58th & 59th			60th & 61st			62nd & 63rd			64th & 65th			66th & 67th		68th	
Byte offset	112	113	114	115	116	117	118	119	120	121	122	123	124	125	126	127
Data Info	& 69th		70th & 71st			72nd & 73rd			74th & 75th			76th & 77th		78th &		
Byte offset	128	129	130	131	132	133	134	135	136	137	138	139	140	141	142	143
Data Info	79th	80th & 81st			82nd & 83rd			84th & 85th			86th & 87th		88th & 89th			
Byte offset	144	145	146	147	148	149	150	151	152	153	154	155	156	157	158	159
Data Info	90th & 91st			92nd & 93rd			94th & 95th			96th & 97th			98th & 99th		100th	
Byte offset	160	161	162	163	164	165	166	167	168	169	170	171	172	173	174	175
Data Info	& 101st		102nd & 103rd			104th & 105th			106th & 107th			108th & 109th		110th &		
Byte offset	176	177	178	179	180	181	182	183	184	185	186	187	188	189	190	191
Data Info	111th	112th & 113th			114th & 115th			116th & 117th			118th & 119th		120th & 121st			
Byte offset	192	193	194	195	196	197	198	199	200							
Data Info	122nd & 123rd			124th & 125th			126th & 127th									

## Waveform File Format

These tables illustrate the waveform file format.

Waveform Data Name	Data Type	Description
File ID	char[8]	File ID (Int16)+ Waveform Identifier(Int48) typedef struct { unsigned short sFileID; //this id is used for user selection,1...256 unsigned short sWaveformID; //the Waveform id highest 2 bytes unsigned long lWaveformID; //the Waveform id Lowest 4 bytes }WAVEFORM_ID;
Revision	unsigned short	Waveform format revision
Compressed	char	Compressed or not
Compression Type	char	Compression type
Metering Mode	char	Metering mode is used to check the channels in each cycle in the future, currently, the channels is fixed in 8 channels
Mac Address	char[6]	Mac Address of the device where the waveform is retrieved
Reserved	char[45]	Reserved for future use
Cycle #1 Data	char[3484]	The first cycle data
Cycle #2 Data	char[3484]	The second cycle data
Cycle #3 Data	char[3484]	The third cycle data
...	...	...
Cycle #N Data	char[3484]	The Nth cycle data

The Cycle 1 through n data format is shown in this table.

Waveform Data Name	Data Type	Description
Timestamp Seconds	unsigned long	Seconds of the first sample data timestamp
Timestamp Nanoseconds	unsigned long	Nanoseconds of the first sample data timestamp
Frequency	float	The average frequency of the current cycle
V1 Magnitude Data	char[233]	The compressed V1 magnitude harmonics data
V2 Magnitude Data	char[233]	The compressed V2 magnitude harmonics data
V3 Magnitude Data	char[233]	The compressed V3 magnitude harmonics data
VN Magnitude Data	char[233]	The compressed VN magnitude harmonics data
I1 Magnitude Data	char[233]	The compressed I1 magnitude harmonics data
I2 Magnitude Data	char[233]	The compressed I2 magnitude harmonics data
I3 Magnitude Data	char[233]	The compressed I3 magnitude harmonics data
I4 Magnitude Data	char[233]	The compressed I4 magnitude harmonics data
V1 Phase Data	char[201]	The compressed V1 phase harmonics data
V2 Phase Data	char[201]	The compressed V2 phase harmonics data
V3 Phase Data	char[201]	The compressed V3 phase harmonics data
VN Phase Data	char[201]	The compressed VN phase harmonics data
I1 Phase Data	char[201]	The compressed I1 phase harmonics data
I2 Phase Data	char[201]	The compressed I2 phase harmonics data
I3 Phase Data	char[201]	The compressed I3 phase harmonics data
I4 Phase Data	char[201]	The compressed I4 phase harmonics data

## IEEE 519 Pass/Fail and TDD

### IEEE 519 Pass/Fail Capability (M6 and M8 models)

IEEE 519-1992, the standard for Recommended Practices and Requirements for Harmonic Control in Electrical Power Systems, provides recommended limits for the level of harmonics in a circuit. The standard applies these limits to current and voltage harmonics up to the 40th order present at the Point of Common Coupling (PCC) between your electric power supplier and your facility, typically where utility meters are connected. The standard recommends limits for individual harmonic components and limits for Total Demand Distortion (TDD).

TDD is similar to THD except TDD is based on the maximum, rather than measured, fundamental load current.

The standard specifies distortion limits for long-term conditions, greater than one hour. In the short term, these limits can be exceeded by 50%. The PowerMonitor 5000 unit provides these results:

- Short Term: the 1 minute rolling average, which is updated at a 10 second rate.
- Long Term: the 1 hour rolling average, which is updated at a 10 minute rate.

The recommended limits for current and voltage harmonic distortion, expressed as a percentage of the fundamental, are listed in the following tables.

**Table 225 - IEEE 519 Current Distortion Limits (120 V...69 kV)**

Ratio of MAX_Isc to MAX_IL	Individual Harmonic Order						
		1 ... 10	11 ... 16	17 ... 22	23 ... 34	35 ... 40	TDD
Less than 20	Odd	4.0	2.0	1.5	0.6	0.3	5.0
	Even	1.0	0.5	0.4	0.2	0.1	
20 ... 49.99	Odd	7.0	3.5	2.5	1.0	0.5	8.0
	Even	1.8	0.9	0.6	0.3	0.1	
50 ... 99.99	Odd	10.0	4.5	4.0	1.5	0.7	12.0
	Even	2.5	1.1	1.0	0.4	0.2	
100 ... 999.99	Odd	12.0	5.5	5.0	2.0	1.0	15.0
	Even	3.0	1.4	1.3	0.5	0.3	
1000 and higher	Odd	15.0	7.0	6.0	2.5	1.5	20.0
	Even	3.8	1.8	1.5	0.6	0.4	

**Table 226 - IEEE 519 Voltage Distortion Limits (0...69 kV)**

Individual voltage distortion, %	Total voltage THD, %
3.0	5.0

## Application

This standard applies to the M6 and M8 models.

## Setup

Basic Metering setup is required. Three configuration parameters that are required for calculating the IEEE 519 Pass/Fail requirements are found in the Configuration.PowerQuality tab.

- IEEE519\_Compliance\_Parameter - Selects 0 = current (default) or 1 = voltage as the compliance parameter.
- IEEE519\_MAX\_Isc\_Amps - Short circuit current available at the PCC, in Amps. Default = 0
- IEEE519\_MAX\_IL\_Amps - Average current related to the maximum demand for the preceding 12 months. Default = 0

---

**IMPORTANT** Zero values for Max Isc and IL disable the calculation.

---

## IEEE 519 Pass/Fail Results

The PowerMonitor™ 5000 reports the IEEE 519 pass/fail status for short-term and long-term conditions in the [Status.Alarms](#) table in the tags that are listed. If the values of IEEE519\_MAX\_Isc\_Amps = 0 or IEEE519\_MAX\_IL\_Amps = 0, then the first row in [Table 225](#) IEEE 519 Current Distortion Limits is used to measure compliance. If the value of IEEE519\_MAX\_IL\_Amps = 0, then current THD rather than TDD is used to measure compliance.

## IEEE519\_Overall\_Status

This bitfield reports overall status.

- 0 = PASS
- 1 = FAIL
- Bit0 - ShortTerm\_TDD\_THD\_PASS\_FAIL
- Bit1 - LongTerm\_TDD\_THD\_PASS\_FAIL
- Bit2 - ShortTerm\_Individual\_Harmonic\_PASS\_FAIL
- Bit3 - LongTerm\_Individual\_Harmonic\_PASS\_FAIL
- Bit4 ... 15 - Future Use
- ShortTerm\_2nd\_To\_17th\_Harmonic\_Status
- LongTerm\_2nd\_To\_17th\_Harmonic\_Status

These bitfields reports the short-term or long-term status of harmonics of order 2...17.

- 0 = PASS
- 1 = FAIL
- Bit0 - 2nd\_Harmonic\_PASS\_FAIL
- Bit1 - 3rd\_Harmonic\_PASS\_FAIL
- ...
- Bit15 - 17th\_Harmonic\_PASS\_FAIL
- ShortTerm\_18th\_To\_33rd\_Harmonic\_Status
- LongTerm\_18th\_To\_33rd\_Harmonic\_Status

These bitfields reports the short-term or long-term status of harmonics of order 18...33.

- 0 = PASS
- 1 = FAIL
- Bit0 - 18th\_Harmonic\_PASS\_FAIL
- Bit1 - 19th\_Harmonic\_PASS\_FAIL
- ...
- Bit15 - 33rd\_Harmonic\_PASS\_FAIL
- ShortTerm\_34th\_To\_40th\_Harmonic\_Status
- LongTerm\_34th\_To\_40th\_Harmonic\_Status

These bitfields reports the short-term or long-term status of harmonics of order 34...40.

- 0 = PASS
- 1 = FAIL
- Bit0 - 34th\_Harmonic\_PASS\_FAIL
- Bit1 - 35th\_Harmonic\_PASS\_FAIL
- ...
- Bit6 - 40th\_Harmonic\_PASS\_FAIL
- Bit 7 ... Bit 15 - Reserved, always = 0

## IEEE 519 Short-Term and Long-Term Harmonic Results

The six data tables that are listed, provide an indication of individual current harmonic distortion and TDD (Total Demand Distortion). If you have selected voltage as the output parameter the tables list voltage distortions and THD (Total Harmonic Distortion).

- PowerQuality.IEEE519\_CH1\_ShortTerm\_Results
- PowerQuality.IEEE519\_CH2\_ShortTerm\_Results
- PowerQuality.IEEE519\_CH3\_ShortTerm\_Results
- PowerQuality.IEEE519\_CH1\_LongTerm\_Results
- PowerQuality.IEEE519\_CH2\_LongTerm\_Results
- PowerQuality.IEEE519\_CH3\_LongTerm\_Results

Each table provides the following:

- Timestamp of the most recent results
- Fundamental magnitude
- Individual harmonic distortion as a percentage of the fundamental magnitude
- Overall distortion
  - With current selected as the compliance parameter (default), if the IEEE519\_MAX\_Isc and IEEE519\_MAX\_IL parameter values are non-zero, then TDD is returned. Otherwise, THD is returned.

See the [PowerMonitor 5000 Unit Data Tables on page 269](#) for further details on these data tables.

### Related Functions

- Harmonic Analysis
- Alarm Log

## IEEE 1159 Power Quality Event Classification

### Power Quality Event Classification per IEEE 1159-2009

IEEE 1159-2009, Recommended Practice for Monitoring Electric Power Quality, categorizes various power quality events that are based on the parameters of the event such as voltage change, frequency content, rise time, and event duration. [Table 227](#), excerpted from the standard, summarizes the classifications in the recommended practice, and indicates which PowerMonitor™ 5000 models support monitoring of each category of phenomena.

**IMPORTANT** [Table 227](#) is adapted from standard IEEE 1159-2009 and is used with permission.

**Table 227 - Categories and Typical Characteristics of Power System Electromagnetic Phenomena<sup>(1)</sup>**

Categories	Typical Spectral Content	Typical Duration	Typical Voltage Magnitude	1426-M6	1426-M8
1.0 Transients					•
1.1 Impulsive					•
1.1.1 Nanosecond	5 ns rise	< 50 ns			
1.1.2 Microsecond	1 μs rise	50...1 ms			
1.1.3 Millisecond	0.1 ms rise	> 1 ms			•
1.2 Oscillatory					•
1.2.1 Low frequency	< 5 kHz	0.3...50 ms	0...4 pu <sup>(2)</sup>		•
1.2.2 Medium frequency	5...500 kHz	20 μs	0...8 pu		
1.2.3 High frequency	0.5...5 MHz	5 μs	0...4 pu		
2.0 Short-duration root-mean-square (rms) variations				•	•
2.1 Instantaneous				•	•
2.1.1 Sag		0.5...30 cycles	0.1...0.9 pu	•	•
2.1.2 Swell		0.5...30 cycles	1.1...1.8 pu	•	•
2.2 Momentary				•	•
2.2.1 Interruption		0.5 cycles - 3 s	< 0.1 pu	•	•
2.2.2 Sag		30 cycles - 3 s	0.1...0.9 pu	•	•
2.2.3 Swell		30 cycles - 3 s	1.1...1.4 pu	•	•
2.3 Temporary				•	•
2.3.1 Interruption		>3 s...1 min	< 0.1 pu	•	•
2.3.2 Sag		>3 s...1 min	0.1...0.9 pu	•	•
2.3.3 Swell		>3 s...1 min	1.1...1.2 pu	•	•
3.0 Long duration rms variations				•	•

**Table 227 - Categories and Typical Characteristics of Power System Electromagnetic Phenomena<sup>(1)</sup> (continued)**

Categories	Typical Spectral Content	Typical Duration	Typical Voltage Magnitude	1426-M6	1426-M8
3.1 Interruption, sustained		> 1 min	0.0 pu	•	•
3.2 Undervoltages		> 1 min	0.8...0.9 pu	•	•
3.3 Overvoltages		> 1 min	1.1...1.2 pu	•	•
3.4 Current overload		> 1 min			
4.0 Imbalance				•	•
4.1 Voltage		steady state	0.5...2%	•	•
4.2 Current		steady state	1.0...30%	•	•
5.0 Waveform distortion				•	•
5.1 DC offset		steady state	0...0.1%	•	•
5.2 Harmonics	0...9 kHz steady state	0...20%		•	•
5.3 Interharmonics	0...9 kHz steady state	0...2%			•
5.4 Notching		steady state			
5.5 Noise	broadband	steady state	0...1%		
6.0 Voltage fluctuations	< 25 Hz	intermittent	0.1...7%	•	•
0.2...2 Pstb				•	•
7.0 Power frequency variations		< 10 s	± 0.10 Hz	•	•

(1) These terms and categories apply to power quality measurements and are not to be confused with similar terms defined in IEEE Std 1366-2003 [B27] and other reliability-related standards, recommended practices, and guides.

(2) The quantity pu refers to per unit, which is dimensionless. The quantity 1.0 pu corresponds to 100%. The nominal condition is often considered to be 1.0 pu. In this table, the nominal peak value is used as the base for transients and the nominal rms value is used as the base for rms variations.

The power monitor classifies power quality events the unit detects according to the table. The M6 model does not detect events in categories 1, 5.3, 5.4, 5.5, or 6.

### Transients (Category 1.1.3, 1.2.1)(M8 model)

The PowerMonitor 5000 detects and records transient voltage events as described in IEEE 1159, Category 1.1.3, Impulsive, Millisecond and 1.2.1, Oscillatory, Low Frequency. The PowerMonitor 5000 does not detect events in Categories 1.1.1, 1.1.2, 1.2.2, and 1.2.3.

### Setup

Basic metering setup is required. The configuration parameter for transient detection is found in the [Configuration.PowerQuality](#) table.

- Transient\_Detection\_Threshold\_% - Percentage of the RMS value of the present cycle voltage, range 0 ... 50%, default 4%



## Operation

The power monitor detects a transient when the RMS value of the transient voltage is greater than a configurable sensitivity threshold.

When a transient is detected, the power monitor captures a waveform record. The number of cycles that are captured is equal to the configured Pre Event and Post Event cycles plus the transient waveform. The Power Quality Log records the event details, including date and time, the waveform reference, the transient threshold, and the RMS value of the transient voltage in the present cycle.

## Status

The [Status.Alarms](#) data table provides the following tag for monitoring of transient events.

- **Transient\_Indication** - sets when a transient has occurred; clears 90 seconds after the transient event has ended.

## Related Functions

- Waveform Recording
- Power Quality Log

## Short Duration RMS Variations (Category 2.0 - Sags, Swells, and Interruptions) (M6 and M8 model)

The power monitor detects and records instantaneous, momentary, and temporary variations in the RMS voltage.

## Setup

Basic metering configuration is required.

## Operation

A sag event begins when the rms value of the voltage dips to less than 90% of the system nominal voltage and ends when the voltage exceeds 92% of nominal.

A swell event is activated when the rms value of the voltage rises to greater than 110% of the nominal system voltage and released when the voltage drops back to 108% of nominal. An interruption event is recorded where the residual voltage is less than 10% of nominal.

The power monitor records each detected power quality event, date and time stamp, trip point, min or max value, and associated waveform record, as applicable, in the Power Quality Log with an event code of 'IEEE1159\_Voltage\_Sag', 'IEEE1159\_Voltage\_Swell' or 'IEEE1159\_Voltage\_Interruption'.

### Related Functions

- Long Duration RMS Variations
- Waveform Recording
- Power Quality Log

## Long Duration RMS Variations (Category 3.0 - Undervoltage, Overvoltage, Sustained Interruptions) (M6 and M8 model)

A sag or swell with a duration that exceeds one minute is classified as an undervoltage or overvoltage, respectively. An interruption with a duration that exceeds one minute is classified as a sustained interruption.

### Setup

The Sag and Swell thresholds that are described in the Short Duration RMS Variations section on [page 465](#) also determine the operation of undervoltage and overvoltage detection.

### Operation

When the duration of a sag or swell event exceeds 60 seconds, the new classification is recorded in the power quality log with the time stamp of the original sag or swell event, and the original sag or swell record in the power quality log is updated with a duration of 60 seconds and its associated waveform recording.

### Status

The [Status.Alarms Data Table](#) provides the following tags for monitoring of long duration rms variations.

- IEEE1159\_Over\_Voltage
- IEEE1159\_Over\_Voltage\_V1
- IEEE1159\_Over\_Voltage\_V2
- IEEE1159\_Over\_Voltage\_V3
- IEEE1159\_Under\_Voltage
- IEEE1159\_Under\_Voltage\_V1
- IEEE1159\_Under\_Voltage\_V2
- IEEE1159\_Under\_Voltage\_V3

The alarm flags are released when the condition no longer exists.

## Voltage and Current Imbalance (Category 4.0)

The power monitor includes long-term voltage and current unbalance in its metering results. The power monitor reports voltage and current imbalance as power quality events.

### Setup

Basic metering setup is required. These configuration parameters are found in the Configuration.PowerQuality tab:

- IEEE1159\_Imbalance\_Averaging\_Intvl\_m - rolling average interval for Imbalance, default 15 minutes
- IEEE1159\_Voltage\_Imbalance\_Limit\_% - percent of voltage imbalance to report an event, default 3 per cent.
- IEEE1159\_Current\_Imbalance\_Limit\_% - percent of current imbalance to report an event, default 25 per cent

### Operation

The power monitor calculates voltage and current imbalance over a rolling average with a configurable range of 15 minutes (default) to 60 minutes. The rolling average is updated at a rate of 10 seconds per minute of the specified interval.

When the rolling average value of voltage or current imbalance exceeds the configured limit, an event is recorded in the power quality log.

### Status

The [Status.Alarms](#) table provides the following tags for monitoring of unbalance events:

- IEEE1159\_Imbalance\_Condition\_Volts - 1 = unbalance is above the limit
- IEEE1159\_Imbalance\_Condition\_Current - 1 = unbalance is above the limit

## Waveform Distortion (Categories 5.1 - DC Offset, 5.2 - Harmonics, and 5.3 - Interharmonics)

The power monitor detects and reports long-term waveform distortion in excess of configured limits. [Table 14 on page 103](#) indicates which phenomena are supported by the PowerMonitor 5000 models.

### Setup

Basic metering setup required. These configuration parameters are found in the Configuration.PowerQuality tab:

- IEEE1159\_DCOffsetAndHarmonics\_Averaging\_Intvl\_m - rolling average interval for DC offset and harmonics, range = 1...15 minutes, default = 5 minutes
- IEEE1159\_Voltage\_DCOffset\_Limit\_% - DC offset alarm threshold, range = 0.00...1.00 per cent of fundamental, default = 0.1 per cent
- IEEE1159\_Voltage\_THD\_Limit\_% - voltage THD alarm threshold, range = 0.00...20.00 per cent of fundamental, default = 5 per cent
- IEEE1159\_Current\_THD\_Limit\_% - current THD alarm threshold, range = 0.00...20.00 per cent of fundamental, default = 10 per cent
- IEEE1159\_Voltage\_TID\_Limit\_% - voltage TID (total interharmonic distortion) alarm threshold, range = 0.00...20.00 per cent of fundamental, default = 5 per cent (M8 only)
- IEEE1159\_Current\_TID\_Limit\_% - voltage TID (total interharmonic distortion) alarm threshold, range = 0.00...20.00 per cent of fundamental, default = 10 per cent (M8 only)

### Operation

The power monitor measures voltage and current THD (and the M8 model measures TID), over the specified rolling average interval and annunciates if these values exceed the specified thresholds. The rolling average is updated at a rate of 10 seconds per minute of the specified interval.

The PowerMonitor 5000 unit does not measure current DC offset because CTs do not pass DC. DC offset is measured on directly connected voltage channels and is tracked in the power quality log.

## Status

These status bits annunciate over limit conditions and remain asserted until the parameter is no longer over the threshold. A value of 1 indicates over limit. They are found in the Status.Alarms tab.

- IEEE1159\_DCOffset\_Condition\_V1
- IEEE1159\_DCOffset\_Condition\_V2
- IEEE1159\_DCOffset\_Condition\_V3
- IEEE1159\_Voltage\_THD\_Condition\_V1
- IEEE1159\_Voltage\_THD\_Condition\_V2
- IEEE1159\_Voltage\_THD\_Condition\_V3
- IEEE1159\_Current\_THD\_Condition\_I1
- IEEE1159\_Current\_THD\_Condition\_I2
- IEEE1159\_Current\_THD\_Condition\_I3
- IEEE1159\_Current\_THD\_Condition\_I4
- IEEE1159\_Voltage\_TID\_Condition\_V1
- IEEE1159\_Voltage\_TID\_Condition\_V2
- IEEE1159\_Voltage\_TID\_Condition\_V3
- IEEE1159\_Current\_TID\_Condition\_I1
- IEEE1159\_Current\_TID\_Condition\_I2
- IEEE1159\_Current\_TID\_Condition\_I3
- IEEE1159\_Current\_TID\_Condition\_I4

## Related Functions

- Harmonic Analysis
- Power Quality Log

## Flicker (Voltage Fluctuations, Category 6.0)

Random or repetitive voltage fluctuations that typically do not exceed the normal range of system voltage can be caused by the switching of large loads at random times. The human effects of lamp flicker caused by such voltage fluctuations can vary from annoyance to epileptic seizures in sensitive individuals. The flicker severity index is proportional to the magnitude of voltage changes and, to a lesser degree, the frequency at which they occur.

IEEE 1159 addresses the short-term flicker severity index  $P_{st}$ . The power monitor also calculates the long-term index,  $P_{lt}$ .

## Setup

Basic metering setup is required. One configuration parameter for flicker is found in the [Configuration.PowerQuality](#) table.

- IEEE1159\_ShortTerm\_Severity - alarm threshold for flicker; range 0.2...4 P<sub>st</sub>, default 1

## Operation

The power monitor calculates the flicker severity index. When the configured limit is exceeded, an alarm status is set and a record is added to the Power Quality log. The values of P<sub>st</sub> and P<sub>It</sub> are also tracked in the Min/Max log.

## Status

The [Status.Alarms](#) data table provides the following tag for monitoring of short-term flicker events.

- IEEE1159\_ShortTerm\_Flicker\_Condition, set when P<sub>st</sub> exceeds the alarm threshold, clears when P<sub>st</sub> returns to normal

## Related Functions

- Min/Max Log
- Power Quality Log

## Power Frequency Variations (Category 7.0)

The power monitor detects and reports short-term power frequency variations in excess of configured limits.

## Setup

Basic metering setup is required. These configuration parameters are found in the [Configuration.PowerQuality](#) tab:

- IEEE1159\_PowerFrequency\_Averaging\_Intvl\_s - rolling average interval for power frequency, range = 1 (default)...10 seconds
- IEEE1159\_PowerFrequency\_Limit\_Hz - power frequency variation alarm threshold, range = 0.1 (default)...0.2 Hz
- IEEE1159\_PowerFrequency\_Hysteresis\_Hz -power frequency hysteresis, range = 0.01...0.05 Hz, default = 0.02 Hz

## Operation

The power monitor measures frequency variation over the specified rolling average interval and annunciates if the value exceeds the specified threshold. The rolling average updates once per second. The hysteresis parameter is considered when the alarm condition is released.

## Status

This status bit annunciates an over limit condition and remains asserted until the parameter is under the threshold less hysteresis. A value of 1 indicates over limit. The status bit is found in the Status.Alarms tab:

- IEEE1159\_PowerFrequency\_Condition

## Related Functions

- Basic Metering
- Power Quality Log

**Notes:**



## EN 50160 Conformance Tracking

### Introduction

EN 50160-2010 is a European standard that defines, describes, and specifies characteristics of voltage that is supplied in public power supply networks. The standard specifies limits on various attributes of the supply voltage, such as magnitude, frequency, and waveform quality, during normal operation. The PowerMonitor™ 5000 M8 model measures and stores data that track conformance to the requirements defined in the standard, for low-voltage (1000V or less) and medium-voltage (1...36 kV) systems.

EN 50160 conformance tracking data is measured according to requirements detailed in the accompanying standard EN 61000-4-30, further described in [Appendix I](#).

The power monitor tracks the following voltage supply parameters over defined intervals and reports each as described. Invalid intervals, in which a voltage interruption occurs, are flagged and excluded from the conformance results. Compliance criteria can differ depending on whether the system is low or medium voltage and whether the system has a synchronous connection to an interconnected system (the grid) or not (islanded). The compliance record lists each parameter and records the number of valid intervals where the parameter measured exceeded the specified compliance criteria.

### Setup

Basic metering setup is required. The power monitor selects EN 50160 conformance criteria that are based on the value of the Nominal\_System\_LL\_Voltage parameter in the [Configuration.Metering.Basic](#) table.

The [Configuration.PowerQuality](#) table includes another parameter that affects the selection of conformance criteria.

The PowerFrequency\_Synchronization tag indicates the synchronization status of the metering system. The choices include the following:

- 0 = Synchronous connection to an interconnected system default
- 1 = Not synchronous to an interconnected system (islanded)

## Operation

This section describes how the power monitor measures EN 50160 conformance.

### Power Frequency

The mean fundamental frequency is measured in each valid 10 second interval. The following are the conforming ranges for these measurements in low- and medium-voltage systems:

#### *Synchronously Connected*

- Range 1: 50 Hz  $\pm$  1% during 99.5% of a year
- Range 2: 50 Hz + 4% / - 6% during 100% of the time

#### *Not Synchronously Connected*

- Range 1: 50 Hz  $\pm$  2% during 95% of each week
- Range 2: 50 Hz  $\pm$  15% during 100% of the time

### Supply Voltage Variations (low-voltage systems)

The mean rms supply voltage is measured in each valid 10 minute interval. The following are the confirming ranges for these measurements in low-voltage systems:

#### *Synchronously Connected*

- Range 1: within  $\pm$  10% of nominal during 95% of each week
- Range 2: within + 10% / - 15% of nominal during 100% of the time

#### *Not Synchronously Connected*

- Within + 10% / - 15% of nominal during 100% of the time

### Supply Voltage Variations (medium-voltage systems)

The following are the conforming ranges for these measurements in medium-voltage systems:

#### *Synchronously Connected*

- Range 1: within  $\pm$  10% of nominal during 99% of each week
- Range 2: within + 15% / - 15% of nominal during 100% of the time

#### *Not Synchronously Connected*

- Within + 10% / - 15% of nominal during 100% of the time

## Rapid Voltage Changes

Long-time flicker severity  $P_{lt}$  is measured over each 2-hour interval. The following is the conformance specification for these measurements in low- and medium-voltage systems:

- $P_{lt}$  must be less than or equal to 1 for 95% of each week

## Supply Voltage Unbalance

Mean rms values of fundamental positive and negative sequence voltages are measured each valid 10 minute interval. The following is the conformance specification for these measurements in low- and medium-voltage systems:

- Negative sequence voltage within the range 0...2% of the positive sequence voltage for 95% of each week

## Harmonic Voltage

Mean rms values of each harmonic voltage are measured each valid 10 minute interval. The following is the conformance specification for these measurements in low-voltage systems:

- Harmonic voltage is less than or equal to the values listed in [Table 228](#) (low-voltage) or [Table 229](#) (medium-voltage) for 95% of each week
- Voltage THD including harmonics up to the 40th order is less than or equal to 8%

**Table 228 - Values of Individual Harmonic Voltages at the Supply Terminals for Orders up to 25<sup>(1)</sup> Given in Percent of the Fundamental Voltage  $u_1$ , Low-voltage Systems**

Odd Harmonics				Even Harmonics	
Not Multiples of 3		Multiples of 3			
Order h	Relative Amplitude $U_h$	Order h	Relative Amplitude $U_h$	Order h	Relative Amplitude $U_h$
5	6.0%	3	5.0%	2	2.0%
7	5.0%	9	1.5%	4	1.0%
11	3.5%	15	0.5%	6...24	0.5%
13	3.0%	21	0.5%		
17	2.0%				
19	1.5%				
23	1.5%				
25	1.5%				

(1) No values are given for harmonics of order higher than 25, as they are usually small, but largely unpredictable due to resonance effects.

**Table 229 - Values of Individual Harmonic Voltages at the Supply Terminals for Orders up to 25<sup>(1)</sup> Given in Percent of the Fundamental Voltage u<sub>1</sub>, Medium-voltage Systems**

Odd Harmonics				Even Harmonics	
Not Multiples of 3		Multiples of 3			
Order h	Relative Amplitude U <sub>h</sub>	Order h	Relative Amplitude U <sub>h</sub>	Order h	Relative Amplitude U <sub>h</sub>
5	6.0%	3	5.0% <sup>(2)</sup>	2	2.0%
7	5.0%	9	1.5%	4	1.0%
11	3.5%	15	0.5%	6...24	0.5%
13	3.0%	21	0.5%		
17	2.0%				
19	1.5%				
23	1.5%				
25	1.5%				

(1) No values are given for harmonics of order higher than 25, as they are usually small, but largely unpredictable due to resonance effects.

(2) Depending on the network design, the value for the third harmonic order can be substantially lower.

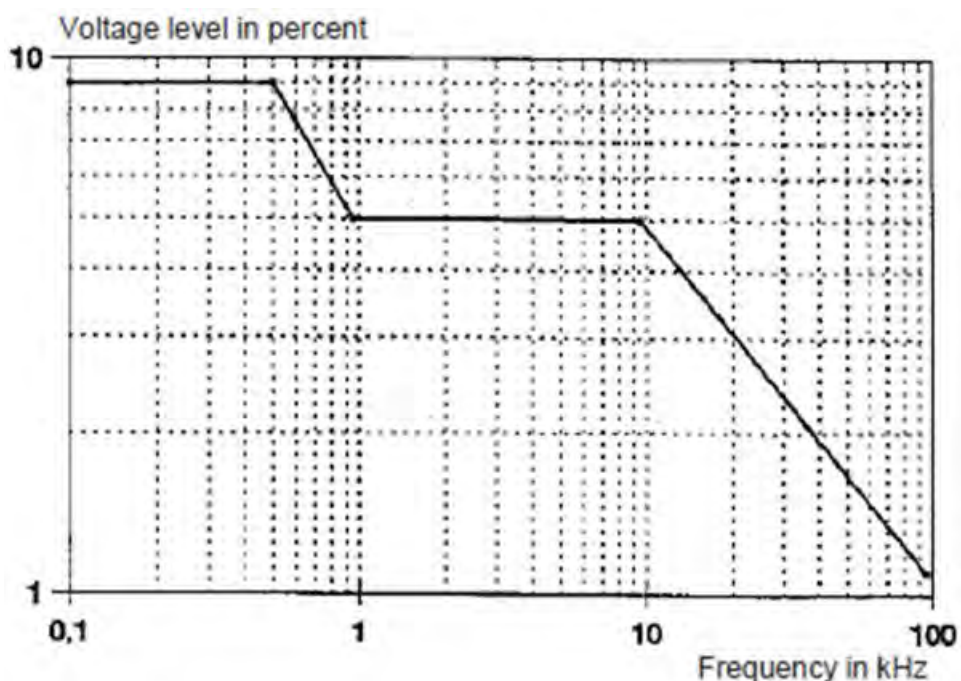
### Interharmonic Voltages

Conformance criteria for interharmonic voltages are under consideration by the standards development organization.

### Mains Signaling Voltages

The mean value of mains signaling voltage at the user-configured frequency is measured in each 3 second interval. The following is the conformance specification for these measurements:

- Signal voltage is less than or equal to the values shown in [Figure 52](#) for 99 percent of each day

**Figure 52 - Voltage Levels of Signal Frequencies in Percent of Nominal Voltage UnUsed in Public Networks**

### Voltage Dips (sags)

The power monitor records voltage dips when the line-to-neutral voltage (for Wye and split-phase metering modes) or line-to-line voltage (for Delta systems) drops below 90% of its nominal value. The duration and residual voltage (the minimum value during the event) are used to classify voltage dips by using the categories shown in [Table 230](#).

**Table 230 - Classification of Dips According to Residual Voltage and Duration**

Residual Voltage, $u$ %	Duration, $t$ ms				
	$10 \leq t \leq 200$	$200 < t \leq 500$	$500 < t \leq 1000$	$1000 < t \leq 5000$	$5000 < t \leq 60,000$
$90 > u \geq 80$	Cell A1	Cell A2	Cell A3	Cell A4	Cell A5
$80 > u \geq 70$	Cell B1	Cell B2	Cell B3	Cell B4	Cell B5
$70 > u \geq 40$	Cell C1	Cell C2	Cell C3	Cell C4	Cell C5
$40 > u \geq 5$	Cell D1	Cell D2	Cell D3	Cell D4	Cell D5
$5 > u$	Cell X1	Cell X2	Cell X3	Cell X4	Cell X5

## Voltage Swells

The power monitor records voltage swells when the line-to-neutral voltage (for Wye and split-phase metering modes) or line-to-line voltage (for Delta systems) exceeds 110% of its nominal value. The duration and swell voltage (the maximum value during the event) are used to classify voltage swells by using the categories shown in [Table 231](#).

**Table 231 - Classification of Swells According to Maximum Voltage and Duration**

Swell Voltage, $u$ %	Duration, $t$ ms		
	$10 \leq t \leq 500$	$500 < t \leq 5000$	$500 < t \leq 60,000$
$u \geq 120$	Cell S1	Cell S2	Cell S3
$120 > u > 110$	Cell T1	Cell T2	Cell T3

## Transient Overvoltages

Conformance criteria for transient overvoltages are not specified in the standard.

## Results

This section explains the results of EN 50160 conformance tracking.

### EN 50160 Compliance Record

The [PowerQuality.EN50160\\_Compliance\\_Results Data Table](#) contains a summary of conformance with EN 50160 compliance criteria. This table aggregates the data that is logged in completed records in the EN 50160 weekly and yearly logs. No in-process weekly or yearly log records are aggregated into the compliance record. The content of the compliance record is shown in [Table 232](#).

**Table 232 - EN50160\_Compliance\_Results Table**

Tag Name	Description
Mains Signaling Voltage	Updated once per day from previous day's data
Supply Voltage Range 1	Aggregated result from weekly log
Supply Voltage Range 2	
Flicker Severity Plt	
Supply Voltage Unbalance	
Individual Harmonic Voltage	
Voltage THD	
Power Frequency Range 1	Synchronous is yearly aggregation; Non-synchronous is weekly aggregation
Power Frequency Range 2	
Sag 90% u...80% u, 10...200 ms Duration	
	Aggregated from yearly log: Number of sag events, cell A1 (1)

**Table 232 - EN50160\_Combpliance\_Results Table (continued)**

Tag Name	Description
Sag 90...80% u, 200...500 mS Duration	Cell A2
Sag 90...80% u, 500...1000 mS Duration	Cell A3
Sag 90...80% u, 1000...5000 mS Duration	Cell A4
Sag 90...80% u, 5000...60000 mS Duration	Cell A5
Sag 80...70% u, 10...200 mS Duration	Cell B1
Sag 80...70% u, 200...500 mS Duration	Cell B2
Sag 80...70% u, 500...1000 mS Duration	Cell B3
Sag 80...70% u, 1000...5000 mS Duration	Cell B4
Sag 80...70% u, 5000...60000 mS Duration	Cell B5
Sag 70...40% u, 10...200 mS Duration	Cell C1
Sag 70...40% u, 200...500 mS Duration	Cell C2
Sag 70...40% u, 500...1000 mS Duration	Cell C3
Sag 70...40% u, 1000...5000 mS Duration	Cell C4
Sag 70...40% u, 5000...60000 mS Duration	Cell C5
Sag 40...5% u, 10...200 mS Duration	Cell D1
Sag 40...5% u, 200...500 mS Duration	Cell D2
Sag 40...5% u, 500...1000 mS Duration	Cell D3
Sag 40...5% u, 1000...5000 mS Duration	Cell D4
Sag 40...5% u, 5000...60000 mS Duration	Cell D5
Sag less than 5% u, 10...200 mS Duration	Cell X1
Sag less than 5% u, 200...500 mS Duration	Cell X2
Sag less than 5% u, 50...1000 mS Duration	Cell X3
Sag less than 5% u, 1000...5000 mS Duration	Cell X4
Sag less than 5% u, 5000...60000 mS Duration	Cell X5
Swell 120% u or greater, 10...500 mS Duration	Number of swell events, Cell S1
Swell 120% u or greater, 500...5000 mS Duration	Cell S2
Swell 120% u or greater, 5000...60000 mS Duration	Cell S3
Swell 120...110% u, 10...500 mS Duration	Cell T1
Swell 120...110% u, 500...5000 mS Duration	Cell T2
Swell 120...110% u, 5000...60000 mS Duration	Cell T3

(1) Cell numbers see [Table 230](#) and [Table 231](#).

## Weekly Conformance Log

The power monitor logs the following parameters in a weekly log. The parameters and their conformance criteria are described in [Operation on page 474](#). The log contains eight records; record 1 being the current in-process day and records 2...8 the completed records for the previous week. Records roll over at midnight local time each day, at which time the oldest record is discarded and the completed records are aggregated and written to the compliance record. The records in the EN 50160 weekly log are expressed in percent of valid intervals that are compliant with the conformance specifications. The number of valid intervals of each duration, is also listed.

**Table 233 - EN50160 Weekly Log**

Tag Name	Description	Unit
Record_Number	Record 1 is the current in-process record; 2 . . . 8 are the completed records from the prior week.	#
Log_Date	The date this record was started.	YYMMDD
Supply Voltage Range 1	Percent of valid intervals during which the parameter was within the specified range.	%
Supply Voltage Range 2		%
Flicker Severity Plt		%
Supply Voltage Unbalance		%
Individual Harmonic Voltage		%
Voltage THD		%
Non-Synchronous Power Freq. Range 1		(1)
Non-Synchronous Power Freq. Range 2	%	
10_Minutes_Valid_Data_Counts	Number of valid intervals during 1 day. Valid interval is one without a voltage dip, swell, or interruption.	#
2_Hours_Valid_Data_Counts		#
10_Seconds_Valid_Data_Counts		#

(1) Synchronous Power Frequency is assigned the value of zero if the PowerFrequency\_Synchronization tag value = 0, synchronized.

## Yearly Conformance Log

The power monitor logs the following parameters in a yearly log. The parameters and their conformance criteria are described in [Operation on page 474](#). The log contains 13 records; record 1 being an in-process record for the current month and records 2...13 the completed records for the previous year. Records roll over at midnight local time the last day of each month, at which time the oldest record is discarded and the completed records are aggregated and written to the compliance record. The records in the EN 50160 yearly log are expressed in percent of valid intervals that are compliant with the conformance specifications or as counts of events. The number of valid 10 second intervals is also listed.



**Table 234 - EN50160 Yearly Log**

Tag Name	Description	Unit
Record_Number	Record 1 is the current in-process record; 2...13 are the prior 12 months	#
Log_Start_Date	The Date this record was started	YYMMDD
Log_End_Date	The Date this record was ended	YYMMDD
Synchronous Power Frequency Range 1	Percent of valid intervals during which the parameter was within the specified range <sup>(1)</sup>	%
Synchronous Power Frequency Range 2		%
Sag 90...80% u, 10...200 mS Duration	Number of sag events, cell A1 <sup>(2)</sup>	#
Sag 90...80% u, 200...500 mS Duration	Cell A2	#
Sag 90...80% u, 500...1000 mS Duration	Cell A3	#
Sag 90...80% u, 1000...5000 mS Duration	Cell A4	#
Sag 90...80% u, 5000...60000 mS Duration	Cell A5	#
Sag 80...70% u, 10...200 mS Duration	Cell B1	#
Sag 80...70% u, 200...500 mS Duration	Cell B2	#
Sag 80...70% u, 500...1000 mS Duration	Cell B3	#
Sag 80...70% u, 1000...5000 mS Duration	Cell B4	#
Sag 80...70% u, 5000...60000 mS Duration	Cell B5	#
Sag 70...40% u, 10...200 mS Duration	Cell C1	#
Sag 70...40% u, 200...500 mS Duration	Cell C2	#
Sag 70...40% u, 500...1000 mS Duration	Cell C3	#
Sag 70...40% u, 1000...5000 mS Duration	Cell C4	#
Sag 70...40% u, 5000...60000 mS Duration	Cell C5	#
Sag 40...5% u, 10...200 mS Duration	Cell D1	#
Sag 40...5% u, 200...500 mS Duration	Cell D2	#
Sag 40...5% u, 500...1000 mS Duration	Cell D3	#
Sag 40...5% u, 1000...5000 mS Duration	Cell D4	#
Sag 40...5% u, 5000...60000 mS Duration	Cell D5	#
Sag less than 5% u, 10...200 mS Duration	Cell X1	#
Sag less than 5% u, 200...500 mS Duration	Cell X2	#
Sag less than 5% u, 500...1000 mS Duration	Cell X3	#
Sag less than 5% u, 1000...5000 mS Duration	Cell X4	#
Sag less than 5% u, 5000...60000 mS Duration	Cell X5	#
Swell 120% u or greater, 10...500 mS Duration	Number of swell events, Cell S1	#
Swell 120% u or greater, 500...5000 mS Duration	Cell S2	#
Swell 120% u or greater, 5000...60000 mS Duration	Cell S3	#
Swell 120...110% u, 10...500 mS Duration	Cell T1	#
Swell 120...110% u, 500...5000 mS Duration	Cell T2	#
Swell 120...110% u, 5000...60000 mS Duration	Cell T3	#
10_Seconds_Valid_Data_Counts	Number of valid 10 second intervals <sup>(1)</sup>	#

(1) Synchronous Power Frequency and 10 second valid data counts are assigned the value of zero if the PowerFrequency\_Synchronization tag value = 1, islanded.

(2) Cell numbers see [Table 230](#) and [Table 231](#).

**Notes:**

## EN 61000-4-30 Metering and Aggregation

### Introduction

EN 61000-4-30 is an international standard that defines methods for measurement and interpretation of results for power quality parameters in AC power systems.

Class A defines requirements for precise measurements of power quality parameters. Measurement methods are defined for each identified power quality parameter so that measurements of parameters by different instruments agree within the specified uncertainty. Class S defines a less rigorous set of requirements, typically used for surveys or power quality assessment. Class B is also included in the standard to permit legacy instruments from becoming obsolete.

The standard also defines requirements for time aggregation of measurements. The basic interval of measurement is 10 cycles for 50 Hz and 12 cycles for 60 Hz, or 200 mS. Measurements that are made at the basic 10/12 Hz rate can then be aggregated into 150/180 Hz (3 second), 10 minute, and 2-hour times, depending on the parameter. Class A and class S requirements for aggregation differ in how intervals of different lengths are kept in synchronization and whether gaps in the basic 10/12 cycle data are permitted.

### Metering Class Designation

The PowerMonitor™ 5000 M8 model conforms to class A and class S requirements as indicated in [Table 235](#).

**Table 235 - EN 61000-4-30 Class Designations (M8 model only)**

61000-4-30 Section Power Quality Parameter	Power Monitor 5000 Class Designation		Remarks
	Metering	Aggregation	
5.1 Power frequency	A	S	
5.2 Magnitude of the supply voltage	A	S	
5.3 Flicker	A	S	Pst range 0.1 . . . 12
5.4 Supply voltage dips and swells	A		
5.5 Voltage interruptions	A		
5.7 Supply voltage unbalance	A	S	
5.8 Voltage harmonics	A	S	
5.9 Voltage interharmonics	A	S	
5.10 Mains signaling voltage	A		
5.12 Underdeviation and overdeviation	A	S	

**Table 235 - EN 61000-4-30 Class Designations (M8 model only) (continued)**

61000-4-30 Section Power Quality Parameter	Power Monitor 5000 Class Designation		Remarks
	Metering	Aggregation	
4.4 Measurement aggregation intervals		S	
4.6 Real-time-clock uncertainty	A w/external sync, S with internal RTC		
4.7 Flagging	Yes		
6.1 Transient influence quantities	Yes		

Measurements can be made in accordance to EN 61000-4-30 requirements on AC 50 Hz or 60 Hz power systems in any metering mode that is supported by the power monitor. Line-to-neutral voltage measurements are only reported in Wye, Split-phase, and Delta hi-leg metering modes.

### Data Flagging

Data flagging is performed to avoid unreliable measurements being produced during a metering interval in which a voltage dip, swell, or interruption occurs and to avoid counting an event in multiple categories as a result. Data flagging applies to individual basic metering intervals as well as to intervals into which the flagged basic interval is aggregated. Data flagging is used in the reporting of results in EN 50160 conformance tracking, [Appendix H](#).

## Power Quality Parameters

The following sections summarize the measurement, accuracy, and time aggregation of each power quality parameter addressed by the standard. Accuracy is expressed as ‘measurement uncertainty’ in the standard.

Measurement uncertainty is specified over a measuring range that is expressed as a function of  $U_{din}$ , the declared input voltage, and in the presence of influence quantities that can vary within a specified range. The power monitor has a  $U_{din}$  of 690V rms line-to-line. [Table 236](#) lists the influence quantities and their permitted ranges.

**Table 236 - Influence Quantity Range<sup>(1) (2)</sup>**

Section and Parameter	Class	Influence Quantity Range
5.1 Frequency	A	42.5...57.5 Hz, 51...69 Hz
	S	42.5...57.5 Hz, 51...69 Hz
	B	42.5...57.5 Hz, 51...69 Hz
5.2 Magnitude of the supply	A	10...200 % $U_{din}$
	S	10...150 % $U_{din}$
	B	10...150 % $U_{din}$
5.3 Flicker	A	0...20 $P_{st}$
	S	0...10 $P_{st}$
	B	Not applicable

**Table 236 - Influence Quantity Range<sup>(1) (2)</sup> (continued)**

Section and Parameter	Class	Influence Quantity Range
5.4 Dips and swells	A	N/A
	S	N/A
	B	N/A
5.5 Interruptions	A	N/A
	S	N/A
	B	N/A
5.7 Unbalance	A	$0 \dots 5\% U_2, 0 \dots 5\% U_0$
	S	$0 \dots 5\% U_2$
	B	Specified by manufacturer
5.8 Voltage harmonics	A	200% of class 3 of IEC 61000-2-4
	S	200% of class 3 of IEC 61000-2-4
	B	200% of class 3 of IEC 61000-2-4
5.9 Voltage interharmonics	A	200% of class 3 of IEC 61000-2-4
	S	200% of class 3 of IEC 61000-2-4
	B	200% of class 3 of IEC 61000-2-4
5.10 Mains signaling voltage	A	$0 \dots 15\% U_{din}$
	S	$0 \dots 15\% U_{din}$
	B	$0 \dots 15\% U_{din}$
5.12 Under/overdeviation	A	N/A
	S	N/A
	B	N/A
Transient voltages IEC 61180	A	6 kV peak
	S	N/A
	B	N/A
Fast transients IEC 61000-4-4	A	4 kV peak
	S	N/A
	B	N/A

(1) Copyright by IEC. Used with permission.

(2) For safety requirements, EMC requirements, or climatic requirements, see product standards, for example, IEC 61557-12.

In general, only basic metering setup is required, except as noted otherwise in the sections that follow.

## Power Frequency

The fundamental power frequency is measured at 10 second intervals. Measurement uncertainty must not exceed  $\pm 50$  mHz over the measuring ranges 42.5...57.5 Hz / 51...69 Hz. Frequency is detected on any voltage or current channel with a signal higher than the channel metering threshold, which is selected in the following order: V1, V2, V3, VN, I1, I2, I3, and I4. Results are reported in the [PowerQuality.EN61000\\_4\\_30\\_Aggregation Data Table](#).

## Magnitude of the Supply Voltage

Voltage is measured at the basic 10/12 Hz metering rate and is time aggregated into 3 second, 10 minute, and 2-hour times. Measurement uncertainty must not exceed  $\pm 0.1\%$  of  $U_{din}$ , over the range of 10...150 % of  $U_{din}$ . The 10/12 Hz results are reported in the [MeteringResults.EN61000\\_4\\_30\\_VIP](#) table, and aggregated results in the [PowerQuality.EN61000\\_4\\_30\\_Aggregation Data Table](#).

## Flicker

Flicker related to voltage fluctuations is measured in accordance with IEC 61000-4-15. Measurement uncertainty (accuracy required by IEC 61000-4-15:  $\pm 8\%$  of one unit of perceptibility) must be met over the measuring range of 0.2...10  $P_{st}$ . Flicker is measured on voltage channels 1, 2, and 3. Short-term  $P_{st}$  results aggregated over 10 minutes, and long-term  $P_{lt}$  results aggregated over 2 hours, are reported in the [PowerQuality.EN61000\\_4\\_30\\_Aggregation Data Table](#).

## Supply Voltage Dips

Voltage dips, or sags, are detected for each voltage channel when the  $\frac{1}{2}$  cycle rms voltage falls below the dip threshold. Dips are characterized by their threshold, duration, and residual voltage.

- The power monitor uses a fixed dip threshold of 90% of nominal system voltage for EN 61000-4-30 voltage dip detection.
- The duration of a dip begins when the  $\frac{1}{2}$  cycle rms voltage falls below the dip threshold and ends when the rms voltage is equal to or greater than the dip threshold plus the hysteresis voltage, which is fixed at 2% of nominal system voltage.
- The residual voltage is the minimum rms voltage that is measured during the event and its measurement uncertainty must not exceed  $\pm 0.2\%$  of  $U_{din}$ .

The start date/time, duration, and residual voltage of voltage dips are logged in the Power Quality log and tracked in the EN 50160 yearly log and compliance record. Time aggregation is not applicable to voltage dips.

## Supply Voltage Swells

Voltage swells are detected for each voltage channel when the ½ cycle rms voltage rises above the swell threshold. Swells are characterized by their threshold, duration, and swell voltage.

- The power monitor uses a fixed swell threshold of 110% of nominal system voltage for EN 61000-4-30 voltage swell detection.
- The duration of a swell begins when the ½ cycle rms voltage rises above the swell threshold and ends when the rms voltage is equal to or less than the swell threshold less the hysteresis voltage, which is fixed at 2% of nominal system voltage. The measurement uncertainty of the duration cannot exceed the length of one cycle.
- The swell voltage is the maximum rms voltage that is measured during the event and its measurement uncertainty must not exceed  $\pm 0.2\%$  of  $U_{din}$ .

The start date/time, duration, and swell voltage of voltage swells are logged in the Power Quality log and tracked in the EN 50160 yearly log and compliance record. Time aggregation is not applicable to voltage swells.

**TIP** You can also set up user-configurable sag and swell detection in the PowerMonitor 5000 M6 and M8 models. See [Sag and Swell Detection on page 102](#).

**TIP** EN 61000-4-30 also provides for a sliding reference voltage for sags and swells. The PowerMonitor 5000 M6 and M8 models provide for sags and swells in their setpoint functionality. See [Setpoints on page 191](#).

## Voltage Interruptions

Voltage interruptions are detected for each voltage channel when the ½ cycle rms voltage on all voltage channels falls below the interruption threshold. Voltage interruptions are characterized by their threshold and duration.

- The power monitor uses a fixed interruption threshold of 5% of nominal system voltage for EN 61000-4-30 voltage dip detection.
- The duration of a dip begins when the ½ cycle rms voltage on all voltage channels falls below the dip threshold and ends when any channel rms voltage is equal to or greater than the interruption threshold plus the hysteresis voltage, which is fixed at 2% of nominal system voltage.

If the power monitor has a separate source of control power, the start date/time and duration voltage interruptions are logged in the Power Quality log and tracked in the EN 50160 yearly log and compliance record. Time aggregation is not applicable to voltage interruptions.

**TIP** You can also set up user-configurable voltage interruption detection in the PowerMonitor 5000 M6 and M8 models. See [Sag and Swell Detection on page 102](#).

## Supply Voltage Unbalance

Supply voltage unbalance is evaluated by using the method of symmetrical components, at the basic 10/12 cycle metering rate, and by using filtering to minimize the effects of harmonics. Measurement uncertainty must be less than  $\pm 0.15\%$  of both negative sequence ratio and zero-sequence ratio.

The 10/12 cycle results of positive, negative, and zero-sequence component values on all voltage and current channels, and the 10/12 cycle results of voltage and current percent unbalance, are returned in the [PowerQuality.EN61000\\_4\\_30\\_Sequence Data Table](#). Three-second, 10 minute, and 2-hour time aggregations of voltage unbalance are returned in the [PowerQuality.EN61000\\_4\\_30\\_Aggregation Data Table](#).

## Voltage Harmonics and Interharmonics

Harmonic and Interharmonic groups are measured by using the requirements of IEC 61000-4-7, at the basic 10/12 cycle metering rate. Measurement accuracy is specified as follows:

- For voltage and current harmonics, the measurement uncertainty is no greater than  $\pm 1\%$  of the measured fundamental voltage or current.
- The phase shift between individual channels must be less than  $h \cdot 1^\circ$ .

The PowerMonitor 5000 M8 model provides the following sets of harmonic measurements in accordance with EN 61000-4-30.

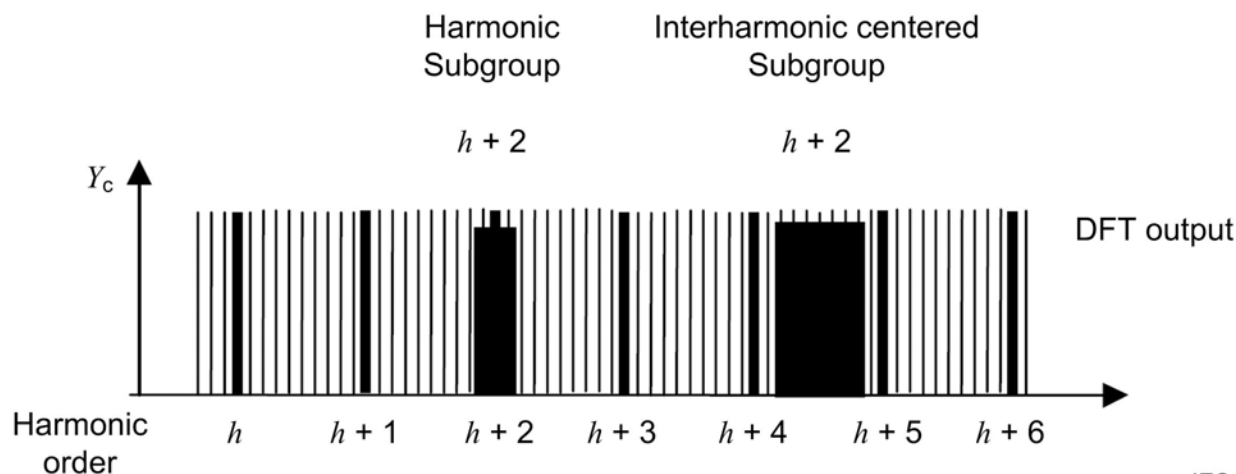
- 10/12 cycle voltage and current IEEE and IEC THD, crest factor, and K-factor, in the following data table:
  - [PowerQuality.EN61000\\_4\\_30\\_THD \(M8 only\)](#)
- 10/12 cycle THD voltage THD of harmonic (THDS) and interharmonic (TIHDS) subgroups, in the following data table:
  - [PowerQuality.EN61000\\_4\\_30\\_HSG \(M8 only\)](#)
- Harmonic subgroup up to the 50th harmonic for voltage and current updated every 10/12 cycles (200 mS). These results are reported in the following data tables:
  - PowerQuality.200mS\_V1\_N\_Volts\_RMS\_HDS
  - PowerQuality.200mS\_V2\_N\_Volts\_RMS\_HDS
  - PowerQuality.200mS\_V3\_N\_Volts\_RMS\_HDS
  - PowerQuality.200mS\_VN\_G\_Volts\_RMS\_HDS
  - PowerQuality.200mS\_V1\_V2\_Volts\_RMS\_HDS
  - PowerQuality.200mS\_V2\_V3\_Volts\_RMS\_HDS



- PowerQuality.200mS\_V3\_V1\_Volts\_RMS\_HDS
- PowerQuality.200mS\_I1\_Amps\_RMS\_HDS
- PowerQuality.200mS\_I2\_Amps\_RMS\_HDS
- PowerQuality.200mS\_I3\_Amps\_RMS\_HDS
- PowerQuality.200mS\_I4\_Amps\_RMS\_HDS
- Interharmonic centered subgroup up to the 50th harmonic for voltage and current updated every 10/12 cycles (200mS). These results are reported in the following data tables:
  - PowerQuality.200mS\_V1\_N\_Volts\_RMS\_IHDS
  - PowerQuality.200mS\_V2\_N\_Volts\_RMS\_IHDS
  - PowerQuality.200mS\_V3\_N\_Volts\_RMS\_IHDS
  - PowerQuality.200mS\_VN\_G\_Volts\_RMS\_IHDS
  - PowerQuality.200mS\_V1\_V2\_Volts\_RMS\_IHDS
  - PowerQuality.200mS\_V2\_V3\_Volts\_RMS\_IHDS
  - PowerQuality.200mS\_V3\_V1\_Volts\_RMS\_IHDS
  - PowerQuality.200mS\_I1\_Amps\_RMS\_IHDS
  - PowerQuality.200mS\_I2\_Amps\_RMS\_IHDS
  - PowerQuality.200mS\_I3\_Amps\_RMS\_IHDS
  - PowerQuality.200mS\_I4\_Amps\_RMS\_IHDS
- Harmonic subgroup up to the 50th harmonic for voltage aggregated over 3 seconds (150/180 cycles). These results are reported in the following data tables:
  - PowerQuality.3s\_V1\_N\_Volts\_RMS\_HDS
  - PowerQuality.3s\_V2\_N\_Volts\_RMS\_HDS
  - PowerQuality.3s\_V3\_N\_Volts\_RMS\_HDS
  - PowerQuality.3s\_VN\_G\_Volts\_RMS\_HDS
  - PowerQuality.3s\_V1\_V2\_Volts\_RMS\_HDS
  - PowerQuality.3s\_V2\_V3\_Volts\_RMS\_HDS
  - PowerQuality.3s\_V3\_V1\_Volts\_RMS\_HDS
- Interharmonic centered subgroup up to the 50th harmonic for voltage aggregated over 3 seconds (150/180 cycles). These results are reported in the following data tables:
  - PowerQuality.3s\_V1\_N\_Volts\_RMS\_IHDS
  - PowerQuality.3s\_V2\_N\_Volts\_RMS\_IHDS
  - PowerQuality.3s\_V3\_N\_Volts\_RMS\_IHDS
  - PowerQuality.3s\_VN\_G\_Volts\_RMS\_IHDS
  - PowerQuality.3s\_V1\_V2\_Volts\_RMS\_IHDS
  - PowerQuality.3s\_V2\_V3\_Volts\_RMS\_IHDS
  - PowerQuality.3s\_V3\_V1\_Volts\_RMS\_IHDS

- Harmonic subgroup up to the 50th harmonic for voltage aggregated over 10 minutes. These results are reported in the following data tables:
  - PowerQuality.10m\_V1\_N\_Volts\_RMS\_HDS
  - PowerQuality.10m\_V2\_N\_Volts\_RMS\_HDS
  - PowerQuality.10m\_V3\_N\_Volts\_RMS\_HDS
  - PowerQuality.10m\_VN\_G\_Volts\_RMS\_HDS
  - PowerQuality.10m\_V1\_V2\_Volts\_RMS\_HDS
  - PowerQuality.10m\_V2\_V3\_Volts\_RMS\_HDS
  - PowerQuality.10m\_V3\_V1\_Volts\_RMS\_HDS
- Interharmonic centered subgroup up to the 50th harmonic for voltage aggregated over 10 minutes. These results are reported in the following data tables:
  - PowerQuality.10m\_V1\_N\_Volts\_RMS\_IHDS
  - PowerQuality.10m\_V2\_N\_Volts\_RMS\_IHDS
  - PowerQuality.10m\_V3\_N\_Volts\_RMS\_IHDS
  - PowerQuality.10m\_VN\_G\_Volts\_RMS\_IHDS
  - PowerQuality.10m\_V1\_V2\_Volts\_RMS\_IHDS
  - PowerQuality.10m\_V2\_V3\_Volts\_RMS\_IHDS
  - PowerQuality.10m\_V3\_V1\_Volts\_RMS\_IHDS
- Harmonic subgroup up to the 50th harmonic for voltage aggregated over 2 hours. These results are reported in the following data tables:
  - PowerQuality.2h\_V1\_N\_Volts\_RMS\_HDS
  - PowerQuality.2h\_V2\_N\_Volts\_RMS\_HDS
  - PowerQuality.2h\_V3\_N\_Volts\_RMS\_HDS
  - PowerQuality.2h\_VN\_G\_Volts\_RMS\_HDS
  - PowerQuality.2h\_V1\_V2\_Volts\_RMS\_HDS
  - PowerQuality.2h\_V2\_V3\_Volts\_RMS\_HDS
  - PowerQuality.2h\_V3\_V1\_Volts\_RMS\_HDS
- Interharmonic centered subgroup up to the 50th harmonic for voltage aggregated over 2 hours. These results are reported in the following data tables:
  - PowerQuality.2h\_V1\_N\_Volts\_RMS\_IHDS
  - PowerQuality.2h\_V2\_N\_Volts\_RMS\_IHDS
  - PowerQuality.2h\_V3\_N\_Volts\_RMS\_IHDS
  - PowerQuality.2h\_VN\_G\_Volts\_RMS\_IHDS
  - PowerQuality.2h\_V1\_V2\_Volts\_RMS\_IHDS
  - PowerQuality.2h\_V2\_V3\_Volts\_RMS\_IHDS
  - PowerQuality.2h\_V3\_V1\_Volts\_RMS\_IHDS
- Interharmonics in 5 Hz increments up to the 50th harmonic for voltage, current, and power updated every 10/12 cycles (200 mS). These results are reported in the MeteringData snapshot, Group 2.

**Figure 53 - Illustration of a Harmonic Subgroup, an Interharmonic Centered Subgroup and 5 Hz Increments of Interharmonics (FFT output)<sup>(1)</sup>**



IEC 863/08

(1) Adapted from IEC 61000-4-7-2002, Copyright by IEC, used with permission

## Mains Signaling Voltage on the Supply Voltage

Mains signaling voltage, also called ripple control signal, is composed of bursts of signals at a particular frequency that energy providers can use to control meters, load controllers, and other devices. The PowerMonitor 5000 M8 model measures mains signaling voltage by using the configuration that is made by the user. Results are aggregated over 3 seconds, and reported in the [PowerQuality.EN61000\\_4\\_30\\_Aggregation Data Table](#). Over-threshold values are tracked in the [PowerQuality.EN50160\\_Compliance\\_Results Data Table](#) and reported in the Alarm and Power Quality logs. Measurement uncertainty must not exceed  $\pm 5\%$  of the measured value or  $\pm 0.15\%$  of the nominal system voltage, whichever is greater.

### Setup

In addition to basic metering setup, these configuration parameters are found in the Configuration.PowerQuality tab:

- Mains\_Signaling\_Frequency\_Hz - The monitoring frequency of the control signal in Hz. Range: 5...3000, default 500
- Mains\_Signaling\_Recording\_Length - The maximum recording length in seconds. Range: 1...120 (default)
- Mains\_Signaling\_Threshold\_% - The threshold in percent of signal level to the mains voltage. Range 0 (default)...15, 0 disables

## Rapid Voltage Changes

A rapid voltage change is a fast transition between two steady-state rms voltage values. In general, the voltage after a rapid voltage change remains within the voltage dip (sag) and swell thresholds. Rapid voltage changes are recorded in the Alarm log and the Power Quality log with the date/time stamp of their occurrence.

### *Setup*

One configuration parameter can be found in the Configuration.PowerQuality tab.

- Under\_Over\_Voltage\_Deviation\_Threshold\_% - The percent under voltage or overvoltage of the mains connection to start recording deviation. Range: 0...15, default = 5, 0 disables

## Installing the Add-on Profile

### Introduction

This appendix shows how to install the Add-on Profile (AOP) of the PowerMonitor™ 5000 module with the Logix Designer application. Add-on Profiles are files that you add to your Rockwell Automation® product library. The files contain the pertinent information for configuring a device to be connected to a Logix controller over the EtherNet/IP™, ControlNet®, or DeviceNet® network.

The Add-on Profile is a folder that contains numerous files for the device. The AOP comes as an installation package.

### Download the AOP

The AOP installation package can be downloaded at the following link:

<http://compatibility.rockwellautomation.com/Pages/MultiProductDownload.aspx?crumb=112>

To download the AOP, follow these steps.

1. Type AOP in the Product Search field and select Add-on Profiles.

You can also find the PowerMonitor 5000 Custom AOP by searching for the 1426 catalog number in the Product Search field.

2. Click Downloads.

**FIND DOWNLOADS**

Select one or more products to view the available downloads for those products. You also have an option to view firmware compatibility for a given product.

Type in the catalog numbers and/or descriptions of the products you wish to find. Use the drop down lists to limit your search.

**Start by selecting products**

Product Search:  All Categories | All Families

Example: 1756-C01, C02, Logix, External You can also filter by product category or family.

1715 SIL2 AOPs and AOs	This firmware bundle consists of V2.003 1715-AENTR, AOs and AOPs that must be used with 1715 I/O for SIL2 applications
Add-On Profiles	Add-On Profiles for RSLogix 5000 and Studio 5000 (AOP, AddOn Profiles, Logix Designer)
Drive AOPs	Add-On Profiles for PowerFlex and legacy SCANport drives
Stratix AOP	Stratix AOP Support files

4 Items found

Localities | Contact Us | Legal Notices

MOVE SELECTIONS ▶

Selections: Clear All Views Save

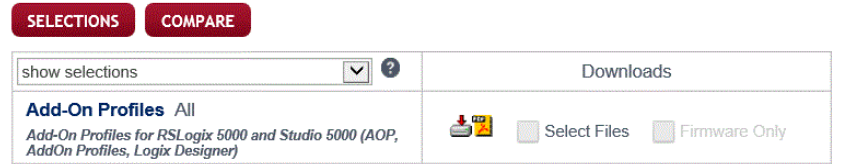
1 Items selected

COMPARE DOWNLOADS

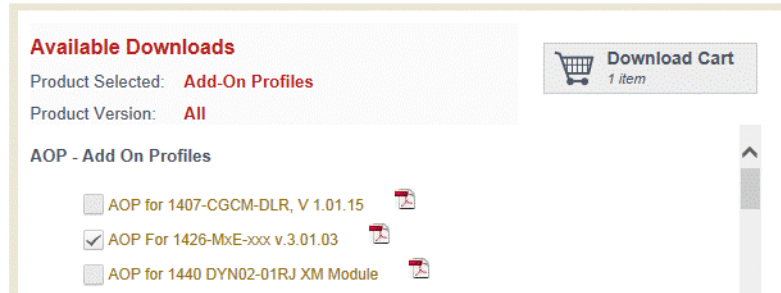
3. Click Select Files.

**DOWNLOADS**

Available downloads for the selected products. Click on the expand icon to see other version downloads

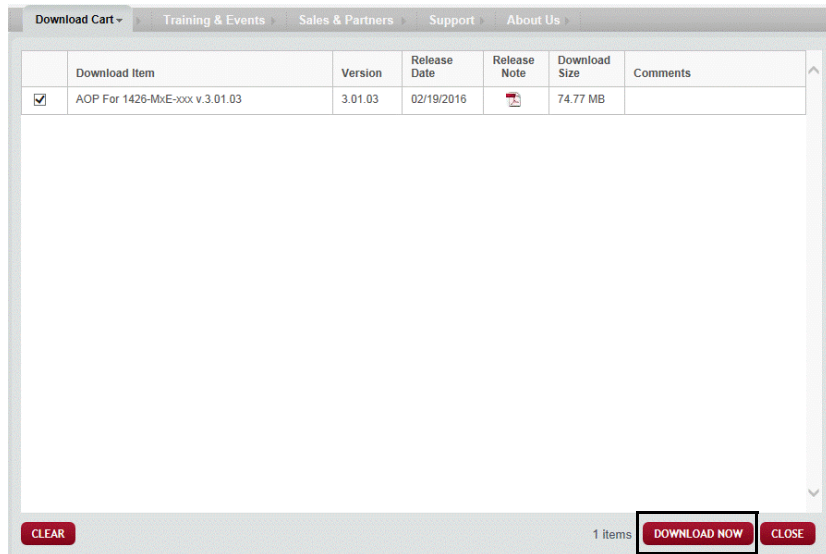


4. Select AOP for 1426-MxE-xxx v.3.01.03 from the list of Add-on Profiles.



5. Click Download Cart.

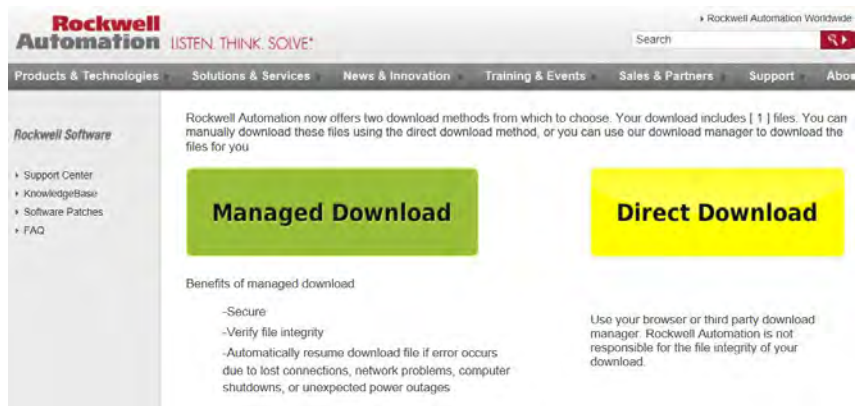
6. Click Download Now.



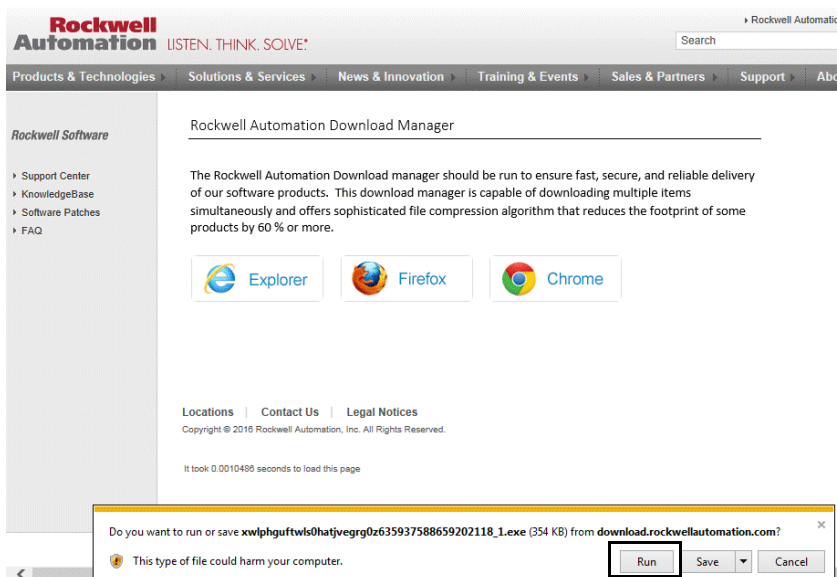
7. If prompted, sign in to website Member Sign In.

8. Accept the terms of the license agreement.

## 9. Select Managed Download.



## 10. Click Run.



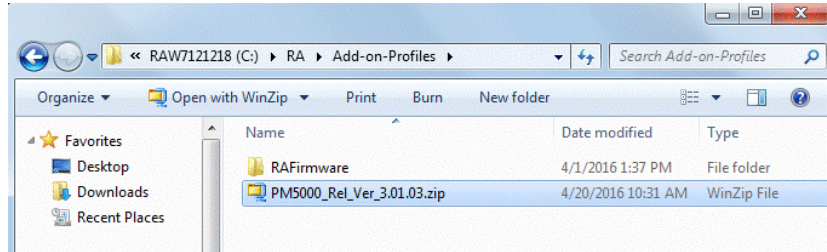
After the download is complete, you can install the profile.

## Install the AOP

Make sure that the Logix Designer application is not running before starting the installation. To install the Add-on Profile, follow the on-screen instructions.

1. To locate the folder where the installation files were downloaded, use Windows Explorer.

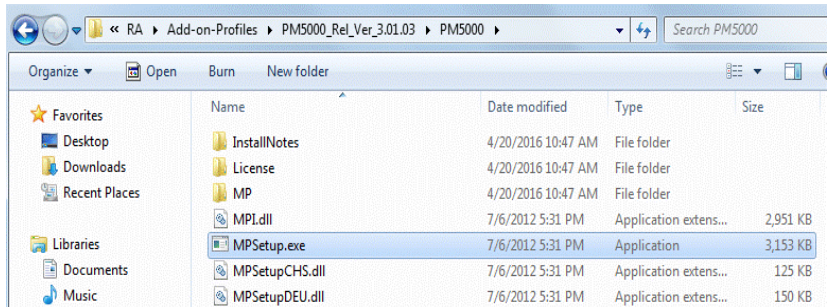
The full path to access the folder is: C:\RA\Add-on-Profiles



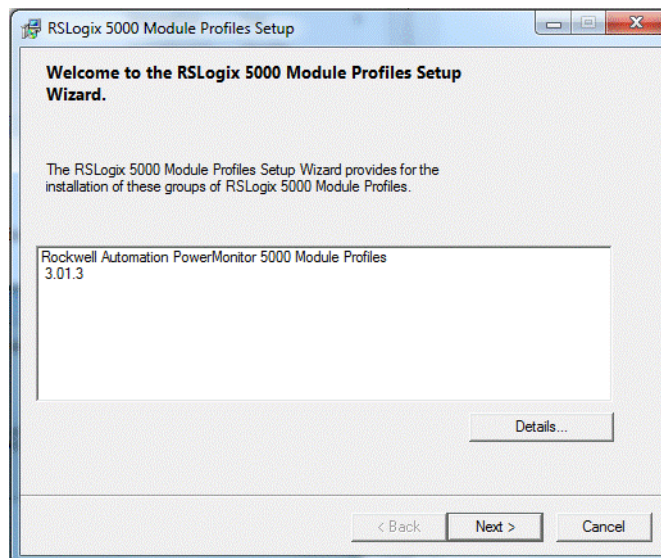
2. Extract the files to a local folder.

The files must be extracted; the Add-on Profile cannot be installed from the zip file.

3. In that folder, open the folder PM5000 and launch MPSetup.exe to begin the installation.



4. In the Logix Designer application Module Setup dialog box, click Next.

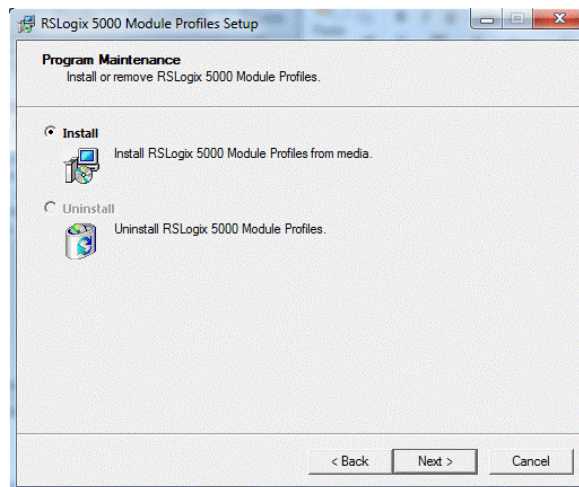




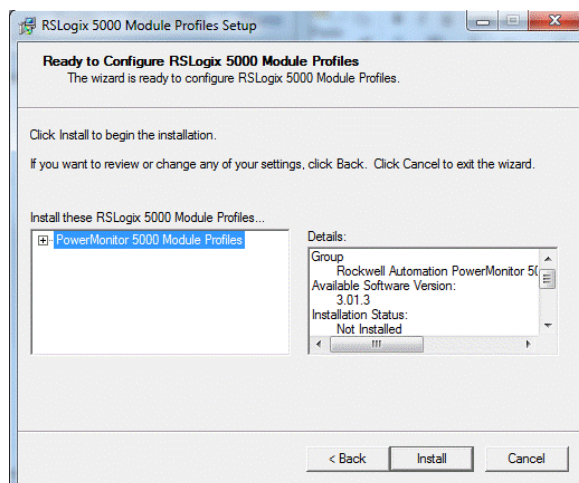
5. Click 'Accept the terms in the license agreement' and click Next.



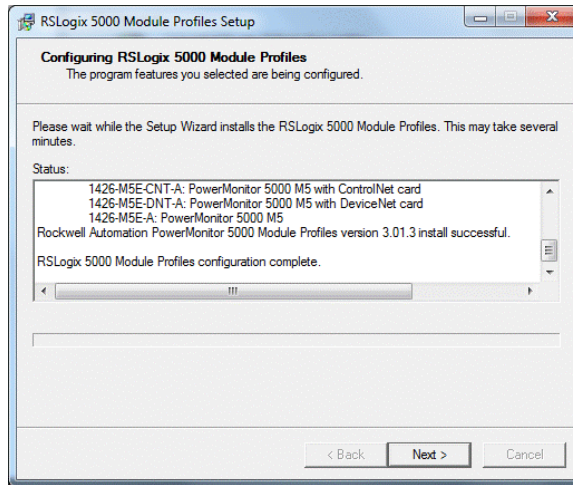
6. Click Install and then click Next.



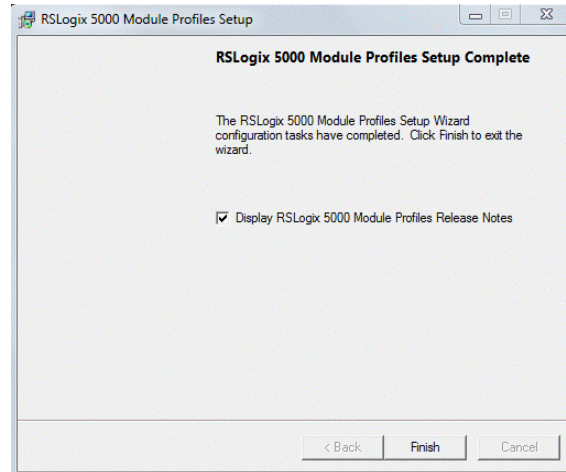
7. Click Install to continue the installation.



8. Click Next to continue.



9. When installation is complete, click Finish.



The following terms and abbreviations are used throughout this manual. For definitions of terms not listed here, see the Allen-Bradley® Industrial Automation Glossary, publication [AG-7.1](#).

- Aggregation** In power quality measurement, the process of computing a value from multiple measurements over a defined time interval. The value is computed by taking the square root of the arithmetic mean of the squared input values over a defined time interval (that is, 180 cycles, 10 minutes). See EN 61000-4-30 standard for more information.
- Amperes (A)** The units of electrical current or rate of flow of electrons. One volt across one ohm of resistance causes a current flow of one ampere. A flow of one coulomb per second equals one amp.
- Apparent Power** The product of voltage magnitude and current magnitude in a circuit. Units are VA or some multiple thereof.
- Balanced Load** An alternating, current power system consisting of more than two current carrying conductors in which these current carrying conductors all carry the same current.
- Billing Demand** The demand level that a utility uses to calculate the demand charges on the current month's bill. Various methods can be used to determine the value, such as minimum demand, peak demand, or a ratchet clause. The value can be based on Watt Demand, VA Demand, VAR Demand, or some combination of these values. A rate at which a transmission occurs, where one baud equals one bit per second.
- Burden** The electrical load that is placed on source of VA or the load an instrument or meter places on a current or potential transformer. All current and potential transformers have a rated burden that cannot be exceeded or else transformer transformation accuracy deteriorates.
- Capacitor** A device consisting essentially of two conducting surfaces that are separated by an insulating material or dielectric. A capacitor stores electrical energy, blocks the flow of direct current, and permits the flow of alternating current to a degree dependent upon the capacitance and frequency. Capacitors can also be used to adjust the power factor in a system.
- Connected Load** The total load that a customer can impose on the electrical system if everything was connected at one time. Connected loads can be measured in horsepower, watts, or volt-amperes. Some rate schedules establish a minimum demand charge by imposing a fee per unit of connected load.
- Crest Factor** A measure of the amount of distortion present in a waveform. Crest Factor can also be used to express the dynamic range of a measurement device. Crest Factor is the ratio of the peak to the rms. For a pure sinusoidal waveform, Crest Factor equals the square root of 2 (1.414).
- Current (I)** The flow of electrons through a conductor, which is measured in amperes.

**Current Overload** A higher than normal flow of current through a conductor or device that exceeds the rating of the conductor or device.

**Current Transformer (CT)** A transformer, intended for measuring or control purposes, which are designed to have its primary winding connected in series with a conductor carrying the current to be measured or controlled. CT's step down high currents to lower values that can be used by measuring instruments.

**Current Transformer Ratio** The ratio of primary amperes divided by secondary amperes.

**Data Flagging** Marking a measured data parameter as potentially inaccurate because the measurement was made during a power quality event.

**Data Table** Power monitor data is organized in data tables similar to data tables found in an SLC 5/03 Programmable Controller. The detailed data table definitions are covered in [Appendix A](#).

**DC Offset** DC offset occurs when an AC waveform has been distorted in a manner that results in a non-zero sum of the waveform values over a one cycle interval.

**Demand Hours** The equivalent number of hours in a month during which the peak demand is fully used. In other words, if energy consumption for the current month is X kwhr and the peak demand is Y kW, then the demand hours is equal to X/Y hours. The higher the number of demand hours, the better the demand leveling situation, and the more effectively demand is being used.

**Demand Interval** Demand charges are based on peak demand over a utility specified time interval, not on the instantaneous demand (or connected load) at any given moment. Typical demand intervals are 15, 20, and 30 minutes.

**Dip** See [Sag](#).

**Duration** For purposes of power quality measurement, duration is the elapsed time from the beginning of a power quality event to the end of that event.

**EN 50160** European standard for 'Voltage characteristics of electricity supplied by public electricity networks'. Defines acceptable variations in the utility supplied voltage.

**EN 61000-4-7** European standard for Testing and measurement techniques - General guide on harmonics and interharmonics measurements and instrumentation, for power supply systems and equipment connected thereto.

**EN 61000-4-15** European standard for Testing and measurement techniques - Flickermeter - Functional and design specifications.

**EN 61000-4-30** European standard that defines testing and measurement techniques for power quality measurement methods.

- FFT Fast Fourier Transform** A mathematical technique for decomposing an AC waveform consisting of a fundamental frequency and one or more harmonics into separate components that represent the magnitude and phase angle of the fundamental and each of the harmonics present. The bandwidth of the input signal must be limited according to the capability of the measuring device.
- Flicker** Low frequency variation in lighting intensity, caused by voltage fluctuations, that can cause discomfort or neurological effects in sensitive individuals. See also Voltage Fluctuation.
- Frequency** The number of recurrences of a periodic phenomenon in a unit of time. In electrical terms, frequency is specified as so many Hertz (Hz) where one Hz equals one cycle per second.
- Fundamental Frequency** With regard to an electrical power system, fundamental frequency is the nominal frequency of the system, that is, 50 Hz or 60 Hz.
- Harmonic Group** The rms value that is obtained for a given harmonic by combining the harmonic rms magnitude with a defined number of adjacent interharmonic rms values. See [EN 61000-4-7](#) for more details.
- Harmonics** AC frequency components that are integer multiples of the fundamental frequency. For example, 180 Hz is the third harmonic in a 60 Hz system.
- Horsepower (hp)** A unit of power, or the capacity of a mechanism to do work. Horsepower is equivalent to raising 33,000 pounds one foot in one minute. One horsepower equals 746 watts.
- IEC 61000-4-30** See EN 61000-4-30.
- IEC 61000-4-7** See EN 61000-4-7.
- IEC 61000-4-15** See EN 61000-4-15.
- IEEE 1159** The IEEE recommended practice for monitoring electric power quality.
- IEEE 519** The IEEE recommended practices and requirements for harmonic control in electrical power systems.
- Imbalance** In a three-phase system, imbalance is a measure of the extent to which the magnitudes of the three phase voltages (or currents) are not equal in magnitude and/or the phase angle between the phases is not 120°. Computed as the ratio of the negative sequence component to the positive sequence component. Imbalance results in unwanted losses in the power system and can result in excessive heating of rotating equipment.
- Impedance** The total opposition (that is, resistance and reactance) a circuit offers to the flow of alternating current at a given frequency. Impedance is measured in ohms.

- Induction Motor** An alternating current motor in which the primary winding (usually the stator) is connected to the power source and induces a current into a secondary (usually the rotor).
- Inductor** A device consisting of one or more windings with or without a magnetic core. Motors are largely inductive.
- Influence Quantity** Any external quantity, such as temperature or electro-magnetic interference, that can affect the accuracy of a measured parameter.
- Initiator Pulses** Electrical impulses that are generated by pulse-initiator mechanisms installed in utility revenue meters. Each pulse indicates the consumption of a specific number of watts. These pulses can be used to measure energy consumption and demand.
- Interharmonics** Frequencies between the harmonics of the power frequency voltage and current, which are not an integer of the fundamental. They can appear as discrete frequencies or as a wide-band spectrum.
- Interharmonic Group** The rms value that is obtained by combining the rms value of the measured interharmonic values between two adjacent harmonic frequencies. See EN 61000-4-7 for more details.
- K-factor** A measure that indicates heating in a power transformer due to harmonics in the power signal. These harmonics cause additional heating due to increased core losses that occur at higher frequencies.
- Lagging Current** The current flowing in an AC circuit that is mostly inductive. If a circuit contains only inductance, the current lags the applied voltage by 90°. Lagging current means lagging power.
- Leading Current** The current flowing in a circuit that is mostly capacitive. If a circuit contains only capacitance, the current leads the applied voltage by 90°. Leading current means leading power factor.
- Load** Any device or circuit consuming power in an electrical system.
- Load Shedding** The removal of load from the line to limit load and control demand level.
- Load Restoring** The energizing of loads that were previously removed from the line to limit load and control demand level.
- Mains Signaling Voltage** A burst of signals that are usually applied to a power circuit at an interharmonic frequency. Used to control remotely industrial equipment, revenue meters, and other devices.
- Measurement Uncertainty** The range of possible error in a measurement as a percent of the ideal value.
- Neutral** The conductor that is chosen as the return path for the current from the load to the source. Neutral is also a voltage reference point in a power system.

---

<b>Noise, Electrical</b>	Undesired broadband electrical signals superimposed on the power system voltage.
<b>Notching</b>	Periodic voltage distortion created by three-phase power electronic devices when current is commutated from one phase to another.
<b>Ohm</b>	The unit of electrical resistance. One ohm is the value of resistance through which a potential difference of one volt maintains a current flow of one ampere.
<b>Overvoltage</b>	An increase in the rms voltage greater than 110% of nominal for more than 1 minute.
<b>Peak Demand</b>	The highest average load over a utility specified time interval during a billing period. If there is no ratchet clause in the rate schedule, then the peak demand is also the billing demand.
<b>Phasor Diagram</b>	A vector diagram that shows the magnitude and phase relationship of the voltages and currents in a three-phase system.
<b>Polyphase</b>	Having or utilizing several phases. A polyphase power circuit has several (typically three) phases of alternating current with a fixed phase angle between phases.
<b>Potential Transformer (PT)</b>	A transformer with the primary winding connected in parallel with the circuit whose voltage is to be measured or controlled. PTs are normally used to step down high-voltage potentials to lower levels acceptable to measuring instruments. Also known as voltage transformer (VT).
<b>Potential Transformer Ratio</b>	The ratio of primary voltage divided by secondary voltage.
<b>Power Factor</b>	The ratio of real power in watts of an alternating current circuit to the apparent power in volt-amperes. Also expressed as the cosine of the phase angle between the fundamental voltage that is applied to a load and the current passing through it.
<b>Power Factor Correction</b>	Steps taken to raise the power factor by closely aligning the current to be in phase with the applied voltage. Most frequently, this process consists of added capacitance to increase the lagging power factor of inductive circuits.
<b>Power Factor Penalty</b>	The charge utilities impose for operating at power factor below some rate schedule-specified level. This level ranges from a lagging power factor of 0.80 to unity. There are innumerable ways by which utilities calculate power factor penalties.
<b>Power Quality</b>	Qualitatively, the fitness of electrical voltage to supply power to consuming devices. Quantitatively, the observed set of electrical characteristics at a given point on an electrical system as compared to a set of reference conditions.
<b>Rapid Voltage Changes</b>	A rapid change is rms value between two steady-state conditions. The magnitude in the change is less than the sag or swell thresholds.

- Ratchet Clause** A rate schedule clause that states that billing demand can be based on current month peak demand or on historical peak demand, depending on relative magnitude. Usually the historical period is the past 11 months, although the historical period can be for the life of the contract. Billing demand is either the current month peak demand or some percentage (75% is typical) of the highest historical peak demand, depending on which is largest. The ratchet Clause is designed to compensate the electric utility for maintaining equipment not fully used.
- Reactance** The opposition to the flow of alternating current. Capacitive reactance is the opposition that is offered by capacitors and inductive reactance is the opposition that is offered by an inductive load. Both reactances are measured in ohms.
- Real Power** The component of apparent power that represents real work in an alternating current circuit. Real Power is expressed in watts and is equal to the apparent power times the power factor.
- Residual Voltage** The minimum remaining voltage during a voltage sag or interruption.
- Resistance** The property of a substance that impedes current flow and results in the dissipation of power in the form of heat. The unit of resistance is the ohm. One ohm is the resistance through which a difference of potential of one volt produces a current of one ampere.
- Revenue Meter** A meter used by a utility to generate billing information. Many types of meters fall in this category depending on the rate structure.
- Root Mean Square (rms)** The effective value of alternating current or voltage. The rms values of voltage and current can be used for the accurate computation of power in watts. The rms value is the same value as if continuous direct current were applied to a pure resistance.
- Sag** Temporary reduction in rms voltage magnitude below a preset threshold, typically 90% of nominal.
- Sequence Currents** The result of symmetrical component analysis performed on a set of three-phase current vectors. The analysis results in three sets of balanced sequence current vectors: positive sequence, negative sequence, and zero sequence. The positive sequence current rotates in the same direction as the original set of vectors, the negative sequence rotates in the opposite direction, and the zero sequence has no rotation. See also Imbalance.
- Sequence Voltages** The result of symmetrical component analysis performed on a set of three-phase voltage vectors. The analysis results in three sets of balanced sequence voltage vectors: positive sequence, negative sequence, and zero sequence. The positive sequence voltage rotates in the same direction as the original set of vectors, the negative sequence rotates in the opposite direction, and the zero sequence has no rotation. See also Imbalance.



- Sliding Demand Interval** A method of calculating average demand by averaging the average demand over several successive short time intervals, advancing one short time interval each time. Updating average demand at short time intervals gives the utility a much better measure of true demand and makes it difficult for the customer to obscure high short-term loads.
- Subharmonics** AC waveform components at frequencies less than the fundamental frequency.
- Swell** Temporary increase in rms voltage magnitude above a preset threshold, typically 110% of nominal.
- Swell Voltage** The maximum rms voltage during a voltage swell.
- TDD** Total Demand Distortion, the ratio of the total rms harmonic content expressed as a percent of the maximum demand current rms value. The maximum demand current is the average of the maximum demand over the previous 12 months.
- THD** Total Harmonic Distortion, the ratio of the total rms harmonic content (either voltage or current) expressed as a percent of the fundamental rms value.
- Threshold** A limit, either fixed or configurable, used to trigger an action when a measured parameter is greater than (i.e. a swell condition) or less than (i.e. a sag condition) the limit.
- TID** Total Interharmonic Distortion, the ratio of the total interharmonic rms content (excluding any harmonic content) to the fundamental rms value.
- Transient** A waveform distortion with a duration of less than one cycle, can be either impulsive or oscillatory. Typically caused by lightning or power device switching.
- Unbalanced Load** A situation existing in a three-phase alternating current system using more than two current carrying conductors where the current is not due to uneven loading of the phases.
- Undervoltage** Voltage sag with a duration greater than one minute.
- Volt ampere (VA)** The unit of apparent power. VA equals volts times amperes regardless of power factor.
- Volt ampere Demand** Where peak average demand is measured in volt-amperes rather than watts. The average VA during a predefined interval. The highest average, for example, Peak VA demand, is sometimes used for billing.
- Volt Ampere Reactive Hours (VARH)** The number of VARs used in one hour. Because the value of this parameter varies, it is necessary to integrate the parameter over time. VARs can be either forward or reverse.
- Voltage (V)** The force that causes current to flow through a conductor. One volt equals the force that is required to produce a current flow of one ampere through a resistance of one ohm.

**Voltage Fluctuation** A series of rms voltage magnitude changes or a low frequency, less than 40 Hz, periodic variation of the nominal voltage envelop. The variations can result in modulation of the luminance of light sources that are connected to the power system. The modulation or 'flicker' can cause discomfort in individuals that are exposed to the flickering light. See EN 61000-4-15 for more details. See also Flicker.

**Voltage Interruption** Voltage sag with a residual voltage less than 10% of nominal.

**Voltage Over Deviation** The ratio of the measured rms voltage to the nominal voltage expressed as a percent when the measured voltage is greater than the nominal voltage. See also Rapid Voltage Changes.

**Voltage Under Deviation** The ratio of the measured rms voltage to the nominal voltage expressed as a percent when the measured voltage is less than the nominal voltage. See also Rapid Voltage Changes.

**Watt (W)** A measure of real power. The unit of electrical power required to do work at the rate of one joule per second. Watt is the power that is expended when one ampere of direct current flows through a resistance of one ohm. Equal to apparent power VA times the power factor.

**Watt Demand** Power during a predetermined interval. The highest average, for example, Peak demand is commonly used for billing.

**Watt Hour (Whr)** The number of watts used in one hour. Because the power usage varies, it is necessary to integrate this parameter over time. Power flow can be either forward or reverse.

**Wattmeter** An instrument for measuring the real power in an electric circuit. Its scale is usually graduated in watts, kilowatts, or megawatts.

**Waveform** Numerical representation of the instantaneous value of a measured parameter (that is, voltage or current) as a function of time. Can be presented graphically or in a tabular form.

**Wiring Correction** In reference to the PowerMonitor™ 5000 unit, the correction that is performed by the device to correct the effect of physical wiring errors without actually accessing the device or moving any of the connected wires.

**Wiring Diagnostics** In reference to the PowerMonitor 5000 unit, this check is an analysis that is performed by the device to verify that the unit is properly connected. In the event connection errors are present, they are identified for the user. The user then has the option of physically correcting the errors or of using the 'virtual' wiring correction capability of the device to allow the device to correct the errors through appropriate internal adjustments. See also [Wiring Correction](#).

**A**

**accessory kit** 19  
     overcurrent protection 31  
**account classes and privileges** 210  
     admin 210  
     application 210  
     USB admin 210  
     user 210  
**accuracy and range** 431  
**adding optional communication** 267  
**addressing**  
     CIP 223  
     CSP 224  
     symbolic 223  
**alarm log** 102  
     codes and descriptions 166  
     logged parameters 165  
     results 165  
**angle data** 457  
**auto return data order** 117  
**automatic virtual wiring correction** 75  
**averaging of metering results** 73

**B**

**basic metering** 71  
     set-up parameters 72  
**billing** 10

**C**

**calendar** 211  
**catalog number explanation** 8  
**CE** 434  
**CIP addressing** 223  
**CIP object** 260  
     base energy 261  
     electrical energy 262  
     message configuration 263  
**class 1 connection** 242  
**commands** 218  
**communication**  
     ControlNet 47  
     ControlNet setup 55  
     DeviceNet 45  
     DeviceNet setup 55  
     Ethernet 44  
     USB port 31  
**communication command**  
     ControlNet 224  
     DeviceNet 224  
     EtherNet/IP 224  
**communication path**  
     explicit message  
         230  
**communication rate**  
     DeviceNet 221

**communication setup**

ControlNet 221  
 DeviceNet 221  
 native Ethernet 219

**configuration**

EDS 257

**configuration lock input** 91**configuration lockswitch** 11**connection**

DeviceNet 46

**control power**

disconnecting means 31  
 source 31

**control power wiring terminal** 12**control relay** 433**control relay terminal** 12**ControlNet**

communication 47, 221  
 communication command 224  
 communication setup 55  
 I/O connection 252  
 object model 227

**cost allocation** 10**crest factor** 96**CSP addressing** 224**CT transformation ratios** 72**current**

THD 468

**current input mapping** 79**current metering** 89**current sensing** 12

phasing 28  
 polarity 28  
 wiring 19  
 wiring diagrams 27 - 29

**current transformer**

wiring 27

**current transformer safety** 9**current transformer secondary wiring** 27

ring lugs 27

**current unbalance formula** 89**D****data log**

date and time 211  
 logged parameters 145  
 parameters 138  
 results 144  
 setup 138  
 single record retrieval 146  
 types 112

**data log parameters** 138**data retrieval** 227**data table interface** 115**data table summary index** 269

**data types**

- DINT 224
- DWORD 224
- INT 224
- INT16 224
- INT32 224
- REAL 224
- SINT 224
- string 224

**daylight saving time** 211, 212

**demand calculation formula** 83

**demand metering** 83

- date and time 211
- delay 86
- end-of-interval signal 85
- number of periods 86
- period length 85
- setup 85

**demand power factor formula** 83

**demand response** 10

**detection of power quality events** 73

**device indicator** 12

**DeviceNet**

- communication 45, 221
- communication command 224
- communication rate 221
- communication setup 55
- connection 46
- I/O connection 247
- mac id 221
- object model 227

**dimensions** 16

**DINT** 224

**disconnecting means** 31

**display module** 437, 447

**display module, Series A**

- navigation, Series A 451

**display module, Series B**

- navigation, Series B 442

**display terminal** 91

**download logging results** 115

**download logging results FTP** 115

**driver configuration**

- Ethernet devices 235
- EtherNet/IP 236
- RSLinx Classic 235

**DWORD** 224

**E**

**EDS** 222

**EDS add on profile**

- RSLinx 5000 257

**electronic data sheet** 222

**electrostatic discharge** 15

**EMC** 435

**EN 50160** 102

- conformance tracking 473
- weekly 117
- weekly log 181, 480
- yearly 117
- yearly log 181, 480

**EN 50160 compliance record** 478

**EN 50160 conformance tracking**

- results 478

**EN 61000-4-30**

- class designations 483
- data flagging 484
- metering and aggregation 483

**enclosure** 15

**energy log** 134

- file name 134
- logged parameters 135
- results 134
- single record retrieval 136

**energy metering** 81

**Energy\_Log\_Interval** 112

**Energy\_Log\_Mode** 113

**Ethernet**

- cable 44
- communication 44
- connections 44
- port 11

**Ethernet communication parameters** 219

**EtherNet/IP**

- communication command 224
- object model 226

**evaluation types** 191

- magnitude 191
- percent of reference 191
- percent of sliding reference 191
- state 191

**event codes** 160

**event log**

- event codes 160
- general codes 160
- information codes 160
- logged parameters 159
- results 159

**Event\_Log\_Mode** 114

**exclusive owner connection** 211, 257

- input only 259
- listen only 258

**explicit message**

- CIP messaging 231
- communication path 230
- PLC-5 typed read 228
- PLC-5 typed read/write 233
- PLC-5 typed write 230
- SLC typed read 228
- SLC typed read/write 233
- SLC typed write 230

**F**

**feature**

- KYZ output 12

- features** 11
    - configuration lockswitch 11
    - control power wiring 12
    - control relay 12
    - current sensing 12
    - Ethernet port 11
    - ground wiring 12
    - KYZ output 30
    - relay outputs 30
    - status indicators 12
    - status inputs 12
    - USB device port 11
    - USB host port 11
    - virtual wiring indicator 12
    - voltage sensing 12
  - flicker** 469, 486
    - severity 475
  - floating point number types** 455
  - frequency metering** 89
  - FTP logging results** 115
  - functions** 13
    - logging 13
    - other 14
- G**
- general codes** 160
  - general specifications** 434
  - generic Ethernet connection**
    - version 19 and earlier 242
  - ground the unit** 18
  - ground wiring terminal** 12
  - grounding**
    - mounting surface 18
    - wire connection 18
- H**
- harmonic analysis**
    - 96
    - IEC DIN 96
    - IEEE THD 96
    - total harmonic distortion 96
  - harmonic distortion**
    - crest factor 96
    - harmonic analysis results 97, 99
    - harmonic magnitude and angle 98
    - harmonic power 99
    - k-factor 97
  - harmonic magnitude** 98
  - harmonic power** 99
  - harmonic voltage**
    - rms values 475
- I**
- I/O connection**
    - ControlNet 252
    - DeviceNet 247
  - IEC DIN** 96
  - IEEE 1159** 102, 469
  - IEEE 1159-2009** 463
  - IEEE 519-1992**
    - pass fail capability 459
    - pass fail results 460
    - pass fail status 460
  - IEEE THD** 96
  - information codes** 160
  - input and output ratings** 432
  - input only connection** 259
  - inserting communication card** 45, 47
  - install the unit** 15
    - substation 15
    - switchgear 15
  - instantaneous demand formula** 84
  - INT** 224
  - INT16** 224
  - Int32** 224
  - interharmonic voltages** 476
  - interharmonics** 488
  - internal clock** 211
- K**
- k-factor** 97
  - KYZ output** 12, 30, 183
    - Setup 184
- L**
- line voltage monitoring** 102
  - load factor log** 155
    - logged parameters 155
    - results 155
  - load profiling** 10
  - Load\_Factor\_Auto\_Log\_Setting** 113
  - logged parameters**
    - energy log 135
  - logging functions** 13
  - logging results** 114, 115
    - using FTP 115
  - logging setup** 112
  - logic gates** 194
    - setup 197
  - Logix Designer application** 228
- M**
- magnitude and direction power quantities**
    - chart 88
  - magnitude data** 456
  - magnitudes** 77
  - mains signaling voltage** 476, 491
  - mean fundamental frequency** 474
  - mean rms supply voltage** 474
  - measurements** 80
  - memory organization** 223

**metering**

- current 89
- frequency 89
- voltage 89

**metering accuracy** 73**metering results** 71

- averaging 73
- update rate 73
- viewing on display terminal 91
- viewing on web page 90
- voltage and current unbalance 467

**metering snapshot log**

- results 180

**min/max log** 148

- logged parameters 148
- results 148

**mount the unit**

- dimensions 16
- enclosure 15
- panel mounting 17
- ventilation 16

**N****native Ethernet**

- communication 219

**navigation**

- display module, Series A 451
- display module, Series B 442

**network communicaiton**

- waveform log 118

**network indicator** 12**nominal system frequency** 73**nominal system voltage** 73**O****object model**

- object class list 226, 227

**Off\_Peak\_Days** 113**OPC server** 236

- test 238

**other functions** 14**overcurrent protection** 31**overview** 9**P****panel mounting** 17**PanelView 800, terminal set-up** 437**PanelView C400, terminal set-up** 447**parameter configuration** 227**peak hours** 113**phase angle** 74, 77**Point of Common Coupling (PCC)** 459**power factor**

- phase angle 74

**power factor ranges** 74**power frequency variations** 470**power indicator** 12**power metering** 87**power quality** 10

- 94
- accuracy 484
- capabilities 94
- classification 94
- magnitude of the supply voltage 486
- measurement 484
- measurement and reporting 94
- power frequency 486
- recording 94
- time aggregation 484

**power quality events** 463**power quality log** 171

- event codes 173
- logged parameters 172
- record 171
- results 175

**power quantities chart** 88**power system control** 10**power system monitoring** 10**PowerMonitor 5000**

- description 9
- functions 13

**PowerMonitor 5000 input only connection** 211**PowerMonitor 5000 unit**

- safety 9

**PowerQuality\_Log\_Mode** 113**precision time protocol** 213**product description** 9**product disposal** 14**PT transformation ratios** 72**R****rapid voltage change** 492**rapid voltage changes** 475**read logging records** 115**REAL** 224**relay outputs** 30**removing communication card** 45, 47**retrieve logging results** 114**ripple control signal** 491**RMS variations**

- operation 465
- setup 465
- short duration 465

**rms variations**

- long duration 466

**RSLinx Enterprise** 240**run time errors** 217**S****safe disposal of product** 14**safe mode** 217**safety** 9

- current transformer 9

- sag and swell**
    - 102
    - operation 103
    - setup 103
    - status 104
    - thresholds 103
  - SCADA** 235
  - security** 209
    - account classes and privileges 210
    - deleted accounts 211
    - login 228
    - lost login 211
  - servicing connect equipment**
    - shorting switch 27
    - shorting terminal block 27
    - test block 27
    - wiring 27
  - setpoint and logic gate**
    - statistics 206
    - status 206
  - setpoint log**
    - logged parameters 163
    - results 163
  - setpoint operation** 191
    - equal to 194
    - evaluation types 191
    - greater than 192
    - less than 193
    - logic gates 194
  - setpoint output action list** 205
  - setpoint parameter list** 198
  - Setpoint\_Log\_Mode** 113
  - set-up parameters** 72
  - simple network time protocol** 213
  - single record retrieval**
    - data log 146
    - energy log 136
  - SINT** 224
  - snapshot log** 179
    - content 179
    - data table interface 181
    - web interface 181
  - specifications**
    - Accuracy and range 431
    - general 434
    - input and output ratings 432, 433
  - status indicators**
    - device 12
    - network 12
    - power 12
  - status inputs** 12, 187
    - features
      - status inputs 30
    - Setup 188
  - string** 224
  - Studio 5000 Engineering and Design Environment** 228
  - sub-billing** 10
  - supply voltage unbalance** 488
  - supply voltage variations** 474
  - symbolic tag addressing** 223
  - symmetrical component analysis** 90
  - system clock synchronize** 213
- T**
- terminal** 437, 447
  - terminal block layout** 18
  - THD** 96
    - current 468
    - voltage 468
  - time of use log**
    - logged parameters 157
    - results 156
  - time zones** 214
  - Time\_Of\_Use\_AutoStore** 113
  - Total Demand Distortion (TDD)** 459
  - total harmonic distortion** 96
  - transient overvoltages** 478
  - transients**
    - category 1.1.3 464
    - category 1.2.1 464
  - trigger data log**
    - 176
    - parameter selection 176
    - record retrieval 178
    - results 177
- U**
- UDT files** 251
  - UL/CUL** 434
  - unit reset** 217
  - update rate of metering results** 73
  - upgrading model** 267
  - USB cable type** 31
  - USB device port** 11, 31
  - USB drivers**
    - download 32
  - USB host port** 11
- V**
- ventilation** 16
  - virtual wiring correction** 78
  - virtual wiring indicator** 12
  - voltage**
    - THD 468
  - voltage and current unbalance** 467
  - voltage dips** 477, 486
  - voltage harmonics** 488
  - voltage input mapping** 79
  - voltage interruptions** 487
  - voltage metering** 89
  - voltage sensing**
    - wiring 19
    - wiring diagrams 20 - 27
  - voltage sensing wiring terminal** 12
  - voltage swells** 478, 487

- voltage unbalance**
  - RMS values 475
- voltage unbalance formula** 89
- VT transformation ratios** 72

## W

- waveform**
  - capture 105, 455
  - compression 455
  - data records 132
  - distortion 468
  - file format 458
  - files 107
  - header 133
  - recording 104, 105
  - recordings 455
  - retrieving 108
- waveform log** 118
  - retrieve records 118
- web page logging results** 114
- wire requirements** 18
- wire the unit**
  - accessory kit 19
  - ground 18
  - requirements 18
  - terminal block layout 18
- wiring corrections**
  - command 78
  - status 79
- wiring diagnostic results** 75
- wiring diagnostics** 73
  - command word 75
  - power factor ranges 74





# Rockwell Automation Support

Use the following resources to access support information.

<b>Technical Support Center</b>	Knowledgebase Articles, How-to Videos, FAQs, Chat, User Forums, and Product Notification Updates.	<a href="https://rockwellautomation.custhelp.com/">https://rockwellautomation.custhelp.com/</a>
<b>Local Technical Support Phone Numbers</b>	Locate the phone number for your country.	<a href="http://www.rockwellautomation.com/global/support/get-support-now.page">http://www.rockwellautomation.com/global/support/get-support-now.page</a>
<b>Direct Dial Codes</b>	Find the Direct Dial Code for your product. Use the code to route your call directly to a technical support engineer.	<a href="http://www.rockwellautomation.com/global/support/direct-dial.page">http://www.rockwellautomation.com/global/support/direct-dial.page</a>
<b>Literature Library</b>	Installation Instructions, Manuals, Brochures, and Technical Data.	<a href="http://www.rockwellautomation.com/global/literature-library/overview.page">http://www.rockwellautomation.com/global/literature-library/overview.page</a>
<b>Product Compatibility and Download Center (PCDC)</b>	Get help determining how products interact, check features and capabilities, and find associated firmware.	<a href="http://www.rockwellautomation.com/global/support/pcdc.page">http://www.rockwellautomation.com/global/support/pcdc.page</a>

## Documentation Feedback

Your comments will help us serve your documentation needs better. If you have any suggestions on how to improve this document, complete the How Are We Doing? form at [http://literature.rockwellautomation.com/idc/groups/literature/documents/du/ra-du002\\_-en-e.pdf](http://literature.rockwellautomation.com/idc/groups/literature/documents/du/ra-du002_-en-e.pdf).

Rockwell Automation maintains current product environmental information on its website at <http://www.rockwellautomation.com/rockwellautomation/about-us/sustainability-ethics/product-environmental-compliance.page>.

Allen-Bradley, CompactLogix, ControlFLASH, ControlLogix, FactoryTalk Administration Console, FactoryTalk EnergyMetrix, Logix5000, MicroLogix, PanelView, PLC-5, PowerMonitor, Rockwell Automation, Rockwell Software, RSLinx Classic, RSLogix 500, RSLogix 5000, RSNetWorx, SLC, Studio 5000, Studio 5000 Automation Engineering & Design Environment, and Studio 5000 Logix Designer are trademarks of Rockwell Automation, Inc.

CIP, CIP Energy, ControlNet, DeviceNet, and EtherNet/IP are trademarks of ODVA, Inc.

Excel and Microsoft is a trademark of Microsoft Corporation.

Trademarks not belonging to Rockwell Automation are property of their respective companies.

Rockwell Otomasyon Ticaret A.Ş., Kar Plaza İş Merkezi E Blok Kat:6 34752 İçerenköy, İstanbul, Tel: +90 (216) 5698400

**[www.rockwellautomation.com](http://www.rockwellautomation.com)**

### Power, Control and Information Solutions Headquarters

Americas: Rockwell Automation, 1201 South Second Street, Milwaukee, WI 53204-2496 USA, Tel: (1) 414.382.2000, Fax: (1) 414.382.4444

Europe/Middle East/Africa: Rockwell Automation NV, Pegasus Park, De Kleetlaan 12a, 1831 Diegem, Belgium, Tel: (32) 2 663 0600, Fax: (32) 2 663 0640

Asia Pacific: Rockwell Automation, Level 14, Core F, Cyberport 3, 100 Cyberport Road, Hong Kong, Tel: (852) 2887 4788, Fax: (852) 2508 1846

Publication 1426-UM001J-EN-P - August 2019

Supersedes Publication 1426-UM001I-EN-P - June 2016

Copyright © 2019 Rockwell Automation, Inc. All rights reserved. Printed in the U.S.A.