



# Relay and Timer Specifications

Bulletin 700

Topic	Page	Topic	Page
Summary of Changes	2	<b>Solid-state Relays</b>	<b>221</b>
General Information	3	700-SA Tube Base Relays	225
<b>General Purpose Relays</b>	<b>9</b>	700-SC Ice Cube Relays	228
700-HA General-purpose Relay	12	700-SF Square Base Relays	233
700-HB Square Base Relay	22	700-SH Hockey Puck Relays	237
700-HD Flange Mount Square Base Relay	28	700-SK Slim Line Relays	246
700-HF Square Base Relay	32		
700-HC Miniature Ice Cube Relay	39		
700-HK Slim Line Relay	44		
700-HL Terminal Block Relay	50		
700-HL 2-pole Terminal Block Relay	56		
700-HLF Terminal Block Timing Relay	60		
700-HP Slim Line Relay	64		
700-HPS Safety Control Relay	65		
700-HJ Magnetic Latching Relay	71		
700-HG Power Relay	75		
700-HHF Flange Mount Power Relay	80		
700-HTA Alternating Relay	83		
<b>General Purpose Electronic Timers and Counters</b>	<b>89</b>		
700-FE Economy Timing Relay	92		
700-FS High Performance Timing Relay	96		
700-HNC Miniature Timing Relay	103		
700-HNK Ultra-Slim Timing Relay	109		
700-HR Dial Timing Relays	116		
700-HT Plug-in Timing Relay	128		
700-HV Timing Relay	133		
700-HX Multi-Function Digital Timing Relay	138		
<b>NEMA Industrial Relays</b>	<b>149</b>		
700-P Industrial Relays	151		
700S-P and 700S-PK – Heavy-Duty Safety Control Relays	167		
700-N Industrial Relays	172		
700-R Sealed Switch Relays	176		
700-RTC – Solid-State Timing Relay	181		
<b>IEC Control Relays</b>	<b>187</b>		
700-CF Control Relay	188		
700S-CF Control Relays	208		
700-K Miniature Control Relays	213		

## Summary of Changes

This publication contains the following new or updated information. This list includes substantive updates only and is not intended to reflect all changes.

<b>Topic</b>	<b>Page</b>
Updated 700-CF Control Module Information	195

## General Information

### Contact Data Tables

	Relay Type	Contact Arrangement	Contact Style	Contact Material	NEMA Pilot Duty <sup>(1)</sup>	AC and DC Switching Capability											
						1 mA	20 mA	50 mA	100 mA	1 A	3 A	5 A	10 A	20 A	25 A	30 A	35 A
IEC Relays	700-CF	Up to 8 form X or 8 form Y	cross stamped	Ag	A600 P600	24V	AC					DC					
	700S-CF	Up to 8 form X or 8 form Y	cross stamped	Ag	A600 P600	24 V	AC					DC					
	700-K	Up to 8 form X or 8 form Y	bifurcated	AgCu	A300 Q300	17V	AC			DC							
NEMA Relays	700-P	Up to 12 form X or 8 form Y	bifurcated	NiAg	A600 P600	10V	AC			DC							
	700-PK	Up to 12 form X or 8 form Y	single	AgCdO	2X A600 2X P600	10V	AC			DC	20 A	(20 A Lighting Load)					
	700-PH	Up to 6 form X or 4 form Y	tandem	AgCdO	A600 P600	10V	AC			DC	(35 A Lighting Load)						
	700-R	Up to 8 form A or form B	sealed sw.	W	B300 C600 P300	5V	AC					DC					
	700-RTC	Up to 4 form A or form B	sealed sw.	W	B600 P300	5V	AC					DC					
	700S-P	Up to 12 form X or 8 form Y	bifurcated	NiAg	A600 P600	10V	AC										

(1) See [NEMA Ratings and Test Values on page 5](#)

**Contact Data Tables**

	Relay Type	Contact Arrangement	Contact Style	Contact Material	NEMA Pilot Duty	AC and DC Switching Capability											
						1 mA	10 mA	50 mA	100 mA	1 A	3 A	5 A	10 A	20 A	25 A	30 A	35 A
Timing Relays	700-FE	1 N.O.	single	AgCdO	D300			10V	AC DC (24V Max.)								
	700-FS	1, 2 form C	single	AgCdO	B300			10V	AC DC (24V Max.)								
General Purpose Relays	700-HA	2, 3 form C	single	AgNi	B300			10V	AC DC (24V Max)								
	700-HAX	2, 3 form C	bifurcated	Au/AgNi	B300	6V	AC DC (24V Max)										
	700-HB	2, 3 form C	single	AgNi	B300			10V	AC DC (24VMax.)								
	700-HC14	4 form C	single	Ag/Au	C300 Q300	10V	AC DC (30V Max.)										
	700-HC22	2 form C	single	AgNi	B300 Q300		10V	AC DC									
	700-HC24	4 form C	single	AgNi	C300 Q300		10V	AC DC (30V Max.)									
	700-HD	2, 3 form C	single	AgCdO	B300			10V	AC DC (24V Max)								
	700-HF	2, 3, 4 form C	single	AgCdO	B300			10V	AC DC (30V Max)								
	700-HG	1 form X, 1 form C, 2 form A, 2 form C	single	AgNi	A600			10V	AC DC (28V Max)								
	700-HHF45	1 form X	single	AgNi	A600			10V	AC DC (28V Max)								
	700-HHF62	2 form C	single	AgNi	B600			10V	AC DC (28V Max)								
	700-HHF73	3 form C	single	AgNi	B300			10V	AC DC (28V Max)								
	700-HJ	1, 2 form C	single	AgCdO	—			10V	AC DC (24V Max.)								
	700-HK36	1 form C	single	AgNi	B300			10V	AC DC (30V Max)								
	700-	1 form C	single	Au/AgNi	B300			10V	AC DC (30V Max)								
700-HK32	2 form C	single	AgNi	B300			5V	AC DC (30V Max)									
700-	2 form C	single	Au/AgNi	B300			5V	AC DC (30V Max)									

## Contact Data Tables

	Relay Type	Contact Arrangement	Contact Style	Contact Material	NEMA Pilot Duty	AC and DC Switching Capability												
						1 mA	10 mA	50 mA	100 mA	1 A	3 A	5 A	10 A	20 A	25 A	30 A	35 A	
General Purpose Relays (continued)	700-HLS	Solid-State 1 N.O.	—	—	—	3V	—————					AC/DC						
	700-HLT	1 Form C	single	AgSnO	B300 R300	12V	—————					6 A	AC/DC					
	700-HLT__X	1 Form C	single	AgSnO	B300 R300	8V	—————					6 A	AC/DC					
	700-HP	2 Form C	single	AgNi	B300 Q300	5V (300 mW)	—————					8 A	AC/DC					
	700-HPX	2 Form C	single	AgNi + Gold	B300 Q300	5V (50 mW)	—————					8 A	AC/DC					
	700-HS	2 Form C	single	AgCdO	B300			10V	—————					AC DC	(30V Max)			
	700-HT	2 form C	single	AgNi	B300			10V	—————					AC DC	(30V Max)			

## NEMA Ratings and Test Values

## NEMA Ratings and Test Values for AC Control Circuit Contacts at 50 or 60 Hz

Maximum Current [A]											
NEMA Contact Rating Designation	Thermal Continuous Test Current [A]	120V		240V		480V		600V		VA	
		Make	Break	Make	Break	Make	Break	Make	Break	Make	Break
A150	10	60	6.00	—	—	—	—	—	—	7200	720
A300	10	60	6.00	30	3.00	—	—	—	—	7200	720
A600	10	60	6.00	30	3.00	15	1.50	12	1.20	7200	720
B150	5	30	3.00	—	—	—	—	—	—	3600	360
B300	5	30	3.00	15	1.50	—	—	—	—	3600	360
B600	5	30	3.00	15	1.50	7.5	0.75	6	0.60	3600	360
C150	2.5	15	1.50	—	—	—	—	—	—	1800	180
C300	2.5	15	1.50	7.5	0.75	—	—	—	—	1800	180
C600	2.5	15	1.50	7.5	0.75	3.75	0.375	3	0.30	1800	180
D150	1.0	3.60	0.60	—	—	—	—	—	—	432	72
D300	1.0	3.60	0.60	1.8	0.30	—	—	—	—	432	72
D600	0.5	1.80	0.30	—	—	—	—	—	—	216	36
2X A300	20	120	12	60	6.00	—	—	—	—	14400	1440
2X A600	20	120	12	60	6.00	30	3.00	24	2.40	14400	1440

### NEMA Ratings and Test Values for DC Control Circuit Contacts

Maximum Current [A]						
NEMA Contact Rating Designation	Thermal Continuous Test Current [A]	5...28V	125V	250V	301...600V	Make or Break at 300V or less [VA]
N150	10	10	2.2	—	—	275
N300	10	10	2.2	1.1	—	275
N600	10	10	2.2	1.1	0.40	275
P150	5.0	5.0	1.1	—	—	138
P300	5.0	5.0	1.1	0.55	—	138
P600	5.0	5.0	1.1	0.55	0.20	138
Q300	2.5	2.5	0.55	0.27	0.11	69
Q600	2.5	2.5	0.55	0.27	0.11	69
2X P600	10	10	2.2	1.1	0.40	275

### NEMA Definitions for Contact Arrangements

Contact Arrangement	Description	Diagram
<b>Form A</b>	A Form A contact arrangement is one that has single-pole, single-throw, normally open contacts. The function of this arrangement is to close a circuit when actuated.	
<b>Form B</b>	A Form B contact arrangement is one that has single-pole, single-throw, normally closed contacts. The function of this arrangement is to open a circuit when actuated.	
<b>Form C</b>	A Form C contact arrangement is one that has single-pole, double-throw contacts with three terminals - one for normally open, one for normally closed, and one common. The function of this arrangement is to transfer a circuit when actuated.	
<b>Form X</b>	A Form X contact arrangement is one that has single-pole, single-throw, normally open double-make contacts. The function of this arrangement is to close a circuit when actuated.	
<b>Form Y</b>	A Form Y contact arrangement is one that has single-pole single-throw normally closed double-break contacts. The function of this arrangement is to open a circuit when actuated.	
<b>Form Z</b>	A Form Z contact arrangement is one that has single-pole, double-throw, contacts with four terminals — two for normally open and two for normally closed. The function of this arrangement is to open one circuit and close the other.	

## Timing Relay Selection Criteria

Single Function Timers: Timers that have only 1 timing mode (for example, ON-Delay or OFF-Delay).

Multi-Function Timers: Timers that have 4...8 timing modes that are selected by turning the mode selection switch.

### ON-Delay or (Delay on Operate)

When power is applied continuously (or when power and a start signal are applied), the timing cycle begins. The output contacts change state after the time delay is completed. The contacts will return to their normal state when a reset signal is applied or power is removed.

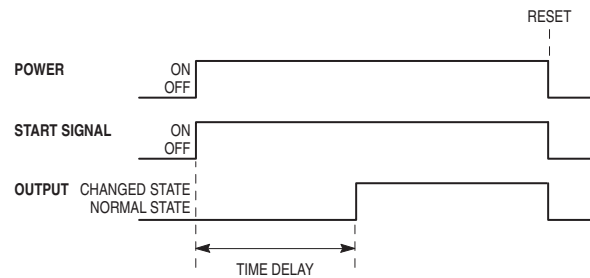

### OFF-Delay or (Delay on Release)

Power is applied continuously. When a start signal is applied, the output contacts change state immediately. When the start signal is removed, the timing cycle begins. The output contacts will return to their normal state once the time delay is completed. Reset will occur when a reset signal is applied or power is removed.

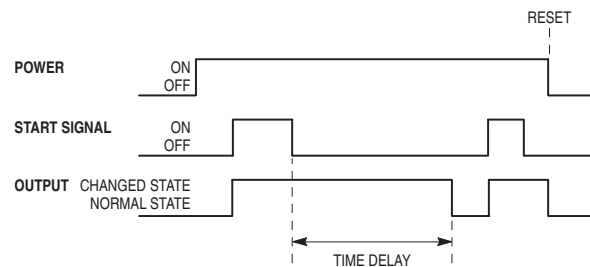

### One Shot or (Repeat Cycle)

Power is applied continuously. When a start signal is applied, the output contacts change state immediately and the timing cycle begins. The output contacts will return to their normal state once the time delay is completed. Reset will occur when a reset signal is applied or power is removed.

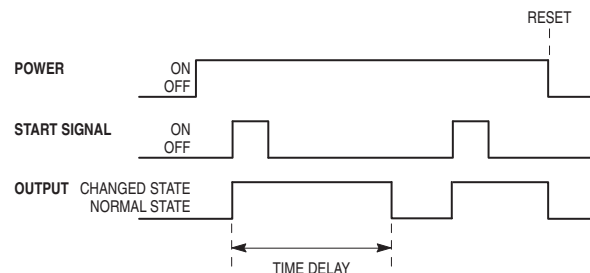

### Repeat Cycle or (Flicker)

Power is applied continuously. When a start signal is applied, the timing cycle begins. When the time delay is completed, the output contacts change state and the next timing cycle begins. This cycle will repeat until a reset signal is applied or power is removed.

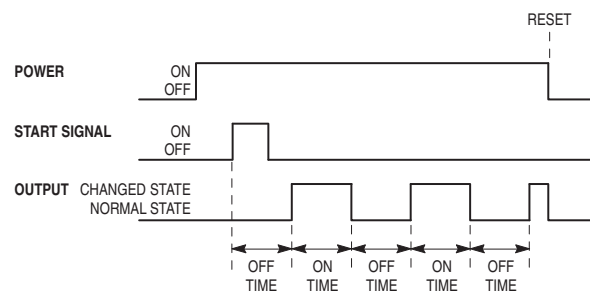

## Flexibility

**Mounting** — Timing relays are available in several different models. They can be plugged into the same socket as the relay, or use a separate plug-in socket mounting.

**Contacts** — The contacts are of various types and ratings. See the appropriate specification pages for more details.

**Functionality** — Timing relays with multi-range and multi-function capability are available. Allowing you to stock one relay to cover a wide variety of applications.

**External Trigger Switch** — OFF-Delay, One-Shot, and other timer functions require an external trigger switch (from a relay or push button) to control the timing function. The external trigger switch will cause the timing function to start. In OFF-Delay, the trigger switch closes to energize the output and when the trigger switch opens the OFF-Delay starts to time out. At the end of the time delay, the output is de-energized and the output contacts return to their shelf state.





**Surge Suppression Information**





Photo	Cat. No.	For use with	Suppression Technique	Max. Relay Contact Dropout Time	Max. Transient Voltage Relative to System Voltage
	700-ADR	700-HA, -HB, -HK, -HP (6...220V DC)	Diode	3X	—
	700-ADL1	700-HC (6...24V DC)	Diode + LED	3X	—
	700-ADL1R	700-HB, -HA, -HK, -HP (6...24V DC)	Diode + LED	3X	—
	700-ADL2	700-HC (28...60V DC)	Diode + LED	3X	—
	700-ADL2R	700-HB, -HA, -HK, -HP (28...60V DC)	Diode + LED	3X	—
	700-ADL3	700-HC (110...220V DC)	Diode + LED	3X	—
	700-ADL3R	700-HB, -HA, -HK, -HP (110...220V DC)	Diode + LED	3X	—
	700-AR1	700-HB, -HA, -HC, -HK, -HP (6...24V AC/DC)	RC	No Effect	3
	700-AR2	700-HB, -HA, -HC, -HK, -HP (110...240V AC/DC)	RC	No Effect	—
	700-AV1R	700-HB, -HA, -HC, -HK, -HP (6...24V AC)	Varistor + LED	No Effect	—
	700-AV3R	700-HB, -HA, -HC, -HK, -HP (110...240V AC)	Varistor + LED	No Effect	—
700-CF Relay	700-CF built-in	—	Diode	—	6...10X
	100-FSC	100C, 700-CF	R-C Ckt	No Effect	3X
	100-FSV	100C, 700-CF	MOV	No Effect	—
	100-FSD	100C, 700-CF	Diode	70...95 ms	6...10X
	100-JE	100C, 700-CF	Diode	5X	6...10X
	700-N5	700-P, 700-N	RC	No effect	3X
	700-N24	700-P, 700-N	RC	No effect	3X
700-R Relay	700-R built-in	—	Diode	—	6...10X
	199-FSMA1, FSMA2	700-P, 700-H, 700-CF, 700DC-R	RC	No effect	3X
	199-FSMA9, 10, 11	700-P, 700-H, 700-CF, 700DC-R	MOV	No effect	—
	199-FSMZ	700-P, 700-H, 700-CF, 700DC-R	Diode	5X	—





## General Purpose Relays

### Product Overview

				
<b>Bulletin No.</b>	<b>700-HA</b>	<b>700-HB</b>	<b>700-HD</b>	<b>700-HF</b>
<b>Type</b>	<b>General-purpose Relay</b>	<b>General-purpose Relay</b>	<b>General-purpose Relay</b>	<b>General-purpose Relay</b>
<b>Features</b>	<ul style="list-style-type: none"> <li>Pin-style terminals</li> <li>Standard ON/OFF flag indicator</li> <li>Electrical schematic on face</li> <li>Clear cover for visual inspection</li> <li>Optional push-to-test and manual override</li> <li>Optional LED</li> </ul>	<ul style="list-style-type: none"> <li>Blade-style quick connect terminals</li> <li>Standard ON/OFF flag indicator</li> <li>Electrical schematic on face</li> <li>Clear cover for visual inspection</li> <li>Optional push-to-test and manual override</li> <li>Optional LED</li> </ul>	<ul style="list-style-type: none"> <li>Flange-mounted</li> <li>Blade-style quick connect terminals</li> <li>Clear cover for visual inspection</li> </ul>	<ul style="list-style-type: none"> <li>Square-base</li> <li>Plug-in quick connect solder terminals</li> <li>Optional push-to-test</li> <li>Optional LED</li> </ul>
<b>Contact Ratings</b>				
<b>Contact Form</b>	DPDT, 3PDT	DPDT, 3PDT	DPDT, 3PDT	DPDT, 4 PDT
<b>Contact Type</b>	Single	Single	Single	Single
<b>Contact Material</b>	AgNi, AgNi + Gold	AgCdO	AgCdO	AgCdO
<b>Operating Current, Under Resistive Load, Max</b>	700-HA: 10 A 700-HAX: 6 A	15 A	15 A	10 A
<b>Permissible Load, min</b>	700-HA: 10V, 5 mA 700-HAX: 6V 1 mA	10V, 10 mA	10V, 10 mA	5V, 100 mA
<b>Coil Ratings</b>				
<b>Coil Voltage</b>	AC: 6, 12, 24, 48, 110, 120, 230, 240, 277V DC: 6, 12, 24, 36, 48, 60, 80, 110, 125, 140, 220V	AC: 6, 12, 24, 120, 240V DC: 6, 12, 24, 48, 110V	AC: 6, 12, 24, 120, 208, 240V DC: 6, 12, 24, 48, 110V	AC: 6, 12, 24, 120, 240V DC: 6, 12, 24, 48, 110V
<b>Permissible Coil Voltage Variation</b>	80...110% of nom voltage at 50 Hz 80...110% of nom voltage at 60 Hz 80...110% of nom voltage at DC			85...110% of nom voltage at 50 Hz 85...110% of nom voltage at 60 Hz 80...110% of nom voltage at DC
<b>Electrical Ratings</b>				
<b>Dielectric Withstand Voltage</b>	Pole-to-pole: 2000V Contact-to-coil: 2000V Contact-to-frame: 2000V	Pole-to-pole: 2500V Contact-to-coil: 4000V Contact-to-frame: 2500V	Pole-to-pole: 2500V Contact-to-coil: 4000V Contact-to-frame: 2500V	Pole-to-pole: 1500V Contact-to-coil: 1500V Contact-to-frame: 1500V
<b>Electrical Service Life (Cycles)</b>	100,000 min	100,000 min	100,000 min	200,000 min 500,000 min (DPDT)
<b>Reference</b>				
<b>Certifications</b>	CE, cULus, cURus, CSA, Lloyds	CE, cULus, cURus, CSA, Lloyds	CE, UR, CSA, Lloyds	CE, UR, CSA
<b>Socket Catalog Numbers</b>	700-HN100, 700-HN101, 700-HN125, 700-HN126, 700-HN204, 700-HN205	700-HN153, 700-HN154	—	700-HN262, 700-HN264
<b>Page</b>	<a href="#">12</a>	<a href="#">22</a>	<a href="#">28</a>	<a href="#">32</a>

				
<b>Bulletin Number</b>	<b>700-HC</b>	<b>700-HK</b>	<b>700-HL</b>	<b>700-HP</b>
<b>Type</b>	Interposing/Isolation Relay	Interposing/Isolation Relay	Interposing/Isolation Relay	Interposing/Isolation Relay
<b>Features</b>	<ul style="list-style-type: none"> <li>• Blade-style terminals</li> <li>• Standard ON/OFF flag indicator</li> <li>• Electrical schematic on face</li> <li>• Clear cover for visual inspection</li> <li>• Optional push-to-test and manual override</li> <li>• Optional LED</li> </ul>	<ul style="list-style-type: none"> <li>• Optional pilot light</li> <li>• Retainer clip (comes with socket)</li> <li>• Low switching capacity</li> <li>• Push-to-test and manual override</li> </ul>	<ul style="list-style-type: none"> <li>• Ideal for PLC Interfaces</li> <li>• Built-in Coil Surge Protection</li> <li>• Fully Assembled Relay/Socket</li> <li>• Standard LED</li> <li>• Relay or Solid-state Output</li> <li>• Optional: Leakage Current</li> <li>• Suppression Solution</li> </ul>	<ul style="list-style-type: none"> <li>• PCB "Pin Style" mounting</li> <li>• 5 mm pin spacing</li> </ul>
<b>Contact Ratings</b>				
<b>Contact Form</b>	DPDT, 4PDT	SPDT, DPDT	SPDT 1 N.O. (SSR)	DPDT
<b>Contact Type</b>	Single	Single	Single	Single
<b>Contact Material</b>	AgNi, AgNi + Gold	AgNi, AgNi + Gold	AgSnO	AgNi, AgNi + Gold
<b>Operating Current, Under Resistive Load, Max</b>	10 A (DPDT) 7 A (4PDT)	8 A (DPDT), 16 A (SPDT)	6 A (SPDT), 2 A (SSR DC output), 2 A (SSR AC output)	8 A
<b>Permissible Load, min</b>	10V, 10 mA (Gold), 5V, 10 mA or 25V, 2 mA (Silver)	5V 60 mA (Silver), 5V 10 mA (Gold)	12V 6 mA (72 mW) Silver 8V, 2.5 mA (20 mW) Gold	5V 5 mA (50 mW) Gold, 5V 5 mA (300 mW) Silver
<b>Coil Ratings</b>				
<b>Coil Voltage</b>	<b>AC:</b> 6, 12, 24, 120, 240V <b>DC:</b> 6, 12, 24, 48, 110V	<b>AC:</b> 6, 12, 24, 120, 240V <b>DC:</b> 6, 12, 24, 48, 110V	<b>AC:</b> 12, 24, 48, 110, 120, 230, 240V <b>DC:</b> 12, 24, 48, 125, 230, 240V	<b>AC:</b> 6, 12, 24, 120, 240V <b>DC:</b> 6, 12, 24, 48, 110V
<b>Permissible Coil Voltage Variation</b>	80...110% of nom voltage at 50 Hz 80...110% of nom voltage at 60 Hz 80...110% of nom voltage at DC	80...110% of nom voltage at 50 Hz 80...110% of nom voltage at 60 Hz 73...110% of nom voltage at DC	85...110% of nom voltage at 50 Hz 85...110% of nom voltage at 60 Hz 80...110% of nom voltage at DC	80...110% of nom voltage at 50 Hz 80...110% of nom voltage at 60 Hz 73...150% of nom voltage at DC
<b>Electrical Ratings</b>				
<b>Dielectric Withstand Voltage</b>	Pole-to-pole: 1000V Contact-to-coil: 2000V Contact-to-frame: 2000V	Pole-to-pole: 1500V Contact-to-coil: 1500V Contact-to-frame: 1500V	Pole-to-pole: 1000V Contact-to-coil: 4000V Contact-to-frame: 1500V	Pole-to-pole: 2000V Contact-to-coil: 5000V
<b>Electrical Service Life (Cycles)</b>	100,000 min	100,000 min	100,000 min	100,000 min
<b>Reference</b>				
<b>Certifications</b>	CE, cULus, cURus, CSA, Lloyds	CE, UL, UR, CSA	CE, cURus, cULus, ABS	CE, cULus, cURus, CSA, Lloyds
<b>Socket Catalog Numbers</b>	700-HN103, 700-HN128, 700-HN104	700-HN121, 700-HN221, 700-HN122, 700-HN222, 700-HN223, 700-HN224	—	700-HN123, 700-HN230
<b>Page Number</b>	<a href="#">39</a>	<a href="#">44</a>	<a href="#">50</a>	<a href="#">64</a>

			
<b>Bulletin Number</b>	<b>700-HJ</b>	<b>700-HG</b>	<b>700-HHF</b>
<b>Type</b>	Magnetic Latching Relay	Power Relay	Power Relay
<b>Features</b>	<ul style="list-style-type: none"> <li>• Socket mounted</li> <li>• Ideal for lighting applications</li> </ul>	<ul style="list-style-type: none"> <li>• Panel mount with screw terminals</li> <li>• Optional magnetic blowouts for switching DC loads</li> <li>• Optional snap action switch</li> </ul>	<ul style="list-style-type: none"> <li>• Flange mounted</li> <li>• Optional LED</li> </ul>
<b>Contact Ratings</b>			
<b>Contact Form</b>	SPDT, DPDT (Single or Dual Coil)	SPST-N.O.-DM, SPDT, DPST-N.O., DPDT	SPST-NO-DM, DPDT, 3PDT
<b>Contact Type</b>	Single	Single	Single
<b>Contact Material</b>	AgCdO	AgNi	AgNi
<b>Operating Current, Under Resistant Load, Max</b>	10 A	40 A	20 A (3PDT), 25 A (DPDT), 30 A (SPDT)
<b>Permissible Load, min</b>	10V 50 mA	10V 50 mA	10V 50 mA 10V 100 mA (3PDT)
<b>Coil Ratings</b>			
<b>Coil Voltage</b>	<b>AC:</b> 24V, 120V, 240V <b>DC:</b> 12V, 24V	<b>AC:</b> 24V, 120V, 240V, 277V, 480V <b>DC:</b> 12V, 24V, 48V, 110V, 220V, 250V	<b>AC:</b> 24V, 120V, 240V <b>DC:</b> 6V, 12V, 24V
<b>Permissible Coil Voltage Variation</b>	85...110% of nom voltage at 50 Hz 85...110% of nom voltage at 60 Hz 80...110% of nom voltage at DC	85...110% of nom voltage at 50 Hz 85...110% of nom voltage at 60 Hz 80...110% of nom voltage at DC	85...110% of nom voltage at 50 Hz 85...110% of nom voltage at 60 Hz 80...110% of nom voltage at DC
<b>Electrical Ratings</b>			
<b>Dielectric Withstand Voltage</b>	Pole-to-pole: 1500V AC Contact-to-coil: 1500V AC Contact-to-frame: 1500V AC	Pole-to-pole: 2200V AC Contact-to-coil: 2200V AC Contact-to-frame: 2200V AC	Pole-to-pole: 2200V AC Contact-to-coil: 2200V AC Contact-to-frame: 2200V AC
<b>Electrical Service Life (Cycles)</b>	100,000 minimum	100,000 minimum	100,000 minimum
<b>Reference</b>			
<b>Certifications</b>	CE, UR, CSA	CE, UL, CSA	CE, UR, CSA
<b>Socket Catalog Numbers</b>	700-HN153, 700-HN154	—	—
<b>Page Number</b>	<a href="#">71</a>	<a href="#">75</a>	<a href="#">80</a>

## 700-HA General-purpose Relay

- 10 A contact rating
- DPDT, 3PDT
- Pin-style terminals
- Standard ON/OFF flag indicator
- Options: LED, push-to-test and manual override, socket-mounted surge suppressor module, or multi-function timer
- Contact choices: standard silver nickel, or bifurcated silver nickel with gold plating



### Tube Base Relay with PIN Terminals (Single Contact) — Mechanical ON/OFF Indicator Included<sup>(1)</sup>

Description	Contact Rating	Wiring Diagrams		Coil Voltage	Cat. No. <sup>(1)</sup>
		U.S./Canada	International		
DPDT 2-pole 2 Form C Single AgNi Contact	10 A B300			6V AC	700-HA32A06
				12V AC	700-HA32A12
				24V AC	700-HA32A24
				120V AC	700-HA32A1
				240V AC	700-HA32A2
				277V AC	700-HA32A27
				6V DC	700-HA32Z06
				12V DC	700-HA32Z12
				24V DC	700-HA32Z24
				36V DC	700-HA32Z36
				48V DC	700-HA32Z48
				60V DC	700-HA32Z60
				80V DC	700-HA32Z80
				110V DC	700-HA32Z1
125V DC	700-HA32Z01				
Sockets		700-HN125	700-HN100 700-HN204	140V DC	700-HA32Z3
				220V DC	700-HA32Z2
3PDT 3-pole 3 Form C Single AgNi Contact	10 A B300			6V AC	700-HA33A06
				12V AC	700-HA33A12
				24V AC	700-HA33A24
				120V AC	700-HA33A1
				240V AC	700-HA33A2
				6V DC	700-HA33Z06
				12V DC	700-HA33Z12
				24V DC	700-HA33Z24
				48V DC	700-HA33Z48
				60V DC	700-HA33Z60
				80V DC	700-HA33Z80
				110V DC	700-HA33Z1
				125V DC	700-HA33Z01
				Sockets	
				220V DC	700-HA33Z2

(1) LED Option: Add suffix (-4) to the selected 700-HA Relay Cat. No., except for the 240V AC Units, add (-4L). Push-to-test, Manual Override, and LED Option: Add suffix (-3-4) to the selected 700-HA Relay Cat. No., except for the 240V AC units, add (-3-4L). Push-to-test and Manual Override option: Add suffix (-3) to the selected 700-HA relay. LED not available for 220V DC and 277V AC coils.

(1) For Time Modules and Surge Suppressor Modules, see Accessories.

**Tube Base Relay with PIN Terminals (Bifurcated Contacts with Gold Overlay) — Mechanical ON/OFF Indicator Included**

Description	Contact Rating	Wiring Diagrams		Coil Voltage	Cat. No				
		U.S./Canada	International						
DPDT 2-Pole 2 Form C Bifurcated AgNi Contacts with Gold Plating	6 A			6V AC	700-HAX2A06				
				12V AC	700-HAX2A12				
				24V AC	700-HAX2A24				
				120V AC	700-HAX2A1				
				240V AC	700-HAX2A2				
				277V AC	700-HAX2A27Δ				
				6V DC	700-HAX2Z06				
				12V DC	700-HAX2Z12				
				24V DC	700-HAX2Z24				
				36V DC	700-HAX2Z36				
				48V DC	700-HAX2Z48				
				110V DC	700-HAX2Z1				
Sockets		700-HN125	700-HN100 700-HN204	125V DC	700-HAX2Z01				
				140V DC	700-HAX2Z3				
3PDT 3-Pole 3 Form C Bifurcated AgNi Contacts with Gold Plating	6 A			6V AC	700-HAX3A06				
				12V AC	700-HAX3A12				
				24V AC	700-HAX3A24				
				120V AC	700-HAX3A1				
				240V AC	700-HAX3A2				
				6V DC	700-HAX3Z06				
				12V DC	700-HAX3Z12				
				24V DC	700-HAX3Z24				
				48V DC	700-HAX3Z48				
				110V DC	700-HAX3Z1				
				Sockets		700-HN126	700-HN101 700-HN205	125V DC	700-HAX3Z01
								140V DC	700-HAX3Z3

**Accessories - 700-HA Relays**







Photo	Description	Pkg. Qty.	Cat. No.
	<b>Screw Terminal Tube Base Socket — Panel or DIN Rail Mounting; Guarded Terminal Construction.</b> 8-Pin for use with DPDT 700-HA Relays, -HX Timing Relays, -HT (On-Delay), and -HRM, -HRC and -HV (Repeat Cycle) Timing Relays.	10	700-HN100
	<b>Screw Terminal Tube Base Socket — Panel or DIN Rail Mounting; Open Style Construction.</b> 8-Pin for use with DPDT 700-HA Relays, -HT (On-Delay) and -HRM, -HRC, and -HV (Repeat Cycle) Timing Relays. No retainer clip required.	10	700-HN125
	<b>Screw Terminal Tube Base Sockets — Panel or DIN Rail Mounting; Guarded Terminal Construction.</b> 11-pin for use with 3PDT 700-HA relays.	10	700-HN101
	<b>Screw Terminal Tube Base Sockets — Panel or DIN Rail Mounting; Open Style Terminal Construction.</b> 11-pin for use with 3PDT 700-HA relays. No retainer clip required.	10	700-HN126
	<b>8-Pin Socket — Can Be Used With or Without Timing Attachment or Surge Suppressor</b> Screw Terminal Tube Base Sockets — panel or DIN Rail mounting. Guarded terminal construction. Used with DPDT 700-HA Relays.	10	700-HN204
	<b>11-Pin Socket — Can Be Used With or Without Timing Module or Surge Suppressor.</b> Screw Terminal Tube Base Sockets — panel or DIN Rail mounting. Guarded terminal construction. Used with 3PDT 700-HA relays.	10	700-HN205
	<b>DIN (#3) symmetrical hat rail</b> 35 x 7.5 x 1 m	10	199-DR1











Photo	Description	Pkg. Qty.	Cat. No.
	<b>Diode Surge Suppressor</b> Voltage Range: 6...220V DC used with 700-HN204 and 700-HN205 socket	10	700-ADR
	<b>Diode with LED Surge Suppressor</b> Voltage Range: 6...24V DC used with 700-HN204 and 700-HN205 socket	10	700-ADL1R
	<b>Diode with LED Surge Suppressor</b> Voltage Range: 28...60V DC used with 700-HN204 and 700-HN205 socket	10	700-ADL2R
	<b>Diode with LED Surge Suppressor</b> Voltage Range: 110...220V DC used with 700-HN204 and 700-HN205 socket	10	700-ADL3R
	<b>Varistor with LED Surge Suppressor</b> Voltage Range: 6...24V AC used with 700-HN204 and 700-HN205 socket	10	700-AV1R
	<b>Varistor with LED Surge Suppressor</b> Voltage Range: 110...240V AC used with 700-HN204 and 700-HN205 socket	10	700-AV3R
	<b>RC Surge Suppressor</b> Voltage Range: 6...24V AC/DC used with 700-HN204 and 700-HN205 socket	10	700-AR1
	<b>RC Surge Suppressor</b> Voltage Range: 110...240V AC/DC used with 700-HN204 and 700-HN205 socket	10	700-AR2

Photo	Description	Pkg. Qty.	Cat. No.		
	<b>Timing Module</b> On-Delay or One-Shot selectable voltage range: 12...24V AC/DC used with sockets that accept plug-in accessory modules.	1	700-AT3		
	<b>Timing Module</b> On-Delay or One-Shot selectable voltage range: 110...125V AC used with sockets that accept plug-in accessory modules.	1	700-AT3A1		
	<b>Timing Module</b> On-Delay or One-Shot selectable voltage range: 230...240V AC used with sockets that accept plug-in accessory modules.	1	700-AT3A2		
	1. 1 s	0.05...1 s		1	700-HT3
	2. 10 s	0.5...10 s			
	3. 100 s	5...100 s			
	4. 10 min	0.5...10 min			
	5. 100 min	5...100 min			
	6. 10 hours	0.5...10 h			
	7. 100 hours	5...100 h			
	8. LED Indicator				

**Socket and Retainer Clip Reference**

Relay Type	Socket	Retainer Clip
700-HA32 700-HAX2	700-HN100 700-HN125 700-HN204	700-HN157 Not Required 700-HN157
700-HA33 700-HAX3	700-HN101 700-HN126 700-HN205	700-HN157 Not Required 700-HN157

## Specifications - 700-HA Relays

Attribute		700-HA		
<b>Electrical Ratings</b>				
Pilot Duty Rating <sup>(1)</sup>		NEMA B300		
Rated Thermal Current ( $I_{th}$ )		HA = 10 A – 120V, 240V; HAX = 6 A – 120V, 240V		
Rated Insulation Voltage ( $U$ )		250V IEC – 300V UL/CSA		
Contacts	Inductive	Make	Break	Hp
		► ] [ ◀	◀ ] [ ►	
	120VAC	30 A	3 A	1/3
	240VAC	15 A	1.5 A	1
	General-purpose	10 A, 240V AC		
Resistive	10 A, 30V DC			
Min. Low Energy Permissible Load		HA = 10V, 5 mA HAX = 5V, 2 mA		
Permissible Coil Voltage Variation		Pickup: 80...110% of nom voltage at 50 Hz, 80...110% of nom voltage at 60 Hz, 80...110% of nom voltage at DC		
Coil Consumption ± 10%	AC Coils	50 Hz	60 Hz	
	Inrush	3.3VA	2.85VA	
	Sealed	2.2VA	1.9VA	
	DC Coils	1.3 W		
Must Dropout Voltage		20% of nom V AC; 10% of nom V DC		
Max. Contact Resistance		50 M $\Omega$ (700-HA), 30 M $\Omega$ (700-HAX)		
<b>Design Specification/Test Requirements</b>				
<b>Electrical</b>				
Pole-to-Pole		2000V		
Contact to Coil		2000V		
Electrical Life (Operating)		100,000 min.		
<b>Mechanical</b>				
Degree of Protection (Open Type) IEC 529		IP 40		
Mechanical Lifecycles (AC/DC)		> 20 x 10 <sup>6</sup> / 50 x 10 <sup>6</sup>		
Switching Frequency Operations		3600/HR		
Coil Voltages		See Product Selection		
Operating Time	Pickup	12 ms		
	Dropout	12 ms		
Maximum Operating Rate		4 Ops/s		
Vibration	Endurance	5 G		
	Operational	2.5 G		
Shock	Endurance	50 G		
	Operational	9 G		
<b>Environmental</b>				
Temperature	Operating	AC/DC	-40...+70 °C (-40...+158 °F)	
	Storage	AC/DC	-40...+100 °C (-40...+212 °F)	
Altitude		2000 m (6560 ft)		
<b>Construction</b>				
Insulating Material		Molded High-Dielectric Material		
Enclosure		Transparent Dust Cover		
Contact Material	700-HA:	10 A – AgNi		
	700-HAX:	6 A – Bifurcated/Gold Plating AgNi		
Terminal Markings on Socket		In accordance with EN50 0005		
Sockets		8-Pin Socket — 700-HN100, -HN125, -HN204, 11-Pin Socket — 700-HN101, -HN126, -HN205		
Certifications		cURus Recognized (File No. E3125, Guide NLDX2/NLDX8), cULus Listed when used with 700-HN sockets noted (File No. E3125, Guide NLDX/NLDX7), CE Marked, CSA Certified, UR Certified (File 229473)		
Standards		UL508, CSA C22.2 No. 14, EN 61810-1		

(1) See [NEMA Ratings and Test Values on page 5](#)



## Relay Performance Graphs

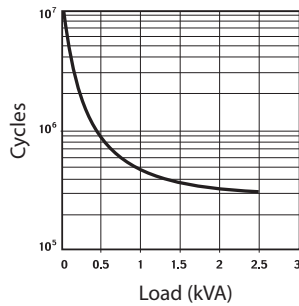

Contact life vs. AC1 load at 1,800 cycles/h

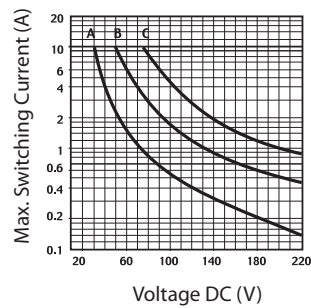

Breaking capacity for DC1 load at 1,800 cycles/h

A = load applied to one contact  
 B = load applied to two contacts in series  
 C = load applied to three contacts in series

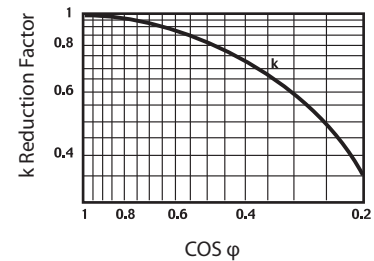

Load reduction factor vs. cos φ

## Specifications - 700-HT3 Time Module

Attribute	700-HT3	
<b>Electrical Ratings</b>		
Operating Voltage Range	12...240V AC (50/60 Hz) 12...240V DC	
Power Consumption	0.1 W (12V) 1.0 W (230V)	
<b>Mechanical</b>		
Degree of Protection of Input (B1) Terminal	IP 20 (Guarded Terminal)	
Input Terminal Wire Range	1.0 x 0.2 mm <sup>2</sup> ...2.5 mm <sup>2</sup> (24...14 AWG) 2.0 x 0.2 mm <sup>2</sup> ...1.5 mm <sup>2</sup> (24...16 AWG)	
Input Terminal Torque Range	0.45...0.8 N·m (4...7 lb·in)	
Status Indicator	Red	
Repeat Accuracy <sup>(1)</sup>	±1%	
Recovery Time	<50 ms	
Selectable Timing Ranges	Three DIP switches, seven ranges (set from 5...100% of range): 1 s, 10 s, 100 s, 10 min, 100 min, 10 h, 100 h	
Selectable Timing Modes	Three DIP switches, eight modes: 1. Power On-Delay 2. Power On One-Shot 3. Power On Repeat Cycle, On Start 4. Signal On-Delay and Signal Off-Delay 5. Signal Off-Delay 6. Signal On-One-Shot 7. Signal Off-One-Shot 8. Signal On and Signal Off Watchdog Monitor	
Adjustable Trimmer Scale Accuracy	±5% of Time Range	
<b>Environmental</b>		
Temperature	Operating	-20...+50 °C (-4...+122 °F)
	Storage	-55...+85 °C (-67...+185 °F)
Altitude	2000 m (6560 ft)	
<b>Construction</b>		
Enclosure	Gray Plastic Housing	
Mounting with Socket Only	8- or 11-Pin Socket with Module Plug	
Sockets	700-HN204 (8-Pin with Plug), 700-HN205 (11-Pin with Plug)	
Certifications	cURus Recognized (File No. E14843, Guide NRNT2/NRNT8), CE Marked	
Standards	UL508, CSA C22.2 No. 14, EN 61810-1	

(1) At constant voltage and temperature.

## Timing Charts - 700-HT3 Multi-function Time Module (t = Time Range 0.05 s...100 h)

**Terms:**

- U** is Power Input
- R** is Relay Output
- S** Signal, +A1 Socket, B1 Timer
- t** is the resulting Time Delay (Red light-emitting diode)

**1. Power On-delay**

Apply power (U) to timer. Relay contacts (R) change state after time delay (t) is complete. Contacts return to their shelf state when power is removed. Terminal B1 is not used in this mode.



**3. Power On Repeat Cycle, On Start**

Apply power (U) to timer. Relay contacts (R) change state immediately and the time delay (t) begins. When the time delay is complete, the contacts return to their shelf state for time delay (t) (time on = time-off). This cycle repeats until the power is removed. Terminal B1 is not used in this mode.

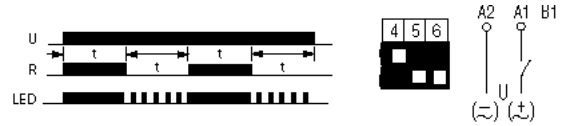

**2. Power On One-shot**

Apply power (U) to timer. Relay contacts (R) change state immediately and the time delay begins. When the time delay (t) is complete, contacts return to their shelf state. Contacts return to their shelf state when power is removed. Terminal B1 is not used in this mode.



**4. Signal On-delay and Signal Off-delay**

Apply power (U) to timer. When the signal (S) is closed the time delay (t) begins, after the time delay is completed the relay contacts (R) change state. Opening the signal starts the time delay, after the time delay is completed the contacts return to their shelf state. If the signal is closed or opened before the time delay is complete, the time delay is reset. Contacts return to their shelf state when power is removed.

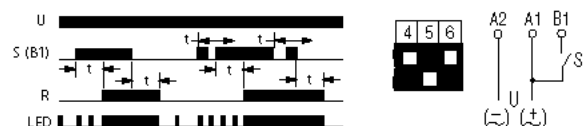

## Timing Charts -Cat. No. 700-HT3 Timing Modes, Time Description, Timing Charts, and DIP Switch Selections

**Terms:**

- U** is Power Input
- R** is Relay Output
- S** Signal, +A1 Socket, B1 Timer
- t** is the resulting Time Delay (Red light-emitting diode)

**5. Signal Off-delay**

Apply power (U) to timer. When the signal (S) is closed, the relay contacts (R) change state immediately and the time delay (t) begins. If the signal is closed before the time delay is complete, the time delay is reset and the relay remains energized. When the time delay is complete, the contacts return to their shelf state. Contacts return to their shelf state when power is removed.

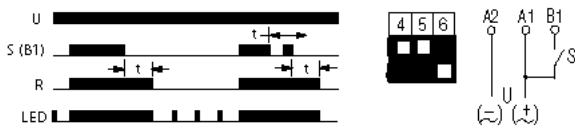

**7. Signal Off One-shot**

Apply power (U) to timer. When the signal (S) is closed and then opened, the relay contacts (R) change state immediately and the time delay (t) begins. After the time delay begins, opening or closing the signal will not reset the time delay. When the time delay is complete, the contacts return to their shelf state. Contacts return to their shelf state when power is removed.

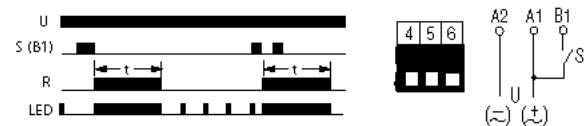

**6. Signal On One-shot**

Apply power (U) to timer. When the signal (S) is closed, the relay contacts (R) change state immediately and the time delay (t) begins. After the time delay begins, opening or closing the signal will not reset the time delay. When the time delay is complete, the contacts return to their shelf state. Contacts return to their shelf state when power is removed.

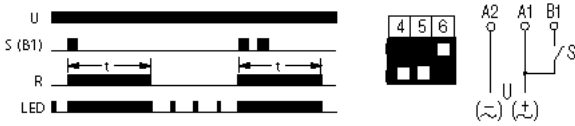

**8. Signal On and Signal Off Watchdog Monitor**

Apply power (U) to timer. When the signal (S) is closed, the relay contacts (R) energize immediately and the time delay (t) begins. If the signal is opened before the time delay is complete, the relay remains energized and the time delay is reset. When the time delay is complete, the contacts return to their shelf state. If the signal is opened after the time delay is complete, the relay contacts energize immediately and the same time delay begins. Continuous cycling of the signal at a rate that is faster than the time delay causes the relay contacts to remain energized. Contacts return to their shelf state when power is removed.

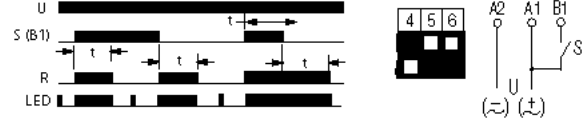

### Dimensions -700-HA Relays

Approximate dimensions are shown in millimeters (inches). Dimensions are not intended for manufacturing purposes.

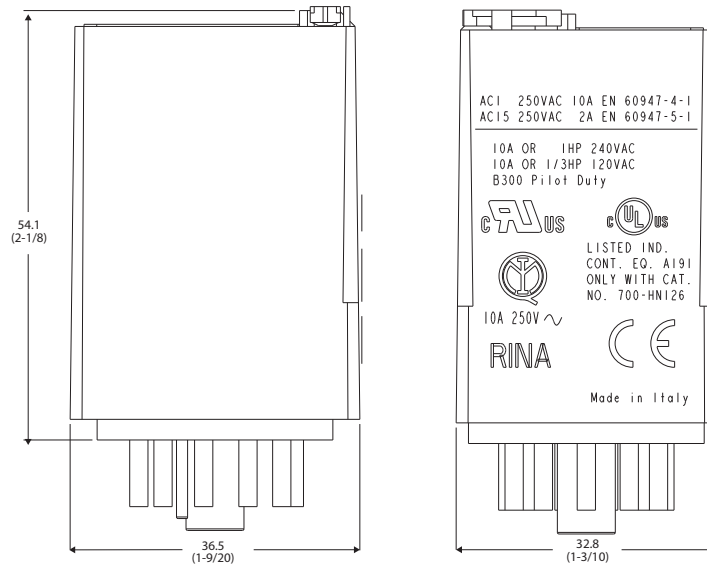

700-HA Relay

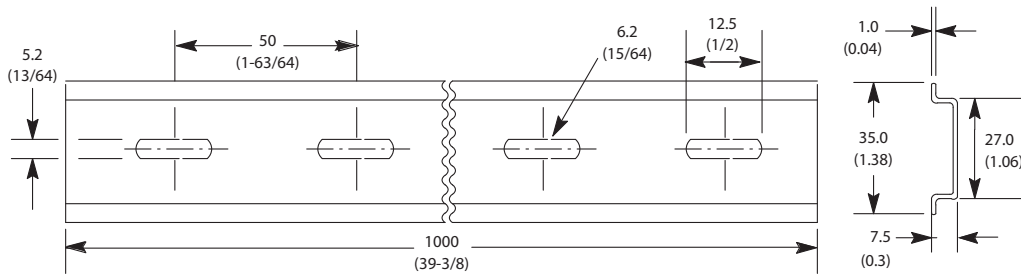

Cat. No. 199-DR1 DIN Mounting Rail Series B  
 Cat. No. 199-DR4 DIN Mounting Rail Series B Has No Mounting Holes

Cat. No.	A	B	C	D	Approx. Shipping Wt.
199-DR1	35 (1-3/8)	27 (1-1/16)	7.5 (19/64)	1.02 (1/64)	1.85 kg (4.07 lb) (10/pkg)
199-DR4	35 (1-3/8)	27 (1-1/16)	15 (19/32)	2.3 (3/32)	3.68 kg (8 lb) (5/pkg)

Approximate dimensions are shown in millimeters (inches). Dimensions are not intended for manufacturing purposes.

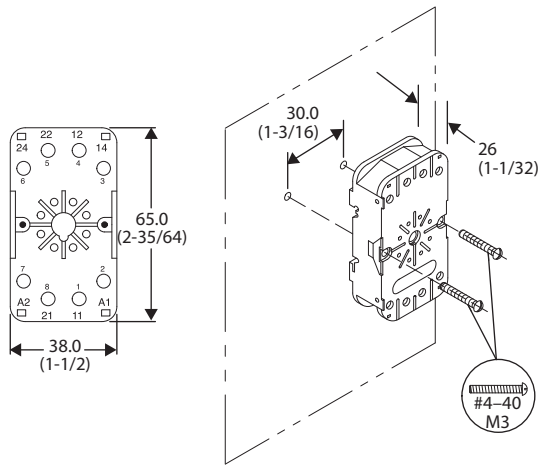

Cat. No. 700-HN100

Panel Mounting

Wire Size:  $2 \times 2.5 \text{ mm}^2$   
 Single Wire – Up to #12 AWG  
 Double Wire –  $2 \times 2.5 \text{ mm}^2$  (#2-14 AWG... #2-20 AWG)  
 (Either Solid or Stranded)  
 Strip Length: 9 mm (3/8 in.) – Torque: 0.8 N·m (7 lb·in)

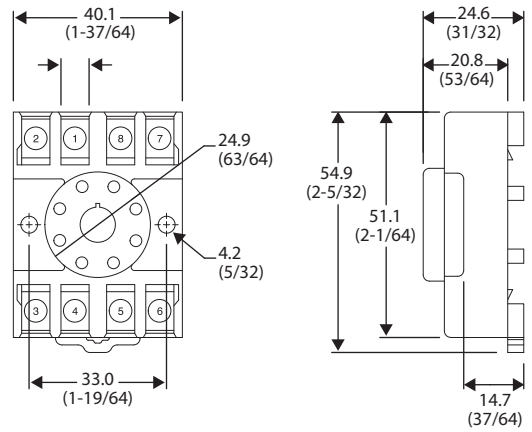

Cat. No. 700-HN125

Wire Size:  $2 \times 2.5 \text{ mm}^2$   
 Single Wire – Up to #12 AWG  
 Double Wire –  $2 \times 2.5 \text{ mm}^2$  (#2-14 AWG... #2-20 AWG)  
 (Either Solid or Stranded)  
 Strip Length: 9 mm (3/8 in.) – Torque: 0.8 N·m (7 lb·in)

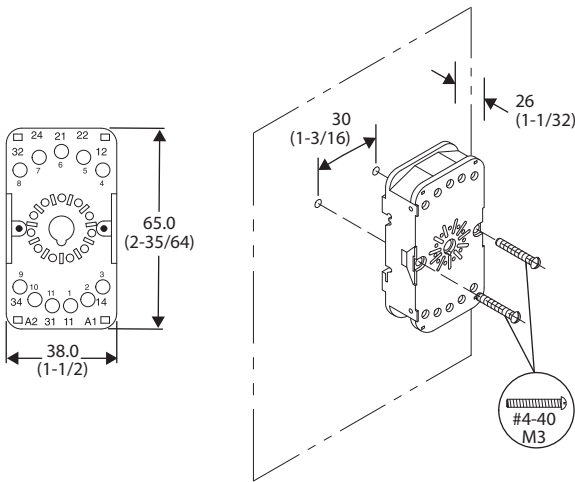

Cat. No. 700-HN101

Panel Mounting

Wire Size:  $2 \times 2.5 \text{ mm}^2$   
 Single Wire – Up to #12 AWG  
 Double Wire –  $2 \times 2.5 \text{ mm}^2$  (#2-14 AWG... #2-20 AWG)  
 (Either Solid or Stranded)  
 Strip Length: 9 mm (3/8 in.) – Torque: 0.8 N·m (7 lb·in)

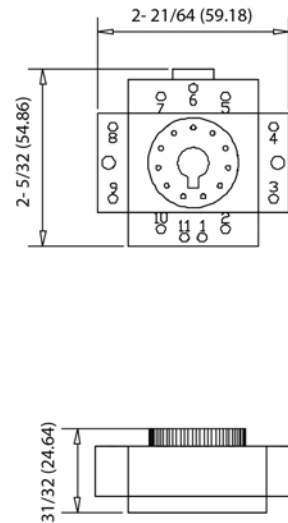

Cat. No. 700-HN126

Wire Size:  $2 \times 2.5 \text{ mm}^2$   
 Single Wire – Up to #12 AWG  
 Double Wire –  $2 \times 2.5 \text{ mm}^2$  (#2-14 AWG... #2-20 AWG)  
 (Either Solid or Stranded)  
 Strip Length: 9 mm (3/8 in.) – Torque: 0.8 N·m (7 lb·in)

Approximate dimensions are shown in millimeters (inches). Dimensions are not intended for manufacturing purposes.

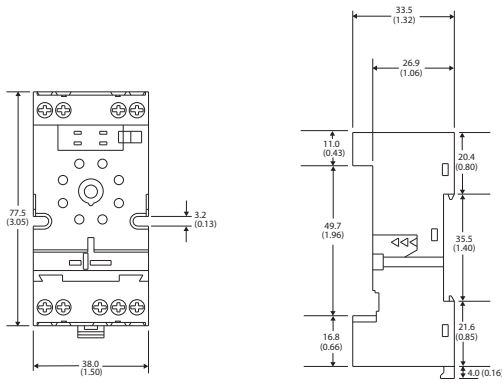

Cat. No. 700-HN204

Wire Size:  $2 \times 2.5 \text{ mm}^2$   
 Single Wire – Up to #12 AWG  
 Double Wire –  $2 \times 2.5 \text{ mm}^2$  (14 AWG . . . 20 AWG) Qty. 2 wires  
 (Either Solid or Stranded)  
 Strip Length: 9 mm (3/8 in.) – Torque: 0.8 N·m (7 lb·in)

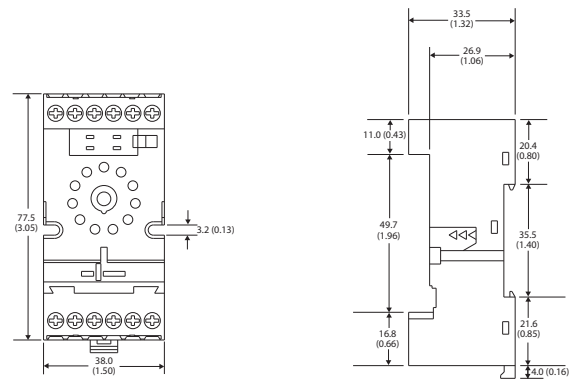

Cat. No. 700-HN205

Wire Size:  $2 \times 2.5 \text{ mm}^2$   
 Single Wire – Up to #12 AWG  
 Double Wire –  $2 \times 2.5 \text{ mm}^2$  (14 AWG . . . 20 AWG) Qty. 2 wires  
 (Either Solid or Stranded)  
 Strip Length: 9 mm (3/8 in.) – Torque: 0.8 N·m (7 lb·in)

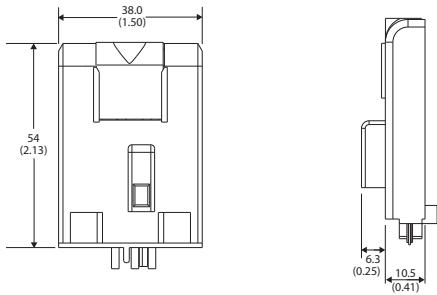

Cat. No. 700-HT3

Wire Size:  $2 \times 1.5 \text{ mm}^2$  (#2 – 16 AWG . . . #1–20 AWG)  
 (Either Solid or Stranded)  
 Strip Length: 9 mm (3/8 in.) – Torque: 0.8 N·m (7 lb·in)

## 700-HB Square Base Relay

- 15 A contact rating
- DPDT, 3PDT
- Blade-style quick connect /solder terminals (Faston 187 - 4.8 x 0.5 mm)
- Standard ON/OFF flag indicator
- Options: LED, push-to-rest, and manual override



Photo	Description	Contact Rating	Wiring Diagrams		Coil Voltage	Cat. No. <sup>(1)</sup>
			U.S./Canada	International		
	DPDT 2-Pole 2 Form C Single AgCdO Contact	15 A B300			6V AC	700-HB32A06
					12V AC	700-HB32A12
					24V AC	700-HB32A24
					120V AC	700-HB32A1
					240V AC	700-HB32A2
					6V DC	700-HB32Z06
					12V DC	700-HB32Z12
					24V DC	700-HB32Z24
					48V DC	700-HB32Z48
					Sockets	
	3PDT 3-Pole 3 Form C Single AgCdO Contact	15 A B300			6V AC	700-HB33A06
					12V AC	700-HB33A12
					24V AC	700-HB33A24
					120V AC	700-HB33A1
					240V AC	700-HB33A2
					6V DC	700-HB33Z06
					12V DC	700-HB33Z12
					24V DC	700-HB33Z24
					48V DC	700-HB33Z48
					Sockets	

(1) LED Option: Add suffix (-4) to the selected 700-HB Relay Cat. No., except for the 240V AC Units, add (-4L).  
 Push-to-test, Manual Override, and LED Option: Add suffix (-3-4) to the selected 700-HB Relay Cat. No., except for the 240V AC units, add (-3-4L)  
 Push-to-test and Manual Override option: Add suffix (-3) to the selected 700-HB relay.

Accessories - 700-HB Relays



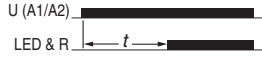





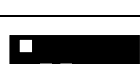

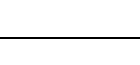



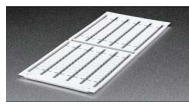

Photo	Description	Pkg. Qty.	Cat. No.		
	<b>Diode Surge Suppressor</b> Voltage Range: 6...220V DC used with 700-HN204 and 700-HN205 socket	10	700-ADR		
	<b>Diode with LED Surge Suppressor</b> Voltage Range: 6...24V DC used with 700-HN204 and 700-HN205 socket	10	700-ADL1R		
	<b>Diode with LED Surge Suppressor</b> Voltage Range: 28...60V DC used with 700-HN204 and 700-HN205 socket	10	700-ADL2R		
	<b>Diode with LED Surge Suppressor</b> Voltage Range: 110...220V DC used with 700-HN204 and 700-HN205 socket	10	700-ADL3R		
	<b>Varistor with LED Surge Suppressor</b> Voltage Range: 6...24V AC used with 700-HN204 and 700-HN205 socket	10	700-AV1R		
	<b>Varistor with LED Surge Suppressor</b> Voltage Range: 110...240V AC used with 700-HN204 and 700-HN205 socket	10	700-AV3R		
	<b>RC Surge Suppressor</b> Voltage Range: 6...24V AC/DC used with 700-HN204 and 700-HN205 socket	10	700-AR1		
	<b>RC Surge Suppressor</b> Voltage Range: 110...240V AC/DC used with 700-HN204 and 700-HN205 socket	10	700-AR2		
	<b>Timing Module</b> On-Delay or One-Shot selectable voltage range: 12...24V AC/DC used with sockets that accept plug-in accessory modules.	On-Delay U (A1/A2)  LED & R	1	700-AT3	
	<b>Timing Module</b> On-Delay or One-Shot selectable voltage range: 110...125V AC used with sockets that accept plug-in accessory modules.	One-Shot U (A1/A2)  LED & R	1	700-AT3A1	
	<b>Timing Module</b> On-Delay or One-Shot selectable voltage range: 230...240V AC used with sockets that accept plug-in accessory modules.		1	700-AT3A2	
	1. 1 s	0.05 s...1 s		1	700-HT3
	2. 10 s	0.5 s...10 s			
	3. 100 s	5 s...100 s			
	4. 10 min	0.5 min...10 min			
	5. 100 min	5 min...100 min			
	6. 10 hours	0.5 h...10 h			
	7. 100 hours	5 h...100 h			
	8. LED Indicator				

Photo	Description	Pkg. Qty.	Cat. No.
	<b>Screw Terminal Socket — Panel or DIN Rail Mounting. Guarded Terminal Construction</b> 11-blade socket for use with 700-HB relays. This socket has coil and contact separation as well as the ability to use optional plug-in modules (700-A___ accessories, LED, surge suppression, timing modules).	10	700-HN153
	<b>Screw Terminal Base Socket — Panel or DIN Rail Mounting. Open Style Construction</b> 11-blade for use with 700-HB relays.	10	700-HN154
	<b>DIN (#3) symmetrical hat rail</b> 35 x 7.5 x 1 m	10	199-DR1
	<b>Retainer Clip</b> <b>For Cat. Nos. 700-HN154 Sockets with 700-HB Relays</b> Secures relay in socket. Order must be for 10 clips or multiples of 10.	10	700-HN156
	<b>Retainer Clip</b> <b>For Cat. Nos. 700-HN153 Sockets with 700-HB Relays</b> Secures relay in socket. Order must be for 10 clips or multiples of 10.	10	700-HN158
	<b>Relay Identification Snap-in Markers</b> Snap-in markers fit on top of product covers. The following are blank cards. Squares slip into molded slot on top of product covers.	100	1492-MS5X12
			1492-MS6X9
			1492-MS6X12
			1492-MS8X9
			1492-MS8X12
	<b>Pre-Printed Identification Tags</b> — contains 10 sheets of pre-printed and blank tags. Each sheet contains 13 sets of the markings CR...9CR, TR...9TR, M...9M, F, R, 1S, and 117 blank tags. Tags are peel-off with sticky backing for easy placement on relays.	10	700-N40
	<b>Blank Identification Tags</b> — contains 10 sheets of blank identification tags for customer specialized printing. Each sheet contains 546 blank tags. Tags are peel-off with sticky backing for easy placement on relays.	10	700-N41

**Socket and Retainer Clip Reference**

Relay Type	Socket Cat. No.	Retainer Clip Cat. No.
700-HB	700-HN153	700-HN158
	700-HN154	700-HN156



## Specifications - 700-HB Relays

Attribute		700-HB				
<b>Electrical Ratings</b>						
Pilot Duty Rating <sup>(1)</sup>		NEMA B300				
Rated Thermal Current ( $I_{th}$ )		15 A – 120V, 240V				
Rated Insulation Voltage ( $U_i$ )		250V IEC-300V UL/CSA				
Contacts	Inductive	Make ▶   ◀		Break ◀   ▶		Hp
		2 -Pole	3 -Pole	2 -Pole	3 -Pole	
		120V AC	60 A	30 A	6 A	3 A
	240V AC	30 A	15 A	3 A	1.5 A	2
	General-purpose	15 A, 240V AC				
Resistive	15 A, 30V DC					
Min. Low Energy Permissible Load		1000 mW (10V, 10 mA)				
Permissible Coil Voltage Variation		80...110% of Nominal Voltage at 50 Hz				
		80...110% of Nominal Voltage at 60 Hz				
		80...110% of Nominal Voltage at DC				
Coil Consumption ±10%	AC Coils	<b>50 Hz</b>		<b>60 Hz</b>		
	Inrush	3.3VA		2.85VA		
	Sealed	2.2VA		1.9VA		
	DC Coils	1.3 W				
Max. Allowable Leakage		25% of VA				
		10% of W				
Max. Contact Resistance		50 MΩ				
<b>Design Specification/Test Requirements</b>						
Dielectric Withstand Voltage						
Pole-to-Pole		2500V				
Contact to Coil		4000V				
<b>Mechanical</b>						
Degree of Protection (Open Type) IEC 529		IP 40				
Mechanical lifecycles (AC/DC)		$> 10 \times 10^6 / 30 \times 10^6$				
Switching Frequency Operations		3600/HR				
Coil Voltages		See Overview/Product Selection				
Operating Time (ms)	Pickup	20 ms				
	Dropout	4 ms				
Maximum Operating Rate		4 Ops/s				
Vibration	Endurance	5 G				
	Operational	1.5 G				
Shock	Endurance	50 G				
	Operational	15 G				
<b>Environmental</b>						
Temperature	Operating	AC/DC	-40...+70 °C (-40...+158 °F)			
	Storage	AC/DC	-40...+100 °C (-40...+212 °F)			
Altitude		2000 m (6560 ft)				
<b>Construction</b>						
Insulating Material		Molded High Dielectric Material				
Enclosure		Transparent Dust Cover				
Contact Material		AgCdO				
Terminal Markings on Socket		In accordance with EN50 0005				
Sockets		700-HN153, -HN154				
Certifications		cURus Recognized (File No. E3125, Guide NLDX2/NLDX8), cULus Listed when used with 700-HN sockets noted				
Standards		UL508, CSA C22.2 No. 14, EN 61810-1				

(1) See [NEMA Ratings and Test Values on page 5](#)

### Technical Data - 700-HB Relays

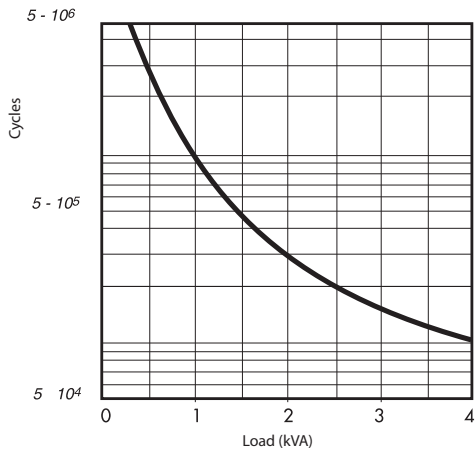

Contact life versus AC1 load at 600 cycles/h.

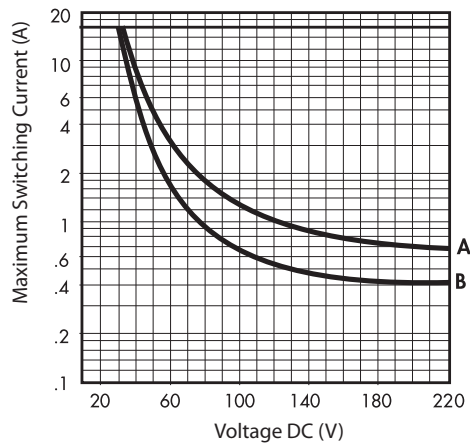

Breaking capacity for DC1 load at 600 cycles/h.  
Load applied to one contact.  
A = for N.O. types  
B = other types

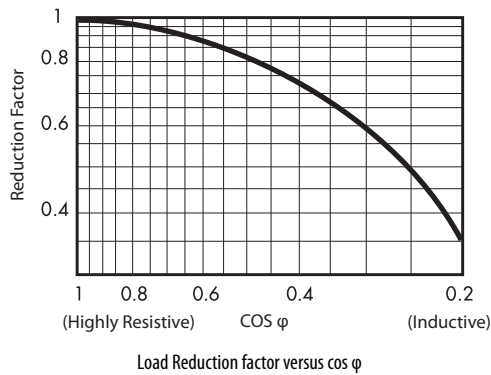

Load Reduction factor versus cos φ

### Dimensions - 700-HB Relays

Approximate Dimensions are shown in millimeters (inches). Dimensions are not intended for manufacturing purposes.

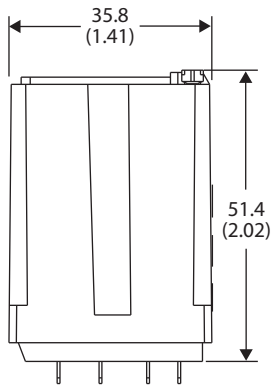

700-HB Relay

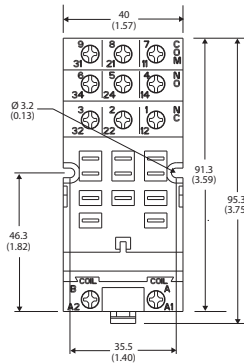
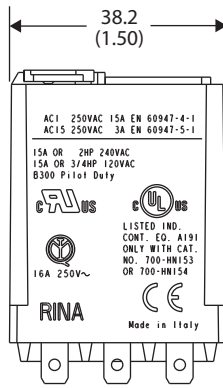

Cat. No. 700-HN153

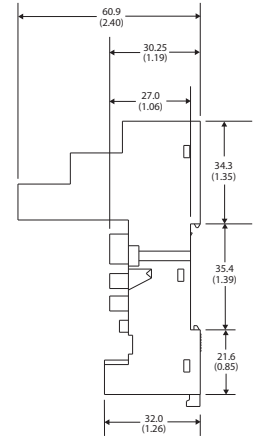

Wire Size:  $2 \times 2.5 \text{ mm}^2$   
 Single Wire – Up to #12 AWG  
 Double Wire –  $2 \times 2.5 \text{ mm}^2$  (14 AWG... 20 AWG), Qty. 2 wires  
 (Either Solid or Stranded)  
 Strip Length: 9 mm (3/8 in.) – Torque: 0.8 N·m (7 lb·in)

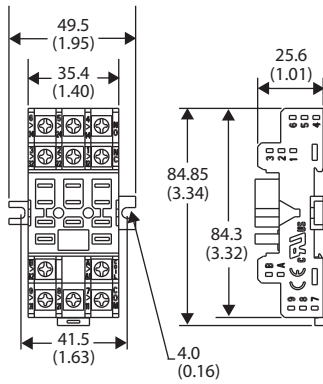

Cat. No. 700-HN154

Wire Size:  $2 \times 2.5 \text{ mm}^2$   
 Single Wire – Up to #12 AWG  
 Double Wire –  $2 \times 2.5 \text{ mm}^2$  (14 AWG... 20 AWG), Qty. 2 wires  
 (Either Solid or Stranded)  
 Strip Length: 9 mm (3/8 in.) – Torque: 0.8 N·m (7 lb·in)

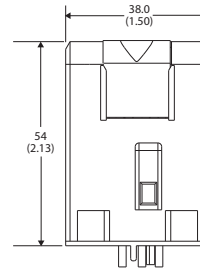
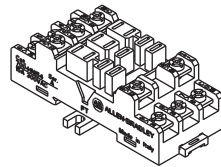

Cat. No. 700-HT3

Wire Size:  $2 \times 1.5 \text{ mm}^2$  (#2 – 16 AWG... #1–20 AWG)  
 (Either Solid or Stranded)  
 Strip Length: 9 mm (3/8 in.) – Torque: 0.8 N·m (7 lb·in)

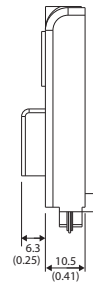

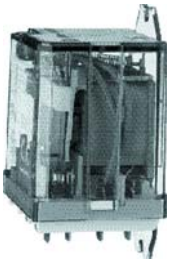
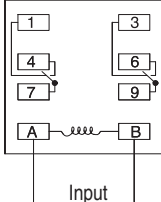
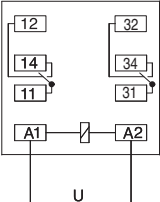

## 700-HD Flange Mount Square Base Relay

- Flange-mounted/panel-mounted
- 15 A contact rating
- DPDT, 3PDT
- Blade-style quick connect terminals (0.187 x 0.020)
- Solder terminals (no socket required)

Photo	Contact Rating		Wiring Diagrams		Coil Voltage	Cat. No.
			U.S./Canada	International		
	DPDT 2-Pole 2 Form C AgCdO Contacts	15 A			6V AC	700-HD32A06
					12V AC	700-HD32A12
					24V AC	700-HD32A24
					120V AC	700-HD32A1
					208V AC	700-HD32A20
					240V AC	700-HD32A2
					6V DC	700-HD32Z06
					12V DC	700-HD32Z12
					24V DC	700-HD32Z24
					48V DC	700-HD32Z48
					110V DC	700-HD32Z1
					6V AC	700-HD33A06
					12V AC	700-HD33A12
					24V AC	700-HD33A24
120V AC	700-HD33A1					
208V AC	700-HD33A20					
240V AC	700-HD33A2					
6V DC	700-HD33Z06					
12V DC	700-HD33Z12					
24V DC	700-HD33Z24					
48V DC	700-HD33Z48					
110V DC	700-HD33Z1					

### Accessories - 700-HD Relays

Photo	Description	Pkg. Qty.	Cat. No.
	<b>Relay Identification Snap-in Markers</b> Snap-in markers fit on top of product covers. The following are blank cards. Squares slip into molded slot on top of product covers.	100	1492-MS5X12
			1492-MS6X9
			1492-MS6X12
			1492-MS8X9
			1492-MS8X12
			1492-MP-Blank
	<b>Pre-Printed Identification Tags</b> — contains 10 sheets of pre-printed and blank tags. Each sheet contains 13 sets of the markings CR...9CR, TR...9TR, M...9M, F, R, 1S, and 117 blank tags. Tags are peel-off with sticky backing for easy placement on relays.	10	700-N40
		<b>Blank Identification Tags</b> — contains 10 sheets of blank identification tags for customer specialized printing. Each sheet contains 546 blank tags. Tags are peel-off with sticky backing for easy placement on relays.	10

## Specifications - 700-HD Relays

Attribute		700-HD				
<b>Electrical Ratings</b>						
Pilot Duty Rating <sup>(1)</sup>		NEMA B300				
Rated Thermal Current ( $I_{th}$ )		15 A <sup>(2)</sup> – 120V 15 A <sup>(2)</sup> – 240V,				
Rated Insulation Voltage ( $U_i$ )		250V IEC-300V UL/CSA				
Contacts	Inductive	<b>Make</b> ▶ ◀		<b>Break</b> ◀ ▶		<b>Hp</b>
		2-Pole	3-Pole	2-Pole	3-Pole	
	120VAC	60 A	30 A	6 A	3 A	3/4
	240VAC	30 A	15 A	3 A	1.5 A	2
	General-purpose	15 A, 240V AC				
	Resistive	15 A, 30V DC				
Min. Low Energy Permissible Load		1000 mW (10V, 10 mA)				
Permissible Coil Voltage Variation		80...110% of Nominal Voltage at 50 Hz 80...110% of Nominal Voltage at 60 Hz 80...110% of Nominal Voltage at DC				
Coil Consumption ±10%	AC Coils	50 Hz		60 Hz		
	Inrush	3.3VA		2.85VA		
	Sealed	2.2VA		1.9VA		
	DC Coils	1.3 W				
Maximum Contact Resistance		50 MΩ				
Must Dropout Voltage		20% of Nominal V AC 10% of Nominal V DC				
<b>Design Specification/Test Requirements</b>						
<b>Electrical</b>						
Dielectric Withstand Voltage	Pole-to-Pole	2500V				
	Contact to Coil	4000V				
<b>Mechanical</b>						
Degree of Protection (Open Type) IEC 529		IP 40				
Mechanical lifecycles (AC/DC)		See Overview/Product Selection				
Switching Frequency Operations		3600/HR				
Coil Voltages		$> 10 \times 10^6 / 30 \times 10^6$				
Operating Time	Pickup	20 ms				
	Dropout	4 ms				
Maximum Operating Rate		4 Ops/s				
Minimum Low Energy Permissible Load		1000 mN (10V, 10 mA)				
<b>Environmental</b>						
Temperature	Operating	-40...+70 °C (-40...+158 °F)				
	Storage	-40...+100 °C (-40...+212 °F)				
Altitude		2000 m (6560 ft)				

<b>Attribute</b>	<b>700-HD</b>
<b>Construction</b>	
Insulating Material	Molded High Dielectric Material
Enclosure	Transparent Dust Cover
Contact Material	Silver Cad. Ox.
Terminal Markings	In accordance with EN50 0005
Certifications	cURs Recognized (File No. E3125, Guide NLDX2/NLDX8), CSA Certified (File No. 229473), CE Marked, UR Certified
Standards	UL 508, CSA C22.2 No. 14, EN 61810-1

- (1) See [NEMA Ratings and Test Values on page 5](#).
- (2) 3-pole relays have a 20 A maximum total current rating for all three poles.

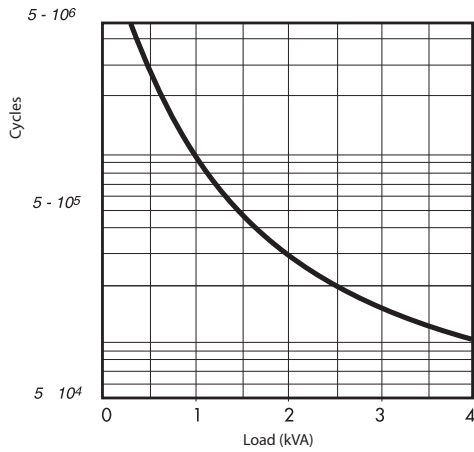

Contact life versus AC1 load at 600 cycles/h.

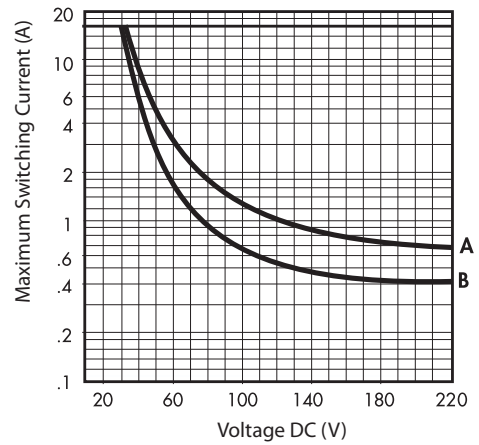

Breaking capacity for DC1 load at 600 cycles/h.

Load applied to one contact.  
 A = for N.O. types  
 B = other types

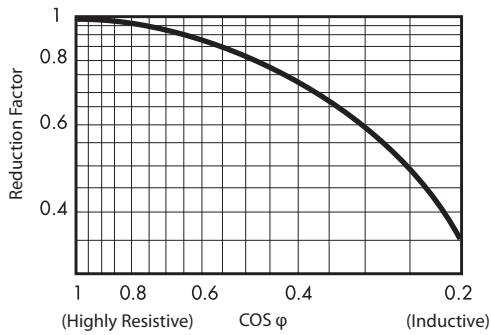

Load Reduction factor versus cos φ

## Dimensions - 700-HD Relays

Approximate dimensions are shown in millimeters (inches). Dimensions are not intended for manufacturing purposes.

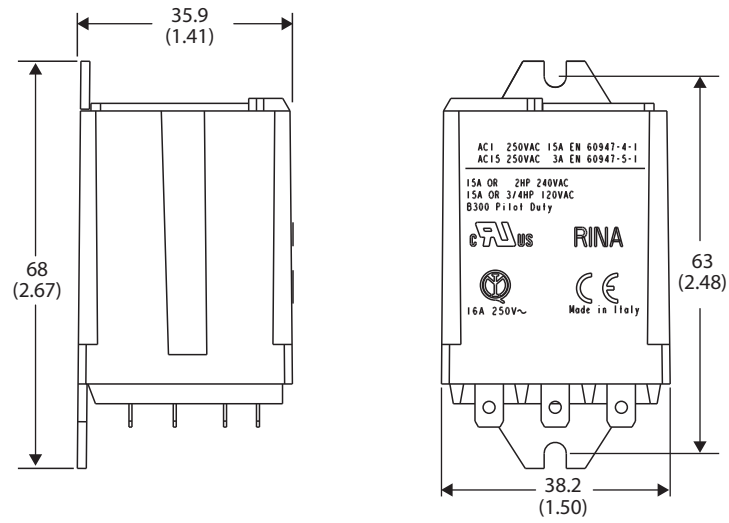



700-HD Relay

## 700-HF Square Base Relay

- 12 A contact rating
- DPDT, 4PDT
- Plug-in quick connect/solder terminals
- Options: LED, push-to-test manual override operator
- Blade size: 4.8 x 0.5 mm (0.19 x 0.02 in.)

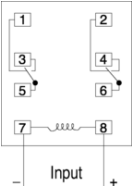

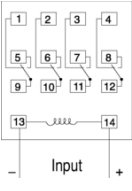
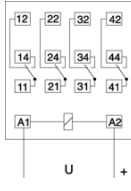
Photo	Description	Contact Rating	Wiring Diagrams		Coil Voltage	Cat. No. <sup>(1)</sup>
			U.S./Canada	International		
	DPDT 2-pole 2 Form C AgCdO Contacts	12 A			6V AC	700-HF32A06
					12V AC	700-HF32A12
					24V AC	700-HF32A24
					120V AC	700-HF32A1
					240V AC	700-HF32A2
					6V DC	700-HF32Z06
					12V DC	700-HF32Z12
					24V DC	700-HF32Z24
			48V DC	700-HF32Z48		
	Socket		700-HN116 700-HN262	700-HN116 700-HN262	110V DC	700-HF32Z1
	4PDT 4-pole 4 Form C AgCdO Contact	12 A			6V AC	700-HF34A06
					12V AC	700-HF34A12
					24V AC	700-HF34A24
					120V AC	700-HF34A1
					240V AC	700-HF34A2
					6V DC	700-HF34Z06
					12V DC	700-HF34Z12
					24V DC	700-HF34Z24
			48V DC	700-HF34Z48		
	Socket		700-HN139 700-HN264	700-HN139 700-HN264	110V DC	700-HF34Z1



(1) Pilot Light Option: Add suffix (-4) to the selected 700-HF Relay Cat. No. except for the 240V AC units, add (-4L).  
 Manual Operator and LED Option: Add suffix (-3-4) to the selected 700-HF Relay Cat. No., except for the 240V AC units, add (-3-4L).



## Accessories - 700-HF Relays

Photo	Description	Pkg. Qty.	Cat. No.
	<b>Pre-Printed Identification Tags</b> — contains 10 sheets of pre-printed and blank tags. Each sheet contains 13 sets of the markings CR...9CR, TR...9TR, M...9M, F, R, 1S, and 117 blank tags. Tags are peel-off with sticky backing for easy placement on relays.	10	700-N40
	<b>Blank Identification Tags</b> — contains 10 sheets of blank identification tags for customer specialized printing. Each sheet contains 546 blank tags. Tags are peel-off with sticky backing for easy placement on relays.	10	700-N41
	<b>Screw Terminal Socket — Panel or DIN Rail Mounting 8-blade miniature socket</b> for use with DPDT HF relays.	10	700-HN116
	<b>Screw Terminal Socket — Panel or DIN Rail Mounting, Guarded Terminal Construction</b> 8-blade socket for use with DPDT 700-HF relays. The socket has the ability to use optional plug-in modules (Cat. No. 700-A__ accessories, LED, surge suppression, timing modules).	10	700-HN262
	<b>Screw Terminal Socket — Panel or DIN Rail Mounting, Guarded Terminal Construction</b> 14-blade socket for use with 4PDT 700-HF relays.	10	700-HN139
	<b>Screw Terminal Socket — Panel or DIN Rail Mounting, Guarded Terminal Construction</b> 14-blade socket for use with 4PDT 700-HF relays. The socket has coil and contact separation and the ability to use optional plug-in modules (Cat. No. 700-A__ accessories, LED, surge suppression, timing modules).	10	700-HN264
	<b>DIN (#3) symmetrical hat rail</b> 35 x 7.5 x 1 m	10	199-DR1
	<b>Retainer Clip for Cat. Nos. 700-HN103, -HN104 and -HN128 Sockets with 700-HC Relays and Cat. Nos. 700-HN116, 700-HN262 Sockets with 700-HF DPDT Relays</b> Secures relay in socket. Order must be for 10 clips or multiples of 10.	10	700-HN114
	<b>Retainer Clip for Cat. Nos. 700-HN139 and -HN264 Sockets with 700-HF 4PDT Relays</b> Secures relay in socket. Order must be for 10 clips or multiples of 10.	10	700-HN266

### Accessories - 700-HF Relays

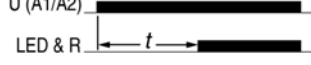
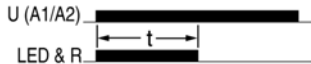
Photo	Description	Pkg. Qty.	Cat. No.
	<b>Diode with LED Surge Suppressor</b> Voltage Range: 6...24V DC used with sockets that accept plug-in accessory modules.	10	700-ADL1
	<b>Diode with LED Surge Suppressor</b> Voltage Range: 28...60V DC used with sockets that accept plug-in accessory modules.	10	700-ADL2
	<b>Diode with LED Surge Suppressor</b> Voltage Range: 110...220V DC used with sockets that accept plug-in accessory modules.	10	700-ADL3
	<b>Varistor with LED Surge Suppressor</b> Voltage Range: 6...24V AC used with sockets that accept plug-in accessory modules.	10	700-AV1R
	<b>Varistor with LED Surge Suppressor</b> Voltage Range: 110...240V AC used with sockets that accept plug-in accessory modules.	10	700-AV3R
	<b>RC Surge Suppressor</b> Voltage Range: 6...24V AC/DC used with sockets that accept plug-in accessory modules.	10	700-AR1
	<b>RC Surge Suppressor</b> Voltage Range: 110...240V AC/DC used with sockets that accept plug-in accessory modules.	10	700-AR2
	<b>Timing Module</b> On-Delay or One-Shot selectable voltage range: 12...24V AC/DC used with sockets that accept plug-in accessory modules.	On-Delay  One-Shot 	700-AT3
	<b>Timing Module</b> On-Delay or One-Shot selectable voltage range: 110...125V AC used with sockets that accept plug-in accessory modules.		700-AT3A1
	<b>Timing Module</b> On-Delay or One-Shot selectable voltage range: 230...240V AC used with sockets that accept plug-in accessory modules.		700-AT3A2

### Socket, and Retainer Clip Reference

Relay Type	Cat. No. Socket	Cat. No. Retainer Clip
700-HF32	700-HN116 700-HN262	700-HN114
700-HF34	700-HN139 700-HN264	700-HN266

## Specifications- 700-HF Relays

Electrical Ratings		700-HF 2 Pole	700-HF 4 Pole	
Contacts	Inductive V AC	230V AC	AC 15 @ 700 VA AC-1 @ 3000 VA 1 Hp @ 240V AC	
		120V AC	1/2 Hp @ 120V AC	
	VDC	DC-1	12 A @ 30V DC	12 A @ 30V DC
			0.5 A @ 110V DC	0.5 A @ 110V DC
			0.25 A @ 220V DC	0.25 A @ 220V DC
	Resistive	AC	12 A @ 250 V AC (per pole)	12 A @ 250 V AC (per pole)
DC		12 A @ 30 V DC (per pole)	12 A @ 30 V DC (per pole)	
Operating Range		AC	80...110% nom voltage	
		DC	85...110% nom voltage	
Rated Power	AC (50 Hz)	1.5 VA	2 VA	
	DC	1 W	1.3 W	
Holding Voltage	AC	80% nom voltage		
	DC	60% nom voltage		
Must Drop Out Voltage	AC	20% nom voltage		
	DC	10% nom voltage		
Insulation Voltage		250V AC		
<b>Design Specification/Test Requirements</b>				
Dielectric Withstand Voltage	Pole-to-Pole	2500V AC		
	Contact to Pole	2500V AC		
<b>Mechanical</b>				
Degree of Protection		Open Type (Sockets)		
Mechanical Life Operations		20 x 10 <sup>6</sup>		
Switching Frequency Operations		3600/hr		
Coil Voltages		See Product Selection		
Operating Time at nom voltage at 20 °C	Pickup	8 ms	10 ms	
	Dropout	3 ms	4 ms	
Maximum Operating Rate		4 Ops/s		
Vibration		15 G		
Shock		15 G		
<b>Environmental</b>				
Temperature	Operating	-40...+70 °C (-40...+268 °F)		
	Storage	-50...+80 °C (-89...+176 °F)		
Altitude		2000 m (6560 ft)		
<b>Construction</b>				
Insulating Material		Molded High-Dielectric Material		
Enclosure		Transparent Dust Cover		
Contact Material		Silver Cad. Oxide		
Terminal Markings on Socket		In accordance with EN50 0005		
Sockets		8-Blade Socket (DPDT) Cat. No. 700-HN116 & 700-HN262, 14-Blade Socket (4PDT) Cat. No. 700-HN139 & 700-HN264		
Certifications		CSA Certified (File No. 229473), UL Recognized (File No. E3125, Guide NLDX2/NLDX8), CE Marked, UL Listed when used with sockets shown above, (File No. E3125, Guide NLDX/NLDX 7), LR Certified, RINA Certified, IMQ Certified		
Standards		UL 508, CSA 22.2 No. 14, EN-61810-1		

### Dimensions -700-HF Relays

Approximate Dimensions are shown in millimeters (inches). Approximate Dimensions are not intended to be used for manufacturing purposes.

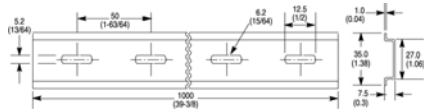
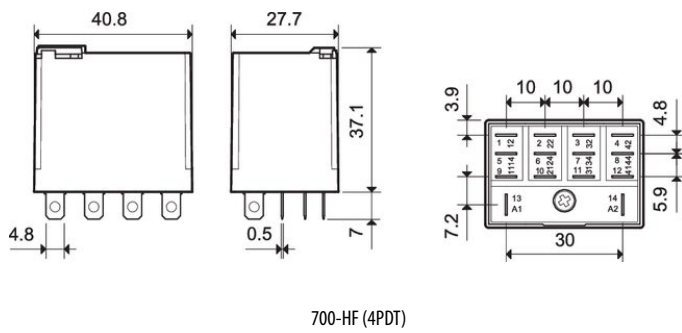
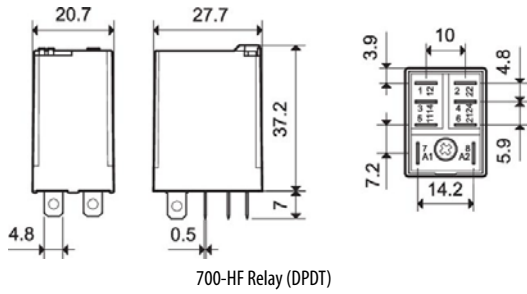

Cat. No. 199-DR1 DIN Mounting Rail Series B  
 Cat. No. 199-DR4 DIN Mounting Rail Series B Has No Mounting Holes

Cat. No.	A	B	C	D	Approx. Shipping Wt.
199-DR1	35 (1-3/8)	27 (1-1/16)	7.5 (19/64)	1.02 (1/64)	1.85 kg (4.07 lb) (10/pkg)
199-DR4	35 (1-3/8)	27 (1-1/16)	15 (19/32)	2.3 (3/32)	3.68 kg (8 lb) (5/pkg)

## Dimensions - 700-HF Relays

Approximate Dimensions are shown in millimeters (inches). Approximate Dimensions are not intended to be used for manufacturing purposes.

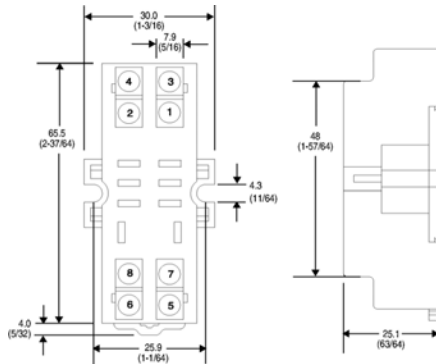

Cat. No. 700-HN116

Wire Size:  $2 \times 2.5 \text{ mm}^2$

Single Wire – Up to #12 AWG

Double Wire –  $2.5 \text{ mm}^2$  (14 ... 20 AWG), Qty. 2 wires

(Either Solid or Stranded)

Strip Length: 9 mm (3/8 in.) – Torque: 0.8 N•m (7 lb•in)

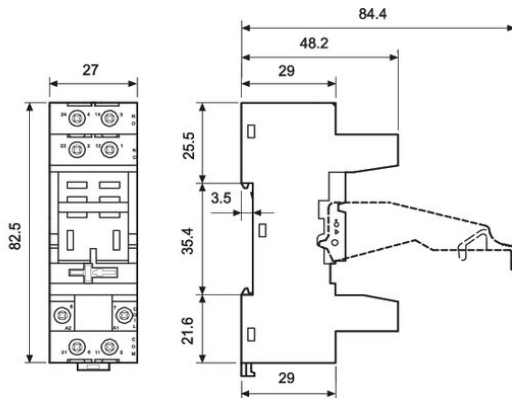

Cat. No. 700-HN262

Wire Size: Solid -  $1 \times 6 / 2 \times 2.5 \text{ mm}^2$

$1 \times 10 / 2 \times 14$  AWG

Stranded -  $1 \times 4 / 2 \times 2.5 \text{ mm}^2$

$1 \times 12 / 2 \times 14$  AWG

Length: 9 mm (3/8 in.) - Torque: 0.8 N•m (7 lb•in)

300V AC, 12 A, 50 °C

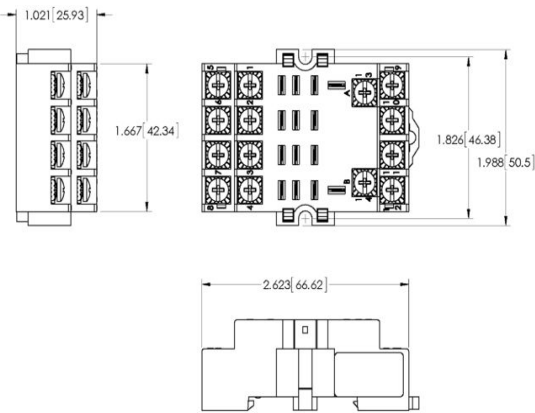

Cat. No. 700-HN139  
 Wire Size: 2 x 2.5 mm<sup>2</sup>  
 Single Wire – Up to #12 AWG  
 Double Wire – 2.5 mm<sup>2</sup> (14 . . . 20 AWG), Qty. 2 wires  
 (Either Solid or Stranded)  
 Strip Length: 9 mm (3/8 in.) – Torque: 0.8 N•m (7 lb•in)

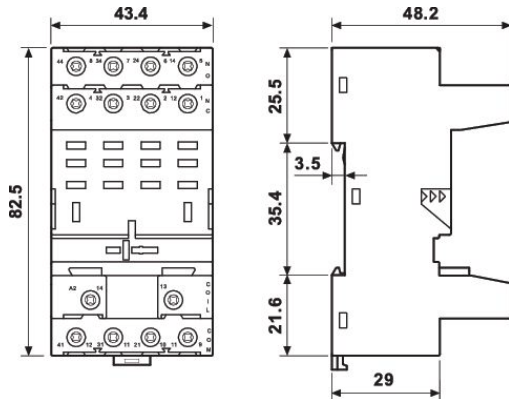

Cat. No. 700-HN264  
 Wire Size: Solid - 1x6 / 2 x 2.5 mm<sup>2</sup>  
 1x10 / 2x14 AWG  
 Stranded - 1x4 / 2x2.5 mm<sup>2</sup>  
 1x12 / 2x14 AWG  
 Length: 9 mm (3/8 in.) - Torque: 0.8 N•m (7 lb•in)  
 300V AC, 10 A, 70 °C

### 700-HC Miniature Ice Cube Relay

- 7 or 10 A contact ratings
- 2PDT or 4PDT
- Standard ON/OFF flag indicator
- Blade-style terminals (2.0 x 0.5 mm)
- Choice of standard silver nickel contacts, or silver nickel with gold-plated contacts for low-energy applications
- Options: LED, push-to-test with manual override option
- Tungsten UL Approvals
  - 4-Pole: 5A @ 24V DC
  - 2-Pole: 10A @ 24V DC



Photo	Contact Rating		Wiring Diagrams		Coil Voltage	Cat. No. <sup>(1)</sup>					
			U.S./Canada	International							
	2PDT 2-Pole 2 Form C Contacts: 10 A = AgNi Contacts	10 A C300 R300 Low energy rating; (10V, 10 mA) 100 mW			12V DC	700-HC22Z12					
							24V DC	700-HC22Z24			
							24V AC	700-HC22A24			
							120V AC	700-HC22A1			
				700-HN128	700-HN103 700-HN104	240V AC	700-HC22A2				
		4PDT 4-Pole 4 Form C Contacts: 7A = AgNiAu Gold Plated Contacts	7 A Low energy rating; (5V, 10 mA or 25V, 2 mA) 50 mW			6V AC	700-HC14A06				
										12V AC	700-HC14A12
										24V AC	700-HC14A24
										120V AC	700-HC14A1
										240V AC	700-HC14A2
										6V DC	700-HC14Z06
										12V DC	700-HC14Z12
									24V DC	700-HC14Z24	
									48V DC	700-HC14Z48	
									110V DC	700-HC14Z1	
	4PDT 4-Pole 4 Form C Contacts: 7A = AgNi Silver Contacts	7 A C300 R300 Low energy rating; (10V, 10 mA) 100 mW			6V AC	700-HC24A06					
									12V AC	700-HC24A12	
									24V AC	700-HC24A24	
									120V AC	700-HC24A1	
									240V AC	700-HC24A2	
									6V DC	700-HC24Z06	
									12V DC	700-HC24Z12	
									24V DC	700-HC24Z24	
								700-HN103	48V DC	700-HC24Z48	
								700-HN104	110V DC	700-HC24Z1	

(1) LED Option: Add suffix (-4) to the selected 700-HC Relay catalog number, except for the 240V AC units, add (-4L).  
 Push-to-test, Manual Override, and LED Option: Add suffix (-3-4) to the selected 700-HC catalog number, except for the 240V AC units, add (-3-4L).  
 Push-to-test and Manual Override option: Add suffix (-3) to the selected 700-HC relay catalog number.

Accessories - 700-HC Relays





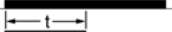
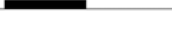





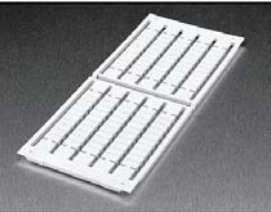

Photo	Description	Pkg. Qty.	Cat. No.
	<b>Diode with LED Surge Suppressor</b> Voltage Range: 6...24V DC used with 700-HN104 socket	10	700-ADL1
	<b>Diode with LED Surge Suppressor</b> Voltage Range: 28...60V DC used with 700-HN104 socket	10	700-ADL2
	<b>Diode with LED Surge Suppressor</b> Voltage Range: 110...220V DC used with 700-HN104 socket	10	700-ADL3
	<b>Varistor with LED Surge Suppressor</b> Voltage Range: 6...24V AC used with 700-HN104 socket	10	700-AV1R
	<b>Varistor with LED Surge Suppressor</b> Voltage Range: 110...240V AC used with 700-HN104 socket	10	700-AV3R
	<b>RC Surge Suppressor</b> Voltage Range: 6...24V AC/DC used with 700-HN104 socket	10	700-AR1
	<b>RC Surge Suppressor</b> Voltage Range: 110...240V AC/DC used with 700-HN104 socket	10	700-AR2
	<b>Timing Module</b> On-Delay or One-Shot selectable voltage range: 12...24V AC/DC used with sockets that accept plug-in accessory modules.	On-Delay U (A1/A2)  LED & R   One-Shot U (A1/A2)  LED & R 	700-AT3
	<b>Timing Module</b> On-Delay or One-Shot selectable voltage range: 110...125V AC used with sockets that accept plug-in accessory modules.		700-AT3A1
	<b>Timing Module</b> On-Delay or One-Shot selectable voltage range: 230...240V AC used with sockets that accept plug-in accessory modules.		700-AT3A2
	Screw Terminal Socket — Panel or DIN Rail Mounting; Guarded Terminal Construction. $I_{th} = 10$ A per pole. 14-blade miniature socket for use with 700-SC Relays.	10	700-HN103
	Screw Terminal Socket — Panel or DIN Rail Mounting; Guarded Terminal Construction $I_{th} = 10$ A per pole. 14-blade miniature socket for use with 700-HC relays. This socket has coil and contact separation as well as the ability to plug in optional plug in modules (700-A__ accessories: LED, Surge Suppression, Timing Modules)	10	700-HN104
	Screw Terminal Base Socket — Panel or DIN Rail Mounting; Open-Style Construction $I_{th} = 10$ A per pole. 14-blade miniature socket for use with 700-HC Relays.	10	700-HN128



Photo	Description	Pkg. Qty.	Cat. No.
	<b>DIN (#3) symmetrical hat rail</b> 35 x 7.5 x 1 m	10	199-DR1
	<b>Retainer Clip for Cat. Nos. 700-HN103, -HN104 and -HN128 Sockets with 700-HC Relays.</b> Secures relay in socket. <sup>(1)</sup>	10	700-HN114
	<b>Plastic Retainer and Ejection Lever</b> For use with the 700-HN104 Sockets for 700-HC relays. Built-in ability to accept 1492 Snap-in Markers	10	700-HN124

(1) See 700-HC Miniature Square Base Relay, Socket, and Retainer Clip Reference Chart.

Photo	Description	Pkg. Qty.	Cat. No.
	<b>Relay Identification Snap-in Markers</b> Snap-in markers fit on top of product covers. Squares slip into molded slot on top of product cover.	5	1492-MS5X12
		5	1492-MS6X9
		5	1492-MS6X12
		5	1492-MS8X9
		5	1492-MS8X12
		100	1492-MP-Blank
	<b>Pre-Printed Identification Tags</b> — contains 10 sheets of pre-printed and blank tags. Each sheet contains 13 sets of the markings CR...9CR, TR...9TR, M...9M, F, R, 1S, and 117 blank tags. Tags are peel-off with sticky backing for easy placement on relays.	10	700-N40
	<b>Markers — Used for terminal identification</b>	50	700-N41

### Socket and Retainer Clip Reference

Relay Type	Socket Cat. No.	Retainer Clip Cat. No.
700-HC	700-HN103	700-HN114
	700-HN128	700-HN114
	700-HN104	700-HN114 or 700-HN124

### Specifications- 700-HC Relays

Attribute		700-HC					
<b>Electrical Ratings</b>							
<b>Pilot Duty Rating</b> <sup>(1)</sup>		NEMA C300, R300					
<b>Rated Thermal Current</b> ( $I_{th}$ )		7 A and 10 A					
<b>Rated Insulation Voltage</b> ( $U_i$ )		250V IEC – 300V UL/CSA					
<b>Contacts</b>	<b>Inductive</b>	700-HC_4		Hp	700-HC22		Hp
		Make ▶] [◀	Break ◀] [▶		Make ▶] [◀	Break ◀] [▶	
	<b>120VAC</b>	15 A	1.5 A	1/8	15 A	1.5 A	1/3
	<b>240VAC</b>	7.5 A	0.75 A	1/3	7.5 A	0.75 A	3/4
	<b>General-purpose</b>	7 A, 277V AC			10 A, 277V AC		
<b>Resistive</b>	7 A, 30V DC			10 A, 24V DC			
<b>Min. Low Energy Permissible Load</b>		100 mW (10V, 10 mA) - Silver Contacts 50 mW (5V, 10 mA, or 25V, 2 mA) - Gold Contacts					
<b>Permissible Coil Voltage Variation</b>		Pickup:	80...110% of nom voltage at 50 Hz 80...110% of nom voltage at 60 Hz 80...110% of nom voltage at DC		Must Dropout Voltage:	20% of nom voltage at AC 10% of nom voltage at DC	
		50 Hz		60 Hz			
<b>Coil Consumption</b> ±10%	<b>AC Coils</b>	<b>Inrush</b>	2.2VA		1.6VA		
		<b>Sealed</b>	1.3VA		1.1VA		
	<b>DC Coils</b>	1.0 W					
<b>Max. Allowable Leakage</b>		20% of VA (AC) 10% of W (DC)					
<b>Design Specification/Test Requirements</b>							
<b>Electrical</b>							
<b>Dielectric Withstand Voltage</b>	<b>Pole-to-Pole</b>	2000V					
	<b>Contact to Coil</b>	2000V					
<b>Electrical Life (Cycles)</b>		100,000 min					
<b>Mechanical</b>							
<b>Degree of Protection (Open Type) IEC 529</b>		IP 20 (Guarded Terminal Sockets)					
<b>Mechanical lifecycles</b>		20 x 10 <sup>6</sup> (AC), 50 x 10 <sup>6</sup> (DC)					
<b>Switching Frequency Operations</b>		1800/HR					
<b>Coil Voltages</b>		See Product Selection					
<b>Operating Time</b>	<b>Pickup</b>	10 ms					
	<b>Dropout</b>	3 ms					
<b>Maximum Operating Rate</b>		8 cycles/s					
<b>Environmental</b>							
<b>Temperature</b>	<b>Operating</b>	-30...+55 °C (-22...+131 °F)					
	<b>Storage</b>	-55...+85 °C (-67...+185 °F)					
<b>Altitude</b>		2000 m (6560 ft)					
<b>Insulating Material</b>		Molded High Dielectric Material					
<b>Enclosure</b>		Transparent Dust Cover					
<b>Contact Material</b>		AgNi(700-HC2), AgNi + 5 μm AlI (700-HC1)					
<b>Terminal Markings on Socket</b>		In accordance with EN50 0005					
<b>Sockets</b>		700-HN103, -HN128, -HN104					
<b>Certifications</b>		cURus Recognized (File No. E14843, Guide NRNT2/NRNT8), cULus Listed when used with 700- HN103, -HN104, and -HN128 sockets (File No. E14843, Guide NRNT/NRNT7), CE Marked, LR Certified					
<b>Standards</b>		UL 508, CSA 22.2 No. 14, EN 61810-1					

(1) See [General Information on page 3](#).

### Dimensions, 700-HC Relays

Approximate dimensions are shown in millimeters (inches). Dimensions are not intended for manufacturing purposes.

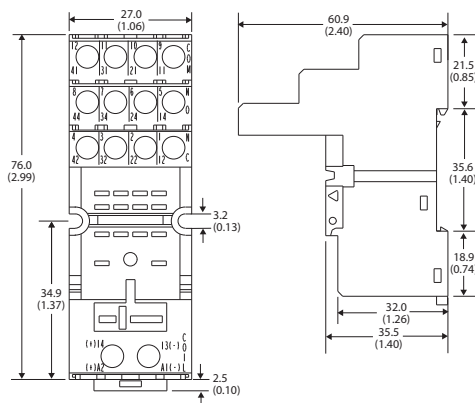
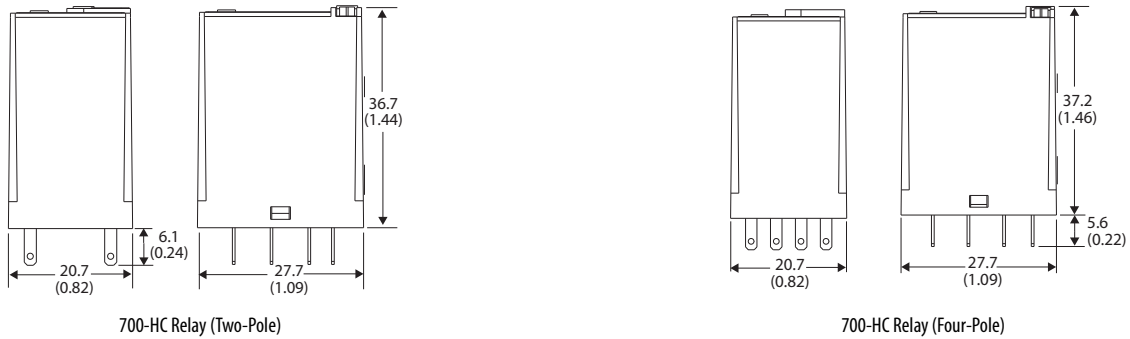

Cat. No. 700-HN104

Single Wire: 0.2 mm<sup>2</sup> ... 2.5 mm<sup>2</sup> (24 AWG ... 14 AWG), Double Wire: 0.2 ... 2.5 mm<sup>2</sup> (24 AWG ... 14 AWG), Qty. 2 wires  
 Wire Type: solid or stranded, copper only, Strip Length: 7 mm (9/32 in.), Torque: 0.5 N·m (4.4 lb-in)

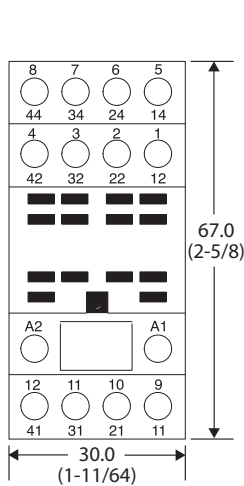

Cat. No. 700-HN103

Single Wire: 0.2 mm<sup>2</sup> ... 2.5 mm<sup>2</sup> (#24 AWG ... 14 AWG)  
 Double Wire: 0.2 ... 2 x 1.5 mm<sup>2</sup> (24 AWG ... 16 AWG), Qty. 2 wires  
 Wire Type: Solid or Stranded, Copper only  
 Strip Length: 8 mm (5/16 in.), Torque: 0.5 N·m (4.4 lb-in)

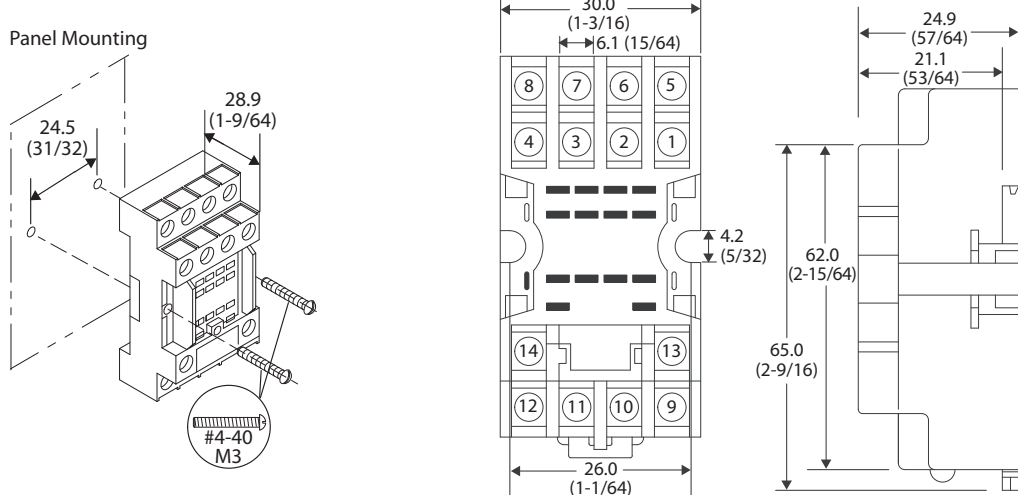

Cat. No. 700-HN128

Wire Size: 2 x 1.5 mm<sup>2</sup> (#2-16 AWG ... #1-20 AWG)  
 (Either Solid or Stranded)  
 Strip Length: 9 mm (3/8 in.) – Torque: 0.8 N·m (7 lb-in)

## 700-HK Slim Line Relay

- 8 A/16 A contact ratings
- DPDT/SPDT
- Plug-in blade-style terminals (2.5 x 0.5 mm)
- Retainer clip with sockets
- Options: LED, push-to-test and manual override, socket-mounted surge suppressor module, or timer module
- Standard ON/OFF flag indicator
- Relay faceplate accepts optional Bulletin 1492 snap-in markers
- Choice of standard silver/nickel contacts or silver/nickel with gold plated contacts
- Maximum duty version available



Photo	Description	Contact Rating	Wiring Diagrams		Coil Voltage	Cat. No. <sup>(1)</sup>
			U.S./Canada	International		
	SPDT 1-Pole 1 Form C AgNi Contacts	16 A			6V AC	700-HK36A06
					12V AC	700-HK36A12
					24V AC	700-HK36A24
					120V AC	700-HK36A1
					240V AC	700-HK36A2
					6V DC	700-HK36Z06
					12V DC	700-HK36Z12
					24V DC	700-HK36Z24
					48V DC	700-HK36Z48
					Socket	
	DPDT 2-Pole 2 Form C AgNi Contacts	8 A			6V AC	700-HK32A06
					12V AC	700-HK32A12
					24V AC	700-HK32A24
					120V AC	700-HK32A1
					240V AC	700-HK32A2
					6V DC	700-HK32Z06
					12V DC	700-HK32Z12
					24V DC	700-HK32Z24
					48V DC	700-HK32Z48
					Socket	

**(1) Options**

Pilot Light: Add suffix (-4) to the selected 700-HK Relay catalog number except for the 240V AC units, add (-4L).

Manual Operator and LED: Add suffix (-3-4) to the selected 700-HK Relay catalog number, except for the 240V AC units, add (-3-4L).

AgNi Contact with Gold plating: Replace "3" with "X" on catalog number. For example, if catalog number 700-HK36A1 is required with gold plating, the new catalog number is 700-HKX6A1.

For high inductive, Tungsten, or Capacitive load applications, replace the "3" with a "M" in the catalog number. Only available in a SPDT configuration and with 24V DC, 120V AC, or 240V AC coil voltages.

## Accessories- 700-HK Relays

Photo	Description	Pkg. Qty.	Cat. No.
	<b>Screw Terminal Socket — Panel or DIN Rail Mounting</b> 5-blade miniature socket with 10 A rating for use with 1-pole, 700-HK relays. Accepts forked lug conductors. Socket includes a retainer clip.	10	700-HN121
	<b>Screw Terminal Socket — Panel or DIN Rail Mounting</b> 5-blade miniature socket with 16 A rating for use with 1-pole, 700-HK relays. Retainer clips are packaged separately with socket. Guarded terminal construction and compatible with optional plug-in module accessories.	10	700-HN221
	<b>Spring Clamp Terminal Socket — Panel or DIN Rail Mounting</b> 5-blade miniature socket for use with 1-pole, 700-HK relays.	10	700-HN223
	<b>Screw Terminal Socket — Panel or DIN Rail Mounting</b> 8-blade miniature socket with 5 A rating for use with 2-pole, 700-HK relays. Accepts forked lug conductors. This socket includes a retainer clip.	10	700-HN122
	<b>Screw Terminal Socket — Panel or DIN Rail Mounting</b> 8-blade miniature socket with 8 A rating for use with 2-pole, 700-HK relays. Retainer clips are packaged separately with socket. Guarded terminal construction and compatible with optional plug-in module accessories.	10	700-HN222
	<b>Spring Clamp Terminal Socket — Panel or DIN Rail Mounting</b> 8-blade miniature socket for use with 2-pole 700-HK relays.	10	700-HN224
	<b>Flange Mount Adapter</b> Used for panel-mounting bulletin 700-HK relays. Order must be for 10 adapters or multiples of 10.	10	700-HN226
	<b>35 mm Rail Mount Adapter</b> Mounts bulletin 700-HK relays to a 35 mm rail. Order must be for 10 adapters or multiples of 10.	10	700-HN227
	<b>Socket Retainer Clip and Ejection Lever</b> For use with 700-HN22, -HN222, -HN223, and -HN224 sockets. Orders must be for 10 clips or multiples of 10.	10	700-HN229

## Specifications- 700-HK Relays

Attribute		700-HK			
<b>Electrical Ratings</b>					
<b>Rated Thermal Current (<math>I_{th}</math>)</b>		1-Pole, 1 CO, SPDT — 16 A		2-Pole, 2 CO, DPDT — 8 A	
<b>Rated Insulation Voltage (<math>U_i</math>)</b>		250V IEC, 300V UL/CSA			
<b>Contacts</b>	<b>Inductive V AC</b>	120V AC	AC-15, 6.2 A B300 Pilot Duty, 3 A A300 (700-HKM_) 1/3 Hp (0.24 kW) 1-phase	120V AC	AC-15, 2.9 A B300 Pilot Duty, 3.0 A 1/4 Hp (0.18 kW), 1-phase
		240V AC	AC-15, 3.1 A B300 Pilot Duty, 1.5 A A300(700-HKM_) 3/4 Hp (0.55 kW), 1-phase	240V AC	AC-15, 1.4 A B300 Pilot Duty, 1.5 A 1/2 Hp (0.37 kW), 1-phase
		230V AC	0.55 kW, 1-phase	230V AC	0.37 kW, 1-phase
	<b>Inductive V DC</b>	24VDC	DC-13, 5.0 A	24VDC	DC-13, 3.0 A
		125VDC	DC-13, 0.2 A / R300 Pilot Duty, 0.22 A	125VDC	DC-13, 0.2 A / R300 Pilot Duty, 0.22 A
		250VDC	DC-13, 0.1 A / R300 Pilot Duty, 0.11 A	5 A, 250V AC	DC-13, 0.1 A / R300 Pilot Duty, 0.11 A
	<b>Resistive</b>	230V AC	AC-1, 16 A	230V AC	AC-1, 8 A
		277V AC	16 A, General Use	277V AC	8 A, General Use
	<b>Make, Break, and Continuous</b>	30VDC	DC-1, 12 A / 10 A, Resistive	30VDC	DC-1, 6 A / 6 A, Resistive
	<b>Min. Permissible Contact Ratings</b>		300 mW (5V/60 mA or 60V/5 mA) for AgNi Contacts (700-HK3_) 50 mW (5V/10 mA or 25V/2 mA) for AgNi + Gold Contacts (700-HKX_) 500 mW (100V/5 mA or 5V/100 mA) for AgSnO <sub>2</sub> Contacts (700-HKM_)		
<b>Permissible Coil Voltage Variation</b>	<b>Pickup: holding Voltage: Must Dropout Voltage:</b>	80...110% of Nominal Voltage at 50/60 Hz, 73...110% of Nominal Voltage at DC 80% of Nominal V AC at 50/60 Hz, 40% of Nominal V DC 20% of Nominal V AC at 50/60 Hz, 10% Nominal V DC			
<b>Power Consumption</b>		1.2VA (V AC Coils), 0.5 W (V DC Coils)			
<b>Coil Voltages</b>		See Overview/Product Selection			
<b>Design Specification/Test Requirements</b>					
<b>Dielectric Withstand Voltage</b>	<b>Pole to Pole (VRMS) Contact to Coil (VRMS)</b>	2000V AC 4000V AC			
<b>Mechanical</b>					
<b>Degree of Protection</b>		IP 20 (guarded terminal sockets), RT II — Flux-proof (Relay)			
<b>Mechanical Life Operations</b>		10 x 10 <sup>6</sup>			
<b>Electrical Lifecycles</b>		230V AC, 16 A Resistive: 100 000 min. 277V AC, 16 A Resistive: 30 000 min. 30V DC, 10 A Resistive: 30 000 min. B300, R300, Hp (kW): 6000 min. A300 (700-HKM_): 100,000 min.	230V AC, 8 A Resistive: 100 000 min. 277V AC, 8 A Resistive: 30 000 min. 30V DC, 6 A Resistive: 30 000 min. B300, R300, Hp (kW): 6000 min.		
<b>Switching Frequency</b>		Mechanical: 18,000 cycles/hr. Electrical: 900 cycles/hr.			
<b>Operating Time at Nominal Voltage at 20 °C (ms)</b>	<b>Pickup</b>	15 ms			
	<b>Dropout</b>	5 ms			
<b>Vibration</b>	<b>Operational</b>	10...2000 Hz, 0.76 mm (0.03 in.) 2.5 G			
	<b>Non-Operational</b>	10...2000 Hz, 0.76 mm (0.03 in.) 5.0 G			
<b>Shock</b>	<b>Operational</b>	15 G			
	<b>Non-Operational</b>	50 G			
<b>Environmental</b>					
<b>Temperature</b>	<b>Operating Storage</b>	-40...+70 °C (-40...+158 °F) -40...+85 °C (-40...+185 °F)			
<b>Altitude</b>		2000 m (6560 ft)			
<b>Construction</b>					
<b>Insulating Material</b>		Molded High Dielectric Material			
<b>Enclosure</b>		Transparent Dust Cover			
<b>Contact Material</b>		700-HK3_: Silver nickel (AgNi); 700-HKX_: Silver Nickel + Gold Plating (AgNi + Au); 700-HKM_: Silver Tin Oxide (AgSnO <sub>2</sub> )			
<b>Terminal Markings on Socket</b>		In accordance with EN 50005			

Attribute		700-HK	
		1-Pole	2-Pole
Sockets	Screw Terminal	700-HN121 (10 A @ 70 °C) 700-HN221 (16 A @ 50 °C, 12 A @ 70 °C)	700-HN122 (2 x 5 A @ 70 °C) 700-HN222 (2 x 8 A @ 70 °C)
	Spring Clamp	700-HN223 (15 A @ 40 °C with 2 conductors per terminal) (10 A @ 70 °C with 1 conductor per terminal)	700-HN224 (2 x 8 A @ 70 °C)
<b>Approvals</b>			
Certifications		CSA Certified, File 75088, UL Recognized, File E3125 Guide NLDX2/NLCX8, cULus Listed with Allen-Bradley sockets (File No. 3125 Guide NLDX/NLDX7), CE Marked	
Standards		EN61810-1, CSA 22.2 No. 14, UL 508	

### Dimensions- 700-HK Relays

Approximate dimensions are shown in millimeters (inches). Dimensions are not intended for manufacturing purposes.

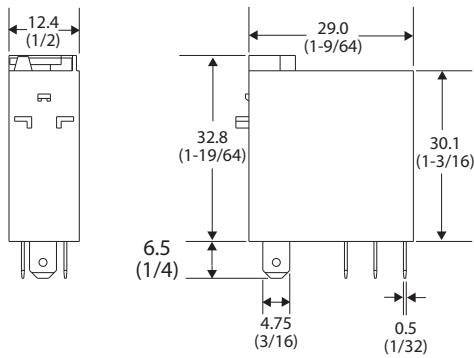

Cat. No. 700-HK36\_ (SPDT)

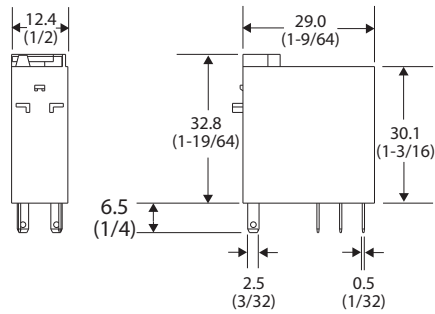

Cat. No. 700-HK32\_ (DPDT)

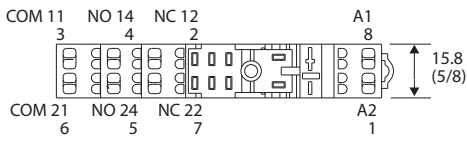

Cat. No. 700-HN224

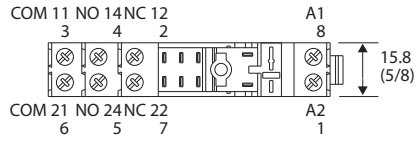

Cat. No. 700-HN222

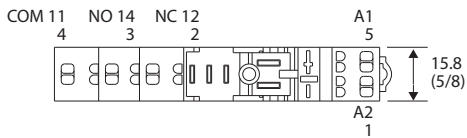

Cat. No. 700-HN223

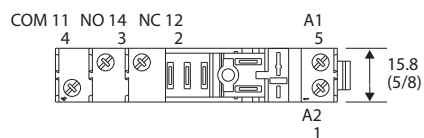

Cat. No. 700-HN221

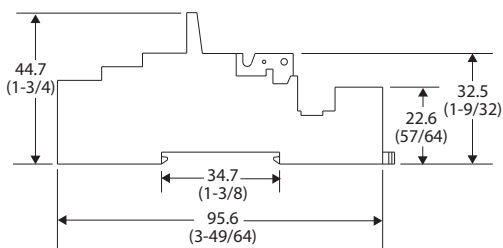

Cat. No. 700-HN223, 700-HN224

Wire Size: 0.2 mm<sup>2</sup>...1.5 mm<sup>2</sup> (#24 AWG...#14 AWG)  
Either Solid or Stranded  
Strip Length: 8 mm (5/16 in)

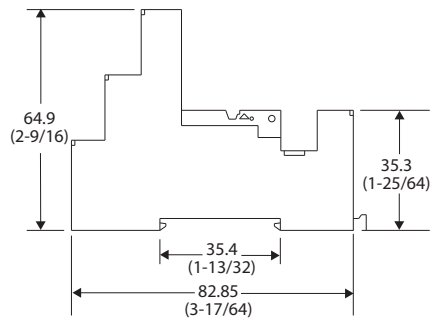

Cat. No. 700-HN221, 700-HN222

Wire Size: 0.2 mm<sup>2</sup>...2.5 mm<sup>2</sup> (#24 AWG...#12 AWG)  
Either Solid or Stranded  
Strip Length: 8 mm (5/16 in), Torque: 0.8Nm (7.0 lb.-in.)

### Dimensions - 700-HK Relays

Approximate dimensions are shown in millimeters (inches). Dimensions are not intended for manufacturing purposes.

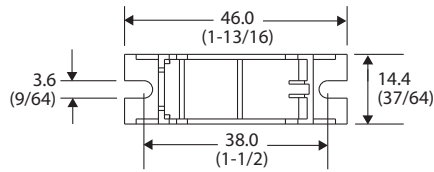

Cat. No. 700-HN226

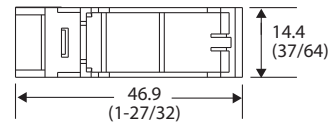

Cat. No. 700-HN227

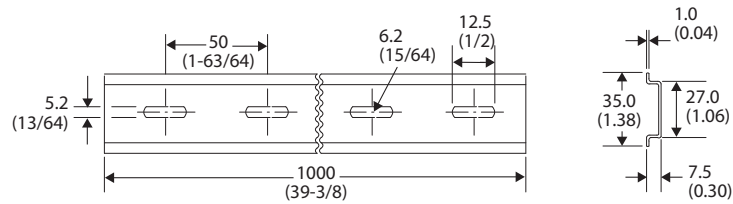
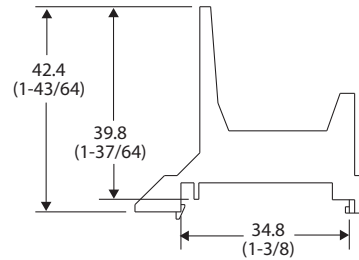
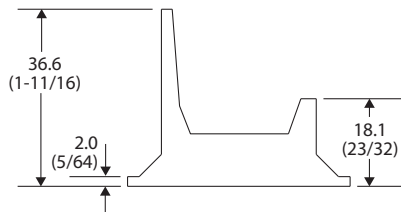

Cat. No. 199-DR4 DIN Mounting Rail Series B Has No Mounting Holes  
Cat. No. 199-DR1 DIN Mounting Rail Series B

Cat. No.	A	B	C	D	Approx. Shipping Wt.
199-DR1	35 (1-3/8)	27 (1-1/16)	7.5 (19/64)	1.02 (1/64)	1.85 kg (4.07 lb) (10/pkg)
199-DR4	35 (1-3/8)	27 (1-1/16)	15 (19/32)	2.3 (3/32)	3.68 kg (8 lb) (5/pkg)



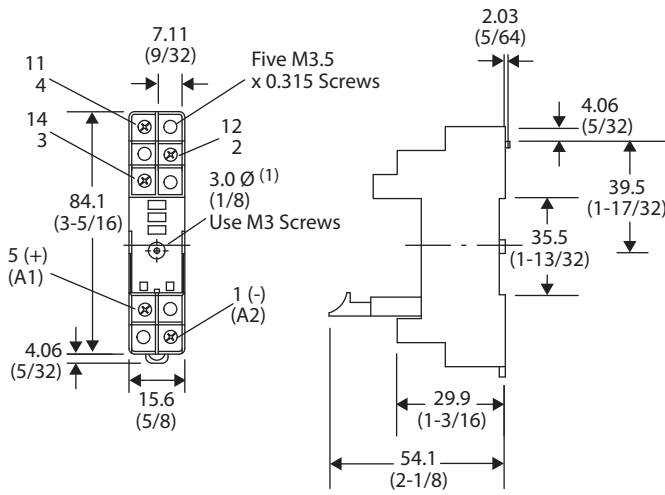

Cat. No. 700-HN121  
 Wire Size:  $2 \times 2.5 \text{ mm}^2$   
 Single Wire – Up to #14 AWG  
 Double Wire –  $2 \times 2.5 \text{ mm}^2$  (14 AWG... 20 AWG) Qty. 2 wires  
 (Either Solid or Stranded)  
 Strip Length: 9 mm (3/8 in.) – Torque: 0.8 N•m (7 lb•in)

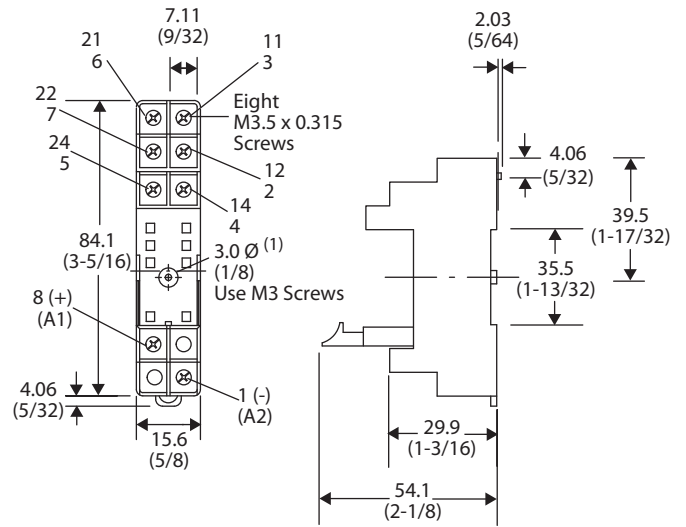

Cat. No. 700-HN122  
 Wire Size:  $2 \times 2.5 \text{ mm}^2$   
 Single Wire – Up to #14 AWG  
 Double Wire –  $2 \times 2.5 \text{ mm}^2$  (14 AWG... 20 AWG) Qty. 2 wires  
 (Either Solid or Stranded)  
 Strip Length: 9 mm (3/8 in.) – Torque: 0.8 N•m (7 lb•in)

## 700-HL Terminal Block Relay

- Relay and socket assembled interface modules for high density interposing or isolation applications
- Screw terminal and spring-clamp bases
- 6 A relay, choice of silver or gold contacts
- 2 A solid-state relay — DC output
- 2 A solid-state relay — AC output
- SPDT (relay), 1 N.O. (solid-state)
- Built-in retainer clip and snap-in marker lever
- Standard LED, reverse polarity protection, and surge protection
- Externally replaceable relay modules
- Unique leakage current suppression version to address industry concerns of nuisance coil turn-on or contact non-drop out when connecting to PLCs with leakage current
- Available with hazardous location certification



Standard built-in Features: • LED • Reverse Polarity Protection for DC Inputs • Coil Surge Protection <sup>(1)</sup>				
	Cat. No. 700-HLT1Z24	Cat. No. 700-HLT2Z24	Cat. No. 700-HLS1Z24	Cat. No. 700-HLS11Z24
Specifications			(3) 	
Output Type	SPDT (1 C/O); $I_{th} = 6A$ <sup>(2)</sup>		1 N.O. solid-state; $I_{th} = 2 A, 24V DC$ or $I_{th} = 2 A, 240V AC$	
Recommended Tightening Torque	0.5 N•m max. (4.4 lb•in)			
Wire Range	Screw Terminal: 0.14 mm <sup>2</sup> . . . 2.5 mm <sup>2</sup> (#26 . . . #14 AWG), Spring Terminal: 0.2 mm <sup>2</sup> . . . 2.5 mm <sup>2</sup> (#24 . . . #14 AWG)			
Approvals	UL, cULus, cURus, ABS, CE			

(1) Diode surge protection provided.

(2) For Gold-plated contacts: Add the letter “X” at the end of the catalog number. For example: if Cat. No. 700-HLT1Z24 is required with gold plating, the new cat. no. is 700-HLT1Z24X.

(3) Reverse polarity on the output terminals of the solid-state relay will result in the output being “ON” regardless of the state of the input voltage.

Input Voltage	Pkg. Qty.	Cat. No. (Screw Terminals)	Cat. No. (Spring Clamp Terminals)	Pkg. Quantity	Cat. No. (Screw Terminals) (DC Output)	Cat. No. (Spring Clamp Terminals) (DC Output)	Cat. No. (Screw Terminals) (AC Output)
12V DC	10	<sup>(2)</sup> 700-HLT1Z12	700-HLT2Z12	—	—	—	—
24V DC	10	<sup>(2)</sup> 700-HLT1Z24	700-HLT2Z24	10	<sup>(2)</sup> 700-HLS1Z24	700-HLS2Z24	700-HLS11Z24
48V DC	10	<sup>(2)</sup> 700-HLT1Z48	700-HLT2Z48	10	<sup>(2)</sup> 700-HLS1Z48	700-HLS2Z48	700-HLS11Z48
12V AC/DC	10	700-HLT1U12	700-HLT2U12	—	—	—	—
24V AC/DC	10	700-HLT1U24	700-HLT2U24	—	—	—	—
48V AC/DC	10	700-HLT1U48	700-HLT2U48	—	—	—	—
110/125V AC/DC	10	700-HLT1U1	700-HLT2U1	10	<sup>(2)</sup> 700-HLS1U1	700-HLS2U1	700-HLS11U1
220 . . . 240V AC/DC	10	700-HLT1U2	700-HLT2U2	10	<sup>(2)</sup> 700-HLS1U2	700-HLS2U2	700-HLS11U2
240V AC	10	700-HLT1A2	—	—	—	—	—

Input Voltage	Pkg. Qty.	Cat. No. (Screw Terminals)		Cat. No. (Spring Clamp Terminals)	Pkg. Quantity	Cat. No. (Screw Terminals) (DC Output)		Cat. No. (Spring Clamp Terminals) (DC Output)	Cat. No. (Screw Terminals) (AC Output)
Built-in LCSC (leakage current suppression circuit) 120V AC and 125V DC <sup>(1)</sup>	10	(2)	700-HLT1L1	—	10	(2)	700-HLS1L1	—	700-HLS1L1
Built-in LCSC (leakage current suppression circuit) 240V AC <sup>(1)</sup>	10	(2)	700-HLT1L2	—	10	(2)	700-HLS1L2	—	700-HLS1L2
Hazardous Location Certification 24V DC	10		700-HLT1Z24-EX	—	10		700-HLS1Z24-EX	—	—
Hazardous Location Certification 12V DC	10		700-HLT1Z12-EX	—	10		—	—	—
Hazardous Location Certification 110/125V AC/DC	10		700-HLT1U1-EX	—	10		700-HLS1U1-EX	—	—

(1) Leakage current suppression up to 2.2 mA off state current.

(2) Electromechanical relay to solid-state relay interchangeability is possible.

### Accessories - 700-HLT, -HLS Relays





Photo	Description	Pkg. Quantity	Socket Input Voltage	Cat. No.
	<b>Replacement Relays<sup>(1)</sup></b> Order must be for 20 relays or multiples of 20.	20	12V AC/DC	700-TBR12
			24V AC/DC	700-TBR24
			48V AC/DC	700-TBR48
			110/125V AC/DC 220...240V AC/DC	700-TBR60
	<b>Replacement SSR</b> 4-blade miniature relay for use with 1 N.O. SSR DC output. Order multiples of 20.	20	24V DC	700-TBS24
			48V DC, 110/125V AC/DC 220...240V AC/DC	700-TBS60
	<b>Replacement SSR</b> 4-blade miniature relay for use with 1 N.O. SSR AC output. Order multiples of 20.	20	24V DC	700-TBS124
	<b>Replacement SSR</b> 4-blade miniature relay for use with 1 N.O. SSR AC output. Order must be for 20 relays or multiples of 20.	20	48V DC 110/125V AC/DC 220...240V AC/DC	700-TBS160
	20-Way Jumper Can be cut to required length. $I_{th} = 36 \text{ A max per 20-way jumper.}$	1	<b>Color</b>	
			Red	700-TBJ20R
			Grey	700-TBJ20G
			Blue	700-TBJ20B

Photo	Description	Pkg. Quantity	Socket Input Voltage	Cat. No.
	<b>End Barrier</b> Used for visual inspection of groups, safe separation of neighboring 700-HL modules that end with jumpers.	10	Black	700-HN177
	<b>Snap-in Marker</b> These snap-in markers have a 6 x 10 mm surface and snap into the ejection lever for the relay. For custom markers, contact your local Rockwell Automation sales office or Allen-Bradley distributor for more information.	100	Blank	1492-MC6X10

(1) For gold-plated contacts: Add the letter "X" at the end of the catalog number. For example: if Cat. No. 700-TBR24 is required with gold plating, the new cat. no. is 700-TBR24X.

### Dimensions - 700-HL Relays

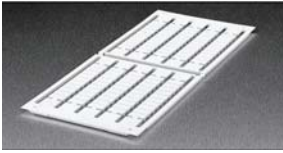
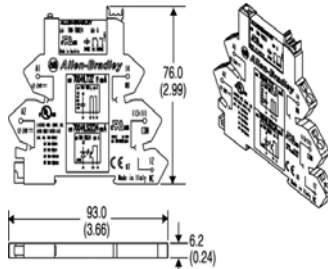

700-HL Spring Terminal Design Single Wire: 0.2 mm2 . . . 2.5 mm2 (#24 AWG . . . #14 AWG ) Wire Type: Solid or stranded, copper only.Strip Length: 9 mm (11/32 in.)

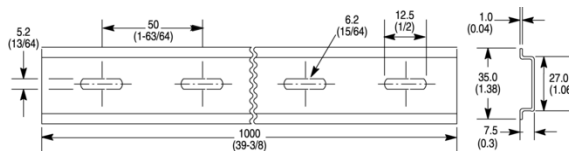

Cat. No. 199-DR1 DIN Mounting Rail Series B, Cat. No. 199-DR4 DIN Mounting Rail Series B has no mounting holes.

### Specifications - 700-HLT Relays

Cat. No. 700-HLT... (Relay Output)							
Electrical Ratings							
Pilot Duty Rating	B 300, R 300						
Rated Thermal Current ( $I_{th}$ )	1-Pole — 6 A						
Rated Insulation Voltage ( $U_i$ )	250V IEC, 300V UL/CSA						
Contacts	1-Pole						
	Inductive V AC	24VAC, 1-phase	30 A	▶ ] [ ◀ Make	5 A	◀ ] [ ▶ Break	
		120VAC, 1-phase	30 A		3 A		
		240VAC, 1-phase	15 A		1.5 A		
	Inductive V DC	24VDC	DC-13, 1.0 A				
		125VDC	DC-13, 0.2 A				
		240VDC	DC-13, 0.1 A				
	Resistive Make, Break, and Continuous	24VDC	6.0 A				
		250VAC	6.0 A				
		240VDC	0.1 A				
Inductive Load	AC-15 250V, 3 A N.O. Contact, 1.5 A N.C. Contact DC-13 24V, 1 A N.O., and N.C. Contact						

<b>Cat. No. 700-HLT... (Relay Output)</b>								
Min. Permissible Contact Ratings	12V, 6 mA (72 mW) for Silver Contacts, 8V, 2.5 mA (20 mW) for Gold Contacts							
Permissible Coil Voltage Variation	Pickup:	85...110% of Nominal Voltage at 50 Hz 85...110% of Nominal Voltage at 60 Hz 80...110% of Nominal Voltage at DC				Must Dropout Voltage:	10% of Nominal Voltage at AC 5% of Nominal Voltage at DC	
Power Consumption $\pm 10\%$	AC	0.3VA						
	DC	0.2 W						
<b>Design Specification / Test Requirements</b>								
Dielectric Withstand Voltage	Pole to Pole (VRMS)	1000V						
	Contact to Coil (VRMS)	4000V						
Input Voltage	12V AC/DC	24V AC/DC	48V AC/DC	120V AC/DC	240V AC/DC	120V LCSC	240V LCSC	
Impedance(Ohms)	1K	2 K	6 K	26 K	56 K	16 K	35 K	
<b>Mechanical</b>								
Degree of Protection	IP20							
Mechanical Life Operations	$1 \times 10^7$							
Electrical Life Operations	6 A Resistive: 100 000 min. 24V DC, 1 A Inductive: 200 000 min. 120V AC 1 A Inductive: 300 000 min.							
Switching Frequency Operations (no-load)	10 cycles/sec							
Coil Voltages	See Overview/Product Selection							
Operating Time at Nominal Voltage at 20 °C (ms)	Pickup	7 ms						
	Dropout	3 ms						
Maximum Operating Rate (full load = 6 A)	6 cycles/min.							
Coil Surge Protection	Per EN 61000-4.5; Surge Immunity (801-5) Class III: 2 kV common and 1 kV differential mode							
<b>Environmental</b>								
Temperature	Operating	-40...+55 °C						
	Storage	-40...+100 °C						
Altitude	2000 m (6560 ft)							
<b>Construction</b>								
Insulating Material	Molded High Dielectric Material							
Enclosure	Relay IP67							
Contact Material	Silver Tin Ox, AgSnO <sub>2</sub> or Silver with Gold Plating, AgSnO <sub>2</sub> + Au							
Terminal Markings on Socket	In accordance with EN50 0005							
Certifications	cULus Listed (File No. E3125, E14843 Guide NLDX/NLDX7) with Allen-Bradley socket, CE Marked, ABS (American Bureau of Shipping)							
Standards	EN 61810-1, CSA 22.2, UL 508, NEMA IEE MAC Compliant, ICS-2 Compliant Class 1, Zn 2, Groups IIC, Ex nC IIC T5 Ta < 55 °C							
Hazardous Location Approvals	UL Listed (UL60079-15)	700-HLT1Z12-EX (12V DC supply) 700-HLT1Z24-EX, 700-HLS1Z24-EX (24V DC supply) 700-HLT1U1-EX, 700-HLS1U1-EX (110V/125V AC/DC supply)						
	CSA Certified <sup>(1)</sup> (CAN/CSA E60079-15)	700-HLT1Z12-EX (12V DC supply) 700-HLT1Z24-EX, 700-HLS1Z24-EX (24V DC supply)						

(1) Product shall be installed in an enclosure providing at least IP54 protection. Provisions shall be made to prevent the rated voltage from being exceeded by transient disturbances of more than 40%.

### Cat. No. 700-HLS... (Solid-state Output)

<b>Electrical</b>		
Rated Thermal Current ( $I_{th}$ )	2 A (DC output)	2 A (AC output)
Rated Insulation Voltage ( $U_i$ )	250V IEC, 300V UL/CSA	

<b>Cat. No. 700-HLS... (Solid-state Output)</b>						
Control Circuit	Min. Control Voltage	80% nominal voltage				
	Maximum Control Voltage	110% nominal voltage				
	Control Current	9 mA $\pm$ 10% (24V) 4 mA $\pm$ 10% (120/240V)				
	Release Voltage	0.4 x nominal voltage (24V), 0.35 x nominal voltage (120/240V)				
	Min. Control Circuit Resistance	3200 ohms (24V), 16k ohms (120V), 32k ohms (240V)	2500 ohms (24V), 12k ohms (120V), 24kohms(240V)			
Outputs	Load Voltage Range	0...24VDC		24...240VAC		
	Max. Repetitive Blocking Voltage	33V		600V		
	Max. Switching Current (inductive/ resistive)	2 A DC		1 A AC		
	On State Voltage Drop @ Max. Switching Current	<120 mV DC		<1V AC		
	Leakage Current	max. 100 $\mu$ A (@U = 24V)				
Power Consumption $\pm$ 10%	AC	0.6VA(120V), 1VA(240V)				
	DC	0.2 W		0.3 W		
<b>Design Specification/Test Requirements</b>						
Dielectric Withstand Voltage	Pole to Pole (VRMS)	2500V				
	Contact to Coil (VRMS)	2500V				
Input Voltage	24VDC	48VDC	120V AC/DC	240V AC/DC	120VLCSC	240VLCSC
Impedance(Ohms)	2K	9 K	26 K	58 K	16 K	35 K
<b>Mechanical</b>						
Degree of Protection	IP20					
Input Voltages	See Overview/Product Selection					
Operating Time at Nominal Voltage at 20 °C (ms)	Turn on Time	30 $\mu$ s (DC only input voltage), 7 ms (AC/DC input voltage)				
	Drop Out Time	350 $\mu$ s (DC only input voltage), 10 ms (AC/DC input voltage)				
Maximum Operating Rate	300 Hz					
<b>Environmental</b>						
Temperature	Operating	-20...+55 °C				
	Storage	-40...+70 °C				
Altitude	2000 m (6560 ft)					
<b>Construction</b>						
Insulating Material	Molded High-Dielectric Material					
Enclosure	RelayIP67					
Terminal Markings on Socket	In accordance with EN50 0005					
Certifications	cULus Listed (File No. E14843, Guide NLDX/NLDX7), CE Marked, ABS (American Bureau of Shipping)					
Standards	UL 508, CSA C22.2 No. 14, EN 61810-1					
Hazardous Location Approvals	Class 1, Zn 2, Groups IIC, Ex nC IIC T5 Ia < 55 °C					
	UL Listed (UL60079-15)	700-HLT1Z24-EX, 700-HLS1Z24-EX (24V DC supply) 700-HLT1U1-EX, 700-HLS1U1-EX (110V/125V AC/DC supply)				
	CSA Certified <sup>(1)</sup> (CAN/CSA60079-15)	700-HLT1Z24-EX, 700-HLS1Z24-EX (24V DC supply)				

(1) Product shall be installed in an enclosure providing at least IP54 protection. Provisions shall be made to prevent the rated voltage from being exceeded by transient disturbances of more than 40%.

### Dimensions - 700-HLT, -HLS Relays

Approximate dimensions are shown in millimeters (inches). Dimensions are not intended for manufacturing purposes.

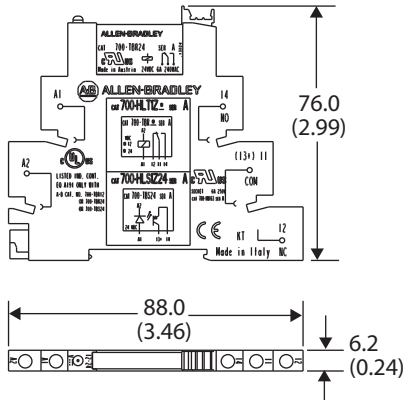

700-HLT / -HLS Screw Terminal Design

Single Wire: 0.14 mm<sup>2</sup> ... 2.5 mm<sup>2</sup> (#26 AWG...#14 AWG)  
 Double Wire: 2 x 0.14 mm<sup>2</sup> ... 2 x 1.5 mm<sup>2</sup> (2 x #26 AWG...2 x #16 AWG)  
 Wire Type: Solid or stranded, copper only  
 Strip Length: 9 mm (11/32 in). Torque: 0.5 N·m (4.4 lb·in)

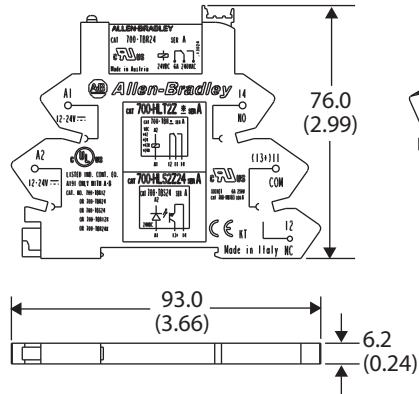
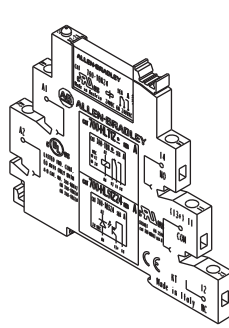

700-HLT / -HLS Spring Terminal Design

Single Wire: 0.2 mm<sup>2</sup> ... 2.5 mm<sup>2</sup> (#24 AWG...#14 AWG)  
 Wire Type: Solid or stranded, copper only  
 Strip Length: 9 mm (11/32 in.)

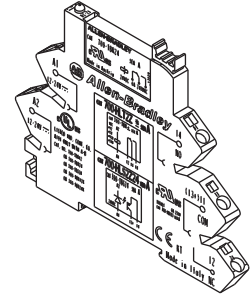

### Dimensions - 700-HLT, -HLS Relay Accessories

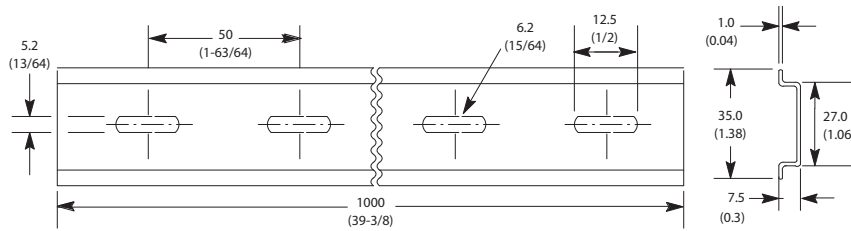



Cat. No. 199-DR1 DIN Mounting Rail Series B  
 Cat. No. 199-DR4 DIN Mounting Rail Series B Has No Mounting Holes

Cat. No.	A	B	C	D	Approx. Shipping Wt.	Pkg. Qty.
199-DR1	35 (1-3/8)	27 (1-1/16)	7.5 (19/64)	1.02 (1/64)	1.85 kg (4.07 lb)	10/pkg
199-DR4	35 (1-3/8)	27 (1-1/16)	15 (19/32)	2.3 (3/32)	3.68 kg (8 lb)	5/pkg

## 700-HL 2-pole Terminal Block Relay

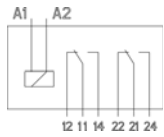



- Relay and socket assembled interface modules for high density interposing or isolation applications
- Screw terminal and spring-clamp bases
- 10 A relay, choice of silver or gold contacts
- DPDT (relay)
- Built-in retainer clip and snap-in marker lever
- Standard LED, reverse polarity protection, and surge protection
- Externally replaceable relay modules

		
Output Type	DPDT (2 C/O); $I_{th} = 10\text{ A}$	
Recommended Tightening Torque	0.6 N·m max. (5.3 lb·in.)	
Wire Range	Screw Terminal: 0.2...2.5 mm <sup>2</sup> (#24...14 AWG), Spring Terminal: 0.2...2.5 mm <sup>2</sup> (#24...14 AWG)	
Approvals	cULus, cURus, CE	

Input Voltages	Pkg. Quantity	Cat. No. <sup>(1)</sup> (Screw Terminals)	Cat. No. (Spring Clamp Terminals)
12V DC	10	700-HLT12Z12	700-HLT22Z12
24V DC	10	700-HLT12Z24	700-HLT22Z24
48V DC	10	700-HLT12Z48	700-HLT22Z48
24V AC/DC	10	700-HLT12U24	700-HLT22U24
110/125V AC/DC	10	700-HLT12U1	700-HLT22U1
220...240V AC/DC	10	700-HLT12U2	700-HLT22U2

(1) For Gold-plated contacts: Add the letter "X" at the end of the catalog number. Example: Cat. No. 700-HLT12Z24 with gold plated contacts is Cat. No. 700-HLT12Z24X. The following relays are available with the gold-plated contact option: 700-HLT\_2Z24, 700-HLT\_2U24, 700-HLT\_2U1, and 700-HLT\_2U2. Not available on 12V and 48V DC products.

### Accessories - 700-HL Relays (2- pole)

Photo	Description	Pkg. Qty.	Socket Input Voltage/Color	Cat. No.
	<b>Replacement Relays</b> Order must be for 20 relays or multiples of 20.	20	12V DC	700-TBR212
			24V AC/DC	700-TBR224
			48V DC	700-TBR248
			110/125V AC/DC, 220...240V AC/DC	700-TBR2110
	8-Way Jumper Can be cut to required length. $I_{th} = 10\text{ A}$ max per 8-way jumper.	1	Red	700-TBJ08R
			Grey	700-TBJ08G
			Blue	700-TBJ08B
	<b>End Barrier</b> Used for visual inspection of groups, safe separation of neighboring 700-HL modules that end with jumpers.	10	Black	700-HN177
	<b>Snap-in Marker<sup>(1)</sup></b> These snap-in markers have a 6 x 12 mm surface and snap into the ejection lever for the relay.	100	Blank	1492-MS6X12

(1) For custom markers, contact your local Rockwell Automation sales office or Allen-Bradley distributor for more information.



## Specifications - 700-HL Relays (2-Pole)

Cat. No. 700-HLT...2-Pole (Relay Output)							
Electrical Ratings							
Pilot Duty Rating		B 300, R 300					
Rated Thermal Current ( $I_{th}$ )		2-Pole — 10 A					
Rated Insulation Voltage ( $U_i$ )		250V IEC, 300V UL/CSA					
Contacts	Inductive V AC UL	120VAC	AC-15, 3.0A B 300, 3.0 A			1/4 HP (186 W), 1-phase	
		240VAC	AC-15, 3.0 A B 300, 1.5 A			1/2 HP (373 W), 1-phase	
	Inductive V DC	24VDC	DC-13, 2.0 A				
		125VDC	DC-13, 0.3 A				
		250VDC	DC-13, 0.2 A				
	Resistive Make, Break, and Continuous	250VAC	10 A				
		24VDC	10 A				
		250VDC	0.28 A				
	Min. Permissible Contact Ratings		12V, 10 mA (120 mW) for Silver Contacts, 5V, 1 mA (50 mW) for Gold Contacts				
Permissible Coil Voltage Variation		Pickup: 85...110% of Nominal Voltage at 50 Hz 85...110% of Nominal Voltage at 60 Hz 80...110% of Nominal Voltage at DC			Must Dropout Voltage: 10% of Nominal Voltage at AC 5% of Nominal Voltage at DC		
Design Specification/Test Requirements							
Dielectric Withstand Voltage		Pole to Pole (VRMS)	1000V				
		Contact to Coil (VRMS)	5000V				
		Adjacent Contacts (VRMS)	2500V				
Input Voltage		12V AC/DC	24V AC/DC	48VDC	120V AC/DC	240V AC/DC	
Impedance (Ohms)		1 K	2 K	3 K	34 K	72 K	
Power Consumption $\pm 10\%$		AC	N/A	0.5VA	N/A	0.4VA	0.8VA
		DC	0.4 W	0.5 W	0.8 W	0.5 W	0.7 W
Mechanical							
Degree of Protection		IP20					
Mechanical Life Operations		$3 \times 10^7$					
Electrical Life Operations		250V AC/24V DC, 8 A Resistive: 100 000 min. 24V DC, 10 A Resistive: 6000 min. 250V DC, 0.28 A Resistive: 6000 min. 250V AC, 10 A Resistive: 30 000 min.					
Switching Frequency Operations (no-load)		1200 cycles/sec					
Coil Voltages		See Overview/Product Selection					
Operating Time at Nominal Voltage at 20 °C (ms)		Pickup	typical 10 ms				
		Dropout	typical 10 ms				
Maximum Operating Rate (full load = 6 A)		6 cycles/min.					

**Cat. No. 700-HLT...2-Pole (Relay Output)**

Environmental		
Temperature	Operating	-40...+60 °C
	Storage	-40...+100 °C
Altitude	2000 m (6560 ft)	
Construction		
Insulating Material	Molded High-Dielectric Material	
Enclosure	Relay RT II — flux-proof, pollution degree 2 installation environment	
Contact Material	AgNi 90/10 or AgNi 90/10 + Au	
Terminal Markings on Socket	In accordance with EN50 0005	
Certifications	cULus Listed (File No. E3125, Guide NRNT/NRNT7), CE Marked	
Standards	UL 508, CSA C22.2 No. 14, EN 61810-1	

**Dimensions - 700-HL (2-pole)**

Approximate dimensions are shown in millimeters (inches). Dimensions are not intended for manufacturing purposes.

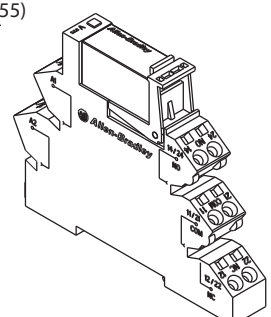
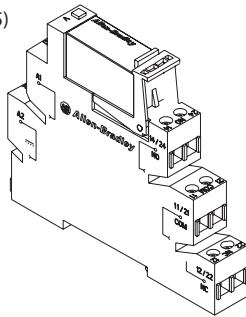
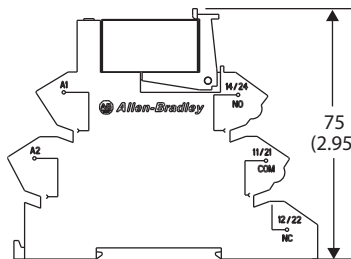
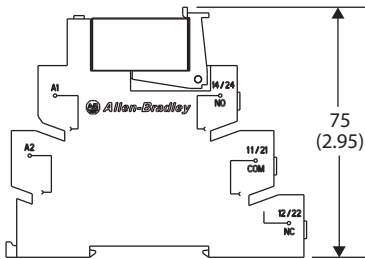
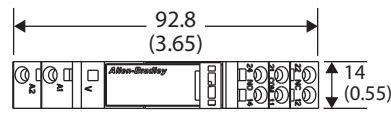
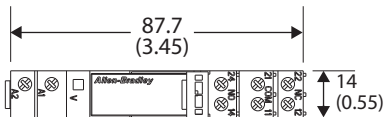

*Bulletin 700-HL Screw Terminal Design*

*Single Wire: 0.14 mm<sup>2</sup>...2.5 mm<sup>2</sup> (#26 AWG...14 AWG)*

*Double Wire: 2 x 0.14 mm<sup>2</sup>...2 x 1.5 mm<sup>2</sup> (2 x #26 AWG...2 x 16 AWG)*

*Wire Type: Solid or stranded, copper only*

*Strip Length: 9 mm (11/32 in). Torque: 0.5 N·m (4.4 lb·in)*

*Bulletin 700-HL Spring Terminal Design*

*Single Wire: 0.2 mm<sup>2</sup>...2.5 mm<sup>2</sup> (#24 AWG...#14 AWG)*

*Wire Type: Solid or stranded, copper only*

*Strip Length: 9 mm (11/32 in)*

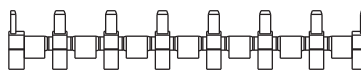
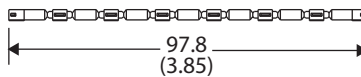

*Bulletin 700-TBJ08\_ 8-Way Jumper*

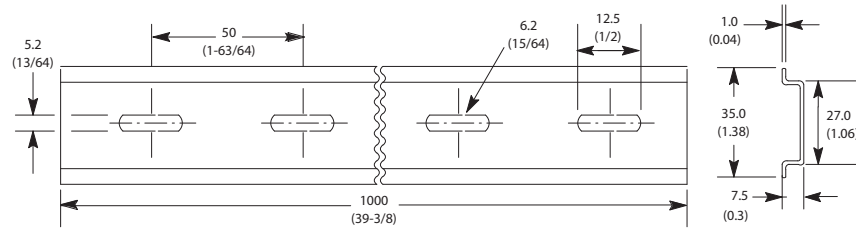

Cat. No. 199-DR1 DIN Mounting Rail Series B  
 Cat. No. 199-DR4 DIN Mounting Rail Series B Has No Mounting Holes

Cat. No.	A	B	C	D	Approx. Shipping Wt.
199-DR1	35 (1-3/8)	27 (1-1/16)	7.5 (19/64)	1.02 (1/64)	1.85 kg (4.07lb) (10/pkg)
199-DR4	35 (1-3/8)	27 (1-1/16)	15 (19/32)	2.3 (3/32)	3.68 kg (8lb) (5/pkg)

## 700-HLF Terminal Block Timing Relay

- Relay and socket assembled modules for high-density applications
- Screw terminal bases
- 6 A relay, choice of silver or gold contacts
- SPDT (relay)
- Four timing functions
- Time range from 0.1 sec...6 hr
- Built-in retainer clip and snap-in marker lever
- Standard LED, reverse polarity protection, and surge protection
- Externally replaceable relay modules



Wiring Diagram	
Output Type	SPDT (1 C/O); $I_{th} = 6AS$
Recommended Tightening Torque	0.5 N·m max. (4.4 lb·in)
Wire Range	Screw Terminal: 0.14 mm <sup>2</sup> ... 2.5 mm <sup>2</sup> (#26 ... #14 AWG)
Approvals	cULus, cURus, CE

Assembled Device		
Input Voltage	Pkg. Quantity	Cat. No. <sup>(1)</sup>
24V AC/DC	10	700-HLF1U24

(1) For gold-plated contacts add an X after the catalog number listed.

### Accessories - 700-HLF Relays

Terminal block timing relay bases are not sold separately.

Photo	Description	Pkg. Quantity	Socket Input Voltage	Cat. No.
	<b>Replacement Relays</b> Order must be for 20 relays or multiples of 20.	20	24V AC/DC	700-TBR24 <sup>(1)</sup>
	<b>20-Way Jumper</b> Can be cut to required length. $I_{th} = 36 A$ max per 20-way jumper.	1	Color	
			Red	700-TBJ20R
			Grey	700-TBJ20G
			Blue	700-TBJ20B
	<b>End Barrier</b> Used for visual inspection of groups, safe separation of neighboring 700-HL modules that end with jumpers.	10	Black	700-HN177
	<b>Snap-in Marker</b> These snap-in markers have a 6 x 10 mm surface and snap into the ejection lever for the relay.	100	Blank	1492-MC6X10

(1) For gold-plated contacts: Add the letter "X" at the end of the catalog number. For example: if Cat. No. 700-TBR24 is required with gold plating, the new cat. no. is 700-TBR24X.

### Function and Connection Diagrams - 700-HLF Relays

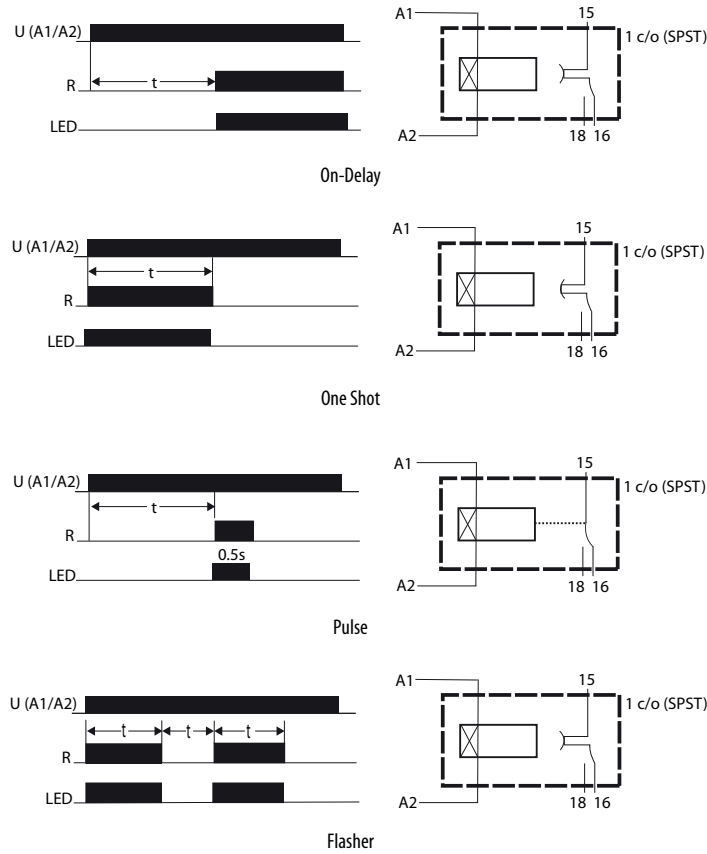

### Specifications- 700-HLF Relays

Cat. No. 700-HLF... (Relay Output) <sup>(1)</sup>				
Electrical Ratings				
<b>Pilot Duty Rating</b>	B 300, R 300			
<b>Rated Thermal Current (<math>I_{th}</math>)</b>	1-Pole — 6 A			
<b>Rated Insulation Voltage (<math>U_i</math>)</b>	250VIEC, 300V UL/CSA			
<b>Contacts</b>	Inductive	1-Pole		
	24V AC, 1-phase	30 A	▶  ◀	5 A
	120V AC, 1-phase	30 A		3 A
	240V AC, 1-phase	15 A		1.5 A
	Make, Break and Continuous VDC	24VDC		1.0 A
120VDC		0.2 A		
240VDC		0.1 A		
<b>Inductive Load</b>	AC-15 250V, 3 A N.O. Contact, 1.5 A N.C. Contact DC-13 24V, 1 A N.O. and N.C. Contact			
<b>Min. Permissible Contact Ratings</b>	12V, 6 mA (72 mW) for Silver Contacts, 8V, 2.5 mA (20 mW) for Gold Contacts			

<b>Permissible Coil Voltage Variation</b>	Pickup:	85...110% of Nominal Voltage at 50 Hz 85...110% of Nominal Voltage at 60 Hz 80...110% of Nominal Voltage at DC	Must Dropout Voltage: 10% of Nominal Voltage at AC, 5% of Nominal Voltage at DC
<b>Power Consumption ±10%</b>	AC/DC	0.5VA	
<b>Design Specification/Test Requirements</b>			
<b>Dielectric Withstand Voltage</b>	Pole to Pole (VRMS)	1000V	
	Contact to Coil (VRMS)	4000V	
<b>Input Voltage</b>	24V AC/DC		
<b>Impedance(Ohms)</b>	2 K		
<b>Mechanical</b>			
<b>Degree of Protection</b>	IP20		
<b>Mechanical Life Operations</b>	1 x 10 <sup>7</sup>		
<b>Electrical Life Operations</b>	6 A Resistive: 100,000 min. 24V DC, 1 A Inductive: 200,000 min. 120V AC 1 A Inductive: 300,000 min.		
<b>Switching Frequency Operations (no-load)</b>	10 cycles/sec		
<b>Coil Voltages</b>	See Overview/Product Selection		
<b>Timer Functions</b>	On-Delay, One Shot, Pulse, and Flasher		
<b>Timer Settings</b>	0.1...3 s, 3...60 s, 1...20 min, and 0.3...6 hr		
<b>Timer Adjustments</b>	Min and Max adjustments with Potentionmeter		
<b>Timer Accuracy</b>	Repeatability 1%, Recovery Time < 50 ms, Setting Accuracy Full Range 5%		
<b>Coil Surge Protection</b>	Per EN 61000-4.5; Surge Immunity (801-5) Class III: 2 kV common and 1 kV differential mode		
<b>Environmental</b>			
<b>Temperature</b>	Operating	-40...+55°C (-40...+131°F)	
	Storage	-40...+100°C (-40...+212°F)	
<b>Altitude</b>	2000 m (6560 ft)		
<b>Construction</b>			
<b>Insulating Material</b>	Molded High Dielectric Material		
<b>Enclosure</b>	Relay IP67		
<b>Contact Material</b>	Silver Tin Ox, AgSnO <sub>2</sub> or Silver with Gold Plating, AgSnO <sub>2</sub> + Au		
<b>Terminal Markings on Socket</b>	In accordance with EN50 0005		
<b>Certifications</b>	cULus Listed (File No. E3125, Guide NLDX/NLDX7) with Allen-Bradley socket, CE Marked		
<b>Standards</b>	EN60947-4-1, EN60947-5-1, CSA 22.2, UL 508, NEMA IEE MAC Compliant, ICS-2 Compliant		

(1) Product shall be installed in an enclosure providing at least IP54 protection. Provisions shall be made to prevent the rated voltage from being exceeded by transient disturbances of more than 40%.

### Dimensions- 700-HLF Relays

Approximate dimensions are shown in millimeters (inches). Dimensions are not intended for manufacturing purposes.

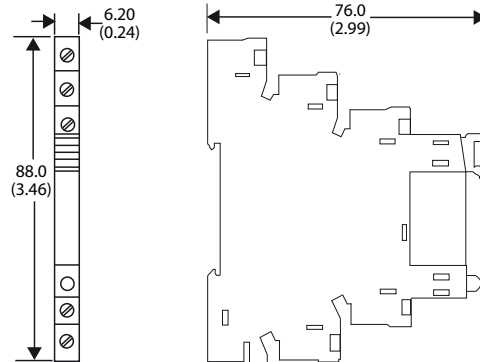

#### 700-HLF Screw Terminal Design

- Single Wire: 0.14 mm<sup>2</sup> ... 2.5 mm<sup>2</sup> (#26 AWG ... 14 AWG)
- Double Wire: 2 x 0.14 mm<sup>2</sup> ... 2 x 1.5 mm<sup>2</sup> (2 x #26 AWG ... 2 x 16 AWG)
- Wire Type: Solid or stranded, copper only
- Strip Length: 9 mm (11/32 in.). Torque: 0.5 N·m (4.4 lb·in)

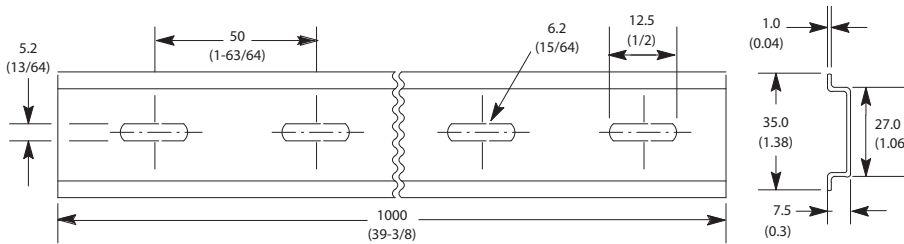

Cat. No. 199-DR1 DIN Mounting Rail Series B  
 Cat. No. 199-DR4 DIN Mounting Rail Series B Has No Mounting Holes

Cat. No.	A	B	C	D	Approx. Shipping Wt.
199-DR1	35 (1-3/8)	27 (1-1/16)	7.5 (19/64)	1.02 (1/64)	1.85 kg (4.07lb) (10/pkg)
199-DR4	35 (1-3/8)	27 (1-1/16)	15 (19/32)	2.3 (3/32)	3.68 kg (8lb) (5/pkg)

### 700-HP Slim Line Relay

- 8 A contact ratings
- DPDT/ (2 c/o) contacts
- Plug-in PIN style (PCB) terminals (5 mm pinning)
- Choice of standard silver nickel contacts, or silver nickel with gold-plated contacts
- Available with mechanically linked contacts (Type B)
- Safety Control Relay Version (700-HPS)



Photo	Description	Contact Rating	Wiring Diagrams		Coil Voltage	Pkg. Qty.	Cat. No.
			U.S./Canada	International			
	DPDT 2-Pole 2 Form C AgNi + Au Gold Plated Contacts	8 A			6V AC	10	700-HPX2A06
					12V AC	10	700-HPX2A12
	24V AC				10	700-HPX2A24	
	120V AC				10	700-HPX2A1	
	240V AC				10	700-HPX2A2	
	6V DC				10	700-HPX2Z06	
	12V DC				10	700-HPX2Z12	
	24V DC				10	700-HPX2Z24	
	48V DC				10	700-HPX2Z48	
	110V DC				10	700-HPX2Z1	
	6V AC				10	700-HP32A06	
	12V AC				10	700-HP32A12	
	24V AC				10	700-HP32A24	
	120V AC				10	700-HP32A1	
	240V AC	10	700-HP32A2				
	6V DC	10	700-HP32Z06				
	12V DC	10	700-HP32Z12				
	24V DC	10	700-HP32Z24				
	48V DC	10	700-HP32Z48				
Sockets			700-HN123	700-HN123	110V DC	10	700-HP32Z1

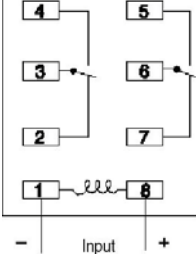
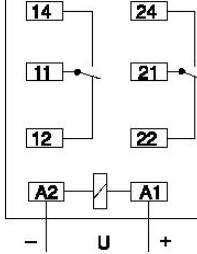

## 700-HPS Safety Control Relay

Photo	Description	Contact Rating	Wiring Diagrams		Coil Voltage	Pkg. Qty.	Cat. No.
			U.S./Canada	International			
	DPDT 2-Pole 2 Form C AgNi + Au Gold Plated Mechanically Linked Contacts	8 A			6V DC	10	700-HPSXZ06
					12V DC	10	700-HPSXZ12
					24V DC	10	700-HPSXZ24
					48V DC	10	700-HPSXZ48
					60V DC	10	700-HPSXZ60
					110V DC	10	700-HPSXZ1
					125V DC	10	700-HPSXZ01
					6V DC	10	700-HPSZ206
					12V DC	10	700-HPSZ212
					24V DC	10	700-HPSZ224
48V DC	10	700-HPSZ248					
60V DC	10	700-HPSZ260					
110V DC	10	700-HPSZ21					
700-HPS DPDT	Sockets		700-HN123	700-HN123	125V DC	10	700-HPSZ201

## Accessories - 700-HP, -HPS



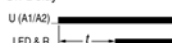





Photo	Description	Pkg. Qty.	Cat. No.	
	<b>Diode Surge Suppressor</b> Voltage Range: 6...220V DC used with 700-HN123 socket	10	700-ADR	
	<b>Diode with LED Surge Suppressor</b> Voltage Range: 6...24V DC used with 700-HN123 socket	10	700-ADL1R	
	<b>Diode with LED Surge Suppressor</b> Voltage Range: 28...60V DC used with 700-HN123 socket	10	700-ADL2R	
	<b>Diode with LED Surge Suppressor</b> Voltage Range: 110...220V DC used with 700-HN123 socket	10	700-ADL3R	
	<b>Diode with LED Surge Suppressor</b> Voltage Range: 6...24V AC used with 700-HN123 socket	10	700-AV1R	
	<b>Varistor with LED Surge Suppressor</b> Voltage Range: 110...240V AC used with 700-HN123 socket	10	700-AV3R	
	<b>RC Surge Suppressor</b> Voltage Range: 6...24V AC/DC used with 700-HN123 socket	10	700-AR1	
	<b>RC Surge Suppressor</b> Voltage Range: 110...240V AC/DC used with 700-HN123 socket	10	700-AR2	
	<b>Timing Module</b> On-Delay or One-Shot selectable voltage range: 12...24V AC/DC used with sockets that accept plug-in accessory modules.	On-Delay U (A1/A2)  LED & R.   One-Shot U (A1/A2)  LED & R. 	700-AT3	
	<b>Timing Module</b> On-Delay or One-Shot selectable voltage range: 110...125V AC used with sockets that accept plug-in accessory modules.		1	700-AT3A1
	<b>Timing Module</b> On-Delay or One-Shot selectable voltage range: 230...240V AC used with sockets that accept plug-in accessory modules.			700-AT3A2

Photo	Description	Pkg. Qty.	Cat. No.
	<b>Screw Terminal Socket — Panel or DIN Rail Mounting</b> 8-pin miniature socket for use with 2-pole, 700-HP relays. Incorporates coil and contact separation.	10	700-HN123
	8-Way Jumper can be cut to required length. Rated 10 A – 250V	Red	700-TBJ20R
		Gray	700-TBJ20G
		Blue	700-TBJ20B
	<b>Plastic Retainer and Ejection Lever</b> For use with the 700-HN123 sockets Built-in ability to accept 1492 snap-in markers	10	700-HN119
	<b>Spring Clamp Terminal Socket — Panel or DIN Rail Mounting</b> 8-pin miniature socket for use with 2-pole, 700-HP relays. Incorporates coil and contact separation.	10	700-HN230
	<b>Plastic Retainer and Ejection Lever</b> For use with the 700-HN230 sockets Built-in ability to accept 1492 snap-in markers	10	700-HN232
	<b>DIN (#3) symmetrical hat rail</b> 35 x 7.5 x 1 m	10	199-DR1
	<b>Relay Identification Snap-in Markers</b> Note - These markers can only be used when the Plastic Retainer and Ejection Lever accessory (part # 700-HN119) is used because the markers snap into the Ejection Lever (and not into the relay itself).	5	1492-MS5X12
		5	1492-MS6X9
		5	1492-MS6X12
		5	1492-MS8X9
		5	1492-MS8X12
		100	1492-MP-Blank
	<b>Pre-Printed Identification Tags</b> — contains 10 sheets of pre-printed and blank tags. Each sheet contains 13 sets of the markings CR...9CR, TR...9TR, M...9M, F, R, 1S, and 117 blank tags. Tags are peel-off with sticky backing for easy placement on relays.	10	700-N40 700-N41

**Socket, and Retainer Clip Reference**

Relay Type	Socket Cat. No.	Retainer Clip Cat. No.
700-HPX2	700-HN123	700-HN119
700-HP32	700-HN123	700-HN119
700-HPS2	700-HN123	700-HN119
700-HPSX	700-HN123	700-HN119

Specifications <sup>(1)</sup> - 700-HP Relays

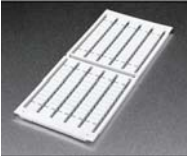
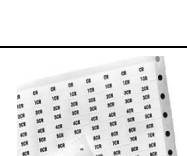
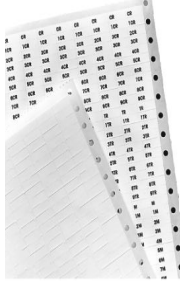
Cat. No. 700-HP...		Cat. No. 700-HP3..., 700-HPX	Cat. No. 700-HPS...	
Contacts	Inductive	VAC	AC 15 @ 500V AC	
			C300	B300
			1/3 Hp @ 240V AC	1/2 Hp @ 240V AC
			1/6 Hp @ 120V AC	1/3 Hp @ 120V AC
		VDC	AC-1 2000VA	—
	R300		—	
	DC-1: 8A @ 30V DC		—	
	Resistive	AC	8 A @ 277V AC (per pole)	
		DC	8 A @ 30V DC (per pole)	
	Minimum Load		700-HP32: 300mW (5V, 5 mA) 700-HPX2: 50mW (5V, 5 mA)	700-HPS2: 500 mW (10V, 10 mA) 700-HPSX: 50 mW (5V, 5 mA)
Nominal Coil Power (AC/DC)		1.2 VA / 0.65 W	0.7 W	
Operating Range (AC/DC)		80...110% / 73...150% Nominal Voltage	75...120% Nominal Voltage DC	
Holding Voltage (AC/DC)		80 / 40% Nominal Voltage	40% Nominal Voltage DC	
Must Drop Out Voltage (AC/DC)		20 / 10% Nominal Voltage	10% Nominal Voltage DC	
Insulation Voltage		250V AC		
<b>Design Specification/Test Requirements</b>		<b>700-HP3, 700-HPX</b>	<b>700-HPS</b>	
Dielectric Withstand Voltage for 1 minute	Pole to Pole (VRMS)	2000V AC		
	Contact to Coil (VRMS)	4000V AC		
<b>Mechanical</b>				
Degree of Protection		Open Type (Sockets)		
Mechanical lifecycles		10 x 10 <sup>6</sup> (AC Coils), 20 x 10 <sup>6</sup> (DC coils)	10 x 10 <sup>6</sup> (DC Coils)	
Switching Frequency Operations		1800/hr (no load)	900/hr (no load)	
Coil Voltages		See Overview/Product Selection		
Operating Time at Nominal Voltage at 20 °C (ms)	Pickup	12	10	
	Dropout	4		
Maximum Operating Rate		16 Ops/s (full load)	8 Ops/s (full load)	
Vibration	Enclosure	5 G		
	Fragility	2.5 G		
Shock	Endurance	50 G		
	Fragility	15 G		
Max. Socket Torque		0.5 N·m (4.4 lb-in)		
<b>Environmental</b>				
Temperature	Operating	-40...+85 °C (-40...+185 °F)	-40...+70 °C (-40...+158 °F)	
	Storage	-45...+100 °C (-49...+212 °F)	-50...+80 °C (-40...+176 °F)	
Altitude		2000 m (6560 ft)		

### Specifications <sup>(1)</sup> - 700-HP Relays

<b>Construction</b>		
Insulating Material	Molded High-Dielectric Material	
Enclosure	Transparent Dust Cover	Red Transparent Dust Cover
Contact Material	Silver Nickel, (AgNi) (700-HP32 and 700-HPS2), Silver Nickel + Gold Plating (AgNi + Au) (700-HPX2 and 700-HPSX)	
Terminal Markings on Socket	In accordance with EN50 0005	
Sockets	2-Pole	
	700-HN123	
<b>Approvals</b>		
Certifications	cURus Recognized (File No. E3125, Guide NLDX2/NLDX8), cULus Listed when used with 700-HN123 socket (File No. E3125, Guide NLDX/NLDC7), CSA Certified (files 229473), CE Marked, LR Certified (700-HP), IMQ & TÜV Certified (700- HPS)	
Standards	UL 508, CSA 22.2 No. 14, EN 61810-1, EN 50205 (700-HPS)	

(1) The inrush VA equals 1.5 times the sealed VA.

### Dimensions - 700-HP Relays

Approximate dimensions are shown in millimeters (inches). Dimensions are not intended for manufacturing purposes.

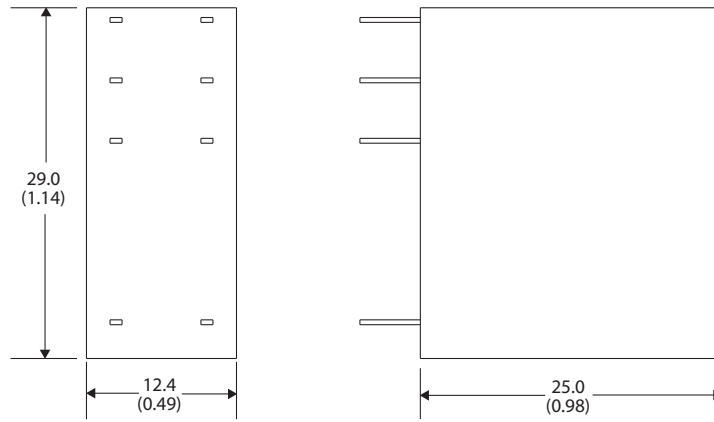

700-HP Relay

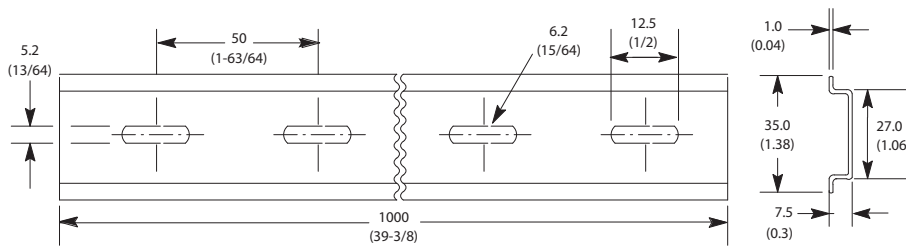

Cat. No. 700-HN123

Single Wire: 0.2.....2.5 mm<sup>2</sup> (#24.....14 AWG)

Double Wire: 2 X 0.2.....2 X 2.5 mm<sup>2</sup> (#2 X 24.....2 X 14 AWG)

Wire Type: solid or stranded, copper only

Strip Length: 7 mm (9/32 in.), Torque: 0.5 N·m (4.4 lb·in)

Cat. No.	A	B	C	D	Approx. Shipping Wt.
199-DR1	35 (1-3/8)	27 (1-1/16)	7.5 (19/64)	1.02 (1/64)	1.85 kg (4.07 lb) (10/pkg)
199-DR4	35 (1-3/8)	27 (1-1/16)	15 (19/32)	2.3 (3/32)	3.68 kg (8 lb) (5/pkg)

Approximate dimensions are shown in millimeters (inches). Dimensions are not intended for manufacturing purposes.

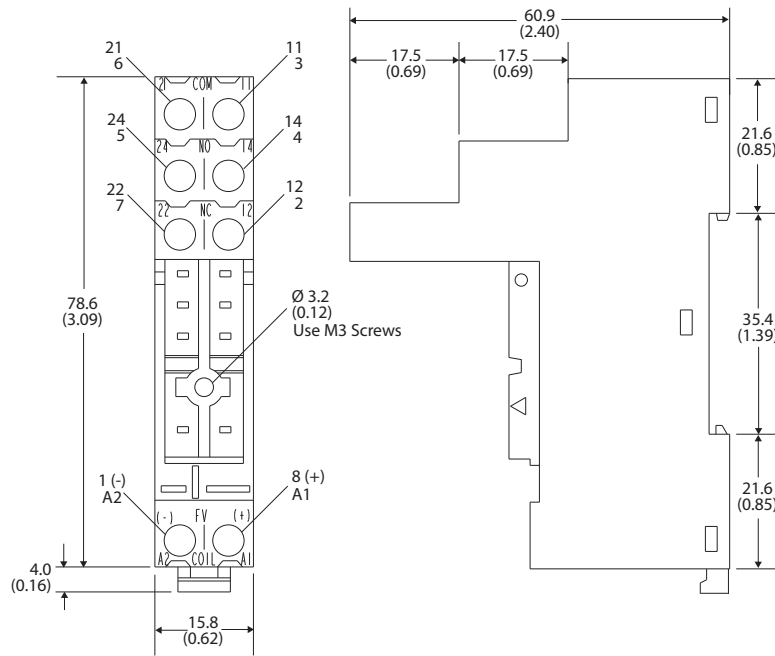

Cat. No. 700-HN123

Single Wire: 0.2.....2.5 mm<sup>2</sup> (#24.....14 AWG)

Double Wire: 2 X 0.2.....2 X 2.5 mm<sup>2</sup> (#2 X 24.....2 X 14 AWG)

Wire Type: solid or stranded, copper only

Strip Length: 7 mm (9/32 in.), Torque: 0.5 N·m (4.4 lb·in)

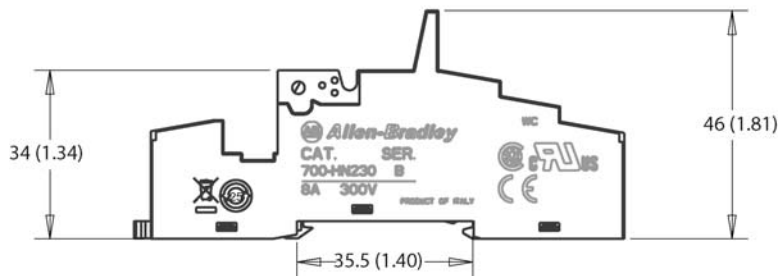
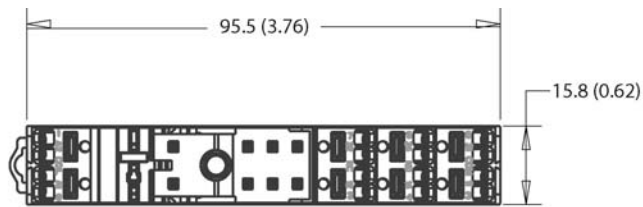

Cat. No. 700-HN230

Min wire size: 0.5mm<sup>2</sup> (21 AWG.)

Max wire size: 2 x 1.5 and 1 x 2.5 mm<sup>2</sup> (2 x 18 / 1 x 14 AWG)

Wire Type: solid or stranded, copper only

Stripe Length: 8mm (10/32 in.)

## 700-HJ Magnetic Latching Relay





- 10 A Contact Rating
- SPDT
- DPDT Single Coil
- DPDT Dual Coil
- Blade Style Quick Connect Terminals



Photo	Description	Contact Rating	Wiring Diagrams		Coil Voltage	Cat. No.	
			AC <sup>(2)</sup>	DC <sup>(3)</sup>			
	SPDT 1-Pole 1 Form C AgCdO Contacts (Single Coil AC or DC)	10 A			24V AC	700-HJ36A24	
						120V AC	700-HJ36A1
	Sockets		700-HN153	700-HN154			
	DPDT 2-Pole 2 Form C AgCdO Contacts (Single Coil AC or DC)	10 A			24V AC	700-HJ32A24	
						120V AC	700-HJ32A1
							240V AC
Sockets		700-HN153	700-HN154	24V DC	700-HJ32Z24		
DPDT 2-Pole 2 Form C AgCdO Contacts (Dual Coil <sup>(1)</sup> )	10 A	DC Only			24V DC	700-HJD32Z24	
			Sockets		700-HN153 or 700-HN154		

(1) Available only in DC Coil with DPDT contacts.  
 (2) AC Relays include internal diodes.  
 (3) For DC operation, polarity must be observed.

### Accessories-700-HJ Relays

Photo	Description	Pkg. Qty.	Cat. No.
	<b>Screw Terminal Socket — Panel or DIN Rail Mounting. Guarded Terminal Construction</b> 11-blade socket for use with 700-HB relays. This socket has coil and contact separation as well as the ability to use optional plug-in modules ( 700-A__ accessories, LED, surge suppression, timing modules).	10	700-HN153
	<b>Screw Terminal Base Socket — Panel or DIN Rail Mounting. Open Style Construction</b> 11-blade for use with 700-HB relays.	10	700-HN154
	<b>DIN (#3) symmetrical hat rail</b> 35 x 7.5 x 1 m	10	199-DR1
	<b>Retainer Clip</b> <b>For Cat. Nos. 700-HN153 and -HN154 Sockets with 700-HJ Relays</b> Secures relay in socket. Order must be for 10 clips or multiples of 10.	10	700-HN159
	<b>Pre-Printed Identification Tags</b> — contains 10 sheets of pre-printed and blank tags. Each sheet contains 13 sets of the markings CR...9CR, TR...9TR, M...9M, F, R, 1S, and 117 blank tags. Tags are peel-off with sticky backing for easy placement on relays.	10	700-N40
	<b>Blank Identification Tags</b> — contains 10 sheets of blank identification tags for customer specialized printing. Each sheet contains 546 blank tags. Tags are peel-off with sticky backing for easy placement on relays.	10	700-N41

### Socket and Retainer Clip Reference

Relay Type	Socket Cat. No.	Retainer Clip Cat. No.
700-HJ	700-HN153	700-HN159
	700-HN154	700-HN159

### Specifications - 700-HJ Relays

Attribute		700-HJ		
<b>Electrical Ratings</b>				
Pilot Duty Rating		—		
Rated Thermal Current ( $I_{th}$ )		10 A		
Rated Insulation Voltage ( $U_i$ )		250VIEC, 300V UL/CSA		
Contacts	Inductive	<b>Make</b>	<b>Break</b>	<b>Hp</b>
		▶] [◀	◀] [▶	
	120V AC	30 A	3 A	1/4
	240V AC	15 A	1.5 A	1/3
	DC	24V DC, 10 A		
Permissible Coil Voltage Variation		85...110% of Nominal Voltage at 50 Hz 85...110% of Nominal Voltage at 60 Hz 80...110% of Nominal Voltage at DC		



## Specifications - 700-HJ Relays

			Single AC Coil	Single DC Coil	Dual DC Coil
Coil Consumption $\pm 10\%$	AC Coils	Inrush Sealed	1.44 VA 1.44 VA	—	—
	DC Coils		—	1.2 W	12V 1.63 W 24V 1.67 W
<b>Design Specification/Test Requirements</b>					
Dielectric Withstand Voltage	Pole-to-Pole		1500V AC		
	Contact-to-Pole		1500V AC		
	Contact-to-Frame		1500V AC		
<b>Mechanical</b>					
Degree of Protection			Open Type (Guarded Terminal Sockets)		
Mechanical Life Operations			10 x 10 <sup>6</sup>		
Switching Frequency Operations			1800/HR		
Coil Voltages			See Product Selection		
Operating Time at Nominal Voltage at 20 °C	Pickup		25 ms		
	Dropout		25 ms		
Maximum Operating Rate			—		
<b>Environmental</b>					
Temperature	Operating		-45...+50 °C (-49...+122 °F)		
	Storage		-45...+100 °C (-49...+212 °F)		
Altitude			2000 m (6560 ft)		
<b>Construction</b>					
Insulating Material			Molded High Dielectric Material		
Enclosure			Transparent Dust Cover		
Contact Material			Silver Cad. Ox.		
Terminal Markings on Socket			In accordance with EN50 0005		
Sockets			11-Blade Socket Cat. No. 700-HN153 Cat. No. 700-HN154		
Certifications			CSA Certified, File LR700026, UL Recognized, File E3125, Guide NLDX 2		
Standards			UL 508, CSA 22.2 No. 14, EN/IEC 60947-4-1, -5-1		

### Dimensions - 700-HJ Relays

Approximate dimensions are shown in millimeters (inches). Dimensions are not intended for manufacturing purposes.

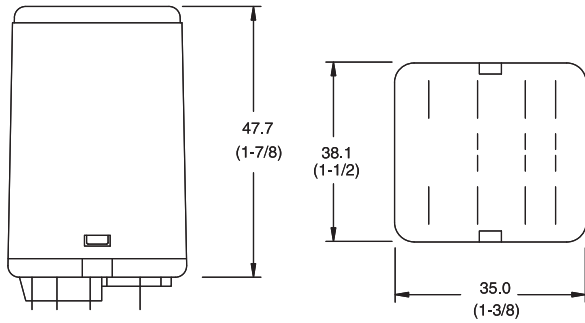

700-HJ Relay

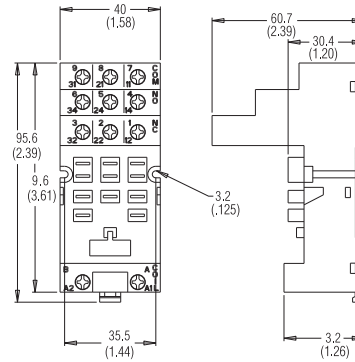

Cat. No. 700-HN153

Wire Size: 2 x 2.5 mm<sup>2</sup>

Single Wire – Up to #12 AWG

Double Wire – 2 x 2.5 mm<sup>2</sup> (#2–14 AWG... #2–20 AWG)  
(Either Solid or Stranded)

Strip Length: 9 mm (3/8 in) – Torque: 0.8 N·m (7 lb·in)

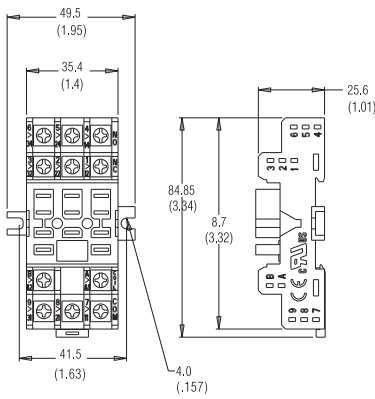

Cat. No. 700-HN154

Wire Size: 2 x 2.5 mm<sup>2</sup>

Single Wire – Up to #12 AWG

Double Wire – 2 x 2.5 mm<sup>2</sup> (#2–14 AWG... #2–20 AWG)  
(Either Solid or Stranded)

Strip Length: 9 mm (3/8 in) – Torque: 0.8 N·m (7 lb·in)

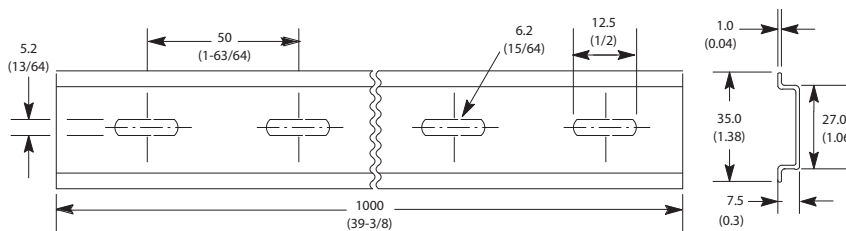





Cat. No. 199-DR1 DIN Mounting Rail Series B

Cat. No. 199-DR4 DIN Mounting Rail Series B Has No Mounting Holes

Cat. No.	A	B	C	D	Approx. Shipping Wt.
199-DR1	35 (1-3/8)	27 (1-1/16)	7.5 (19/64)	1.02 (1/64)	1.85 kg (4.07 lb) (10/pkg)
199-DR4	35 (1-3/8)	27 (1-1/16)	15 (19/32)	2.3 (3/32)	3.68 kg (8 lb) (5/pkg)

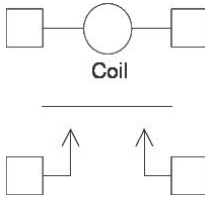

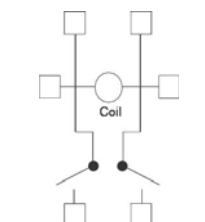
## 700-HG Power Relay

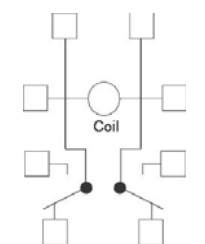
- 40 A Contact Ratings
- SPST-NO-DM, SPDT, DPST-NO, DPDT
- Panel Mounted
- Options: Magnetic Blowout for High DC Loads, Auxiliary Snap Action Switch
- Screw Terminals #6-32 for Coil, #8-32 for Contacts

	Description	Contact Ratings	Wiring Diagrams	Coil Voltage	Cat. No. <sup>(1)</sup>
	SPST-NO-DM 1 Form X AgCdO Contacts	40 A (A600)		24V AC	700-HG45A24
				120V AC	700-HG45A1
				240V AC	700-HG45A2
				277V AC	700-HG45A27
				480V AC	700-HG45A4
				12V DC	700-HG45Z12
				24V DC	700-HG45Z24
				48V DC	700-HG45Z48
				110V DC	700-HG45Z1
					SPDT 1-pole 1 Form C AgCdO Contacts
120V AC	700-HG46A1				
240V AC	700-HG46A2				
12V DC	700-HG46Z12				
24V DC	700-HG46Z24				
48V DC	700-HG46Z48				
110V DC	700-HG46Z1				
	DPST-NO 2-pole 2 Form A AgCdO Contacts	40 A (A600)		24V AC	700-HG47A24
				120V AC	700-HG47A1
				240V AC	700-HG47A2
				480V AC	700-HG47A4
				12V DC	700-HG47Z12
				24V DC	700-HG47Z24
				48V DC	700-HG47Z48
110V DC	700-HG47Z1				
	DPDT 2-pole 2 Form C AgCdO Contacts	40 A (A600)		24V AC	700-HG42A24
				120V AC	700-HG42A1
				240V AC	700-HG42A2
				277V AC	700-HG42A27
				12V DC	700-HG42Z12
				24V DC	700-HG42Z24
				48V DC	700-HG42Z48
				110V DC	700-HG42Z1
				220V DC	700-HG42Z2
				250V DC	700-HG42Z25

(1) Auxiliary Snap Switch Option: Add suffix (-5) to the selected 700-HG relay Cat. No., except for the 220V DC add (-5L).  
Magnetic Blowout Option: Add suffix (-6) to the selected 700-HG relay Cat. No. (suppresses the arc when switching DC loads – ratings listed below).

**Accessories - 700-HG Relays**

Photo	Description	Pkg. Qty.	Cat. No.
	<p><b>Pre-Printed Identification Tags</b> — contains 10 sheets of pre-printed and blank tags. Each sheet contains 13 sets of the markings CR...9CR, TR...9TR, M...9M, F, R, 1S, and 117 blank tags. Tags are peel-off with sticky backing for easy placement on relays.</p>	10	700-N40
	<p><b>Blank Identification Tags</b> — contains 10 sheets of blank identification tags for customer specialized printing. Each sheet contains 546 blank tags. Tags are peel-off with sticky backing for easy placement on relays.</p>	10	700-N41
	<p><b>Type 1 Enclosure</b> For use with any of the listed relays. Knockouts for 1/2 in. and 3/4 in. conduit connections. The enclosure exceeds the minimum clearances required by U.S. standards, resulting in generous wiring spaces.</p>	1	700-HN120

**Auxiliary Snap Action Switch**

Contact	Material	Rating	Dielectric Withstand V (1 Min.)
SPDT (1 Form C)	Silver Cad. Ox.	10 A at 120 or 240 Resistive	1500V AC RMS Contact to Frame

## Specifications - 700-HG Relays

Attribute		700-HG									
<b>Electrical Ratings</b>											
Pilot Duty Rating <sup>(1)</sup>		A600									
Rated Thermal Current ( $I_{th}$ )		40 A									
Rated Insulation Voltage ( $U_i$ )		600V UL									
<b>Contact Ratings: AC Ratings SPST-NO-DM</b>						<b>Contact Ratings: AC Ratings SPDT, DPST - NO and DPDT</b>					
Volts	Inductive			Resistive - Make/Break and Continuous	HP	Volts	Inductive			Resistive - Make/Break and Continuous	HP <sup>(2)</sup>
	Make	Break	Continuous				Make	Break	Continuous		
120	60 A	6 A	10 A	40 A	2	120	60 A	6 A	10 A	40 A	1 - 1/2
240	30 A	3 A	10 A	40 A		240	30 A	3 A	10 A	40 A	
480V	15 A	1.5 A	10 A	12 A	2	480	15 A	1.5 A	10 A	5 A	1 - 1/2
600V	12 A	1.2 A	10 A	10 A		600	15 A	1.2 A	10 A	5 A	
DC Ratings: Without Magnetic Blowouts - 28V 40 A - Make, Break and Continuous Est Drop 125V 1.2...3 A											
DC Ratings: With Magnetic Blowouts:		SPST - NO - DM		SPDT, DPST - NO and DPDT							
Make, Break, and Continuous		110V	20 A	10 A							
		220V	8 A	4 A							
		325V	4 A	2 A							
		500V	2 A	—							
Permissible Coil Voltage Variation		80...100% of Nominal Voltage at 50 Hz									
		85...110% of Nominal Voltage at 60 Hz									
		80...110% of Nominal Voltage at DC									
		<b>50 HZ</b>		<b>60 HZ</b>							
Coil Consumption $\pm 10\%$		AC Coils		Inrush	13 VA	16 VA					
				Sealed	10 VA	11 VA					
		DC Coils		2.0 W							
<b>Design Specification/Test Requirements</b>											
Dielectric Withstand Voltage		Pole-to-Pole		2200V AC							
		Contact to Pole		2200V							
		Contact to Frame		2200V AC							
<b>Mechanical</b>											
Degree of Protection		Open Type									
Mechanical Life Operations		5 x 10 <sup>6</sup>									
Switching Frequency Operations		1600/Hr									
Coil Voltage		See Overview/Product Selection									
Operating Time at Nominal Voltage at 20 °C (68 °F)		Pickup		40 ms							
		Dropout		35 ms							
Maximum Operating Rate		—									

## Specifications - 700-HG Relays

<b>Environmental</b>		
Temperature	Operating	30...+55 °C (-22...+149 °F)
	Storage	-30...+65 °C (-22...+149 °F)
Altitude		2000 m (6560 ft)
<b>Construction</b>		
Insulating Material		Molded Thermo
		Setting Plastic
Enclosure		—
Contact Material		Silver Cadmium Oxide
Terminal Markings on Socket		—
Sockets		—
Certifications		CSA Certified, File 225674, UL Listed, File E3125, Guide NLDX, CE Marked
Standards		UL 508, CSA 22.2 No. 14, EN/IEC 60947-1, -5-1

- (1) NEMA Rating Chart is on page 19 of publication 700-SG003B-EN-P.  
 (2) For DPDT only: 2 Hp Switching 2 Poles, 200...600V AC, 50/60 Hz.

## Dimensions - 700-HG Relays

Approximate dimensions are shown in millimeters (inches). Dimensions are not intended for manufacturing purposes.

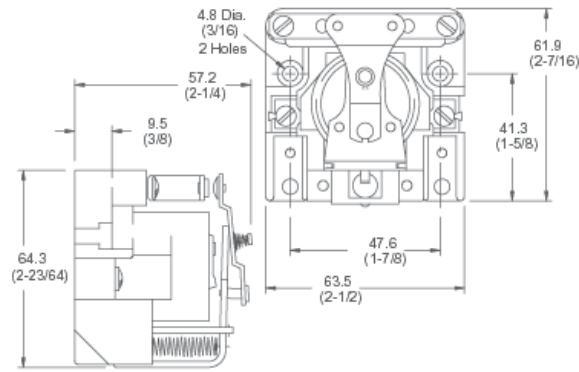

700-HG Relay, SPST-NO-DM

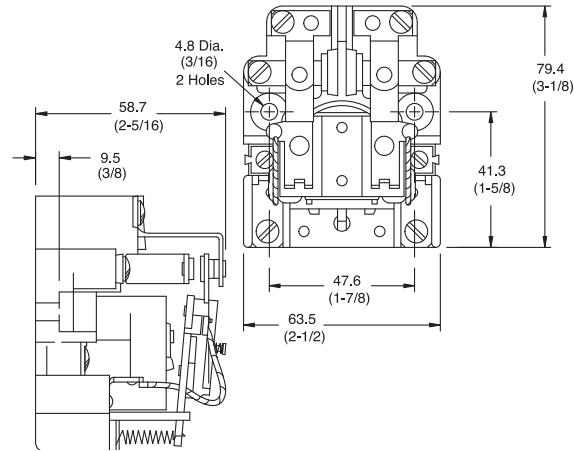

700-HG Relay

### 700-HHF Flange Mount Power Relay

- Flange-Mounted
- Blade Style 0.250 x 0.032 Quick Connect/Solder (no socket) Terminals
- Solder Terminals (no socket)

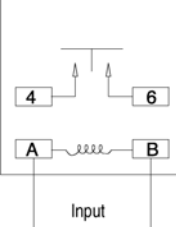
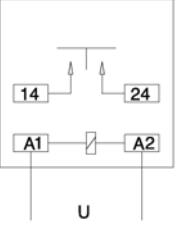
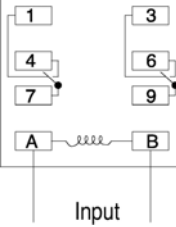
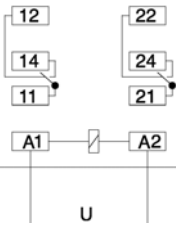
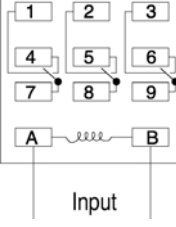
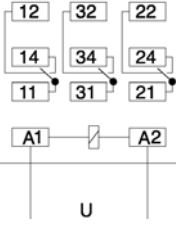
	Description	Contact Rating	Wiring Diagrams		Coil Voltage	Cat. No.
			U.S./Canada	International		
	SPST-NO-DM 1 Form X AgCdO Contacts	30 A (A600)			120V AC	700-HHF45A1
			24V DC	700-HHF45Z24		
	DPDT 2-Pole 2 Form C AgCdO Contacts	25 A (B600)			24V AC	700-HHF62A24
					120V AC	700-HHF62A1
					240V AC	700-HHF62A2
					12V DC	700-HHF62Z12
					24V DC	700-HHF62Z24
	3PDT 3-Pole 3 Form C AgCdO Contacts	20 A (B300)			120V AC	700-HHF73A1

### Specifications - 700-HHF Relays

Attribute	700-HHF...										
<b>Electrical Ratings</b>											
Pilot Duty Rating <sup>(1)</sup>	SPST-NO-DM					NEMA A600					
	DPDT					NEMA B600					
	3PDT					NEMA B300					
Rated Thermal Current ( $I_{th}$ )	SPST-NO-DM 30 A, DPDT 25A, 3PDT 20 A										
Rated Insulation Voltage ( $U_i$ )	250V IEC-300V UL/CSA										
Contacts	Inductive	SPST-NO-DM			Hp	DPDT		Hp	3PDT		Hp
		▶][◀	◀][▶			▶][◀	◀][▶		▶][◀	◀][▶	
	120VAC	60 A	6 A	1	30 A	3 A	1	30 A	3 A	1/2	
	240VAC	30 A	3.0 A	1-1/2	15 A	1.5 A	1-1/2	15 A	1.5 A	—	
	DC	28V DC, 30 A			28V DC, 13 A		—		—		



## Specifications - 700-HHF Relays

Attribute			700-HHF...					
Permissible Coil Voltage Variation			85...110% of Nominal Voltage at 50 Hz					
			85...110% of Nominal Voltage at 60 Hz					
			80...110% of Nominal Voltage at DC					
			SPST-NO-DM		DPDT		3PDT	
			50 Hz	60 Hz	50 Hz	60 Hz	50 Hz	60 Hz
Coil Consumption ±10%	AC Coils	Inrush	7.2 VA	6.3 VA	7.2 VA	6.3 VA	7.2 VA	6.3 VA
		Sealed	4.8 VA	4.2 VA	4.8 VA	4.2 VA	4.8 VA	4.2 VA
	DC Coils		1.4 W					
Max. Allowable Leakage			25% of VA					
			10% of W					
<b>Design Specification/Test Requirements</b>								
Dielectric Withstand Voltage		Pole-to-Pole	2200V AC					
		Contact-to-Pole	2200V AC					
		Contact-to-Frame	1600V AC					
<b>Mechanical</b>								
Mechanical Life Operations			5 x 10 <sup>6</sup>					
Switching Frequency Operations			3600/Hr					
Coil Voltages			See Overview/Product Selection					
Operating Time at Nominal Voltage at 20 °C		Pickup	20 ms					
		Dropout	15 ms					
Maximum Operating Rate			4 Ops/s.					
<b>Environmental</b>								
Temperature		Operating	-30...+50 °C					
			(-22...+122 °F)					
		Storage	-30...+100 °C					
			(-22...+212 °F)					
Altitude			2000 m (6560 ft)					
<b>Construction</b>								
Insulating Material			Molded High Dielectric Material					
Enclosure			Transparent Dust Cover					
Contact Material			Silver Cadmium Oxide					
Terminal Markings			In accordance with EN50 0005					
Sockets			(2)					
Certifications			cURus Recognized, File E3125, Guide NLDX2/NLDX8, CE Marked					
Standards			UL 508, CSA 22.2 No.14, EN/IEC 60947-1, -5-1					

(1) See [NEMA Ratings and Test Values on page 5](#).

(2) 700-HHF relay wiring and terminals are the quick connect / solder type 6.35 x 0.82 mm (0.250 x 0.032 in) termination.

### Dimensions - 700-HHF Relays

Approximate dimensions are shown in millimeters (inches). Dimensions are not intended for manufacturing purposes.

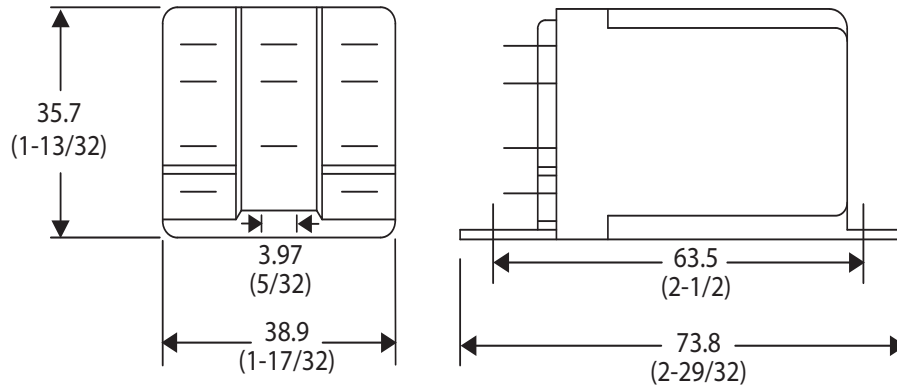

700-HHF Relay

## 700-HTA Alternating Relay

- Alternating Relay
- Rugged Pin Style Socket Mounting
- 10 A, SPDT, DPDT, and Cross Wired
- Excellent for Pump Panel Applications



700  
a
-
HTA  
b
2  
c
A12  
d
7  
e







### Catalog Number Explanation - 700-HTA Relays

a Bulletin Number	-	b Relay Type	c Model Type	d Coil Voltage	e Gold Plated Contacts Option
700		HTA - Tube Base Alternating Relay	1 - SPDT 2 - DPDT 3 - Cross-Wired	A12 - 12V AC 50/60 Hz A24 - 24V AC 50/60 Hz A1 - 120V AC 50/60 Hz A2 - 240V AC 50/60 Hz	Blank - Without switch 7 - With switch

### Alternating Relays with Pin-Style Terminations

700-HTA	Alternating Relay	Wiring Diagrams	
		U.S./Canada	International
SPDT Form C Contact	SPDT		
DPDT 2 Form C Contact	DPDT		
Cross-Wired DPDT 2 Form C Contacts	Cross-Wired		

**Accessories - 700-HTA Relays**

Photo	Description	Pkg. Qty.	Cat. No.
	<p><b>Screw Terminal Tube Base Socket — Panel or DIN Rail Mounting; Guarded Terminal Construction.</b> 8-Pin for use with 700-HTA1A or -HTA3A alternating relays. Order ten or multiples of ten.</p>	10	700-HN100
	<p><b>Screw Terminal Tube Base Socket — Panel or DIN Rail Mounting; Open Style Construction.</b> 8-Pin for use with 700-HTA1A or -HTA3A alternating relays. Order ten or multiples of ten. No retainer clip required.</p>	10	700-HN125
	<p><b>Screw Terminal Tube Base Sockets — Panel or DIN Rail Mounting; Guarded Terminal Construction.</b> 11-pin for use with 700-HTA2A alternating relays. Order in multiples of 10.</p>	10	700-HN101
	<p><b>Screw Terminal Tube Base Sockets — Panel or DIN Rail Mounting; Open Style Terminal Construction.</b> 11-pin for use with 700-HTA2A alternating relays. Order in multiples of 10. No retainer clip required.</p>	10	700-HN126
	<p><b>DIN (#3) symmetrical hat rail</b> 35 x 7.5 x 1 m</p>	10	199-DR1
	<p><b>Retainer Clip for Cat. Nos. 700-HN100 and -HN101 Sockets with 700-HT Timing Relays, and 700-HTA Alternating Relays</b> Secures relay in socket. Order must be for 10 clips or multiples of 10.</p>	10	700-HN110
	<p><b>Pre-Printed Identification Tags</b> — contains 10 sheets of pre-printed and blank tags. Each sheet contains 13 sets of the markings CR...9CR, TR...9TR, M...9M, F, R, 1S, and 117 blank tags. Tags are peel-off with sticky backing for easy placement on relays.</p>	10	700-N40
	<p><b>Blank Identification Tags</b> — contains 10 sheets of blank identification tags for customer specialized printing. Each sheet contains 546 blank tags. Tags are peel-off with sticky backing for easy placement on relays.</p>	10	700-N41

## Specifications - 700-HTA Relays

Attribute		700-HTA		
<b>Electrical Ratings</b>				
Pilot Duty Rating <sup>(1)</sup>		NEMA B300 AC 15		
Rated Thermal Current ( $I_{th}$ )		10 A		
Rated Insulation Voltage ( $U_i$ )		250V IEC, 300V UL/CSA		
Contacts	Inductive	<b>Make</b>	<b>Break</b>	<b>HP</b>
		▶ ◀	◀ ▶	
	120V AC	30 A	3 A	1/3
	240V AC	15 A	1.5 A	1/2
	Resistive 30V DC	10 A	10 A	—
Permissible Coil Voltage Variation		85...110% of Nominal Voltage at 50 Hz 85...110% of Nominal Voltage at 60 Hz		
Power Consumption ±10%	AC	24V AC	2 VA	
		120V AC	4 VA	
		240V AC	4 VA	
<b>Design Specification/Test Requirements</b>				
Dielectric Withstand Voltage	Pole-to-Pole, same circuit (VRMS)		1000V AC	
	Pole-to-Pole, different circuits (VRMS)		2000V AC	
	Contact-to-Coil (VRMS)		2000V AC	
Electrical Life Operations		100,000 minimum		
Switching Frequency Operations		1800/hr		
Coil Voltages		See product selection		
<b>Mechanical</b>				
Degree of Protection		Open Type (Guarded Terminal Sockets)		
Mechanical Life Operations		10 x 10 <sup>6</sup>		
Switching Frequency Operations		18,000/hr		
Start-up Time (max. time from power application until unit is timing)		0.05 sec		
Max. Function Time (max. time power can drop out and unit continues timing)		0.01 sec		
Min. Cycle Time		100 ms on release of the control switch		

**Specifications - 700-HTA Relays**

Attribute	700-HTA	
<b>Environmental</b>		
Temperature	Operating	-28...+65 °C (50 °C max., 240V AC coil) (-18...+149 °F) (122 °F max., 240V AC coil)
	Storage	-55...+85 °C (-67...+185 °F)
Altitude	2000 m (6560 ft)	
<b>Construction</b>		
Insulating Material	Molded High Dielectric Material	
Enclosure	Impact Resistant Dust Cover	
Contact Material	Silver Tin Oxide	
Terminal Markings on Socket	In accordance with EN50 005	
Sockets	8- or 11-Pin Socket 700-HN100, -HN125 700-HN101, -HN126	
Certifications	CSA Certified, File 223833, UL Recognized (File E3125 Guide NLDX2/NLDX8), cULus Listed with 700-HN100, 700-HN101, 700-HN125, and 700-HN126 Sockets (File No. E3125 Guide NLDX/NLDX7), CE-Marked (per EU Low Voltage Directive)	
Standards	EN 61812-1, CSA 22.2 No. 14, UL 508	

(1) See [NEMA Ratings and Test Values on page 5](#).

*Trigger Signal Cat. Nos. 700-HTA*

Contact closure provides signal to timer. The 700-HTA alternating relay generates a low energy signal. For optimum reliability, use contacts designed for low energy switching (10V, 1 mA) (Example: Bul. 800F-X\_V, 800T-X\_V). No external voltage can be connected to the contact signal.

*Load Diagrams - 700-HTA Relays*

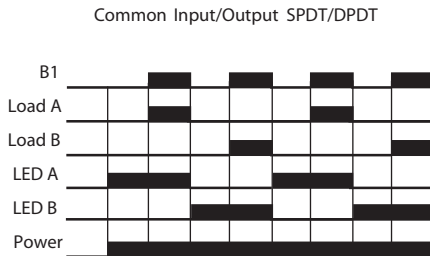

Socket Pinout Map SPDT	
Relay	Socket
A1	4
A2	3

Socket Pinout Map DPDT	
Relay	Socket
A1	4
A2	8

Note: pin out in wiring diagram may not match actual printed socket see pinout map for wiring up the power source

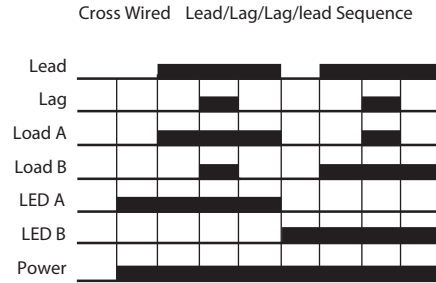

Socket Pinout Map Cross-Wired	
Relay	Socket
A1	3
A2	6

Note: pin out in wiring diagram may not match actual printed socket see pinout map for wiring up the power source

### Dimensions - 700-HTA Relays

Approximate dimensions are shown in millimeters (inches). Dimensions are not intended for manufacturing purposes.

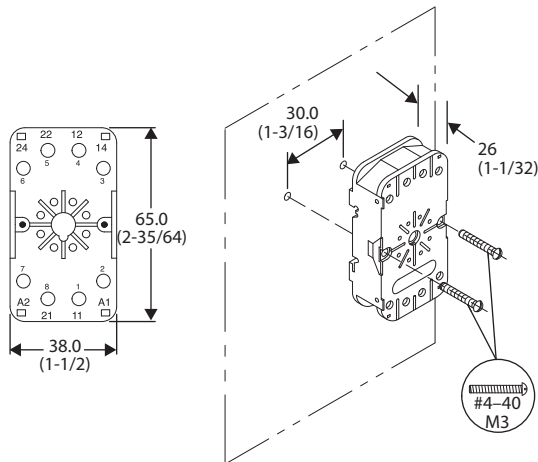
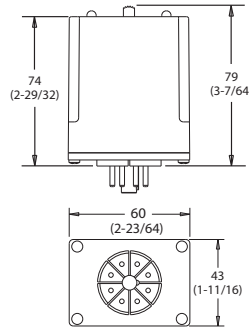

Cat. No. 700-HN100  
Panel Mounting

Double Wire — 2 x 2.5 mm<sup>2</sup> (#2 – 14 AWG... #2 – 20 AWG)  
(Either Solid or Stranded)  
Strip Length: 9 mm (3/8 in) – Torque: 0.8 N·m (7 lb·in)

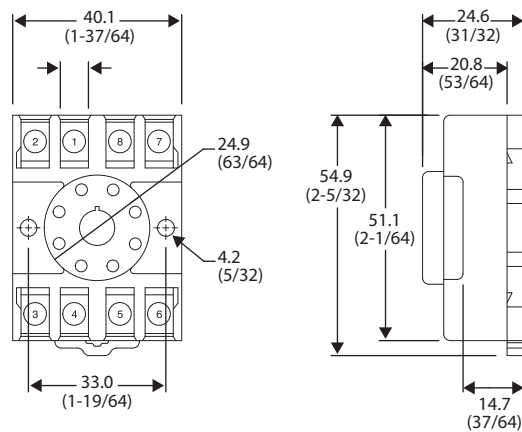

Cat. No. 700-HN125  
Wire Size: 2 x 2.5 mm<sup>2</sup>

Single Wire — Up to #12 AWG  
Double Wire — 2 x 2.5 mm<sup>2</sup> (#2 – 14 AWG... #2 – 20 AWG)  
(Either Solid or Stranded)  
Strip Length: 9 mm (3/8 in) — Torque: 0.8 N·m (7 lb·in)

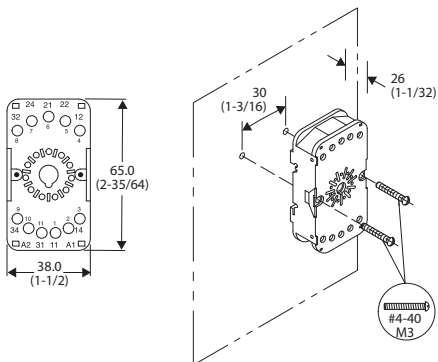

Cat. No. 700-HN101  
Panel Mounting

Double Wire — 2 x 2.5 mm<sup>2</sup> (#2 – 14 AWG... #2 – 20 AWG)  
(Either Solid or Stranded)  
Strip Length: 9 mm (3/8 in) – Torque: 0.8 N·m (7 lb·in)

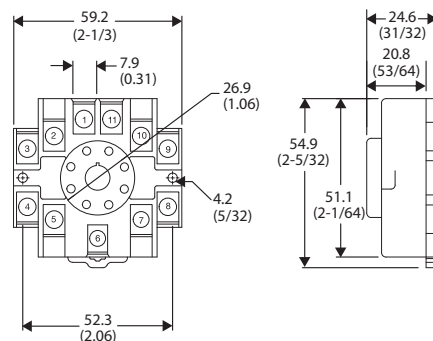





Cat. No. 700-HN126  
Wire Size: 2 x 2.5 mm<sup>2</sup>





Single Wire — Up to 12 AWG  
Double Wire — 2 x 2.5 mm<sup>2</sup> (#2 – 14 AWG... #2 – 20 AWG)  
(Either Solid or Stranded)  
Strip Length: 9 mm (3/8 in) — Torque: 0.8 N·m (7 lb·in)





## General Purpose Electronic Timers and Counters

### Product Overview

					
<b>Bulletin No.</b>	<b>700-FE</b>	<b>700-FS</b>	<b>700-HR52, -HRP, -HRS, -HRT, -HRV</b>	<b>700-HRM/-HRC</b>	<b>700-HRF</b>
<b>Type</b>	DIN Rail Timer	DIN Rail Timer	Multifunction Timer	On-Delay Timer	Twin Timer
<b>Features</b>	<ul style="list-style-type: none"> <li>Only 17.5 mm wide</li> <li>5 A contact rating</li> <li>Multifunction or single function</li> <li>No additional socket required</li> </ul>	<ul style="list-style-type: none"> <li>Only 22.5 mm wide</li> <li>8 A contact rating</li> <li>Multifunction or single function</li> <li>No additional socket required</li> <li>Optional:               <ul style="list-style-type: none"> <li>Star-delta timing function</li> <li>True off-delay timing function</li> <li>Hazardous location certification</li> </ul> </li> </ul>	<ul style="list-style-type: none"> <li>Dial timing relays</li> <li>5 A contact rating</li> <li>Multiple programmable timing ranges</li> <li>Tube base pin style terminals</li> <li>Multi-voltage inputs</li> <li>Timed contacts and instantaneous contacts</li> <li>Transistor outputs</li> <li>Single function and multi-function</li> <li>7 different operating modes</li> </ul>	<ul style="list-style-type: none"> <li>Dial timing relays</li> <li>5 A contact rating</li> <li>Multiple programmable timing ranges</li> <li>Tube base pin-style terminals</li> <li>Multi-voltage inputs</li> <li>Timed contacts and instantaneous contacts</li> <li>Transistor outputs</li> <li>Single function and multi-function</li> </ul>	<ul style="list-style-type: none"> <li>Independent ON and OFF settings</li> <li>14 time ranges</li> <li>8-pin models available</li> <li>Dial timing relays</li> <li>UL508</li> </ul>
<b>Control Outputs: Time Limit Instantaneous</b>	1 N.O. or SPDT timed	SPDT or DPDT or 2 N.O. + 1 common	DPDT Timed, Transistor SPDT Timed/Instantaneous	DPDT Timed, Transistor SPDT Timed/Instantaneous	DPDT Timed
<b>Operation Modes:</b>	On-delay Off-delay One shot Repeat cycle-pulse Fleeting off-delay Pulse converter	11 timing modes	On-Delay Off-Delay One Shot Repeat Cycle Off Start Repeat Cycle On Start Signal On/Off-Delay On-Delay One Shot	On-Delay	Repeat Cycle Off Start Repeat Cycle On Start
<b>Time Range</b>	0.05 s... 10 hr	0.05 s... 60 hr	0.05 s... 300 h	0.05 s... 300 h	0.05 s... 300 h
<b>Supply Voltage</b>	24V AC/DC 110...240V AC 24...48V AC/DC 24...240V AC	12V DC 24V...48V DC 24V...240V AC	12...48V DC 24...48V AC 100...240V AC 100...125V DC	12...48V DC 24...48V AC 100...240V AC 100...125V DC	12V DC 24V AC/DC 48...125V DC 100...240V AC
<b>Contact Rating at 120V AC</b>	5 A	8 A	5 A	5 A	5 A
<b>Certifications</b>	CE, cULus	CE, cULus	cURus, CE, C-Tick	cURus, CE, C-Tick	cURus, CE, C-Tick
<b>Socket Cat. No(s).</b>	DIN Rail or panel mount	DIN Rail or panel mount	700-HN100 OR 700-HN101 700-HN125 OR 700-HN126	700-HN100 700-HN125	700-HN100 700-HN125
<b>Page</b>	<a href="#">92</a>	<a href="#">96</a>	<a href="#">116</a>	<a href="#">117</a>	<a href="#">117</a>

				
<b>Bulletin No.</b>	<b>700-HRY</b>	<b>700-HRQ</b>	<b>700-HNC</b>	<b>700-HNK</b>
<b>Type</b>	Star-Delta Timer	True Off-Delay Timer	Miniature Timer	Ultra-Slim Timer
<b>Features</b>	<ul style="list-style-type: none"> <li>A wide star-time range (up to 120 s)</li> <li>Star-delta transfer time range (up to 0.5 s)</li> <li>UL Recognized</li> </ul>	<ul style="list-style-type: none"> <li>Dial timing relays</li> <li>Long power Off-delay times</li> <li>11-pin and 8-pin models are available</li> <li>UL Recognized</li> </ul>	<ul style="list-style-type: none"> <li>Four different operating modes</li> <li>DIN Rail mount with socket</li> <li>Pin configuration same as 700-HC relay</li> </ul>	<ul style="list-style-type: none"> <li>Ultra-slim timing relay</li> <li>Four different operating modes</li> <li>Three operating voltages</li> <li>DIN Rail mount with socket</li> <li>Pin configuration same as 700-HK relay</li> </ul>
<b>Control Outputs: Time Limit Instantaneous</b>	SPST (Star, Delta) Timed SPST - NO Instantaneous	DPDT Timed	4PDT	SPDT, DPST-NO
<b>Operation Modes:</b>	Star-Delta	True OFF-delay Timer True OFF-delay Timer w/reset	On-Delay One Shot Repeat Cycle Off Start Repeat Cycle On Start	On-Delay One Shot Repeat Cycle Off Start Repeat Cycle On Start
<b>Time Range</b>	0.5 s...120 s	0.05 s...12 min	0.1 s...10 h	0.1 s...10 h
<b>Supply Voltage</b>	100...120V AC 200...240V AC	48V DC 24V AC/DC 100...240V AC 100...125V DC	12V DC 24V AC/DC 48...125V DC 100...240V AC	12V DC 24V DC 24V AC
<b>Contact Rating at 120V AC</b>	5 A	5 A	5 A	5 A
<b>Certifications</b>	cURus, CE, C-Tick	cURus, CE, C-Tick	cURus, CSA, CE, C-Tick	cURus, CE, ACA
<b>Socket Cat. No(s).</b>	700-HN100 700-HN125	700-HN100 OR 700-HN101 700-HN125 OR 700-HN126	700-HN103 700-HN128	700-HN121 700-HN122
<b>Page</b>	<a href="#">117</a>	<a href="#">118</a>	<a href="#">103</a>	<a href="#">109</a>

			
<b>Bulletin No.</b>	<b>700-HT</b>	<b>700-HV</b>	<b>700-HX</b>
<b>Type</b>	Tube Base Timing Relay	Repeat-Cycle Timing Relay	Digital Timer
<b>Features</b>	<ul style="list-style-type: none"> <li>Pin-style terminals</li> <li>Single range or fixed timers</li> <li>Available as ON- or OFF-Delays</li> </ul>	<ul style="list-style-type: none"> <li>Pin-style terminals</li> <li>Single-range timer</li> <li>Repeat cycle</li> </ul>	<ul style="list-style-type: none"> <li>Digital timer</li> <li>5 A contact rating</li> <li>Negative transmissive LCD display</li> <li>10 functions or modes</li> <li>Environmentally friendly—flash memory, no battery</li> <li>NEMA B300 rated</li> <li>NEMA 4/IP66</li> <li>DIN Rail or panel mount capable</li> </ul>
<b>Control Outputs: Time Limit Instantaneous</b>	DPDT	DPDT	SPDT
<b>Timing Operation Modes:</b>	On-Delay Off-Delay	Repeat Cycle	Signal On-Delay 1 and 2 Signal Off-Delay One Shot Repeat Cycle Off Start Repeat Cycle On Start Signal On/Off-Delay Power On-Delay 1 and 2 Twin Timer Cumulative
<b>Time Range</b>	0.1 s . . . 30 min.	0.1 s . . . 30 min.	0.05 s . . . 300 h
<b>Supply Voltage</b>	12V DC 24V DC 24V AC 120V AC 240V AC	24V DC 24V AC 120V AC 240V AC	12 . . . 24V DC 24V AC 100 . . . 240V AC
<b>Contact Rating at 120V AC</b>	10 A	10 A	5 A
<b>Certifications</b>	UR, UL, CSA, CE	UR, UL, CSA, CE	cURus, CE, C-Tick
<b>Socket Cat. No(s).</b>	700-HN100 OR 700-HN101 700-HN125 OR 700-HN126	700-HN100 700-HN125	700-HN100 700-HN125
<b>Page</b>	<a href="#">128</a>	<a href="#">133</a>	<a href="#">138</a>

## 700-FE Economy Timing Relay

- Adjustable function and timing range timing relays
- DIN Rail mounted without cost of socket
- 17.5 mm wide, multi-function or single function
- Available as 1 N.O. or SPDT contact output, 5 A
- Timing ranges from 0.05 s...10.0 hr
- Coil surge protection



### Multi-Function

This device offers you the flexibility of selecting one of 4 single timing functions.

Operating Mode	Contact Output	Timing Range <sup>(1)</sup>	Input Voltage	Cat. No.
ON-delay, OFF-delay, One Shot, Flasher (repeat cycle starting with pulse)	1 N.O.	0.05 s...10 hr (6 settings)	24V AC/DC <sup>(2)</sup> 110...240V AC 50/60 Hz	700-FEM1TU22
ON-delay, OFF-delay, One Shot, Flasher (repeat cycle starting with pulse)	SPDT (1 C/O)	0.05 s...10 hr (6 settings)	24V...48V AC/DC 24...240V AC 50/60 Hz	700-FEM3TU23

(1) Time ranges: 0.05 s...1 s, 0.5...10 s, 0.05...1 min, 0.5...10 min, 0.05...1 hr, 0.5...10 hr.

(2) Voltage is either 24V AC/DC 50/60 Hz.

### Single-Function

This device offers you one specific timing function.

Operating Mode	Contact Output	Timing Range <sup>(1)</sup>	Input Voltage	Cat. No.
ON-delay	1 N.O.	0.05 s...10 hr (6 settings)	24V AC/DC 110...240V AC 50/60 Hz <sup>(2)</sup>	700-FEA1TU22
	SPDT (1 C/O)	0.05 s...10 hr (6 settings)	24V...48V AC/DC 24...240V AC 50/60 Hz	700-FEA3TU23
OFF-delay	1 N.O.	0.05 s...10 hr (6 settings)	24V AC/DC 110...240V AC 50/60 Hz <sup>(2)</sup>	700-FEB1TU22
	SPDT (1 C/O)	0.05 s...10 hr (6 settings)	24V...48V AC/DC 24...240V AC 50/60 Hz	700-FEB3TU23
One Shot	1 N.O.	0.05 s...10 hr (6 settings)	24V AC/DC 110...240V AC 50/60 Hz <sup>(2)</sup>	700-FED1TU22
	SPDT (1 C/O)	0.05 s...10 hr (6 settings)	24V...48V AC/DC 24...240V AC 50/60 Hz	700-FED3TU23
Fleeting OFF-delay	SPDT (1 C/O)	0.05 s...10 hr (6 settings)	24V...48V AC/DC 24...240V AC 50/60 Hz	700-FEE3TU23
Flasher (repeat cycle starting with pulse)	1 N.O.	0.05 s...10 hr (6 settings)	24V AC/DC 110...240V AC 50/60 Hz <sup>(2)</sup>	700-FEF1TU22
	SPDT (1 C/O)	0.05 s...10 hr (6 settings)	24V...48V AC/DC 24...240V AC 50/60 Hz	700-FEF3TU23
Pulse Converter	SPDT (1 C/O)	0.05 s...10 hr (6 settings)	24V...48V AC/DC 24...240V AC 50/60 Hz	700-FEL3TU23

(1) Time ranges: 0.05 s...1 s, 0.5...10 s, 0.05...1 min, 0.5...10 min, 0.05...1 hr, 0.5...10 hr.

(2) Voltage is either 24V AC 50/60 Hz or 24V DC.

### Special Functions

Operating Mode	Contact Output	Timing Range <sup>(1)</sup>	Input Voltage	Cat. No.
Star-Delta	2 N.O. with 1 Common	0.15 s...10 min (4 settings)	24V...48V AC/DC 24...240V AC 50/60 Hz	700-FEY2QU23

(1) Time ranges: 0.15...3 s, 0.5...10 s, 3 s...1 min, 30 s...10 min.

Accessories - 700-FE Relays

Description	Pkg. Quantity	Cat. No.
 <p><b>Panel Mounting Adapter</b> For surface mounting according to drilling plan EN 50 002</p>	5	199-FSA
<p><b>Label Sheet</b> 105 self-adhesive paper labels each, 6 x 17 mm</p>	10	100-FMS

Function and Connection Diagrams - 700-FE Relays

(A) On-Delay

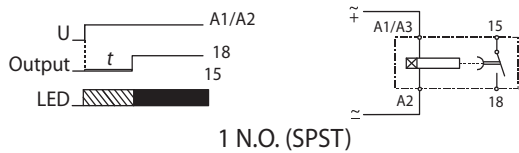

(B) Off-Delay

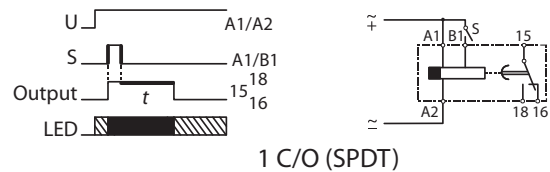
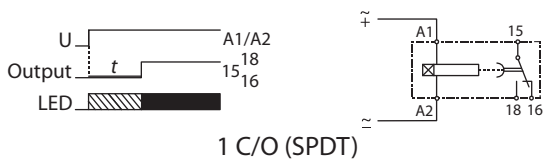
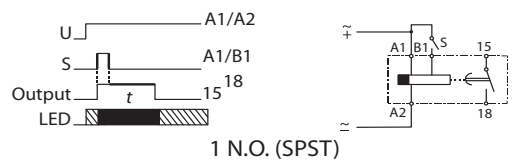

(D) One Shot

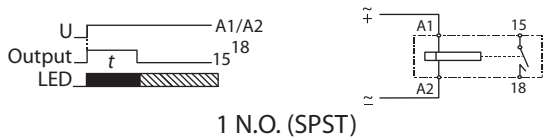

(F) Flasher (Repeat Cycle Starting with Pulse)

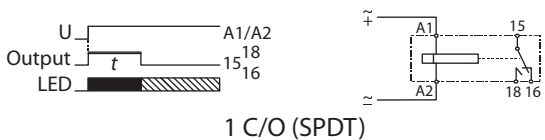
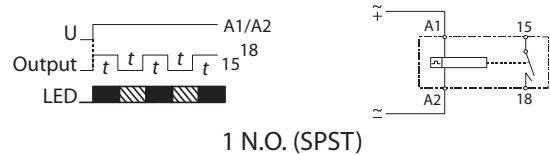

(E) Fleeting Off-Delay

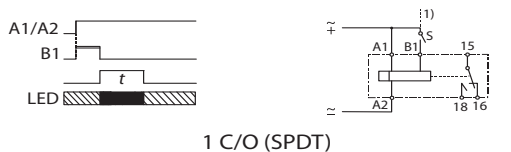

(L) Pulse Converter







(Y) Star-Delta Timing Relay





Bi-color light-emitting diode: 1 C/O (SPDT) or 1 N.O. Contact Timers

Single Color light-emitting diode: 2 N.O. with Common

 LED U = green: Supply voltage available.  
 LED Relay = red: Output is energized.

 ON = green  
 OFF = red

Specifications - 700-FE Relays<sup>(1)</sup>

Attribute		700-FE			
			1 N.O.		SPDT
Setting Accuracy		±5% of full scale			
Repeatability		±1% of setting (typical)			
Tolerance		By voltage: ±0.01%/ΔU By temperature: ±0.25%/°C		By voltage: ±0.001%/ΔU By temperature: ±0.025%/°C	
<b>Supply</b>					
Supply Voltage		24V AC/DC <sup>(1)</sup> and 110...240V AC, 50/60 Hz		24...48V DC and 24...240V AC, 50/60 Hz	
Voltage Tolerance	AC	-15%/+10%			
	DC	-15%/+20%			
Power Consumption		0.5 W at 24V DC, 5VA at 240V AC			
Time Energized		100%			
Reset Time		100 ms			
Cable Length (Supply Voltage Control)		Max. 250 m (750 feet)			
<b>Pulse Control (B1)</b>					
Impulse Duration		≥ 250 ms		≥ 50 ms (AC), ≥ 30 ms (DC)	
Input Voltage		supply voltage range			
Input Current		1 mA			
Cable Length		Max. 250 m without parallel load between B1 and A2 Max. 50 m with load (< 3 kΩ between B1 and A2)			
<b>Outputs</b>					
Contact Type		1 N.O. contact		1 Form C – SPDT contact	
Dielectric Withstand Voltage	Contact-to-coil	4000V			
	Power	1250VA			
Switching Capacity	According to IEC 947-5-1	AC-1	5 A /250V AC (resistive load)		
		AC-14	1 A/250V AC (inductive load)		
		DC-13	1 A/24V DC (inductive load)		
	According to UL 508	NEMA D300 - 1 A/300V AC			
Short circuit Resistance		6 A gL (Fast Blow Fuse)			
Life	Mechanical	20 million operations			
	Electrical	0.4 million at 1 A/250V AC, resistive 0.4 million at 0.5 A/250V AC, cos φ = 0.4 0.4 million at 1 A/24V DC, resistive			
State Indicator		1 bicolor light-emitting diode (Supply; Relay)			
Certifications		cULus Listed (File No. E14840, Guide NKCR/NKCR7), CE Marked			
Standards		EN/IEC 60947-1, EN/IEC 60947-5-1, UL 508, CSA 22.2 No. 14			
Insulation Characteristics		2 kV AC/50 Hz test voltage according to VDE 0435 and 4 kV 1.2/50 μs surge voltage according to IEC 60947-1 between all inputs and outputs			
EMC/Interference Immunity		The following requirements are fulfilled: Surge capacity of the supply voltage according to IEC 61000-4-5: Level 3 Burst according to IEC 61000-4-4: Level 3 ESD discharge according to IEC 61000-4-2: Level 3			
EMC / Emission		electromagnetic fields according to EN 55 022: Class B			

(1) Time Characteristics (according to VDE 0435, part 2021)

Attribute	700-FE	
Safe Isolation	according to VDE 0106 T 101	
Climatic Withstand	56 cycles (24 hr) at 25...40 °C and 95% relative humidity according to IEC 60068-2-30	
Vibration Resistance	4 g in three axes at 10...500 Hz, test FC according to IEC 60068-2-6	
Shock Resistance	50 g according to IEC 68-2-27	
Protection Class IEC 60947-1	Enclosure: IP40 Terminal: IP20	
Weight	60 g	60 g
Certifications	cULus, CE Certified	cULus, Germanischer Lloyd, CE Certified
Ambient Temperature	Open: -25...+60 °C Enclosed: -25...+45 °C Storage: -40...+85 °C	
Connections	Screw terminal M3 for Pozidriv No.1, Phillips, and slotted screws No.2. suitable for power screwdriver. Rated tightening torque 8.8 lb.-in. (max. 1.0 Nm) For terminal cross-sections of 1 x 0.5 mm <sup>2</sup> ...2 x 1.5 mm <sup>2</sup> (solid) or 2 x 1.5 mm <sup>2</sup> (stranded with sleeve), #20...14 AWG. Finger protection according to EN 50274	
Mounting	For surface mounting in any position; snap-on mounting on 35 mm DIN Rail or by adapter and two screws (M4 type)	
Disposal	Synthetic materials without dioxin according to EC/EFTA-Notification No. 93/0141/D electrical contacts are AgCd0	

(1) Voltage is either 24V DC or AC 50/60 Hz.

### Dimensions - 700-FE Relays

Approximate dimensions are shown in millimeters (inches). Dimensions are not intended for manufacturing purposes.

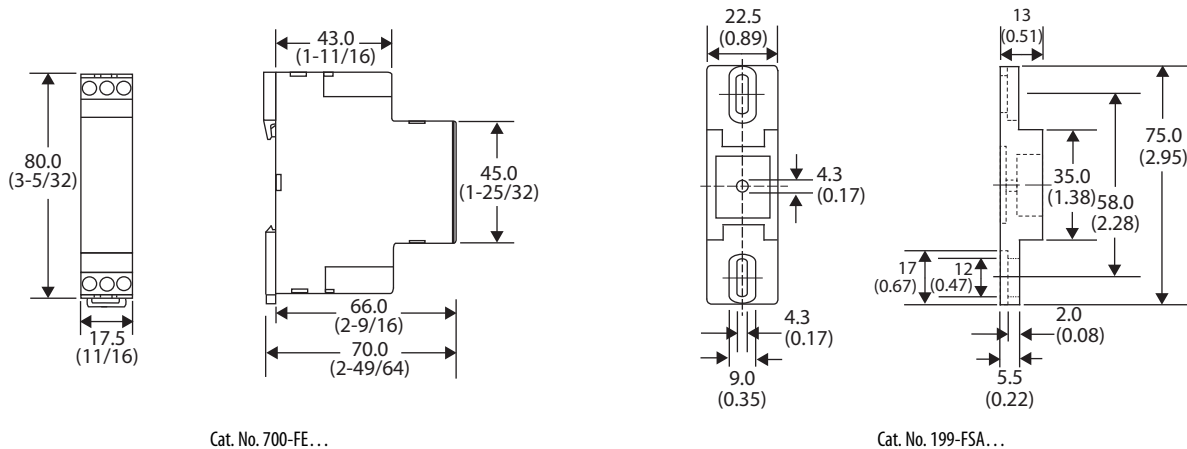

## 700-FS High Performance Timing Relay

- Adjustable function and timing range timing relays
- DIN Rail mounted without cost of socket
- 22.5 mm wide multi-function or single functions
- Available as SPDT or DPDT contact output, 8 A
- Timing Ranges From 0.05 s...60 hr
- Coil surge protection
- Hazardous location version available



### Catalog Number Explanation - 700-FS Relays

700 - FS H 3 U - U23  

a
b
c
d
e
f

a Bulletin Number	b Type of Relay	c Operating Mode	d Contact Output	e Timing Range	f Input Voltage
700	FS	A—On-delay B—Off-delay C—On- and off-delay D—One shot E—Fleeting off-delay F—Flasher (repeat cycle starts with pulse) G—Flasher (repeat cycle starts with pause) I—On-delay pulse generator J—On-delay (pulse controlled) K—One shot/watch dog (pulse controlled) L—Pulse converter	3—One changeover contact (SPDT) 1 C/O	A—0.05...1 s B—0.15...3 s C—0.5...10 s D—1.5...30 s E—0.05...1 min F—0.15...3 min G—0.5...10 min H—1.5...30 min I—0.05...1 hr J—0.15...3 hr K—0.5...10 hr L—3.0...60 hr U—0.05 s...60 hr <sup>(1)</sup>	Z12—12V DC U23—24...48V DC   24...240V AC 50/60 Hz

<sup>(1)</sup> Valid for functions "A" and "B" only.

### Single Function (With 2PDT 2 C/O contacts)

Operating Mode	Contact Output	Timing Range <sup>(1)</sup>	Input Voltage	Cat. No.
On-delay	(DPDT) 2 C/O	0.05 s...60 hr	12V DC	700-FSA4U212
On-delay	(DPDT) 2 C/O		24...48V DC 24...240V AC, 50/60 Hz	700-FSA4UU23
Off-delay	(DPDT) 2 C/O		12V DC	700-FSB4U212
Off-delay	(DPDT) 2 C/O		24...48V DC 24...240V AC, 50/60 Hz	700-FSB4UU23

<sup>(1)</sup> The time range of "0.05 s...60 hr" is selectable in 12 smaller ranges plus an ON and OFF function for maintenance needs.

### Single Function With Hazardous Location Certification<sup>(1)</sup> (With SPDT 1 C/O contacts)

Operating Mode	Contact Output	Timing Range	Input Voltage	Cat. No.
One Shot / Watch Dog (Pulse Controlled)	(SPDT) 1 C/O	0.05 s...1 s	24...48V DC 24...240V AC 50/60 Hz	700-FSK3AU23-EX
		0.5 s...10 s		700-FSK3CU23-EX



## Multi-Function

This device allows the flexibility of selecting one of 8 single timing functions.

Operating Mode	Contact Output	Timing Range	Input Voltage	Cat. No.
Multi-function timing relays 8 Single-functions: A, B, C, D, E, F, I, and L ON and OFF function additional (for installation and maintenance) note: See connection diagrams for further description.	(SPDT) 1 C/O	0.05 s...60 hr	12V DC	700-FSM3UZ12
	(SPDT) 1 C/O		24...48V DC 24...240V AC 50/60 Hz	700-FSM3UU23
	(DPDT) 2 C/O		12V DC	700-FSM4UZ12
	(DPDT) 2 C/O		24...48V DC 24...240V AC 50/60 Hz	700-FSM4UU23

## Multi-Function With Hazardous Location Certification <sup>(1)</sup>

This device allows the flexibility of selecting one of 8 single timing functions.

Operating Mode	Contact Output	Timing Range <sup>(1)</sup>	Input Voltage	Cat. No.
M Multi-function timing relays 8 Single-functions: A, B, C, D, E, F, I, and L ON and OFF function additional (for installation and maintenance) Note: See connection diagrams for further description.	(SPDT) 1 C/O	0.05 s...60 h	24...48V DC 24...240V AC 50/60 Hz	700-FSM3UU23-EX
	(DPDT) 2 C/O			700-FSM4UU23-EX

(1) The time range of "0.05 s...60 hr" is selectable in 12 smaller ranges plus an ON and OFF function for maintenance needs.

## Special Function

Operating Mode	Contact Output	Timing Range	Input Voltage	Cat. No.
Flasher (repeat cycle starting with pulse or pause)	(SPDT) 1 C/O	0.05 s...60 hr <sup>(2)</sup>	12V DC	700-FSH3UZ12
			24...48V DC 24...240V AC 50/60 Hz	700-FSH3UU23
		2 x 0.05 s...60 hr (2 ranges)	12V DC	700-FSH3VZ12
			24...48V DC 24...240V AC, 50/60 Hz	700-FSH3VU23
OFF-delay without supply voltages (True OFF-delay) <sup>(1)</sup>	(SPDT) 1 C/O	0.15 s...10 min <sup>(3)</sup>	24...240V DC 24...240V AC 50/60 Hz	700-FSQ3QU18
	(DPDT) 2 C/O			700-FSQ4QU18
Star-Delta	2 N.O. + 1 Common	0.5 s...10 s	24...48V DC 24...240V AC 50/60 Hz	700-FSY2CU23
		1.5...30 s		700-FSY2DU23
		0.05 s...1 min		700-FSY2EU23
		0.15...3 min		700-FSY2FU23
		0.5...10 min		700-FSY2GU23







(1) Due to shock during shipment, the state of the contacts should be verified before initial use. Minimum power on time is 800 msec

(2) The time range of "0.05 s...60 hr" is selectable in 12 smaller ranges plus an ON and OFF function for maintenance needs.

(3) This time range is selectable in four smaller ranges: 0.15 s...2.5 s, 0.5 s...10 s, 4 s...80 s, 30 s...10 min.



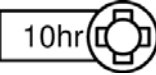



(1) Temp. Code T4A 2A 32VDC MAX.: II 3 G, EEx nL IIC T4 DEMKO 04 ATEX 0404974X 2A 32VDC MAX. Ta 70 °C  
Ind. Cont. Eq. for Hazardous Location Listed 87SL Class 1, Div. 2, Groups A,B,C,D Class 1, Zn 2, Group IIC  
Subject devices are to be installed in an ATEX Certified IP54 (as defined in IEC 60529) enclosure and accessible only by the use of a tool.

### Multi-Function Timing Relay Function and Time Range Settings - 700-FS Relays

Description		SPDT			DPDT
	Multi-function timing relays 700-FSM3U includes 10 setting functions:		Multi-Time Setting Range 0.05 s . . . 60 h		
(A) On-Delay					
(B) Off-Delay					
(C) On- and Off-Delay					
(D) One shot					
(E) Fleeting Off-Delay					
(F) Flasher (repeat cycle starts with pulse)			(1 s) 0.05 . . . 1 s (3 s) 0.15 . . . 3 s (10 s) 0.5 . . . 10 s (1 min) 0.05 . . . 1 min (3 min) 0.15 . . . 3 min (10 min) 0.5 . . . 10 min		
(I) On-Delay pulse generator			(1 hr) 0.05 . . . 1 hr		
(L) Pulse converter			(3 hr) 0.15 . . . 3 hr		
(On) ON-Function <sup>(1)</sup>			(10 hr) 0.5 . . . 10 hr		
(Off) OFF-Function <sup>(1)</sup>			(60 hr) 3 . . . 60 hr		
Note: Switch  is on DPDT relays only. When switch is down, one contact is instantaneous and one is timed. When switch is up, both contacts are timed.					

(1) For installation and maintenance.

### Accessories - 700-FS Relays

	Description	Pkg. Quantity	Cat. No.	
	<b>Setting Knob with Scale</b> (for time setting without tools)	10	700-FSK	
	<b>Panel Mounting Adapter</b> For surface mounting according to drilling plan EN 50 002	5	199-FSA	
	<b>Label Sheet</b> 105 self-adhesive paper labels each, 6 x 17 mm	10	100-FMS	
	<b>Marking Tag Sheet</b> 160 perforated paper labels each, 6 x 17 mm, to be used with a transparent cover	10	100-FMP	
	<b>Transparent Cover</b> To be used with marking tag sheets	100	100-FMC	
	<b>Marking Tag Adapters</b> To be used with marking tag: System 1492 W	100	(1)	100-FMA2

(1) Cat. No. 100-FMA2 is only a marking tag carrier. Please refer to the Terminal Block Accessories section, Marking Solutions of this publication for appropriate marker cards to be used with this carrier.

**IMPORTANT** Versatile Mounting: The 700-FS timing relay can be panel or DIN rail mounted. For best long-term performance, allow at least 5 mm (0.2 in.) of space on each side of the relay for proper ventilation.

## Function and Connection Diagrams - 700-FS Relays

### (A) On-Delay

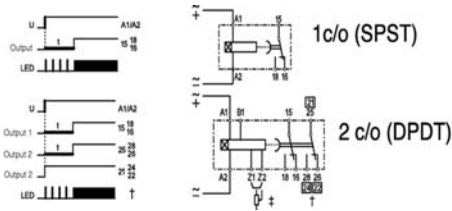

### (B) Off-Delay (Min. Pulse AC 50 ms...DC 30 ms)

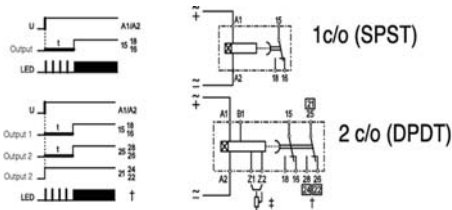

### (C) On- and Off-Delay

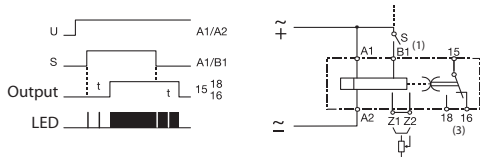

### (D) One Shot

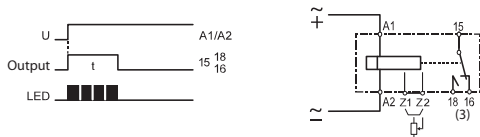

### (E) Fleeting Off-Delay (Min. Pulse AC 50 ms...DC 30 ms)

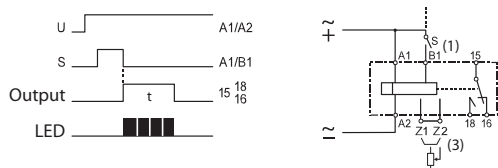

### (F) Flasher (Repeat Cycle Starts with Pulse)



### (G) Flasher (Repeat Cycle Starts with Pause)

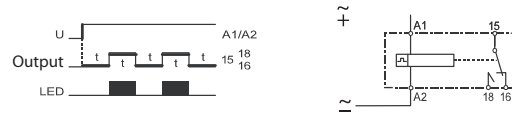

### (I) On-Delay Pulse Generator



### (J) On-Delay (Pulse Controlled)

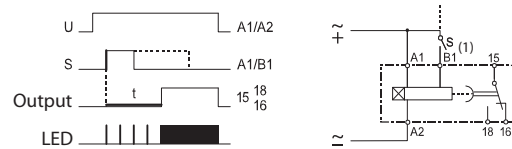

### (K) One Shot/Watch Dog (Pulse Controlled)

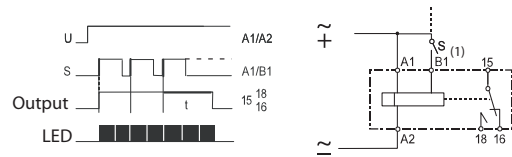

### (On) ON-Function (Off) OFF-Function

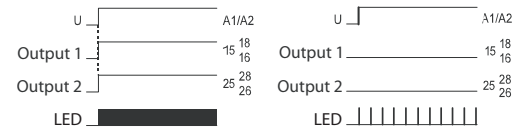

### (L) Pulse Converter (Min. Pulse AC 50 ms...DC 30 ms)

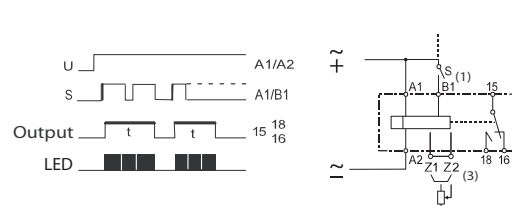

### Cleverly Designed Function Display light-emitting diode (Green)

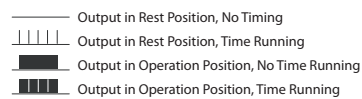

- (1) A voltage other than the supply voltage can be used at B1, but must be within voltages specified on timer.
- (2) Output 2 is selectable as instantaneous contact with sliding switch (⊗) on front panel (instantaneous when switch is down, timed when switch is up).
- (3) Available on multifunction "M," and single function "A" or "B" option timing relays along with code "4" (ZPDT contacts). Bridge or potentiometer 10 kΩ, 0.25 W min. (low voltage) for external time setting. Set timer dial to 0.0.

## Special Function Flasher Timing Relay

### Description

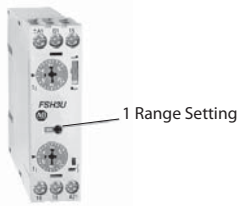

700-FSH3U

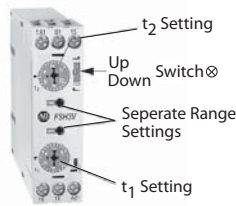

700-FSH3V

**Supply Voltages (A1/A2)**  
**Z12** 12V DC  
**U23** 24...48V DC, 24...240V AC, 50/60 Hz

### Function Diagram / Connection Diagram<sup>(1)</sup>

#### (H) Flasher (Repeat Cycle Starting with Pulse or Pause)

The repeat cycle timer permits different settings for on and off times. The following operating modes are possible:

- Oscillating mode; repeat cycle starts with voltage that is applied at A1 and B1, and continues to repeat until voltage is off.
- One cycle mode; started by energizing B1 with voltage on A1 and A2.
- Output starts with pulse or pause (switch ⊗ Up or Down).
- 700-FSH3U provides (1) range setting for  $t_1$  and  $t_2$   
 700-FSH3V provides (2) range settings for  $t_1$  and  $t_2$

**Supply Voltage Controlled, Oscillating Mode Starting with Pause**  
 — Switch ⊗ Is up

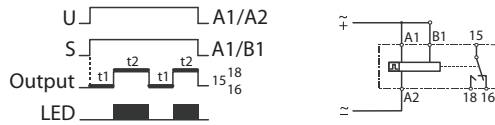

**Supply Voltage Controlled, Oscillating Mode Starting with Pulse**  
 — Switch ⊗ is Down

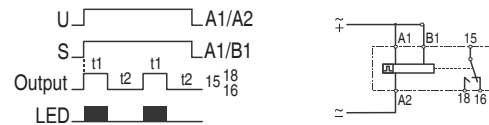

**Pulse Controlled, Output Starts With Pause (Min. Pulse AC 50 ms — DC 30 ms) — Switch ⊗ is Up One Cycle Mode**  
 — Voltage Supplied at A1 and A2, then Pulsing “s” to Energize B1 will Initiate One Cycle.

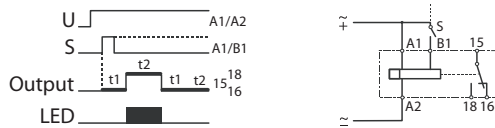

**Pulse Controlled, Output Starts with Pulse (Min. Pulse AC 50 ms — DC 30 ms) — Switch ⊗ is Down One Cycle Mode**  
 — Voltage Supplied at A1 and A2, then Pulsing “s” to Energize B1 will Initiate One Cycle.

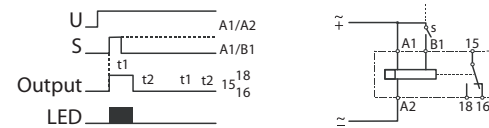

(1) If B1 is pulsed, a one full time cycle consisting of  $t_1$  and  $t_2$  is completed.

#### LED Operation Chart Green LED

- LED \_\_\_\_\_ Output at Shelf State, No Timing - LED OFF
- LED | | | | | Output at Shelf State, Time is Running - LED Flashing
- LED ██████████ Output NO Contact is Closed, No Timing - LED On
- LED ██████████ Output NO Contact is Closed, Time is Running - LED Long Flashing

**Function Diagram / Connection Diagram<sup>(1)</sup>**

**(Q) Off-Delay without Supply Voltage (True Off-Delay)**

- When input power is turned on, the output contact changes state. When the power is removed, the time delay begins. The output contact returns to shelf state at the end of the time delay.

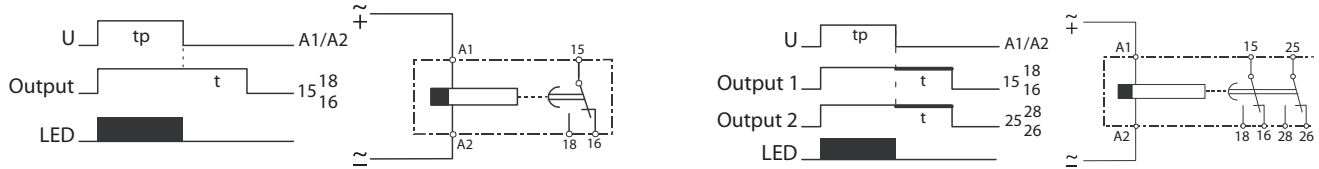

**(Y) Star-Delta Timing Relay**

- When power is applied, the output contact 17/18(Y) changes state. After the time setting, the output contact 17/18(Y) returns to shelf state. After the fixed time (50... 60 ms), the output contact 17/28Δ changes state. Both output contacts return to shelf state whenever the power is removed.

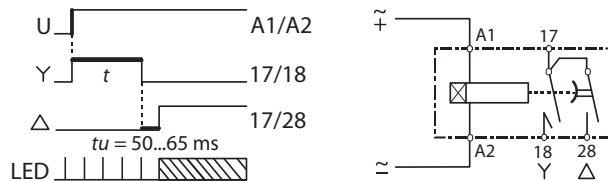

(1) Min. pulse (tp) required: 800 ms

**Specifications - 700-FS Relays<sup>(1)</sup>**

Attribute	Value
Setting Accuracy	±5% of full scale
Repeatability	±0.2% of the setting values
Tolerance	Voltage: ±0.001%/°ΔU Temperature: ±0.025%/°C

**Supply**

Attribute	Value
Supply Voltages	24...48V DC and 24...240V AC, 50/60 Hz (multi voltage)
Voltage Tolerance	-20...+20% (DC), -15...+10% (AC)
Power Consumption	0.5 W at 24V DC, 5 VA at 240V AC
Time Energized	100%
Reset Time	50 ms
Voltage Interruption	≥20 ms without reset (supply voltage)
Input Impedance	Relay ON: 3K-13K ohms, Relay OFF: 0.7K-4K ohms
Cable Length (Supply Voltage Control)	Max. 250 m (800 ft)

**Pulse Control (B1)**

Attribute	Value
Pulse Duration	≥50 ms (AC), ≥30 ms (DC)
Input Voltage	Supply voltage range

Input Current	1 mA
Max. Leakage Current	400 micro Amps
Cable Length	Max. 250 m (800 ft) without parallel load between B1 and A2, Max. 50m (160ft) with load (<3 kΩ) between B1 and A2

**Outputs**

Contact Type	Relay as changeover switch
Dielectric Coil to Contact	5000 V
Switching Capacity	Voltage: 440V AC
	Current $I_{th}$ (AC-1): 8 A (5 A for 700- FSQ)
	Power: 2000 VA
	According to IEC 947-5-1:
	3 A/440V AC (inductive load, AC 14)
	3 A/250V AC (inductive load, AC 15)
	1 A/24V DC (inductive load, DC 13)
Short-Circuit Resistance	According to UL 508:
	1.5 A/250V AC (B300)
	3 A/120V AC (B300)
Short-Circuit Resistance	10 A gL

(1) Time Characteristics (according to VDE 0435, Part 2021)

Life	Mechanical: 30 million operations
	Electrical operations:
	4 mil at 1 A/250V AC, cos φ = 1
	0.2 mil at 6 A/250V AC, cos φ = 1
	1.5 mil at 1 A/250V AC, cos φ = 0.3
	0.3 mil at 3 A/250V AC, cos φ = 0.3
	0.5 mil at 6 A/24V DC, resistive
	2 mil at 4 A/24V DC, resistive
	2 mil at 0.2 A/230V DC, resistive
	1 mil at 0.4 A/24V DC, L/R = 20 ms
	1 mil at 0.2 A/110V DC, L/R = 20 ms
	1 mil at 0.1 A/230V DC, L/R = 20 ms
State Indicator	1 LED, combination signal

**General Data- 700-FS Relays**

Insulation Characteristics	2 kVAC/50 Hz test voltage according to VDE 0435 and 6 kV 1.2/50 μs surge voltage according to IEC 947-1 between all inputs and outputs
EMC/Interference Immunity	Performance of following requirements: Surge capacity of the supply voltage according to IEC 1000-4-5: 4 kV 1.2/50 μs Burst according to IEC 1000-4-4: 6 kV 6/50 ns ESD discharge according to IEC 1000- 4-2: Contact 8 kV, air 8 kV Electromagnetic HF field according to IEC 801-3 and conducted electromagnetic HF signal according to IEC 801-6: Level 3
EMC/Emission	Electromagnetic fields according to EN 55 022: class B
Safe Isolation	According to VDE 106, part 101
Climatic Withstand	56 Cycles (24 hr) at 25...40 °C and 95% relative humidity according to IEC 68-2-30 and IEC 68-2-3
Vibration Resistance	4 g in three axes at 10...500 Hz, test FC according to IEC 68-2-6
Shock Resistance	50 g according to IEC 68-2-27
Protection Class	Enclosure: IP40 IP30 (Single-function) Terminal: IP 20 according to IEC 947-1
Weight	100 g
Approval	UL, C-UL
Ambient Temperature	Open: -25...+60 °C Enclosed: -25...+45 °C Storage: -40...+85 °C
Terminals	Screw terminal M3.5 for Number 2 Posidriv, Philips, and slotted screws. Suitable for power screwdriver. Rated tightening torque 8.8 lb.-in. (0.8 N-m, max. 1.2 N-m). Dual-chamber system for terminal cross-sections of 1 x 0.5 mm <sup>2</sup> ...2 x 2.5 mm <sup>2</sup> (solid) or stranded 2 x 2.5 mm <sup>2</sup> (flexible with sleeve), #20...14 AWG. Finger protection according to VDE 0106.
Mounting	Front mounting; For snap-on mounting on 35 mm DIN Rail or screw fixing by adapter and 2 screws (M4 type)
Disposal	Synthetic material without dioxin according to EC/EFTA notification Number 93/0141/D electrical contacts with cadmium
Certifications	cULus Listed (File No. E14840, Guide NKCR/NKCR7), CE Marked
Standards	EN/IEC 60947-1, EN/IEC 60947-5-1, UL 508, CSA 22.2 No. 14



Temp. Code T4A  
2A 32VDC MAX.

**Mounting:** Product shall be installed in an enclosure constructed in accordance with the requirements of EN50021.





## 700-HNC Miniature Timing Relay

- Miniature timer, perfect for converting 700-HC "Ice Cube" relays into timing relays
- 4 operating modes
- 4PDT contact output
- Timing range from 0.1 s...10 hr
- Socket mounted



Model	Timing Mode	Contact Output	Input Voltages	Timing Range	Socket Type	Cat. No.
 Cat. No. 700-HNC	On-Delay One Shot Repeat cycle, OFF-start Repeat cycle, ON-start	4PDT	12V DC	0.1 s...10 min	700-HN103 700-HN128	700-HNC44AZ12
				.1 min...10 hr		700-HNC44BZ12
			24V DC	0.1 s...10 min		700-HNC44AZ24
				0.1 min...10 hr		700-HNC44BZ24
			48V DC	0.1 s...10 min		700-HNC44AZ48
				0.1 min...10 hr		700-HNC44BZ48
			100...110V DC	0.1 s...10 min		700-HNC44AZ11
				0.1 min...10 hr		700-HNC44BZ11
			125V DC	0.1 s...10 min		700-HNC44AZ25
				0.1 min...10 hr		700-HNC44BZ25
			24V AC	0.1 s...10 min		700-HNC44AA24
				0.1 min...10 hr		700-HNC44BA24
			100...120V AC	0.1 s...10 min		700-HNC44AA12
				0.1 min...10 hr		700-HNC44BA12
200...230V AC	0.1 s...10 min	700-HNC44AA23				
	0.1 min...10 hr	700-HNC44BA23				

## Accessories - 700-HNC Relays

Photo	Description	Pkg. Quantity	Cat. No.
	<b>Screw Terminal Socket — Panel or DIN Rail Mounting. Guarded Terminal Construction</b> 14-Blade miniature socket for use with 700-HNC timers.	10	700-HN103
	<b>Screw Terminal Base Sockets — Panel or DIN Rail Mounting. Open Style Construction</b> 14-blade miniature socket for use with 700-HNC timers.	10	700-HN128
	<b>Screw Terminal Socket – Panel or DIN Rail Mounting. Guarded Terminal Construction</b> 14-blade miniature socket for use with 700-HNC timers. This socket has coil and contact separation.	10	700-HN104
	Retainer Clip for Cat. Nos. 700-HN103, -HN104 and -HN128 Sockets with 700-HNC Timers. Secures Timer in Socket.	10	700-HN263

## Specifications - 700-HNC Relays

Attribute		700-HNC	
Pilot Duty Rating		NEMA B300	
Pin type		Plug-in	
Operating voltage range		85%...110% of rated supply voltage (12V DC: 90%...110% of rated supply voltage) <sup>(1)</sup>	
Reset voltage		10% min. of rated supply voltage	
Power consumption	24VAC:	Relay ON: Relay OFF:	1.5 VA (1.1 W) (at 24V AC, 60 Hz) 0.2 VA (0.1 W) (at 24V AC, 60 Hz)
	100...120VAC:	Relay ON: Relay OFF:	1.5 VA (1.3 W) (at 120V AC, 60 Hz) 0.8 VA (0.5 W) (at 120V AC, 60 Hz)
	200...230VAC:	Relay ON: Relay OFF:	1.8 VA (1.5 W) (at 230V AC, 60 Hz) 1.2 VA (0.9 W) (at 230V AC, 60 Hz)
	12VDC:	Relay ON: Relay OFF:	0.9 W (at 12V DC) 0.07 W (at 12V DC)
	24VDC:	Relay ON: Relay OFF:	0.9 W (at 24V DC) 0.07 W (at 24V DC)
	48VDC:	Relay ON: Relay OFF:	1.0 W (at 48V DC) 0.2 W (at 48V DC)
	100...110VDC:	Relay ON: Relay OFF:	1.3 W (at 110V DC) 0.3 W (at 110V DC)
	125VDC:	Relay ON: Relay OFF:	1.3 W (at 125V DC) 0.3 W (at 125V DC)
Control outputs		4PDT: 5 A at 250V AC, resistive load (cos $\phi$ = 1)	
<b>Characteristics</b>			
Make ▶ ◀	120VAC	30 A	
	240VAC	15 A	
Break ◀ ▶	120VAC	3 A	
	240VAC	1.5 A	
Hp at 120V AC		1/6 Hp	
Hp at 240V AC		1/6 Hp	
Accuracy of operating time		$\pm 1\%$ FS max. (1 s range: $\pm 1\% \pm 10$ ms max.)	
Setting error		$\pm 10\% \pm 50$ ms FS max.	
Reset time		Min. power-opening time: 0.1 s max. (including halfway reset)	
Influence of voltage		$\pm 2\%$ FS max.	
Influence of temperature		$\pm 2\%$ FS max.	
Insulation resistance		100 m $\Omega$ min. (at 500V DC)	
Dielectric strength	2000V AC, 50/60 Hz for 1 min (between current-carrying terminals and exposed non-current-carrying metal parts) <sup>(2)</sup>		
	2000V AC, 50/60 Hz for 1 min (between operating power circuit and control output)		
	2000V AC, 50/60 Hz for 1 min (between different pole contacts; 2-pole model)		
	1500V AC, 50/60 Hz for 1 min (between different pole contacts; 4-pole model)		
	1000V AC, 50/60 Hz for 1 min (between non-continuous contacts)		
Vibration resistance		Malfunction: 10...55 Hz, 0.5 mm single amplitude	
Shock resistance		Malfunction: 100 m/s <sup>2</sup> (approx. 10G)	
Ambient temperature		Operating: -10 °C...50 °C (with no icing)	
		Storage: -25 °C...65 °C (with no icing)	



Attribute	700-HNC
Ambient humidity	Operating: 35% . . . 85%
Life expectancy	Mechanical: 10 000 000 operations min. (under no load at 1800 operations/hr)
	Electrical: 4PDT: 200 000 operations min. (3 A at 250V AC, resistive load at 1800 operations/hr)
Noise immunity	$\pm 1.5$ kV, square-wave noise by noise simulator (pulse width: 100 ns / 1 $\mu$ s, 1- ns rise)
Static immunity	Destruction: 8 kV Malfunction: 4 kV IP40
Enclosure rating	
Weight	Approx. 50 g
EMC	Emission Enclosure: EN55011 Group 1 class A
	Emission AC Mains: EN55011 Group 1 class A
	Immunity ESD: EN61000-4-2: 4 kV contact discharge (level 2) 8 kV air discharge (level 3)
	Immunity RF-interference: EN55014: 10 V/m (amplitude modulated, 80 MHz to 1 GHz) (level 3) 10 V/m (pulse modulated, 900 MHz)
	Immunity Conducted Disturbance: EN55014: 10 V (0.15 . . . 80 MHz) (level 3)
	Immunity Burst: EN61000-4-4: 2 kV power-line (level 3) 2 kV I/O signal-line (level 4)
Standards	UL 508, CSA 22.2 No. 14, EN/IEC 61812-1
Certifications	cURus Recognized (File No. E14843, Guide NRNT2/NRNT8), CSA Certified (File 224268), CE Marked, C- Tick Marked

(1) Single-phase, full-wave-rectified power supplies can be used.

(2) When using the 700-HNC continuously in any place where the ambient temperature is in a range of 45 °C . . . 50 °C, supply 90% . . . 110% of the rated supply voltages supply 95% . . . 110% with 12V DC type).

### General Timer Functions

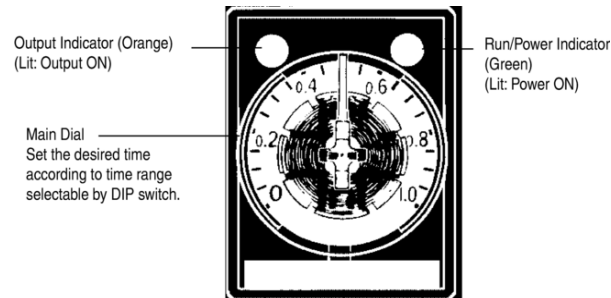

## Timing Charts - 700-HNC Relays

**IMPORTANT** t: Set time, Rt: Reset time

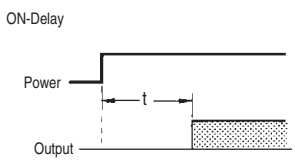
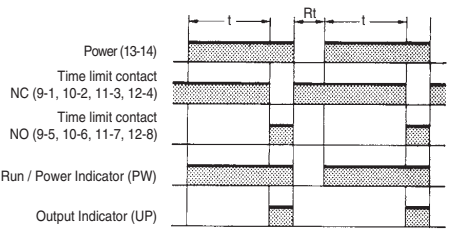
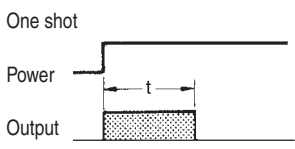
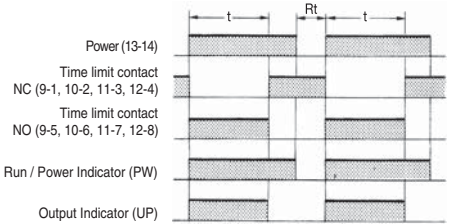
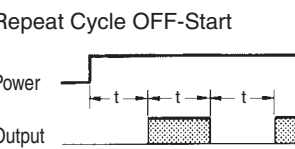
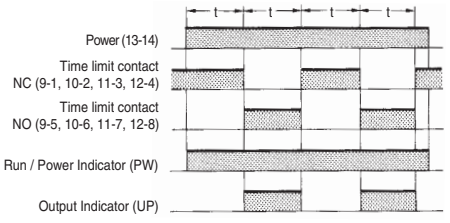
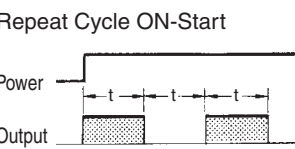
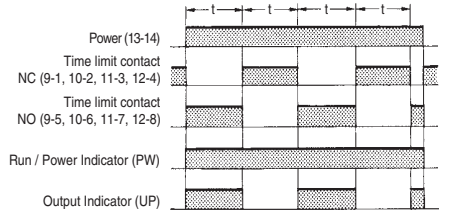
Operating Mode	Timing Charts / Wiring Diagram	
<p>ON-Delay</p> 		
<p>One shot</p> 		
<p>Repeat Cycle OFF-Start</p> 		
<p>Repeat Cycle ON-Start</p> 		

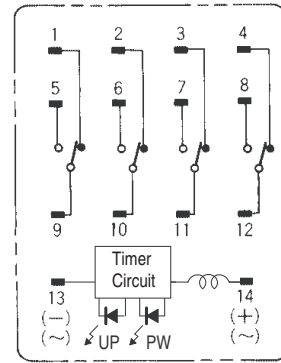

### General Timer Functions

### Pulse Operation

A pulse output for a certain period can be obtained with a random external input signal. Use the 700-HNC timing relay in interval mode as shown in the following timing charts.

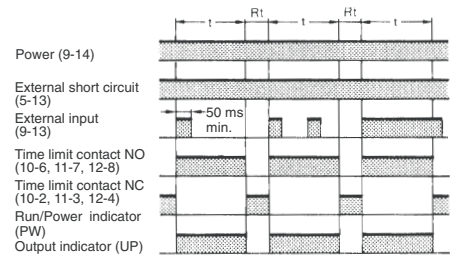
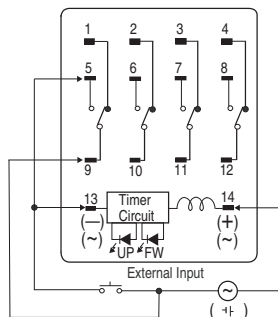
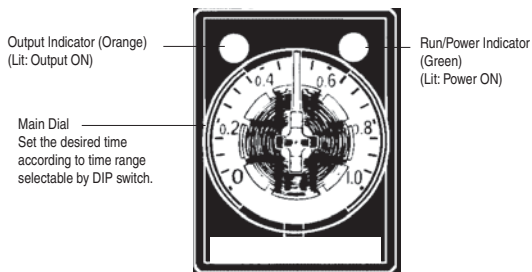

**Note:** t: Set time  
Rt: Reset time

### DIP Switch Settings - 700-HNC Relays

#### Time Ranges

Cat. No.	Time Range	Time Setting Range	Setting	Factory-Set
700-HNC44AZ12 700-HNC44AZ24 700-HNC44AZ48 700-HNC44AZ11	1 s	0.1 s...1 s		Yes
700-HNC44AZ25 700-HNC44AA24 700-HNC44AA12 700-HNC44AA23	10 s	1 s...10 s		No
700-HNC44BZ12 700-HNC44BZ24 700-HNC44BZ48 700-HNC44BZ11 700-HNC44BZ25 700-HNC44BA24 700-HNC44BA12 700-HNC44BA23	1 min	0.1 s...1 min		Yes
	10 min	1...10 min		No
	1 hr	0.1...1 hr		No
	1 hr	1...10 hr		No

**Note:** The top two DIP switch pins are used to select the time ranges.

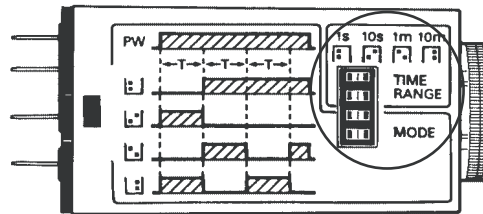

Operating Mode	Setting	Factory-set
ON-delay		Yes
One Shot		No
Repeat Cycle OFF-start		No
Repeat Cycle ON-start		No

**Note:** The top two DIP switch pins are used to select the time ranges.

### Dimensions - 700-HNC Relays

Approximate dimensions are shown in millimeters (inches). Dimensions are not intended for manufacturing purposes.

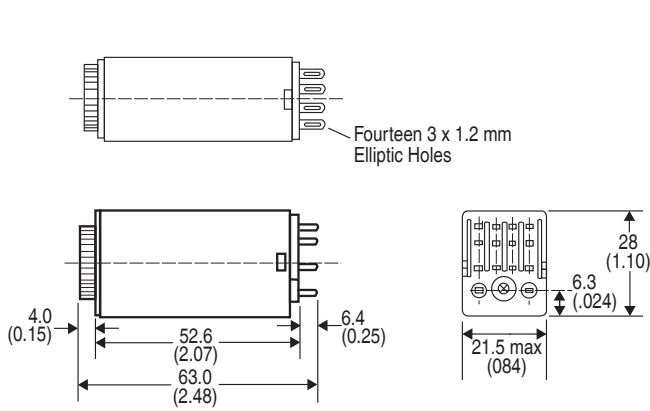

Cat. No. 700-HNC...

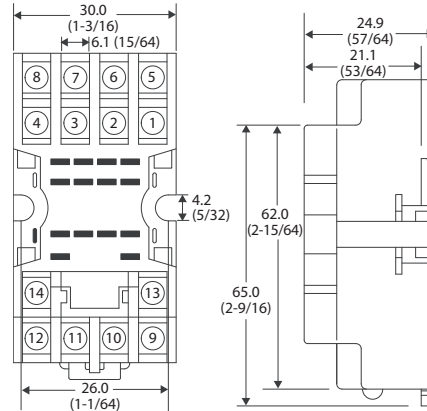

Cat. No. 700-HN128<sup>(1)</sup>  
 Wire Size: 2 x 1.5 mm<sup>2</sup> (#2-16 AWG...#1-20 AWG)  
 (Either Solid or Stranded)  
 Strip Length: 9 mm (3/8 in.) - Torque: 0.8 N·m (7 lb·in)

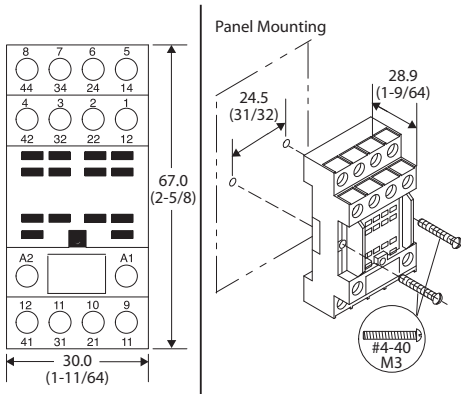

Cat. No. 700-HN103  
 Single wire: 0.2...2.5 mm<sup>2</sup> (#24 AWG...14 AWG)  
 Double wire: 2 x 0.2 mm<sup>2</sup>...2 x 1.5 mm<sup>2</sup> (2 x 24 AWG...2 x 16 AWG)  
 Wire type: solid or stranded, copper only  
 Strip length: 8 mm (5/16 in.), Torque: 0.5 N·m (4.4 lb·in)

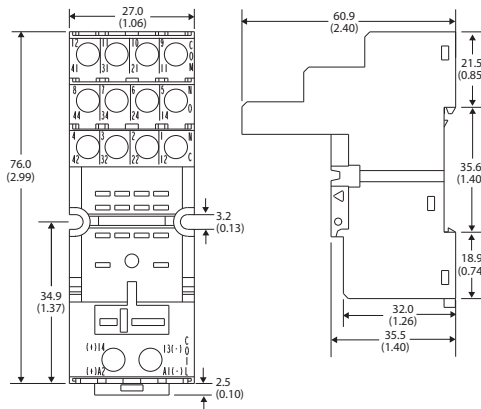

Cat. No. 700-HN104  
 Single Wire: 0.2...2.5 mm<sup>2</sup> (#24 AWG...14 AWG)  
 Double Wire: 2 x 0.2 mm<sup>2</sup>...2 x 2.5 mm<sup>2</sup> (2 x 24 AWG...2 x 14 AWG)  
 Wire Type: solid or stranded, copper only  
 Strip Length: 7 mm (9/32 in.), Torque: 0.5 N·m (4.4 lb·in)

(1) Total height of 700-HN128 + 700-HNC is 82.5 mm.

## 700-HNK Ultra-Slim Timing Relay

- The ultra-slim timing relay is the smallest relay available
- It is perfect for converting 700-HK relays into a timing relay
- SPDT and DPST-NO contact output
- Socket-mounted
- Timing range From 0.1 s...10 hr



Photo	Timing Mode	Socket Type	Contact Output	Timing Range	Input Voltage	Cat. No.
	On-Delay One Shot Repeat Cycle, OFF-start Repeat Cycle, ON-start	700-HN121	SPDT <sup>(1)</sup>	0.1 s...10 min	12V DC	700-HNK41AZ12
					24V DC	700-HNK41AZ24
					24V AC	700-HNK41AA24
				0.1 min...10 hr	12V DC	700-HNK41BZ12
					24V DC	700-HNK41BZ24
					24V AC	700-HNK41BA24
		700-HN122	DPST-NO <sup>(2)</sup>	0.1 s...10 min	12V DC	700-HNK42AZ12
					24V DC	700-HNK42AZ24
					24V AC	700-HNK42AA24
				0.1 min...10 hr	12V DC	700-HNK42BZ12
					24V DC	700-HNK42BZ24
					24V AC	700-HNK42BA24

(1) 5-blade terminal type only.

(2) 8-blade terminal type only.

## Accessories - 700-HNK Relays

Description	Pkg. Quantity	Cat. No.
<p><b>Screw Terminal Socket — Panel or DIN Rail Mounting</b> 5-blade miniature socket. For use with 1-pole type 700-HNK41 timers. Socket includes a retainer clip.</p>	10	700-HN121
<p><b>Screw Terminal Socket — Panel or DIN Rail Mounting</b> 8-blade miniature socket for use with 2-pole, 700-HNK42 timers. This socket includes a retainer clip.</p>	10	700-HN122

## Sockets and Retainer Clip Reference

Timer Type	Socket Cat. No.	Retainer Clip Cat. No.
700-HNK	700-HN121	Provided
	700-HN122	Provided

**Specifications - 700-HNK Relays**

Attribute		700-HNK
Pilot Duty Rating		NEMA B300
Rated Supply Voltage		24V AC; 12, 24V DC
Pin Type		Plug-in
Operating Mode		ON-delay, One Shot, Repeat Cycle OFF start, or Repeat Cycle ON start selectable with DIP switch.
Operating Voltage Range		85%...110% of rated supply voltage (12 VDC: 90%...110% of rated supply voltage) <sup>(1)</sup>
Power Consumption		24V AC:Relay ON:approx. 0.8 VA (at 24 VAC, 60 Hz) Relay OFF:0.5 VA (at 24V AC, 60 Hz) 12V DC:Relay ON:approx. 0.4 W (at 12V DC) Relay OFF:0.1 W (at 12V DC) 24V DC:Relay ON:approx. 0.5 W (at 24V DC) Relay OFF:0.2 W (at 24V DC)
Control Outputs		5 A at 250V AC, resistive load ( $\cos \phi = 1$ ) The minimum applicable load is 10 mA at 5 VDC (P reference value).
<b>Characteristics</b>		
Make ▶ I ◀	120V AC	30 A
	240V AC	15 A
Break ◀ I ▶	120V AC	3 A
	240V AC	1.5 A
Hp at 240V AC		1/6 Hp
Accuracy of Operating Time		±1% FS max. (1 s range: +1% ±10 ms max.)
Setting Error		±15% +50 ms FS max.
Reset Time		Min. power-opening time: 12, 24V DC: 0.1 s max. (including halfway reset) 24V AC: 0.5 s max. (including halfway reset)
Influence of Voltage		±2% FS max.
Influence of Temperature		±2% FS max.
Insulation Resistance		100 mΩ min.(at 500VDC)
Dielectric Strength		2000V AC, 50/60 Hz for 1 min (between operating circuit and control output, or contacts of different poles) 1000V AC, 50/60 Hz for 1 min (between non-continuous contacts)
Vibration Resistance		Malfunction: 10...55 Hz, 0.5 mm single amplitude
Shock Resistance		Malfunction: 100 m/s <sup>2</sup> (approx. 10G)
Ambient Temperature		Operating: -10 °C...50 °C (with no icing) Storage: -25 °C...65 °C (with no icing)
Ambient Humidity		Operating: 35...85%
Life Expectancy		Mechanical: 10 000 000 operations min. (under no load at 1800 operations/hr) Electrical: 100 000 operations min. (3 A at 250V AC, resistive load at 1800 operations/hr)
Impulse Withstand Voltage		Between power terminals: 1 kV
Noise Immunity		±1.5 kV, square-wave noise by noise simulator (pulse width: 100 ns/1 μs, 1-ns rise)
Static Immunity		Destruction: 8 kV Malfunction: 4 kV
Enclosure Rating		IP20
Weight		Approx. 18 g

Attribute	700-HNK
EMC	Emission Enclosure: EN55011 Group 1 class A Emission AC Mains: EN55011 Group 1 class A Immunity ESD: EN61000-4-2:4 kV contact discharge (level 2) 8 kV air discharge (level 3) Immunity RF-interference: ENV50140: 10 V/m (amplitude modulated, 80 MHz...1GHz) (level 3) 10 V/m (pulse modulated, 900 MHz) Immunity Conducted Disturbance: ENV50141:10 V (0.15...80 MHz) (level 3) Immunity Burst: EN61000-4-4:2 kV power-line (level 3) 2 kV I/O signal-line (level 4)
Standards	UL508, CSA C22.2 No. 14, EN/IEC 60947-5-1, EN/IEC 61812-1
Certifications	cURus Recognized Component (File No. E14843, Guide NRNTZ/NRNT8), CE Marked, C-Tick Marked

(1) When using 700-HNK timer in any place where the ambient temperature is more than 50 °C, supply 90...110% of the rated voltages (12V DC: 95...111% of the rated voltage).

**IMPORTANT** t: Set time, Rt:Reset time

### General Timer Functions

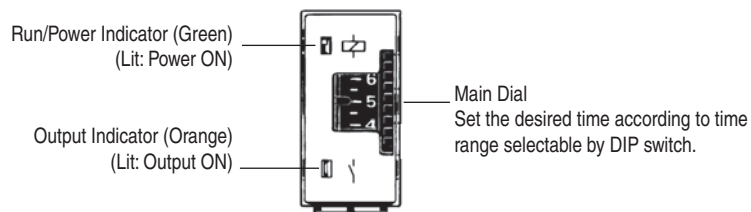

Operating Mode	Timing Charts / Wiring Diagram	
	700-HNK41...	700-HNK42...
<p>ON-Delay</p>	<p>Power (1-5)</p> <p>Time limit contact NC (4-2)</p> <p>Time limit contact NO (4-3)</p> <p>Run/ Power Indicator (PW)</p> <p>Output Indicator (OUT)</p>	<p>Power (1-8)</p> <p>Time limit contact NO 4-3, 5-6</p> <p>Run/Power indicator (PW)</p> <p>Output indicator (OUT)</p>
<p>One shot</p>	<p>Power (1-5)</p> <p>Time limit contact NC (4-2)</p> <p>Time limit contact NO (4-3)</p> <p>Run/ Power Indicator (PW)</p> <p>Output Indicator (OUT)</p>	<p>Power (1-8)</p> <p>Time limit contact NO (4-3, 5-6)</p> <p>Run/Power indicator (PW)</p> <p>Output indicator (OUT)</p>
<p>Repeat Cycle OFF-Start</p>	<p>Power (1-5)</p> <p>Time limit contact NC (4-2)</p> <p>Time limit contact NO (4-3)</p> <p>Run/ Power Indicator (PW)</p> <p>Output Indicator (OUT)</p>	<p>Power (1-8)</p> <p>Time limit contact NO (4-3, 5-6)</p> <p>Run/Power indicator (PW)</p> <p>Output indicator (OUT)</p>
<p>Repeat Cycle ON-Start</p>	<p>Power (1-5)</p> <p>Time limit contact NC (4-2)</p> <p>Time limit contact NO (4-3)</p> <p>Run/ Power Indicator (PW)</p> <p>Output Indicator (OUT)</p>	<p>Power (1-8)</p> <p>Time limit contact NO (4-3, 5-6)</p> <p>Run/Power indicator (PW)</p> <p>Output indicator (OUT)</p>



### Wiring- 700-HNK Relays

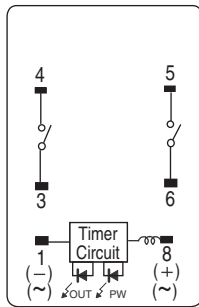

Cat. No. 700-HNK42...

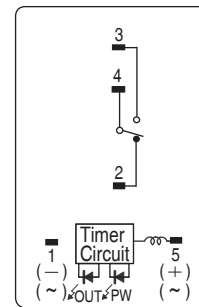

Cat. No. 700-HNK41...

A pulse output for a certain period can be obtained with a random external input signal. Use the 700-HNK in interval mode as shown in the following timing chart.

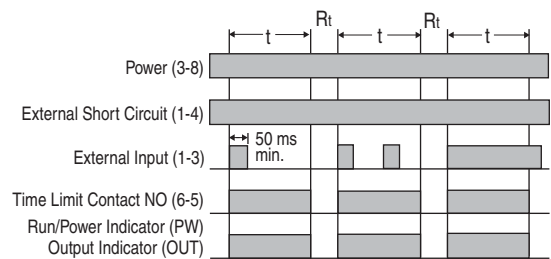
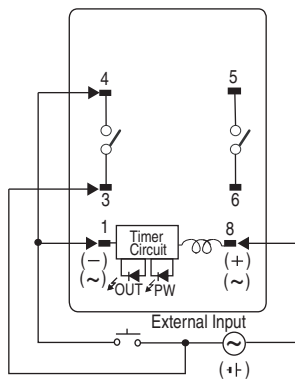

**Note:** Set time  
Rt: Reset time

Mode	Terminals
Pulse Operation	Power supply between 3 and 8 Short-circuit between 4 and 1 Input signal between 3 and 1
Operating mode; One shot and all other modes	Power supply between 1 and 8

### Time Ranges- 700-HNK Relays

Cat. No.	Time Range	Time Setting Range	Setting	Factory-Set
700-HNK41AZ12 700-HNK41AZ24 700-HNK41AA24 700-HNK42AZ12 700-HNK42AZ24 700-HNK42AA24	1 s	0.1...1 s		Yes
	10 s	1...10 s		No
	1 min	0.1 s...1 min		No
	10 min	1...10 min		No
700-HNK41BZ12 700-HNK41BZ24 700-HNK41BA24 700-HNK42BZ12 700-HNK42BZ24 700-HNK42BA24	1 min	0.1...1 min		Yes
	10 min	1...10 min		No
	1 hr	0.1...1 hr		No
	10 hr	1...10 hr		No

**Note:** The left two DIP switch pins are used to select the time ranges.

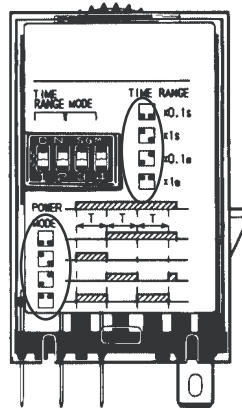

### Operating Modes - 700-HNK Relays

Operating Mode	Setting	Factory-set
On-delay		Yes
One Shot		No
Repeat Cycle Off-start		No
Repeat Cycle On-start		No

**Note:** The right two DIP switch pins are used to select the operating modes.

### Dimensions - 700-HNK Relays

Approximate dimensions are shown in millimeters (inches). Dimensions are not intended for manufacturing purposes.

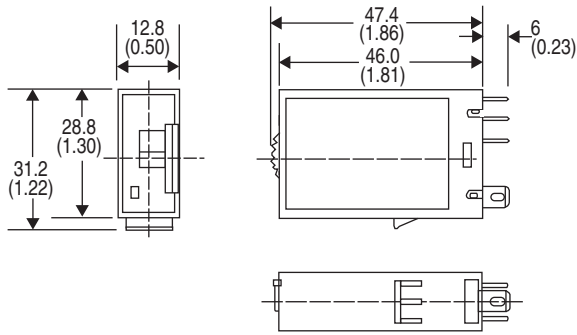

700-HNK41 SPDT Contact

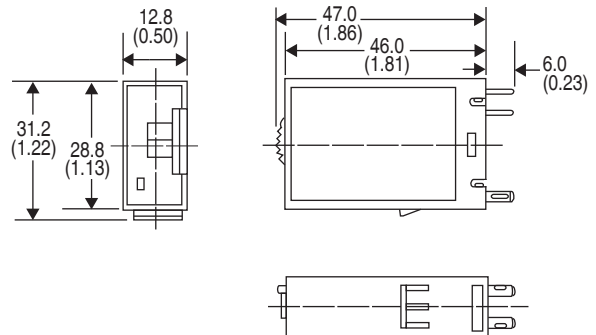

700-HNK42 DPST-NO Contact

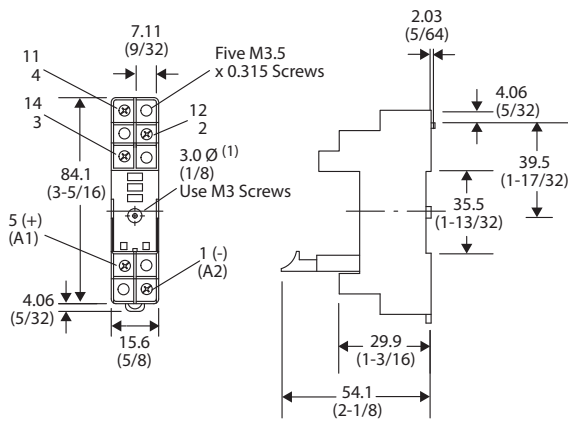

Cat No. 700-HN121  
 Wire Size: 2 x 2.5 mm<sup>2</sup>  
 Single Wire – Up to #12 AWG  
 Double Wire – 2 x 2.5 mm<sup>2</sup> (#2–14 AWG... #2–20 AWG)  
 (Either Solid or Stranded)  
 Strip Length: 9 mm (3/8 in.) – Torque: 0.8 N·m (7 lb·in)  
 Total height: 700-HN121 + 700-HNK41 is 78.0 mm.

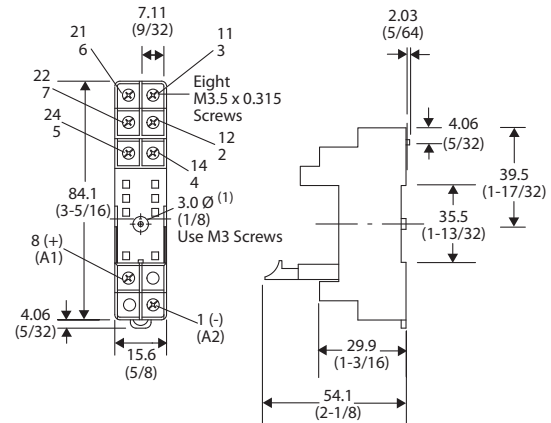

Cat No. 700-HN122  
 Wire Size: 2 x 2.5 mm<sup>2</sup>  
 Single Wire – Up to #12 AWG  
 Double Wire – 2 x 2.5 mm<sup>2</sup> (#2–14 AWG... #2–20 AWG)  
 (Either Solid or Stranded)  
 Strip Length: 9 mm (3/8 in.) – Torque: 0.8 N·m (7 lb·in)  
 Total height: 700-HN122 + 700-HNK42 is 78.0 mm.

(1) Holes required for mounting [3 mm (1/8 in.) diameter].

### 700-HR Dial Timing Relays

- Socket- or panel-mounted
- 5 A contact ratings or transistor outputs
- Single- or Multi-Function
- Timing range from 0.05 s...300 hr
- Multi-voltage inputs



### Multi-Function Timing Relays with Trigger and Reset Switch Options

- Socket or Panel Mounted
- Timing Range From 0.05 s...300 hr
- 11-pin base for socket cat. nos. 700-HN101, -HN126, -HN129
- Trigger: Power on or optional trigger signal
- Reset: Power off or optional reset signal

Timing Mode	Supply Voltage	Trigger Options	Reset Options	Outputs	Cat. No.
On-Delay (A) OFF-Delay (D) One Shot (E) Repeat cycle OFF-Start (B) Repeat Cycle ON-Start (B2) Signal ON/OFF-delay (C) Delayed One Shot (J) Signal ON/OFF - Delay (G)	24...48V AC 12...48V DC	1. Power On 2. Start Signal - contact closure (zero volts) - NPN transistor 3. Gate Signal (pause)	1. Power Off 2. Reset Signal - contact closure (zero volts) - NPN transistor	DPDT	700-HR52TU24
				Transistor	(1) 700-HRT6TTU24
	100...240V AC 100...125V DC	1. Power On 2. Start Signal - contact closure (voltage) - NPN transistor - PNP transistor	Power Off	DPDT	700-HRV52TU24
		1. Power On 2. Start Signal - contact closure (zero volts) 3. Gate Signal (pause)	1. Power Off 2. Reset Signal - contact closure (zero volts)	DPDT	700-HRS2TA17
		1. Power On 2. Start Signal - contact closure (voltage)	Power Off	DPDT	(1) 700-HRV52TA17

(1) Voltage input connection to high signal instead of 0V signal.

### Multi-Function Timing Relays with Power On Trigger

- Socket or Panel Mounted
- Timing Range From 0.05 s...300 hr
- 8-pin base for socket cat. nos. 700-HN100, -HN125, -HN108
- Trigger: Power on
- Reset: Power off

Timing Mode	Supply Voltage	Trigger Options	Reset Options	Outputs	Cat. No.
ON-Delay (A) One Shot (E) Repeat Cycle OFF-Start (B) Repeat Cycle ON-Start (B2) Delayed One Shot (J)	24...48V AC 12...48V DC	Power On	Power Off	DPDT	700-HRS42TU24
				Transistor	(1) 700-HRT4TTU24
	24...48V AC/DC	Power On	Power Off	SPDT Timed + Instantaneous Contact	(1) 700-HRP42TU24
				SPDT Timed + Instantaneous Contact	700-HRP42TA17
	100...240V AC 100...125V DC	Power On	Power Off	DPDT	700-HRS42TA17

(1) Voltage input connection to high signal instead of 0V signal.

## ON-Delay Timing Relays

- Socket or Panel Mounted
- Timing Range From 0.05 s...300 h
- 8-pin base for socket cat. nos. 700-HN100, -HN125, -HN108
- Trigger: Power on
- Reset: Power off

Timing Mode	Supply Voltage	Trigger Options	Reset Options	Outputs	Cat. No.
ON-Delay (A)	24...48V AC/DC	Power On	Power Off	SPDT Timed + Instantaneous Contact	700-HRC12TU24
	24...48V AC, 12...48V DC			DPDT	700-HRM12TU24
	100...240V AC	Power On	Power Off	DPDT	700-HRM12TA17
				SPDT Timed + Instantaneous Contact	700-HRC12TA17

### Timing Mode Description

A	D	E	B	B2	C	J	G
ON-Delay	OFF-Delay	One Shot	Repeat Cycle OFF-Start	Repeat Cycle ON-Start	Signal ON/OFF-Delay	Delayed One Shot	Signal ON/OFF-Delay

## 700-HRF Repeat Cycle Timing Relays

- Socket or Panel Mounted
- Independently adjustable on- and off-time
- 8-Pin base for socket cat. nos. 700-HN100, -HN125, and -HN108
- DPDT contact outputs
- Trigger: Power on
- Reset: Power off
- Hazardous location version available

<b>700</b>	-	<b>HRF</b>	<b>7</b>	<b>2</b>	<b>D</b>	<b>U26</b>
a		b	c	d	e	f

### Catalog Number Explanation

a Bulletin Number	-	b Type of Relay	c Function	d Contact Output	e Timing Range	f Supply Voltage
700		HRF—Repeat cycle with adjustable ON/OFF times	7—Repeat cycle with OFF start 8—Repeat cycle with ON start	2- DPDT	D—0.05 s...300 hr	U26 - 12...48V DC, 24...48V AC U27 - 100...125V DC, 100...240V AC

## 700-HRY Star-Delta Timing Relays

- 8-Pin base for socket cat. nos. 700-HN100, -HN125, and -HN108
- SPDT timed + instantaneous contact outputs
- Trigger: Power on
- Reset: Power off

<b>700</b>	-	<b>HRY</b>	<b>6</b>	<b>F</b>	<b>A12</b>
a		b	c	d	e

### Catalog Number Explanation

a Bulletin Number	-	b Type of Relay	c Function	d Timing Range	e Supply Voltage
700		HRY—YStar-Delta timer	6—SPDT timed + SPDT instant	F—Star: 0.5...120 s Delta: 0.05, 0.1, 1.25, 0.5, 0.75, 1.0 s	A12—100...120V AC, 50/60 Hz A22—200...240V AC, 50/60 Hz

### 700-HRQ True Off-Delay Timing Relays

- 11-Pin base for use with reset option — socket cat. nos. 700-HN101, -HN126, and -HN129
- 8-Pin base for use without reset option — socket cat. nos. 700-HN100, -HN125, and -HN108
- DPDT contact outputs
- Trigger: Power off
- Reset: optional reset signal

$\frac{700}{a} - \frac{HRQ}{b} \frac{N}{c} \frac{2}{d} \frac{G}{e} \frac{A12}{f}$

### Catalog Number Explanation

a Bulletin Number	b Type of Relay	c Function	d Contact Output	e Timing Range	f Supply Voltage
700	HRQ—True Off-Delay Timer	N—No reset option, 8-pin terminals R—Reset option, 11-pin terminals	2—DPDT	G—0.05...12 s H—0.05...12 min	A12—100...120V AC, 50/60 Hz A22—200...240V AC, 50/60 Hz U25—24V AC, 50/60 Hz; 24V DC Z48—48V DC Z11—100...125V DC

### Accessories - 700-HR Relays











Photo	Description	Pkg. Qty.	Cat. No.
	<b>Screw Terminal Tube Base Socket — Panel or DIN Rail Mounting; Guarded Terminal Construction.</b> 8-Pin for use with 700-HR and -HX timing relays.	10	700-HN100
	<b>Screw Terminal Tube Base Socket — Panel or DIN Rail Mounting; Open Style Construction.</b> 8-Pin for use with 700-HR and -HX timing relays. No retainer clip required.	10	700-HN125
	<b>Screw Terminal Tube Base Sockets — Panel or DIN Rail Mounting; Guarded Terminal Construction.</b> 11-pin for use with 3PDT 700-HA relays.	10	700-HN101
	<b>Screw Terminal Tube Base Sockets — Panel or DIN Rail Mounting; Open Style Terminal Construction.</b> 11-pin for use with 3PDT 700-HA relays. No retainer clip required.	10	700-HN126
	<b>DIN (#3) symmetrical hat rail</b> 35 x 7.5 x 1 m	10	199-DR1

Photo	Description	Pkg. Qty.	Cat. No.
	<b>Specialty Socket</b> 8-pin backwired socket with solder terminals for use with 700-HR timing relays. Order 10 or multiples of 10.	10	700-HN108
	<b>Specialty Socket</b> 11-pin back-wired socket with solder terminals for use with 700-HR timing relays.	10	700-HN129
	<b>Frame Adapter</b> For flush or door mounting of all 700-HR and -HX timers.	1	700-HN130
	<b>Retainer Clip for Cat. Nos. 700-HN100 and -HN101 Sockets with all 700-HR Timing Relays</b> Secures timer in socket.  <b>Note:</b> Not required for installation	10	700-HN131
	<b>Protective Cover</b> Helps prevent tampering of timing and mode settings. Provides a degree of protection against water and dirt from entering the front of the relay. For use with all 700-HRs and -HX timing relays.	1	700-HN132
	<b>Pre-Printed Identification Tags</b> — contains 10 sheets of pre-printed and blank tags. Each sheet contains 13 sets of the markings CR. . .9CR, TR. . .9TR, M. . .9M, F, R, 1S, and 117 blank tags. Tags are peel-off with sticky backing for easy placement on relays.	10	700-N40
	<b>Blank Identification Tags</b> — contains 10 sheets of blank identification tags for customer specialized printing. Each sheet contains 546 blank tags. Tags are peel-off with sticky backing for easy placement on relays.	10	700-N41

Timer Type	Socket Cat. No.	Retainer Clip Cat. No.
700-HR52, -HRT6, -HRV, -HRQR	(1) 700-HN101	700-HN131
	700-HN126	Not Required <sup>(3)</sup>
	700-HN129	Not Applicable
700-HRS, -HRT4, -HRP, -HRC, -HRM, -HRF, -HRY, -HRQN	(2) 700-HN100	700-HN131(See note above)
	700-HN108	Not Applicable
	700-HN125	Not Required <sup>(3)</sup>

(1) 11 pins.

(2) 8+ pins.

(3) Design of these sockets holds the timing relays securely and does not require retainer clips.

## Specifications - 700-HR Relays

	700-HR, 700-HRS, 700-HRV	700-HRP	700-HRC	700-HRM	700-HRF	700-HRY	700-HRQ	700-HRT (Transistor Outputs)
<b>Electrical Ratings</b>								
Pilot Duty Rating	NEMA B300							—
Thermal Current ( $I_{th}$ )	5 A							100 mA @ 30V DC max.
Make ▶ ◀	120V AC	30 A					—	
	240V AC	15 A					—	
Break ◀ ▶	120V AC	3 A					—	
	240V AC	1.5 A					—	
Hp at 120V	1/6 Hp (0.12 kW)	1/4 Hp (0.18 kW)	1/6 Hp (0.12 kW)		1/4 Hp (0.18 kW)	1/6 Hp (0.12 kW)	—	
Hp at 240V	1/3 Hp (0.25 kW)							—
Resistive Load	5 A at 250V AC/30V DC							
Inductive Load	AC-15 @ 250V AC, 3 A/DC-13 @ 30V DC, 0.5 A							
Accuracy of Operating Time	±0.2% FS max. (±0.2% ±10 ms max. in a range of 1.2 s)							
Setting Error	±5 % FS ±50 ms (The value is ±5% FS +100 ms to -0 ms max. when the C or D mode signal of the 700-HRVs are OFF.)							
Influence of Voltage	±0.2% FS max. (±0.2% ±10 ms max. in a range of 1.2 s)							
Influence of Temperature	±1% FS max. (±1% ±10 ms max. in a range of 1.2 s)							
Permissible Leakage Current	—							
Power Consumption	-HRS2,-HRS	-HRV	-HRP,-HRC	-HRM	-HRF	-HRY	-HRQ	-HRT
240V AC, Output ON	2.1 VA	2.5 VA	2.0 VA	2.1 VA	10 VA	12 VA	0.4 VA	—
240V AC, Output OFF	1.3 VA	1.8 VA	2.0 VA	1.3 VA	10 VA	12 VA	0.4 VA	—
24V DC, Output ON	0.8 W	0.9 W	0.9 W	0.8 W	1.0 W	—	0.2 W	0.3 W
24V DC, Output OFF	0.2 W	0.3 W	0.9 W	0.2 W	1.0 W	—	0.2 W	0.2 W
<b>Design Specifications</b>								
Dielectric Strength	2000V AC (1000V AC for 700-HRT), 50/60 Hz for 1 min (contact to frame) 2000V AC (1000V AC for 700-HRT), 50/60 Hz for 1 min (between control output terminals and operating circuit) 2000V AC, 50/60 Hz for 1 min (pole-to-pole) 1000V AC, 50/60 Hz for 1 min (between contacts not located next to each other) 2000V AC, 50/60 Hz for 1 min (contact to coil)							
<b>Mechanical</b>								
Vibration Resistance	Malfunction: 10...55 Hz with 0.5 mm double amplitude each in three directions for ten minutes each							
Shock Resistance	Malfunction: 100 m/s <sup>2</sup> (10 G)				98 m/s <sup>2</sup> (10 G)	294 m/s <sup>2</sup> (10 G)	98 m/s <sup>2</sup> (10 G)	100 m/s <sup>2</sup> (10 G)
<b>Environmental</b>								
Noise Immunity	±1.5 kV for ±600V DC				±400V for 12V DC		±1kV for 48V DC	±1.5 kV for ±600V DC
Static Immunity	Malfunction: 8 kV							
Ambient Temperature	Operating: -10...+55 °C ( 14...131 °F) with no icing Storage: -25...+65 °C ( 13...149 °F) with no icing							
Ambient Humidity	Operating: 35...85 %							
<b>Construction</b>								
Life Expectancy (Min. Operations)	Mechanical: 20 000 000. (under no load at 1800 operations/h) Electrical: 100 000 (5 A at 250V AC, resistive load at 1800 operations/h)						Mech: 10 <sup>7</sup> Electrical: 10 <sup>4</sup>	



	700-HR, 700-HRS, 700-HRV	700-HRP	700-HRC	700-HRM	700-HRF	700-HRY	700-HRQ	700-HRT (Transistor Outputs)
EMC	(EMI) EN50081-2 Emission Enclosure: EN55011 Group 1 class A Emission AC Mains: EN55011 Group 1 class A (EMS) EN50082-2 Immunity ESD: EN61000-4-2: 4 kV contact discharge (level 2); 8 kV air discharge (level 3) Immunity RF-interference from AM Radio Waves: ENV50140: 10 V/m (80 MHz...1 GHz) (level 3) Immunity RF-interference from Pulse-modulated Radio Waves: ENV50204: 10 V/m (900 ±5 MHz) (level 3) Immunity Conducted Disturbance: ENV50141: 10V (0.15...80 MHz) (level 3) Immunity Burst: EN61000-4-4: 2 kV power-line (level 3) Immunity Surge: EN61000-4-52 kV I/O signal-line (level 4) 1 kV line to line; 2 kV line to ground (level 3)							
Degree of Protection	IP40 (panel surface)							
Weight	Approx. 90 g							
Certifications	CSA Certified (File No. 70751), UL Recognized (File No. E14843 Guide No. NRNT2), CE Marked, C-Tick Marked							
Standards	UL 508, CSA C22.2 No. 14, EN 61812-1, EN 61000-6-2, -6-4							

## Timer Functions - 700-HR Relays

### 700-HR Multifunction Timer

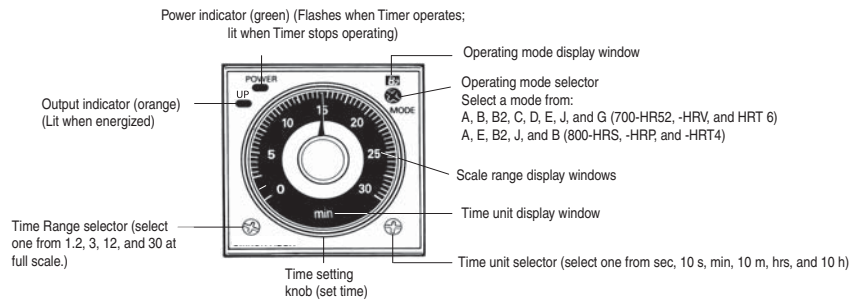

### 700-HRC -HRM On-Delay Timer

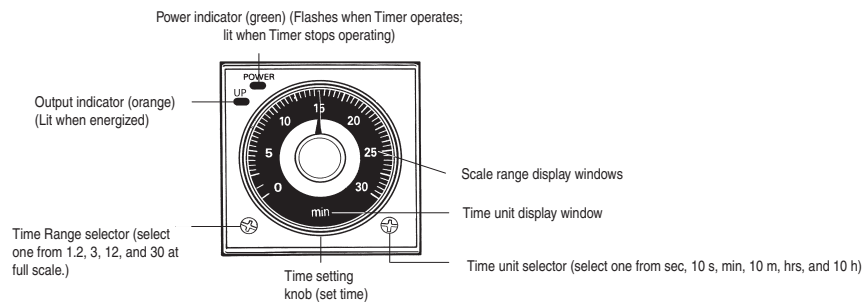

### 700-HRF Twin Timer

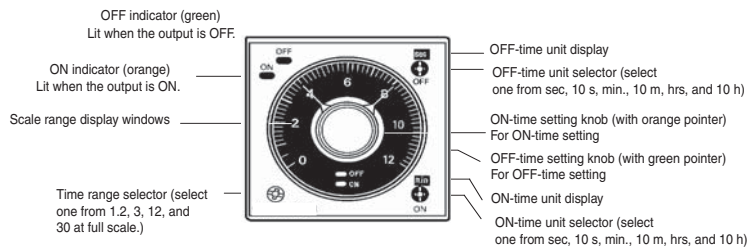

### 700-HRY Star-Delta Timer

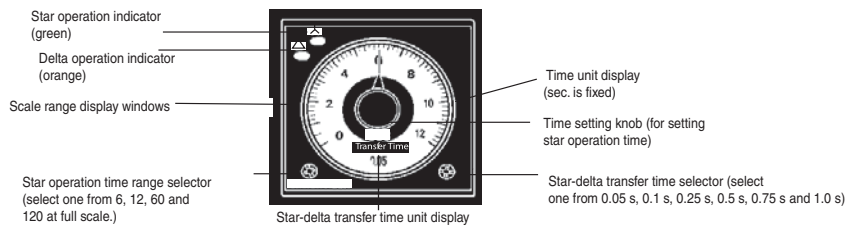

### 700-HRQ True Off-Delay Timer

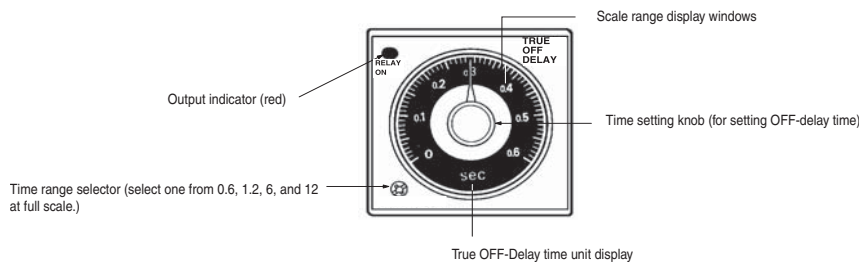

**Specifications for Start, Gate, Reset Signal (Cat. Nos. 700-HR52, -HRT6, -HRV, -HRQR)**

Start, Reset, and Gate signals are typically contact closures or signals from a solid-state sensor.

**(R) Reset Signal**

The reset signal is not required for normal operation. Reset can be accomplished by removing power from the timing relay. To reset the timer without removing power, a signal must be applied which resets the timing cycle and returns the output contacts to their shelf state. The reset signal will override both the start signal and gate signal. The reset signal can be either momentary or maintained.

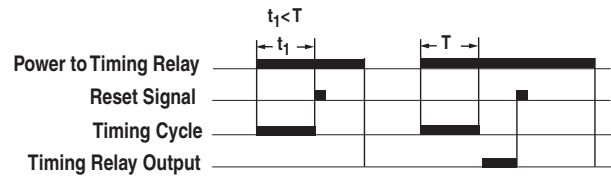

**(G) Gate Signal**

The gate signal is not required for normal operation. The gate signal provides a pause or retentive timing function. When the gate signal is applied the timing cycle is momentarily interrupted. When the signal is removed, the timing cycle resumes timing at the point the cycle was interrupted and will continue timing until the time delay is completed or the gate signal is re-applied.

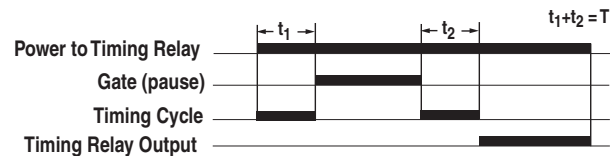

**Contact Signal — Cat. Nos. 700-HR52, -HRT6, -HRQR**

Contact closure provides signal to timer. A low energy signal is generated by the 700-HR timing relay. For optimum reliability, use contacts designed for low energy switching (5V, 1 mA) (Bul. 800F-X V, 800T-X V). No external voltage should be connected to the contact signal.

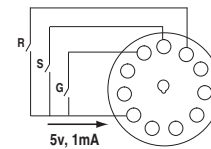

**Contact Signal — Cat. No. 700-HRV**

For use in applications where it is not possible to use contacts designed for low energy switching. Contact closure provides signal to timer. A signal is generated by the 700-HR timing relay, and is the same potential as the supply voltage of the timing relay. No external voltage should be connected to contact signal. 700-HRV52TU24 supply voltage: 24...48V AC, 12...48V DC / 700-HRV52TA17 supply voltage: 100...240V AC, 100...125V DC.

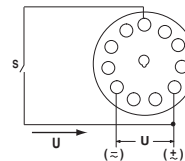

**Solid-State Signal — Cat. Nos. 700-HR52, -HRT6**

Timing relay is suitable for use with a 3-wire NPN 12...24V DC sensor. Supply voltage potential of sensor must be the same as the supply voltage potential of the timing relay. Permissible off-state leakage current from sensor: 0.01 mA max.

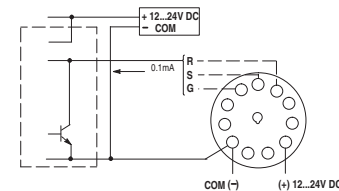

**Solid-State Signal — Cat. No. 700-HRV**

Timing relay is suitable for use with a 3-wire NPN or PNP 12...24V DC sensor. Supply voltage potential of sensor must be the same as the supply voltage potential of the timing relay. Permissible off-state leakage current from sensor: 0.01 mA max.

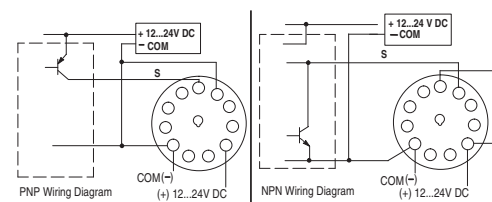

**Signal Specifications**

Circuit Impedance	Circuit impedance can be used to calculate the maximum wiring distance from the signal switch to the timing relay, for example. Permissible signal-ON impedance: 1 kΩ max. Permissible signal-OFF impedance: 100 kΩ min.				
Power-OFF Reset	Min. power-off time: 0.1 s, Reset Voltage: 10% max. of rated voltage				
Signal Duration	Min. pulse width: 0.05 s				
Signal Options		<b>700-HR52</b>	<b>700-HRT6</b>	<b>700-HRV5</b>	<b>700-HRQR</b>
	Start	X	X	X	NA
	Reset	X	X	NA	X
	Gate	X	X	NA	NA

## Timing Charts - 700-HR Relays

### Mode A — ON-Delay

- Needs continuous input power applied.
- Timing is initiated by the leading edge of the start signal.
- Contacts change state after timing is complete.
- Additional start signals during timing don't reset timing or contacts.
- When the input power is removed contacts return to shelf state.

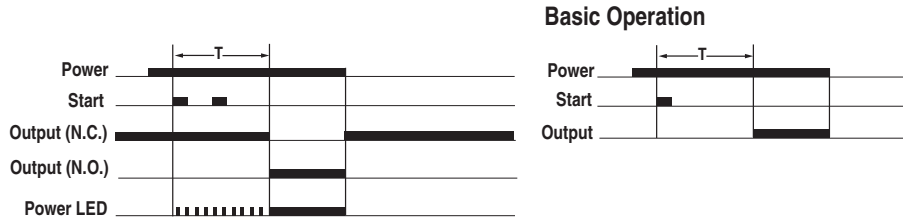

### Mode B — Repeat Cycle, Off Start

- Need continuous input power applied.
- Timing is initiated by the leading edge of the start signal. Additional start signals during timing do not reset timing or contacts.
- For the first time period the contacts remain in their shelf state. When that time period is complete contacts change state for the same time period (time on = time off).
- This cycle repeats itself until input power is removed or reset signal is applied. When the input power is removed or reset signal is applied contacts return to the shelf state.

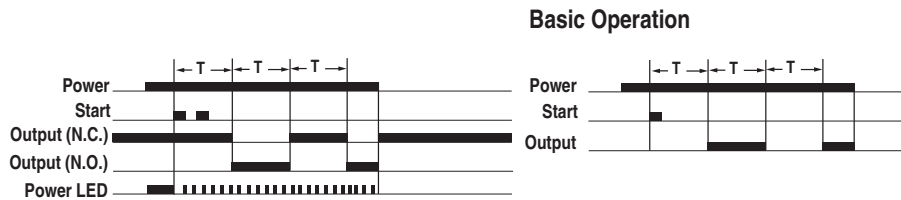

### Mode B2 — Repeat Cycle On start

- Need continuous input power applied.
- Timing is initiated by the leading edge of the start signal. Additional start signals during timing do not reset timing or contacts.
- For the first time period the contacts change state. When that time period is complete contacts return to the shelf state for the same time period (time on = time off).
- This cycle repeats itself until input power is removed or reset signal is applied. When the input power is removed or reset signal is applied contacts return to the shelf state.

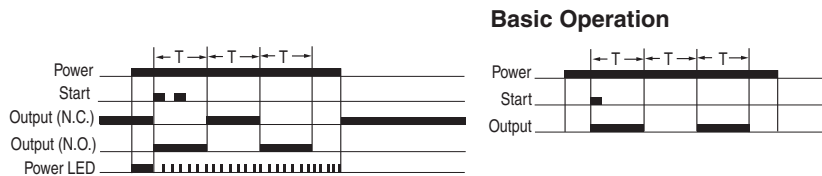

### Mode C — Watchdog monitor (Trigger = Signal On/Off)

- Need continuous input power applied.
- Contacts change state immediately when start signal is applied or when start signal is removed (only if timing cycle was complete).
- Timing is initiated at the leading edge of the start signal. After the first timing cycle is complete, timing is initiated by the trailing edge of the start signal.
- At the end of the time period contacts return to the shelf state.
- Relay timing is reset when additional start signals are applied while the relay is timing. Contacts remain in energized state.
- When the input power is removed contacts return to the shelf state.

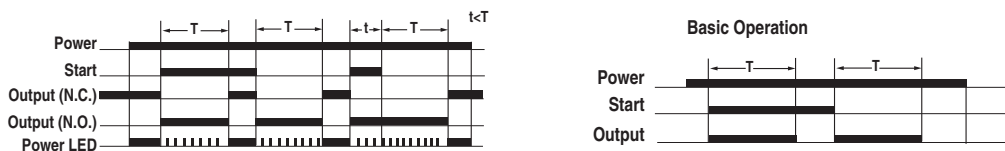

**Mode D — Off-Delay (Trigger = Signal Off)**

- a. Need continuous input power applied.
- b. Contacts change state immediately when start signal is applied.
- c. Timing is initiated by the trailing edge of the start signal.
- d. At the end of the time period contacts return to the shelf state.
- e. Relay timing is reset when additional start signals are applied while the relay is timing. Contacts remain in energized state.
- f. When the input power is removed contacts return to the shelf state.

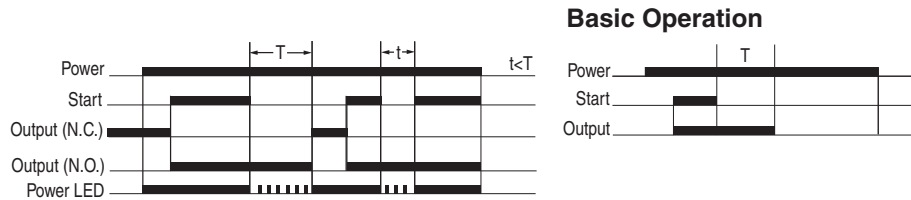

**Mode E — One-Shot (Trigger = Signal On) 700-HR52, -HRV, and -HRT6**

- a. Need continuous input power applied.
- b. Timing is initiated by the leading edge of the start signal.
- c. Contacts change state immediately when start signal is applied.
- d. At the end of the time period contacts return to the shelf state.
- e. Relay timing is reset when additional start signals are applied while the relay is timing. Contacts remain in energized state.
- f. When the input power is removed contacts return to shelf state.

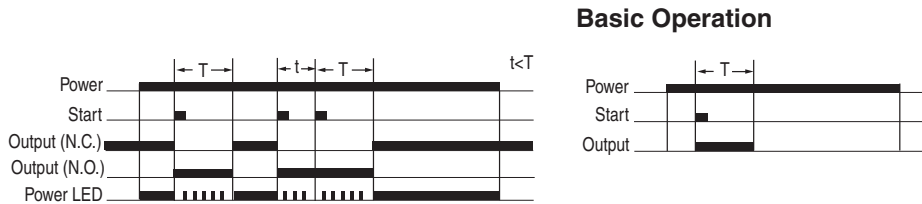

**Mode E — One-Shot (Trigger = Power On) 700-HRS, -HRP, and -HRT4**

- a. Need continuous input power applied.
- b. Timing is initiated when the input power is applied.
- c. At the end of the time period contacts return to the shelf state.
- d. Relay timing is reset when input power is removed.

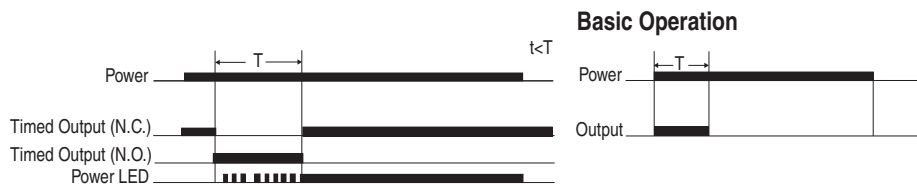

**Mode G — Watchdog Monitor (Trigger=Signal ON/OFF)**

- a. Need continuous input power applied.
- b. Timing is initiated by the landing edge of the start signal.
- c. After the first timing cycle is complete the contacts change state and timing is initiated by the trailing edge of the start signal.
- d. At the end of the time period the contacts return to the shelf state.
- e. Relay timing is reset when additional start signals are applied while the relay is timing.
- f. When the power is removed contacts return to the shelf state.

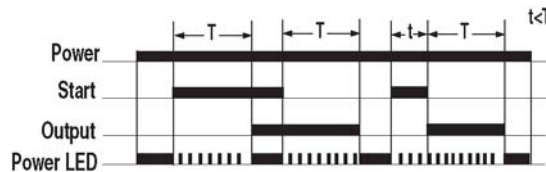

**Mode J — Delayed One-Shot (Trigger = Power On)**

- a. Need continuous input power applied.
- b. No start signal applied.
- c. Timing is initiated when input power is applied.
- d. Contacts change state after the timing for a fixed time of 1s +/-0.5s
- e. At the end of the 1 sec period the contacts return to the shelf state.
- f. When the input power is removed contacts return to the shelf state.

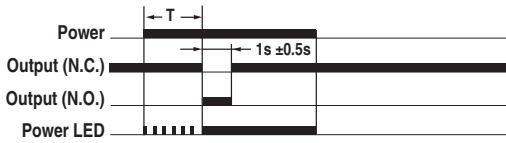

**Basic Operation**

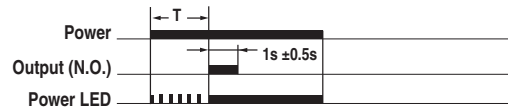

**Mode Star-Delta**

- a. Need continuous input power applied.
- b. No start signal required. Timing is initiated when input power is applied.
- c. Star output contact changes state when input power is applied.
- d. After timing is complete star output contact returns to the shelf state then both the star & delta contacts remain in shelf states until transfer time setting is complete.
- e. Delta output contact changes state after transfer time is complete.
- f. Instantaneous contact changes state when input power is applied.
- g. All contacts return to the shelf state when input power is removed.

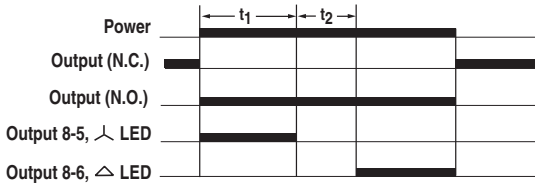

**Basic Operation**

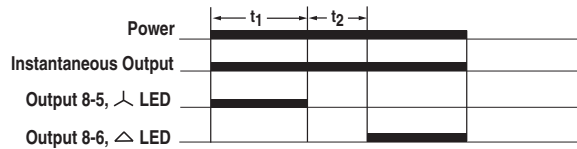

**Mode True Off-Delay (Trigger = Power Off)**

- a. Continuous input power is NOT required.
- b. No start signal applied.
- c. Contacts change state immediately when input power is applied.
- d. Timing starts when input power is removed.
- e. At the end of the time period contacts return to the shelf state.
- f. Relay timing is reset when input power is reapplied while the relay is timing. Contacts remain in energized state.

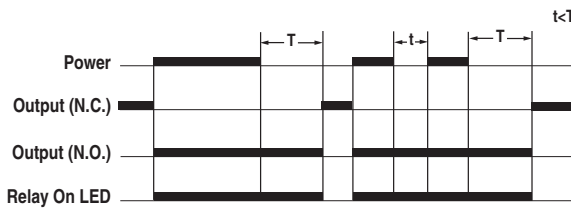

**Basic Operation**

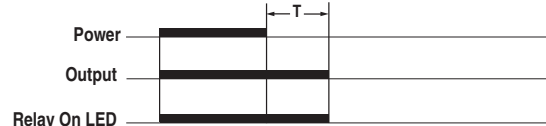

### Dimensions - 700-HR Relays

Approximate dimensions are shown in millimeters (inches). Dimensions are not intended for manufacturing purposes.

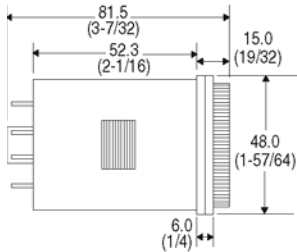

Cat. No. 700-HR, -HRM, -HRC, -HRF, -HRS, HRV, HRP  
Timing Relays

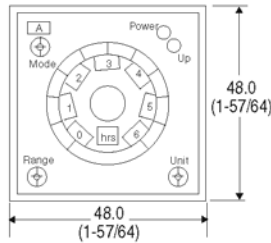

Cat. No. 700-HR, -HRM, -HRC, -HRF, -HRS, -HRV, -HRP, -HRY, -HRQ Timing Relays

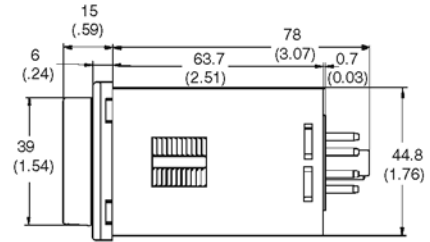

Cat. No. 700-HRY, -HRQ Timing Relays

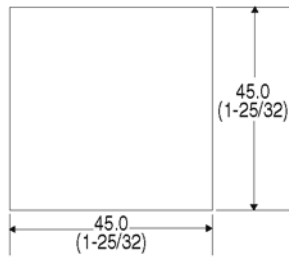

Cat. No. 700-HR...  
Panel Cutout

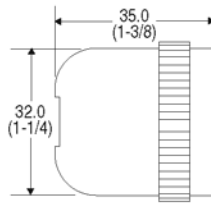

Cat. No. 700-HN129 — 11-pin  
Cat. No. 700-HN108 — 8-pin socket

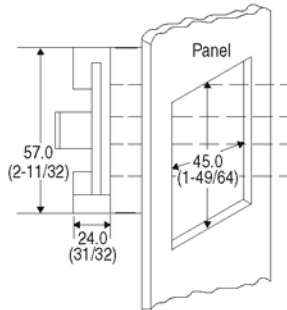

Cat. No. 700-HN130  
Retainer

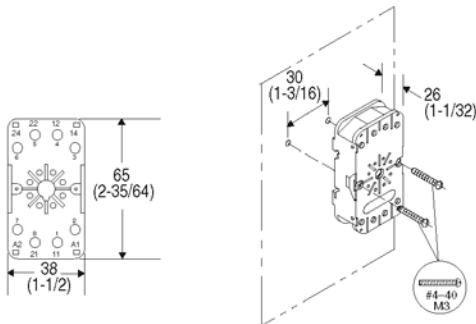

Cat. No. 700-HN100  
Wire Size: 2x2.5 mm  
Single Wire — Up to #12 AWG  
Double Wire — 2x2.5 mm (#2-14 AWG...#2-20 AWG)  
(Either Solid or Stranded)  
Strip length: 9 mm (3/8 in) — Torque: 0.8 N•m (7 lb•in)

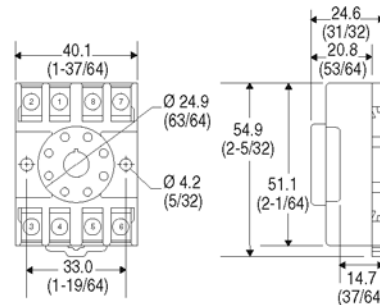

Cat. No. 700-HN125  
Wire Size: 2x2.5 mm  
Single Wire — Up to #12 AWG  
Double Wire — 2x2.5 mm (#2-14...#2-20 AWG)  
(Either Solid or Stranded)  
Strip Length: 9 mm (3/8 in) — Torque: 0.8 N•m (7 lb•in)

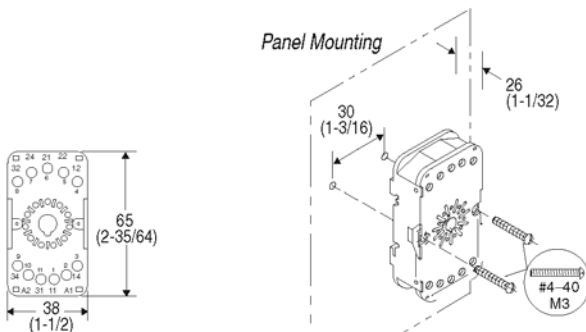

Cat. No. 700-HN101  
Wire Size: 2x2.5 mm  
Single Wire — Up to #12 AWG  
Double Wire — 2x2.5 mm (#2-14 AWG...#2-20 AWG)  
(Either Solid or Stranded)  
Strip Length: 9 mm (3/8 in.) — Torque: 0.8 N•m (7 lb•in.)

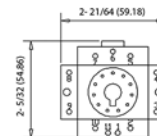

Cat. No. 700-HN126  
Wire Size: 2x2.5 mm  
Single Wire — Up to #12 AWG  
Double Wire — 2x2.5 mm (#2-14...#2-20 AWG)  
(Either Solid or Stranded)  
Strip Length: 9 mm (3/8 in) — Torque: 0.8 N•m (7 lb•in)

### 700-HT Plug-in Timing Relay

- Timing Relay (On-Delay or Off-Delay)
- Rugged Pin Style Socket Mounting
- 10 A, DPDT Contact Ratings
- 0.1 s...30 min Fixed Timing Relay
- 0.1 s...3 min Single Adjustable Timing Relay
- Single or Fixed Timing



### Single Range Timing Relay with Pin Style Terminations

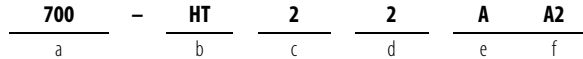

### Catalog Number Explanation - 700-HT Relays

a Bulletin Number	-	b Type of Relay	c Operating Mode	d Number of Poles	e Timing Range	f Coil Voltage
700		HT - Tube Base Adjustable Timing Relay	1-On-delay 2-Off-delay	2 - 2PDT	A- 0.1...10 s B- 1.0...100 s C- 0.1...10 min D- 1.0...100 min E- 0.1...10 hr	U12- 12V DC U24- 24V AC/DC, 50/60 Hz U120- 120V AC/DC, 50/60 Hz A2- 240V AC, 50/60 Hz

	Operating Mode	<b>Wiring Diagrams</b>	
		<b>U.S./Canada</b>	<b>International</b>
	On-Delay		
	Socket	700-HN125 or 700-HN100	700-HN100
	Off-Delay		
<b>700-HT DPDT 2-Pole — 2 Form C Contacts</b>	Socket	700-HN126 or 700-HN101	700-HN101



## Fixed Timing Relays

700-HTF Fixed Timing Relays feature a plug-in tube base. Construction is the same as the 700-HT relay except that the adjustment knob has been removed to help prevent unwanted tampering. The timing and output specifications are identical to those of the 700-HT relay. Setting time will be  $\pm 5\%$  of the time ordered.



<u>700</u>	-	<u>HTF</u>	<u>2</u>	<u>2</u>	<u>025</u>	<u>S</u>	<u>A2</u>
a		b	c	d	e	f	g

## Catalog Number Explanation - 700-HTF Relays



a Bulletin Number	b Type of Relay	c Operating Mode	d Number of Poles	e Timing Range	f Timing Units	g Coil Voltage
700	HTF- Tube Base Fixed Timing Relay	1—On-delay 2—Off-delay	2 - 2PDT	001...999 – The three digit code represents a numeric value with one decimal place. For example: code 001 is 0.1, code 025 is 2.5, and code 999 is 99.9 The acceptable range for each time unit is listed below: Seconds - 001...999 Minutes - 001...999 Hours - 001...100	S –Seconds M –Minutes H –Hours	U12– 12V DC U24– 24V AC/DC, 50/60 Hz U120– 120V AC/DC, 50/60 Hz A2 – 240V AC, 50/60 Hz





## Socket and Retainer Clip Reference

Relay Type	Socket Cat. No.	Retainer Clip Cat. No.
700-HT12	700-HN100	700-HN110
	700-HN125	Not Required <sup>(1)</sup>
700-HT22	700-HN101	700-HN110
	700-HN126	Not Required <sup>(1)</sup>

(1) Design of these sockets holds the relays securely and does not require retainer clips.

## Accessories - 700-HT Relays

	Description	Pkg. Qty.	Cat. No.
	<b>Screw Terminal Tube Base Socket — Panel or DIN Rail Mounting; Guarded Terminal Construction.</b> 8-Pin for use with DPDT 700-HA Relays, -HX Digital Timing Relays, -HT (On-Delay) and -HRM, -HRC and -HV (Repeat Cycle) Timing Relays. Order ten or multiples of ten	10	700-HN100
	<b>Screw Terminal Tube Base Socket — Panel or DIN Rail Mounting; Open Style Construction.</b> 8-Pin for use with DPDT 700-HA Relays, -HT (On-Delay) and -HRM, -HRC and -HV (Repeat Cycle) Timing Relays. Order must be for 10 sockets or multiples of 10. No retainer clip required.	10	700-HN125

	Description	Pkg. Qty.	Cat. No.
	<p><b>Screw Terminal Tube Base Sockets — Panel or DIN Rail Mounting; Guarded Terminal Construction.</b> 11-pin for use with 3PDT 700-HA relays.</p>	10	700-HN101
	<p><b>Screw Terminal Tube Base Sockets — Panel or DIN Rail Mounting; Open Style Terminal Construction.</b> 11-pin for use with 3PDT 700-HA relays. No retainer clip required.</p>	10	700-HN126
	<p><b>DIN (#3) symmetrical hat rail</b> 35 x 7.5 x 1 m</p>	10	199-DR1
	<p><b>Retainer Clip for Cat. Nos. 700-HN100 and -HN101 Sockets with 700-HT Timing Relays<sup>(1)</sup></b> Secures relay in socket. Order must be for 10 clips or multiples of 10.</p>	10	700-HN110
	<p><b>Pre-Printed Identification Tags</b> — contains 10 sheets of pre-printed and blank tags. Each sheet contains 13 sets of the markings CR...9CR, TR...9TR, M...9M, F, R, 1S, and 117 blank tags. Tags are peel-off with sticky backing for easy placement on relays.</p>	10	700-N40
	<p><b>Blank Identification Tags</b> — contains 10 sheets of blank identification tags for customer specialized printing. Each sheet contains 546 blank tags. Tags are peel-off with sticky backing for easy placement on relays.</p>	10	700-N41

(1) Refer to 700-HT Timing Relay, Socket, and Retainer Clip Reference Chart.

## Specifications - 700-HT

		Cat. No. 700-HT...			Cat. No. 700-HTF...		
<b>Electrical Ratings</b>							
Pilot Duty Rating <sup>(1)</sup>		NEMA B300					
Rated Thermal Current ( $I_{th}$ )		10 A					
Rated Insulation Voltage ( $U_i$ )		250V IEC, 300V UL/CSA					
Contacts	Inductive	Make	Break	HP	Make	Break	HP
		► ◄	◄ ►		► ◄	◄ ►	
	120V AC	30 A	3 A	1/2 N.O. 1/3 N.C	30 A	3 A	1/3
	240V AC	15 A	1.5 A	1/2 N.O. 1/3 N.C	15 A	1.5 A	1/2
	Resistive 28V DC	10 A	10 A	—	10 A	10 A	—
Permissible Coil Voltage Variation		85...110% of Nominal Voltage at 50 Hz 85...110% of Nominal Voltage at 60 Hz 80...110% of Nominal Voltage at DC					
Power Consumption ±10%	AC	24V AC	2 VA				
		120V AC	4 VA				
		240V AC	4 VA				
	DC	1.3 W					
<b>Design Specification/Test Requirements</b>							
Dielectric Withstand Voltage	Pole-to-Pole, same circuit (VRMS)		1000V AC				
	Pole-to-Pole, different circuits (VRMS)		2000V AC				
	Contact-to-Coil (VRMS)		2000V AC				
Electrical Life Operations		100,000 minimum					
Switching Frequency Operations		1800/hr					
Coil Voltages		See product selection					
<b>Mechanical</b>							
Degree of Protection		Open Type (Guarded Terminal Sockets)					
Mechanical Life Operations		10 x 10 <sup>6</sup>					
Switching Frequency Operations		18,000/hr					
Timing	Duty Cycle	Continuous					
Repeat Accuracy (constant voltage and temperature)		±2% (Time Delay: 0.1...2 s) ±1% (Time Delay: >2 s)					
Repeat Accuracy (variable voltage and temperature)		±10%					
Fixed Time Setting Accuracy		—			±5% (Time Delay: 0.1...2 s) ±1% (Time Delay: >2 s)		
Scale Tolerance	High End of Range	+5%			—		
	Low End of Range	-50%			—		
Reset Time	ON Delay	100 ms					
	OFF Delay	40 ms					

		Cat. No. 700-HT...	Cat. No. 700-HTF...
<b>Environmental</b>			
Temperature	Operating	-28...+65 °C (50 °C max., 240V AC coil) (-18...+149 °F) (122 °F max., 240V AC coil)	
	Storage	-55...+85 °C (-67...+185 °F)	
Altitude		2000 m (6560 ft)	
<b>Construction</b>			
Insulating Material		Molded High Dielectric Material	
Enclosure		Impact Resistant Dust Cover	
Contact Material		Silver Cadmium Oxide	
Terminal Markings on Socket		In accordance with EN50 005	
Sockets		8- or 11-Pin Socket (On = 8, Off = 11) 700-HN100, -HN125 700-HN101, -HN126	
Certifications		CSA Certified, File 223833, UL Recognized, File E3125 Guide NLDX 2, UL Listed, when used with 700-HN100, 700-HN101, 700-HN125, and 700-HN126 Sockets, File No. E3125 Guide NLDX, CE Marked	
Standards		EN 61812-1, CSA 22.2 No. 14, UL 508	

(1) See [NEMA Ratings and Test Values on page 5](#).

### Trigger Signal Cat. Nos. 700-HT

Contact closure provides signal to timer. A low energy signal is generated by the 700-HT timing relay. For optimum reliability, use contacts designed for low energy switching (10V, 1 mA) (Bul. 800F-X\_\_V, 800T-X\_\_V). No external voltage should be connected to the contact signal.

### Timing Diagrams - 700-HT Relays



ON Delay	OFF Delay

### 700-HV Timing Relay

- Repeat Cycle Timing Relay
- 10 A Contact Rating
- DPDT
- Pin Style Terminals
- 0.1 s...30 min.
- Repeat Cycle Adjustable Timing
- Two Timing Adjustments T1 ≠ T2

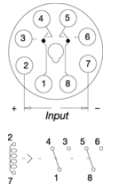

### Repeat Cycle Timing Relays with Pin Style Terminations with 2 Adjustments (T1 ≠ T2)

	<b>Operating Mode</b>  Repeat Cycle	<b>Wiring Diagrams</b>	
		<b>U.S./Canada</b>  	<b>International</b>  
<b>700-HV Repeat Cycle Timing Relay DPDT 2-Pole — 2 Form C Contacts</b>	<i>Socket</i>	700-HN125 or 700-HN100	700-HN100

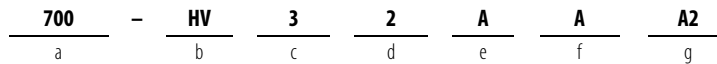

### Catalog Number Explanation - 700-HV Relays





a Bulletin Number	b Type of Relay	c Operating Mode	d Number of Poles	e Timing Range OFF Time	f Timing Range ON Time	g Coil Voltage
700	HV – Tube Base Repeat Cycle Timing Relay	3 – Power ON Repeat Cycle, OFF Start (Repeat Cycle, OFF/ON Delay)	2 – 2PDT	Code OFF Time — Type HV A – 0.1...10 s B – 1.0...100 s C – 0.1...10 min D – 1.0...100 min E – 0.1...10 hr	Code ON Time — Type HV A 0.1...10 s B 1.0...100 s C 0.1...10 min D 1.0...100 min E 0.1...10 hr	U12 –12V DC U24 –24V AC/DC, 50/60 Hz U120 –120V AC/DC, 50/60 Hz A2 –240V AC, 50/60 Hz

### Socket and Retainer Clip Reference

Relay Type	Socket Cat. No.	Retainer Clip Cat. No.
700-HV	700-HN100	700-HN110
	700-HN125	Not Required <sup>(1)</sup>

(1) Design of these sockets holds the relays securely and does not require retainer clips.

**Accessories - 700-HV Relays**

Photo	Description	Pkg. Qty.	Cat. No.
	<p><b>Screw Terminal Tube Base Socket — Panel or DIN Rail Mounting; Guarded Terminal Construction.</b> 8-Pin for use with DPDT 700-HA Relays, -HX Digital Timing Relays, -HT (On-Delay) and -HRM, -NRC and -HV (Repeat Cycle) Timing Relays. Order ten or multiples of ten</p>	10	700-HN100
	<p><b>DIN (#3) symmetrical hat rail</b> 35 x 7.5 x 1 m</p>	10	199-DR1
	<p><b>Screw Terminal Tube Base Socket — Panel or DIN Rail Mounting; Open Style Construction.</b> 8-Pin for use with DPDT 700-HA Relays, -HT (On-Delay) and -HRM, -HRC and -HV (Repeat Cycle) Timing Relays. Order must be for 10 sockets or multiples of 10. No retainer clip required.</p>	10	700-HN125
	<p><b>Pre-Printed Identification Tags</b> — contains 10 sheets of pre-printed and blank tags. Each sheet contains 13 sets of the markings CR. . .9CR, TR. . .9TR, M. . .9M, F, R, 1S, and 117 blank tags. Tags are peel-off with sticky backing for easy placement on relays.</p>	10	700-N40
	<p><b>Blank Identification Tags</b> — contains 10 sheets of blank identification tags for customer specialized printing. Each sheet contains 546 blank tags. Tags are peel-off with sticky backing for easy placement on relays.</p>	10	700-N41

## Specifications - 700-HV Relays

		Cat. No. 700-HV...		
Electrical Ratings				
Pilot Duty Rating‡		NEMA B300		
Rated Thermal Current ( $I_{th}$ )		10 A		
Rated Insulation Voltage ( $U_i$ )		250V IEC, 300V UL/CSA		
Contacts	Inductive	<b>Make</b>	<b>Break</b>	<b>Hp</b>
		▶ ] [ ◀	◀ ] [ ▶	
	120V AC	30 A	3 A	1/2 N.O. 1/3 N.C.
	240V AC	15 A	1.5 A	1/2 N.O. 1/3 N.C.
Resistive 28V DC		10 A	10 A	—
Permissible Coil Voltage Variation		85...110 of Nominal Voltage at 50 Hz 85...110 of Nominal Voltage at 60 Hz 80...110 of Nominal Voltage at DC		
Power Consumption ±10%	AC	24V AC	2 VA	
		120V AC	4 VA	
		240V AC	4 VA	
	DC	1.3 W		
Design Specification/Test Requirements				
Dielectric Withstand Voltage	Pole-to-Pole, same circuit (VRMS)		1000V AC	
	Pole-to-Pole, different circuits (VRMS)		2000V AC	
	Contact-to-Coil (VRMS)		2000V AC	
Electrical Life Operations		100,000 minimum		
Switching Frequency Operations		1800/hr		
Coil Voltages		See product selection		
Mechanical				
Degree of Protection		Open Type (Guarded Terminal Sockets)		
Mechanical Life Operations		10 x 10 <sup>6</sup>		
Switching Frequency Operations		18,000/hr		
Timing	Duty Cycle	Continuous		
Repeat Accuracy (constant voltage and temperature)		±2% (Time Delay: 0.1...2 s) ±1% (Time Delay: >2 s)		
Repeat Accuracy (variable voltage and temperature)		±10%		
Scale Tolerance	High End of Range	+5%		
	Low End of Range	-50%		
Reset Time		100 ms		
Environmental				
Temperature	Operating	-28...+65 °C (50 °C max., 240V AC coil) (-18...+149 °F) (122 °F max., 240V AC coil)		
	Storage	-55...+85 °C (-67...+185 °F)		
Altitude		2000 m (6560 ft.)		
Construction				
Insulating Material		Molded High Dielectric Material		
Enclosure		Impact Resistant Dust Cover		

Contact Material	Silver Cadmium Oxide
Terminal Markings on Socket	In accordance with EN50 005
Sockets	8-Pin Socket Cat. No. 700-HN100, -HN125
Certifications	CSA Certified, File 223833; UL Recognized, File E3125; Guide NLDX 2; cULus Listed when used with 700-HN100 and 700-HN125 sockets; CE Marked
Standards	EN 61812; CSA 22.2 No. 14; UL 508

### Timing Diagram- 700-HV Relays

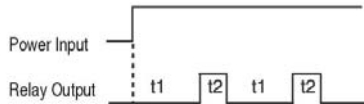

### Dimensions - 700-HV Relays

Approximate Dimensions are shown in millimeters (inches). Approximate Dimensions are not intended to be used for manufacturing purposes.

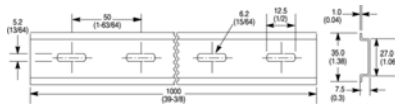
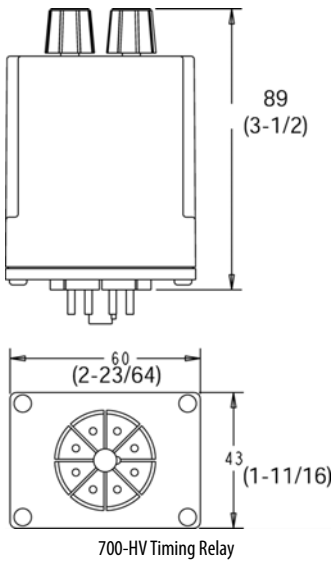

Cat. No. 199-DR1 DIN Mounting Rail Series B  
 Cat. No. 199-DR4 DIN Mounting Rail Series B Has No Mounting Holes

Cat. No.	A	B	C	D	Approx. Shipping Wt.
199-DR1	35 (1-3/8)	27 (1-1/16)	7.5 (19/64)	1.02 (1/64)	1.85 kg (4.07 lbs.) (10/pkg)
199-DR4	35 (1-3/8)	27 (1-1/16)	15 (19/32)	2.3 (3/32)	3.68 kg (8 lbs.) (5/pkg)



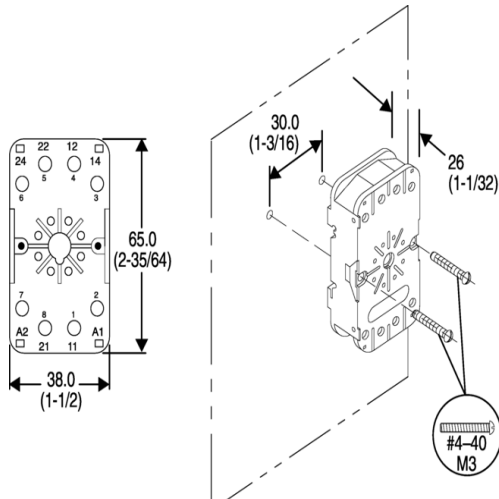

Cat. No. 700-HN100  
 Panel Mounting  
 Double Wire—2 x 2.5mm<sup>2</sup> (#2-14 AWG...#2-20 AWG)  
 (Either Solid or Stranded)  
 Strip Length: 9 mm (3/8 in) - Torque: 0.8 N·m (7 ib·in)

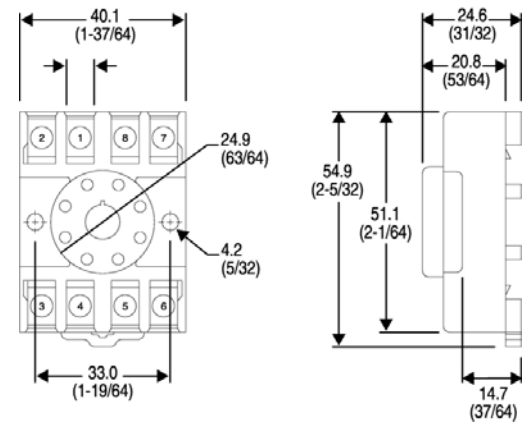

Cat. No. 700-HN125  
 Wire Size: 2 x 2.5 mm<sup>2</sup>  
 Single Wire—Up to #12 AWG  
 Double Wire—2 x 2.5mm<sup>2</sup> (#2-14 AWG...#2-20 AWG)  
 (Either Solid or Stranded)  
 Strip Length: 9 mm (3/8 in) - Torque: 0.8 N·m (7 ib·in)

## 700-HX Multi-Function Digital Timing Relay

- Digital timing relay with LCD display
- Socket- or panel-mounted (NEMA 4X/IP66)
- 5A, B300, SPDT contact ratings
- 10 Functions or modes
- Environmentally friendly — flash memory, no battery



Photo	Operating Mode	Timing Range	Socket Type	Contact Output	No. of Pins	Input Voltage	Cat. No.
	A mode: Signal ON-Delay 1 A-1 mode: Signal ON-Delay 2 A-2 mode: Power ON-Delay 1 A-3 mode: Power On-Delay 2 B mode: Repeat Cycle 1 B-1 mode: Repeat Cycle 2 D mode: Signal OFF-delay E mode: One Shot F mode: Cumulative Z mode: On/Off duty adjustable repeat cycle S mode: stop watch toff: Flicker OFF start 1 ton: Flicker ON start 1 toff-1: Flicker OFF start 2 ton-1: Flicker ON start 2	0.000...9.999 s 0.000...99.99 s 0.000...999.9 s 0.000...9999 s 0.000...99 min 59 s 0.000...999.9 min 0.000...9999 min 0.000...99 hr 59 min 0.000...999.9 hr 0.000...9999 hr	700-HN100 700-HN125	SPDT	8	100...240V AC  24V AC 12...24V DC	700-HX86SA17  700-HX86SU24



### Socket and Retainer Clip Reference

Timer Type	Socket Cat. No.	Retainer Clip Cat. No.
700-HX	700-HN100	700-HN131
	700-HN108	Not Required <sup>(1)</sup>
	700-HN125	Not Required

(1) Design of socket holds the relay securely and does not require retainer clips.

### Accessories - 700-HX Relays

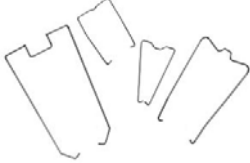
Photo	Description	Pkg. Quantity	Cat. No.
	<b>Screw Terminal Tube Base Socket — Panel or DIN Rail Mounting; Guarded Terminal Construction.</b> 8-Pin for use with 700-HX Timing Relays. Order ten or multiples of ten	10	700-HN100
	<b>Screw Terminal Tube Base Socket — Panel or DIN Rail Mounting; Open Style Construction.</b> 8-Pin for use with 700-HX Timing Relays. Order must be for 10 sockets or multiples of 10. No retainer clip required.	10	700-HN125
	<b>DIN (#3) symmetrical hat rail</b> 35 x 7.5 x 1 m	10	199-DR1

Photo	Description	Pkg. Quantity	Cat. No.
	<p><b>Specialty Socket</b> 8-pin backwired socket with solder terminals. For use with 700-HX Timing Relays.</p>	10	700-HN108
	<p><b>Retainer Clip for Cat. Nos. 700-HN100 Sockets with all 700-HX Timing Relays</b> Secures timer in socket.  Note: Not required for installation</p>	10	700-HN131
	<p><b>Frame Adapter</b> For flush or door mounting of all 700-HR and -HX timers.</p>	1	700-HN130
	<p><b>Protective Cover</b> Helps prevent tampering of timing and mode settings. Provides a degree of protection against water and dirt from entering the front of the relay. For use with all 700-HR and -HX timing relays.</p>	1	700-HN132

## General Timer Functions- 700-HX Relays

### Display Section

**1. Key Protect Indicator** (orange)

**2. Control Output Indicator** (orange)

**3. Reset Indicator** (orange)

**4. Present Value Display** (Main display)  
(Character height: 12 mm, red \*)

\* Characters on models with screw terminals can be switched between red, green, and orange.

### 5. Time Unit Indicators

(Color is same as present value display.)

(If the time range is 0 min, 0 h, 0.0 h, or 0 h 0 min, these indicators flash to indicate timing operation.)

### 6. Set Value Display

(Character height: 6 mm, green)

### 7. Set Value 1, 2 Indicator

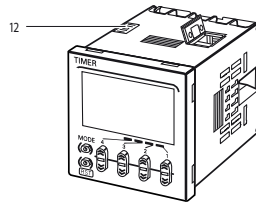
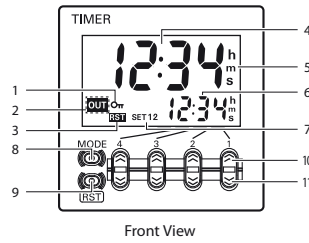

### Operation Key

#### 8. Mode Key

(Changes modes and setting items)

#### 9. Reset Key

(Resets present value and output)

#### 10. Up Keys 1 to 4

#### 11. Down Keys 1 to 4

### Switches

#### 12. Key-protect Switch

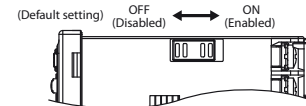

Character Size for Present Value Display

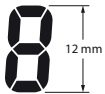

Character Size for Set Value Display



## Specifications - 700-HX Relays

Attribute		700-HX
<b>Electrical Ratings</b>		
Pilot Duty Rating		NEMA B300
Rated supply voltage		100 to 240V AC, 24V AC/12 to 24V DC (50/60Hz) (permissible ripple: 20%(p-p) max.)
Operating voltage range		85...110% of rated supply voltage
Power consumption	100...240V AC	4.3VA
	24V AC/12...24V DC	3.4VA/1.7 W
Inrush Current	100...240V AC	3 A
	24V AC/12...24V DC	5 A
Make ▶ ◀	120V AC	30 A
	240V AC	15 A
Break ◀ ▶	120V AC	3 A
	240V AC	1.5 A
Hp at 120V AC		1/4 Hp
Hp at 240V AC		1/3 Hp
<b>Mechanical</b>		
Mounting Method		Flush mounting, surface mounting, DIN mounting
Display		Seven-segment, negative transmissive LCD; Present value (red, 12 mm high characters); Set value (green, 6 mm high characters)
Digits		Four digits
Timer	Time ranges	0.000...9.999 s, 0.00...99.99 s, 0.0...999.9 s, 0...9999 s, 0 min 00 s...99 min 59 s, 0.0...999.9 min, 0 hr 00 min...99 hr 59 min, 0.0 hr...999.9 hr, 0 hr...9999 hr
	Timer modes	Elapsed time (Up), remaining time (Down), selectable
	Output modes	A, A-1, A-2, A-3, B, B-1, D, E, F, Z, S, tOFF, tON, tOFF-1, or tON-1
Inputs	Input signals	Start, reset
	Input method	No-voltage input via:NPN transistor or switching of contact
	Start, reset, gate	Minimum input signal width: 1 or 20 ms (selectable)
	Power reset	Minimum power-opening time: 0.5 s (Except for A-3, B-1, and F mode)
Control output		SPDT contact output: 5 A at 250V AC, resistive load (cosine=1) Minimum applied load: 10 mA at 5 V DC (failure level: P,reference value)
External Power Supply		No
Key Protect		Yes
Memory Backup		EEP-ROM (overwritten 100 000 times min), which can store data for 10 years min.
Accuracy of Operating Time and Setting Error <sup>(1)</sup>		Power-ON start: +-0.01% +-50 ms max. <sup>(1)</sup> to be rated against set value Signal start: +- 0.005% +-30 ms max. <sup>(1)</sup> to be rated against set value Signal start at transistor output model: +- 0.005% +-3 ms max. <sup>(2)</sup> If the set value is within the sensor waiting time (250 ms max.)

(1) The values are based on the set value.

(2) The value is applied for a minimum pulse width of 1 ms.

Attribute		700-HX
<b>Environmental</b>		
Installation environment		Setup category II, pollution degree 2 (as per IEC61010-1)
Ambient temperature		-10...+55 °C (14...141 °F), Avoid freezing or condensation
Ambient humidity		25...85 %
Storage temperature		-25...+65 °C (-13...149 °F), Avoid freezing or condensation
Altitude, max		2,000 m
<b>Characteristics <sup>(1)</sup></b>		
Insulation Resistance		100 mΩ min. (at 500VDC)
Dielectric Strength		2000V AC, 50/60Hz for 1 min between current-carrying terminals and non-current-carrying metal parts (1000V AC for 24V AC/12 to 24V DC type), 1000 VAC, 50/60 Hz for 1 min between non-continuous contacts
Noise Immunity		±1.5 kV (between power terminals) for 100 to 240 VAC, ±480V for 24VAC/12 to 24VDC, and ±600V (between input terminals), square-wave noise by noise simulator (pulse width: 100 ns/1 μs, 1-ns rise)
Static Immunity		±8 kV (malfunction), ±15 kV (destruction)
Vibration Resistance	Malfunction	10...55 Hz with 0.35 mm single amplitude each in three directions for 10 min
Shock Resistance	Malfunction	98 m/s <sup>2</sup> (approx. 10 G) each in three directions
Life Expectancy	Mechanical	10 million operations min. (under no load at 18 000 operation/hr)
	Electrical	100 000 operations min. (5 A at 250V AC, resistive load at 1800 operation/hr)
EMC	(EMI)	EN61812-1
	Emission Enclosure:	EN55011 Group1 class A
	Emission AC mains:	EN55011 Group1 class A
	(EMS)	EN61812-1
	Immunity ESD:	EN61000-4-2: 4 kV contact discharge (level2) 8 kV air discharge (level3)
	Immunity RF-interference:	EN61000-4-3: 10 V/m
Enclosure Ratings		Panel surface: IP66 and NEMA Type 4 (indoors) <sup>(2)</sup>
Weight		Approx. 100 g
Certifications		CE Certified; cURus (File No. E14843, Guide NRNTZ/NRNT8), C-Tick Marked
Standards		EN61010-1, EN 61326, VDE0106/P 100, CSA C22.2 No. 14, UL 508

(1) More information in the 700-HX User Manual, publication [700-UM002](#).

(2) An attached waterproof packing is necessary to ensure IP66 waterproofing between the 700-HX and installation pan.

Timing Charts- 700-HX Relays

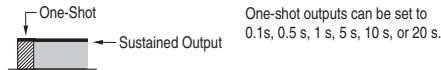

Output Mode A Mode: Signal ON-Delay (Timer resets when power comes ON.)

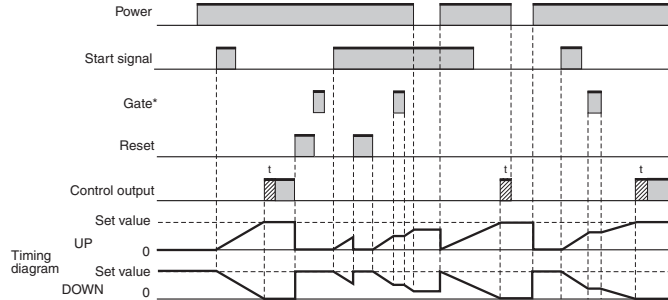

Timing starts when the start signal goes ON. While the start signal is ON, the timer starts when power comes ON or when the reset input goes OFF. The control output is controlled using a sustained or one-shot time period.

Basic Operation

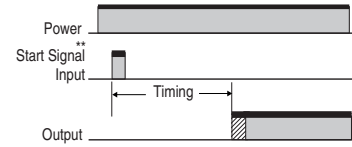

\*Output is instantaneous when setting is 0.  
\*\* Start signal input is enabled during timing.

Output Mode A-1: Signal ON-Delay 2 (Timer resets when power comes ON.)

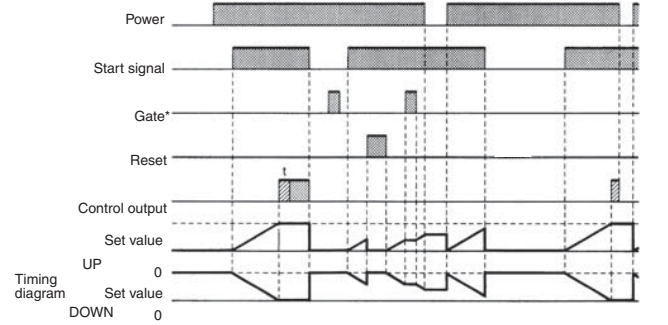

Timing starts when the reset input goes ON and is reset when the start signal goes OFF. While the start signal is ON, the timer starts when the power comes ON or when the reset input goes OFF. The control output is controlled using a sustained or one-shot time period.

Basic Operation

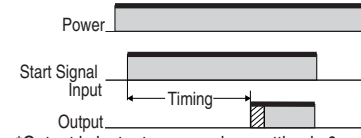

\*Output is instantaneous when setting is 0.

Output Mode A-2: Power ON Delay 1 (Timer resets when power comes ON)

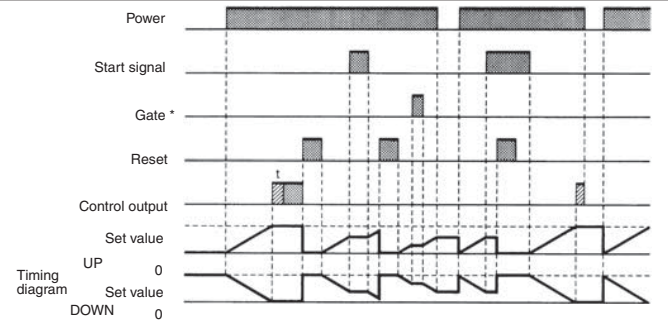

Timing starts when the reset input goes OFF. The start signal disables the timing function (i.e., same function as the gate input). The control output is controlled using a sustained or one-shot time period.

Basic Operation

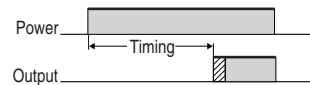

\*Output is instantaneous when setting is 0.

Output Mode A-3 Power ON Delay 2 (Timer does not reset when power comes ON)

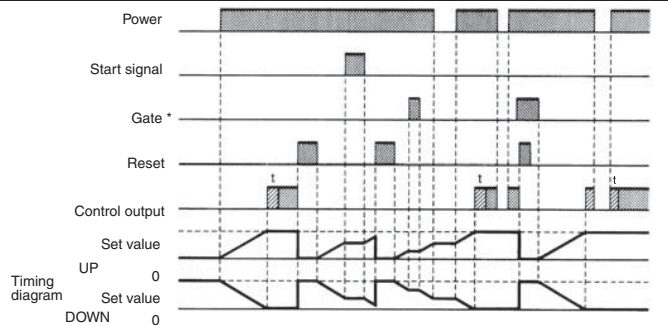

Timing starts when the reset input goes OFF. The start signal disables the timing function (i.e., same function as the gate input). The control output is controlled using a sustained or one-shot time period.

Basic Operation

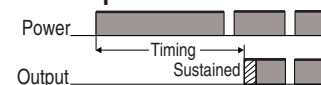

\*Output is instantaneous when setting is 0.

† Gate not included on any mode of this relay.

Output Mode B: Repeat Cycle (Timer resets when power comes ON.)

Sustained Output

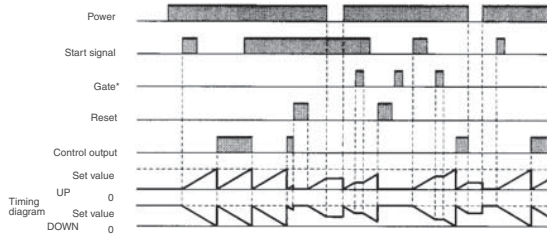

Timing starts when the start signal goes ON. The status of the control output is reversed when time is up (OFF at start). While the start signal is ON, the timer starts when the power comes ON or when the reset input goes OFF.

Basic Operation

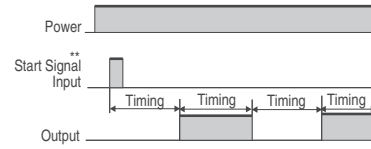

\* Normal output operation will not be possible if the set time is too short. Set the value to at least 100 ms (contact output type).  
\*\* Start signal input is disabled during timing.

One-Shot Output

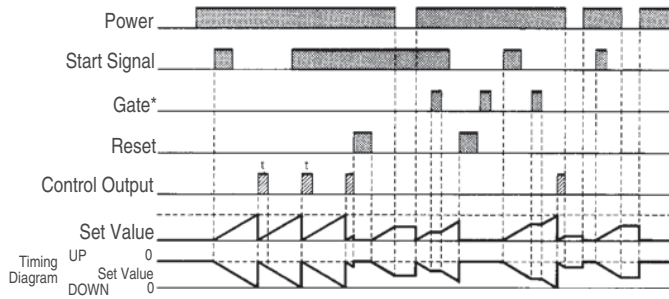

Timing starts when the start signal goes ON. The control output is turned ON when time is up. While the start signal is ON, the timer starts when the power comes ON or when the reset input goes OFF.

Basic Operation

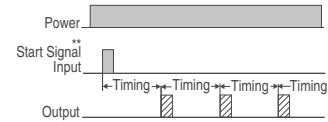

\* Normal output operation will not be possible if the set time is too short. Set the value to at least 100 ms (contact output type).  
\*\* Start signal input is disabled during timing.

Output Mode B-1: Repeat Cycle 2 (Timer does not reset when power comes ON)

Sustained Output

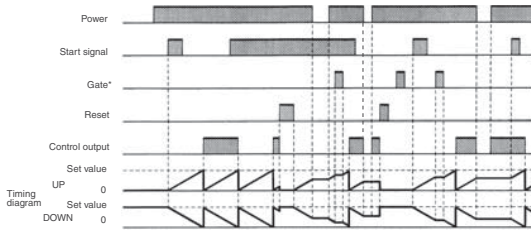

Timing starts when the start signal goes ON. The status of the control output is reversed when time is up (OFF at the start). While the start signal is ON, the timer starts when the power comes ON or when the reset input goes OFF.

Basic Operation

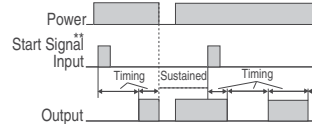

\* Normal output operation will not be possible if the set time is too short. Set the value to at least 100 ms (contact output type).  
\*\* Start signal input is disabled during timing.

One-Shot Output

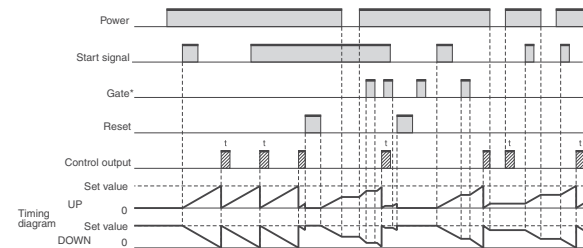

Timing starts when the start signal goes ON. The control output comes ON when time is up. While the start signal is ON, the timer starts when the power comes ON or when the reset input goes OFF.

Basic Operation

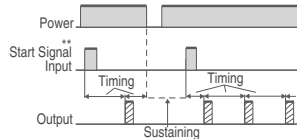

\* Normal output operation will not be possible if the set time is too short. Set the value to at least 100 ms (contact output type).  
\*\* Start signal input is disabled during timing.

\* Gate not included on any mode of this relay.



**Output Mode D: Signal OFF-Delay (Timer resets when power comes ON.)**

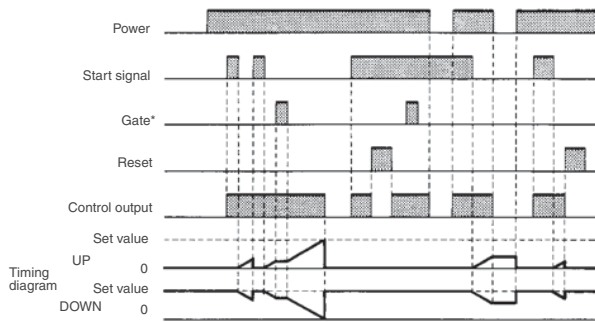

The control output is ON when the start signal is ON (except when the power is OFF or the reset is ON).  
The timer is reset when the time is up.

**Basic Operation**

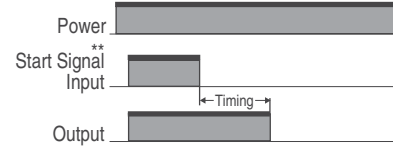

\* Output functions only during start signal input when setting is 0.  
\*\* Start signal input is enabled during timing.

**Output Mode E: Interval (Timer resets when power comes ON.)**

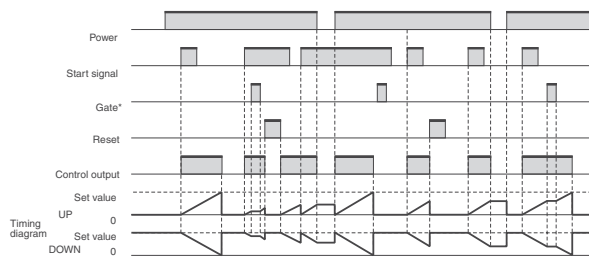

Timing starts when the start signal comes ON.  
The control output is reset when time is up.  
While the start signal is ON, the timer starts when power comes ON or when the reset input goes OFF.

**Basic Operation**

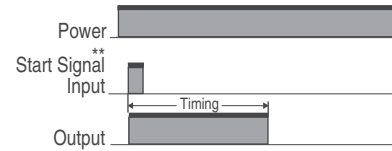

\* Output is disabled when the setting is 0.  
\*\* Start signal input is enabled during timing.

**Output Mode F: Cumulative (Timer does not reset when power comes ON)**

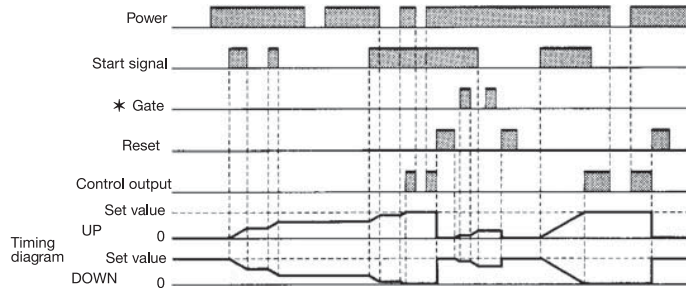

Start signal enables timing (timing is stopped when the start signal is OFF or when the power is OFF).  
A sustained control output is used.

**Basic Operation**

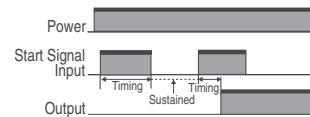

\*Output is instantaneous when setting is 0.

† Gate not included on any mode of this relay.

**Z Mode**

Output quantity can be adjusted by changing the cycle time set in the adjustment level to 1 and by changing the ON duty (%) set value. The set value shows the ON duty (%) and can be set to a value between 0 and 100 (%). When the cycle time is 0, the output will always be OFF. When the cycle time is not 0 and when ON duty has been set to 0 (%), the output will always be OFF. When ON duty has been set to 100 (%), the output will always be ON.

Z mode: ON/OFF-duty Adjustable Repeat Cycle

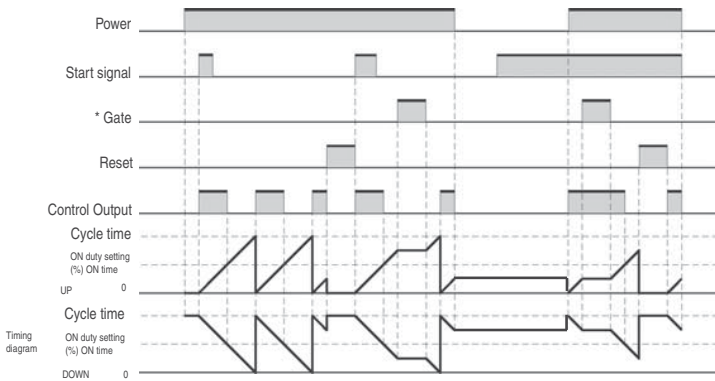

Timing starts when the start signal goes ON. The status of the control output is reversed when time is up (ON at start). While the start signal is ON, the timer starts when power comes ON or when the reset input goes OFF.

Basic Operation

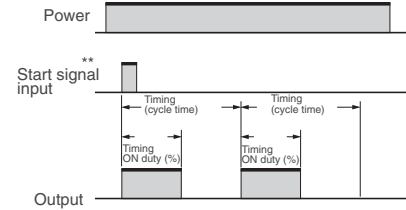

- \* Normal output operation will not be possible if the set time is too short. Set the value to at least 100 ms (contact output type).
- \*\* Start signal input is enabled during timing.

Output Mode S: Stop Watch (Timer resets when power comes ON)

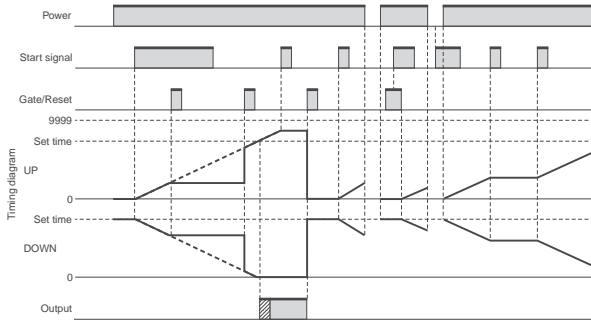

The signal starts and stops timing. The display is held and timing is continued if the reset or gate input is received during timing operation. The timer resets if the reset or gate input is received when the timing operation is stopped.

Basic Operation

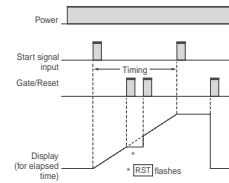

Note: Output is instantaneous when setting is 0.

Output Mode T OFF: Twin Timer OFF start

Sustained Output

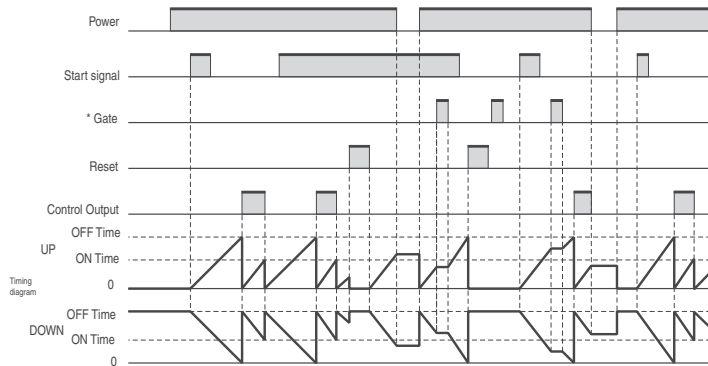

Timing starts when the start signal goes ON. The status of the control output is reversed when time is up (OFF at start). While the start signal is ON, the timer starts when power comes ON or when the reset input goes OFF.

Basic Operation

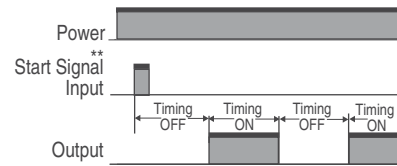

- \* Normal output operation will not be possible if the ON/OFF set time is too short. Set the value to at least 100 ms (contact output type).
- \*\* Start signal input is disabled during timing.

\* Gate not included on any mode of this Relay.

Output Mode T ON: Twin Timer ON start

Sustained Output

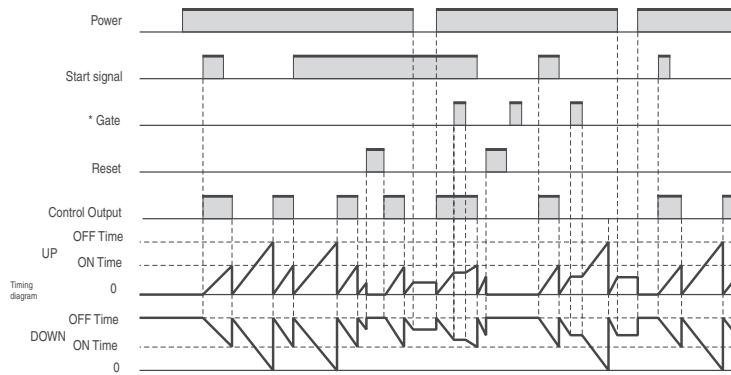

Timing starts when the start signal goes ON. The status of the control output is reversed when time is up (ON at start). While the start signal is ON, the timer starts when power comes ON or when the reset input goes OFF.

Basic Operation

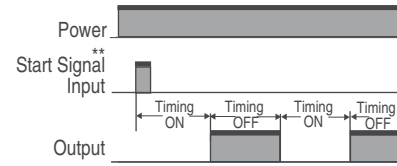

\* Normal output operation will not be possible if the ON/OFF set time is too short. Set the value to at least 100 ms (contact output type).  
 \*\* Start signal input is disabled during timing.

Output Mode TOFF-1: Flicker OFF start 2 (Timer does not reset when power comes ON)

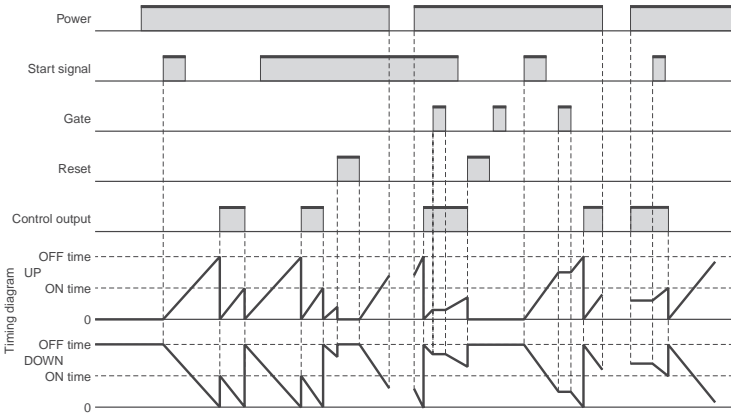

Timing starts when the start signal goes ON. The status of the control output is reversed when time is up (OFF at start). While the start signal is ON, the timer starts when the power comes ON or when the reset input goes OFF.

Basic Operation

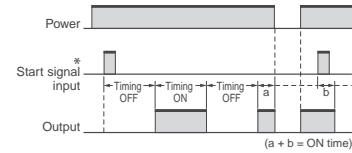

\* Start signal input is disabled during timing.

**Note:** Normal output operation will not be possible if the set time is too short. Set the value to at least 100 ms (contact output type).

Output Mode TON-1: Flicker ON start 2 (Timer does not reset when power comes ON)

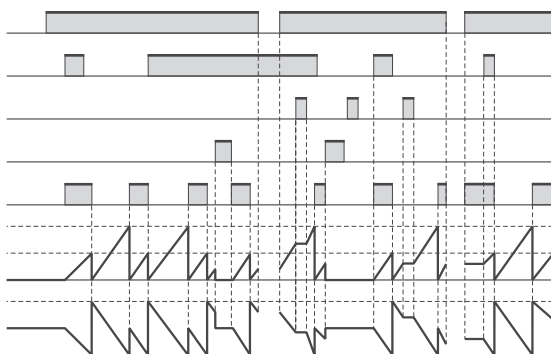

Timing starts when the start signal goes ON. The status of the control output is reversed when time is up (ON at start). While the start signal is ON, the timer starts when the power comes ON or when the reset input goes OFF.

Basic Operation

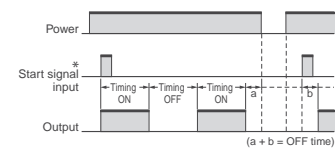

\* Start signal input is disabled during timing.

**Note:** Normal output operation will not be possible if the set time is too short.

r Gate not included on any mode of this Relay.

### Dimensions- 700-HX Relays

Approximate dimensions are shown in millimeters (inches). Dimensions are not intended for manufacturing purposes.

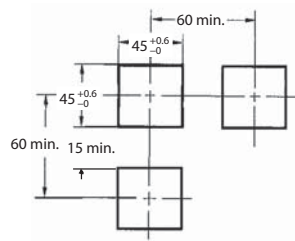
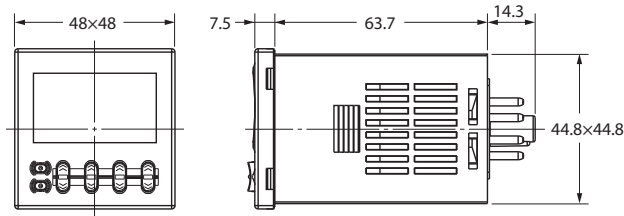

Cat. No. 700-HX...  
Panel Cutout

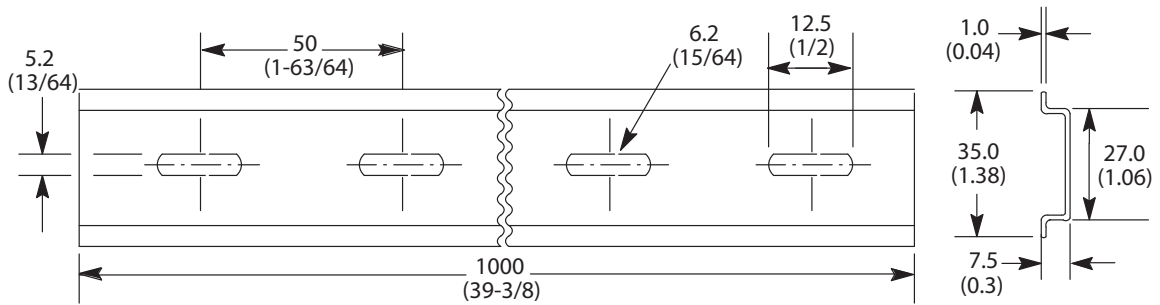

Cat. No. 199-DR1 DIN Mounting Rail Series B  
Cat. No. 199-DR4 DIN Mounting Rail Series B Has No Mounting Holes

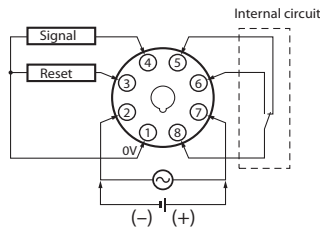

### Terminal Arrangement





Cat. No. 700-HX...

## NEMA Industrial Relays

### Product Overview

			
<b>Bulletin No.</b>	<b>700-P</b>	<b>700S-P</b>	<b>700-N</b>
<b>Type</b>	Heavy-duty control relay	Heavy-duty control relay	Industrial Relay
<b>Features</b>	<ul style="list-style-type: none"> <li>• Convertible contacts</li> <li>• Up to 600V AC &amp; DC</li> <li>• Very long life</li> <li>• Timer &amp; latch options</li> <li>• Mechanically linked</li> </ul>	<ul style="list-style-type: none"> <li>• Convertible contacts</li> <li>• Up to 600V AC &amp; DC</li> <li>• Very long life</li> <li>• Timer &amp; latch options</li> <li>• Mechanically linked</li> </ul>	<ul style="list-style-type: none"> <li>• Contact cartridges convertible from N.O. to N.C. and vice versa</li> <li>• NEMA A300 AC</li> <li>• 24...250V AC coils</li> <li>• Pneumatic timing unit</li> <li>• Solid-state timing unit</li> <li>• Overlap contacts</li> <li>• Logic reed contacts</li> </ul>
<b>Contact Form</b>	2...12 poles, double break	2...12 poles, double break	2- or 4-poles
<b>Contact Type</b>	Bifurcated double break	Bifurcated double break	—
<b>Contact Material</b>	Bifurcated silver nickel	Bifurcated silver nickel	Silver
<b>Electrical</b>			
<b>Max. Current AC Resistive</b>	10 A	10 A	10 A
<b>Min. load</b>	10V, 50 mA 1 mA, 5V with 700-CPR	10V, 50 mA 1 mA, 5V with 700-CPR	—
<b>Coil Voltage</b>	24...600V AC 6...600V DC	24...600V AC 6...600V DC	—
<b>Coil Voltage Pickup</b>	85...110% AC coils, 80...110% DC coils	85...110% AC coils, 80...110% DC coils	—
<b>Dielectric Withstand</b>	2640V	2640V	—
<b>Reference</b>			
<b>Electric Service Life (cycles)</b>	10 million at 10 A 120V AC	10 million at 10 A 120V AC	—
<b>Certifications</b>	cULus, CE	cULus, CE	UL, CSA, CE
<b>Sockets</b>	DIN Rail, relay rail, or panel mount	DIN Rail, relay rail, or panel mount	—
<b>Product Selection</b>	<a href="#">151</a>	<a href="#">151</a>	<a href="#">172</a>

**Product Overview**

		
<b>Bulletin No.</b>	<b>700-R</b>	<b>700-RTC</b>
<b>Type</b>	Sealed Switch	<b>Solid-state Timing Relay</b>
<b>Features</b>	<ul style="list-style-type: none"> <li>• Hazardous location ratings</li> <li>• Long life in dirty environment</li> <li>• Timer and latch options</li> <li>• Switch 600V AC, 300V DC</li> </ul>	<ul style="list-style-type: none"> <li>• Timed and instantaneous contacts.</li> <li>• Sealed contacts for harsh environments and hazardous locations.</li> </ul>
<b>Contact Form</b>	2...8 Poles	—
<b>Contact Type</b>	Sealed Switch	—
<b>Contact Material</b>	Sealed Switch	—
<b>Electrical</b>		—
<b>Max. Current AC Resistive</b>	5 A	—
<b>Min. load</b>	1 mA, 5V	—
<b>Coil Voltage</b>	24...240V AC 24...250V DC	—
<b>Coil Voltage Pickup</b>	85...110% AC Coils 80...110% DC Coils	—
<b>Dielectric Withstand</b>	2640V	—
<b>Reference</b>		
<b>Electric Service Life (cycles)</b>	1.5 million at 5 A 120V AC	—
<b>Certifications</b>	UL, CSA, CE	—
<b>Sockets</b>	Panel or rail mount	—
<b>Timing Relay Information</b>		
<b>Control Outputs:</b> <b>Time Limit Instantaneous</b>	—	Four output contacts
<b>Timing Operation Modes:</b>	—	On-Delay Off-Delay
<b>Time Range</b>	—	0.05 s . . . 64 min
<b>Supply Voltage</b>	—	24V AC 110 . . . 120V AC 220 . . . 240V AC 24V DC 120V DC 240V DC
<b>Product Selection</b>	<a href="#">176</a>	<a href="#">181</a>

## 700-P Industrial Relays

### 700-P — Direct Drive™ Convertible Contact Cartridge Relays

- NEMA and IEC ratings
- 600V maximum AC/DC
- Accessories for field installation: contact cartridges, adder decks, time delay, latching, surge suppressors, mounting strip
- Contact Ratings: (10 A) 700-CP1, (20 A) 700-CPM, (35 A) 700-CPH, (Low Power) 700-CPR
- For machine tool and other heavy-duty applications
- Can accommodate ring tongue terminals
- Integral DIN Rail mount on AC relays
- Finger-safe protection standard
- Factory supplied standard at 120V AC and 24V DC - user configurable for field assembly
- Blank relays are available in all coil voltages for field custom configuration
- Contact cartridge is convertible from N.O. to N.C. by simply turning cartridge over.

The 700/700DC-P family of Direct Drive Industrial Relays offers switching solutions ranging from 200 mA in Low Energy Circuits to 35 A in Heavy Duty Circuits. All of the contacts can easily be changed from the standard N.O. to N.C. configuration. The relays can be accessorized to meet the application needs with the use of time delayed contacts, mechanical latches and NEMA enclosures. All devices are available in the most popular AC and DC control voltages. Combining different cartridges into one relay can yield a custom-tailored application solution. Relays are available without contact cartridges in all of the available AC and DC coil voltages for maximum flexibility.

700/700DC-P relays use standard (10 A) contact cartridges with a double-break and bifurcated design. Bifurcation provides excellent contact reliability and low-contact bounce, while the double-break contact design reduces the possibility of contacts welding and enhances the relay's ability to break DC circuits. These relays can be configured with a maximum of 12 contacts (only 8 may be N.C.).

### A Modular Approach to Control Circuit Solutions

The 700-P AC control relay is factory assembled with a standard 10 A contact cartridges with all contacts as N.O. in either 2, 4, 8, or 12 pole configurations with a 120 volt operating coil. Four pole relays are also available at 240 and 480 VAC and can have up to eight contacts added by using adder decks. The 700DC-P control relay is factory assembled with a standard 10 A contact cartridges with all contacts as N.O. in either 4 or 8 poles with a 24 volt operating coil. The 4 pole is also available with a 120 VDC operating coil.

For control relays that require different contact ratings or control voltages we offer a modular design that are easily field configurable. A base blank relay (either AC or DC control), a variety of contact kits, adder decks, and operating coils can be used to make an infinite number of custom control relay solutions.

- Master Control 700-PMCKIT master control cartridges provide (20 A) switching capability with large single-contact pads on each side of the spanner for twice the current rating to control heavy loads and provide for master control of a system. The cartridge also has the same double-break design as the standard 700-P relay contact cartridge. Relays can be configured with up to a maximum of 12 contacts (only 8 may be N.C.). Time delay and latching attachments are compatible with master cartridges.
- Heavy Duty Control 700-PHDKIT contact cartridges provide (35 A) switching capability through tandem contact cartridges. A jumper allows two (20 A) master contact cartridges to be connected in parallel. A maximum of six poles can be configured in a relay, only four of which can be normally closed. Time delay and latch attachments are available.
- Low Energy Control Logic Reed 700-PLRKIT contact cartridges provide switching to 200 mA @ 30 VDC. These contacts are matched with standard control (10 A) contact cartridges for low energy switching applications.
- Overlapping Contact 700-POLKIT contact cartridges provide (10 A) switching capabilities with the same rating as the standard contact. These cartridge used in pairs operate with the N.O. contact closing before the N.C. contact opens on pick-up and vice versa on the drop-out.

### AC-Operated Relays - In-stock Contact Configurations

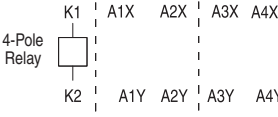
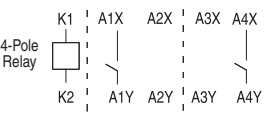
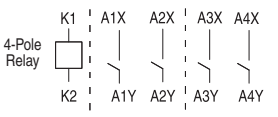
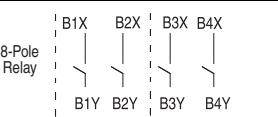
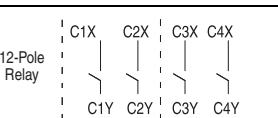
Photo	Contacts	Contact Arrangement and Markings	Open Type, DIN Rail, or Relay Rail Mount (700-MP)		
	N.O. (1)		120V AC	240V AC	480V AC
	0		700-P000A1	—	—
	2		700-P200A1	—	—
	4		700-P400A1	700-P400A2	700-P400A4
	8		700-P800A1	—	—
	12		700-P1200A1	—	—

(1) Factory assembled N.O. contacts can be easily to N.C. in the field.

### DC-Operated Relays - In-stock Contact Configurations

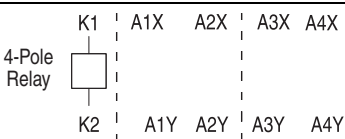
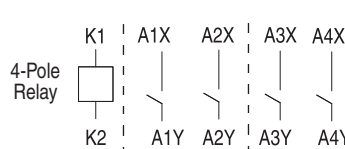
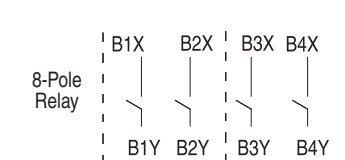
Photo	Contacts	Contact Arrangement and Markings	Open Type Relay Rail Mount (2)	
	N.O. (1)		24V DC	120V DC
			Cat. No.	Cat. No.
	0		700DC-P000Z24	—
	4		700DC-P400Z24	700DC-P400Z1
	8		700DC-P800Z24	—

(1) Factory assembled N.O. contacts can be easily to N.C. in the field.

(2) For DIN Rail mounting, order Cat. No. 700-DRA.

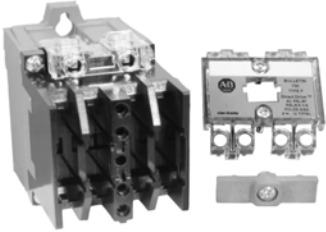

**Base Blank Relay - Factory Assembled**

Photo	Type of Control Circuit	Cat. No.
	AC	700-P000⊗
	DC	700DC-P000⊗

**⊗ AC Coil Voltage Code**

Hz	24	110	115-120	200-208	230-240	277	460-480	575-600
50	—	A1	—	—	—	—	—	—
60	A24	—	A1	A20	A2	A27	A4	A6

**⊗ DC Coil Voltage Code**

24	48	72	115-125	230-250	575-600
Z24	Z48	Z72	Z1	Z2	Z6

### Master (20 A) and Heavy Duty (35 A) Contact Cartridge Options

Follow this process to order a relay that utilizes: 20 A master contact cartridges or 35 A heavy duty contact cartridges.

**Base Blank Relay** + **Cartridge Kit** + **Adder Decks** + **Coil**

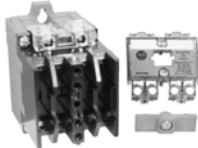
Base Blank Relay	Type of Control Circuit	Cat. No.
	AC	700-P000A1
	DC	700DC-P000Z24

+

#### Contact Cartridge Kits

Photo	Description	Contents	Continuous Carrying Current [A]	Cat. No.
	<b>Master Contact Cartridge</b> AC Rating Twice NEMA A600 DC Rating NEMA N150 P600	4 Master Cartridges (Cat. No. 700-CPM)	20	700-PMCKIT
	Heavy Duty Contact Kit	4 Master Cartridges and two sets of jumper terminals, rating label (makes two 35 A poles)	35	700-PHDKIT

+

#### Adder Decks

Do you have more than four circuits or more than two 35 A circuits in the relay?

	Device Description	Adder Decks Required Cat. No.	Additional Cartridge Kits Required
	8 Pole Device	700-PB00	1 additional kit
	12 Pole Device	700-PB00 700-PC00 (Qty 1 of each)	2 additional kits

**EXAMPLE** Heavy Duty circuit (35 A) application that requires 4 circuits and 240 AC control circuit:

- Base Unit: Cat. No. 700-P000A1
- Cartridge Kits: Cat. No. 700-PHDKIT - Qty 2 (Each kit makes two circuits)
- Adder Deck: Cat. No. 700-PB00
- Coil: Cat. No. PA254

**IMPORTANT** If required, see [Operating Coils](#) for coil selection.

### Logic Reed and Overlapping Contact Cartridge Option

Follow this process to order a relay that utilizes: low energy contact cartridges or overlapping late make or late break cartridges.

**Base Blank Relay** + **Cartridge Kit** + **Adder Decks** + **Coil**

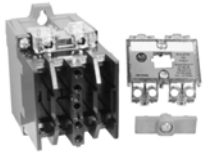
Base Blank Relay	Type of Control Circuit	Cat. No.
	AC	700-P000A1
	DC	700DC-P000Z24

+

### Contact Cartridge Kits

Photo	Description	Contents	Continuous Carrying Current [A]	Cat. No.
	<b>Logic Reed Cartridge for Low Energy Circuits</b> 150V AC 500 mA 25 VA Max. 30V DC 200 mA 6W Max.	2 Logic Reed Cartridges (Cat. No. 700-CPR)	500 mA 150V AC 200 mA 30V DC	700-PLRKIT
		2 Standard Cartridges (Cat. No. 700-CP1)	10	
	<b>Overlap Contact Cartridges Overlapping</b> Used in pairs. N.O. contact closes before N.C. contact opens on pick-up and vice versa on drop-out.	4 Overlapping Cartridges (Cat. No. 700-CP11Z)	10	700-POLKIT

+

### Adder Decks

Do you have more than four circuits or more than two 35 A circuits in the relay?

	Device Description	Adder Decks Required Cat. No.	Additional Cartridge Kits Required
	8 Pole Device	700-PB00	1 additional kit
12 Pole Device	700-PB00 700-PC00 (Qty 1 of each)	2 additional kits	



**EXAMPLE** Logic Reed and Overlapping Contact Cartridge Option:

- Low Voltage Circuit 24V DC less than 200 mA
- Base Unit: Cat. No. 700-P000A1
- Cartridge Kits: Cat. No. 700-PLRKIT - Qty 1
- Coil: Cat. No. PA254

**IMPORTANT** If required, see Operating Coils for coil selection.



**Accessories - 700-P Relays**

**Adder Decks**

Photo	Description	No. of N.O. Contacts	Continuous Carrying Current [A]	Arrangement	Cat. No.
	Second Deck (0-pole)	0	—	B1X   B2X   B3X   B4X  B1Y   B2Y   B3Y   B4Y	700-PB00
	Second Deck (4-pole)	4	10	B1X   B2X   B3X   B4X               /   /   /   / B1Y   B2Y   B3Y   B4Y	700-PB40
	Third Deck (0-pole)	0	0	C1X   C2X   C3X   C4X  C1Y   C2Y   C3Y   C4Y	700-PC00
	Third Deck (4-pole)	4	10	C1X   C2X   C3X   C4X               /   /   /   / C1Y   C2Y   C3Y   C4Y	700-PC40

## Operating Coils

### Bulletin 700-P Relays — Bulletin 700-PLL-PKLL Mechanical Latch Attachments





	Coil Volts <sup>(2)</sup>	Bulletin 700-P, 2...12-pole, AC control		Bulletin 700-PLL-PKLL AC Mechanical Latch Attachment			Bulletin 700DC-P 2...12-pole, DC control
		60 Hz	50 Hz	60 Hz	50 Hz	DC	—
	24	PA013	PA407	PL013	PL407	PM714	PD714
	48	—	—	—	—	PM724	PD724
	72	—	—	—	—	PM730	PD730
	110 <sup>(3)</sup>	—	PA236	—	PL236	—	PD733 (100...110)
	115...120 <sup>(3)</sup>	PA236	—	PL236	—	—	—
<b>110...115<sup>(1)</sup> Bulletin 700-P Operating Coil</b>	—	PA322	—	PL322	—	—	—
	115...125	—	—	—	—	PM735	PD735
	120\$	PA322	—	PL322	—	—	—
	130...140	—	—	—	—	—	—
	200...208	PA249	—	—	—	—	—
	220...230	PA251	PA339	—	—	—	—
	230...240	PA254	PA342	PL254	—	—	—
	230...250	—	—	—	—	PM748	PD748
	277	PA260	—	—	—	—	—
	380	—	PA354	—	—	—	—
	415	—	PA357	—	—	—	—
	440...460	—	PA360	—	—	—	—
<b>Bulletin 700-PL Unlatch Coil and Magnet Assembly</b>	460...480	PA273	—	—	—	—	—
	500	—	—	—	—	—	—
	575...600	PA278	—	—	—	—	PD758

(1) This coil is optimized for 110...115V, 50 Hz applications and will operate satisfactorily at 120V, 60 Hz.

(2) Coils for AC relays cannot be used in DC relays and vice versa.

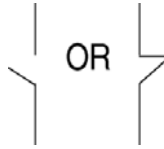
(3) This coil is optimized for 115...120V, 60 Hz applications and will operate satisfactorily at 110V, 50 Hz.

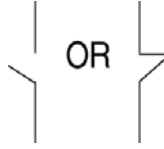
**Contact Cartridges (Convertible from N.O. to N.C. and N.C. to N.O.)**

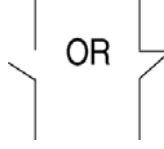
Photo	Description	Continuous Carrying Current [A]	Arrangement	Pkg. Quantity	Cat. No.
	<b>Standard Contact Cartridge</b> AC Rating NEMA A600 DC Rating NEMA P600	10		1	700-CP1
	<b>Overlap Contact Cartridges</b> Overlapping Used in pairs. N.O. contact closes before N.C. contact opens on pick-up and vice versa on drop-out. <sup>(1)</sup>	AC Rating NEMA A600 DC Rating NEMA P150 125V DC, 138 VA Make and Break		10 5	2
	<b>Master Contact Cartridge</b> AC Rating Twice NEMA A600 DC Rating NEMA N150 P600	20		1	700-CPM
	<b>Logic Reed Cartridge for Low Energy Circuits</b> 150V AC 500 mA 25 VA Max. 30V DC 200 mA 6W Max. <sup>(2)</sup>	Maximum 150V AC		1	700-CPR
		Maximum 30V DC			

(1) Not Direct Drive

(2) The 700-CPR Logic Reed cartridge must be installed only in the 2nd deck (B1X - B4X, B1Y - B4Y position) or 3rd deck (C1X - C4X, C1Y - C4Y position) of the Bulletin 700 Type P relay. It is not recommended that the 700-CPR cartridge be installed in the single deck (A1X - A4X, A1Y - A4Y position) because this may lead to improper operation.

Electrically Held Relays — Typical Wiring Diagrams

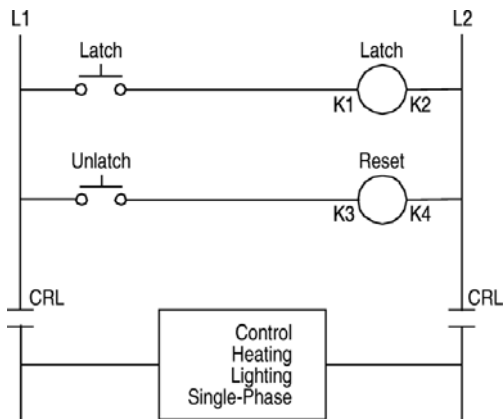
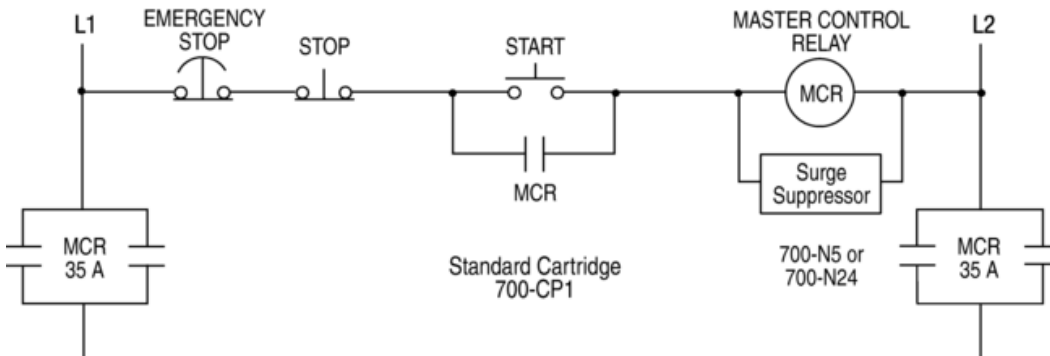
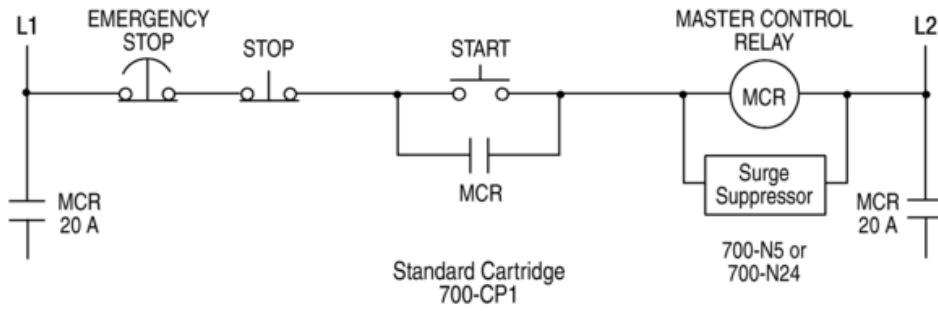

### Pneumatic Time-Delay Unit

- Timing Range — 0.1...60 s
- 0, 2, or 4 instantaneous contacts
- Two timed contacts — both ON Delay or both OFF Delay
- Convertible from ON Delay to OFF Delay and vice versa
- Standard contact cartridges rated NEMA A600 (AC) and P600 (DC)
- Master contact cartridges rated 2X NEMA A600 (AC) and N150 P600 (DC)

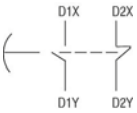
Photo	Operating Mode	No. of Timed Contacts <sup>(1)</sup>		Continuous Carrying Current [A]	Arrangement	Timing Range	Open Type Without Enclosure <sup>(2)</sup>
		N.O.	N.C.				Cat. No.
	On-Delay Off-Delay	1	1	10		0.1...60 s	700-PT
				20			700-PKT

(1) In addition to instantaneous cartridges on the relay  
 (2) Mounts on 4-pole Bulletin 700-P or -PK relay or 2-pole Bulletin 700-PH relay.

### Mechanical Latch Units

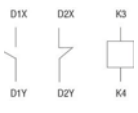
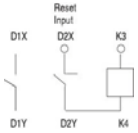
Photo	Description	Arrangement	Continuous Carrying Current [A]	Cat. No.
	AC-Operated Latch Units		No cartridge	700-PLL⊗
			10	700-PLL11⊗
			20	700-PKLL11⊗
	DC-Operated Latch Units		No cartridge	700DC-PLL⊗
			10	700DC-PLL10⊗
			20	700DC-PKLL10⊗

#### ⊗ AC Coil Voltage Code

The Cat. No. as listed is incomplete. Select a voltage suffix code from the table below to complete the Cat. No. Example: Cat. No. 700-PLL⊗ becomes Cat. No. 700-PLLA1.

Hz	24	110	110-115	115-120	120	200-208	220-230	230-240	277	347	380	415	440-480	460-480	500	575-600
50	B24	A1 <sup>(1)</sup>	B11 <sup>(2)</sup>	—	—	—	—	—	—	—	—	—	—	—	—	—
60	A24	—	—	A1 <sup>(1)</sup>	B11 <sup>(2)</sup>	—	—	A2	—	—	—	—	—	—	—	—

(1) Optimized for 115...120V, 60 Hz. Operates satisfactorily at 110V, 50 Hz.  
 (2) Optimized for 110...115V, 50 Hz. Operates satisfactorily at 120V, 60 Hz.





#### ⊗ DC Coil Voltage Code

The Cat. No. as listed is incomplete. Select a voltage suffix code from the table below to complete the Cat. No. Example: Cat. No. 700DC-PLL⊗ becomes Cat. No. 700DC-PLLZ24.



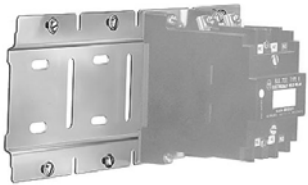

24	48	64	72	115-125	230-250	575-600
Z24	Z48	—	Z72	Z1	Z2	Z6



## Accessories

Photo	Description	Relays per Strip	Pkg. Quantity	Cat. No.
	<b>Relay Rail</b> Simplifies panel layout. These indexed strips are easily cut to the required length and bolted, riveted, or spot-welded in place. Relays are installed adjacent to one another on the mounting strip with the captive mounting screws provided. Rows of relays on Relay Rail form their own wiring trough. Can be used with the following relays: 700P, 700DC-P, 700S-P, 700N, 700-R, 700-RTC	4	5	700-MP4
		8	5	700-MP8
		12	5	700-MP12
		16	5	700-MP16
	<b>DIN Rail Adapter</b> Can be used with the following relays: Bulletin 700-P, 700DC-P, 700S-P, 700-N, 700-R, 700-RTC		1	700-DRA
	<b>DIN (#3) symmetrical hat rail</b> 35 x 7.5 x 1 m		10	199-DR1
	<b>Type 1 Enclosure</b> — Use for all Bulletin 700-P relays except 10- and 12-pole DC relays or 6-pole DC Bulletin 700-PH relays.		1	700-N31
	<b>Type 4/4X Enclosure</b> — For 2- and 4-pole Bulletin 700-P, -N, and -R relays and 2-pole heavy duty relays.		1	700-N39
	<b>Type 7 &amp; 9 Enclosure</b> — For 2- and 4-pole Bulletin 700-P, -N, and -R relays and 2-pole heavy duty relays. 1 conduit hub; top and bottom.		1	700-N33

**Accessories**

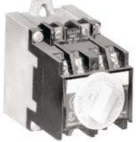
Photo		Description	Pkg. Quantity	Cat. No.	
		<p><b>Surge Suppressors (RC Circuit)</b> — Surge suppressors reduce the high transient voltages generated when the coil circuit is opened. These suppressors can be used with Bulletin 700-P, -PH, -PK, and -N relays, and other electromechanical devices. They contain a resistor and capacitor. Maximum ratings: 150V, AC or DC, 35 VA. Cat. No. 700-N5 requires 1 in. additional depth of enclosure.</p>	Mounting behind relay	1	700-N5
			Mounting on coil terminal	1	700-N24
		<p><b>Surge Suppressor</b> When the circuit to a DC operating coil is opened, the inductive energy stored in the coil can generate very high transient voltages. With the addition of the appropriate surge suppressor, the stored energy is absorbed and dissipated limiting the voltage spikes. A surge suppressor is not required with AC 700-R or -RM relays because the AC operating coil transients are suppressed by a full wave rectifier connected to the coil.</p>	24...48V AC/DC	1	199-FSMA9
			50...120V AC/DC	1	199-FSMA10
			130...250V AC/DC	1	199-FSMA11
			<p><b>Diode Surge Suppressor</b> — for 6...300V DC voltage coils. Used on Bulletin 700-P, -PH, -PK, -N, -F, and -R relays.</p>		1
		<p><b>35 A Jumper Kit</b> – CSA Approved, UL Listed This 35 A Jumper Kit can be used with any Bulletin 700-P and -PK AC or DC relay, Time-Delay relay or Latch Unit equipped with 20 A Master Cartridges. It does not require any additional panel space. Jumper Kit terminals are designed for one #8 AWG wire or two #10 AWG wires. When connecting the two 20 A Master Cartridges in parallel, it is important that they be the same configuration (Normally Open or Normally Closed). Jumpers can be added to any contact cartridge location on a relay except the two center poles because of the wide spacing. An adhesive label is included with each kit listing the contact ratings.</p>		1	700-CPH
		<p><b>Jumpers</b> (Not applicable for Bulletin 700-PH or -PK relays) – For connection between a middle pole and an outer pole on the left or right side of the relay.</p>	<p><b>Jumper</b> – For outer poles</p>	50	700-N3
Cat. No. 700-N3	Cat. No. 700-N4				<p><b>Jumpers</b> (Not applicable for Bulletin 700-PH or -PK relays) – For connection between two middle poles.</p>
		<p><b>Check Out Tool</b> — Mechanically maintains the Bulletin 700-P, -PH, or -PK relay in the energized position for troubleshooting purposes.</p>		1	700-N23
		<p><b>Adapter Plate</b> — Simplified relay conversion. Allows you to use the existing mounting holes when you replace a Bulletin 700-B, -BR, -BX, or -D relay with a Bulletin 700-P, -PH, or -PK relay.</p>			700-N34

## IP 2X Finger-Safe Cover Accessories

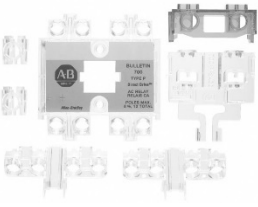
Photo	Description	Pkg. Quantity	Cat. No.
	<b>Top Covers (Covering Top Level Contact Screws)</b>		
	IP2X Top Cover for 700-P	1	700-PFSC
	Timer Top Cover Kit	1	700-PFSTC
	Latch Top Cover Kit (for Relays with Mechanical Latch Attachment)	1	700-PFSLCK
	Timer Top Cover Kit, (for Master Cont. Relays with Pneumatic Timer)	1	700-PFSKTC
	Latch Top Cover Kit (for Master Cont. Relays with Mechanical Latch)	1	700-PFSKLCK
	<b>Deck Covers (Covering all terminals not on top deck, only for multi-deck relays)</b>		
	IP2X Deck Cover for all AC & DC Relays in the 700P Range	1	700-PFSDEK
	<b>Coil Covers</b>		
	IP2X Coil Cover for all AC Relays in the 700P Range	1	700-PFSACC
IP2X Coil Cover for all DC Relays in the 700P Range	1	700-PFSDCC	

### Specifications - 700-P Relays

Type	Standard Cartridge						Master Cartridge						Heavy duty							
Bulletin No.	700-P						700-PMCKIT						700-PHDKIT							
<b>Electrical</b>																				
<b>Contact Rating Continuous</b>	10 A @ 600V AC ; 5 A @ 600V DC						20 A @ 600V AC; 10 A @ 600V DC						35 A @ 600V AC; 20 A @ 600V DC							
<b>Ratings Make/Break</b>	<b>AC</b>	NEMA A600						2 x NEMA A600						2 x NEMA A600						
	<b>DC</b>	NEMA P600						N150 P600						N150 P600						
<b>Additional Contact Ratings for AC single-phase loads</b>	—						3 Hp @ 240V AC - N.O. 2 Hp @ 240V AC - N.O./N.C. 1 Hp @ 120V AC - N.O./N.C. 20 A Resistive Heating to 600V AC 20 A Tungsten Lighting Load to 480V AC						5 Hp @ 240V AC - N.O. 3 Hp @ 240V AC - N.O./N.C. 2 Hp @ 120V AC - N.O./N.C. 35 A General Use At 0.75 PF to 600V AC 35 A Tungsten Lighting Load to 480V AC							
<b>DC Current Ratings Make/Break</b>	Cartridge Cat. No. 700-CP1						Cartridge Cat. No. 700-CPM						Cartridge Cat. No. 700-CPH							
<b>DC Switching Inductive Load</b>	Contacts in Series	Volts DC																		
			24	64	125	250	500	600	24	64	125	250	500	600	24	64	125	250	500	600
			5 A	2.2 A	1.1 A	.55 A	.24 A	.2 A	10 A	5 A	2.2 A	.55 A	.24 A	.2 A	10 A	5 A	2.2 A	.55 A	.24 A	.2 A
		1	10 A	10 A	5 A	2 A	.7 A	.5 A	20 A	10 A	5 A	2 A	.7 A	.5 A	20 A	10 A	5 A	2 A	.7 A	.5 A
		2	—	—	7 A	3 A	1.5 A	1.0 A	—	15 A	7 A	3 A	1.5 A	1.0 A	—	15 A	7 A	3 A	1.5 A	1.0 A
3	—	—	10 A	5 A	2.5 A	1.5 A	—	20 A	10 A	5 A	2.5 A	1.5 A	—	20 A	10 A	5 A	2.5 A	1.5 A		
<b>Coil Voltage Range</b>	<b>AC</b>	85...110%						85...110%						85...110%						
	<b>DC</b>	80...110%						80...110%						80...110%						
	<b>Battery</b>	85...115%						85...115%						85...115%						
<b>Coil Consumption</b>	<b>AC</b>		50 Hz			60 Hz			50 Hz			60 Hz			50 Hz			60 Hz		
		Inrush	132VA <sup>(2)</sup>			138VA <sup>(2)</sup>			132VA <sup>(2)</sup>			138VA <sup>(2)</sup>			132VA <sup>(2)</sup>			138VA <sup>(2)</sup>		
	Sealed	19.3VA <sup>(2)</sup>			19VA <sup>(2)</sup>			19.3 VA <sup>(2)</sup>			19VA <sup>(2)</sup>			19.3VA <sup>(2)</sup>			19VA <sup>(2)</sup>			
	<b>DC</b>	Inrush	12.7VA <sup>(2)</sup>						12.7VA <sup>(2)</sup>						12.7VA <sup>(2)</sup>					
Sealed		12.7VA <sup>(2)</sup>						12.7VA <sup>(2)</sup>						12.7VA <sup>(2)</sup>						
<b>PLL - PKLL AC Latch Unit</b>	Inrush	15VA <sup>(2)</sup>			15.6VA <sup>(2)</sup>			5VA <sup>(2)</sup>			15.6VA <sup>(2)</sup>			15VA <sup>(2)</sup>			15.6VA <sup>(2)</sup>			
	Sealed	5.4VA <sup>(2)</sup>			5.5VA <sup>(2)</sup>			5.4VA <sup>(2)</sup>			5.5VA <sup>(2)</sup>			5.4VA <sup>(2)</sup>			5.5VA <sup>(2)</sup>			
<b>PLL - PKLL DC Latch Unit</b>	Unlatch	35VA <sup>(2)</sup>						35VA <sup>(2)</sup>						—						
	Intermittent	35 W <sup>(2)</sup>						35 W <sup>(2)</sup>						—						
<b>Reset Time</b>	PT – PKT	75 ms						75 ms						—						
<b>Minimum Pulse</b>	PLL–PKLL	75 ms						75 ms						—						
<b>Mechanical</b>																				
<b>Operating Time</b>	Pickup	AC – 10...20 ms / DC – 30...50 ms						AC – 10...20 ms / DC – 30...50 ms						AC – 10...20 ms / DC – 30...50 ms						
	Dropout	AC – 10...20 ms / DC – 20...33 ms						AC – 10...20 ms / DC – 20...33 ms						AC – 10...20 ms / DC – 20...33 ms						
<b>Mechanical Life</b>	10 million operations																			
<b>Construction</b>																				
<b>Contact Arrangement</b>	Up to 12 Poles, Convertible to N.O. or N.C. (8 N.C. Maximum)												Up to 6 Poles, Convertible to N.O. or N.C. (4 N.C. Maximum)							
<b>Contact Material</b>	Silver Nickel						Silver Cadmium Oxide						Silver Cadmium Oxide							
<b>Mounting</b>	Panel, Strip Mount, or DIN Rail Horizontal Mounting Recommended																			
<b>Environmental</b>																				
<b>Temperature</b>	<b>Operating</b> <sup>(1)</sup>	–20...+65 °C (–4...+149 °F)						–20...+65 °C (–4...+149 °F)						–20...+65 °C (–4...+149 °F)						
	<b>Storage</b>	–40...+65 °C (–40...+149 °F)						–40...+65 °C (–40...+149 °F)						–40...+65 °C (–40...+149 °F)						
<b>Wire Terminations</b>																				
<b>Wire size per UL/CSA</b>	#18 AWG... (2) #12 AWG																			
<b>Tightening Torque</b>	8...12 lb·in (0.9...1.4 N·m)																			
<b>Standards Compliance</b>	UL 508, CSA C22.2, No. 14, EN/IEC 60947-1, -5-1																			
<b>Certifications</b>	cULus Listed (File No. E14840, Guide NKCR/NKCR7), CE Marked, ABS																			

(1) Temperature inside the panel.

(2) Average value for all coils within range. For values on a specific coil voltage, contact your local Rockwell Automation sales office or Allen-Bradley distributor.

International Symbol for Mechanically Linked Contacts



### Dimensions - 700-P Relays with standard, master contact, or heavy-duty contact cartridge

Approximate dimensions are shown in millimeters (inches). Dimensions are not intended for manufacturing purposes.

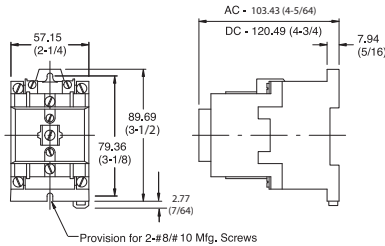

**2- and 4-pole 700-P Relay**  
Approx Shipping Weight: AC – 0.68 kg (1.5 lb), DC – 1.34 kg (2.95 lb)

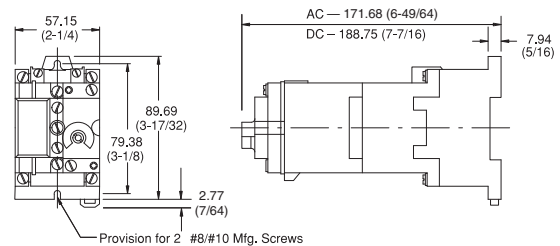

**2- and 4-pole 700-P with Pneumatic Time Delay Attachment**  
Approx Shipping Weight: AC – 0.85 kg (1.88 lb), DC – 1.5 kg (3.33 lb)

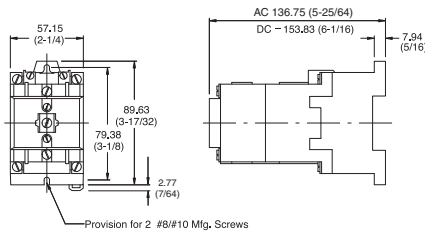

**6- and 8-pole 700-P Relay with one -PB adder deck**  
Approx Shipping Weight: AC – 0.79 kg (1.75 lb), DC – 1.45 kg (3.20 lb)

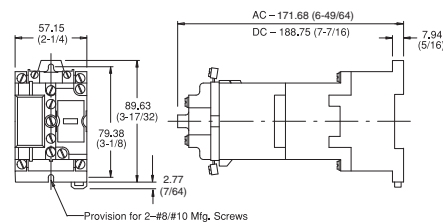

**700-P Relay with Mechanical Latch Attachment**  
Approx Shipping Weight: AC – 0.97 kg (2.13 lb), DC – 1.62 kg (3.58 lb)

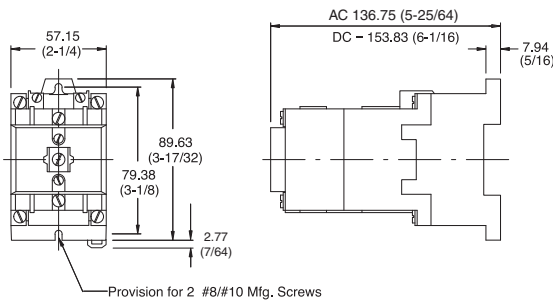

**700-P Relay, up to 12 poles with -PB and -PC adder decks**  
Approx Shipping Weight: AC – 1.02 kg (2.25 lb), DC – 1.68 kg (3.7 lb)

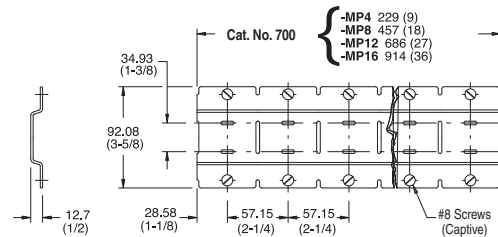

**Relay Rail for 700-P, -N, -NM, -R, -RM, -RT, -RTA Relays**  
Secure the mounting strip with two screws at each end relay position.  
Use a minimum of one screw at the 3rd, 5th, 7th, etc., relay positions.  
Alternate between upper and lower horizontal slots.

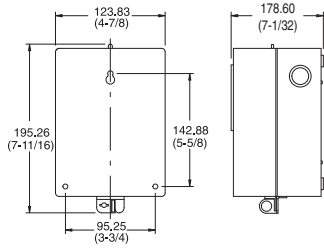

Cat. No. 700-N31, Type 1 Enclosure for  
700-P, -RTC Relays  
Approximate Shipping Weight: 1.26 kg (2.8 lb)

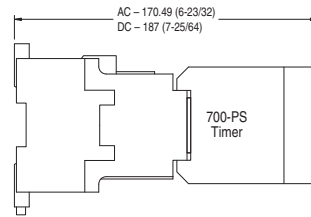

700-PS Timer Mounted on a 700-P Relay  
Approximate Shipping Weight: AC – 0.68 kg (1.5 lb) without 700-PS,  
DC – 1.34 kg (2.9 lb) without 700-PS

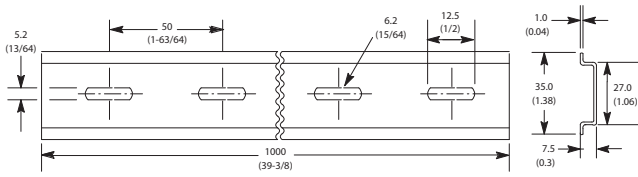

Cat. No. 199-DR1 DIN Mounting Rail Series B  
Cat. No. 199-DR4 DIN Mounting Rail Series B Has No Mounting Holes

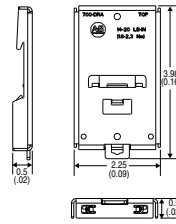

DIN Rail Adapter

## 700S-P and 700S-PK — Heavy-Duty Safety Control Relays

- Mechanically linked contacts meet IEC 947-5-1-L
- 2...12 poles – all mechanically linked
- Red cover for easy identification of safety circuits
- Tamper resistant cover helps prevent changes which could jeopardize safety
- IEC mechanically linked contacts symbol displayed on front
- Visual indication of contact state
- Ideal for use in safety circuits

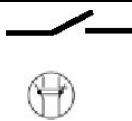
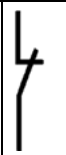

### 700S-P (10 A) Safety Control Relays — AC and DC Coil Voltages

Contacts		AC Coils		24V DC Coils			
		Open Type	Panel Mount Relay Rail Mount	Open Type	Panel Mount Relay Rail Mount	Open Type	DIN Rail Mount
		Cat. No.		Cat. No.		Cat. No.	
N.O.	N.C.						
3	1	700S-P310⊗		700S-DCP310Z24		700S-DCP310DZ24	
2	2	700S-P220⊗		700S-DCP220Z24		700S-DCP220DZ24	
7	1	700S-P710⊗		700S-DCP710Z24		700S-DCP710DZ24	
6	2	700S-P620⊗		700S-DCP620Z24		700S-DCP620DZ24	
5	3	700S-P530⊗		700S-DCP530Z24		700S-DCP530DZ24	
4	4	700S-P440⊗		700S-DCP440Z24		700S-DCP440DZ24	
3	5	700S-P350⊗		700S-DCP350Z24		700S-DCP350DZ24	
10	2	700S-P1020⊗		700S-DCP1020Z24		700S-DCP1020DZ24	

### ⊗ AC Coil Voltage Code<sup>(1)</sup>

The Cat. No. as listed is incomplete. Select a coil voltage code from the table below to complete the Cat. No. Example: Cat. No. 700S-P310 becomes Cat. No. 700S-P310A1 for a 120V AC coil.

[V]	24	115-120	230-240	460-480
60 Hz	A24	A1	A2	A4

IEC 947-5-1 Annex L has 2 requirements for a relay to meet for mechanically linked contacts:

- 1.) If a N.O. contact welds, all the N.C. contacts will remain open and meet a 2500V impulse test.
- 2.) If a N.C. contact welds, all the N.O. contacts will remain open and meet a 2500V impulse test.

700S-P and 700S-DCP relays meet these requirements including the 2500V impulse test.

The relays shown on this page are shipped from the factory with the 700-CPS safety cartridge installed and cannot be converted to N.O. or N.C. in the field.

**700S-PK (20 A) Safety Control Relays**

<b>Contacts</b>		<b>Coil Voltage</b>	<b>Cat. No.</b>
<b>N.O.</b>	<b>N.C.</b>		
7	1	110V AC	700S-PK710A1
6	2	110V AC	700S-PK620A1
5	3	110V AC	700S-PK530A1
4	4	110V AC	700S-PK440A1
3	5	110V AC	700S-PK350A1
10	2	110V AC	700S-PK1020A1
3	1	110V AC	700S-PK310A1
7	1	24V DC	700S-DCPK710Z24
6	2	24V DC	700S-DCPK620Z24
5	3	24V DC	700S-DCPK530Z24
4	4	24V DC	700S-DCPK440Z24
3	5	24V DC	700S-DCPK350Z24
10	2	24V DC	700S-DCPK1020Z24
3	1	24V DC	700S-DCPK310Z24



## Specifications - 700S-P Relays

Type		700S-P					
<b>Electrical</b>							
Contact Rating Continuous		10 A @ 600V AC 5 A @ 600V DC					
Ratings Make/ Break	AC	NEMA A600					
	DC	NEMA P600					
Minimum Contact Switching Ratings		10V, 50 mA					
DC Switching Inductive Load	Contacts in Series	Volts DC					
		24V	64V	125V	250V	500V	600V
	1	5 A	2.2 A	1.1 A	0.55 A	0.24 A	0.2 A
	2	10 A	10 A	5 A	2 A	0.7 A	0.5 A
	3	—	—	7 A	3 A	1.5 A	1.0 A
4	—	—	10 A	5 A	2.5 A	1.5 A	
Contact Electrical Life— Resistive Loads		1.5 million operations at 10A break at 120V AC 14 million operations at 1A break at 120V AC 6 million operations at 1A break at 24V DC					
Coil Voltage Range <sup>(1)</sup>	AC	85...110%					
	DC	80...110%					
	Battery Charging	85...115%					
Coil Consumption		50 Hz			60 Hz		
AC	Inrush	132 VA			138 VA		
	Sealed	19.3 VA			19 VA		
DC	Inrush	12.7 W					
	Sealed	12.7 W					
<b>Mechanical</b>							
Mechanically Linked Contacts		All contacts are mechanically linked per IEC 947- 5-1 annex L for 2 to 12 poles					
Operating Time	Pickup	AC – 10...20 ms DC – 30...50 ms					
	Dropout	AC – 10...20 ms DC – 20...33 ms					
Mechanical Life		10 million operations					
<b>Construction</b>							
Contact Arrangement		2...12 Poles, Double Break Contacts N.O. or N.C. (8 N.C. Maximum)					
Contact Material/Design		Silver Nickel/Bifurcated					
Mounting		Panel mount or mount on 700-MP Relay or DIN Rail Horizontal Mounting Recommended					
<b>Environmental</b>							
Operating Temperature <sup>(2)</sup>		-20...+65 °C (-4...+149 °F)					
Storage Temperature		-40...+65 °C (-40...+149 °F)					
<b>Wire Terminations</b>							
Wire size per UL/CSA		#18 AWG... (2) #12 AWG					
Tightening Torque		8...12 lb•in (0.9...1.4 N•m)					
Standards Compliance		UL 508, CSA C22.2, No. 14, EN/IEC 60947-1, -5-1					
Certifications		cULus Listed (File No. E14840, Guide NKCR/NKCR7), CE Marked, ABS					

(1) Coil voltage required for proper operation (percent of rated coil voltage).

(2) Temperature inside the panel.

**Specifications - 700S-PK Relays**

Type		700S-PK					
<b>Electrical</b>							
Contact Rating Continuous		20 A @ 600V AC 10 A @ 600V DC					
Ratings Make/ Break	AC	NEMA A600					
	DC	NEMA P600					
Additional Contact Ratings for AC Single-Phase Loss		3 Hp @ 240V AC - N.O. 2 Hp @ 240V AC - N.O./N.C. 1 HP @ 120V AC - N.O./N.C. 20 A resistive heating to 600V AC 20 A Tungsten lighting load to 480V AC					
DC Current Ratings Make/Break		Cartridge Cat. No. 700-CMS					
DC Switching	Contacts in Series	Volts DC					
		24V	64V	125V	250V	500V	600V
	1	10 A	5 A	2.2 A	0.55 A	0.24 A	0.2 A
	2	20 A	10 A	5 A	2 A	0.7 A	0.5 A
	3	—	15 A	7 A	3 A	1.5 A	1.0 A
4	—	20 A	10 A	5 A	2.5 A	1.5 A	
Coil Voltage Range <sup>(1)</sup>	AC	85...110%					
	DC	80...110%					
	Battery Charging	85...115%					
Coil Consumption		50 Hz			60 Hz		
AC	Inrush	132 VA			138 VA		
	Sealed	19.3 VA			19 VA		
DC	Inrush	12.7 W					
	Sealed	12.7 W					
<b>Mechanical</b>							
Mechanically Linked Contacts		All contacts are mechanically linked per IEC 947-5-1 annex L for 2 to 12 poles					
Operating Time	Pickup	AC – 10...20 ms, DC – 30...50 ms					
	Dropout	AC – 10...20 ms, DC – 20...33 ms					
<b>Construction</b>							
Contact Arrangement		2...12 Poles, Double Break Contacts N.O. or N.C. (8 N.C. Maximum)					
Contact Material/Design		Silver Cadmium Oxide					
Mechanical (Mechanically-Linked Contacts)		All contacts, are mechanically linked per IEC 947-5-1 Annex L for 2 to 12 poles					
Mounting		Panel mount or strip mount recommended					
<b>Environmental</b>							
Operating Temperature <sup>(2)</sup>		-20...+65 °C (-4...+149 °F)					
Storage Temperature		-40...+65 °C (-40...+149 °F)					
<b>Wire Terminations</b>							
Wire size per UL/CSA		#18 AWG...(2) #12 AWG					
Tightening Torque		8...12 lb-in (0.9...1.4 N·m)					
Standards Compliance		UL 508, CSA C22.2, No. 14, EN/IEC 60947-1, -5-1					
Certifications		cULus Listed (File No. E14840, Guide NKCR/NKCR7), CE Marked, ABS					

(1) Coil voltage required for proper operation (percent of rated coil voltage).

(2) Temperature inside the panel.

### Dimensions - 700S-P Relays

Approximate dimensions are shown in millimeters (inches). Dimensions are not intended for manufacturing purposes.

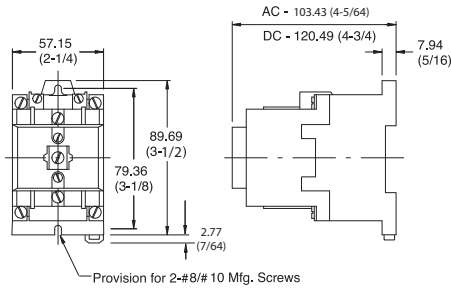

2- and 4-pole 700S-P Relay

Approximate Shipping Weight: AC – 0.68 kg (1.5 lb), DC – 1.34 kg (2.95 lb)

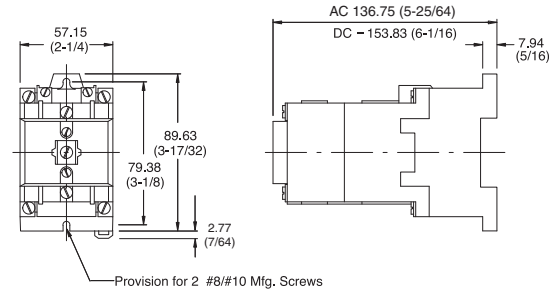

6- and 8-pole 700S-P Relay

Approximate Shipping Weight: AC – 0.79 kg (1.75 lb), DC – 1.45 kg (3.20 lb)

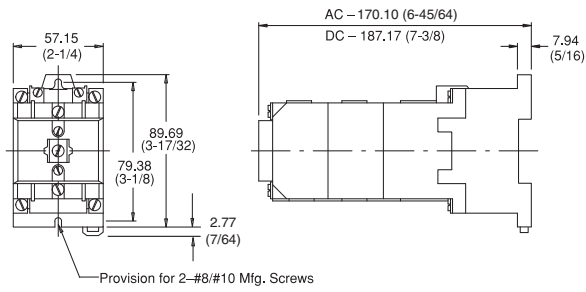

10- and 12-pole 700S-P (Captive)

Approximate Shipping Weight: AC – 1.02 kg (2.25 lb), DC – 1.68 kg (3.7 lb)

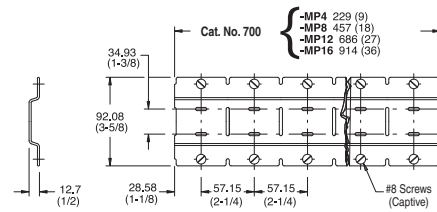

Relay Rail

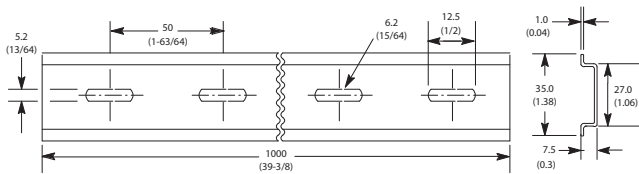

DIN Rail

## 700-N Industrial Relays

- Contact cartridges convertible from N.O. to N.C. and vice versa
- NEMA A300 AC
- 24...250V AC coils
- Pneumatic timing unit
- Solid-state timing unit
- Overlap contacts
- Logic reed contacts
- 4...8-pole

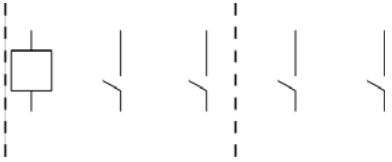
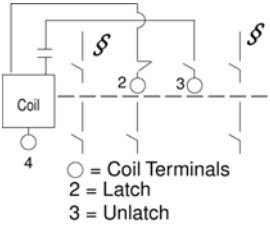

### AC-Operated Relays

Photo	Contacts		Contact Arrangement	Open Type
	N.O.	N.C.		Cat. No.
	4	—	4-Pole Relay 	700-N400⊗
Type NM Relay 2 Poles§	2	—	 ○ = Coil Terminals 2 = Latch 3 = Unlatch	700-NM200⊗

### ⊗ AC Coil Voltage Code

The Cat. No. as listed is incomplete. Select a coil voltage code from the table below to complete the cat. no. Example: Cat. No. 700-N200⊗ becomes Cat. No. 700-N200A24 for 24V 60 Hz. For other coil voltages, contact your local Rockwell Automation sales office or Allen-Bradley distributor.

[V]	24	110	120	208	220	240
50 Hz	—	A1	—	—	A2	—
60 Hz	A24	—	A1	A20	—	A2



### IMPORTANT

- **NORMALLY CLOSED CONTACTS:** Listed relays are supplied with all contacts normally open. These contacts can be readily converted to normally closed in the field.
- **OVERLAP CONTACTS:** Overlap contacts (normally open contact closes before the normally closed contact opens) can be supplied. See for information on kits for field installation of overlap contact cartridges.
- Location of contacts in 2-pole relays
- Permanent Magnet Latch AC Relay. Minimum Operating Time - Type NM - For reliable operation, power to the latch circuit must be maintained for a minimum time of 75 milliseconds and power to the unlatch circuit must be maintained for minimum time of 50 milliseconds.

## Operating Coils

Photo	Coil Voltage	700-N Relay • 2-...8-Pole	
		60 Hz	50 Hz
	24	84AB27	84AB28
	110	84AB01	84AB86
	120	84AB86	—
	208	84AB113	—
	220	84AB06	84AB83
	240	84AB83	—

## 700-NT Pneumatic Timing Unit

Photo	Description	Timed Contacts		Contact Arrangement	Open Type
		N.O.	N.C.		Cat. No.
	<b>Timing Unit Only</b> (for 700-N, 2...4-pole)	1	1	ON-Delay mode is standard. Timer is easily converted to OFF-Delay mode.	700-NT

**Specifications - 700-N Relays**

Attribute		Bul. 700-N		Bul. 700-NT
<b>Electrical Ratings</b>				
Rated Thermal Current $I_{th}$		10 A		
Rated Insulation Voltage		300V		
Contact Rating		10 A @ 300V AC, NEMA A300		
Coil Voltage Range	AC	85...110%		—
	DC	80...110%		—
<b>Coil Consumption</b>				
		<b>50 Hz</b>	<b>60 Hz</b>	—
AC	Inrush	120 VA	133 VA	—
	Sealed	24 VA	20 VA	—
<b>Mechanical</b>				
		<b>AC</b>		—
Max. Operating Time	Pickup	14 ms		—
	Drop Out	13 ms		—
Timing Range		—		0.2...60 s
Repeat Accuracy		—		±15% of setting
Reset Time		—		75 ms
Timing Mode		—		On-Delay — convertible to OFF Delay, up to 2 poles convertible to N.O. or N.C.
<b>Construction</b>				
Contact Arrangement		Up to 8 Poles, Convertible to N.O. or N.C.		—
Contact Material		Silver		Silver
Mounting		Panel or strip mount Horizontal mounting recommended		On relay only
<b>Environmental</b>				
Ambient Temperature (Outside Enclosure)	Operating	-20...+40 °C (-4...+104 °F)		
	Storage	-40...+60 °C (-40...+140 °F)		
Operating Temperature Rise (Inside Enclosure)		+25 °C Max		—
<b>Wire Terminations</b>				
Wire size per UL/CSA		#18 AWG... (2) #12 AWG		
Tightening Torque		8...12 lb•in. (0.9...1.4 N•m)		
Standards Compliance		UL 508, CSA C22.2, No. 14		
Certifications		cULus Listed (File No. E14840, Guide NKCR/NKCR7)		

### Dimensions - 700-N Relays

Approximate dimensions are shown in millimeters (inches). Dimensions are not intended for manufacturing purposes.

Type of Relay	No. of Poles	Open Type Without Enclosure						Approx. Ship. Wt. kg (lbs.)	Type 1 General Purpose Enclosure					Approx. Ship. Wt. kg (lbs.)
		Drawing Number	A Wide	B High	C Deep	D	A Wide		B High	C Deep	D	E		
N	700	2...4	1	57.15 (2-1/4)	88.90 (3-1/2)	82.55 (3-1/4)	79.38 (3-1/8)	0.68 (1-1/2)	107.95 (4-1/4)	185.74 (7-5/16)	103.19 (4-1/16)	146.05 (5-3/4)	85.73 (3-3/8)	1.59 (3-1/2)
	700	6...8	2	57.15 (2-1/4)	88.90 (3-1/2)	106.36 (4-3/16)	79.38 (3-1/8)	0.79 (1-3/4)	112.71 (4-7/16)	228.60 (9)	120.65 (4-3/4)	206.38 (8-1/8)	92.08 (3-5/8)	2.27 (5)
N with Pneumatic Timer	700	2...4	3	57.15 (2-1/4)	88.90 (3-1/2)	138.11 (5-7/16)	79.38 (3-1/8)	0.91 (2)	—	—	—	—	—	—
N with Solid-State Timer	700	2...4	3	57.15 (2-1/4)	88.90 (3-1/2)	160.34 (6-5/16)	79.38 (3-1/8)	1.02 (2-1/4)	—	—	—	—	—	—

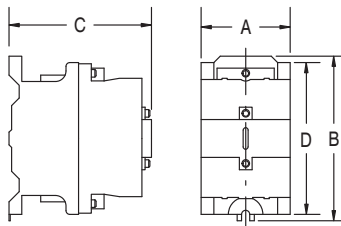

Drawing Number 1

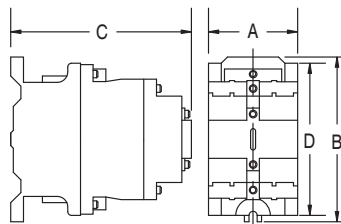

Drawing Number 2

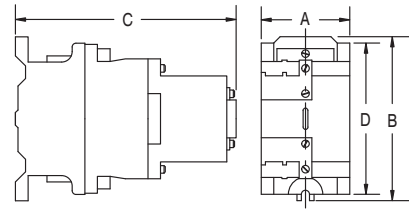

Drawing Number 3

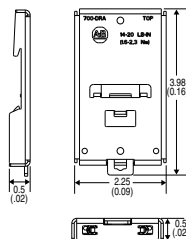
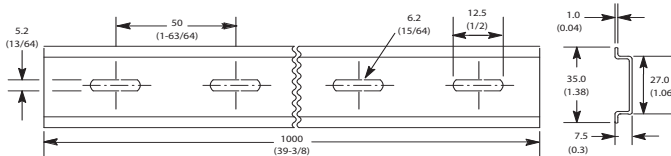
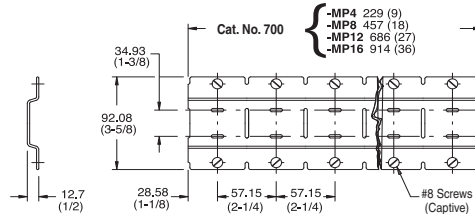
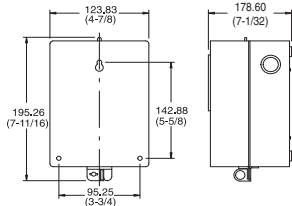

DIN Rail Adapter

## 700-R Sealed Switch Relays

- Sealed contacts
- Extremely long mechanical and electrical life
- Hazardous locations Class 1, Div 2 Groups A, B, C, D
- Harsh environments
- Suitable for applications with shock and vibration
- High reliability circuit integrity



No. of Poles	Electrically Held		Contact Arrangement and Markings‡	AC-Operated Relay Only	DC-Operated Relay Only
	Contacts			Open Type	Open Type
	N.O.	N.C.		Cat. No.	Cat. No.
0	0	0	Relay without Contact	700-R000⊗	700DC-R000⊗
2	2	0		700-R200⊗	700DC-R200⊗
	1	1		700-R110⊗	700DC-R110⊗
	0	2		700-R020⊗	700DC-R020⊗
4	4	0		700-R400⊗	700DC-R400⊗
	3	1		700-R310⊗	700DC-R310⊗
	2	2		700-R220⊗	700DC-R220⊗
	1	3		700-R130⊗	700DC-R130⊗
6	0	4		700-R040⊗	700DC-R040⊗
	6	0		700-R600⊗	700DC-R600⊗
	5	1		700-R510⊗	700DC-R510⊗
	4	2		700-R420⊗	700DC-R420⊗
	3	3		700-R330⊗	700DC-R330⊗
	2	4	700-R240⊗	700DC-R240⊗	
	1	5	700-R150⊗	700DC-R150⊗	
8	0	6	700-R060⊗	700DC-R060⊗	
	8	0	700-R800⊗	700DC-R800⊗	
	7	1	700-R710⊗	700DC-R710⊗	
	6	2	700-R620⊗	700DC-R620⊗	
	5	3	700-R530⊗	700DC-R530⊗	
	4	4	700-R440⊗	700DC-R440⊗	
	3	5	700-R350⊗	700DC-R350⊗	
	2	6	700-R260⊗	700DC-R260⊗	
	1	7	700-R170⊗	700DC-R170⊗	
	0	8	700-R080⊗	700DC-R080⊗	

‡ Arrangement displays all N.O. contacts.  
 ◆ Location of contacts in 6-pole relays.  
 △ Polarity must be observed for DC voltage (700 DC) relays.  
 ◆ Location of contacts in 2-pole relays.

### ⊗ Coil Voltage Code

The Cat. No. as listed is incomplete. Select a voltage code from the table below to complete the Cat. No. Example: Cat. No. 700-R000⊗ becomes Cat. No. 700-R000A24.

Type of Relay	[V]	Coil Volts							
		24	48	110	115-125	120	220	230-250	240
AC	25, 50, 60 Hz	—	—	A1	—	—	A2	—	—
		A24	—	—	—	A1	—	—	A2
DC	—	Z24	Z48	—	Z1	—	—	Z2	—



## Accessories - 700-R Relays

Photo	Description	Pkg. Qty.	Cat. No.				
	<b>Relay Rail</b> Simplifies panel layout. These indexed strips are easily cut to the required length and bolted, riveted, or spot-welded in place. Relays are installed adjacent to one another on the mounting strip with the captive mounting screws provided. Rows of relays on Relay Rail form their own wiring trough. Can be used with the following relays: 700P, 700DC-P, 700S-P, 700N, 700-R, 700-RTC	4 Relays per Strip	700-MP4				
		8 Relays per Strip	700-MP8				
		12 Relays per Strip	700-MP12				
		16 Relays per Strip	700-MP16				
	<b>DIN (#3) symmetrical hat rail</b> 35 x 7.5 x 1 m	10	199-DR1				
	<b>DIN Rail Adapter</b> Can be used with the following relays: 700-P, 700DC-P, 700S-P, 700-N, 700-R, 700-RTC	1	700-DRA				
	<b>Front Deck</b> A front deck can be attached to 700 2-, 3-, or 4-pole AC and DC Type R relays.	Front Deck with one N.O. Contact Cartridge (700-R Relay)	700-RA10				
		Front Deck with one N.C. Contact Cartridge (700-R Relay)	700-RA01				
		Front Deck with one N.O. Contact Cartridge (700-RM Relay)	700-RB10				
		Front Deck with one N.C. Contact Cartridge (700-RM Relay)	700-RB01				
	<b>Contact Cartridges</b> These cartridges are used to increase the number of poles of a relay. A dummy cartridge is also available to fill empty space not occupied by a contact cartridge.	N.O. Contact Cartridge - Green (700-R Relay)	700-CR5				
		N.C. Contact Cartridge - Yellow (700-R Relay)	700-CR6				
		 N.O. N.C.	<b>"DUMMY" Cartridge - Black (700-R Relay)</b> 1 700-CR9				
<table border="1"> <tr> <td>Cat. No. 700-CR5</td> <td>Cat. No. 700-CR6</td> <td>Cat. No. 700-CR9</td> </tr> </table>	Cat. No. 700-CR5	Cat. No. 700-CR6	Cat. No. 700-CR9	<b>Surge Suppressor</b> When the circuit to a DC operating coil is opened, the inductive energy stored in the coil can generate very high transient voltages. With the addition of the appropriate surge suppressor, the stored energy is absorbed and dissipated limiting the voltage spikes. A surge suppressor is not required with AC 700-R relays because the AC operating coil transients are suppressed by a full wave rectifier connected to the coil.	12V DC (700-R Relay)	1	199-FSMA9
Cat. No. 700-CR5	Cat. No. 700-CR6	Cat. No. 700-CR9					
	24V DC (700-R Relay)	1					
	48V DC (700-R Relay)	1					
	115...125V DC (700-R Relay)	1	199-FSMA10				
	230...250V DC (700-R Relay)	1	199-FSMA11				

## Specifications - 700-R

**Application Data** – Because of the inherent characteristics of this device, the normally open contacts may close before the normally closed contacts open on energization and the normally closed contacts may close before the normally open contacts open on de-energization.

## Ratings

AC Voltage					DC Voltage				
NEMA Rating Designation	Voltage	Make	Break	Continuous Carrying Current [A]	NEMA Rating Designation	Volts DC	Make/Break	Continuous Carrying Current [A]	
B300	Up to 300V AC	120V	30	3	5	NEMA P300	46...300	138 VA	5
		240V	15	1.5					
C600	Above 300V AC	480V	3.75	0.375	2.5		5...46	3 A	5
		600V	3.0	0.30					

## Maximum Allowable Off-State Leakage Current

Voltage	Maximum Off-State Leakage Current [mA]
	Type R
24V DC	23
24V AC	23
120V AC	5

## Relay Data

Type	700-R	
Contact Arrangement	Up to 8 poles, available in any combination of N.O. or N.C. contacts	
Contact Material	W (tungsten in a controlled gas atmosphere)	
Coil Voltage Range	24...250V AC 24...250V DC	
Coil Power	Sealed Voltage Range: -15...+10%	5.5 VA, 50/60 Hz 5.5 W DC
	Inrush	5.5 VA, 50/60 Hz 5.5 W DC
Pickup Time	30 ms	
Dropout Time	30 ms	
Operating Temperature	-40...+60 °C (-40...+140 °F)	
Mounting	Panel mount	
Haz. Loc. Ratings	Class I, Division 2, Groups A, B, C, and D	
Standards Compliance	ISA 12.12, CSA C22.2, No. 213, EN/IEC 60947-1, -5-1	
Certifications	cULus Listed (File No. E10314, Guide NOIV/NOIV7), CE Marked	

### 700-R Operating Coils

	Coil Volts	700-R 2-...8-Pole AC		700-R 2-...8-Pole DC
		60 Hz	50 Hz	
	24	77AB27	77AB27	77D152
	48	77AB134	77AB134	77D166
	110	77AB86	77AB86	—
	115...125	—	—	77D155
	120	77AB86	77AB86	—
	208	—	—	—
	220	77AB83	77AB83	—
	240	77AB83	77AB83	—
	230...250	—	—	77D156

### Dimensions - 700-R

Approximate dimensions are shown in millimeters (inches). Dimensions are not intended for manufacturing purposes.

700-R Relays														
Type of Relay		No. of Poles	Open Type Without Enclosures				Approx. Ship Wt. [kg (lb)]	Type 1 General Purpose Enclosure					Approx. Ship Wt. [kg (lb)]	
			Drawing Number	A Wide	B High	C Deep		D	A Wide	B High	C Deep	D		E
R	700 and 700DC	2...4	1	55.56 (2-3/ 16)	88.90 (3-1/2)	92.25 (3-3/8)	79.38 (3-1/8)	0.91 (2)	104.78 (4-1/8)	185.74 (7-5/ 16)	103.19 (4-1/ 16)	146.05 (5-3/4)	85.73 (3-3/8)	1.81 (4)
		5...8	2	55.56 (2-3/ 16)	88.90 (3-1/2)	111.13 (4-3/8)	79.38 (3-1/8)	1.02 (2-1/4)	112.71 (4-7/ 16)	228.60 (9)	120.65 (4-3/4)	206.38 (8-1/8)	92.08 (3-5/8)	2.49 (5)

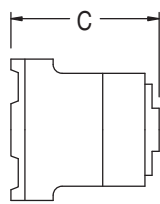

700-R400...

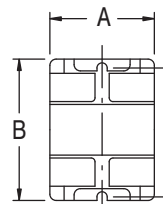

700-R800...

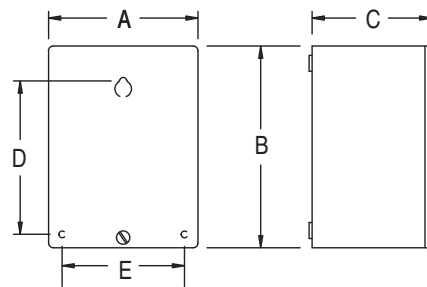
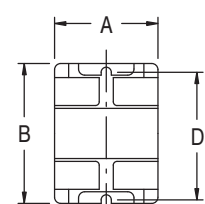
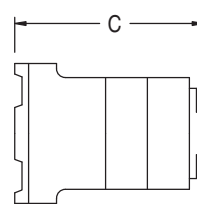

Type 1 Enclosure

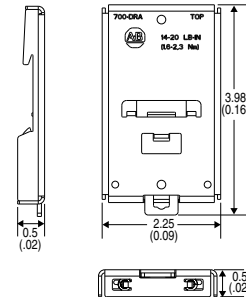

DIN Rail Adapter

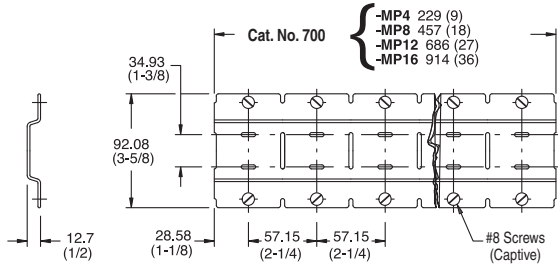

Secure the mounting strip with 2 screws at each end relay position. Use a minimum of one screw at the 3rd, 5th, 7th, etc., relay positions. Alternate between upper and lower horizontal slots.

Relay Rail

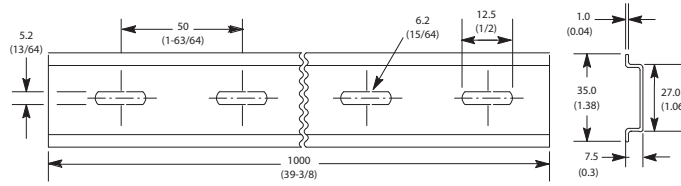

Cat. No. 199-DR1 DIN Mounting Rail Series B

## 700-RTC — Solid-State Timing Relay

- Timing functions
- 8 ON-delay
- 8 OFF-delay
- Timing ranges
- Seconds: 0.05...2, 0.2...8, 0.4...30, 2...120
- Minutes: 0.015...1, 0.06...4, 0.25...16 and 1...64
- AC, 50/60 Hz or DC
- 600V AC maximum
- 300V DC maximum
- Relays with fixed time delay
- Sealed contacts
- Harsh environments
- Hazardous locations Class I, Div. 2, Groups A, B, C and D

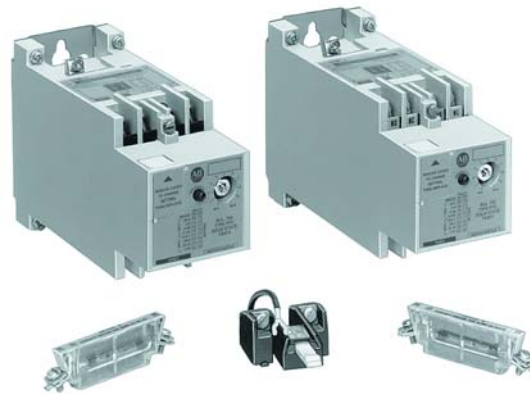

### 700-RTC Relay with Adjustable Time Delay – Relays with Provision for Instantaneous Contacts

Relays listed below have slots for two timed contacts and two instantaneous contacts. Unused slots are equipped with removable dummy cartridges.

Number of Contact Cartridges				Open Type Without Enclosure	
Total	Instantaneous		Timed		Cat. No.
	N.O.	N.C.	N.O.	N.C.	
0	0	0	0	0	700-RTC00000⊗
1	0	0	1	0	700-RTC00100⊗
	0	0	0	1	700-RTC00010⊗
2	0	0	2	0	700-RTC00200⊗
	1	0	1	0	700-RTC10100⊗
	0	1	1	0	700-RTC01100⊗
	0	0	1	1	700-RTC00110⊗
	1	0	0	1	700-RTC10010⊗
	0	1	0	1	700-RTC01010⊗
	0	0	0	2	700-RTC00020⊗
	0	0	0	0	700-RTC00000⊗
3	1	0	2	0	700-RTC10200⊗
	2	0	1	0	700-RTC20100⊗
	0	1	2	0	700-RTC01200⊗
	1	1	1	0	700-RTC11100⊗
	1	0	1	1	700-RTC10110⊗
	2	0	0	1	700-RTC20010⊗
	0	2	1	0	700-RTC02100⊗
	0	1	1	1	700-RTC01110⊗
	1	1	0	1	700-RTC11010⊗
	1	0	0	2	700-RTC10020⊗
	0	2	0	1	700-RTC02010⊗
	0	1	0	2	700-RTC01020⊗

Number of Contact Cartridges					Open Type Without Enclosure
Total	Instantaneous		Timed		Cat. No.
	N.O.	N.C.	N.O.	N.C.	
4	2	0	2	0	700-RTC20200⊗
	1	1	2	0	700-RTC11200⊗
	2	0	1	1	700-RTC20110⊗
	0	2	2	0	700-RTC02200⊗
	1	1	1	1	700-RTC11110⊗
	2	0	0	2	700-RTC20020⊗
	1	1	0	2	700-RTC11020⊗
	0	2	1	1	700-RTC02110⊗
	0	2	0	2	700-RTC02020⊗

⊗ *Coil Voltage Code*

The Cat. No. as listed is not complete. Select a voltage code from the table below to complete the Cat. No. Example: Cat. No. 700-RTC00100⊗ becomes Cat. No. 700-RTC00100U24. For other voltages consult your local Rockwell Automation sales office or Allen-Bradley distributor.

[V]	24V DC, 24V AC	120V DC, 110/120V AC
50/60 Hz	U24	U1

**700-RTC Relays with Fixed Time Delay— Relays with Provision for Instantaneous Contacts**

Relays listed below have slots for two timed and two instantaneous contacts. Unused slots are equipped with removable dummy cartridges.

Number of Contact Cartridges					Open Type Without Enclosure
Total	Timed		Instantaneous		Cat. No.
	N.O.	N.C.	N.O.	N.C.	
0	0	0	0	0	700-RTC00#0⊗
1	1	0	0	0	700-RTC10#0⊗
	0	1	0	0	700-RTC20#0⊗
2	2	0	0	0	700-RTC40#0⊗
	1	0	1	0	700-RTC11#0⊗
	1	0	0	1	700-RTC12#0⊗
	1	1	0	0	700-RTC30#0⊗
	0	1	1	0	700-RTC21#0⊗
	0	1	0	1	700-RTC22#0⊗
	0	2	0	0	700-RTC50#0⊗
	3	2	0	1	0
1		0	2	0	700-RTC14#0⊗
2		0	0	1	700-RTC42#0⊗
1		0	1	1	700-RTC13#0⊗
1		1	1	0	700-RTC31#0⊗
0		1	2	0	700-RTC24#0⊗
1		0	0	2	700-RTC15#0⊗
1		1	0	1	700-RTC32#0⊗
0		1	1	1	700-RTC23#0⊗
0		2	1	0	700-RTC51#0⊗
0		1	0	2	700-RTC25#0⊗
0		2	0	1	700-RTC52#0⊗

Number of Contact Cartridges				Open Type Without Enclosure	
Total	Timed		Instantaneous		Cat. No.
	N.O.	N.C.	N.O.	N.C.	
4	2	0	2	0	700-RTC44#0⊗
	2	0	1	1	700-RTC43#0⊗
	1	1	2	0	700-RTC34#0⊗
	2	0	0	2	700-RTC45#0⊗
	1	1	1	1	700-RTC33#0⊗
	0	2	2	0	700-RTC54#0⊗
	1	1	0	2	700-RTC35#0⊗
	0	2	1	1	700-RTC53#0⊗
0	2	0	2	700-RTC55#0⊗	

### # Operating Mode

Replace the # in the cat. no. with the appropriate letter and numbers to indicate the operating mode and the fixed time delay value. Refer to operating mode table below.

Digit	Operating Mode	Fixed Time Delay
S	On-Delay – s	<b>Seconds</b> –Two digits indicating the fixed time delay in seconds. Three digits indicating the fixed time delay (first digit indicates seconds, next two digits indicate 1/100 seconds).
Z	Off-Delay – s	
Y	On-Delay – Min.	<b>Minutes</b> –Two digits indicating the fixed time delay in minutes. Three digits indicating the fixed time delay (first digit indicates minutes, next two digits indicate 1/100 minutes).
I	Off-Delay – Min.	

**EXAMPLE** Cat. No. **700-RTC00Y200U1** is for a relay without contact cartridges. “Y20” indicates an On-Delay timer with a 20 minute fixed time delay. This is a “standard relay.” Order the contact cartridges separately.

Cat. No. **700-RTC42S020U1** is for a relay with 2 N.O. cartridges in the timed position and 1 N.C. cartridge in the instantaneous position. “S02” indicates an On-Delay timer with a 2 second fixed time delay.

### ⊗ Coil Voltage Code

The cat. no. as listed is not complete. To complete the cat. no., add a coil code selected from the table below.

[V]	24V DC, 24V AC	120V DC, 110/120V AC
50/60 Hz	U24	U1

### Accessories - 700-RTC Relays





Photo	Description	Cartridge Type	Color	Cat. No.
	<b>Contact Cartridges</b> – These cartridges are used to add contacts to timing relays having unused slots. The N.O., N.C., and Dummy cartridges are interchangeable and can be used in timed or instantaneous contact slots. Dummy cartridges should be placed in unused cartridge slots to guard against entrance of foreign material.	N.O.	Grey	700-CRT5
		N.C.	Orange	700-CRT6
		Dummy Cartridge	Black	700-CR9
Cat. No. 700-CRT5	Cat. No. 700-CRT6	Cat. No. 700-CR9		

Photo	Description	Cartridge Type	Color	Cat. No.
	<b>Type 1 Enclosure</b> — Use for all 700-P relays except 10- and 12-pole DC relays or 6-pole DC 700-PH relays.			700-N31
	<b>Relay Rail</b> Simplifies panel layout. These indexed strips are easily cut to the required length and bolted, riveted, or spot-welded in place. Relays are installed adjacent to one another on the mounting strip with the captive mounting screws provided. Rows of relays on Relay Rail form their own wiring trough. Can be used with the following relays: 700P, 700DC-P, 700S-P, 700N, 700-R, 700-RTC	Relays per Strip	Pkg. Quantity	700-MP4
		4	5	
		8	5	700-MP8
		12	5	700-MP12
		16	5	700-MP16
	<b>DIN (#3) symmetrical hat rail</b> 35 x 7.5 x 1 m		10	199-DR1
	<b>DIN Rail Adapter</b> Can be used with the following relays: 700-P, 700DC-P, 700S-P, 700-N, 700-R, 700-RTC		1	700-DRA

**Specifications - 700-RTC Relays**

*Voltage and Power Requirements*

AC Voltage +10% –15% 50/60 Hz	Total Power Required	Initiate Terminal Power	Maximum Allowable Leakage Current	Coil Code
24V AC	8 VA	4 VA	10 mA	<b>U24</b>
110/120V AC	9 VA	4 VA	2.4 mA	<b>U1</b>

DC Voltage +10% –20%	Total Power Required	Initiate Terminal Power	Maximum Allowable Leakage Current	Coil Code
24V DC	10 W	5 W	10 mA	<b>U24</b>
120V DC	11 W	5 W	2.4 mA	<b>U1</b>

Type	700-RTC
Contact Rating	NEMA B600 600V AC, 5 A NEMA P300 300V DC, 5 A
Contact Arrangement	1...4 poles. Max. of 2 timed and 2 instantaneous. Available in any combination of N.O. and N.C. contacts
Contact Material	W (tungsten in a controlled gas atmosphere)
Operating Mode	Convertible to ON-Delay or OFF-Delay



Type	700-RTC	
Timing Range	0.015 . . . 64 minutes; 0.05...120 seconds	
Reset Time	25 ms	
Repeat Accuracy	±1% (or ±50 ms) at constant voltage and temperature	
Mounting	Panel or strip mount	
Surge Suppression	Not required. Timers have internal suppression	
Haz. Loc. Ratings	Class I, Division 2, Groups A, B, C, and D	
Maximum Allowable Leakage Current	24V AC/DC	10 mA
	110/120V AC, 120V DC	2.4 mA
Ambient Temperature <sup>(1)</sup>		
Operating:	-20...+60 °C (-4...+140 °F)	
Storage:	-20...+60 °C (-4...+140 °F)	
Standards Compliance	ISA 12.12, CSA C22.2, No. 213	
Certifications	cULus Listed (File No. E10314, Guide NOIV/NOIV7)	

- (1) Continuous duty units placed close to each other (3 in a row) have a temperature range of -20...+45 °C (-4...+113 °F) or should have air circulated around the units. Approximate space of 3/4 in (mm) on all sides is needed.

### Typical Wiring Diagram - 700-RTC Relays

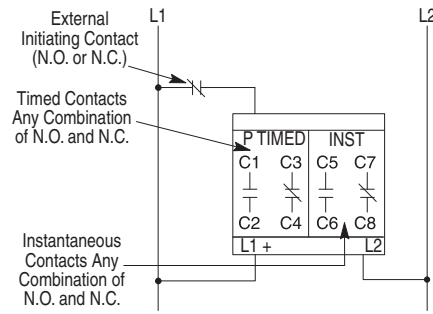

### Dimensions - 700-RTC Relays

Approximate dimensions are shown in millimeters (inches). Dimensions are not intended for manufacturing purposes.

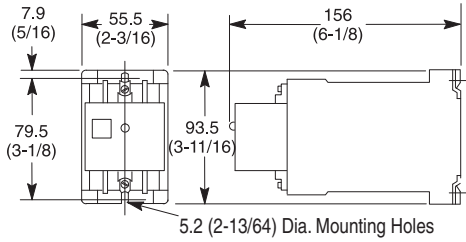

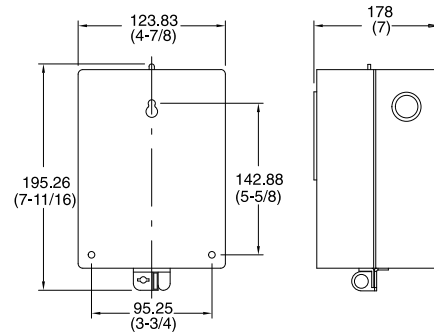

Approximate Shipping Weight 0.92 kg (2.1 lb.)



NEMA Type 1 Enclosure for RTC Relays  
Approximate Shipping Weight 1.26 kg (2.8 lb.)

## IEC Control Relays

### Product Overview

		
<b>Bulletin No.</b>	<b>700-CF and 700S-CF</b>	<b>700-K</b>
<b>Type</b>	Control Relay	Miniature Control Relay
<b>Features</b>	<ul style="list-style-type: none"> <li>• Mechanically linked contacts</li> <li>• Timer and latch operations</li> <li>• Switch up to 690V AC and DC</li> <li>• 700S-CF for safety circuits</li> </ul>	<ul style="list-style-type: none"> <li>• Smallest size</li> <li>• Long life</li> <li>• Low power consumption</li> <li>• Switch up to 690V AC and DC</li> </ul>
<b>Contact Form</b>	4...12 poles, double break	4...8 Poles Double Break
<b>Contact Type</b>	Cross stamp or bifurcated	Bifurcated
<b>Contact Material</b>	Silver, gold	Silver
<b>Electrical</b>		
<b>Max. Current AC Resistive</b>	20 A (relay) 10 A (adder deck)	10 A
<b>Min. load</b>	17V, 10 mA (Silver) 5V, 3 mA (Gold)	15V, 2 mA (700-K)
<b>Coil Voltage</b>	12...600V AC 9...250V DC	12...600V AC 9...250V DC
<b>Coil Voltage Pickup</b>	85...110% AC coils, 80...110% DC coils	85...110% AC Coils, 80...110% DC Coils
<b>Dielectric Withstand</b>	2.5 kV	2640V
<b>Reference</b>		
<b>Electric Service Life (cycles)</b>	1.2 million at 10 A	800K at 10 A 120V AC
<b>Certifications</b>	CE, cULus, CCC	CE, cULus, CCC
<b>Sockets</b>	DIN Rail or panel mount	DIN Rail or panel mount
<b>Page</b>	<a href="#">188</a>	<a href="#">213</a>

## 700-CF Control Relay

- IEC industrial relays
- Mechanically linked contact performance per IEC 60947-5-1
- Gold plated, bifurcated version for low level switching applications
- Master control relay version rated 15 A (AC-15)
- Solid-state and pneumatic timing modules
- 4...10 Poles



### 4-Pole AC Coil Voltage (Ratings for 700-CF Only)

AC-12		AC-15							Connection Diagrams	Contacts		Standard Contacts <sup>(1)</sup>	Gold Plated Bifurcated Contacts <sup>(2)</sup>	Master Contacts <sup>(2)</sup>
I <sub>th</sub> [A]		I <sub>e</sub> [A]								N.O.	N.C.			
40 °C	60 °C	24/48V	120V	240V	400V	500V	600V	690V				Cat. No.	Cat. No.	Cat. No.
20	20	10	10	10	6	2.5	1	1		2	2	700-CF220⊗	700-CFB220⊗	700-CFM220⊗
										3	1	700-CF310⊗	700-CFB310⊗	700-CFM310⊗
										4	0	700-CF400⊗	700-CFB400⊗	700-CFM400⊗
										0	4	700-CF040⊗	700-CFB040⊗	—

(1) For spring clamp terminals, insert R after 700-C. Example: Cat. No. 700-CRF220D.

(2) All Cat. Nos. are factory-stocked.



### ⊗ AC Coil Voltage Code

The cat. no. as listed is incomplete. Select a coil voltage code from the table below to complete the cat. no. Example: Cat. No. 700-CF220⊗ becomes Cat. No. 700-CF220D for 120V, 60 Hz.

[V]	12	24	32	36	42	48	100	100... 110	110	120	127	200	200... 220	208	208... 240	220... 230	230	230... 240	240
50 Hz	R	K	V	W	X	Y	KP	—	D	P	S	KG	L	—	—	F	—	VA	T
60 Hz	Q	J	—	V	—	X	—	KP	—	D	—	—	KG	H	L	—	—	—	A
50/60 Hz	—	KJ	—	—	—	KY	KP	—	KD	—	—	KG	KL	—	—	KL	KF	—	KA

[V]	277	347	380	380... 400	400	400... 415	440	480	500	550	600
50 Hz	—	—	—	N	—	G	B	—	M	C	—
60 Hz	T	I	E	—	—	—	N	B	—	—	C
50/60 Hz	—	—	—	—	KN	—	KB	—	—	—	—

## 4-Pole DC Coil Voltage (Ratings for 700-CF Only)

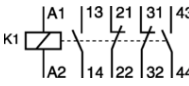
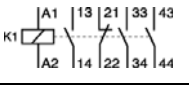
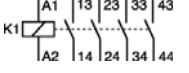
AC-12		AC-15							Connection Diagrams	Contacts		Standard Contacts <sup>(1)</sup>	Gold Plated Bifurcated Contacts <sup>(2)</sup>	Master Contacts <sup>(2)</sup>
<i>I</i> th[A]		<i>I</i> e [A]												
40 °C	60 °C	24/48V	120V	240V	400V	500V	600V	690V		N.O.	N.C.	Cat. No.	Cat. No.	Cat. No.
20	20	10	10	10	6	2.5	1	1		2	2	700-CF220 ⊗	700-CFB220⊗	700-CFM220⊗
										3	1	700-CF310⊗	700-CFB310⊗	700-CFM310⊗
										4	0	700-CF400⊗	700-CFB400⊗	700-CFM400⊗

(1) For spring clamp terminals, insert R after 700-C. Example: Cat. No. 700-CRF220D.

(2) All Cat. Nos. are factory-stocked.

## ⊗ DC Coil Voltage Code

The cat. no. as listed is incomplete. Select a coil voltage code from the table below to complete the cat. no. example: Cat. No. 700-CF220⊗ becomes Cat. No. 700-CF220EJ for 24V DC, electronic with diode.

[V]	9	12	24	36	48	48... 72	60	64	72	80	110	110... 125	115	125	220	220... 250	230	250
Electronic with diode	—	EQ	EJ	EW	—	EY	—	—	—	—	—	ED	—	—	—	EA	—	—
Electronic with diode/ Quick Pick-up	—	—	QJ	—	—	—	—	—	—	—	—	—	—	—	—	—	—	—

### 6- and 8-pole Relays

Control Relays with Overlapping Side-Mounted Contacts

AC-12			AC-15							Left Aux.	Relay Arrangement	Right Aux.	Contacts		Overlapping Side-Mounted Contacts		Cat. No.
$I_{th}$ [A]			$I_e$ [A]										N.O.	N.C.	N.O.	N.C.	
40 °C	60 °C		24/48V	120 V	240 V	400 V	500 V	600 V	690 V								
Main Relay	20	20	10	10	10	6	2.5	1	1		4	0	1	1	700-CFZ1510⊗		
											3	1	1	1	700-CFZ1420⊗		
Side Contacts	10	10	6	6	5	3	1.6	1	1		2	2	1	1	700-CFZ1330⊗		
											4	0	2	2	700-CFZ2620⊗		
											3	1	2	2	700-CFZ2530⊗		
											2	2	2	2	700-CFZ2440⊗		

### Control Relays with Standard Side-mounted Contacts

AC-12			AC-15							Left Aux.	Relay Arrangement	Right Aux.	Contacts		Standard Side-Mounted Contacts		Cat. No. <sup>(1)</sup>
$I_{th}$ [A]			$I_e$ [A]										N.O.	N.C.	N.O.	N.C.	
	40 °C	60 °C	24/48V	120V	240V	400V	500V	600V	690V								
Main Relay	20	20	10	10	10	6	2.5	1	1		4	0	1	1	700-CFZ0510⊗		
											3	1	1	1	700-CFZ0420⊗		
												2	2	1	1	700-CFZ0330⊗	
Side Contacts	10	10	6	6	5	3	1.6	1	1		4	0	2	2	700-CFZ0620⊗		
											3	1	2	2	700-CFZ0530⊗		
												2	2	2	2	700-CFZ0440⊗	

(1) All Cat. Nos. are factory stocked.

#### ⊗ AC Coil Voltage Code

The cat. no. as listed is incomplete. Select a coil voltage code from the table below to complete the cat. no. Example: Cat. No. 700-CFZ0510⊗ becomes Cat. No. 700-CFZ0510F.

[V]	12	24	32	36	42	48	100	100... 110	110	120	127	200	200... 220	208	208... 240	220... 230	230	230... 240	240
50 Hz	R	K	V	W	X	Y	KP	—	D	P	S	KG	L	—	—	F	—	VA	T
60 Hz	Q	J	—	V	—	X	—	KP	—	D	—	—	KG	H	L	—	—	—	A
50/60 Hz	—	KJ	—	—	—	KY	KP	—	KD	—	—	KG	KL	—	—	KL	KF	—	KA

[V]	277	347	380	380... 400	400	400... 415	440	480	500	550	600
50 Hz	—	—	—	N	—	G	B	—	M	C	—
60 Hz	T	I	E	—	—	—	N	B	—	—	C
50/60 Hz	—	—	—	—	KN	—	KB	—	—	—	—

### Assignment of Contacts



Device Combinations in Accordance with IEC 60947-1 / -4-1

Auxiliary Contact Blocks		Control Relays 700-CF (AC and DC Control)			
	Circuit Diagram	Control	700-CF⊗220	700-CF⊗310	700-CF⊗400
<b>FrontMounting<sup>(1)</sup></b>					
100-FA02		AC/DC	22E + 02E = 24Y	31E + 02E = 33Y	40E + 02E = 42Y
100-FA11		AC/DC	22E + 11E = 33Y	31E + 11E = 42Y	40E + 11E = 51Y
100-FA20		AC/DC	22E + 20E = 42Y	31E + 20E = 51Y	40E + 20E = 60Y
100-FA22		AC/DC	22E + 22E = 44Y	31E + 22E = 53Y	40E + 22E = 62Y
100-FA31		AC/DC	22E + 31E = 53Y	31E + 31E = 62Y	40E + 31E = 71Y
100-FA40		AC/DC	22E + 40E = 62Y	31E + 40E = 71Y	40E + 40E = 80Y
100-FAL22		AC/DC	22E + L22E = L44Y	31E + L22E = L53Y	40E + L22E = L62Y



(1) Control relay and auxiliary contact block AC/DC max. 4 N. C.

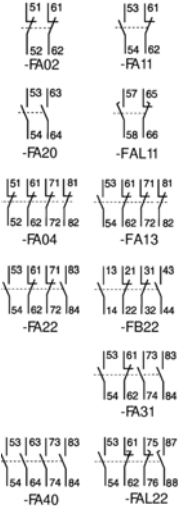

### Auxiliary Contacts

Photo	Description	N.O.	N.C.	Connection Diagrams	For Use With	Standard Contacts <sup>(1)</sup>	Bifurcated Contacts
						Cat. No.	Cat. No.
 	<b>Auxiliary Contact Blocks for Front Mounting§</b> 2- and 4-pole Quick and easy mounting without tools Electronic-compatible contacts down to 17V, 5 mA Mechanically linked performance between N.O. and N.C. poles and to the main relay poles (except for L types) Models with equal function with several terminal numbering choices 1L = Late break N.C./early make N.O. Bifurcated version for switching down to 5V, 3 mA	0	2		700-CF	100-FA02	100-FAB02
		1	1			100-FA11	100-FAB11
		2	0			100-FA20	100-FAB20
		1L	1L			100-FAL11	—
		0	4			100-FA04	100-FAB04
		1	3			100-FA13	100-FAB13
		2	2			100-FA22	100-FAB22
		3	1			100-FA31	100-FAB31
		4	0			100-FA40	100-FAB40
		1+1L	1+1L			100-FAL22	—

(1) For spring clamp terminals, insert CR after 100-. Example: Cat. No. 100-CRFA02.

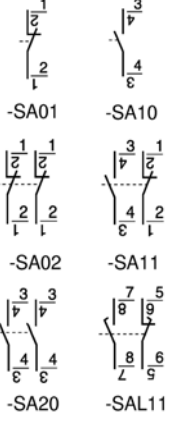
Photo	Description	N.O.	N.C.	Connection Diagrams	For Use With	Cat. No.
 	<b>Auxiliary Contact Blocks for Side Mounting without Sequence Terminal Designations§</b> 1- and 2-pole Two-way numbering for right or left mounting on the contactor Quick and easy mounting without tools Electronic-compatible contacts down to 17V, 10 mA Mirror contact performance to the main relay poles 1L = Late break N.C./early make N.O.	0	1		700-CF	100-SA01
		1	0			100-SA10
		0	2			100-SA02
		1	1			100-SA11
		2	0			100-SA20
		1L	1L			100-SAL11

**IMPORTANT** For maximum number of contacts, see the following tables.

**700-CF (AC electronic coils), vertical mounting, 60 °C<sup>(1)</sup>**

Cat. No. 700...	Max. N.O. Side Aux.	Max. N.C. Side Aux.	Max. N.O. Front Aux.	Max. N.C. Front Aux.	Max. N.O. Front + Side Aux.	Max. N.C. Front + Side Aux.	Max. N.O. + N.C. Front + Side Aux.
CF400	2	4	4	4	6	7	8
CF310	2	4 <sup>(2)</sup>	4	4 <sup>(3)</sup>	6	5	8
CF220	4	4 <sup>(2)</sup>	4	2	8	5	8
CF040	2	2	4	0	6	2	6

(1) For other operating conditions, please contact your local Rockwell Automation sales office or Allen-Bradley distributor.

(2) With no front auxiliary contacts installed. Otherwise 3 N.C. Maximum

(3) With no side auxiliary contacts installed. Otherwise 3 N.C. Maximum







**700-CF (DC conventional coils), vertical mounting, 60 °C<sup>(1)</sup>**

Cat. No. 700...	Max. N.O. Side Aux.	Max. N.C. Side Aux.	Max. N.O. Front Aux.	Max. N.C. Front Aux.	Max. N.O. Front + Side Aux.	Max. N.C. Front + Side Aux.	Max. N.O. + N.C. Front + Side Aux.
CF400	2	2	4	4 <sup>(2)</sup>	6	5	8
CF310	2	2	4	4 <sup>(2)</sup>	6	5	8
CF220	2	2	4	2	6	4	8

(1) For other operating conditions, please contact your local Rockwell Automation sales office or Allen-Bradley distributor.

(2) With no side auxiliary contacts installed. Otherwise 3 N.C. Maximum

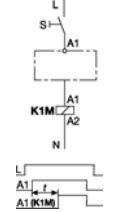
**Control Modules**

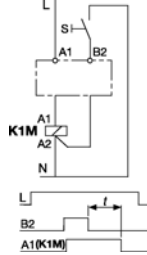
Photo	Description	Connection Diagrams	Reset Time	Repeat Accuracy	Delay	For Use With	Cat. No.
	<b>Pneumatic Timing Modules<sup>(1)</sup> ON-Delay</b> Pneumatic timing element contacts switch after the delay time. The contacts on the main control relay continue to operate without delay.		25...90 ms for AC Coils	+/-10%	0.3...30 s	700-CF all <sup>(1)</sup>	100-FPTA30
					1.8...180 s		100-FPTA180
	<b>Pneumatic Timing Modules OFF-Delay</b> Pneumatic timing element contacts switch after the delay time. The contacts on the main control relay continue to operate without delay.		47...85 ms for DC coils		0.3...30 s		100-FPTB30
					1.8...180 s		100-FPTB180
	<b>Electronic Timing Modules — On-Delay</b> Delay of the control relay coil assembly. The control relay is energized at the end of the delay time.		100 ms	+/-1%	0.1...3 s	700-CF 110...240V AC coils	100-ETA3
					1...30 s		100-ETA30
					10...180 s		100-ETA180
					0.1...3 s	700-CF 24...48V DC coils	100-ETAZJ3
					1...30 s		100-ETAZJ30
					10...180 s		100-ETAZJ180
	<b>Electronic Timing Modules — Off-Delay</b> Delay of the control relay coil assembly. After interruption of the control signal, the control relay is deenergized at the end of the delay time.		100 ms	+/-1%	0.3...3 s	700-CF 110...240V AC coils	100-ETB3
					1...30 s		100-ETB30
					10...180 s		100-ETB180
					0.3...3 s	700-CF 24V AC coils	100-ETBKJ3
					1...30 s		100-ETBKJ30
					10...180 s		100-ETBKJ180

(1) On-Delay modules cannot be used with side-mounted auxiliary contacts on DC coil relays.

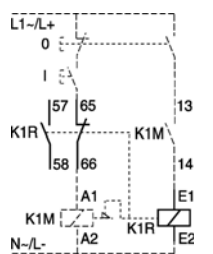

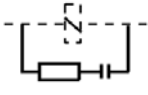
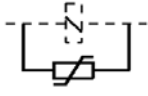

Photo	Description	Connection Diagrams	For Use With	Cat. No.
	<b>Mechanical Latch</b> Following relay latching, the relay coil is immediately de-energized (off) by the N.C. auxiliary contact (65-66). Electrical or manual release 1 N.O. + 1 N.C. auxiliary contacts		700-CF with AC coils	100-FL11⊗

Photo	Description			Connection Diagrams	For Use With	Cat. No. <sup>(1)</sup>
	<b>Surge Suppressors</b> For limitation of coil switching transients. Plug-in, coil mounted	<b>RC Module</b> AC Operating Mechanism	24...48V 50/60 Hz		700-CF with AC coils	100-FSC48
			110...280V 50/60 Hz			100-FSC280
			380...480V 50/60 Hz			100-FSC480
		<b>Varistor Module</b> AC/DC Operating Mechanism	12...55V AC/ 12...77V DC		700-CF all	100-FSV55
			56...136V AC/ 78...180V DC			100-FSV136
			137...277V AC/ 181...350V DC			100-FSV277
			278...575V AC			100-FSV575
		<b>Diode Module</b> DC Operating Mechanism Dropout Time 70...95 ms	12...250V DC		700-CF with Conventional DC coils	100-FSD250

(1) For spring clamp terminals, insert CR after 100-. Example: Cat. No. 100-CRFSC48.

### Coil Voltage Code

The cat. no. as listed is incomplete. Select a coil voltage code from the table below to complete the cat. no. Example: Cat. No. 100-FL11⊗ becomes Cat. No. 100-FL11J.

[V] <sup>(1)</sup>	24	48	100	110	120	230...240	240	277	380...400	400...415	440	480
50 Hz	K	Y	KP	D	—	VA	T	—	N	G	B	—
60 Hz	J	—	—	—	D	—	A	T	—	—	N	B

(1) For special voltages, consult your local Rockwell Automation sales office or Allen-Bradley distributor.

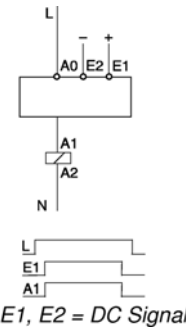

Photo	Description (Relays)	Connection Diagrams	For Use With (Relays)	Cat. No.	
	<b>DC Interface</b> (electronic) Interface between the DC control signal (PLC) and the AC operating mechanism of the control relay. Control (input) voltage 12V DC 24V DC 48V DC Requires no additional surge suppression on the relay coils	Input: 24V DC Output: 110...240V AC	 <i>E1, E2 = DC Signal</i>	700-CF with 110...240V AC coils	100-JE
		Input: 12V DC Output: 110...240V AC		100-JE12	
		Input: 48V DC Output: 110...240V AC		100-JE48	

## Specifications 100-J... DC Interfaces

	Cat. No. 100-JE	Cat. No. 100-JE12	Cat. No. 100-JE48		
<b>Electrical</b>					
Input Voltage	24V DC	12V DC	48V DC		
Input Voltage Range	18...30V DC	6...12V DC	35...48V DC		
Output Voltage	110...240V AC	110...240V AC	110...240V AC		
Power Consumption	0.1...0.4 W	0.02...0.12 W	0.2...0.5 W		
Minimum Actuation	5V DC, 2 mA DC	5V DC, 2 mA DC	5V DC, 2 mA DC		
<b>Mechanical</b>					
Finger Protection	IP20	IP20	IP20		
Pickup Time	0...10 ms + pickup time of the contactor	0...10 ms + pickup time of the contactor	0...10 ms + pickup time of the contactor		
Dropout Time	0...10 ms + dropout time of the contactor	0...10 ms + dropout time of the contactor	0...10 ms + dropout time of the contactor		
Max. Cycles Per Second	2 <sup>(1)</sup>	2 <sup>(1)</sup>	2 <sup>(1)</sup>		
Isolation/Breakdown Voltage	In: 50V, Out: 250V	In: 50V, Out: 250V	In: 50V, Out: 250V		
Rated Impulse Withstand Voltage	4 kV	4 kV	4 kV		
<b>Environmental</b>					
Ambient Temperature Range	-25...+60 °C	-25...+60 °C	-25...+60 °C		
Storage Temperature Range	-50...+80 °C	-50...+80 °C	-50...+80 °C		
Operating Life	100 + million ops	100 + million ops	100 + million ops		
<b>Construction</b>					
Wire Size Range	Flexible wire	1 Wire	0.5...2.5 mm <sup>2</sup>	0.5...2.5 mm <sup>2</sup>	0.5...2.5 mm <sup>2</sup>
		2 Wire	0.75...2.5 mm <sup>2</sup>	0.75...2.5 mm <sup>2</sup>	0.75...2.5 mm <sup>2</sup>
	Solid wire	1 Wire	1.0...2.5 mm <sup>2</sup>	1.0...2.5 mm <sup>2</sup>	1.0...2.5 mm <sup>2</sup>
		2 Wire	1.0...2.5 mm <sup>2</sup>	1.0...2.5 mm <sup>2</sup>	1.0...2.5 mm <sup>2</sup>
	Solid and Stranded	18...14 AWG	18...14 AWG	18...14 AWG	
Tightening Torque	1...1.5 N·m / 7...15 lb·in	1...1.5 N·m / 7...15 lb·in	1...1.5 N·m / 7...15 lb·in		
Type of Light	LED	LED	LED		

(1) To consider the maximum operations/hour of the relays.

## Assembly Components

Photo	Description	For Use With	Pkg Qty. <sup>(1)</sup>	Cat. No.
	<b>Protective Covers</b> Provides protection against unintended manual operation	700-CF all	1	100-SCCA
	<b>Protective Covers</b> <ul style="list-style-type: none"> <li>Provides protection against unintended manual operation</li> <li>For contactors and front-mounted auxiliary contacts, pneumatic timers, and latches</li> </ul>	100-FA, -FB, -FC, -FP, -FL;	10	100-SCFA

(1) All Cat. Nos. are factory stocked.

### Accessories

Uniform labeling materials for contactors, motor startup equipment, relays, and circuit breakers.

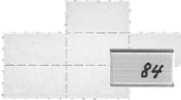
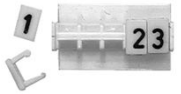
Photo	Description	Pkg. Qty. <sup>(1)</sup>	Cat. No.
	<b>Label Sheet</b> 105 self-adhesive paper labels each, 6 x 17 mm	10	100-FMS
	<b>Marking Tag Sheet</b> 160 perforated paper labels each, 6 x 17 mm, to be used with a transparent cover	10	100-FMP
	<b>Transparent Cover</b> To be used with marking tag sheets	100	100-FMC
	<b>Marking Tag Adapters</b> To be used with marking tag: System V4/V5	100	100-FMA1 <sup>(2)</sup>
	System 1492 W		100-FMA2

(1) Must be ordered in multiples of package quantities.

(2) Marker for 100-FMA1 must be purchased from a third party.

## Coils

Photo	AC Coil Code	AC Voltages			Cat. No. 700-CF	DC Coil Code	DC Voltages	Cat. No. 700-CF
		50Hz	60Hz	50/60Hz				
	Q	—	12V	—	TA006	EQ	12V	TC708E
	R	12V	—	—	TA404	EJ	24 V	TC714E
	J	—	24V	—	TA013	QJ	24V	TC714Q
	K	24V	—	—	TA407	EY	48...72V	TC724E
	KJ	—	—	24V	TA855	EW	36...48	TC719E
	V	32V	36V	—	TA481	ED	110...125	TC733E
	W	36V	—	—	TA410	EA	220...250	TC747E
	X	42V	48V	—	TA482			
	Y	48V	—	—	TA414			
	KY	—	—	48V	TA860			
	KP	100V	100 - 110V	100V	TA861			
	D	110V	120V	—	TA473			
	KD	—	—	110V	TA856			
	P	120V	—	—	TA425			
	S	127V	—	—	TA428			
	KG	200V	200 - 220V	200V	TA862			
	H	—	208V	—	TA049			
	L	200 - 220V	208 - 240V	—	TA296			
	KL	—	—	200 - 230V	TA864			
	A	220V	240V	—	TA474			
	F	220 - 230V	260V	—	TA441			
	KF	—	—	230V	TA851			
	VA	230 - 240V	—	—	TA440			
	T	240V	277V	—	TA480			
	KA	—	—	240V	TA858			
	I	—	347V	—	TA065			
	E	—	380V	—	TA067			
	N	380 - 400V	440V	—	TA071			
KN	—	—	400V	TA863				
G	400-415V	—	—	TA457				
B	440V	480V	—	TA475				
KB	—	—	440V	TA859				
M	500V	—	—	TA479				
C	550V	600V	—	TA476				



**Specifications - 700-CF..., 700S-CF Relays**

		Main Relay Cat. Nos. 700-CF, 700S- CF	Front Mounted Standard Auxiliary Contacts	Main Relay Cat. No. 700-CFB, 700S- CFB	Master Relay Cat. No. 700-CFM	Front Mounted Bifurcated Auxiliary Contacts	Side-mounted Auxiliary Contacts	
Contact Ratings — NEMA		A600, P600	A600, Q600	A600, Q600	2 x A600, P600	A600, Q600	A600, Q600	
Min. Contact Rating		17V, 10 mA	17V, 5 mA	8V, 5 mA	—	5V, 3 mA	17V, 10 mA	
Contact Ratings — IEC AC-15 (solenoids, contactors) at rated voltage IEC 60947-5-1		24V	10 A	6 A	3 A	15 A	3 A	6 A
		48V	10 A	6 A	3 A	15 A	3 A	6 A
		120V	10 A	6 A	3 A	15 A	3 A	6 A
		240V	10 A	5 A	3 A	15 A	3 A	5 A
		400V	6 A	3 A	2 A	7.5 A	2 A	3 A
		480V/500V	2.5 A	1.6 A	1.2 A	5 A	1.2 A	1.6 A
		600V	1 A	1 A	0.7 A	2 A	0.7 A	1 A
		690V	1 A	1 A	0.7 A	2 A	0.7 A	1 A
AC-12 (Control of resistive loads) IEC 60947-5-1	40 °C	$I_{th}$	20 A	10 A	10 A	20 A	10 A	10 A
		230V	8 kW					
		400V	14 kW					
		690V	24 kW					
	60 °C	$I_{th}$	20 A	6 A	6 A	20 A	6 A	6 A
		230V	8 kW					
		400V	14 kW					
		690V	24 kW					
DC-12 Switching DC Loads L/R < 1ms, Resistive Loads IEC 60947-5-1		24V	15 A	10 A	6 A	20 A	6 A	6 A
		48V	10 A	9 A	3.2 A	20 A	3.2 A	3.2 A
		110V	6 A	3.5 A	1 A	8 A	1 A	1 A
		220V	1 A	0.7 A	0.5 A	1.5 A	0.5 A	0.5 A
		440V	0.4 A	0.2 A	0.2 A	0.4 A	0.2 A	0.2 A
DC-13 IEC 60947-5-1, Solenoids and contactors		24V	5 A	5 A	2.5 A	5 A	2.5 A	5 A
		48V	3 A	3 A	1.5 A	3 A	1.5 A	2.5 A
		110V	1.2 A	1.2 A	0.6 A	1.2 A	0.6 A	0.68 A
		220V	0.6 A	0.6 A	0.3 A	0.6 A	0.3 A	0.32 A
		440V	0.3 A	0.15 A	0.15 A	0.3 A	0.15 A	0.15 A

	Location of welded N.O. contacts	State of N.C. Contacts if N.O. contact welds		
		Main	Front aux.	Side aux.
	Mechanically Linked Contacts <sup>(1)</sup>	Main	Open	Open
	Front aux.	Open	Open	—

(1) Side mounted auxiliary contacts provide "mirror contact" performance with main poles only.  
 (2) Defined in IEC 60947-5-1 annex L. Mechanically linked is a relationship between contacts of opposite types (i.e., N.O. and N.C.).



Attribute			Cat. No. 700-CF	Aux./Pneumatic Timer Contact (Front mounted)	
Mechanical Life		[Mil]	15	5	
Electrical Life	AC-15 (240V, 3 A)	[Mil]	1.5	1.5	
Weight	AC Coil	[g]	390	—	
<b>Terminal Cross-Sections</b>					
Terminal Type					
Terminal Size per IEC60 947-1			2 x A4	2 x A4	
	Solid/Stranded	1 Conductor	[mm <sup>2</sup> ]	1.5...6	0.5...2.5
	(1)	2 Conductor	[mm <sup>2</sup> ]	1.5...6	0.75...2.5
Max. Wire Size per UL/CSA			[AWG]	16...10	18...14
Tightening Torque			[lb-in]	13.3...17.7	8.9...13.3
Tightening Torque			[N·m]	1.5...2.0	1...1.5

(1) For 16 or more strands, end ferrule is required.

<b>DC Switching Ratings for 700-CF Main Poles in Series (Resistive Load at 60 °C)</b>			
Attribute	1 pole	2 poles	3 poles
<b>24/48V</b>	15/10 A	25 A	25 A
<b>125V</b>	6 A	25 A	25 A
<b>220V</b>	1 A	6 A	25 A
<b>440V</b>	0.4 A	1 A	3 A

**Control Circuit**

Attribute		Cat. No. 700-CF	
<b>Operating Voltage</b>			
AC 50/60 Hz	Pickup	[x U <sub>s</sub> ]	0.85...1.1
	Dropout	[x U <sub>s</sub> ]	0.3...0.6
DC (conventional) <sup>(1)</sup>	Pickup	[x U <sub>s</sub> ]	0.8...1.1
	Dropout	[x U <sub>s</sub> ]	0.1...0.6
DC (electronic EQ, EW)	Pickup	[x U <sub>s</sub> ]	0.7...1.25
	Dropout	[x U <sub>s</sub> ]	0.3...0.4
DC (electronic EY)	Pickup	[x U <sub>s</sub> ]	0.8...1.25
	Dropout	[x U <sub>s</sub> ]	0.3...0.4
DC (electronic ED)	Pickup	[x U <sub>s</sub> ]	0.7...1.12 <sup>(2)</sup>
	Dropout	[x U <sub>s</sub> ]	0.3...0.4
DC (electronic EA)	Pickup	[x U <sub>s</sub> ]	0.8...1.1
	Dropout	[x U <sub>s</sub> ]	0.3...0.4
<b>Coil Consumption</b>			
AC 50/60 Hz	Inrush	[VA]	75
	Sealed	[VA/W]	9.5/2.7
DC (conventional)	Inrush	[W]	7.7
	Sealed	[W]	6.3
DC (electronic EQ, EJ)	Inrush (avg./ peak)	[W]	10/17
	Sealed	[W]	1.7
DC (electronic EY)	Inrush (avg./ peak)	[W]	10/17
	Sealed	[W]	1.9
DC (electronic ED)	Inrush (avg./ peak)	[W]	12/19
	Sealed	[W]	2.1
DC (electronic EA)	Inrush (avg./ peak)	[W]	14/22
	Sealed	[W]	3.0
<b>Operating Times</b>			
AC 50/60 Hz	Pickup Time	[ms]	15...30
	Dropout Time	[ms]	10...60
DC (conventional)	Pickup Time	[ms]	40...70
	Dropout Time	[ms]	7...15
With integrated diode	Opening Delay	[ms]	14...20
With external diode	Opening Delay	[ms]	70...125
DC (electronic- EQ, EJ)	Closing Delay	[ms]	25...50
	Opening Delay	[ms]	27...45
DC (electronic - EW, EY, ED, EA)	Closing Delay	[ms]	25...50
	Opening Delay	[ms]	23...33
DC (electronic- QJ)	Closing Delay	[ms]	20...50
	Opening Delay	[ms]	15...22

Attribute		Cat. No. 700-CF	
Min OFF time	[ms]	50	
Max. ripple		± 15%	
<b>Latch Attachment Release, 100-FL</b>			
Coil Consumption	AC	[VA/W]	45/40
	DC	[W]	25
Contact Signal Duration	[min./max]	0.03...15 s	
<b>Timing Attachment</b>			
Reset Time, 100-ETA, 100-ETB	at min. time setting	[ms]	10
	at max. time setting	[ms]	70
Repeat Accuracy		± 10%	

- (1) For 9V DC, code ZR, use operating voltage  $0.65 \dots 1.3 \times U_s$ .  
 For 24V DC, code ZJ, DJ, or EJ use operating voltage  $0.7 \dots 1.25 \times U_s$ .
- (2) At 110V DC, coil code ED has an operating voltage range of  $0.7 \dots 1.25 \times U_s$ .

## General Specifications - 700-CF Relays

Cat. No. 700-CF	
<b>Rated Insulation Voltage <math>U_i</math></b>	
IEC	690V
UL; CSA	600V
<b>Rated Impulse Strength <math>U_{imp}</math></b>	
	6 kV
High Test Voltage 1 minute (per IEC 60947-	
	2500V
<b>Rated Voltage <math>U_e</math></b>	
AC	115, 230, 400, 500, 690V
DC	24, 48, 110, 220, 440V
Short-Circuit Protection gG Fuse 20 A	
<b>Rated Frequency</b>	
	50/60 Hz, DC
<b>Ambient Temperature</b>	
Storage	-55...+80 °C (-67...+176 °F)
Operation at nominal current	-25...+60 °C (-13...+140 °F)
15% current reduction for AC-12 at > 60 °C	-25...+70 °C (-13...+158 °F)
<b>Corrosion Resistance</b>	
	humid-alternating climate, cyclic, per IEC 60068-2-30 and DIN 50 016, 56 cycles
<b>Altitude</b>	
	2000 m above mean sea level, per IEC 60 947-4
<b>Type of Protection</b>	
IP2X (IEC 60529 and DIN 40050)	in connected state
<b>Shock Resistance</b>	
	IEC 60068-2: Half sinusoidal shock 11 ms, 30 G (in 3 directions)
<b>Vibration Resistance</b>	
	IEC 60068-2: Static >2 G, in normal position no malfunction <5 G
<b>Standards Compliance</b>	
	UL 508, CSA C22.2 No. 14, EN/IEC 60947-1, -5-1, Meets the material restrictions for European Directive 2002/95/EC - EU-
<b>Certifications</b>	
	cULus Listed (File No. E14840, Guide NKCR/NKCR7), CE Marked, CCC Certified

## Utilization Category Table from EN 60947-5-1

Verification of Making and Breaking Capacities of Switching Elements Under Normal Conditions Corresponding to the Utilization Categories <sup>(1)</sup>									
Utilization Category	Normal Condition of Use						Number and Rate of Making and Breaking operations		
	Make <sup>(3)</sup>			Break <sup>(3)</sup>			No. operating cycles <sup>(5)</sup>	Operating cycles per minute	ON time [s] <sup>(6)</sup>
	$I/I_e$	$U/U_e$	$\cos \phi$	$I/I_e$	$U/U_e$	$\cos \phi$			
AC-12 <sup>(2)</sup>	1	1	0.9	1	1	0.9	6050	6	0.05
AC-13 <sup>(2)</sup>	2	1	0.65	1	1	0.65	6050	6	0.05
AC-14 <sup>(2)</sup>	6	1	0.3	1	1	0.3	6050	6	0.05
AC-15 <sup>(2)</sup>	10	1	0.3	1	1	0.3	6050	6	0.05
DC	—	—	$T_{0.95}$	—	—	$T_{0.95}$	—	—	—
DC-12	1	1	1 ms	1	1	1 ms	6050	6	0.05 <sup>(6)</sup>
DC-13	1	1	$6 \times P^{(4)}$	1	1	$6 \times P^{(4)}$	6050	6	0.05 <sup>(6)</sup>
DC-14 <sup>(2)</sup>	10	1	15 ms	1	1	15 ms	6050	—	0.05 <sup>(6)</sup>

(1) See sub-clause 8.3.3.5.2.

(2) Where the break current differs from the make current value, the ON time refers to the make current value after which the current is reduced to the break current value for a suitable period e.g., 0.05 s.

(3) For tolerances on test quantities, see sub-clause 8.3.2.2.

(4) The value " $6 \times P$ " results from an empirical relationship which is found to represent most DC magnetic loads to an upper limit of  $P = 50$  W, e.g.,  $6 \times P = 300$  W.(5) The first 50 operating cycles shall be run at  $U/U_e = 1.1$  with the loads set at  $U_e$ .(6) The ON time shall be at least equal to  $T_{0.95}$ . $I_e$  Rated operational current,  $I$  Current to be made or broken $U_e$  Rated operational voltage,  $U$  Voltage before make $P/U_e I_e$  Steady-state power consumption (W) $T_{0.95}$  Time to reach 95% of the steady-state current (ms)

## Contact Rating Table from EN 60947-5-1

Examples of Contact Rating Designation Based on Utilization Categories										
NEMA Designation (1)	IEC Utilization Category	Conventional Thermal Current $I_{the}$ (A)	Rated Operational Current $I_e$ (A) at Rated Operational Voltage $U_e$						VA Rating	
			120V	240V	380V	480V	500V	600V	Make	Break
<b>AC</b>										
A150	AC-15	10	6	—	—	—	—	—	7200	720
A300	AC-15	10	6	3	—	—	—	—	7200	720
A600	AC-15	10	6	3	1.9	1.5	1.4	1.2	7200	720
B150	AC-15	5	3	—	—	—	—	—	3600	360
B300	AC-15	5	3	1.5	—	—	—	—	3600	360
B600	AC-15	5	3	1.5	0.95	0.75	0.72	0.6	3600	360
C150	AC-15	2.5	1.5	—	—	—	—	—	1800	180
C300	AC-15	2.5	1.5	0.75	—	—	—	—	1800	180
C600	AC-15	2.5	1.5	0.75	0.47	0.375	0.35	0.3	1800	180
D150	AC-15	1.0	0.6	—	—	—	—	—	432	72
D300	AC-14	1.0	0.6	0.3	—	—	—	—	432	72
E150	AC-14	0.5	0.3	—	—	—	—	—	216	36
<b>DC</b>			<b>125V</b>	<b>250V</b>	<b>440V</b>	<b>500V</b>	<b>600V</b>	<b>—</b>	<b>Make</b>	<b>Break</b>
N150	DC-13	10	2.2	—	—	—	—	—	275	275
N300	DC-13	10	2.2	1.1	—	—	—	—	275	275
N600	DC-13	10	2.2	1.1	0.63	0.55	0.4	—	275	275
P150	DC-13	5	1.1	—	—	—	—	—	138	138
P300	DC-13	5	1.1	0.55	—	—	—	—	138	138
P600	DC-13	5	1.1	0.55	0.31	0.27	0.2	—	138	138
Q150	DC-13	2.5	0.55	—	—	—	—	—	69	69
Q300	DC-13	2.5	0.55	0.27	—	—	—	—	69	69
Q600	DC-13	2.5	0.55	0.27	0.15	0.13	0.1	—	69	69
R150	DC-13	1.0	0.22	—	—	—	—	—	28	28
R300	DC-13	1.0	0.22	0.1	—	—	—	—	28	28

(1) This letter stands for the conventional thermal current and identifies AC or DC: for example, B=5 A AC. The number that follows is the rated insulation voltage.

### Dimensions - 700-CF... Relays

Approximate dimensions are shown in millimeters (inches). Dimensions are not intended for manufacturing purposes.

#### Mounting Position

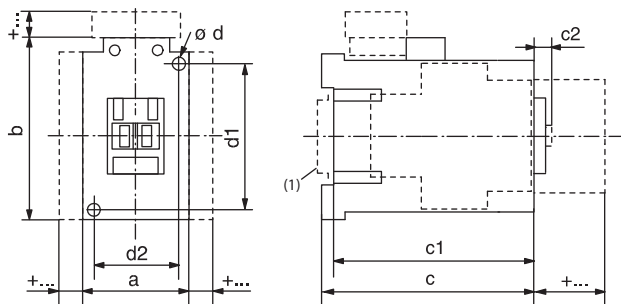

(1) May be mounted to 35 mm EN 50 022 DIN Rail.

AC and DC Control Relay with DC Electronic Coil

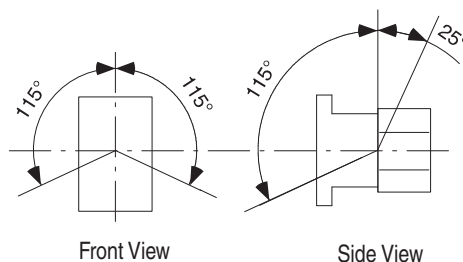

DC Control Relay

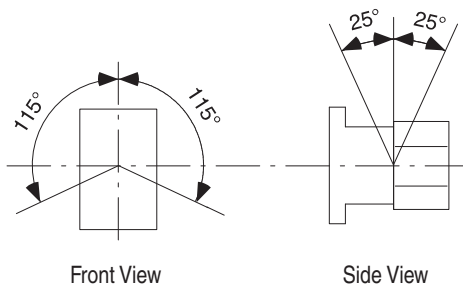

#### All AC Control Relays and DC Control Relays with 12V or 24V DC Electronic Coil

Type	a	b	c	c1	c2	Ød	d1	d2
700-CF, -CFB, -CFM	45 (1-25/32)	81 (3-3/16)	80.5 (3-11/64)	75.5 (3-3/32)	6 (1/4)	2 screws 4.5 (3/16)	60 (2-23/64)	35 (1-25/64)

#### DC Control Relays with 48...72V, 110...125V or 220...250V DC Electronic Coil

Type	a	b	c	c1	c2	Ød	d1	d2
700-CF, -CFB, -CFM	45 (1-25/32)	105 (4-1/8)	80.5 (3-11/64)	75.5 (3-3/32)	6 (1/4)	2 screws 4.5 (3/16)	60 (2-23/64)	35 (1-25/64)

#### DC Control Relays with Conventional Coil

Type	a	b	c	c1	c2	Ød	d1	d2
700-CF, -CFB, -CFM	45 (1-25/32)	81 (3-3/16)	106.5 (4-3/16)	101.5 (4)	6 (1/4)	2 screws 4.5 (3/16)	60 (2-23/64)	35 (1-25/64)

## Accessories - 700-CF Relays

Relay with		AC Control Relay		DC Control Relay	
		mm	(inches)	mm	(inches)
Auxiliary Contact for Front Mounting	2- or 4-pole	$c/c1 + 39$	$(c/c1 + 1 - 37/64)$	$c/c1 + 39$	$c/c1 + 1 - 37/64)$
Auxiliary Contact for Side Mounting	1- or 2-pole	$a + 9$	$(a + 23/64)$	$a + 9$	$(a + 23/64)$
Pneumatic Timing Module	—	$c/c1 + 58$	$(c/c1 + 2 - 23/64)$	—	—
Solid-state Timing Module	on coil terminal side	$b + 24$	$(b + 15/16)$	$b + 24$	$(b + 15/16)$
Mechanical Latching	—	$c/c1 + 61$	$(c/c1 + 2 - 31/64)$	—	—
DC Interface	on coil terminal side	$b + 9$	$(b + 23/64)$	—	—
Surge Suppressor	on coil terminal side	$b + 3$	$(b + 1/8)$	$b + 3$	$(b + 1/8)$
Labelling with:	label sheet	+0	(+0)	+0	(+0)
—	marking tag with cover	+0	(+0)	+0	(+0)
—	marking tag carrier for System V4/V5	+5.5	(+7/32)	+5.5	(+7/32)
—	marking tag carrier for System Bull. 1492W	+5.5	(+7/32)	+5.5	(+7/32)

## 700S-CF Control Relays

The 700S-CF Safety Control Relay provides mechanically or mirror contact performance, which are required in feedback circuits for safety applications. Bifurcated contacts are ideal for low energy feedback safety circuits where high contact reliability is required.

- IEC industrial safety relay
- Mechanically linked contacts as per IEC 60947-5-1
- Third party certification SUVA
- Red cover and mechanically linked contact symbol on front face
- Gold plated, bifurcated version for low level switching applications
- Permanently fixed front mounted auxiliary contact block



### Type CF and CFB Safety Control Relays — 8-Pole AC Coil Voltage (Ratings for 700S-CF Only)

AC-12		AC-15								Contacts		Standard Contacts (Main) Gold-Plated Bifurcated (Front) Cat. No.	Gold-Plated Bifurcated, All Contacts Cat. No. <sup>(1)</sup>		
I <sub>th</sub> [A]	I <sub>e</sub> [A]	Connection Diagrams								Main Contacts				N.O.	N.C.
										Main Contacts					
	40 °C	60 °C	24/48V	120 V	240 V	400 V	500 V	600 V	690 V						
Main Contacts	20	20	10	10	10	6	2.5	1	1			4	4	700S-CF440⊗BC	700S-CFB440⊗C
													5	3	700S-CF530⊗BC
Adder Deck Contacts	10	6	6	6	5	3	1.6	1	1			6	2	700S-CF620⊗BC	700S-CFB620⊗C

(1) Ratings for 700S-CFB are on Specifications

#### ⊗ AC Coil Voltage Code

The cat. no. as listed is incomplete. Select a coil voltage code from the table below to complete the cat. no. Example: Cat. No. 700S-CF440⊗BC becomes Cat. No. 700S-CF440DBC for 120V, 60 Hz.

[V]	12	24	32	36	42	48	100	100... 110	110	120	127	200	200... 220	208	208... 240	220... 230
50 Hz	R	K	V	W	X	Y	KP	—	D	P	S	KG	L	—	—	F
60 Hz	Q	J	—	V	—	X	—	KP	—	D	—	—	KG	H	L	—
50/60 Hz	—	KJ	—	—	—	KY	KP	—	KD	—	—	KG	KL	—	—	KL
[V]	230	230... 240	240	277	347	380	380... 400	400	400... 415	440	480	500	550	600		
50 Hz	—	VA	T	—	—	—	N	—	G	B	—	M	C	—		
60 Hz	—	—	A	T	I	E	—	—	—	N	B	—	—	C		
50/60 Hz	KF	—	KA	—	—	—	—	KN	—	KB	—	—	—	—		



**Type CF and CFB Safety Control Relays — 8-Pole DC Coil Voltage (Ratings for 700S-CF Only)**

AC-12		AC-15								Connection Diagrams		Contacts		Standard Contacts (Main) Gold-Plated Bifurcated (Front) Cat. No.	Gold Plated Bifurcated All Contacts Cat. No. <sup>(1)</sup>		
$I_{th}$ [A]		$I_e$ [A]								Main Contacts		Auxiliary Contacts				No. of N.O. Contacts	No. of N.C. Contacts
40 °C	60 °C	24/48V	120V	240V	400V	500V	600V	690V									
Main Contacts	20	20	10	10	10	6	2.5	1	1		4	4	700S-CF440⊗BC	700S-CFB440⊗C			
Main Contacts											5	3	700S-CF530⊗BC	700S-CFB530⊗C			
Adder Deck Contacts	10	6	6	6	5	3	1.6	1	1		6	2	700S-CF620⊗BC	700S-CFB620⊗C			

(1) Ratings for 700S-CFB are on Specifications

**⊗ DC Coil Voltage Code**

The cat. no. as listed is incomplete. Select a coil voltage code from the table below to complete the cat. no. Example: Cat. No. 700S-CFB440⊗C becomes Cat. No. 700S-CFB440EJC for 24V DC, electronic with diode.

[V]	9	12	24	36	48	48... 72	60	64	72	80	110	110... 125	115	125	220	220... 250	230	250
Electronic with diode	—	EQ	EJ	EW	—	EY	—	—	—	—	—	ED	—	—	—	EA	—	—
Electronic with diode/ Quick Pick-up	—	—	QJ	—	—	—	—	—	—	—	—	—	—	—	—	—	—	—

### Assignment of Contacts

Safety Control Relays with Front-mount Auxiliary Contacts, 8-Pole AC or DC Coil Voltage

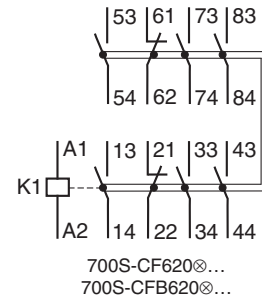
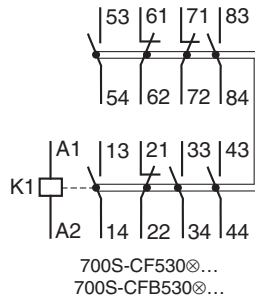
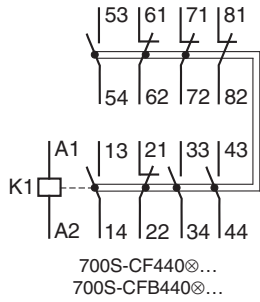

### Specifications - 700S-CF Relays

For more 700S-CF Specifications, see [Specifications - 700-CF... 700S-CF Relays on page 200](#).

			Cat. No. 700S-CF	Aux. Contact (Front-mounted)	
Mechanical Life		[Mil]	15	15	
Electrical Life	AC-15 (240V, 3 A)	[Mil]	1.5	1.5	
Weight	AC Coil	[g]	390	—	
Terminal Cross-Sections					
Terminal Type					
Terminal Size per IEC 947-1			2 x A4	2 x A4	
	Solid/ Stranded <sup>(1)</sup>	1 Conductor	[mm <sup>2</sup> ]	1.5...6	0.5...2.5
		2 Conductor	[mm <sup>2</sup> ]	1.5...6	0.75...2.5
Max. Wire Size per UL/CSA			[AWG]	16...10	18...14
Tightening Torque			[lb•in]	13.3...22	8.9...13.3
Tightening Torque			[N•m]	1.5...2.5	1...1.5
Standards Compliance	UL 508, CSA C22.2 No. 14, EN/IEC 60947-1, -5-1, Meets the material restrictions for European Directive 2002/95/EC - EU-RoHS				
Certifications	cULus Listed (File No. E14840, Guide NKCR/NKCR7), CE Marked, CCC Certified				

(1) For 16 or more strands, end ferrule is required

### Dimensions - 700S-CF Relays

Approximate dimensions are shown in millimeters (inches). Dimensions are not intended for manufacturing purposes.

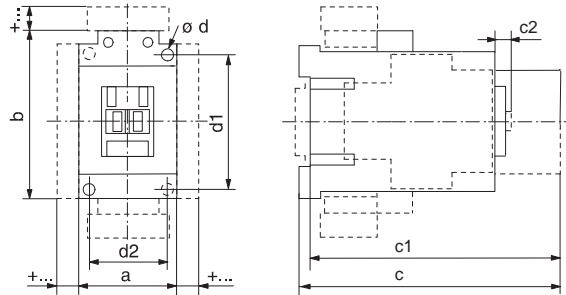

#### AC and DC Safety Control Relays with 12V or 24V DC Electronic Coil

Cat. No.	a	b	c	c1	c2	Ød	d1	d2
700S-CF	45	81	119.5	114.5	6	2 - 4.5	60	35
	(1-25/32)	(3-3/16)	(4-3/4)	(4-43/64)	(1/4)	(2 - 3/16)	(2-23/64)	(1-25/64)

#### DC Safety Control Relays with 48...72V, 110...125V or 220...250V DC Electronic Coil

Cat. No.	a	b	c	c1	c2	Ød	d1	d2
700S-CF	45	105	119.5	114.5	6	2 - 4.5	60	35
	(1-25/32)	(4-1/8)	(4-3/4)	(4-43/64)	(1/4)	(2 - 3/16)	(2-23/64)	(1-25/64)

#### DC Safety Control Relays with Conventional Coil

Cat. No.	a	b	c	c1	c2	Ød	d1	d2
700S-CF	45	81	145.5	140.5	6	2 - 4.5	60	35
	(1-25/32)	(3-3/16)	(5-49/64)	(5-37/64)	(1/4)	(2 - 3/16)	(2-23/64)	(1-25/64)

### Accessories - 700S-CF Relays

Safety Control Relays with	mm	[in.]
Auxiliary contact block for side mounting 1- or 2-pole	a + 9	(a + 23/64)
Electronic Timing Module on coil terminal side	b + 24	(b + 15/16)
Interface Module on coil terminal side	b + 9	(b + 23/64)
Surge Suppressor on coil terminal side	b + 3	(b + 1/8)
Labeling with label sheet	+ 0	(+ 0)
Marking tag sheet with clear cover	+ 0	(+ 0)
Marking tag adapter for System Bul. 1492W	+ 5.5	(+ 7/32)

### Mounting Position

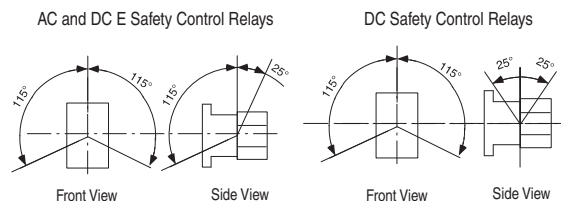

### Safety Relay Circuit With 5 Safety Outputs

- Use for E-stop control. E-stop will work properly if any one fault occurs (a fault could be one welded contact or one undesired open connection such as a loose wire).
- High output switching capability and long contact life.
- Circuit complies with EN 954 categories 1, 2, 3, 4.
- Helps prevent restart of the 5 safety outputs if there is a single fault anywhere in the system.
- Use (3) 700S-CF relays and this diagram to construct the circuit

Basic Circuit

(1) Output Circuit (3 Relays, 9 Terminal Blocks)

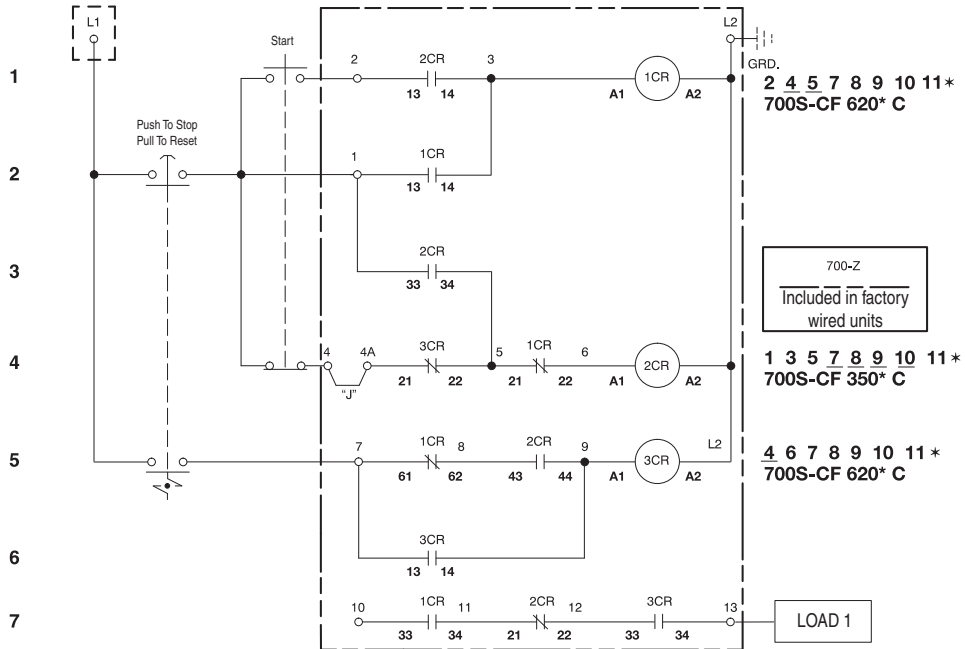

(5) Output Circuit (3 Relays, 17 Terminal Blocks)

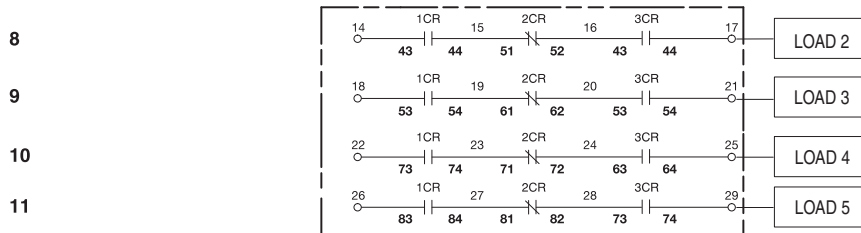

\* Numbers shown are the line numbers where the contacts for this relay appear. Contact your local Rockwell Automation sales office or Allen-Bradley distributor for availability.

## 700-K Miniature Control Relays

- IEC compact industrial relay
- IP2X Finger Protection
- Bifurcated contacts for low-level signals
- Optional integrated coil protection diode



### 4-Pole AC or DC Coil Voltage

AC-12		AC-15 (B600)							Connection Diagrams	Contacts		Pkg. Qty. <sup>(2)</sup>	Cat. No.
<i>I</i> <sub>th</sub> [A]		<i>I</i> <sub>e</sub> [A]								N.O.	N.C.		
40 °C	60 °C	24/48V	120V	240V	400V	500V	600V	690V					
10	6	3	3	2	1	1	0.6	0.6		4	0	1	700-K40E-⊗
										3	1	1	700-K31Z-⊗
										2	2	1	700-K22Z-⊗
										1+1L <sup>(1)</sup>	1+1L	1	700-KL22Z-⊗

(1) 1L = Late Break N.C. / Early Make N.O.

(2) May be ordered in package quantities of 20. Add letter M to the end of the cat. no. Example: 700-K40E-ZJM.

### ⊗ Coil Voltage Codes

The cat. no. as listed is incomplete. Select a coil voltage code from the table below to complete the cat. no. Example: 230V, 50/60 Hz: Cat. No. 700-K40E-⊗ becomes Cat. No. 700-K40E-KF. For other voltages, consult your local Rockwell Automation sales office or Allen-Bradley distributor.

For Screw Type Terminal Versions															
	[V]	12	24	110	120	125	220	230	240	250	400	440	480	525	600
AC, 50 Hz		—	—	D	—	—	—	—	—	—	—	B	—	VC	—
AC, 60 Hz		—	—	—	D	—	—	—	—	—	—	—	B	—	VC
AC, 50/60 Hz		—	KJ	—	—	—	—	KF	KA	—	KN	—	—	—	—
Standard	DC	ZQ	ZJ	ZD	—	ZS	ZA	—	—	ZT	—	—	—	—	—
Standard diode		—	DJ	—	—	—	—	—	—	—	—	—	—	—	—

For Spring Clamp Type Terminal Versions															
	[V]	12	24	110	120	125	220	230	240	250	400	440	480	525	600
AC, 50 Hz		—	—	D	—	—	—	—	—	—	—	—	—	—	—
AC, 60 Hz		—	—	—	D	—	—	—	—	—	—	—	—	—	—
AC, 50/60 Hz		—	KJ	—	—	—	—	KF	—	—	—	—	—	—	—
Standard	DC	—	ZJ	ZD	—	—	—	—	—	—	—	—	—	—	—
Standard diode		—	DJ	—	—	—	—	—	—	—	—	—	—	—	—

### Assignment of Contacts









**Device Combinations in Accordance with IEC 60947-1 / -4-1**

Table valid for: AC / DC = 0.85...1.1 x U<sub>s</sub>, T<sub>amb</sub> = -25 °C...+60 °C, normal position (horizontal rail mounting). Also valid for 700-KR relays and 100-KR auxiliary contacts. <sup>(3)</sup>

Auxiliary Contact Blocks		Control Relays 700-K (AC and DC Control)				
Cat. No.	Circuit Diagram	Control	700-K22Z-	700-K31Z-	700-K40E-	700-KL22Z-
<b>Front Mounting</b>						
100-KFA02E		AC/DC	—	31Z + 02E = 33Y <sup>(1)</sup>	40E + 02E = 42Y	—
100-KFA11E		AC/DC	22Z + 11E = 33Y	31Z + 11E = 42Y	40E + 11E = 51Y	L22Z + 11E = L33Y
100-KFA20E		AC/DC	22Z + 20E = 42Y	31Z + 20E = 51Y	40E + 20E = 60Y	L22Z + 20E = L42Y
100-KFA04E		AC/DC	—	—	40E + 04E = 44Y <sup>(1)</sup>	—
100-KFA13E		AC/DC	—	31Z + 13E = 44Y <sup>(1)</sup>	40E + 13E = 53Y	—
100-KFA22Z		AC/DC	—	31Z + 22Z = 53Y <sup>(1)</sup>	40E + 22Z = 62Y	—
100-KFA31Z		AC/DC	—	—	40E + 31Z = 71Y <sup>(2)</sup>	—
100-KFA40E		AC/DC	22Z + 40E = 62Y	31Z + 40E = 71Y	40E + 40E = 80Y	L22Z + 40E = L62Y



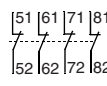
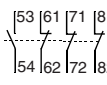
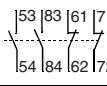
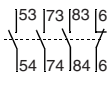

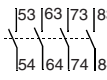
(1) T<sub>amb</sub> max. +40 °C  
 (2) T<sub>amb</sub> max. +40 °C and only allowed for coil voltage 24V DC or 230V AC  
 (3) For other operating limits, please contact our technical consultant.

## Auxiliary Contact Blocks

Photo	Description	Connection Diagrams			For Use With	Pkg. Qty. (1)	Screw Type Terminals	Spring Clamp Terminals
			N.O.	N.C.			Cat. No.	Cat. No.
	<b>Front-mounted auxiliary contacts</b> <ul style="list-style-type: none"> <li>Auxiliary Contact Blocks</li> <li>2- and 4-pole versions</li> <li>Choice of contact configurations</li> <li>Snap on, no tools required</li> <li>Electronic-compatible bifurcated contacts for signals down to 15V / 2 mA</li> </ul>		0	2	100/104-K, 700-K	1	100-KFA02E	100-KRFA02E
			1	1	100/104-K, 700-K	1	100-KFA11E	100-KRFA11E
			2	0	100/104-K, 700-K	1	100-KFA20E	100-KRFA20E
		0	4	100/104-K, 700-K	1	100-KFA04E	100-KRFA04E	
		1	3	100/104-K, 700-K	1	100-KFA13E	100-KRFA13E	
		2	2	100/104-K, 700-K	1	100-KFA22Z	100-KRFA22Z	
		3	1	100/104-K, 700-K	1	100-KFA31Z	100-KRFA31Z	
			4	0	100/104-K, 700-K	1	100-KFA40E	100-KRFA40E

(1) May be ordered in package quantities of 10. Add letter **M** to the end of the cat. no. Example: **100-KFA02EM**.

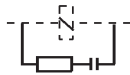
## Control Modules

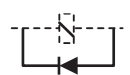
Photo	Description	Connection Diagrams	For Use With	Pkg. Qty.	Cat. No.
	<b>Mechanical Interlock</b> <ul style="list-style-type: none"> <li>For interlocking of two adjacent contactors</li> <li>No added width to contactor assembly</li> <li>Front mount plug-in type</li> <li>Optional auxiliary contact blocks and suppressor modules mount onto the interlock</li> </ul>		100/104-K/-KR, 700-K/-KR	1	100-KMCH
	<b>Surge Suppressor</b> <ul style="list-style-type: none"> <li>Plug-in type</li> <li>Limits surge voltage on coil drop-off</li> </ul>		100/104-K/-KR, 700-K/-KR	1 <sup>(1)</sup>	100-KFSC50
				1 <sup>(1)</sup>	100-KFSC280
				1 <sup>(1)</sup>	100-KFSC480
			100/104-K/-KR, 700-K/-KR	1 <sup>(1)</sup>	100-KFSV55
				1 <sup>(1)</sup>	100-KFSV136
				1 <sup>(1)</sup>	100-KFSV277
	100/104-K/-KR, 700-K/-KR	1 <sup>(1)</sup>	100-KFSD250		

(1) May be ordered in package quantities of 10. Add letter **M** to the end of the cat. no. Example: **100-KFSC50M**.

## Accessories

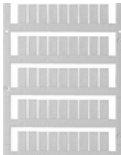
Photo	Description	Pkg. Qty.	Cat. No.
	<p><b>Label Sheet</b> 105 self-adhesive paper labels each, 6 x 17 mm</p>	10	100-FMS
	<p><b>Snap-In Marker Card</b></p>	5	1492-M6X12







## IEC Specifications - 700-K... Relays

			700-K	700-KR
<b>AC-12 Rated Thermal Current Ambient temperature 40°C</b>				
$I_{th}$	24...240V	[A]	10	
	230...500V	[A]	10	
	230...690V	[A]	10	
<b>Ambient temperature 60°C</b>				
$I_{th}$	24...240V	[A]	6	
	230...500V	[A]	6	
	230...690V	[A]	6	
<b>AC-15/B600 Switching of Solenoids and contactors</b>				
$I_e$	24V	[A]	3	
	48V	[A]	3	
	120V	[A]	3	
	230V	[A]	2	
	240V	[A]	2	
	400V	[A]	1.2	
	480V	[A]	1	
	500V	[A]	1	
	600V	[A]	0.6	
	690V	[A]	0.6	
<b>Short-circuit Protection</b>				
	Fuse gG	[A]	10	
<b>Min. Switching Capacity 15V</b>				
		[mA]	2	
<b>Resistance and Power Dissipation</b>				
Main current circuit resistance, 1 pole		[mΩ]	6.5	
Power dissipation, 4 poles		[W]	2.6	
<b>Total power dissipation</b>				
	AC control, warm	[W]	4.4	
	DC control, warm	[W]	5.2	
<b>Lifespan</b>				
Mechanical		[Mio. op.]	15	
Electrical AC-15 (240V / 2 A)		[Mio. op.]	0.7	
<b>Weight</b>				
	AC control	kg (lbs.)	0.16 (0.35)	
	DC control	kg (lbs.)	0.2 (0.44)	
<b>Load Carrying Capacity per UL/CSA</b>				
Rated voltage	AC	[V]	max. 600	
Continuous rating	40 °C	[A]	10	6
Switching capacity	AC	[A]	B 600	
Rated voltage	DC	[V]	max. 600	
Switching capacity	DC	[A]	Q 600	

			700-K
<b>DC-13/Q600</b>			
1 pole	24V	[A]	2.3
	48V	[A]	1
	110V	[A]	0.55
	125V	[A]	0.55
	220V	[A]	0.27
	250V	[A]	0.27
	400V	[A]	0.15
	440V	[A]	0.15
	600V	[A]	0.1

### Cross Sections

<b>Conductor Cross Sections - Main Contacts, Auxiliary Contacts, and Coil Terminals</b>				<b>700-K</b>	<b>700-KR</b>	
<b>Terminal type</b>				(1) 		
	Fine stranded with ferrule	(1) Conductor (2) Conductors	[mm <sup>2</sup> ] [mm <sup>2</sup> ]	0.75...2.5 0.75...2.5	0.50...2.5 0.50...2.5	
 	Solid or coarse stranded	(1) Conductor (2) Conductors	[mm <sup>2</sup> ] [mm <sup>2</sup> ]	1...4 1...2.5 + 1...4	0.75...2.5 <sup>(3)</sup> 0.75...2.5 <sup>(3)</sup>	
Recommended torque				[Nm]	1.2	—
Cross section per UL/CSA				[AWG]	18...12 <sup>(2)</sup>	18...14 <sup>(3)</sup>
Recommended torque				[lb-in]	10.6	—

- (1) Pozidriv No. 2 / Blade No. 3 screw
- (2) Use same cross sections
- (3) Stranded wire only

**Coil Data**

			<b>700-K</b>
<b>Operating Limits</b>			
AC control 50 Hz, 60 Hz, 50/60 Hz	pick-up	[x Us]	0.85...1.1
	dropout	[x Us]	0.2...0.75
DC control	pick-up	[x Us]	0.8...1.1 9, 12, 24, 110V DC: 0.7...1.25
	dropout	[x Us]	0.1...0.75
<b>Coil Consumption</b>			
AC control 50 Hz, 60 Hz, 50/60 Hz	pick-up	[VA/W]	35/32
	hold-in	[VA/W]	5/1.8
DC control	pick-up	[W]	cold 3.0, warm 2.6
	hold-in	[W]	cold 3.0, warm 2.6
<b>Operating Times</b>			
AC	closing delay	[ms]	15...40
	opening delay	[ms]	15...33
With RC module	opening delay	[ms]	15...28
DC	closing delay	[ms]	18...40
	opening delay	[ms]	6...12
With integrated diode	closing delay	[ms]	8...12
With external diode	opening delay	[ms]	35...50

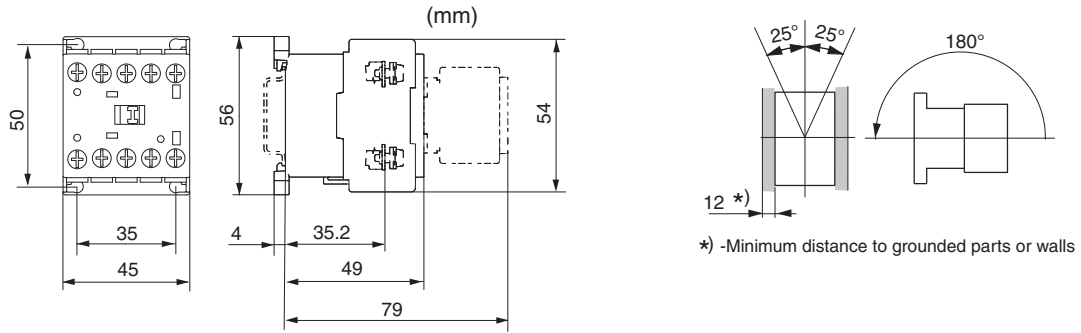

### Dimensions - 700-K... Relays

Approximate dimensions are shown in millimeters. To convert millimeters to inches multiply by 0.0394. Dimensions are not intended to be used for manufacturing purposes.





## Solid-state Relays

### Product Overview

				
<b>Bulletin No.</b>	<b>700-5A</b>		<b>700-5C</b>	
<b>Type</b>	Tube Base, Socketed		Miniature, Ice Cube Socketed	
<b>Features</b>	Compatible with 700-HN100, 125, 108, and 204 socket, LED status, zero-cross switching		Compatible with 700-HN103 or 128 socket, LED Status, and Zero-cross AC Switching Options	
<b>Load Type</b>	AC (47...63 Hz)	DC	AC (47...63 Hz)	DC
<b>Load Voltage Range</b>	75...264V AC	3...125V DC	75...264V AC	3...52.8V DC or 3...125V DC
<b>Load Current Max. (Continuous)</b>	5 A	3 A	3 A	3 A @ 48V DC or 2 A @ 110V DC
<b>Max. Leakage Current to Load</b>	5 mA @ 100V, 10 mA @ 200V	5 mA @ 125V	5 mA @ 100V AC	10 mA @ 200V AC, 5 mA @ 50V DC or 0.1 mA @ 100V DC
<b>Zero Cross Load Switching</b>	Yes	Not Applicable	Yes (optional)	Not Applicable
<b>Equivalent Electromechanical Relay Contact Arrangement</b>	Form A		Form A	
<b>Rated Control (Input) Voltage</b>	5...24V DC		5...24V DC, 100...110V AC, 200/220V AC	5...24V DC
<b>LED Indicator</b>	Yes		Yes (optional)	Yes (optional for 48V DC)
<b>Mounting Method</b>	Panel or DIN with socket		Panel or DIN with socket	
<b>Dielectric Strength</b>	1500V AC, 50/60 Hz, 1 min.		1500V AC, 50/60 Hz, 1 min.	
<b>Certification</b>	cURus, CE, VDE		cURus, CE, VDE	
<b>Max. Ambient Operating Temperature</b>	-30...80 °C (no condensation)		-30...80 °C (no condensation)	
<b>Page</b>	<a href="#">223</a>		<a href="#">228</a>	

**Product Overview**

							
<b>Bulletin No.</b>	<b>700-SF</b>	<b>700-SH</b>	<b>700-SK</b>				
<b>Type</b>	Square Base, Socketed	Hockey Puck	Slim Line, Socketed				
<b>Features (1)</b>	Compatible with 700-HN116 socket, LED status, zero-cross AC switching	Panel/DIN Mount, High Current, Protective Cover, LED Status	Compatible with 700-HN121 socket. Supports Input (sensor) module or Output (SSR) module				
<b>Load Type</b>	AC (47...63 Hz)	AC (47...63 Hz) 3...60V DC	Output Module		Input Module		
	DC		AC (47...63 Hz)	DC	AC (47...63 Hz)	DC	
<b>Load Voltage Range</b>	75...264V AC	3...50V DC, 24...265V AC 42...530V AC, 42...265V AC, 42...660V AC	75...264V AC	4...60V DC, 40...200V DC	Field Input: 60...264V AC	Field Input: 6.6...32V DC	
<b>Load Current Max. (Continuous)</b>	3 A	10 A/100 A $\ddagger$	2 A	2 A @ 60V, 1.5 A @ 200V	Supply Current: 0.1...100 mA	Supply Current: 0.1...100 mA	
<b>Max. Leakage Current to Load</b>	5 mA @ 100V AC, 10 mA @ 200V AC	5 mA @ 50V DC	<3 mA	1.5 mA	1 mA	5 $\mu$ A	5 $\mu$ A
<b>Zero Cross Load Switching</b>	Yes	Not Applicable	Yes	Yes (optional)	N/A	No	N/A
<b>Equivalent Electromechanical Relay Contact Arrangement</b>	Form A	Form A	Form A	Form A			
<b>Rated Control (Input) Voltage</b>	4V DC or 24V DC	3...32V DC, 4...32V DC, 80...130V AC, 20...260V AC 20...280V AC/22...48V DC	5...24V DC				
<b>LED Indicator</b>	Yes	Yes	Yes				
<b>Mounting Method</b>	Panel or DIN with socket	Panel without heat sink, Panel, or DIN with heat sink	Panel or DIN with socket				
<b>Dielectric Strength</b>	1500V AC, 50/60 Hz, 1 min.	>4000V AC RMS	4000V AC, 50/60 Hz, 1 min.				
<b>Certification</b>	cURus, CE, VDE	cURus, CE, CSA	cURus, CE, TÜV				
<b>Max. Ambient Operating Temperature</b>	-30...80 °C (no condensation)	-20...70 °C (no condensation)	-30...80 °C (no condensation)				
<b>Page</b>	<a href="#">233</a>	<a href="#">237</a>	<a href="#">246</a>				

(1) See [Solid-state Relay Glossary on page 223](#) for term definitions.

## Solid-state Relay Glossary

Terms		Meaning
Insulation	Basic insulation	Insulation for basic protection from electric shock (IEC950 1.2.9.2)
	Supplemental insulation	Independent insulation that is provided outside of basic insulation to protect from electric shock when the basic insulation breaks down (IEC950 1.2.9.3)
	Reinforced insulation	A single-layer of insulation (IEC950 1.2.9.5) that provides the same protection from electric shock as double insulation (insulation including both basic and supplemental insulation) according to conditions stipulated in IEC950 standards
Circuit functions	Zero cross circuit	A circuit that starts operation with the AC load voltage at close to zero-phase.
	Trigger circuit	A circuit for controlling the triac or thyristor trigger signal, which turns the load current ON and OFF.
Input	Isolated input circuit	If the external circuit is prone to generating noise, or if wires from external sources are prone to the influence of inductive noise, in order to prevent malfunctions due to noise, it is necessary to electrically isolate internal circuits and external circuits (output circuits). An isolated input circuit is a circuit that isolates inputs and outputs by using components that are not connected electrically but that can transmit signals, such as contact relays or photocouplers.
	Photocoupler	A component that runs the electric signal into a light emitter (for example, LED), changes it to a light signal, and then returns it to an electric signal using a photoelectric conversion element, such as a photo transistor. The space that is used for transferring the light signal is isolated thus providing good insulation and a high propagation speed.
	Rated voltage	The voltage that serves as the standard value of an input signal voltage
	Pickup (must-operate) voltage	Minimum input voltage when the output status changes from OFF to ON.
	Input impedance	The impedance of the input circuit and the resistance of current-limiting resistors used. Impedance varies with the input signal voltage in case of the constant current input method.
	Operating voltage	The permissible voltage range within which the voltage of an input signal voltage may fluctuate.
	Dropout (Reset) voltage	Maximum input voltage when the output status changes from ON to OFF.
	Input current	The current value when the rated voltage is applied.
Output	Load voltage	This is the effective value for the power supply voltage that can be used for load switching or in the continuous-OFF state.
	Maximum load current (continuous)	The effective value of the maximum current that can continuously flow into the output terminals under specified cooling conditions (i.e., the size, materials, thickness of the heat sink, and an ambient temperature radiating condition).
	Leakage current	The effective value of the current that can flow into the output terminals when a specified load voltage is applied to the SSR with the output turned OFF.
	Output ON voltage drop	The effective value of the AC voltage that appears across the output terminals when the maximum load current flows through the SSR under specified cooling conditions (such as the size, material, and thickness of heat sink, ambient temperature radiation conditions, etc.).
	Minimum load current (continuous)	The minimum load current at which the SSR can operate normally.
	Snubber circuit	A circuit consisting of a resistor R and capacitor C, which prevents faulty ignition from occurring in the SSR triac by suppressing a sudden rise in the voltage that is applied to the triac.
	Semiconductor output element (switching element)	This is a generic name for semiconductors such as the thyristor, triac, power transistor, and power MOS FET. In particular, triacs are often used in SSRs because they allow switching to be performed with one element.
	Repetitive peak OFF-state voltage (VDRM)	This is a rating for an output semiconductor that used in an SSR for AC loads.
Collector-emitter voltage (VCEO)	This is a rating for an output semiconductor that used in an SSR for DC loads.	

Terms		Meaning
Characteristics	Operating (pick-up) time	A time lag between the moment a specified signal voltage is imposed to the input terminals and the output is turned ON.
	Release (drop-out) time	A time lag between the moment the imposed signal input is turned OFF and the output is turned OFF.
	Insulation resistance	The resistance between the input and output terminals or I/O terminals and metal housing (heat sink) when DC voltage is imposed.
	Dielectric strength	The effective AC voltage that the SSR can withstand when it is applied between the input terminals and output terminals or I/O terminals and metal housing (heat sink) for more than 1 minute.
	Ambient temperature and humidity (operating)	The ranges of temperature and humidity in which the SSR can operate normally under specified cooling, input/output voltage, and current conditions.
	Storage temperature	The temperature range in which the SSR can be stored without voltage imposition.
Others	Inrush current resistance	A current, which can be applied for short periods of time to the electrical element.
	Counter-electromotive force	Extremely steep voltage rise which occurs when the load switched or turned OFF.
	Recommended applicable load	The recommended load capacity which takes into account the safety factors of ambient temperature and inrush current.
	Bleeder resistance	The resistance connected in parallel to the load in order to increase apparently small load currents, so that the ON/OFF of minute currents functions normally. (It is also used to shunt leakage currents.)

**Solid-state Relay Switching Capacity**

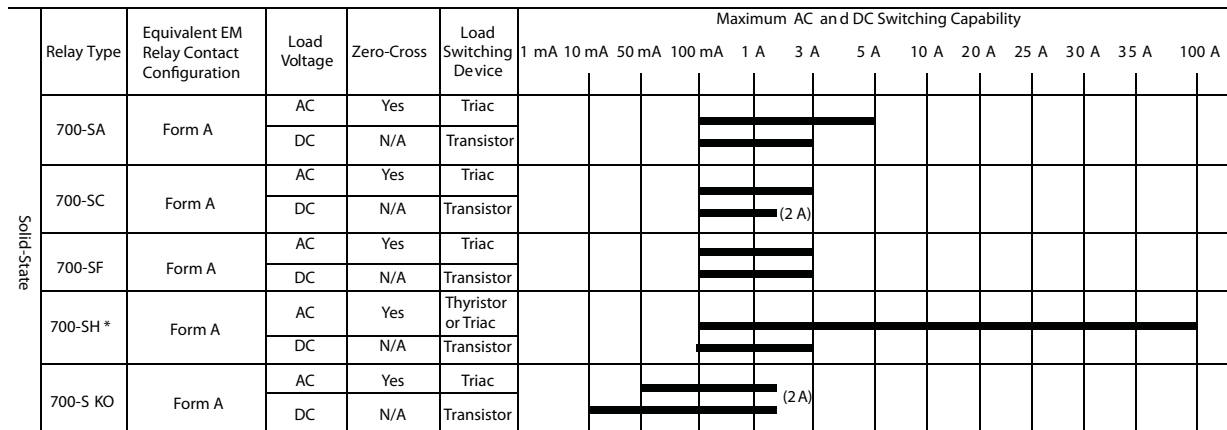

**IMPORTANT** \* Requires a heat sink to reach maximum current value.









## 700-SA Tube Base Relays

- 5 A (resistive) max. continuous load (output) current
- 264V AC or 125V DC max. load voltage options
- Photocoupler isolation between control and load voltage
- LED indicator (standard) for input/logic ON/OFF status monitoring
- 700-HN100, -HN125, -HN 202, or -HN108 specialty socket compatible
- 700-HT2 timing module



Input-to-Output Isolation Method	Zero Cross Function	Status Indicator	Output (Load) Max. Continuous Current and Rated Voltage Range	Rated Input (Control) Voltage	Cat. No.
Photocoupler	Yes	Yes	5 A @ 100...240V AC (47...63 Hz)	5...24V DC	700-SAZY5Z25
	Not Applicable		3 A @ 5...110V DC		700-SANY3Z25

## Accessories - 700-SA Relays

Photo	Description	Pkg. Quantity	Cat. No.
	<b>Screw Terminal Tube Base Socket — Panel or DIN Rail Mounting; Guarded Terminal Construction.</b> 8 Pin for use with DPDT 700-HA Relays.	10	700-HN100
	<b>Specialty Socket</b> 8 Pin back wired socket with solder terminals	10	700-HN108
	<b>Screw Terminal Tube Base Socket — Panel or DIN Rail Mounting; Open Style Construction.</b> 8 Pin for use with DPDT 700-HA Relays. No retainer clip required.	10	700-HN125
	<b>DIN (#3) symmetrical hat rail</b> 35 x 7.5 x 1 m	10	199-DR1
	<b>Pre-Printed Identification Tags</b> — contains 10 sheets of pre-printed and blank tags. Each sheet contains 13 sets of the markings CR...9CR, TR...9TR, M...9M, F, R, 1S, and 117 blank tags. Tags are peel-off with sticky backing for easy placement on relays.	10	700-N40
	<b>Blank Identification Tags</b> — contains 10 sheets of blank identification tags for customer specialized printing. Each sheet contains 546 blank tags. Tags are peel-off with sticky backing for easy placement on relays.	10	700-N41
	<b>Retainer Clip</b> for Sockets with 700-SA AND 700-HB Relays. Secures relay in socket.	10	700-HN158
	<b>8-Pin Socket</b> — <b>Can Be Used With or Without Timing Module or Surge Suppressor.</b> Screw Terminal Tube Base Sockets — panel or DIN Rail mounting. Guarded terminal construction. Used with DPDT 700-HA Relays.	10	700-HN204

## Specifications - 700-SA Relays

### Control/Input Ratings

Cat. No.	Rated Control Voltage	Max. Operating Control Voltage Range	Max. Reverse Control Voltage	Impedance	Control Voltage Levels	
					Pick-up Voltage	Drop-out Voltage
700-SAZY5Z25	5...24V DC	4...32V DC	-32V DC	15 mA max. <sup>(1)</sup>	4V DC max.	1V DC min.
700-SANY3Z25		4...30V DC	-30V DC	1.5 k $\Omega$ (+20% -10%)		

### Load/Output Ratings

Cat. No.	Rated Load Voltage	Maximum Load Voltage Range	Continuous Load Current (Resistive) [A]		Max. Inrush Current <sup>(3)</sup>
			Min.	Max. <sup>(2)</sup>	
700-SAZY5Z25	100...240V AC	75...264V AC	0.1	5.0	80 A, @ 50/60 Hz for 1 cycle
700-SANY3Z25	5...110V DC	3...125V DC	0.1	3.0	12 A (10 ms)

### Characteristics

Description	Cat. No. 700-SAZY5Z25	Cat. No. 700-SANY3Z25
Load Switching Method/Device	Triac	Transistor
Pick-up Time	1/2 cycle of load power source cycle time <sup>(4)</sup> + 1 ms max.	0.5 ms max.
Drop-out Time	1/2 cycle of load power source cycle time <sup>(4)</sup> + 1 ms max.	2.5 ms max.
Output ON Voltage Drop	1.6V (RMS) max.	1.5V max.
Output Leakage Current	5 mA max. (at 100V AC); 10 mA max. (at 200V AC)	5 mA max. (at 125V DC)
Output $V_{DRM}$ $V_{CEO}$ (V)	600	150
Output di/dt (V/uS)	50	—
Output dv/dt (V/uS)	500	—
Output $I^2t$ (A <sup>2</sup> S)	41.6	—
Output Tj (°C) Max.	125	150
Insulation Resistance	100 M $\Omega$ min. (at 500V DC)	
Dielectric Strength	1500V AC, 50/60 Hz for 1 min	
Vibration Resistance (Max.)	10...55 Hz, 1.5 mm double amplitude (10 G)	
Shock Resistance (max.)	1000 m/s <sup>2</sup> (100 G)	
Ambient Temperature	Operating	-30...80 °C (-22...176 °F) with no icing or condensation
	Storage	-30...100 °C (-22...212 °F) with no icing or condensation
Ambient Humidity	45...85% (no condensation)	
Standards Compliance	UL 508, CSA C22.2 No. 14, EN 60947-1, -4-3	
Certifications	cURus Recognized (File No. E96956, Guide NMFT2/NMFT8), CE Marked, VDE Certified	
Weight	Approx. 70 g	

- (1) With constant current input system. SSR input impedance varies with a change in input (control) voltage.
- (2) See the following graph "Load Current Vs. Ambient Temperature Characteristics" for additional load current details.
- (3) If the SSR operation is continuous ON/OFF, this value should be reduced by 50%. See "Inrush Current Resistivity" graph.
- (4) 60 Hz full cycle time = 16.6 ms, 50 Hz full cycle time = 20 ms.

#### Load Current vs. Ambient Temperature Characteristics

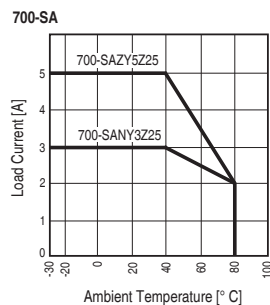

#### Inrush Current Resistivity <sup>(1)</sup>

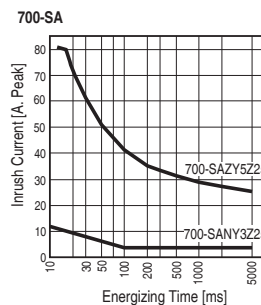

- (1) Inrush current resistivity is the ability of an SSR to withstand a large surge current for a short period. Surges are considered non-repetitive (max. repeatability once every 5 seconds). Keep the inrush current to half the rated value if it occurs repetitively. Exceeding the non-repetitive inrush current will damage the SSR.

### Terminal Arrangement (Bottom View)

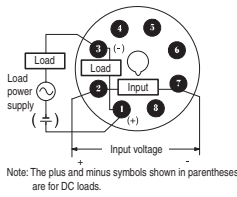

### Basic Application Considerations

#### High Density Mounting of Multiple Solid-state Relays (SSRs)

If multiple SSRs are installed side by side, the outer case wall of the SSR serves to dissipate heat. Install the relays so that they are adequately ventilated. If poor ventilation is unavoidable, reduce the load current to half.

#### Protective Component

When controlling AC inductive loads, connect an inrush/surge absorbing device (varistor) across the SSR load terminals. If the SSR has built-in surge suppression (s 700-SE and 700-SH) and additional surge suppression is required, connect the varistor across the terminals of the load device. Select a varistor that meets the conditions of the load voltage that is outlined in the table.

Load Voltage	Varistor Voltage [V]	Varistor Surge Resistance
100...120V AC	240...270	1000 A min.
200...240V AC	440...470	
380...480V AC	820...1000	

**TIP** For additional details on solid-state relays, see the Solid-State Relay Application Guide, publication [700-AT001](#).

For a DC inductive load, a diode should be connected parallel to the load to absorb the counter electromotive force (OFF) of the load.

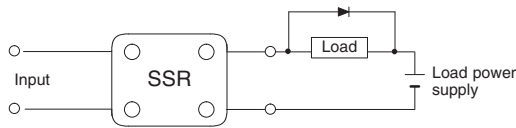

#### EMC Directive Compliance

1. AC-switching models comply with EMC Directives under the following conditions:

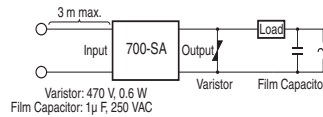

- Connect a varistor between the output terminals.
- Connect a film capacitor to the load power supply.
- The input cable must be less than 3 m.

2. DC-switching models comply with EMC Directives under the following conditions:

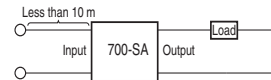

- The input cable must be less than 10 m.

### Dimensions - 700-SA Relays

All units in millimeters unless otherwise indicated. To convert millimeters to inches multiply by 0.0394. Dimensions are not intended to be used for manufacturing purposes.

700-SA <sup>(1)</sup>

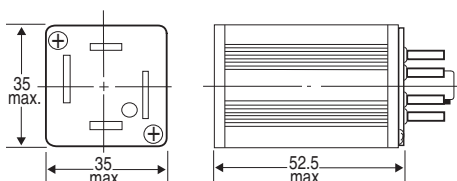

(1) 700-SA is compatible with Cat. Nos. 700-HN100, -108, -125, and -204 (sockets).

## 700-SC Ice Cube Relays

- 3 A (resistive) max. continuous load (output) current
- 264V AC, 48V DC or 125V DC max. load voltage options
- 5...24V DC or 110/220V AC control (input) voltage options
- LED indicator (optional) for input/logic On/Off status monitoring
- 700-HN103, 700-HN104, or 700-HN128 socket compatible
- Compatible with 700-AT1 or 700-AT2 timer modules



Input-to-Output Isolation Method	Zero Cross Function	Status Indicator	Output (Load) Max. Continuous Current and Rated Voltage Range	Rated Input (Control) Voltage	Cat. No.
Photocoupler	Yes	Yes	3 A @ 100...240V AC <sup>(1)</sup>	5...24V DC	700-SCZY3Z25
			2 A @ 100...240V AC <sup>(1)</sup>	100/110V AC	700-SCZY2A1
Phototriac	No	3 A @ 100...240V AC <sup>(1)</sup>		200/220V AC	700-SCZY2A2
			24V DC	700-SCTY3Z24	
Photocoupler	Not Applicable	No	3 A @ 4...48V DC	5...24V DC	700-SCNY3Z25
	Yes			4...24V DC	700-SCZN3Z26
Phototriac	No	No	3 A @ 100...240V AC <sup>(1)</sup>	24V DC	700-SCTN3Z24
Photocoupler	Not Applicable			4...24V DC	700-SCNN3Z26
				24V DC	700-SCNN2Z25

(1) 47...63 Hz

## Accessories - 700-SC Relays







Photo	Description	Pkg. Quantity	Cat. No.
	<b>Screw Terminal Socket</b> — Panel or DIN Rail Mounting; Guarded Terminal Construction. $I_{th} = 10$ A per pole. 14-blade miniature socket for use with 700-SC Relays.	10	700-HN103
	<b>Screw Terminal Socket</b> — Panel or DIN Rail Mounting; Guarded Terminal Construction $I_{th} = 10$ A per pole. 14-blade miniature socket for use with 700-SC relays. This socket has coil and contact separation and the ability to plug in optional plug-in modules (700-A__ accessories: LED, Surge Suppression, Timing Modules)	10	700-HN104
	<b>Screw Terminal Base Socket</b> — Panel or DIN Rail Mounting; Open-Style Construction $I_{th} = 10$ A per pole. 14-blade miniature socket for use with 700-SC Relays.	10	700-HN128
	<b>DIN (#3) symmetrical hat rail</b> 35 x 7.5 x 1 m	10	199-DR1

Photo	Description	Pkg. Quantity	Cat. No.
	<b>Pre-Printed Identification Tags</b> — contains 10 sheets of pre-printed and blank tags. Each sheet contains 13 sets of the markings CR...9CR, TR...9TR, M...9M, F, R, 1S, and 117 blank tags. Tags are peel-off with sticky backing for easy placement on relays.	10	700-N40
	<b>Blank Identification Tags</b> — contains 10 sheets of blank identification tags for customer specialized printing. Each sheet contains 546 blank tags. Tags are peel-off with sticky backing for easy placement on relays.	10	700-N41
	<b>Retainer Clip for Cat. Nos. 700-HN103, -HN104, and -HN128 Sockets with 700-HC Relays.</b> Secures relay in socket.	10	(1) 700-HN114

(1) Series B retainer clip must be used with 700-SC

## Specifications- 700-SC Relays

### Control/Input Ratings

Cat. No.	Rated Control Voltage	Max. Operating Control Voltage Range	Max. Reverse Control Voltage [V]	Impedance	Control Voltage Levels	
					Pick-up Voltage	Drop-out Voltage
700-SCZY3Z25	5...24V DC	4...28V DC	-28.8	15mAmax. <sup>(1)</sup>	4V DC max.	1V DC min.
700-SCZY2A1	100/110V AC	75...125V AC	NA	41 k $\Omega$ $\pm$ 20%	75V AC max.	20V AC min.
700-SCZY2A2	200/220V AC	150...250V AC	NA	72 k $\Omega$ $\pm$ 20%	150V AC max.	40V AC min.
700-SCTY3Z24	24V DC	19.2...28.8V DC	-28.8	2 k $\Omega$ $\pm$ 20%	19.2V DC max.	1V DC min.
700-SCNY3Z25	5...24V DC	4...28V DC	-28	1.5 k $\Omega$ $\pm$ 20% / -10% <sub>(2)</sub>	4V DC max.	
700-SCZN3Z26	4...24V DC	3...28V DC	-28.8	15mAmax. <sup>(1)</sup>	3V DC max.	
700-SCTN3Z24	24V DC	19.2...28.8V DC	-28.8	2 k $\Omega$ $\pm$ 20%	19.2V DC max.	
700-SCNN3Z26	4...24V DC	3...28V DC	-28	1.5 k $\Omega$ $\pm$ 20% / -10% <sub>(2)</sub>	3V DC max.	
700-SCNN2Z25	5...24V DC		-28.8			

### Load/Output Ratings

Cat. No.	Rated Control Voltage	Max. Load Voltage Range	Continuous Load Current (Resistive) [A]		Max. Inrush Current <sup>(4)</sup>
			Min.	Max. <sup>(3)</sup>	
700-SCZY3Z25	100...240V AC	75...264V AC	0.1	3	45 A (@50/60 Hz, 1 cycle)
700-SCTY3Z24					
700-SCZN3Z26					
700-SCTN3Z24			0.1	2	
700-SCZY2A1					
700-SCZY2A2					
700-SCNN3Z26	4...48V DC	3...52.8V DC	0.1	3	18 A (10 ms)
700-SCNY3Z25					
700-SCNN2Z25	5...110V DC	3...125V DC	0.1	2	10 A (10 ms)

(1) With constant current input circuit system. SSR impedance varies with a change in input (control) voltage.

(2) Input impedance attains its maximum at the operating voltage.

(3) If the SSR operation is continuous ON/OFF, this value should be reduced by 50%. See "Inrush Current Resistivity" graphs on page 112 for details

(4) See the following "Load Current Versus Ambient Temperature Characteristics" graphs on page 112 for additional load current details.

**Characteristics**

Description	Cat. No. 700-SCZ...	Cat. No. 700-SCT	Cat. Nos. 700-SCNY, 700-SCNN3...	Cat. Nos. 700-SCNN2...
Load Switching Method/Device	Triac		Transistor	
Pick-up time	1/2 of load power source cycle time <sup>(1)</sup> + 1 ms max. (DC input)			
	3/2 of load power source cycle time <sup>(1)</sup> + 1 ms max. (AC input)			
Drop-out time	1/2 of load power source cycle time <sup>(1)</sup> + 1 ms max. (DC input)	1/2 of load power source cycle time <sup>(1)</sup> + 1 ms max.	2 ms max.	2.5 ms max.
	3/2 of load power source cycle time <sup>(1)</sup> + 1 ms max. (AC input)			
Output On Voltage Drop	1.6V (RMS) max.	1.6V (RMS)	1.5V max.	1.5V max.
Output Leakage Current	5 mA max (@ 100V AC) 10 mA max (@ 200V AC)	2.5 mA max (@ 100V AC) 5 mA max (at 200V AC)	5 mA max (@ 50V DC)	0.1 mA max (@ 100V DC)
Output V <sub>DRM</sub> , V <sub>CEO</sub> (V)	600	600	80	80
Output di/dt (A/uS)	50	50	—	—
Output dv/dt (V/uS)	250	250	—	—
Output I <sup>2</sup> t (A <sup>2</sup> S)	18	18	—	—
Output Tj (°C) Max.	125	125	150	150
Insulation Resistance	100 MΩ min (@500V DC)			
Dielectric Strength	1500V AC, 50/60 Hz for 1 minute			
Vibration Resistance (max.)	10...55 Hz, 1.5 mm double amplitude (10 G)			
Shock Resistance (max.)	1000 m/s <sup>2</sup> (100 G)			
Ambient Temperature	Operating: -30...+80 °C (-22...+176 °F) with no icing or condensation Storage: -30...+100 °C (-22...+212 °F) with no icing or condensation			
Standards Compliance	UL 508, CSA C22.2 No. 14, EN/IEC 60950, EN 50011, EN 61000-6-2, EN/IEC 60947-1, -4-3			
Certifications	cURus Recognized (File No. E96956, Guide NMFT2/NMFT8), CE Marked, VDE Certified			
Ambient Humidity	Operating: 45...85% (no condensation)			
Weight	Approx. 50 g			

(1) 60 Hz full cycle time = 16.6 ms, 50 Hz full cycle time = 20 ms

**Load Current Versus Ambient Temperature Characteristics**

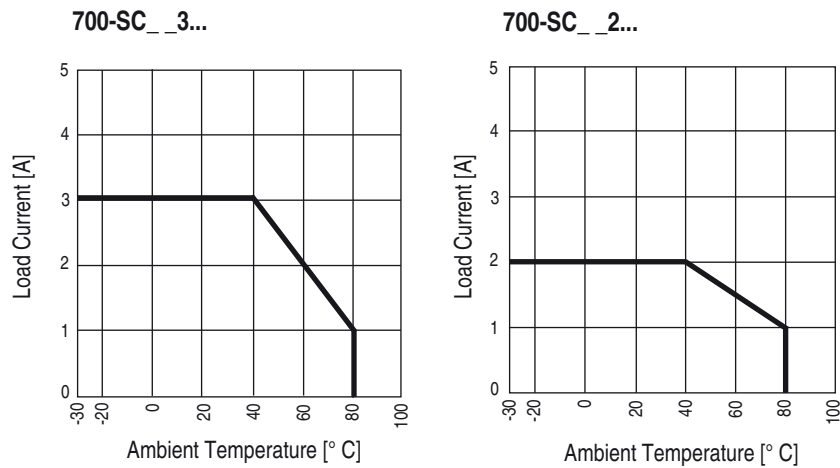

### Inrush Current Resistivity <sup>(1)</sup>

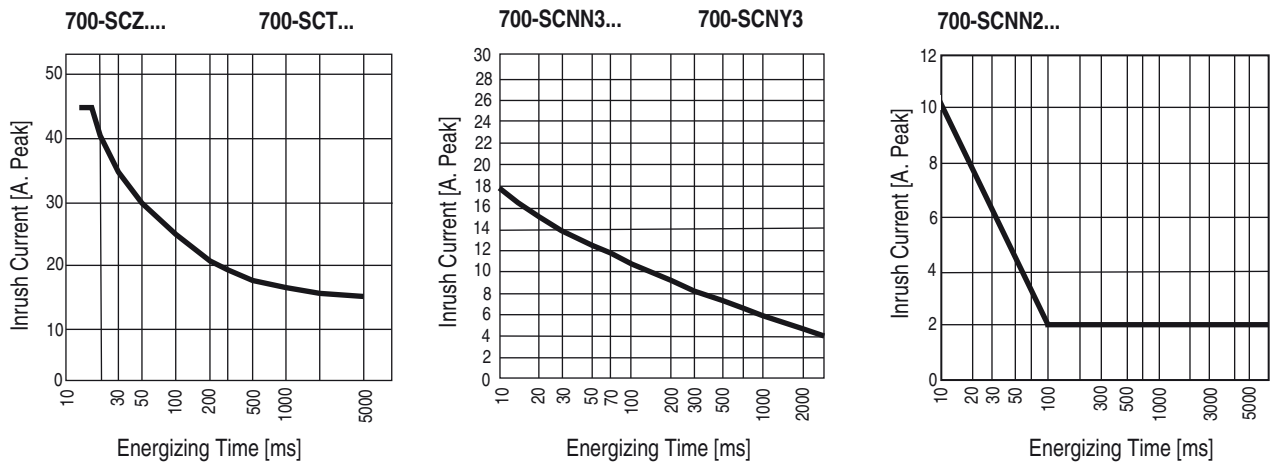

(1) Inrush current resistivity is the ability of an SSR to withstand a large surge current for a short period. Surges are considered non-repetitive (max. repeatability once every 2...5 seconds). Keep the inrush current to half the rated value if it occurs repetitively. Exceeding the non-repetitive inrush current will damage the SSR.

### EMC Directive Compliance

1. AC-switching models comply with EMC Directives under the following conditions

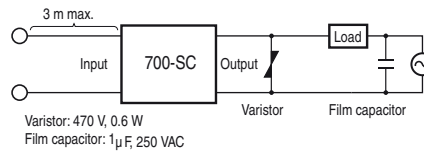

- Connect a varistor between the output terminals.
- Connect a film capacitor to the load power supply.
- The input cable must be less than 3 m.

2. DC-switching models comply with EMC Directives under the following conditions

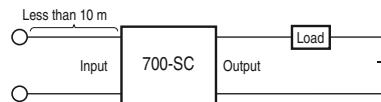

- The input cable must be less than 10 m.

### Dimensions - 700-SC Relays

All units in millimeters unless otherwise indicated. To convert millimeters to inches multiply by 0.0394. Dimensions are not intended to be used for manufacturing purposes.

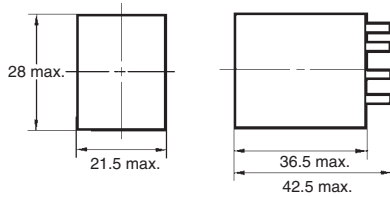
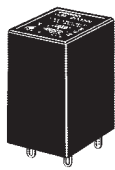

#### Terminal Arrangement/ Internal Connections (Bottom View)

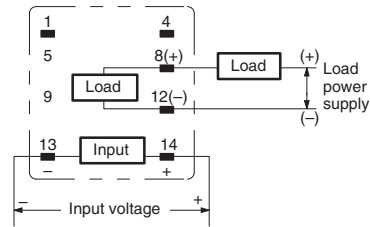

**Note:** The plus and minus symbols shown in parentheses are for DC loads.

Cat. No 700-SC...<sup>(1)</sup>

(1) 700-SC is compatible with Cat. Nos. 700-HN103, -HN104, and -HN128 socket.

### Basic Application Considerations for 700-SC

#### High-density Mounting of Multiple Solid-state Relays (SSRs)

If multiple relays are mounted side by side, the outer wall of each SSR works as a radiator. The SSR casing serves to dissipate heat. Install the relays so that they are adequately ventilated. If poor ventilation is unavoidable, reduce the load current by half.

#### Connection

For DC Load Switching, 700-SC will operate properly if the load is connected to either the positive or negative SSR load terminal.

#### Protective Component

When controlling AC inductive loads, connect an inrush/surge absorbing device (varistor) across the SSR load terminals. If the SSR has built-in surge suppression (s 700-SE and 700-SH) and additional surge suppression is required, connect the varistor across the terminals of the load device. Select a varistor that meets the conditions of the load voltage that is outlined in the table below.

Load Voltage [V AC]	Varistor Voltage [V]	Varistor Surge Resistance
100...120	240...270	1000 A min.
200...240	440...470	
380...480	820...1000	

**TIP** For additional details on solid-state relays, see the Solid-State Relay Application Guide, publication [700-AT001](#).

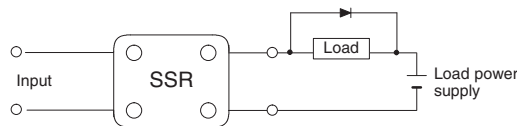







## 700-SF Square Base Relays

- 3 A (resistive) max. continuous load (output) current
- 264V AC or 52.8V DC max. load voltage options
- 4...24V DC control/input voltage
- Photocoupler or phototriac isolation option between control and output voltage
- LED Indicator for input/logic ON/OFF status monitoring
- 700-HN116 socket compatible



Input-to-Output Isolation Method	Zero Cross Function	Status Indicator	Output (Load) Max. Continuous Current and Rated Voltage Range	Rated Input Control Voltage	Cat. No.
Photocoupler	Yes	Yes	3 A @ 100...240V AC (47...63 Hz)	5...24V DC	700-SFZY3Z25
Phototriac	No			24V DC	700-SFTY3Z24
Photocoupler	Not Applicable		3 A @ 4...48V DC	4...24V DC	700-SFNY3Z25

## Accessories-700-SF Relays

Photo	Description	Pkg. Quantity	Cat. No.
	<b>Screw Terminal Socket — Panel or DIN Rail Mounting</b> 8-blade miniature socket for use with DPDT HF relays.	10	700-HN116
	<b>DIN (#3) symmetrical hat rail</b> 35 x 7.5 x 1 m	10	199-DR1
	<b>Pre-Printed Identification Tags</b> — contains 10 sheets of pre-printed and blank tags. Each sheet contains 13 sets of the markings CR...9CR, TR...9TR, M...9M, F, R, 1S, and 117 blank tags. Tags are peel-off with sticky backing for easy placement on relays.	10	700-N40
	<b>Blank Identification Tags</b> — contains 10 sheets of blank identification tags for customer specialized printing. Each sheet contains 546 blank tags. Tags are peel-off with sticky backing for easy placement on relays.	10	700-N41
	<b>Retainer Clip for Cat. Nos. 700-HN103, -HN104, and -HN128 Sockets with 700-HC Relays.</b> Secures relay in socket.	10	700-HN114 <sup>(1)</sup>

(1) 700-SF must use Cat. No. 700-HN114 series B retainer clip.

## Specifications- 700-FS Relays

### Control/Input Ratings

Cat. No.	Rated Control Voltage	Max. Operating Control Voltage Range [V DC]	Max. Reverse Control Voltage [V]	Impedance	Control Voltage Levels	
					Pick-up Voltage	Drop-out Voltage
700-SFZY3Z25	5...24V DC	4...28V DC	-32	15 mA max. <sup>(1)</sup>	4V DC max.	1V DC min.
700-SFTY3Z24	24V DC	19.2...28.8V DC	-28.8	2 k $\Omega$ $\pm$ 20%	19.2V DC max.	1V DC min.
700-SFNY3Z25	5...24V DC	4...28V DC	-28.8	1.5 k $\Omega$ + 20%/-10% <sup>(2)</sup>	4V DC max.	1V DC min.

## Load/Output Ratings

Cat. No.	Rated Control Voltage	Max. Load Voltage Range	Continuous Load Current (Resistive) [A]		Max. Inrush Current <sup>(4)</sup>
			Min.	Max. <sup>(3)</sup>	
700-SFZY3Z25	100...240V AC	75...264V AC	0.1	3	45 A @ 50/60 Hz, 1 cycle
700-SFTY3Z24			0.1	3	
700-SFNY3Z25	4...48V DC	3...52.8V DC	0.1	3	18 A (10 ms)

## Characteristics

Description	Cat. No. 700-SFZY3Z25	Cat. No. 700-SFTY3Z24	Cat. No. 700-SFNY3Z25
Load Switching Method/Device	Triac	Transistor	
Pick-up Time	1/2 cycle of load power source cycle time <sup>(5)</sup> + 1 ms max.	1 ms max.	0.5 ms max.
Drop-out Time	1/2 cycle of load power source cycle time <sup>(5)</sup> + 1 ms max.		2 ms max.
Output ON Voltage Drop	1.6V (RMS) max.		1.5V max.
Output Leakage Current	5 mA max. (@ 100V AC); 10 mA max. (@ 200V AC)	2.5 mA max. (@ 100V AC); 5 mA max. (@ 200V AC)	5 mA max. (@ 50V DC)
Output $V_{DRM}$ , $V_{CEO}$ (V)	600	600	80
Output di/dt (A/uS)	50	50	—
Output dv/dt (V/uS)	250	250	—
Output $I^2t$ (A <sup>2</sup> S)	18	18	—
Output Tj (°C) Max.	125	125	150
Insulation Resistance	100 M $\Omega$ min. (at 500VDC)		
Dielectric Strength	1,500V AC, 50/60 Hz for 1 min		
Vibration Resistance (Max.)	10...55 Hz, 1.5 mm double amplitude (10 G)		
Shock Resistance (Max.)	1000 m/s <sup>2</sup> (100 G)		
Ambient Temperature	Operating: -30...+80 °C (-22...+176 °F) with no icing or condensation Storage: -30...+100 °C (-22...+212 °F) with no icing or condensation		
Ambient Humidity	45...85% (no condensation)		
Standards Compliance	UL 508, CSA C22.2 No. 14, EN/IEC 60947-1, -4-3, EN/IEC 60950		
Certifications	cURus Recognized (File No. E96956, Guide NMFT2/NMFT8), CE Marked, VDE Certified		
Weight	Approx. 50 g		

- (1) With constant current input circuit system, SSR impedance varies with a change in input voltage.  
(2) Input impedance reaches its maximum at the operating voltage.  
(3) If the SSR operation is continuous ON/OFF, this value should be reduced by 50%. See the "Inrush Current Resistivity" graphs on page 116 for more details.  
(4) See "Load Current vs. Ambient Temperature Characteristics" on page 116 for additional load current details.  
(5) 60 Hz full cycle time = 16.6 ms, 50 Hz full cycle time 20 ms.

**IMPORTANT** This data is non-repetitive. Keep the inrush current to half the rated value if it occurs repetitively. Inrush current resistivity is the ability of an SSR to withstand a large surge current for a short period.

Surges are considered non-repetitive (max. repeatability once every 2...5 seconds). Keep the inrush current to half the rated value if it occurs repetitively. Exceeding the non-repetitive inrush current will damage the SSR.

**Load Current vs. Ambient Temperature Characteristics**

700-SF

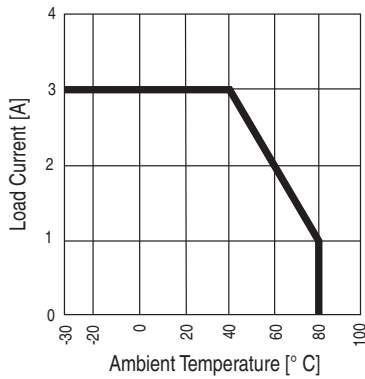

**Inrush Current Resistivity<sup>(1)</sup>**

700-SFZ... 700SFT...

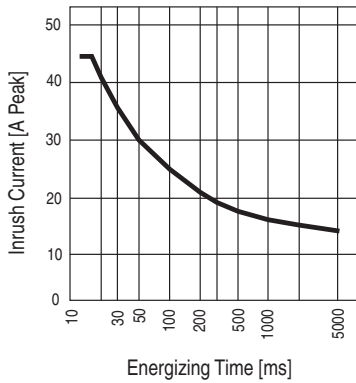

**Inrush Current Resistivity<sup>(1)</sup>**

700-SFN...

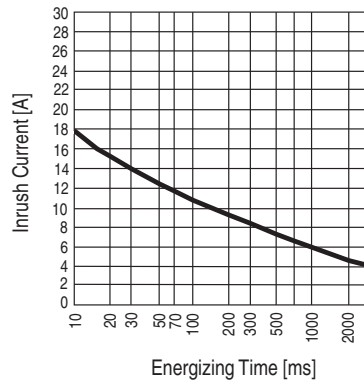

(1) Inrush current resistivity is defined as the ability of an SSR to withstand a large surge current for a short period. Surges are considered non-repetitive (max. repeatability once every 2...5 seconds). Keep the inrush current to half the rated value if it occurs repetitively. Exceeding the non-repetitive inrush current will damage the SSR.

**EMC Directive Compliance**

1. AC-switching models comply with EMC Directives under the following conditions

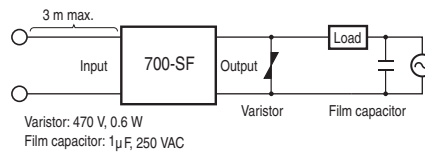

- Connect a varistor between the output terminals.
- Connect a film capacitor to the load power supply.
- The input cable must be less than 3 m.

2. DC-switching models comply with EMC Directives under the following conditions

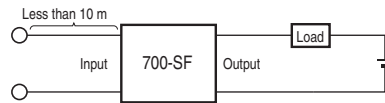

- The input cable must be less than 10 m.

### Dimensions - 700-SF Relays

All units in millimeters unless otherwise indicated. To convert millimeters to inches multiply by 0.0394. Dimensions are not intended to be used for manufacturing purposes.

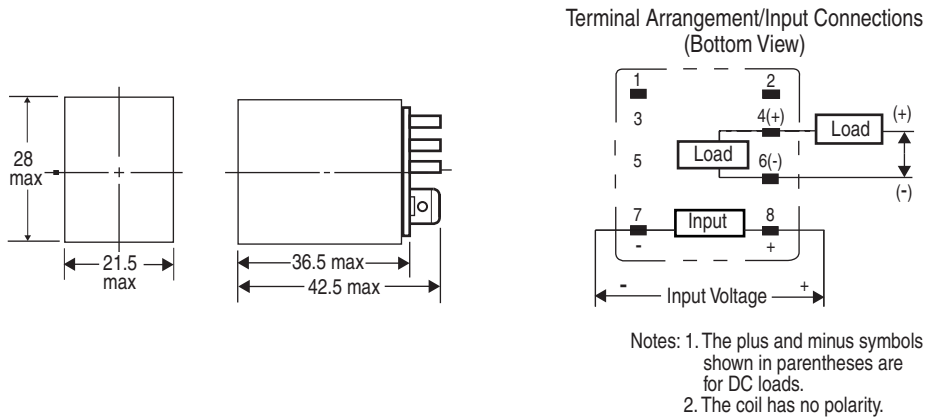

**IMPORTANT** 700-SF is compatible with Cat. No. 700-HN116 socket.

### Basic Application Considerations of 700-SF

#### High-density Mounting of Multiple Solid-state Relays (SSRs)

If multiple SSRs are mounted side by side, the outer case wall of the SSR acts as a radiator. The SSR case serves to dissipate heat. Install the relays so that they are adequately ventilated. If poor ventilation is unavoidable, reduce the load current by half.

#### Connection

For DC load switching, the Bul. 700-SF SSR will operate properly if the load is connected to either the positive or negative load terminals.

#### Protective Component to Extend SSR Life

When controlling AC inductive loads, connect an inrush/surge absorbing device (varistor) across the SSR load terminals. If the SSR has built-in surge suppression (700-SE and 700-SH) and additional surge suppression is required, connect the varistor across the terminals of the load device. Select a varistor that meets the conditions of the load voltage that is outlined in the table.

Load Voltage [V AC]	Varistor Voltage [V]	Varistor Surge Resistance
100...120	240...270	1000 A min.
200...240	440...470	
380...480	820...1000	

**TIP** For additional details on solid-state relays, see the Solid-State Relay Application Guide, publication [700-AT001](#).

For a DC inductive load, a diode should be connected parallel to the load to absorb the counter electromotive force (EMF) of the load.

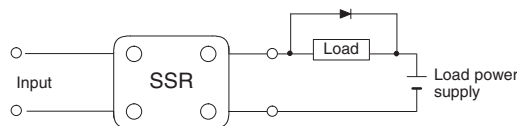

## 700-SH Hockey Puck Relays

- 100 A max. continuous load (output) current with appropriate heat sink
- 264V AC, 530V AC, or 660V AC max. load voltage options
- 3...32V DC, 4...32V DC, 80...130V AC, 200...260V AC, 20...280V AC/22...48V DC control (input) voltage options
- LED indicator for input/logic ON/OFF status monitoring
- Protective cover for added safety

Photo	Input-to-Output Isolation Method	Zero Cross Function	Status Indicator	Output (Load) Max. Continuous Current and Rated Voltage Range <sup>(1)</sup>	Rated Input Control Voltage	Cat. No. <sup>(2)</sup>
	Optocoupler	Yes	Yes	10 A @ 42...265V AC	3...32V DC	700-SH10JZ24
				10 A @ 42...265V AC	80...130V AC	700-SH10JA12
				10 A @ 42...265V AC	200...260V AC	700-SH10JA22
				10 A @ 42...530V AC	4...32V DC	700-SH10HZ25 (Series B)
				25 A @ 42...530V AC	4...32V DC	700-SH25HZ25 (Series B)
				25 A @ 24...265V AC	3...32V DC	700-SH25GZ24
				25 A @ 24...265V AC	20...280V AC/ 22...48V DC	700-SH25GA24
				50 A @ 24...265V AC	3...32V DC	700-SH50GZ24
				50 A @ 24...265V AC	20...280V AC/ 22...48V DC	700-SH50GA24
				50 A @ 42...530V AC	4...32V DC	700-SH50HZ25
				25 A @ 42...660V AC	4...32V DC	700-SH25VZ25
				25 A @ 42...660V AC	20...280V AC/ 22...48V DC	700-SH25VA24
				50 A @ 42...660V AC	4...32V DC	700-SH50VZ25
				50 A @ 42...660V AC	20...280V AC/ 22...48V DC	700-SH50VA24
				75 A @ 42...530V AC	4...32V DC	700-SH75HZ25
				75 A @ 42...660V AC	4...32V DC	700-SH75VZ25
				75 A @ 42...530V AC	20...280V AC/ 22...48V DC	700-SH75HA24
				75 A @ 42...660V AC	20...280V AC/ 22...48V DC	700-SH75VA24
				100 A @ 42...530V AC	4...32V DC	700-SH100HZ25
				100 A @ 42...530V AC	20...280V AC/ 22...48V DC	700-SH100HA24
		100 A @ 42...660V AC	4...32V DC	700-SH100VZ25		
		100 A @ 42...660V AC	20...280V AC/ 22...48V DC	700-SH100VA24		
Yes	No	5 A @ 3...60V DC	3...32V DC	700-SH5FZ24		
Yes	Yes	25 A @ 90...280V AC	4...20 mA DC	700-SH25WA25		
		50 A @ 90...280V AC	4...20 mA DC	700-SH50WA25		

(1) When used with heat sink.

(2) All catalog numbers are Series A unless noted.

**Accessories - 700-SH Relays**

Photo	Description	Pkg. Quantity	Cat. No.
	Heat Sink— Panel or DIN Rail Mount	1	700-SN10
	Heat Sink— Panel or DIN Rail Mount	1	700-SN25
	Heat Sink— Panel or DIN Rail Mount	1	700-SN50
	Heat Sink— Panel or DIN Rail Mount	1	700-SN50HC
	Heat Sink— Panel or DIN Rail Mount	1	700-SN50VHC
	DIN (#3) symmetrical hat rail 35 x 7.5 x 1 m	10	199-DR1
	<b>Thermal Conductive Pads</b>	50	700-SHCPAD
	<b>Plastic Covers</b> — for DC output version	25	700-SHCOV
	<b>Thermal Adapters</b> - for 100 A Wire	10	700-SHTRMA

## Specifications- 700-SH Relays

### Control/Input Ratings

Cat. No.	Operating Voltage	Input Current @ Max. Voltage	Voltage Level Pickup Voltage	Drop-out Voltage
700-SH10J...	3...32V DC	12 mA	2.75V DC max.	1.2V DC min.
	80...130V AC	13 mA	70V AC max.	30V AC min. <sup>(1)</sup>
	200...280V AC	13 mA	190V AC max.	90V AC min.
700-SH__H...	4...32V DC	12 mA	4V DC max.	1V DC min.
	20...280V AC/22...48V DC	20 mA	18V AC/DC	6V AC/DC
700-SH__G...	3...32V DC	12 mA	2.5V DC	1.2V DC
	20...280V AC/22...48V DC	20 mA	-32V DC	6V AC/DC
700-SH__V...	4...32V DC	12 mA	3.5V DC	1.2V DC
	20...280V AC/22...48V DC	20 mA	18V AC/DC	6V AC/DC
700-SH__W...	Current Control	4...20 mA	—	—
700-SH__F...	3...32V DC	12 mA	3V DC max.	1.0V DC

(1) When specified heatsink is used.

### Output Ratings

Cat. No.	Load Voltage Range	Applicable Load Current with Heat Sink [A] <sup>(2)</sup>
700-SH5FZ24	3...60V DC	0.001...5 A DC
700-SH10J...	42...265V AC	0.15...10
700-SH10H...	42...530V AC	0.15...10
700-SH25G...	24...265V AC	0.15...25
700-SH25H...	42...530V AC	0.15...25
700-SH25V...	42...660V AC	0.15...25
700-SH25W...	90...280V AC	0.15...25
700-SH50G...	24...265V AC	0.15...50
700-SH50H...	42...530V AC	0.15...50
700-SH50V...	42...660V AC	0.15...50
700-SH50W...	90...280V AC	0.15...50
700-SH75H...	42...530V AC	0.15...75
700-SH75V...	42...660V AC	0.15...75
700-SH100H...	42...530V AC	0.15...100
700-SH100V...	42...660V AC	0.15...100

(2) AC unless indicated.

**Characteristics**

Description	Cat. Nos. 700-SH10, 25, 50 (not including 700-SH__W)	Cat. Nos. 700-SH75, 100
Pick-up Time	1/2 of load power source cycle time(DC input) / 1 of load power source cycle time (AC input)	
Drop-out Time	1/2 of load power source cycle time (DC input) / 2 of load power source cycle time (AC input)	
Output ON Voltage Drop	1.6V (RMS) max.	
Output Leakage Current	<3 mA <sub>RMS</sub> 100M $\Omega$ min(@500VDC)	
Insulation Resistance	100M $\Omega$ min.(at500VDC)	
Dielectric Strength	>4000V AC <sub>RMS</sub>	
Vibration Resistance	Malfunction: 10...55 Hz, 1.5 mm double amplitude	
Shock Resistance	Malfunction: 1000 m/s <sup>2</sup>	
Ambient Temperature	Operating: -20...+70 °C with no icing or condensation Storage: -40...+100 °C with no icing or condensation	
Ambient Humidity	0...95% no condensing	
Standards Compliance	UL 508, CSA C22.2 No. 14, EN/IEC 60947-1, -4-2, -4-3, EN 61000-6-2, EN 61000-6-4	
Certifications	cURus Recognized (File No. E14843, Guide NPNT2), CSA Certified (File No. 240924)	
Weight	Approx. 60 g	Approx. 100 g

Description	Cat. No. 700-SH__W
Pick-up Current	4.2 mA
Drop-out Current	4.1 mA
Voltage Drop	<10V DC @ 20 mA
Leakage Current	<3 mA
Insulation Voltage	<4000 V <sub>RMS</sub>
Vibration Resistance	Malfunction: 10...55 Hz, 1.5 mm double amplitude
Shock Resistance	Malfunction: 1000 m/s <sup>2</sup>
Ambient Temperature	Operating: -20...+70 °C with no icing or condensation
Ambient Humidity	0...95% no condensing
Standards Compliance	UL 508, CSA C22.2 No. 14, EN/IEC 60947-1, -4-2, -4-3, EN 61000-6-2, EN 61000-6-4
Certifications	cURus Recognized (File No. E14843, Guide NPNT2), CSA Certified (File No. 24024)
Weight	Approx. 60 g

Description	Cat. No. 700-SH5FZ24
Pick-up Voltage	<3V DC
Drop-out Voltage	>1V DC
Activating Frequency	<100 Hz
Input Impedance	1k $\Omega$
Response Time Pick-up @ Vin > 5V	<4000 $\mu$ s
Response Time Drop-out	<1 ms
On-state Voltage Drop @ Rated Current	<1.5V



Description	Cat. No. 700-SH5FZ24
Off-state Current Drop @ Rated Voltage	<1 mA
Insulation Voltage	<1 mA
Vibration Resistance	Malfunction: 10...55 Hz, 1.5 mm double amplitude
Shock Resistance	Malfunction: 1,000 m/s <sup>2</sup>
Ambient Temperature	Operating: -20...+70 °C with no icing or condensation
Ambient Humidity	0...95% no condensing
Standards Compliance	UL 508, CSA C22.2 No. 14, EN/IEC 60947-1, -4-2, -4-3, EN 61000-6-2, EN61000-6-4
Certifications	cURus Recognized (File No. E14843, Guide NPNT2), CSA Certified (File No. 240924)
Weight	Approx. 60 g

### Surge Current vs. Ambient Temperature Characteristics

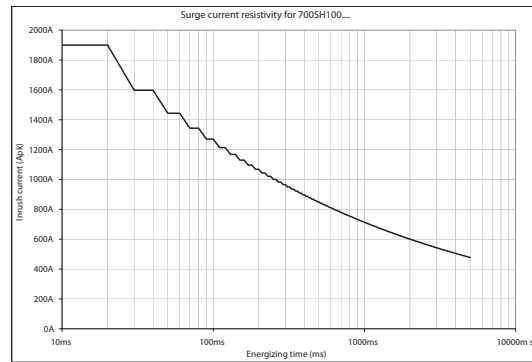
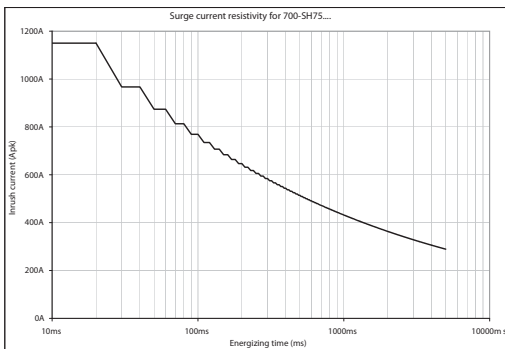
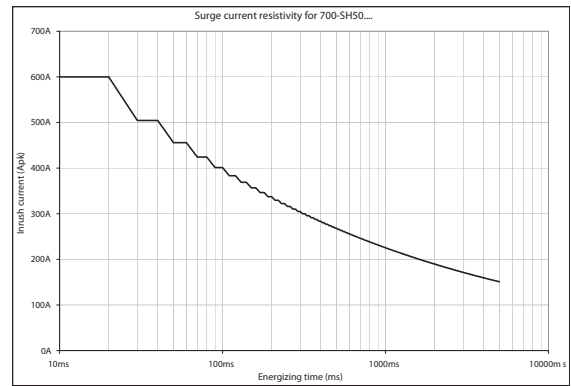
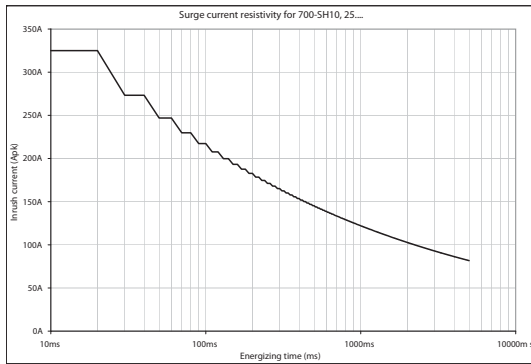

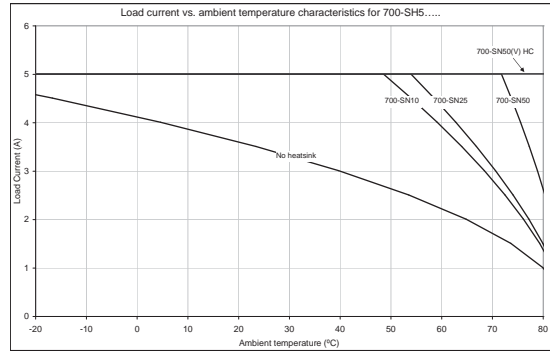
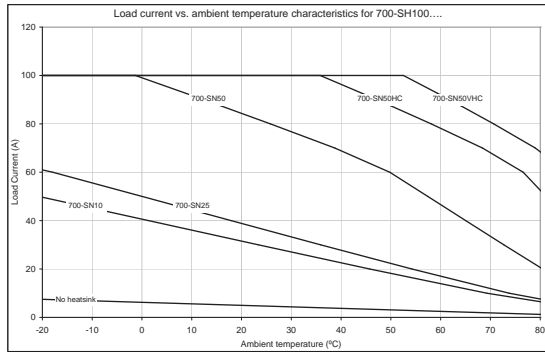
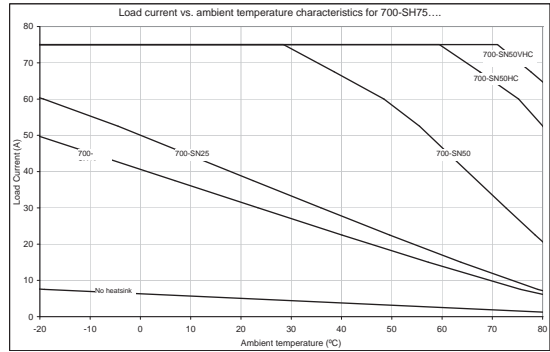
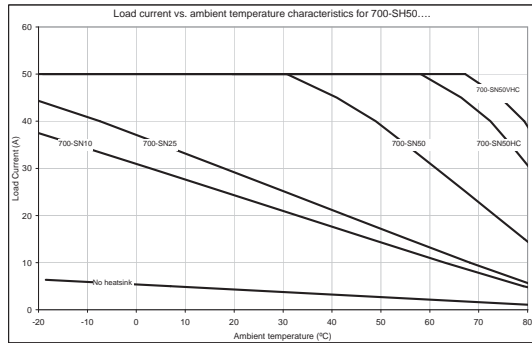
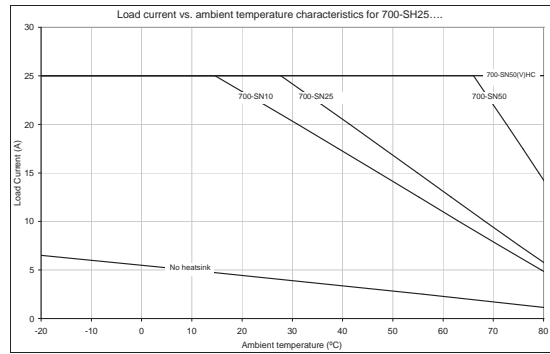
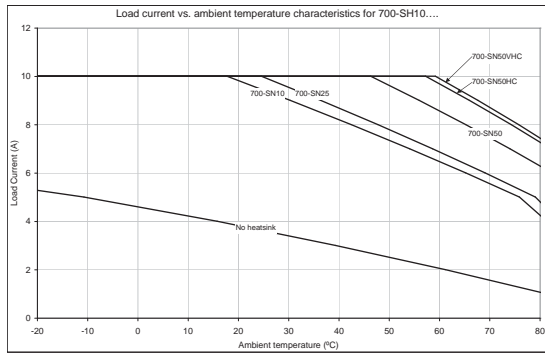

### Mounting Considerations (1) (2) (3) (4)

All units are in millimeters unless otherwise indicated. To convert to inches multiply by 0.0394. Dimensions are not intended for manufacturing purposes.

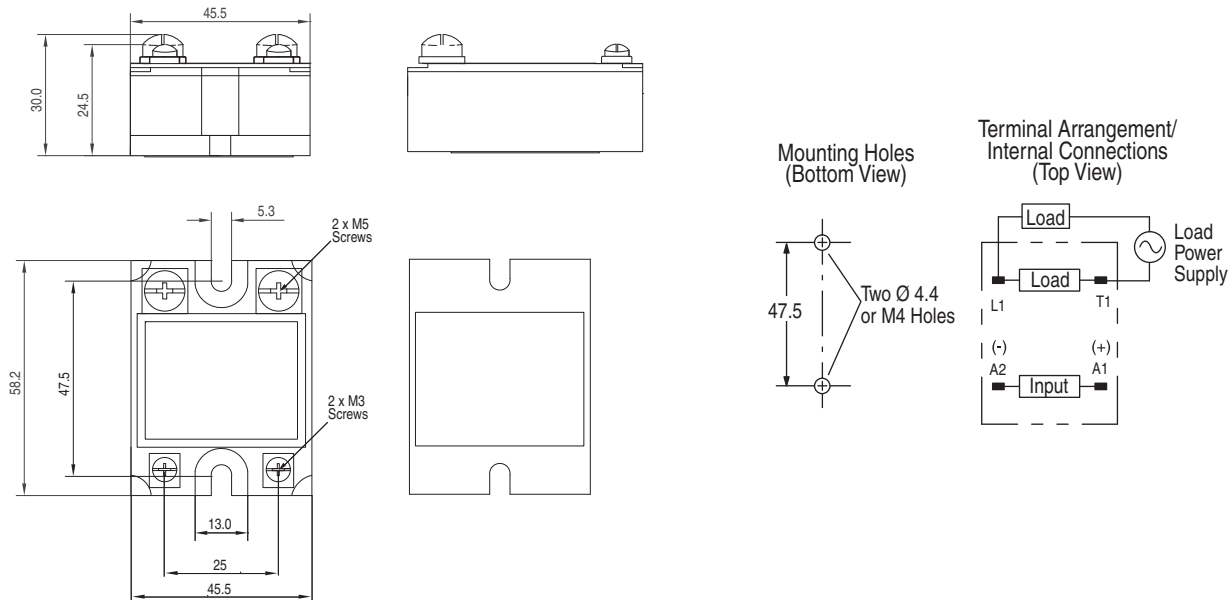

Cat. No. 700-SH5F...

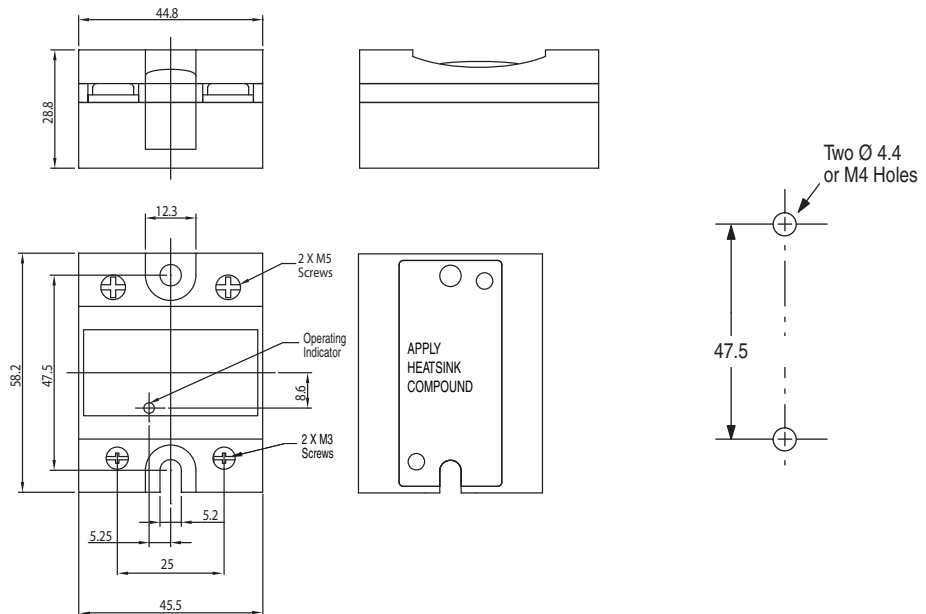

Cat. No. 700-SH10, -SH25, -SH50, -SH75, -SH100

- (1) The proper mounting orientation of the heat sink is so the heat fins run perpendicular to the floor (vertical) to maximize ventilation flow. If the fins do not run perpendicular to the floor, a 30% current derating is required.
- (2) When attaching a heat sink to 700-SH, apply a thin layer of heat conductive grease (approximately 0.002 in. thick) on the heat sink to maximize heat transfer between the SSR and the heat sink. Recommended types: Silicon based, Dow Corning 340, Toshiba YG6240; Non-silicon based, AOS company type 53300 (Cat. No. 46801-010-01).
- (3) Tighten the SSR panel/heat sink mounting screws to a torque of 0.78...0.98 N·m (6.9...8.7 lb·in).
- (4) Tighten the SSR terminal wiring screws as follows M4: 0.98...1.37 N·m (8.67...12.12 lb·in), M5: 1.57...2.35 N·m (13.89...20.8 lb·in).

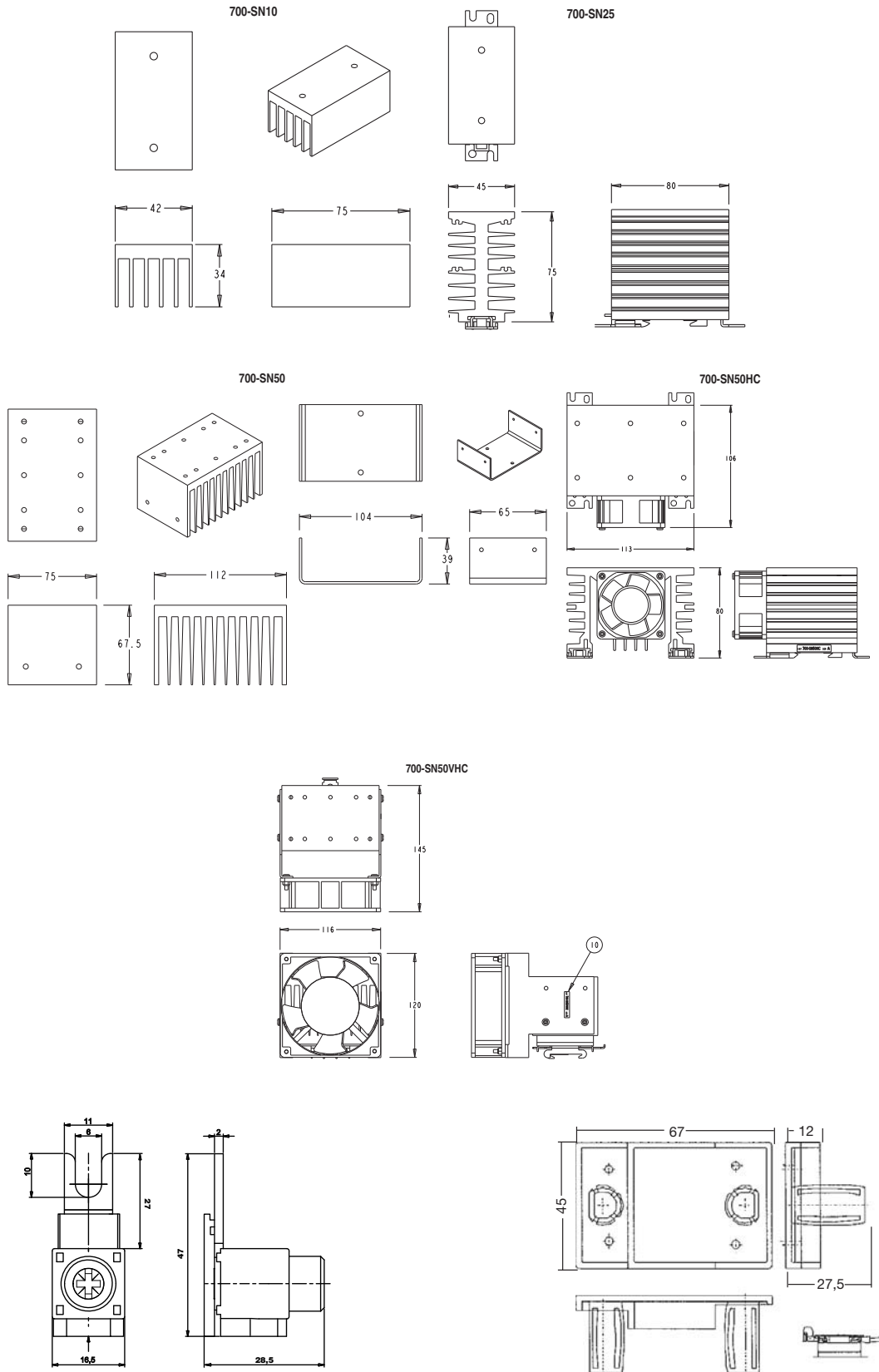

### Load Connection

- For an AC load, use a power supply that is rated at 50 Hz. or 60 Hz. The maximum operating frequency is 10 Hz.
- The 700-SH has a built-in varistor for surge/inrush protection of AC loads. If additional suppression is required, connect an external varistor across the load device terminals. Select a varistor, which meets the load voltage condition that is outlined in the table.

Load Voltage [V AC]	Varistor Voltage [V]	Varistor Surge Resistance
100...120	240...270	1000 A min.
200...240	440...470	
380...480	820...1000	

**TIP** For additional details on solid-state relays, see the Solid-State Relay Application Guide, publication [700-AT001](#).

### Zero Cross Function

An SSR with a zero cross function operates when an AC load voltage reaches the zero point or its vicinity. This reduces clicking noises when the load is switched and minimizes the influence of an inductive load, (such as, lamp, heater, or motor) on the power supply because the inrush current of the load is reduced. This can also minimize the scale of the inrush current protection circuit.

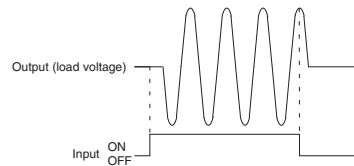

At a low applied voltage (for example, 24V AC) the load current is not fully supplied. When the unit is switched ON, the voltage required to power the unit deprives the output signal of the necessary voltage level and thus creates loss time. The lower the load voltage is, the greater the loss time is. This condition, however, will not create any serious problems.

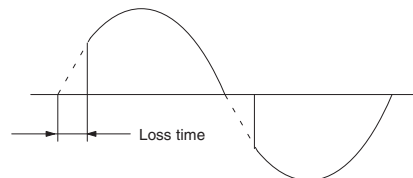

For a DC inductive load, a diode should be connected parallel to the load to absorb the counter electromotive force (OFF) of the load.

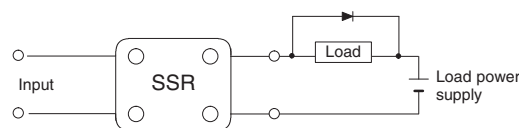

## 700-SK Slim Line Relays

- High-response speed models
- Input sensor module to allow high voltage 100...240V AC or 12...24V DC sensor
- Interface to low voltage (logic) device such as a PC output module for typical SSR applications
- LED indicator
- Input modules and output modules can be used with the 700-HN121 or 700-HN221 sockets



### Input/Sensor Module

Input-to-Output Isolation Method	Status Indicator	Response Frequency	Logic Level		Rated Input Sensor Voltage	Cat. No.
			Supply Voltage	Supply Current		
Photocoupler	Yes	10 Hz	4...32V DC	0.1...100 mA	100...240V AC <sup>(1)</sup>	700-SKICA18
		1 kHz			12...24V DC	700-SKICZ24



(1) 47...63 Hz

### Output/SSR Module

Input-to-Output Isolation Method	Zero Cross Function	Status Indicator	Output (Load) Max. Continuous Current and Rated Voltage Range	Rated Input Control Voltage	Cat. No.
Phototriac	Yes	Yes	2 A @ 100...240V AC <sup>(1)</sup>	5...24V DC	700-SK0Z2Z25
	No				700-SK0N2Z25
Photocoupler	Not Applicable		2 A @ 5...48V DC		700-SK0C2Z25
			1.5 A @ 48...200V DC		700-SK0C1Z25

(1) 47...63 Hz

### Accessories - 700-SK Relays

Photo	Description	Pcs./Pkg.	Cat. No.
	<b>Screw Terminal Socket — Panel or DIN Rail Mounting</b> 5-blade miniature socket with 10 A rating for use with 1-pole, 700-HK relays. Accepts forked lug conductors. Socket includes a retainer clip.	10	700-HN121
	<b>DIN (#3) symmetrical hat rail</b> 35 x 7.5 x 1 m	10	199-DR1
	<b>Pre-Printed Identification Tags</b> — contains 10 sheets of pre-printed and blank tags. Each sheet contains 13 sets of the markings CR...9CR, TR...9TR, M...9M, F, R, 1S, and 117 blank tags. Tags are peel-off with sticky backing for easy placement on relays.	10	700-N40
	<b>Blank Identification Tags</b> — contains 10 sheets of blank identification tags for customer specialized printing. Each sheet contains 546 blank tags. Tags are peel-off with sticky backing for easy placement on relays.	10	700-N41

## Specifications - 700-SK Relays

### Input Sensor Module

#### Input Sensor Ratings

Cat. No.	Rated Input Voltage	Max. Operating Input Voltage Range	Input Current	Pick-up Voltage	Drop-out Voltage
700-SKICZ24	12...24V DC	6.6...32V DC	8 mA max.	6.6V DC max.	3.6V DC min.
700-SKICA18	100...240V AC	60...264V AC	15 mA max.	60V AC max.	20V AC min.

#### Output Logic Ratings

Cat. No.	Logic Level Supply Voltage	Logic Level Supply Current Draw
700-SKICZ24	4...32V DC	0.1...100 mA
700-SKICA18		

#### Characteristics

Description	Cat. No. 700-SKICA18	Cat. No. 700-SKICZ24
Pick-up time	20 ms max.	0.1 ms max.
Drop-out time	20 ms max.	0.1 ms max.
Response frequency	10 Hz	100 Hz
Output ON voltage drop	1.6V max.	
Leakage current (from SSR)	5 $\mu$ A max.	
Output $V_{DRM}$ , $V_{CEO}$ (V)	80 (ref. value)	80 (ref. value)
Output di/dt (A/uS)	—	—
Output dv/dt (V/uS)	—	—
Output $I^2t$ (A <sup>2</sup> S)	—	—
Output Tj (°C) Max.	150	150
Insulation Resistance	100 M $\Omega$ min. between input and output	
Dielectric Strength	4000V AC, 50/60 Hz for 1 min between input and output	
Vibration Resistance (Max.)	10...55 Hz, 1.5 mm double amplitude (10 G)	
Shock Resistance (Max.)	1000 m/s <sup>2</sup> (100 G)	
Ambient Temperature	Operating	-30...+80 °C (-22...+176 °F) with no icing or condensation
	Storage	-30...+100 °C (-22...+212 °F) with no icing or condensation
Standards Compliance	UL 508, CSA C22.2 No. 14, EN/IEC 60950	
Certifications	cURus Recognized (File No. E96956, Guide NMFT2/NMFT8), CE Marked, TÜV Certified	
Ambient humidity Operating	45...85% (no condensation)	
Weight	Approx. 18 g	

### Output SSR Module

#### Control/Input Ratings

Cat. No.	Rated Control Voltage	Max. Operating Control Voltage Range	Max. Reverse Control Voltage	Impedance <sup>(1)</sup>	Pick-up Voltage	Drop-out Voltage
700-SKOZ2Z25	5...24V DC	4...32V DC	-32V DC	15 mA max. at 25 °C (77 °F)	4V DC max.	1V DC min.
700-SKON2Z25						
700-SKOC2Z25				8 mA max.		
700-SKOC1Z25						

**Load/Output Ratings**

Cat. No.	Rated Load Voltage	Maximum Load Voltage Range	Continuous Load Current (Resistive) [A]		Max. Inrush Current <sup>(3)</sup>
			Min.	Max. <sup>(2)</sup>	
700-SKOZ2Z25	100...240V AC	75...264V AC	0.05	2	30 A (@50/60 Hz, One cycle)
700-SKON2Z25					
700-SKOC2Z25	5...48V DC	4...60V DC	0.1	2	8 A (10 ms)
700-SKOC1Z25	48...200V DC	40...200V DC	0.1	1.5	8 A (10 ms)

- (1) With a constant current input system. SSR impedance varies with a change in input voltage.
- (2) See "Load Current vs. Ambient Temperature Characteristics" graphs on page 126 for additional details.
- (3) If the SSR operation is continuous ON/OFF, this value should be reduced by 50%. See the "Inrush Current Resistivity" graphs on page 126 for more details.

**Characteristics**

Description	Cat. No. 700-SKOZ2Z25	Cat. No. 700-SKON2Z25	Cat. No. 700-SKOC2Z25	Cat. No. 700-SKOC1Z25
Load Switching Method/Device	Triac		Transistor	
Pick-up Time	1/2 cycle of load power source cycle time <sup>(1)</sup> + 1 ms max.		1 ms max.	
Drop-out Time	1/2 of load power source cycle time <sup>(1)</sup> + 1 ms max.		2 ms max.	
Response Frequency	20 Hz		100 Hz	
Output ON Voltage Drop	1.6V max.			2.5V max.
Leakage Current (from SSR)	1.5 mA max.		1 mA max.	
Output $V_{DRM}, V_{CEO}$ (V)	600 (ref.value)	600 (ref.value)	80 (ref.value)	400 (ref.value)
Output di/dt (A/uS)	30	30	—	—
Output dv/dt (V/uS)	300	300	—	—
Output $I^2t$ (A <sup>2</sup> S)	10.4	10.4	—	—
Output Tj (°C) Max.	125	125	150	150
Insulation Resistance	100 MΩ min. between input and output			
Dielectric Strength	4000V AC, 50/60 Hz for 1 min between input and output			
Vibration Resistance (Max.)	10...55 Hz, 1.5 mm double amplitude (10 G)			
Shock Resistance (Max.)	1000 m/s <sup>2</sup> (100 G)			
Ambient Temperature	Operating	-30...+80 °C (-22...+176 °F) with no icing or condensation		
	Storage	-30...+100 °C (-22...+212 °F) with no icing or condensation		
Standards Compliance	UL 508, CSA C22.2 No. 14, EN/IEC 60950			
Certifications	cURus Recognized (File No. E96956, Guide NMFT2/NMFT8), CE Marked, TÜV Certified			
Ambient Humidity Operating	45...85% (no condensation)			
Weight	Approx. 18 g			

(1) 60 Hz cycle time = 16.6 ms, 50 Hz cycle time = 20 ms.

**Load Current vs. Ambient Temperature Characteristics**

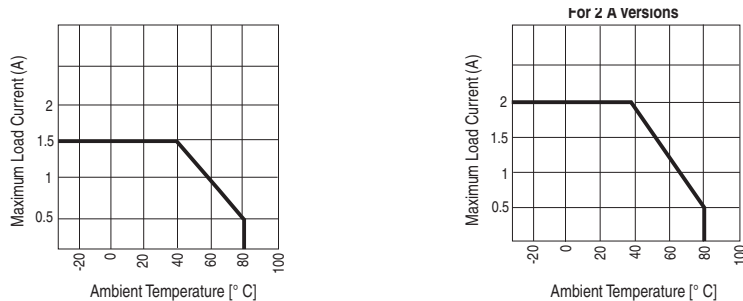



### Inrush Current Resistivity <sup>(2)</sup>

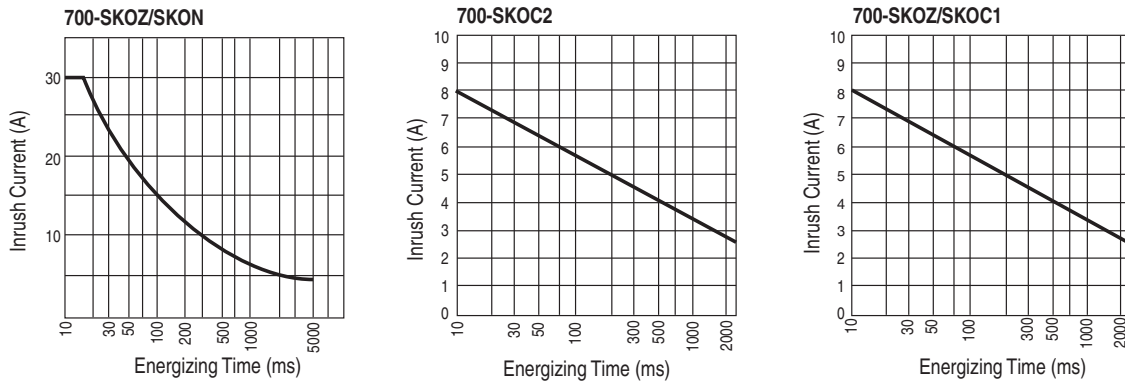

(2) Inrush current resistivity is the ability of an SSR to withstand a large surge current for a short period. Surges are considered non-repetitive (max. repeatability once every 2...5 seconds). Keep the inrush current to half the rated value if it occurs repetitively. Exceeding the non-repetitive inrush current will damage the SSR.

### Dimensions - 700-SK Relays

All units are in millimeters unless otherwise indicated. To convert to inches multiply by 0.0394. Dimensions are not to be used for manufacturing purposes.

**IMPORTANT** The input module (700-SKI) and output module (700-SKO) are compatible with the Cat. No. 700-HN121 socket.

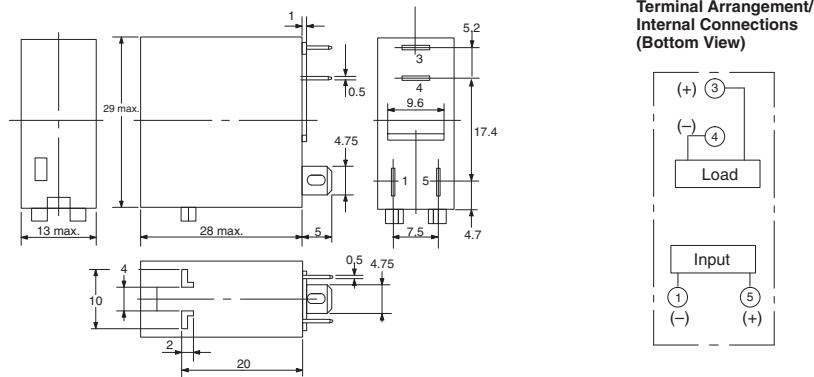

### Application Considerations of the 700-SK Relay

#### Connection

For DC load switching, 700-SK SSR will operate properly if the load is connected to either the positive or negative SSR load terminal. The load can be connected to either positive or negative output terminals of the SSR.

#### Protective Element (to extend SSR life)

Since the SSR does not incorporate a surge absorption component, be sure to connect a surge absorption component when using the SSR to control an inductive load.

**TIP** For additional details on solid-state relays, see the Solid-State Relay Application Guide, publication [700-AT001](#).

## Additional Resources

These documents contain additional information concerning related products from Rockwell Automation.

Resource	Description
General Purpose, Interposing, Solid-State and Specialty Relays Brochure publication <a href="#">700-BR018</a>	Provides product overview and applications for Bul 700 relay line.
Solid-state Relay Application Guide, publication <a href="#">700-AT001</a>	Provides methods for applying and troubleshooting Solid-state relays.
Industrial Automation Wiring and Grounding Guidelines, publication <a href="#">1770-4.1</a>	Provides general guidelines for installing a Rockwell Automation industrial system.
Product Certifications website, <a href="http://rok.auto/certifications">rok.auto/certifications</a> .	Provides declarations of conformity, certificates, and other certification details.

You can view or download publications at <http://www.rockwellautomation.com/global/literature-library/overview.page>.

## Additional Resources

These documents contain additional information concerning related products from Rockwell Automation.

Resource	Description
General Purpose, Interposing, Solid-State and Specialty Relays Brochure publication <a href="#">700-BR018</a>	Provides product overview and applications for Bul 700 relay line.
Solid-state Relay Application Guide, publication <a href="#">700-AT001</a>	Provides methods for applying and troubleshooting Solid-state relays.
EtherNet/IP Network Devices User Manual, <a href="#">ENET-UM006</a>	Describes how to configure and use EtherNet/IP devices to communicate on the EtherNet/IP network.
Ethernet Reference Manual, <a href="#">ENET-RM002</a>	Describes basic Ethernet concepts, infrastructure components, and infrastructure features.
System Security Design Guidelines Reference Manual, <a href="#">SECURE-RM001</a>	Provides guidance on how to conduct security assessments, implement Rockwell Automation products in a secure system, harden the control system, manage user access, and dispose of equipment.
Industrial Components Preventive Maintenance, Enclosures, and Contact Ratings Specifications, publication <a href="#">IC-TD002</a>	Provides a quick reference tool for Allen-Bradley industrial automation controls and assemblies.
Safety Guidelines for the Application, Installation, and Maintenance of Solid-state Control, publication <a href="#">SGI-1.1</a>	Designed to harmonize with NEMA Standards Publication No. ICS 1.1-1987 and provides general guidelines for the application, installation, and maintenance of solid-state control in the form of individual devices or packaged assemblies incorporating solid-state components.
Industrial Automation Wiring and Grounding Guidelines, publication <a href="#">1770-4.1</a>	Provides general guidelines for installing a Rockwell Automation industrial system.
Product Certifications website, <a href="http://rok.auto/certifications">rok.auto/certifications</a> .	Provides declarations of conformity, certificates, and other certification details.

You can view or download publications at [rok.auto/literature](http://rok.auto/literature).

# Rockwell Automation Support

Use these resources to access support information.

<b>Technical Support Center</b>	Find help with how-to videos, FAQs, chat, user forums, and product notification updates.	<a href="http://rok.auto/support">rok.auto/support</a>
<b>Knowledgebase</b>	Access Knowledgebase articles.	<a href="http://rok.auto/knowledgebase">rok.auto/knowledgebase</a>
<b>Local Technical Support Phone Numbers</b>	Locate the telephone number for your country.	<a href="http://rok.auto/phonesupport">rok.auto/phonesupport</a>
<b>Literature Library</b>	Find installation instructions, manuals, brochures, and technical data publications.	<a href="http://rok.auto/literature">rok.auto/literature</a>
<b>Product Compatibility and Download Center (PCDC)</b>	Download firmware, associated files (such as AOP, EDS, and DTM), and access product release notes.	<a href="http://rok.auto/pcdc">rok.auto/pcdc</a>

## Documentation Feedback

Your comments help us serve your documentation needs better. If you have any suggestions on how to improve our content, complete the form at [rok.auto/docfeedback](http://rok.auto/docfeedback).





Allen-Bradley, expanding human possibility, and Rockwell Automation are trademarks of Rockwell Automation.

Inc. EtherNet/IP is a trademark of ODVA, Inc.

Trademarks not belonging to Rockwell Automation are property of their respective companies.

Rockwell Automation maintains current product environmental compliance information on its website at [rok.auto/pec](http://rok.auto/pec).

Rockwell Otomasyon Ticaret A.Ş. Kar Plaza İş Merkezi E Blok Kat:6 34752, İçerenköy, İstanbul, Tel: +90 (216) 5698400 EEE Yönetmeliğine Uygundur

Connect with us.    

**rockwellautomation.com** ————— expanding **human possibility**<sup>™</sup>

AMERICAS: Rockwell Automation, 1201 South Second Street, Milwaukee, WI 53204-2496 USA, Tel: (1) 414.382.2000, Fax: (1) 414.382.4444

EUROPE/MIDDLE EAST/AFRICA: Rockwell Automation NV, Pegasus Park, De Kleetlaan 12a, 1831 Diegem, Belgium, Tel: (32) 2 663 0600, Fax: (32) 2 663 0640

ASIA PACIFIC: Rockwell Automation, Level 14, Core F, Cyberport 3, 100 Cyberport Road, Hong Kong, Tel: (852) 2887 4788, Fax: (852) 2508 1846