

CompactLogix 5370 Controllers

Catalog Numbers 1769-L16ER-BB1B, 1769-L18ER-BB1B, 1769-L18ERM-BB1B, 1769-L19ER-BB1B, 1769-L24ER-QB1B, 1769-L24ER-QBFC1B, 1769-L24ER-QBFC1BK, 1769-L27ERM-QBFC1B, 1769-L30ER, 1769-L30ER-NSE, 1769-L30ERM, 1769-L30ERMK, 1769-L33ERMO, 1769-L33ER, 1769-L33ERM, 1769-L33ERMK, 1769-L36ERM, 1769-L36ERMO, 1769-L37ERM, 1769-L37ERMK, 1769-L37ERMO, 1769-L38ERM, 1769-L38ERMK, 1769-L38ERMO



Important User Information

Read this document and the documents listed in the additional resources section about installation, configuration, and operation of this equipment before you install, configure, operate, or maintain this product. Users are required to familiarize themselves with installation and wiring instructions in addition to requirements of all applicable codes, laws, and standards.

Activities including installation, adjustments, putting into service, use, assembly, disassembly, and maintenance are required to be carried out by suitably trained personnel in accordance with applicable code of practice.

If this equipment is used in a manner not specified by the manufacturer, the protection provided by the equipment may be impaired.

In no event will Rockwell Automation, Inc. be responsible or liable for indirect or consequential damages resulting from the use or application of this equipment.

The examples and diagrams in this manual are included solely for illustrative purposes. Because of the many variables and requirements associated with any particular installation, Rockwell Automation, Inc. cannot assume responsibility or liability for actual use based on the examples and diagrams.

No patent liability is assumed by Rockwell Automation, Inc. with respect to use of information, circuits, equipment, or software described in this manual.

Reproduction of the contents of this manual, in whole or in part, without written permission of Rockwell Automation, Inc., is prohibited

Throughout this manual, when necessary, we use notes to make you aware of safety considerations.



WARNING: Identifies information about practices or circumstances that can cause an explosion in a hazardous environment, which may lead to personal injury or death, property damage, or economic loss.



ATTENTION: Identifies information about practices or circumstances that can lead to personal injury or death, property damage, or economic loss. Attentions help you identify a hazard, avoid a hazard, and recognize the consequence.

IMPORTANT

Identifies information that is critical for successful application and understanding of the product.

Labels may also be on or inside the equipment to provide specific precautions.



SHOCK HAZARD: Labels may be on or inside the equipment, for example, a drive or motor, to alert people that dangerous voltage may be present.



BURN HAZARD: Labels may be on or inside the equipment, for example, a drive or motor, to alert people that surfaces may reach dangerous temperatures.



ARC FLASH HAZARD: Labels may be on or inside the equipment, for example, a motor control center, to alert people to potential Arc Flash. Arc Flash will cause severe injury or death. Wear proper Personal Protective Equipment (PPE). Follow ALL Regulatory requirements for safe work practices and for Personal Protective Equipment (PPE).

	Preface	9
	Summary of Changes	9
	Abbreviations	9
	Product Compatibility and Download Center	10
	Additional Resources	11
	 Chapter 1	
CompactLogix 5370 Controllers Overview	CompactLogix 5370 Control System Components	14
	Controller Functionality	15
	Support for Integrated Motion over an EtherNet/IP Network	16
	Electronic Keying	17
	More Information	18
	Example System Configurations	18
	EtherNet/IP Network	18
	DeviceNet Network	20
	 Chapter 2	
Install the CompactLogix 5370 L1 Controller	Before You Begin	26
	CompactLogix 5370 L1 Controller Parts	29
	Installation Summary	29
	Install the Secure Digital Card	30
	Install the System	32
	Mount the System	32
	Ground the System	35
	Install the Controller	35
	Install the Removable Terminal Block	36
	Connect Power to the Controller (Series B)	37
	Connect to the Controller Via a USB Cable	42
	Connect the Controller to an EtherNet/IP Network	43
	Connecting to Different EtherNet/IP Network Topologies ...	43

	Chapter 3	
Install the CompactLogix 5370 L2 Controller	Before You Begin.....	48
	CompactLogix 5370 L2 Controller Parts	49
	Installation Summary.....	50
	Install the Secure Digital Card.....	50
	Install the System	52
	Mount the System	52
	Ground the System	58
	Install the Controller	58
	Remove and Replace the Removable Terminal Block	60
	Wire the Terminal Block.....	61
	Wire Size and Terminal Screw Torque	61
	Connect Power to the Control System	62
	Connect to the Controller Via a USB Cable.....	65
	Connect the Controller to an EtherNet/IP Network.....	66
	Connecting to Different EtherNet/IP Network Topologies... ..	66
	Chapter 4	
Install the CompactLogix 5370 L3 Controller	Before You Begin.....	70
	CompactLogix 5370 L3 Controller Parts	71
	Installation Summary.....	72
	Install the Secure Digital Card.....	72
	Install the System	74
	Assemble the System.....	74
	Remove and Replace the Removable Terminal Block	77
	Wire the Terminal Block.....	77
	Wire Size and Terminal Screw Torque	78
	Mount the System	78
	Ground the System	81
	Connect Power to the Control System	83
	Connect to the Controller Via a USB Cable.....	84
	Connect the Controller to an EtherNet/IP Network.....	85
	Connecting to Different EtherNet/IP Network Topologies... ..	86
	Chapter 5	
Complete Software Tasks Required at CompactLogix 5370 Controller Installation	Set the IP Address of a Controller	89
	Use the BOOTP Server to Set the IP Address of the Controller	91
	Use the DHCP Server to Set the IP Address of the Controller.	98
	Use RSLinx Software to Set the IP Address of the Controller..	99
	Use the Logix Designer Application to Set the IP Address of the Controller.....	101
	Use the SD Card to Set the IP Address of the Controller.....	104
	Change the IP Address of a Controller	105
	Change the Network IP Address with RSLinx Classic Software	106
Change the Network IP Address with Logix Designer Application	107	

Change the Network IP Address with an SD Card	108
Load the Controller Firmware.....	109
Use the ControlFLASH Software to Load Firmware	110
Use AutoFlash to Load Firmware	114
Use the Secure Digital Card to Load Firmware	117
Select the Operating Mode of the Controller	118

Chapter 6

Communicate over Networks

EtherNet/IP Network Communication.....	121
Available Software	122
EtherNet/IP Network Functionality on CompactLogix 5370 Controllers	122
Nodes on an EtherNet/IP Network	123
EtherNet/IP Network Topologies	125
Socket Interface with CompactLogix 5370 Controllers	131
Quality of Service (QoS) and I/O Module Connections	132
EtherNet/IP Network Connections.....	132
DeviceNet Network Communication.....	134
Available Software	134
Compact I/O 1769-SDN DeviceNet Scanner.....	136
Power Supply Distance Rating.....	136
Current Capacity in CompactLogix 5370 L3 Control Systems	140

Chapter 7

Use I/O Modules with CompactLogix 5370 L1 Controllers

Select I/O Modules.....	143
Connect Field Power to I/O Devices Connected to a CompactLogix 5730 L1 Control System	144
Embedded I/O Modules	149
Local Expansion Modules	157
Distributed I/O Modules over an EtherNet/IP Network	161
Validate I/O Layout.....	162
Set the Number of Local Expansion Modules	162
Empty Slots and Removal and Insertion Under Power Situations . 163	
Estimate Requested Packet Interval	164
Module Faults Related to RPI Estimates.....	166
Calculate System Power Consumption	166
Physical Placement of I/O Modules	167
Use the Event Task.....	168
Configure I/O	172
Common Configuration Parameters	173
I/O Connections.....	174
Configure Distributed I/O Modules on an EtherNet/IP Network	174
Monitor I/O Modules	177
Bus Off Detection and Recovery.....	179

**Use I/O Modules with
CompactLogix 5370
L2 Controllers**

Chapter 8

Select I/O Modules.....	181
Embedded I/O Modules	182
Determine Embedded Module Update Time	196
Channel Update Times	197
Embedded Analog I/O Modules Data Arrays	202
Input Array	202
Output Array	204
Configuration Array	205
Local Expansion Modules - Optional.....	213
Distributed I/O Modules over an EtherNet/IP Network ...	215
Distributed I/O Modules over a DeviceNet Network.....	216
Validate I/O Layout.....	217
Estimate Requested Packet Interval	217
Module Fault Related to RPI Estimates.....	219
System Power Availability	219
Power Supply Distance Rating.....	220
Configure Local I/O Modules.....	223
Configure Embedded I/O Modules	223
Configure Local Expansion Modules	224
Common Configuration Parameters	225
I/O Connections.....	226
Configure Distributed I/O Modules on an EtherNet/IP Network	226
Configure Distributed I/O Modules on a DeviceNet Network...	230
Monitor I/O Modules	232
End Cap Detection and Module Faults.....	233

**Use I/O Modules with
CompactLogix 5370
L3 Controllers**

Chapter 9

Select I/O Modules.....	235
Local Expansion Modules	236
Distributed I/O Modules over an EtherNet/IP Network ...	238
Distributed I/O Modules over a DeviceNet Network.....	239
Validate I/O Layout.....	240
Estimate Requested Packet Interval	240
Module Fault Related to RPI Estimates.....	242
Calculate System Power Consumption	243
Physical Placement of I/O Modules	246
Power Supply Distance Rating.....	249
Configure I/O	251
Common Configuration Parameters	252
I/O Connections.....	252
Configure Distributed I/O Modules on an EtherNet/IP Network	253
Configure Distributed I/O Modules on a DeviceNet Network...	256
Monitor I/O Modules	258
End Cap Detection and Module Faults.....	259

Develop Applications	Chapter 10	
	Elements of a Control Application.....	261
	Tasks.....	262
	Task Priority.....	265
	Programs.....	266
	Scheduled and Unscheduled Programs.....	267
	Routines.....	268
	Tags.....	269
	Extended Properties.....	270
	Access Extended Properties in Logic.....	271
	Programming Languages.....	272
	Add-On Instructions.....	273
	Access the Module Object.....	274
	Create the Add-On Instruction.....	274
	Monitoring Controller Status.....	276
	Monitoring I/O Connections.....	277
	Determine if I/O Communication has Timed Out.....	278
	Determine if I/O Communication to a Specific I/O Module has Timed Out.....	278
	Interrupt the Execution of Logic and Execute the Fault Handler..	279
	System Overhead Time Slice.....	280
	Configure the System Overhead Time Slice.....	281
Sample Controller Projects.....	282	
Develop Integrated Motion over an EtherNet/IP Network Application	Chapter 11	
	Motion Axes Support.....	284
	AXIS_VIRTUAL Axis.....	284
	AXIS_CIP_DRIVE Axis.....	285
	Maximum Number of Position Loop-configured Drives.....	286
	Position Loop-configured Drive Limits.....	286
	Time Synchronization.....	287
	Configure Integrated Motion on the EtherNet/IP Network.....	288
	Enable Time Synchronization.....	288
	Add a Drive.....	289
	Scalability in Applications Using Integrated Motion on EtherNet/IP Networks.....	292
	1769-L30ERM, 1769-L30ERMK, 1769-L33ERM, 1769- L33ERMK, 1769-L33ERMO, 1769-L36ERM, 1769-L36ERMO, 1769-L37ERM, 1769-L37ERMK, 1769-L37ERMO, 1769- L38ERM, 1769-L38ERMK, and 1769-L38ERMO Controllers	292
	1769-L18ERM-BB1B.....	294
	1769-L27ERM-QBFC1B Controller.....	295

	Chapter 12	
Use a Secure Digital Card	Store or Load a Project with the Secure Digital Card	299
	Store a Project	299
	Load a Project.....	303
	Appendix A	
Troubleshoot the Module	Use Logix Designer Application for Troubleshooting	305
	Fault Type Determination	307
	Use the CompactLogix 5370 Controllers Status Indicators	308
	Appendix B	
Replacement Considerations	Product Comparison	311
	Dimensions.....	312
	Power Supply Wiring.....	312
	Examples	314
	Appendix C	
Connect Power to the Series A CompactLogix 5370 L1 Controllers	CompactLogix 5370 L1, Series A, Controller Power Connection.	315
	CompactLogix 5370 L1, Series A, Controller Field Power to I/O Devices Connection.....	320
	Index	325

This manual describes the necessary tasks to install, configure, program, and operate a CompactLogix™ 5370 controller. This manual is intended for automation engineers and control system developers.

CompactLogix 5370 controllers are designed to provide solution for small and medium-sized applications.

Summary of Changes

This manual contains new and updated information as indicated in the following table.

Topic	Page
Added Catalog Numbers: 1769-L24ER-QBFC1BK, 1769-L30ERMK, 1769-L33ERMK, 1769-L37ERM, 1769-L37ERMK, 1769-L37ERMO, 1769-L38ERM, 1769-L38ERMK, 1769-L38ERMO	Throughout
Supported Local Expansion Modules	70
Controllers supporting Integrated Motion	279...292

Abbreviations

This table lists the abbreviations that this manual uses.

Abbreviation	Full Term
BOOTP	Bootstrap Protocol
CIP	Common Industrial Protocol
CJC	Cold Junction Composition
COS	Change of state
CST	Coordinated System Time
DHCP	Dynamic Host Configuration Protocol
DINT	Signed double integer
DLR	Device Level Ring
GSV	Get System Value
HMI	Human Machine Interface
IOT	Immediate Output
IP	Internet Protocol
JSR	Jump to Subroutine
MCR	Master Control Relay

Abbreviation	Full Term
MSG	Message
NEC	National Electrical Code
QoS	Quality of Service
RPI	Requested packet interval
RTB	Removable terminal block
RTD	Resistance Temperature Detector
RUIP	Removal and insertion under power
SD	Secure Digital
SELV	Safety Extra Low Voltage
SINT	Signed short integer
SNMP	Simple Network Management Protocol
SSV	Set System Value
TCP	Transmission Control Protocol
USB	Universal Serial Bus
UTC	Coordinated Universal Time

Product Compatibility and Download Center

For more information on controller firmware revisions and software application minimum requirements, go to the Rockwell Automation Product Compatibility and Download Center (PCDC) available at:
<http://compatibility.rockwellautomation.com/Pages/home.aspx>

You can access firmware for your CompactLogix 5370 controller in the Download section of the PCDC. You can see software compatibility for the software applications that are used in a CompactLogix 5370 control system in the Compare section of the PCDC.

Additional Resources

These resources contain information about related products from Rockwell Automation.

Resource	Description
CompactLogix Controllers Specifications Technical Data, publication 1769-TD005	Provides CompactLogix controller specifications for all CompactLogix controllers.
Armor CompactLogix Controllers Installation Instructions, publication 1769-IN021	Describes how to install the Armor™ CompactLogix controllers.
1769-SDN DeviceNet Scanner Module User Manual, publication 1769-UM009	Describes how to use the 1769-SDN to back up your CompactLogix 5370 L2 or L3 controller.
Compact High-speed Counter Module User Manual, publication 1769-UM006	Describes high-speed counter operation for standalone 1769-HSC when used with L2 and L3 Compact controllers and embedded high-speed counters in L2 embedded controllers.
Compact I/O DeviceNet Scanner Module Installation Instructions, publication 1769-IN060	Describes how to install the Compact I/O™ modules.
Compact I/O Expansion Power Supplies Installation Instructions, publication 1769-IN028	Describes how to wire the 1769 Compact I/O power supply.
Compact I/O Modules Installation Instructions, publication 1769-IN088	Describes how to install any 1769 Compact I/O module.
CompactLogix 5370 L1 Controllers Quick Start, publication IASIMP-QS024	Describes basic tasks to design, install, and start a CompactLogix 5370 L1 control system.
CompactLogix 5370 L2 Controllers Quick Start, publication IASIMP-QS025	Describes basic tasks to design, install, and start a CompactLogix 5370 L2 control system.
CompactLogix 5370 L3 Controllers Quick Start, publication IASIMP-QS023	Describes basic tasks to design, install, and start a CompactLogix 5370 L3 control system.
CompactLogix System Selection Guide, publication 1769-SG001	Describes available components for selecting a CompactLogix system.
Electronic Keying in Logix5000 Control Systems Application Technique, publication LOGIX-AT001	Describes the types of Electronic Keying available in Logix5000 control systems.
Ethernet Design Considerations Reference Manual, publication ENET-RM002	Describes the following concepts that you must consider when designing a control system that includes an EtherNet/IP network: <ul style="list-style-type: none"> • EtherNet/IP overview • Ethernet infrastructure • EtherNet/IP protocol
EtherNet/IP Embedded Switch Technology Application Guide, publication ENET-AP005	Describes how to use a DLR network topology.
Execution Time and Memory Use for Logix5000 Controller Instructions Reference Manual, publication 1756-RM087	Assists in estimating the memory use and execution time of programmed logic and in selecting among different programming options.
Integrated Motion on the EtherNet/IP Network: Configuration and Startup User Manual, publication MOTION-UM003	Describes how to configure an Integrated Motion over EtherNet/IP motion application and to start up that motion solution in a Logix5000™ control system.
Logix5000 Controllers Add On Instructions Programming Manual, publication 1756-PM010	Shows how to use Add-On Instructions for the Logix Designer application.
Logix5000 Controllers Common Procedures Programming Manual, publication 1756-PM001	Provides links to a collection of programming manuals that describe how you can use procedures that are common to all Logix5000 controller projects.

Resource	Description
Logix5000 Controllers General Instructions Reference Manual, publication 1756-RM003	Provides details about each available instruction for a Logix-based controller.
Logix5000 Controllers I/O and Tag Data Programming Manual, publication 1756-PM004	Provides information on how to access I/O and tag data in Logix5000 controllers.
Logix5000 Controllers Major, Minor, and I/O Faults Programming Manual, publication 1756-PM014	Shows how to monitor and handle major and minor controller faults. Also provides lists of major, minor, and I/O fault codes that you can use to troubleshoot your system.
POINT I/O 24V dc Expansion Power Supply Installation Instructions, publication 1734-IN058	Describes the 1734-EP24DC expansion power supply.
POINT I/O Digital and Analog Modules and POINTBlock I/O Modules User Manual, publication 1734-UM001	Describes how to return a 1734 POINT I/O™ module to Autobaud.
POINT I/O Field Potential Distributor Modules Installation Instructions, publication 1734-IN059	Describes the 1734-FPD POINT I/O Field Power Distributor module.
Using Event Tasks with Logix5000 Controller White Paper, publication LOGIX-WP003	Describes the use of event-based tasks with Logix5000 controllers.
Industrial Automation Wiring and Grounding Guidelines, publication 1770-4.1	Provides general guidelines for installing a Rockwell Automation industrial system.
Product Certifications website, http://www.rockwellautomation.com/global/certification/overview.page	Provides declarations of conformity, certificates, and other certification details.

You can view or download publications at <http://www.rockwellautomation.com/literature/>. To order paper copies of technical documentation, contact your local Allen-Bradley distributor or Rockwell Automation sales representative.

CompactLogix 5370 Controllers Overview

Topic	Page
CompactLogix 5370 Control System Components	14
Controller Functionality	15
Electronic Keying	17

The CompactLogix™ 5370 controllers offer state-of-the-art control, communication, and I/O elements in a distributed control package. This product family includes the following CompactLogix 5370 controllers:

- 1769-L16ER-BB1B
- 1769-L18ER-BB1B
- 1769-L18ERM-BB1B
- 1769-L19ER-BB1B
- 1769-L24ER-QB1B
- 1769-L24ER-QBFC1B
- 1769-L27ERM-QBFC1B
- 1769-L30ER
- 1769-L30ERM
- 1769-L30ER-NSE
- 1769-L33ER
- 1769-L33ERM
- 1769-L33ERMO
- 1769-L36ERM
- 1769-L36ERMO
- 1769-L37ERM, 1769-L37ERMK
- 1769-L37ERMO⁽¹⁾
- 1769-L38ERM, 1769-L38ERMK
- 1769-L38ERMO⁽¹⁾

Among the features the CompactLogix 5370 controllers support, are dual EtherNet/IP ports on each controller and support for Integrated Motion over an EtherNet/IP network on some CompactLogix 5370 controllers.

(1) Available at software version 31 and firmware revision 31.

The Armor™ CompactLogix controller, 1769-L33ERMO, 1769-L36ERMO, 1769-L37ERMO, or 1769-L38ERMO, combines the CompactLogix controller with a power supply in an IP67-rated housing for mounting on a machine. For information on how to install the Armor CompactLogix controller, see the Armor CompactLogix Controller Installation Instructions, publication [1769-IN021](#).

For a complete description of the CompactLogix 5370 control system components and functionality, see [Table 1](#) and [Table 2](#), respectively.

CompactLogix 5370 Control System Components

[Table 1](#) describes components a CompactLogix 5370 controller uses in a typical control system.

Table 1 - CompactLogix 5370 Control System Components

System Component	Product Family		
	CompactLogix 5370 L1 Controllers	CompactLogix 5370 L2 Controllers	CompactLogix 5370 L3 Controllers
Controller	One of the controllers that is documented in this publication		
Power supply	External power supply that is connected to the embedded 24V DC nominal input of the controller, nonisolated power supply. The power supply has a 10...28.8 input range.	External power supply that is connected to the embedded 24V DC input of the controller, isolated power supply	One of the following 1769 Compact I/O™ power supplies: <ul style="list-style-type: none"> • 1769-PA2 • 1769-PB2 • 1769-PA4 • 1769-PB4
Communication networks components	Any of the following: <ul style="list-style-type: none"> • EtherNet/IP network via built-in EtherNet/IP network ports • USB connection only for programming and firmware updates 	Any of the following: <ul style="list-style-type: none"> • EtherNet/IP network via built-in EtherNet/IP network ports • DeviceNet network via a 1769-SDN module • USB connection only for programming and firmware updates 	
Software	<ul style="list-style-type: none"> • One of the following: <ul style="list-style-type: none"> – RSLogix™ 5000 software, version 20.xx.xx, - For CompactLogix 5370 controllers that are using firmware revision 20.xxx – Logix Designer application, version 21.00.00 or later, - For CompactLogix 5370 controllers that are using firmware revision 21.000 or later • RSLinx® Classic software, version 2.59.xx or later • RSNetWorx™ for DeviceNet software, version 11.00.00 or later <p>IMPORTANT: This software is not used with CompactLogix 5370 L1 controllers because they do not offer DeviceNet connectivity.</p>		
Secure Digital (SD) card for external nonvolatile memory	<ul style="list-style-type: none"> • 1784-SD1 card - Ships with CompactLogix 5370 controller and offers 1 GB of memory • 1784-SD2 card - Available for separate purchase and offers 2 GB of memory 		
I/O modules	<ul style="list-style-type: none"> • 16 embedded 24V DC digital input points - The nominal input voltage is 24V DC but the operating range is 10...28.8V DC. • 16 embedded 24V DC digital output points - The nominal input voltage is 24V DC but the operating range is 10...28.8V DC. • Local expansion modules- 1734 POINT I/O™ modules • Distributed I/O - Multiple I/O module product lines over an EtherNet/IP network 	<ul style="list-style-type: none"> • 16 embedded 24V DC digital input points • 16 embedded 24V DC digital output points • Only 1769-L24ER-QBFC1B and 1769-L27ERM-QBFC1B controllers <ul style="list-style-type: none"> – Four embedded high-speed counters – Four embedded universal analog input points – Two embedded analog output points • Local expansion modules- 1769 Compact I/O modules • Distributed I/O - Multiple I/O module product lines over DeviceNet and EtherNet/IP networks 	<ul style="list-style-type: none"> • Local expansion modules- 1769 Compact I/O modules • Distributed I/O - Multiple I/O module product lines over DeviceNet and EtherNet/IP networks
Reset button	If held in during controller powerup, it clears the user program from the internal memory of the controller.		

Controller Functionality

[Table 2](#) describes functionality available with CompactLogix 5370 controllers.

Table 2 - CompactLogix 5370 Controller Functionality

Cat. No.	Controller Tasks Supported	Programs Supported Per Task	Internal Energy Storage Solution	EtherNet/IP Network Topology Support	Power Supply Distance Rating	Onboard User Memory Size	Local I/O Module Support
1769-L16ER-BB1B	32	1000	Yes - Eliminating the need for a battery	Support the following topologies: <ul style="list-style-type: none"> • Device Level Ring (DLR) • Linear • Traditional star 	NA	384 KB	As many as six 1734 POINT I/O modules ⁽³⁾
1769-L18ER-BB1B						512 KB	As many as eight 1734 POINT I/O modules ⁽³⁾
1769-L18ERM-BB1B						1 MB	
1769-L19ER-BB1B					See footnote ⁽²⁾	768 KB	As many as four Compact I/O modules
1769-L24ER-QB1B						1 MB	
1769-L24ER-QBFC1B							
1769-L27ERM-QBFC1B					4	1 MB	As many as eight Compact I/O modules
1769-L30ER							
1769-L30ER-NSE							
1769-L30ERM							
1769-L33ER						2 MB	As many as 16 Compact I/O modules
1769-L33ERM							—
1769-L33ERMO							
1769-L36ERM						3 MB	As many as 30 Compact I/O modules
1769-L36ERMO							—
1769-L37ERM, 1769-L37ERMK						4MB	
1769-L37ERMO ⁽¹⁾							
1769-L38ERM, 1769-L38ERMK					5MB		
1769-L38ERMO ⁽¹⁾							

(1) Available at software version 31 and firmware revision 31.

(2) CompactLogix 5370 L2 controllers have an embedded power supply. Therefore, you do not need to consider power supply distance rating when installing the controller. The Compact I/O modules that are used as local expansion modules in a CompactLogix 5370 L2 control systems operate on a CompactBus. These Compact I/O modules also have a power supply distance rating that you must consider when installing those modules.

For more information on power supply distance rating regarding how to use Compact I/O modules in a CompactLogix 5370 L2 control system, see [page 123](#) and [page 220](#).

(3) **IMPORTANT:** You can use up to the maximum number of 1734 POINT I/O modules with the CompactLogix 5370 L1 controllers that are listed in [Table 3](#). This applies only as long as the total current that the modules draw does not exceed the available POINTBus™ backplane current of 1 A. If you must use more local expansion modules than the POINTBus backplane current supports, you can install a 1734-EP24DC POINT I/O expansion power supply between local expansion modules to increase the POINTBus backplane power and meet your system requirements.

The 1769-L30ER-NSE controller is intended for use in applications that require the installed controller to deplete its residual stored energy to specific levels before transporting it into or out of your application.



WARNING: If your application requires the 1769-L30ER-NSE controller to deplete its residual stored energy to 200 μ J or fewer before you transport it into or out of the application, complete these steps before you remove the controller.

1. Turn off power to the chassis.
After you turn off power, the controller's OK status indicator transitions from Green to Solid Red to OFF.
 2. Wait **at least 15 minutes** for the residual stored energy to decrease to 200 μ J or fewer before you remove the controller.
There is no visual indication of when the 15 minutes has expired. **You must track that time period.**
-

IMPORTANT The Real Time Clock (RTC) does not retain its time and date when the power is off.

Some applications require that the installed controller to deplete its residual stored energy to specific levels before transporting it into or out of your application. This requirement can include other devices that also require a wait time before removing them. See the documentation of those products for more information.

Support for Integrated Motion over an EtherNet/IP Network

The following CompactLogix 5370 controllers support Integrated Motion over an EtherNet/IP network:

- 1769-L18ERM-BB1B
- 1769-L27ERM-QBFC1B
- 1769-L30ERM
- 1769-L33ERM
- 1769-L33ERMO
- 1769-L36ERM
- 1769-L36ERMO
- 1769-L37ERM
- 1769-L37ERMK
- 1769-L37ERMO⁽¹⁾
- 1769-L38ERM
- 1769-L38ERMK
- 1769-L38ERMO⁽¹⁾

(1) Available at software version 31 and firmware revision 31.

For more information on how to use CompactLogix 5370 controllers in applications that require Integrated Motion over an EtherNet/IP network, see Chapter 11, [Develop Integrated Motion over an EtherNet/IP Network Application on page 283](#).

Electronic Keying

Electronic Keying reduces the possibility that you use the wrong device in a control system. It compares the device that is defined in your project to the installed device. If keying fails, a fault occurs. These attributes are compared.

Attribute	Description
Vendor	The device manufacturer.
Device Type	The general type of the product, for example, digital I/O module.
Product Code	The specific type of the product. The Product Code maps to a catalog number.
Major Revision	A number that represents the functional capabilities of a device.
Minor Revision	A number that represents behavior changes in the device.

The following Electronic Keying options are available.

Keying Option	Description
Compatible Module	Lets the installed device accept the key of the device that is defined in the project when the installed device can emulate the defined device. With Compatible Module, you can typically replace a device with another device that has the following characteristics: <ul style="list-style-type: none"> • Same catalog number • Same or higher Major Revision • Minor Revision as follows: <ul style="list-style-type: none"> – If the Major Revision is the same, the Minor Revision must be the same or higher. – If the Major Revision is higher, the Minor Revision can be any number.
Disable Keying	Indicates that the keying attributes are not considered when attempting to communicate with a device. With Disable Keying, communication can occur with a device other than the type specified in the project. <p>ATTENTION: Be extremely cautious when using Disable Keying; if used incorrectly, this option can lead to personal injury or death, property damage, or economic loss.</p> <p>We strongly recommend that you do not use Disable Keying.</p> <p>If you use Disable Keying, you must take full responsibility for understanding whether the device being used can fulfill the functional requirements of the application.</p>
Exact Match	Indicates that all keying attributes must match to establish communication. If any attribute does not match precisely, communication with the device does not occur.

Carefully consider the implications of each keying option when selecting one.

IMPORTANT Changing Electronic Keying parameters online interrupts connections to the device and any devices that are connected through the device. Connections from other controllers can also be broken.

If an I/O connection to a device is interrupted, the result can be a loss of data.

More Information

For more detailed information on Electronic Keying, see Electronic Keying in Logix5000™ Control Systems Application Technique, publication [LOGIX-AT001](#).

Example System Configurations

CompactLogix 5370 controllers support the following networks:

- EtherNet/IP network - All CompactLogix 5370 controllers
- DeviceNet network - Only CompactLogix 5370 L2 and L3 controllers

EtherNet/IP Network

IMPORTANT [Figure 1](#), [Figure 2](#), and [Figure 3](#) show CompactLogix 5370 controllers that are used in a DLR network topology on an EtherNet/IP network. You can also use CompactLogix 5370 controllers in linear or star EtherNet/IP network topologies.

For more information on the other EtherNet/IP network topologies, see [Communicate over Networks on page 121](#).

Some of the CompactLogix 5370 controllers support Integrated Motion over an EtherNet/IP network, if desired. For more information on using Integrated Motion over an EtherNet/IP network, see Chapter 11, [Develop Integrated Motion over an EtherNet/IP Network Application on page 283](#).

[Figure 1](#) shows an example EtherNet/IP system configuration for a 1769-L18ERM-BB1B controller.

Figure 1 - Example 1769-L18ERM-BB1B Control System Configuration on an EtherNet/IP Network

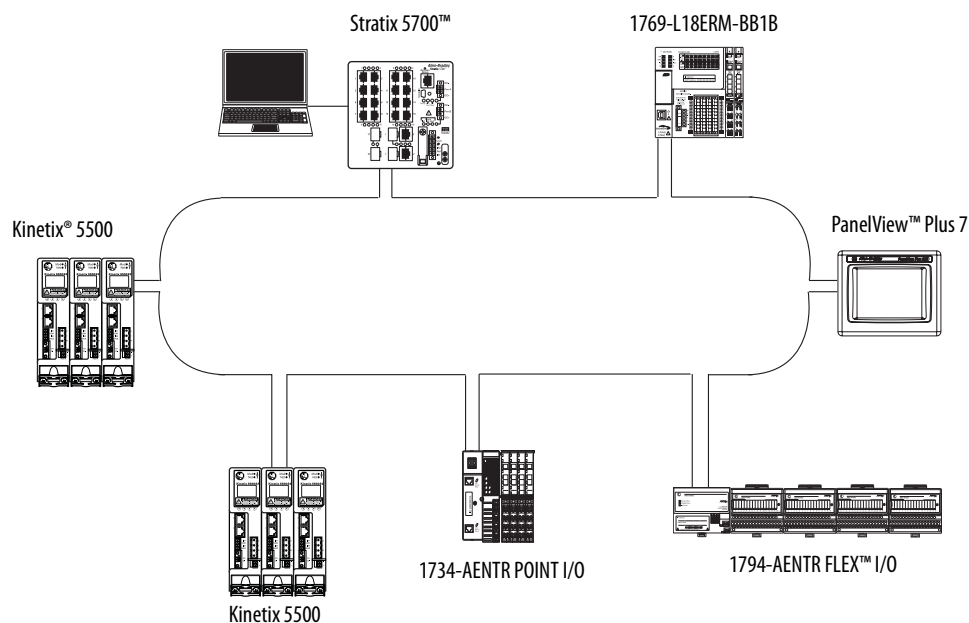

[Figure 2](#) shows an example EtherNet/IP system configuration for a 1769-L27ERM-QBFC1B controller.

Figure 2 - Example 1769-L27ERM-QBFC1B Control System Configuration on an EtherNet/IP Network

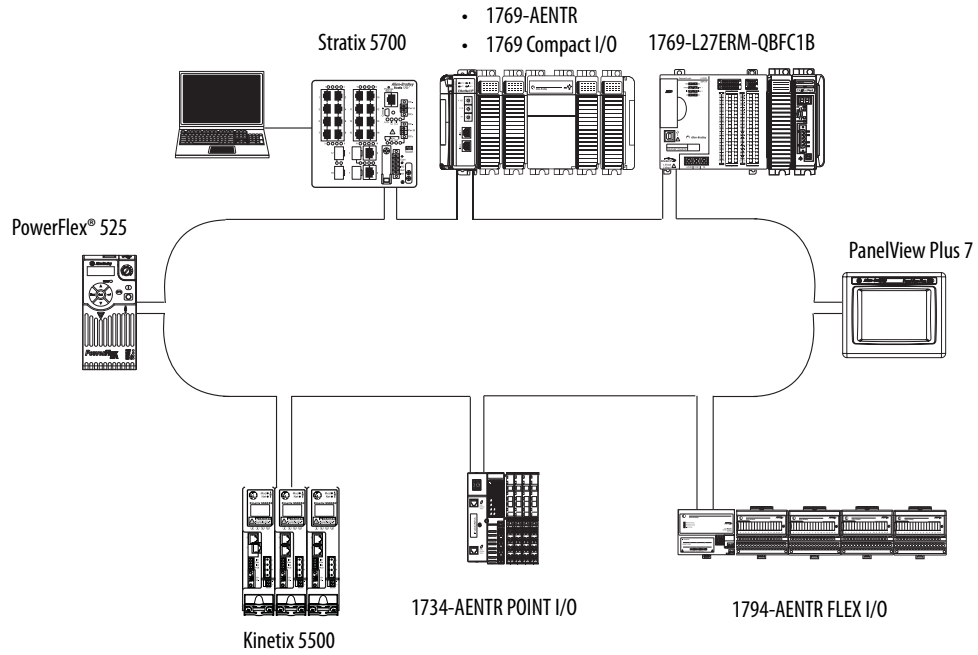

[Figure 3](#) shows an example EtherNet/IP system configuration for a 1769-L33ERM controller.

Figure 3 - Example 1769-L33ERM Control System Configuration on an EtherNet/IP Network

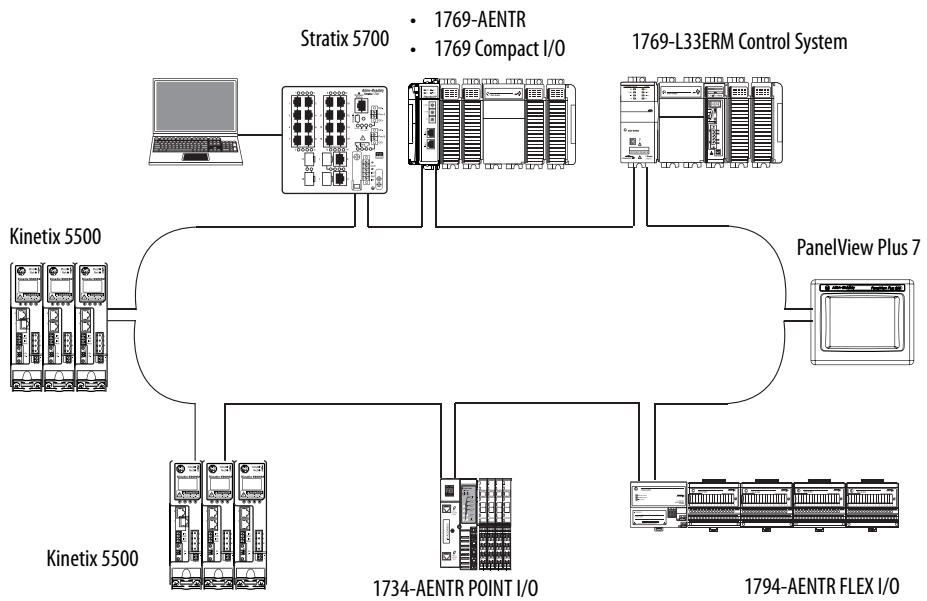

DeviceNet Network

IMPORTANT CompactLogix 5370 L2 and L3 controllers can send messages to devices on the DeviceNet network; however, these **controllers cannot receive** messages from those devices on the DeviceNet network.

Figure 4 shows an example DeviceNet system configuration for a CompactLogix 1769-L24ER-QB1B controller.

Figure 4 - Example 1769-L24ER-QB1B Control System Configuration on a DeviceNet Network

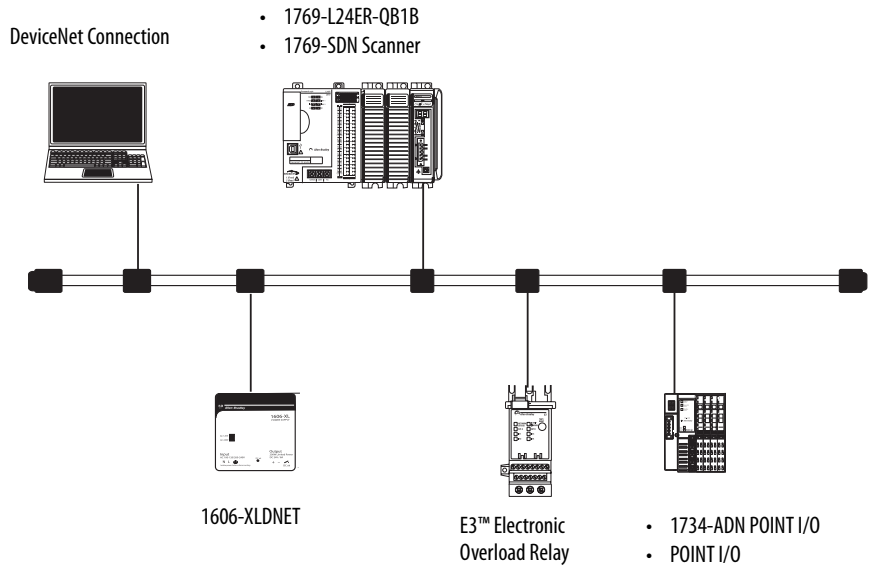
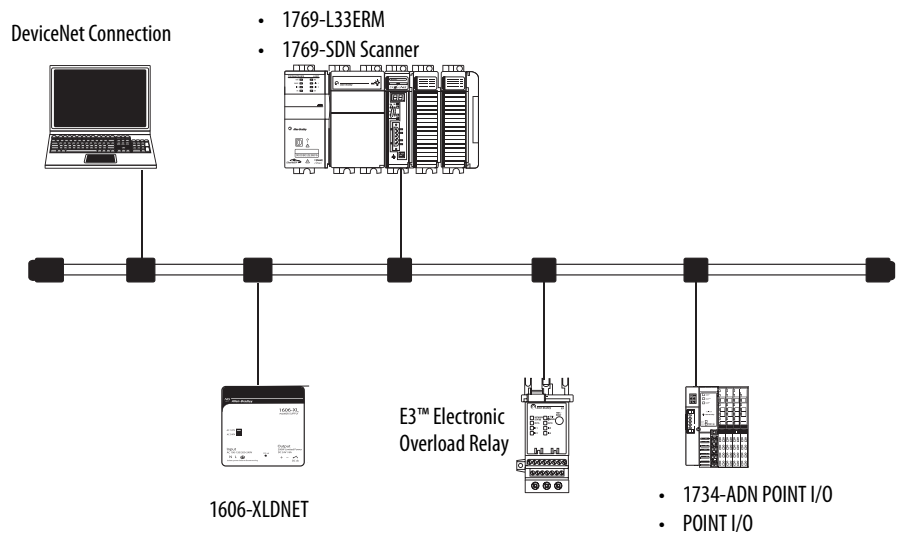

Figure 5 shows an example DeviceNet system configuration for a CompactLogix 1769-L33ERM controller.

Figure 5 - Example 1769-L33ERM Control System Configuration on a DeviceNet Network



For more information on how to use the CompactLogix 5370 L2 or L3 controllers on DeviceNet networks, see [Communicate over Networks on page 121](#).

Notes:

Install the CompactLogix 5370 L1 Controller

Topic	Page
Before You Begin	26
Install the Secure Digital Card	30
Install the System	32
Connect to the Controller Via a USB Cable	42
Connect the Controller to an EtherNet/IP Network	43

**ATTENTION:** Environment and Enclosure

This equipment is intended for use in a Pollution Degree 2 industrial environment, in overvoltage Category II applications (as defined in IEC 60664-1), at altitudes up to 2000 m (6562 ft) without derating.



This equipment is considered Group 1, Class A industrial equipment according to IEC/CISPR 11. Without appropriate precautions, there may be difficulties with electromagnetic compatibility in residential and other environments due to conducted and radiated disturbances.

This equipment is supplied as open-type equipment. It must be mounted within an enclosure that is suitably designed for those specific environmental conditions that will be present and appropriately designed to prevent personal injury resulting from accessibility to live parts. The enclosure must have suitable flame-retardant properties to prevent or minimize the spread of flame, complying with a flame spread rating of 5VA, V2, V1, V0 (or equivalent) if nonmetallic. The interior of the enclosure must be accessible only by the use of a tool. Subsequent sections of this publication may contain additional information regarding specific enclosure type ratings that are required to comply with certain product safety certifications.

In addition to this publication, see the following:

- Industrial Automation Wiring and Grounding Guidelines, publication [1770-4.1](#), for additional installation requirements
 - NEMA 250 and IEC 60529, as applicable, for explanations of the degrees of protection provided by enclosures
-

North American Hazardous Location Approval

<p>The following information applies when operating this equipment in hazardous locations.</p>	<p>Informations sur l'utilisation de cet équipement en environnements dangereux.</p>
<p>Products marked "CL I, DIV 2, GP A, B, C, D" are suitable for use in Class I Division 2 Groups A, B, C, D, Hazardous Locations and nonhazardous locations only. Each product is supplied with markings on the rating nameplate indicating the hazardous location temperature code. When combining products within a system, the most adverse temperature code (lowest "T" number) may be used to help determine the overall temperature code of the system. Combinations of equipment in your system are subject to investigation by the local Authority Having Jurisdiction at the time of installation.</p>	<p>Les produits marqués "CL I, DIV 2, GP A, B, C, D" ne conviennent qu'à une utilisation en environnements de Classe I Division 2 Groupes A, B, C, D dangereux et non dangereux. Chaque produit est livré avec des marquages sur sa plaque d'identification qui indiquent le code de température pour les environnements dangereux. Lorsque plusieurs produits sont combinés dans un système, le code de température le plus défavorable (code de température le plus faible) peut être utilisé pour déterminer le code de température global du système. Les combinaisons d'équipements dans le système sont sujettes à inspection par les autorités locales qualifiées au moment de l'installation.</p>
<div style="display: flex; align-items: center;">  <div> <p>WARNING: EXPLOSION HAZARD -</p> <ul style="list-style-type: none"> • Do not disconnect equipment unless power has been removed or the area is known to be nonhazardous. • Do not disconnect connections to this equipment unless power has been removed or the area is known to be nonhazardous. Secure any external connections that mate to this equipment by using screws, sliding latches, threaded connectors, or other means provided with this product. • Substitution of components may impair suitability for Class I, Division 2. • If this product contains batteries, they must only be changed in an area known to be nonhazardous. </div> </div>	<div style="display: flex; align-items: center;">  <div> <p>AVERTISSEMENT: RISQUE D'EXPLOSION –</p> <ul style="list-style-type: none"> • Couper le courant ou s'assurer que l'environnement est classé non dangereux avant de débrancher l'équipement. • Couper le courant ou s'assurer que l'environnement est classé non dangereux avant de débrancher les connecteurs. Fixer tous les connecteurs externes reliés à cet équipement à l'aide de vis, loquets coulissants, connecteurs filetés ou autres moyens fournis avec ce produit. • La substitution de composants peut rendre cet équipement inadapté à une utilisation en environnement de Classe I, Division 2. • S'assurer que l'environnement est classé non dangereux avant de changer les piles. </div> </div>

European Hazardous Location Approval

The following applies when the product bears the Ex Marking.

This equipment is intended for use in potentially explosive atmospheres as defined by European Union Directive 94/9/EC and has been found to comply with the Essential Health and Safety Requirements relating to the design and construction of Category 3 equipment intended for use in Zone 2 potentially explosive atmospheres, given in Annex II to this Directive.

Compliance with the Essential Health and Safety Requirements has been assured by compliance with EN 60079-15 and EN 60079-0.



ATTENTION: This equipment is not resistant to sunlight or other sources of UV radiation.

WARNING:

- This equipment must be installed in an enclosure providing at least IP54 protection when applied in Zone 2 environments.
- This equipment shall be used within its specified ratings defined by Rockwell Automation.
- Provision shall be made to prevent the rated voltage from being exceeded by transient disturbances of more than 40% when applied in Zone 2 environments.
- Secure any external connections that mate to this equipment by using screws, sliding latches, threaded connectors, or other means provided with this product.
- Do not disconnect equipment unless power has been removed or the area is known to be nonhazardous.
- Enclosure must be marked with the following: "Warning - Do not open when energized." After installation of equipment into the enclosure, access to termination compartments shall be dimensioned so that conductors can be readily connected.



ATTENTION: Prevent Electrostatic Discharge

This equipment is sensitive to electrostatic discharge, which can cause internal damage and affect normal operation. Follow these guidelines when you handle this equipment:

- Touch a grounded object to discharge potential static.
- Wear an approved grounding wriststrap.
- Do not touch connectors or pins on component boards.
- Do not touch circuit components inside the equipment.
- Use a static-safe workstation, if available.
- Store the equipment in appropriate static-safe packaging when not in use.

Before You Begin

The CompactLogix™ 5370 L1, series B, controller redesign occurred to provide an option to use one external power supply for system power and field side power.

There are differences between the CompactLogix 5370 L1, series A and B, controllers, which are detailed throughout the sections of this manual.

Consider the following before installing a CompactLogix 5370 L1 controller:



ATTENTION: If this equipment is used in a manner not specified by the manufacturer, the protection provided by the equipment can be impaired.

- The control system includes the controller, an embedded power supply, and embedded I/O points.

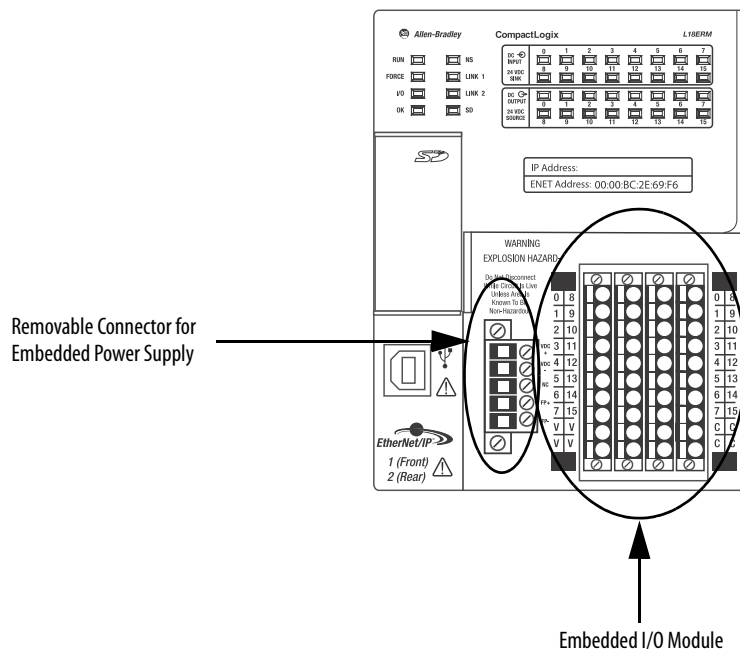

- The embedded power supply for the series A L16ER, L18ER, or L18ERM controller is a 24V DC nominal, non-isolated power supply with an input range of 10...28.8V DC. You wire the embedded power supply via a removable connector.
- The embedded power supply for the series B L16ER, L18ER, L18ERM, and series A L19ER controller is a 24V DC nominal, isolated power supply. The input range of the power supply is 10...28.8V DC. You wire the embedded power supply via a removable connector.

IMPORTANT You must use a dedicated external Class 2/SELV-approved power supply to provide power to the system, according to needs of the application, and within the operating voltage range of the controller for only series A L16ER, L18ER, and L18ERM controllers. You cannot use the external power supply that provides power to the embedded power supply of the controller to provide power to any other components or devices in the application for only series A L16ER, L18ER, and L18ERM controllers.

- A second, fused external power supply must be used to provide power to other components for only series A L16ER, L18ER, and L18ERM controllers (see [Appendix C](#)).
- Power for other components can be provided from the external power supply that is used to provide power to the system for only series B L16ER, L18ER, L18ERM Controllers, and series A L19ER controllers.
- The controller has 16 embedded digital input points and 16 embedded digital output points. You wire the input and output points via a removable connector.

- The controller supports the use of a limited number of 1734 POINT I/O™ modules on the POINTBus™ backplane as local expansion modules.

IMPORTANT You must use the latest series and firmware revision for all 1734 POINT I/O modules in the local expansion slots to make sure that your application operates as expected. Use of an older firmware revision renders the entire 1734 bus inoperable.

The following table lists local expansion module support by controller catalog number.

Table 3 - Local Expansion Module Support for CompactLogix 5370 L1 Controllers

Cat. No.	1734 POINT I/O Modules Supported, max
1769-L16ER-BB1B	6
1769-L18ER-BB1B	8
1769-L18ERM-BB1B	
1769-L19ER-BB1B	

See [Chapter 7](#) for further information about the I/O modules.



ATTENTION: Do not discard the end cap. Use this end cap to cover the exposed interconnections on the last mounting base on the DIN rail. Failure to do so could result in equipment damage or injury from electric shock.

For more information on how to terminate the end of your system, see [page 36](#).

1734 POINT I/O modules support removal and insertion under power.

CompactLogix 5370 L1 Controller Parts

These parts are included in the box when you order your controller:

- Controller - Specific catalog number varies by order
- 1784-SD1 Secure Digital (SD) card with 1 GB of memory storage

A 1784-SD2 SD card with 2 GB of memory storage, or more 1784-SD1 SD cards, are also available if you need extra memory.

IMPORTANT The life expectancy of nonvolatile media is dependent on the number of write cycles that are performed. Nonvolatile media use a wear leveling technique or technology for prolonging the service life, but avoid frequent writes.

Avoid frequent writes when logging data. We recommend that you log data to a buffer in the memory of your controller and limit the number of times data is written to removable media.

- An end cap protective cover that slides onto the right side of the CompactLogix 5370 L1 control system.

Installation Summary

To install a CompactLogix 5370 L1 controller, follow these steps.

1. [Install the Secure Digital Card.](#)
2. [Install the System.](#)
3. [Connect to the Controller Via a USB Cable.](#)
4. [Connect the Controller to an EtherNet/IP Network.](#)

Install the Secure Digital Card

The CompactLogix 5370 L1 controller is shipped from the factory with the 1784-SD1 SD card installed.

Complete these steps to reinstall an SD card that has been removed from the controller back into the controller or to install a new SD card into the controller.

We recommend that you leave the SD card in the controller, even when it is not used. If the controller experiences a major non-recoverable fault, extended fault information is saved to the card.



WARNING: When you insert or remove the SD card while power is on, an electrical arc can occur. This could cause an explosion in hazardous location installations.

Be sure that power is removed or the area is nonhazardous before proceeding.

1. Verify that the SD card is locked or unlocked according to your preference. Consider the following when deciding to lock the card before installation:
 - If the card is unlocked, the controller can write data to it or read data from it.

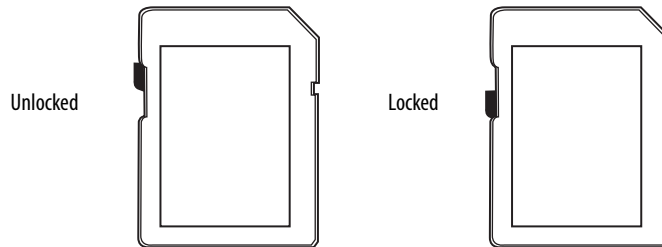

2. Open the door for the SD card.

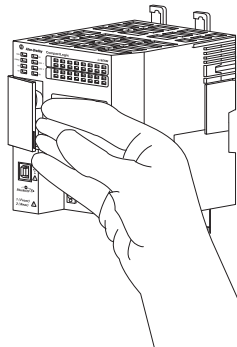

3. Insert the SD card into the SD card slot.

You can install the SD card in only one orientation. The beveled corner is at the top.

If you feel resistance when inserting the SD card, pull it out and change the orientation.

4. Gently press the card until it clicks into place.

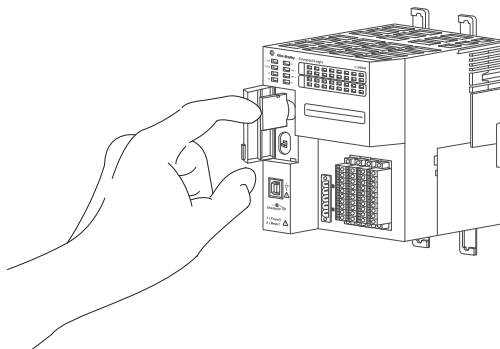

5. Close the SD card door.

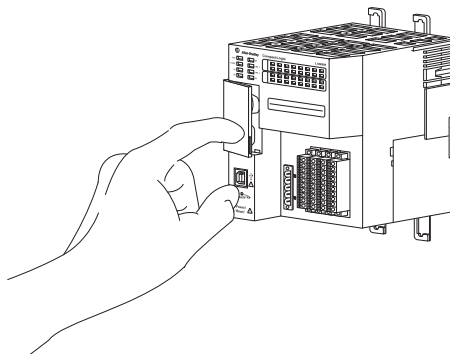

We recommend that you keep the SD card door closed during normal system operation. For more information on how to use the SD card, see [Use a Secure Digital Card on page 297](#).

Install the System

Complete the following steps to install the CompactLogix 5370 L1 control system.

- [Mount the System](#)
- [Ground the System](#)
- [Install the Controller](#)
- [Connect Power to the Controller \(Series B\)](#) L16 ER, L18ER, L18ERM series B controllers, and series A L19ER

Mount the System

You mount a CompactLogix 5370 L1 control system on a DIN rail. Before you complete the steps that are required to install the system, install a DIN rail.



WARNING: When used in a Class I, Division 2, hazardous location, this equipment must be mounted in a suitable enclosure with proper wiring method that complies with the governing electrical codes.

Before you mount a CompactLogix 5370 L1 control system, consider the following requirements:

- [Available DIN Rails](#)
- [Minimum Spacing](#)
- [System Dimensions](#)

Available DIN Rails



ATTENTION: This product is grounded through the DIN rail to chassis ground. Use zinc-plated yellow-chromate steel DIN rail to assure proper grounding. The use of other DIN rail materials (for example, aluminum or plastic) that can corrode, oxidize, or are poor conductors, can result in improper or intermittent grounding. Secure DIN rail to mounting surface approximately every 200 mm (7.8 in.) and use end-anchors appropriately.

You can mount the CompactLogix 5370 L1 controller on the following DIN rails:

- EN 50 022 - 35 x 7.5 mm (1.38 x 0.30 in.)
- EN 50 022 - 35 x 15 mm (1.38 x 0.59 in.)

IMPORTANT You must install bumpers on the back of your CompactLogix 5370 L1 controller before mounting it on the EN 50022 - 35 x 15 mm (1.38 x 0.59 in.) DIN rail.

Bumper Selection:

- For more information on Bumper Selection, see Rockwell Automation® Knowledgebase article #591565. You can access the article at: (Login required)
<https://rockwellautomation.custhelp.com/>
-

Minimum Spacing

Maintain spacing from enclosure walls, wireways, and adjacent equipment. Allow 50 mm (2 in.) of space on all sides, as shown. This spacing provides ventilation and electrical isolation.

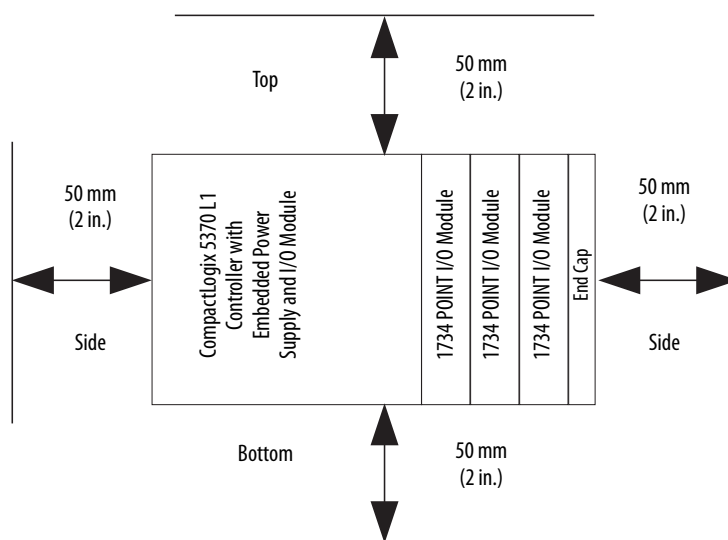

System Dimensions

This graphic shows the system dimensions.

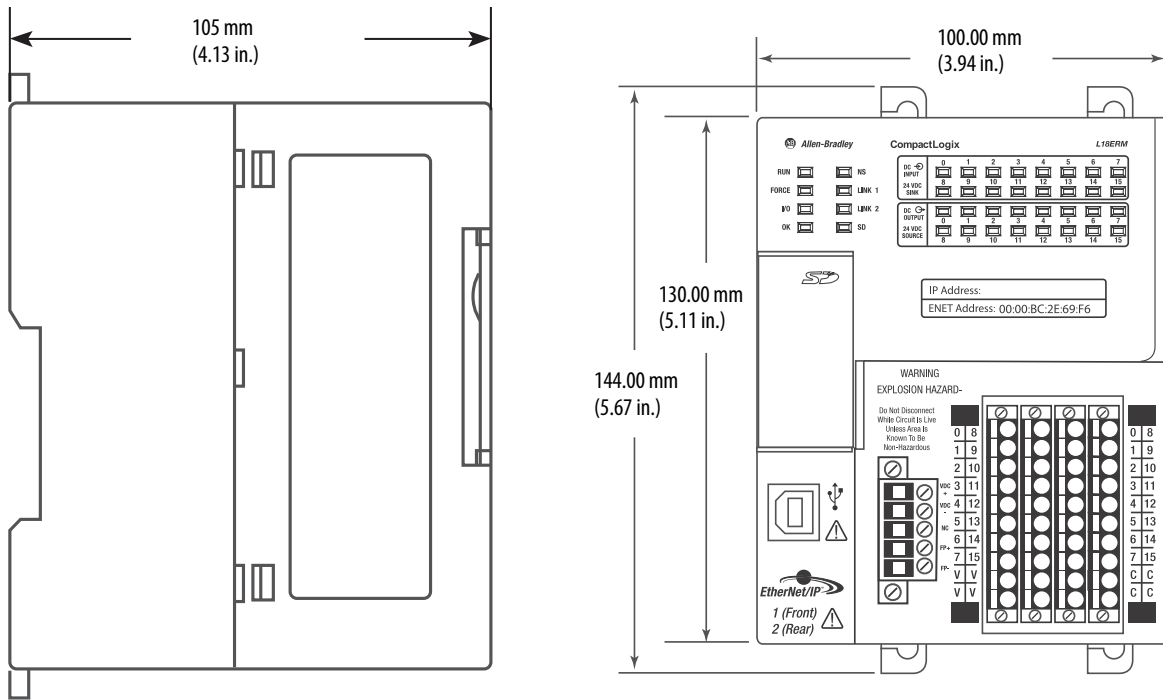

This graphic shows the system dimensions with Expansion I/O modules installed.

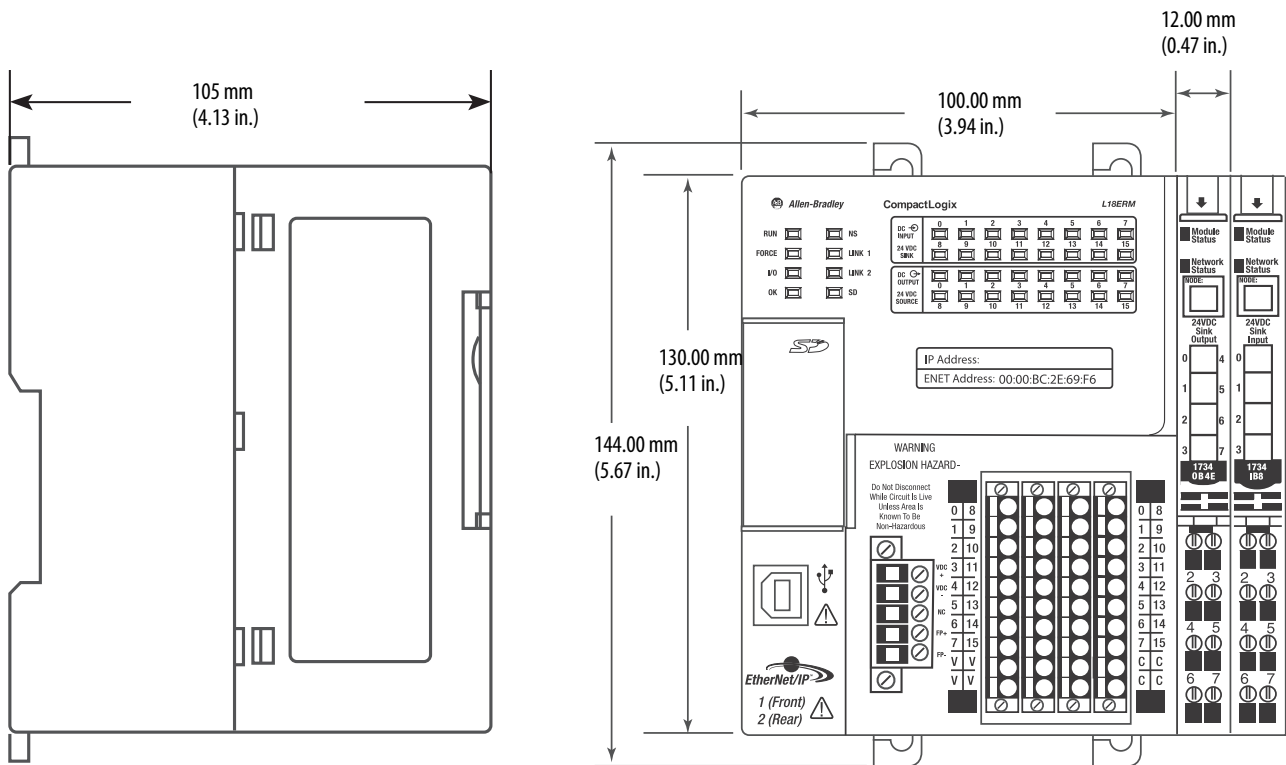

Ground the System



ATTENTION: This product is intended to be mounted to a well-grounded mounting surface such as a metal panel. Additional grounding connections from the power supply's mounting tabs or DIN rail (if used) are not required unless the mounting surface cannot be grounded.

See Industrial Automation Wiring and Grounding Guidelines, Rockwell Automation publication [1770-4.1](#), for additional information.

Install the Controller

Complete these steps to install the controller.

1. Pull out the locking tabs.

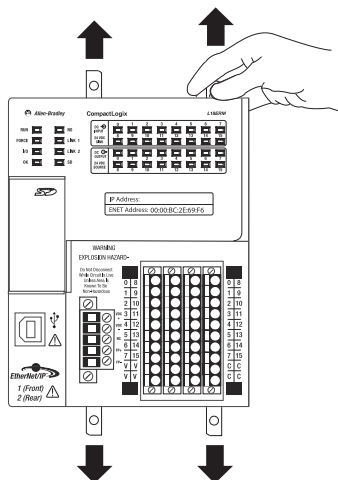

2. Slide the controller into position on the DIN rail and push the locking tabs in.

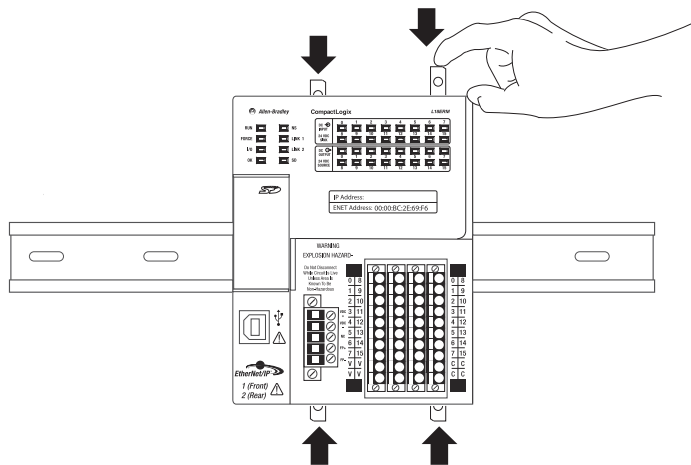

3. If you are not using local expansion modules, use the tongue-and-groove slots on the right side of the controller to slide a protective covering onto the controller. The protective cover ships with the controller.

The covering covers the exposed interconnections on the right side of the controller. Failure to use a protective covering can result in equipment damage or injury from electric shock.

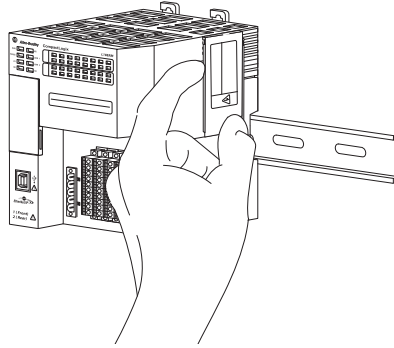

If you are using local expansion modules, see [Local Expansion Modules on page 157](#) for more information on how to install them in a CompactLogix 5370 L1 control system.

Install the Removable Terminal Block

A removable terminal block (RTB) is supplied with your wiring base assembly. To remove, pull up on the RTB handle. This feature allows the mounting base to be removed and replaced as necessary without removing any wires. To reinsert the removable terminal block, proceed as follows:

1. Insert the end opposite the handle into the base unit. This end has a curved section that engages with the wiring base.
2. Rotate the RTB into the wiring base until it locks itself in place.

3. If an I/O module is installed, snap the RTB handle into place on the module.

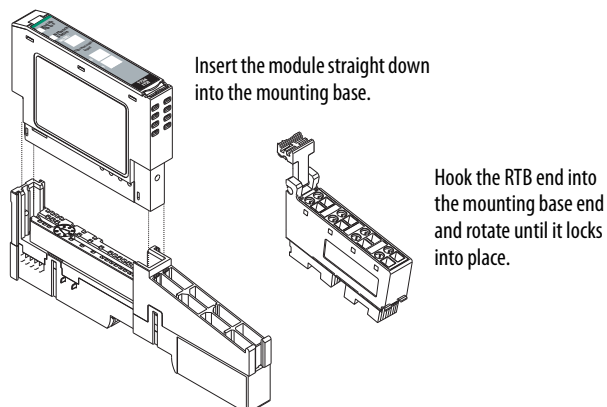

WARNING: When you connect or disconnect the RTB with field-side power applied, an electrical arc can occur. This can cause an explosion in hazardous location installations.

Be sure that power is removed or the area is nonhazardous before proceeding.

Connect Power to the Controller (Series B)

For information to connect power to a series A L1 controller, see [Appendix C](#).

IMPORTANT This section describes how to power the controller via the VDC+ and VDC- terminals.

Connections to the VDC+ and VDC- terminals **do not** provide power to input or output devices that are connected to the embedded I/O modules of the controller or local expansion modules. Power must be connected to the FP+ and FP- terminals to provide power to input or output devices that are connected to the embedded I/O modules of the controller or local expansion modules.

The external power supply can be used to power both the VDC+/- and FP+/- terminals on the series B L1 controller, see [page 144](#).

For more information on how to provide power to input or output devices that are connected to the embedded I/O modules of the controller and local expansion modules, see [page 144](#).



WARNING: Do not connect directly to line voltage. Line voltage must be supplied by a suitable, approved isolating transformer or power supply having short circuit capacity not exceeding 100VA maximum or equivalent. The controller power requirement is 30VA.

Power is connected to the controller via a removable connector that is connected to the front of the controller. The following graphic shows the connector.

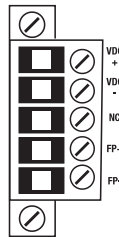

IMPORTANT The controller is grounded once it is installed on a DIN rail as described in [Mount the System on page 32](#).

Consider these points before completing the steps in this section:

- This section describes how to connect an external 24V DC power source to the CompactLogix 5370 L1 controller.

For information on how to provide field power to input and output devices that are connected to the embedded I/O modules of the controller and local expansion modules via the removable connector, see [page 144](#).

- Use a power source that most effectively meets your application needs. That is, calculate the power requirements for your application before choosing a power source to avoid using a power source that far exceeds your application requirements.
- This section assumes that any DIN rail you use has been grounded following Industrial Automation Wiring and Grounding Guidelines, publication [1770-4.1](#).
- The embedded power supply of the CompactLogix 5370 L1 controller provides power to the controller and POINTBus backplane.

- Not all Class 2/SELV-listed power supplies are certified for use in all applications, for example, use in nonhazardous and hazardous environments.

Before installing an external power supply, consult all specification and certification information to verify that you are using an acceptable external power supply.

- Only for example purposes, this section describes how to use a 1606-XLE120E, NEC Class 2 switched-mode power supply. The exact steps for other external power supplies can vary from the steps that are described here.

Complete these steps to connect power to the CompactLogix series B L16ER, L18ER, L18ERM, and series A L19ER controllers.

1. Verify that the external 24V DC power source is not powered.
2. Mount the external 24V DC power source on a DIN rail.

The external 24V DC power source can be installed on the same DIN rail as the controller or a separate DIN rail.

3. Connect wires to the 24V DC+ and 24V DC- connections on the external 24V DC power source.



WARNING: If you connect or disconnect wiring while the field-side power is on, an electrical arc can occur. This could cause an explosion in hazardous location installations. Be sure that power is removed or the area is nonhazardous before proceeding.

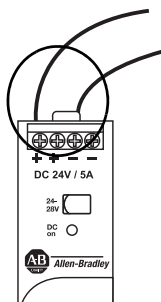

4. Pull the removable connector off the CompactLogix 5370 L1 controller.

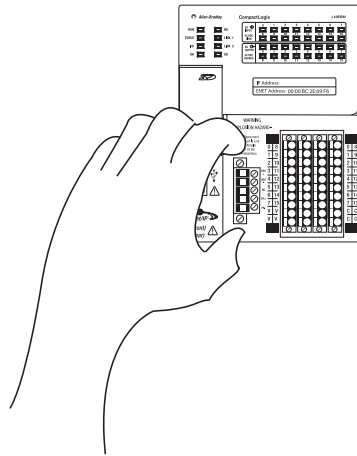

5. Connect the wire that is connected to the 24V DC+ terminal on the external 24V DC power source to the VDC+ terminal. The VDC+ terminal is the top terminal on the removable connector.

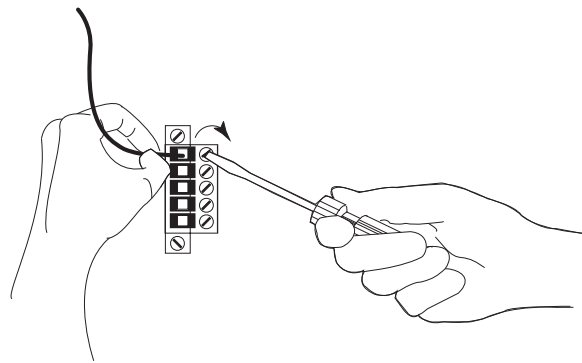

6. Connect the wire that is connected to the 24V DC- terminal on the external 24V DC power source to the VDC- terminal. The VDC- terminal is the second from the top on the removable connector.

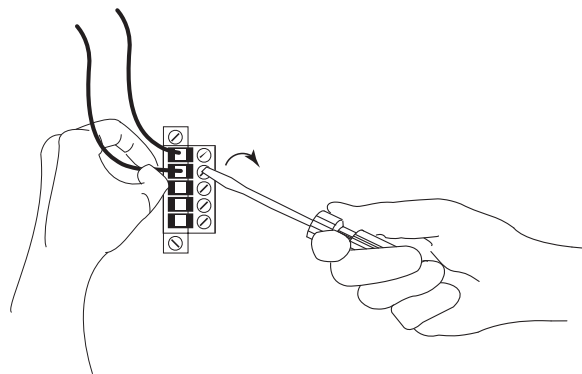

IMPORTANT If your application requires a power control device, for example, a switch or relay, between the external 24V DC power source and the CompactLogix 5370 L1 controller to control when the controller is powered, you must install the power control device at the VDC+ terminal on the removable connector.

If you install the power control device at the VDC- terminal, the CompactLogix 5370 L1 controller can have problems powering up or powering down properly.

7. Plug the removable connector back into the controller.
8. Secure the removable connector in place.

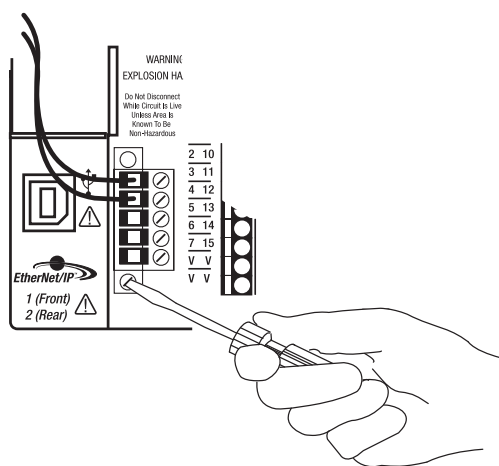

9. Turn on power to the external 24V DC power source.

The following graphic shows an external 24V DC power source that is connected to a CompactLogix 5370 L1 controller.

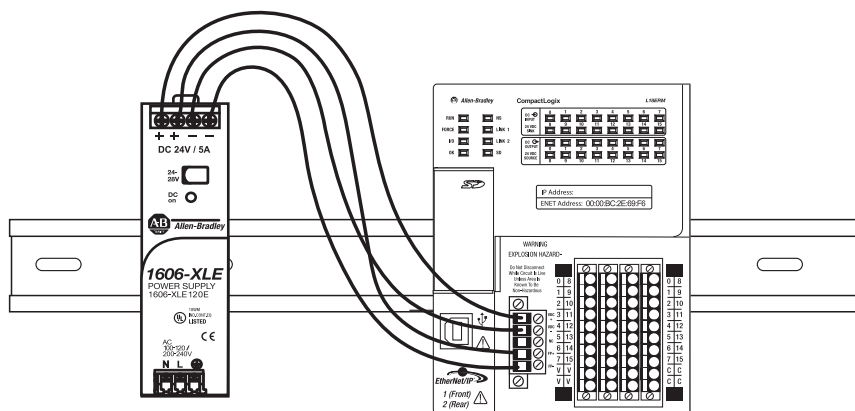

Connect to the Controller Via a USB Cable

The controller has a USB port that uses a Type B receptacle. The port is USB 2.0-compatible and operates at 12 Mbps.

Use a USB cable to connect your computer to the USB port. With this connection, you can update firmware and download programs to the controller directly from your computer.



ATTENTION: The USB port is intended only for temporary local programming purposes and not intended for permanent connection. The USB cable is not to exceed 3.0 m (9.84 ft) and must not contain hubs.



WARNING: Do not use the USB port in hazardous locations.

Plug the USB cable into the CompactLogix 5370 L1 controller.

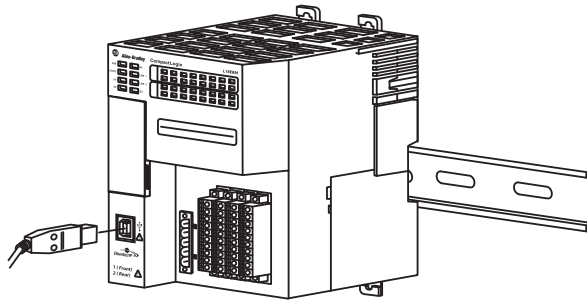

Connect the Controller to an EtherNet/IP Network



WARNING: If you connect or disconnect the communication cable with power applied to this module or any device on the network, an electrical arc can occur. This could cause an explosion in hazardous location installations.

Be sure that power is removed or the area is nonhazardous before proceeding.

Connect the RJ45 connector of the Ethernet cable to one of the Ethernet ports on the controller. The ports are on the bottom of the controller.

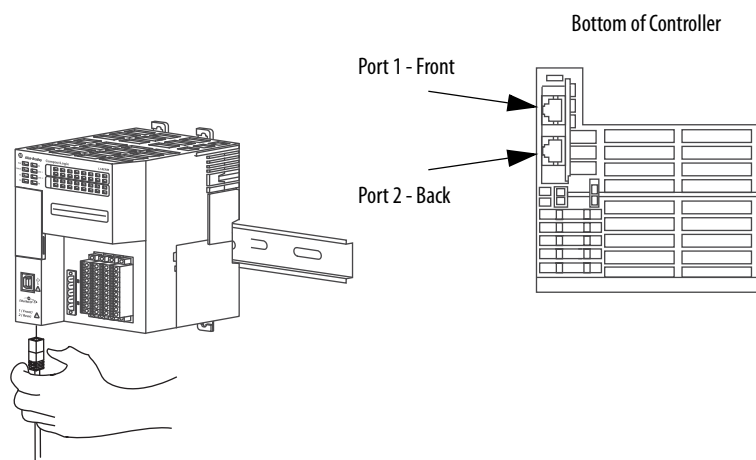

IMPORTANT This example shows how to connect the controller to the network through one port. Depending on the network topology of your application, you can connect both ports of the controller to the EtherNet/IP network.

For more information on EtherNet/IP network topologies, see [page 125](#).

Connecting to Different EtherNet/IP Network Topologies

CompactLogix 5370 L1 controllers have embedded switch technology and two EtherNet/IP ports that let you use it in various EtherNet/IP network topologies:

- Device Level Ring network topology - Both ports on the controller are connected to the network.
- Linear network topology - Both ports on the controller are connected to the network.
- Star network topology - One port on the controller is connected to the network.

There are connection and configuration requirements for each EtherNet/IP network topology.

For more information, see [EtherNet/IP Network Topologies on page 125](#).

Notes:

Install the CompactLogix 5370 L2 Controller

Topic	Page
Before You Begin	48
Install the Secure Digital Card	50
Install the System	52
Connect to the Controller Via a USB Cable	65
Connect the Controller to an EtherNet/IP Network	66



ATTENTION: Environment and Enclosure

This equipment is intended for use in a Pollution Degree 2 industrial environment, in overvoltage Category II applications (as defined in IEC 60664-1), at altitudes up to 2000 m (6562 ft) without derating.



This equipment is considered Group 1, Class A industrial equipment according to IEC/CISPR 11. Without appropriate precautions, there may be difficulties with electromagnetic compatibility in residential and other environments due to conducted and radiated disturbances.

This equipment is supplied as open-type equipment. It must be mounted within an enclosure that is suitably designed for those specific environmental conditions that will be present and appropriately designed to prevent personal injury resulting from accessibility to live parts. The enclosure must have suitable flame-retardant properties to prevent or minimize the spread of flame, complying with a flame spread rating of 5VA, V2, V1, V0 (or equivalent) if nonmetallic. The interior of the enclosure must be accessible only by the use of a tool. Subsequent sections of this publication may contain additional information regarding specific enclosure type ratings that are required to comply with certain product safety certifications.

In addition to this publication, see the following:

- Industrial Automation Wiring and Grounding Guidelines, publication [1770-4.1](#), for additional installation requirements
 - NEMA 250 and IEC 60529, as applicable, for explanations of the degrees of protection provided by enclosures
-

North American Hazardous Location Approval

<p>The following information applies when operating this equipment in hazardous locations.</p>	<p>Informations sur l'utilisation de cet équipement en environnements dangereux.</p>
<p>Products marked "CL I, DIV 2, GP A, B, C, D" are suitable for use in Class I Division 2 Groups A, B, C, D, Hazardous Locations and nonhazardous locations only. Each product is supplied with markings on the rating nameplate indicating the hazardous location temperature code. When combining products within a system, the most adverse temperature code (lowest "T" number) may be used to help determine the overall temperature code of the system. Combinations of equipment in your system are subject to investigation by the local Authority Having Jurisdiction at the time of installation.</p>	<p>Les produits marqués "CL I, DIV 2, GP A, B, C, D" ne conviennent qu'à une utilisation en environnements de Classe I Division 2 Groupes A, B, C, D dangereux et non dangereux. Chaque produit est livré avec des marquages sur sa plaque d'identification qui indiquent le code de température pour les environnements dangereux. Lorsque plusieurs produits sont combinés dans un système, le code de température le plus défavorable (code de température le plus faible) peut être utilisé pour déterminer le code de température global du système. Les combinaisons d'équipements dans le système sont sujettes à inspection par les autorités locales qualifiées au moment de l'installation.</p>
<div style="display: flex; align-items: center;">  <div> <p>WARNING: EXPLOSION HAZARD -</p> <ul style="list-style-type: none"> • Do not disconnect equipment unless power has been removed or the area is known to be nonhazardous. • Do not disconnect connections to this equipment unless power has been removed or the area is known to be nonhazardous. Secure any external connections that mate to this equipment by using screws, sliding latches, threaded connectors, or other means provided with this product. • Substitution of components may impair suitability for Class I, Division 2. • If this product contains batteries, they must only be changed in an area known to be nonhazardous. </div> </div>	<div style="display: flex; align-items: center;">  <div> <p>AVERTISSEMENT: RISQUE D'EXPLOSION –</p> <ul style="list-style-type: none"> • Couper le courant ou s'assurer que l'environnement est classé non dangereux avant de débrancher l'équipement. • Couper le courant ou s'assurer que l'environnement est classé non dangereux avant de débrancher les connecteurs. Fixer tous les connecteurs externes reliés à cet équipement à l'aide de vis, loquets coulissants, connecteurs filetés ou autres moyens fournis avec ce produit. • La substitution de composants peut rendre cet équipement inadapté à une utilisation en environnement de Classe I, Division 2. • S'assurer que l'environnement est classé non dangereux avant de changer les piles. </div> </div>

European Hazardous Location Approval

The following applies when the product bears the Ex Marking.

This equipment is intended for use in potentially explosive atmospheres as defined by European Union Directive 2014/34/EU and has been found to comply with the Essential Health and Safety Requirements relating to the design and construction of Category 3 equipment intended for use in Zone 2 potentially explosive atmospheres, given in Annex II to this Directive.

Compliance with the Essential Health and Safety Requirements has been assured by compliance with EN 60079-15 and EN 60079-0.



ATTENTION: This equipment is not resistant to sunlight or other sources of UV radiation.

WARNING:

- This equipment must be installed in an enclosure providing at least IP54 protection when applied in Zone 2 environments.
- This equipment shall be used within its specified ratings defined by Rockwell Automation.
- Provision shall be made to prevent the rated voltage from being exceeded by transient disturbances of more than 40% when applied in Zone 2 environments.
- Secure any external connections that mate to this equipment by using screws, sliding latches, threaded connectors, or other means provided with this product.
- Do not disconnect equipment unless power has been removed or the area is known to be nonhazardous.
- Enclosure must be marked with the following: "Warning - Do not open when energized." After installation of equipment into the enclosure, access to termination compartments shall be dimensioned so that conductors can be readily connected.



ATTENTION: Prevent Electrostatic Discharge

This equipment is sensitive to electrostatic discharge, which can cause internal damage and affect normal operation. Follow these guidelines when you handle this equipment:

- Touch a grounded object to discharge potential static.
- Wear an approved grounding wriststrap.
- Do not touch connectors or pins on component boards.
- Do not touch circuit components inside the equipment.
- Use a static-safe workstation, if available.
- Store the equipment in appropriate static-safe packaging when not in use.

Before You Begin

Consider the following before installing a CompactLogix™ 5370 L2 controller:

- The control system includes a controller, an embedded power supply, embedded I/O points, and a 1769-ECR right end cap.
- The embedded power supply is a 24V DC input, isolated power supply

The following graphic shows an example CompactLogix 5370 L2 controller.

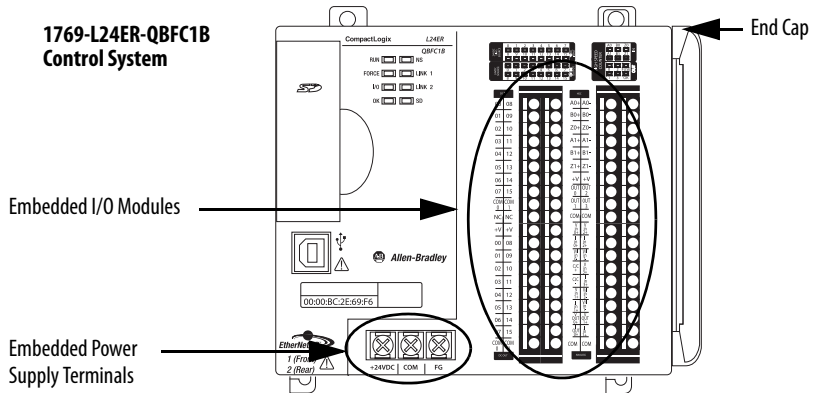

ATTENTION: You must use an external power supply that is Class 2 or SELV-listed for series A L1 controllers.

For example, you can use a 1606-XLSDNET4, standard switched-mode power supply, as shown in this chapter.

- The controllers have embedded I/O points. You wire the input and output points via a removable connector.
- The controller supports the use of up to four Compact I/O™ modules on the local 1769 CompactBus backplane as local expansion modules.

For more information on how to use **embedded I/O** points and **local expansion modules**, see Chapter 8, [Use I/O Modules with CompactLogix 5370 L2 Controllers on page 181](#).

- You must terminate the end of the CompactBus via a 1769-ECR right end cap as shown in [step 6 on page 59](#).
- You cannot remove nor install Compact I/O modules while the controller is powered.



ATTENTION: CompactLogix 5370 L2 control systems do not support removal and insertion under power (RIUP). Removing a 1769 Compact I/O module or end cap generates a controller fault and may also result in damage to system components.

CompactLogix 5370 L2 Controller Parts

These parts are included in the box when you order your controller:

- Controller - Specific catalog number varies by order
- 1769-ECR Compact I/O end cap/terminator
- 1784-SD1 Secure Digital (SD) card with 1 GB of memory storage

A 1784-SD2 SD card with 2 GB of memory storage, or more 1784-SD1 SD cards, are also available if you need extra memory.

IMPORTANT The life expectancy of nonvolatile media is dependent on the number of write cycles that are performed. Nonvolatile media use a wear leveling technique or technology for prolonging the service life, but avoid frequent writes.

Avoid frequent writes when logging data. We recommend that you log data to a buffer in the memory of your controller and limit the number of times data is written to removable media.

Installation Summary

To install a CompactLogix 5370 L2 controller, follow these steps.

1. [Install the Secure Digital Card.](#)
2. [Install the System.](#)
3. [Connect to the Controller Via a USB Cable.](#)
4. [Connect the Controller to an EtherNet/IP Network.](#)

Install the Secure Digital Card

The CompactLogix 5370 L2 controller is shipped from the factory with the 1784-SD1 SD card installed.

Complete these steps to reinstall an SD card that has been removed from the controller back into the controller or to install a new SD card into the controller.

We recommend that you leave the SD card in the controller, even when it is not used. If the controller experiences a Major Non-recoverable Fault, extended fault information is saved to the card.



WARNING: When you insert or remove the SD card while power is on, an electrical arc can occur. This could cause an explosion in hazardous location installations.

Be sure that power is removed or the area is nonhazardous before proceeding.

1. Verify that the SD card is locked or unlocked according to your preference. Consider the following when deciding to lock the card before installation:
 - If the card is unlocked, the controller can write data to it or read data from it.

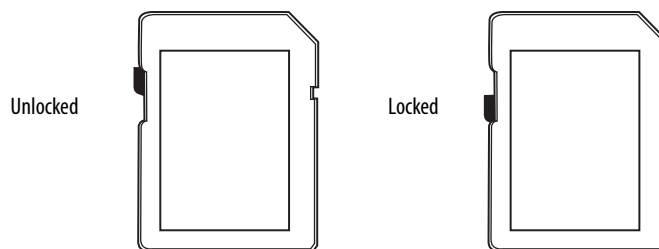

2. Open the door for the SD card.

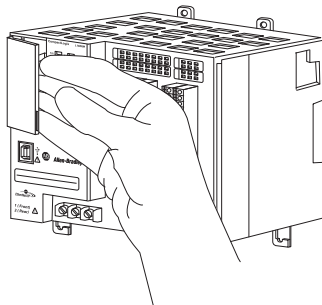

3. Insert the SD card into the SD card slot.

You can install the SD card in one orientation only. The beveled corner is at the bottom.

If you feel resistance when inserting the SD card, pull it out and change the orientation.

4. Gently press the card until it clicks into place.

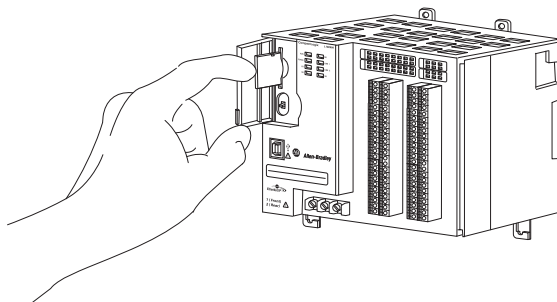

5. Close the SD card door.

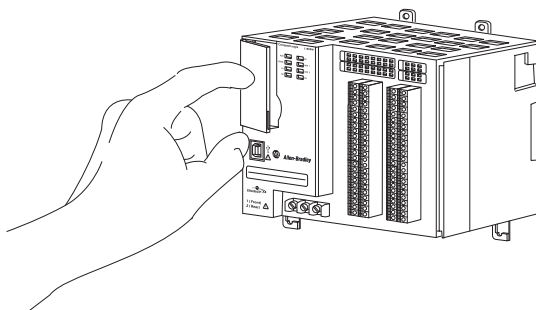

We recommend that you keep the SD card door closed during normal system operation. For more information on how to use the SD card, see [Use a Secure Digital Card on page 297](#).

Install the System

Complete the following tasks to install the CompactLogix 5370 L2 control system:

- [Mount the System](#)
- [Ground the System](#)
- [Install the Controller](#)
- [Connect Power to the Control System](#)

Mount the System

You can mount a CompactLogix 5370 L2 control system on a DIN rail or a panel.



WARNING: When used in a Class I, Division 2, hazardous location, this equipment must be mounted in a suitable enclosure with proper wiring method that complies with the governing electrical codes.

Before you mount a CompactLogix 5370 L2 control system, consider the following requirements:

- [Available DIN Rails](#)
- [Minimum Spacing](#)
- [System Dimensions](#)

Available DIN Rails



ATTENTION: This product is grounded through the DIN rail to chassis ground. Use zinc-plated yellow-chromate steel DIN rail to assure proper grounding. The use of other DIN rail materials (for example, aluminum or plastic) that can corrode, oxidize, or are poor conductors, can result in improper or intermittent grounding. Secure DIN rail to mounting surface approximately every 200 mm (7.8 in.) and use end-anchors appropriately.

You can mount the CompactLogix 5370 L2 controller on the following DIN rails:

- EN 50 022 - 35 x 7.5 mm (1.38 x 0.30 in.)
- EN 50 022 - 35 x 15 mm (1.38 x 0.59 in.)

Minimum Spacing

Maintain spacing from enclosure walls, wireways, and adjacent equipment. Allow 50 mm (2 in.) of space on all sides, as shown. This spacing provides ventilation and electrical isolation.

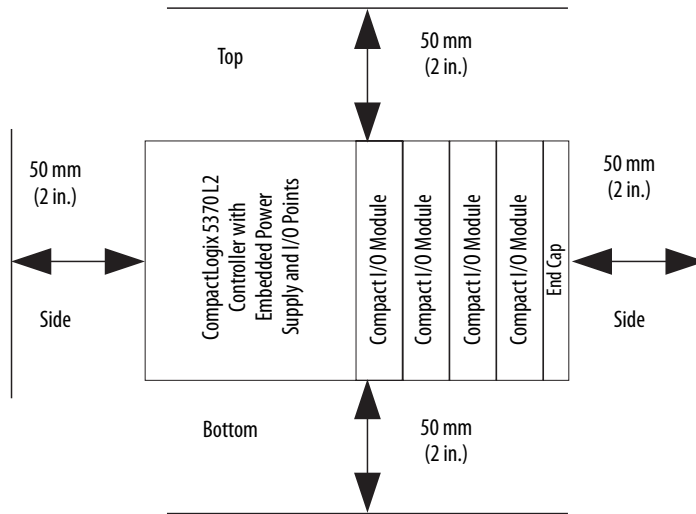

System Dimensions

This graphic shows the system dimensions for the 1769-L24ER-QB1B controller.

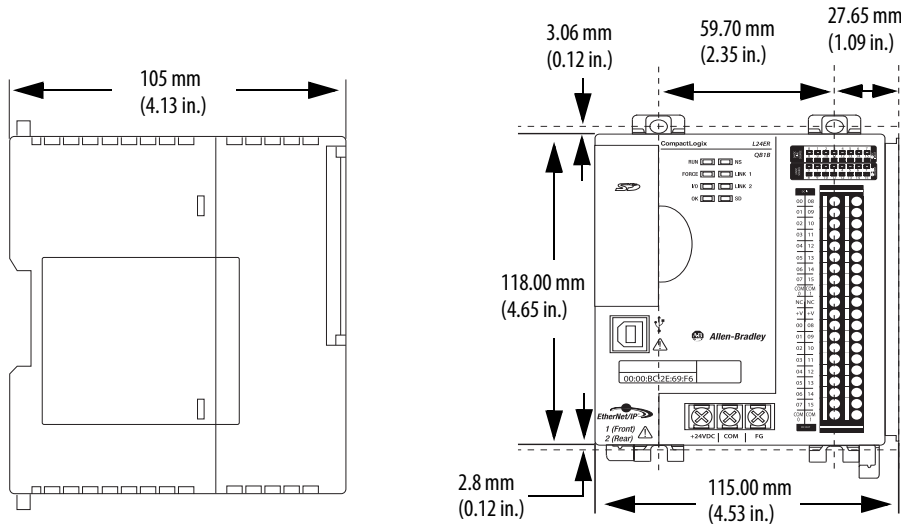

This graphic shows the system dimensions for the 1769-L24ER-QB1B controller with expansion modules installed.

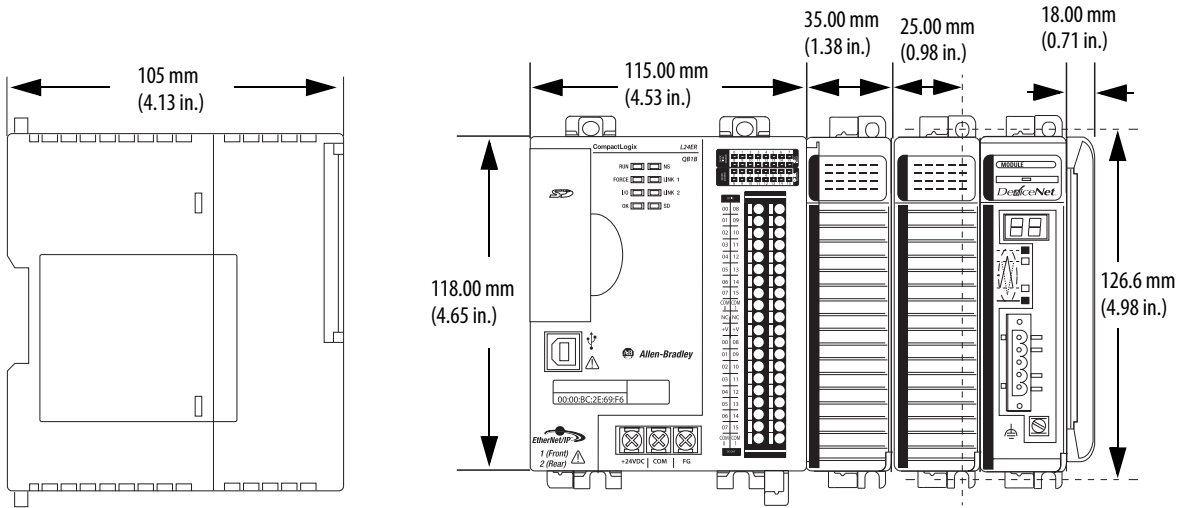

This graphic shows the system dimensions for the 1769-L24ER-QBFC1B controller.

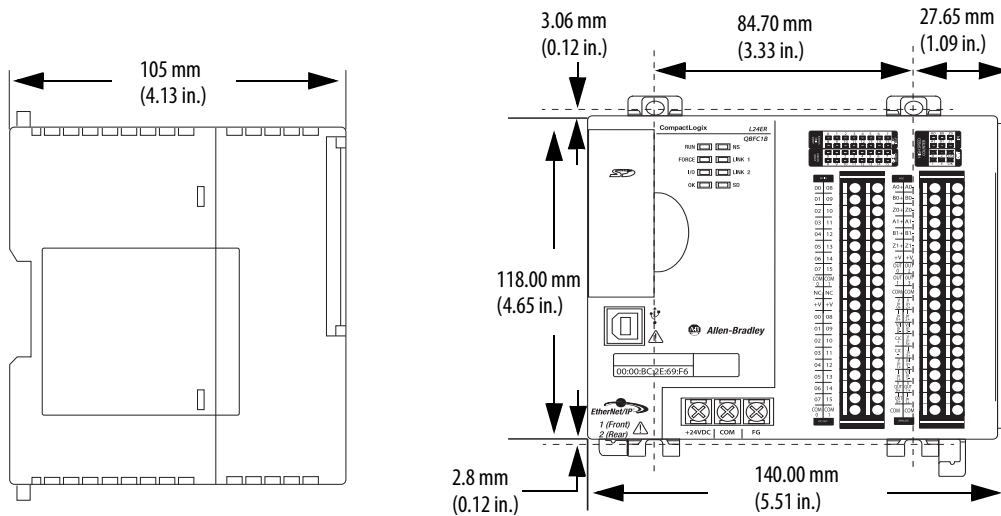

This graphic shows the system dimensions for the 1769-L24ER-QBFC1B controller with expansion modules installed.

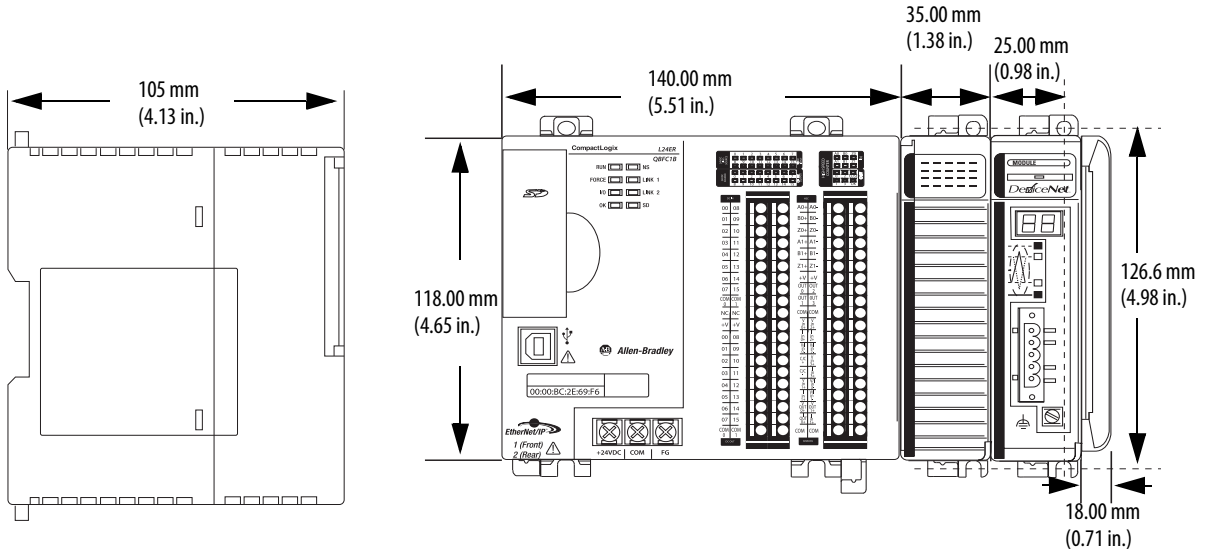

This graphic shows the system dimensions for the 1769-L27ERM-QBFC1B controller.

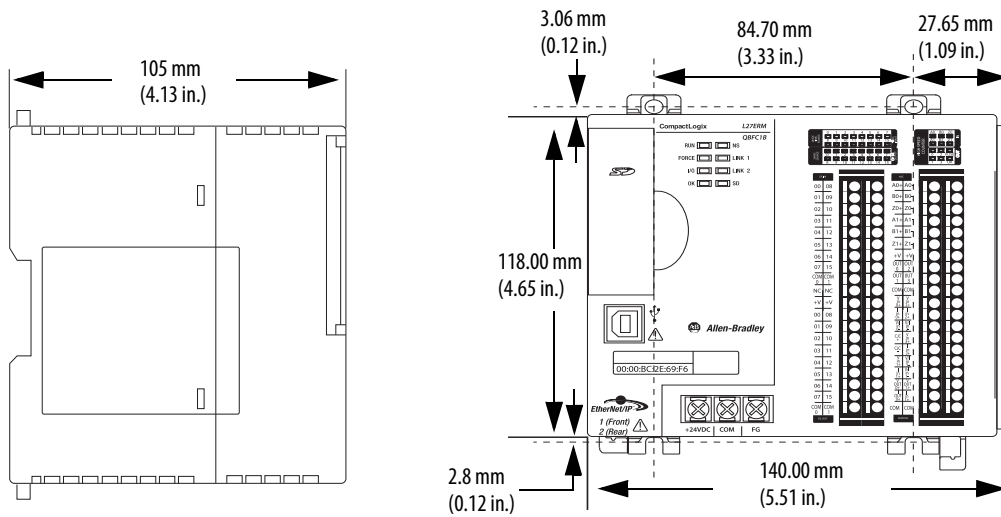

This graphic shows the system dimensions for the 1769-L27ERM-QBFC1B controller with expansion modules installed.

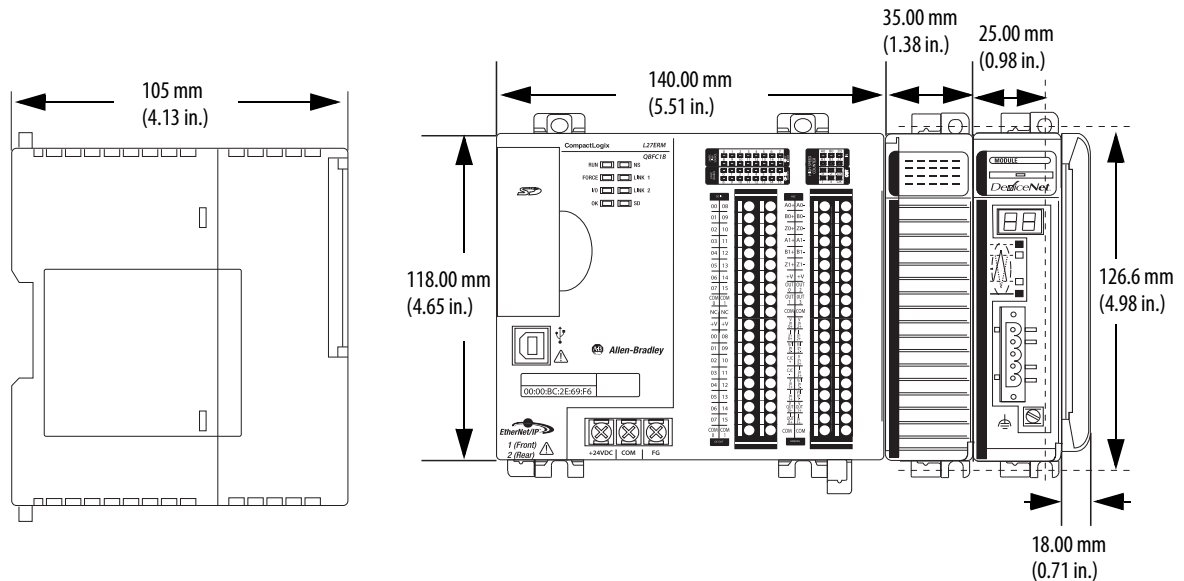

Mount the Controller on a Panel

Use two M4 or #8 pan head screws to mount the controller. Mounting screws are required on every module. Use this procedure to use the assembled modules as a template to drill holes in the panel.

IMPORTANT Due to module mounting hole tolerance, it is important to follow these procedures.

1. On a clean work surface, assemble no more than three modules.
2. Use the assembled modules as a template and carefully mark the center of all module-mounting holes on the panel.
3. Return the assembled modules to the clean work surface, including any previously mounted modules.
4. Drill and tap the mounting holes for the recommended M4 or #8 screw.

5. Place the modules back on the panel and check for proper hole alignment.

TIP The grounding plate, that is, where you install the mounting screws, grounds the module when it is panel-mounted.

6. Use the mounting screws to attach the modules to the panel.

TIP If you are mounting more modules, mount only the last one of this group and put the others aside. This process reduces remounting time when you are drilling and tapping the next group of modules.

7. Repeat steps 1...6 for any remaining modules.

Mount the Controller on the DIN Rail

You can mount the controller on the following DIN rails:

- EN 50 022 - 35 x 7.5 mm (1.38 x 0.30 in.)
- EN 50 022 - 35 x 15 mm (1.38 x 0.59 in.)



ATTENTION: This product is grounded through the DIN rail to chassis ground. Use zinc-plated yellow-chromate steel DIN rail to assure proper grounding. The use of other DIN rail materials (for example, aluminum or plastic) that can corrode, oxidize, or are poor conductors, can result in improper or intermittent grounding. Secure DIN rail to mounting surface approximately every 200 mm (7.8 in.) and use end-anchors appropriately.

1. Hook the DIN rail latch at the top of the back of the controller on the DIN rail.
2. Swing the controller downward until it touches the DIN rail and press the controller against the DIN rail until it clicks in place.

Ground the System



ATTENTION: This product is intended to be mounted to a well-grounded mounting surface such as a metal panel. Additional grounding connections from the power supply's mounting tabs or DIN rail (if used) are not required unless the mounting surface cannot be grounded.

See Industrial Automation Wiring and Grounding Guidelines, Rockwell Automation® publication [1770-4.1](#), for additional information.

Install the Controller

Complete these steps to install the controller.

1. Pull out the bottom locking tabs.

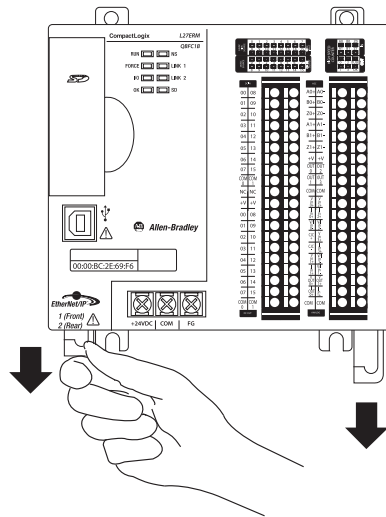

2. Hook the top of the controller on the DIN rail.
3. Swing it downward until the controller is flush against the DIN rail and push it down against the DIN rail.
4. Push the controller against the DIN rail.

5. Push the locking tabs in.

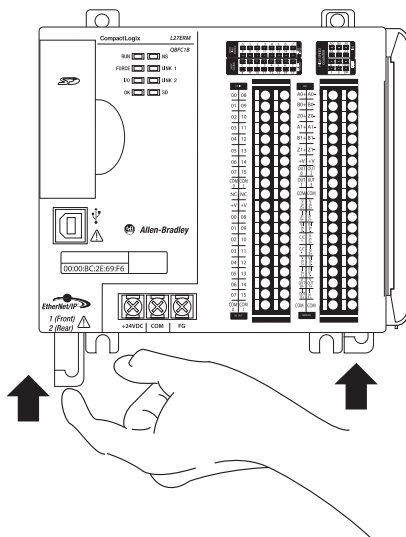

6. If you are not using local expansion modules, slide the 1769-ECR end cap onto the right side of the controller.

IMPORTANT You must install an end cap onto the right side of the CompactLogix 5370 L2 controller system either at the end of the controller. You must also install an end cap at the end of any local expansion modules that can be installed onto the controller.

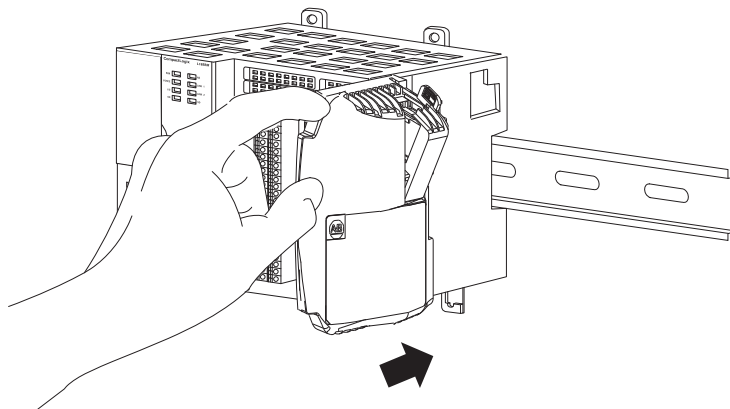

7. Push the end cap locking mechanism to the right to lock it onto the controller.

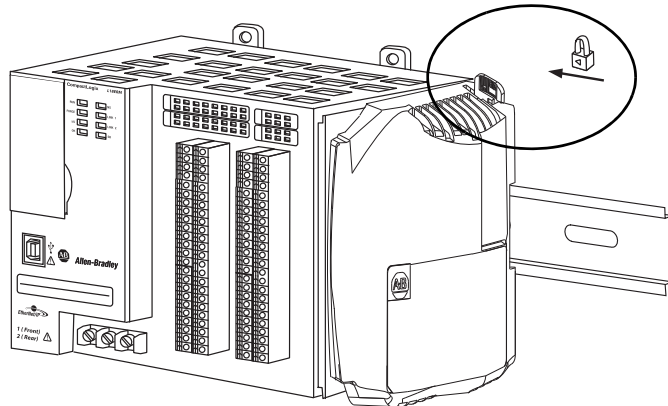

If you are using local expansion modules, see [Local Expansion Modules - Optional on page 213](#) for more information on how to install them in a CompactLogix 5370 L2 control system.

Remove and Replace the Removable Terminal Block

To remove the RTB, loosen the upper and lower retaining screws. The terminal block backs away from the module as you remove the screws. When replacing the terminal block, torque the retaining screws to 0.46 N·m (4.1 lb•in).

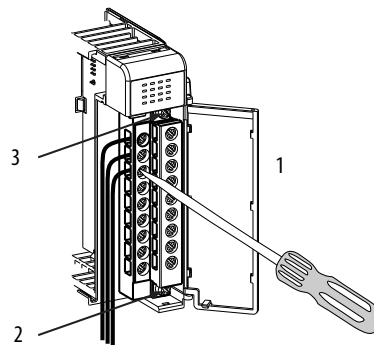

Item	Description
1	Wiring the finger-safe cover
2	Lower retaining screws
3	Upper retaining screws

Wire the Terminal Block

When wiring the terminal block, keep the finger-safe cover in place.

1. Loosen the retaining screws to be wired.
2. Route the wire under the terminal pressure plate.

You can use the bare wire or a spade lug. The terminals accept a 6.35 mm (0.25 in.) spade lug.

TIP The retaining screws are non-captive. You can use a ring lug [maximum 6.35 mm (0.25 in.) o.d. with a 3.53 mm (0.139 in.) minimum i.d. (M3.5)] with the module.

3. Tighten the retaining screw and make sure that the pressure plate secures the wire.

Recommended torque when you tighten the retaining screws is 0.68 N•m (6 lb•in).

TIP If you must remove the fingersafe cover, insert a screwdriver into one of the square wiring holes and gently pry the cover off. If you wire the terminal block with the fingersafe cover removed, you cannot put it back on the terminal block because of wires in the way.

Wire Size and Terminal Screw Torque

Each terminal accepts one or two wires with the following restrictions.

Wire Type		Wire Size	Terminal Screw Torque	Retaining Screw Torque
Solid	Cu-90 °C (194 °F)	#14...#22 AWG	0.68 N•m (6 lb•in)	0.46 N•m (4.1 lb•in)
Stranded	Cu-90 °C (194 °F)	#16...#22 AWG	0.68 N•m (6 lb•in)	0.46 N•m (4.1 lb•in)

Connect Power to the Control System

You must connect an external Class 2 or SELV-listed power supply to the embedded power supply of the controller. The external power supply converts 115/230V AC power to 24V DC power.



WARNING: Do not connect directly to line voltage. Line voltage must be supplied by a suitable, approved isolating transformer or power supply having short circuit capacity not exceeding 100VA maximum or equivalent.

Consider these points before completing the steps in this section:

- This section describes how to connect power only to the embedded power supply of the CompactLogix 5370 L2 controller.

For information on how to wire the embedded I/O module available on CompactLogix 5370 L2 controllers, see [Embedded I/O Modules on page 182](#).

- Not all Class 2 or SELV-listed power supplies are certified for use in all applications, for example, use in nonhazardous and hazardous environments.

Before installing an external power supply, consult all specification and certification information to verify that you are using an acceptable external power supply.

- This section describes how to wire terminals +24VDC and COM on the CompactLogix 5370 L2 controller. They are the only terminals you wire to power the CompactLogix 5370 L2 control system.

Use only the FG terminal when connecting a field device to the controller.

For example purposes, this section uses a 1606-XLDNET4, standard switched-mode power supply.

IMPORTANT The 1606-XLDNET4 power supply is not certified for use in all applications, for example, you cannot use it in hazardous locations. Read the points in [Connect Power to the Control System on page 62](#) before choosing the external power supply for your application.

Complete these steps to connect power to the CompactLogix 5370 L2 control system.

1. Verify that the external 24V DC power source is not powered.
2. Mount the external 24V DC power source on a DIN rail.

The external 24V DC power source can be installed on the same DIN rail as the controller or a separate DIN rail.

3. Connect wires to the 24V DC+ and 24V DC- connections on the external 24V DC power source.



WARNING: If you connect or disconnect wiring while the field-side power is on, an electrical arc can occur. This could cause an explosion in hazardous location installations. Be sure that power is removed or the area is nonhazardous before proceeding.

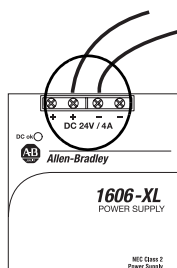

4. Strip 8 mm (0.31 in.) insulation from the end of the wire that you connect to the +24VDC terminal on the controller.
5. Connect the wire from the 24VDC+ terminal on the external 24V DC power source to the +24VDC terminal on the controller.

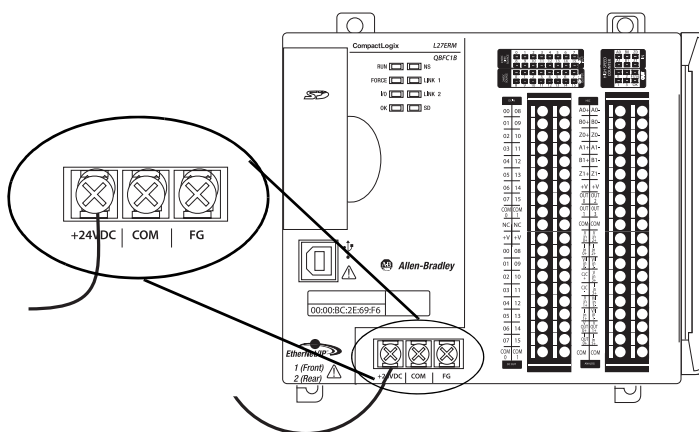

6. Strip 8 mm (0.31 in.) insulation from the end of the wire that you connect to the COM terminal on the controller.
7. Connect the wire from the 24V DC- terminal on the external 24V DC power source to the COM terminal on the controller.

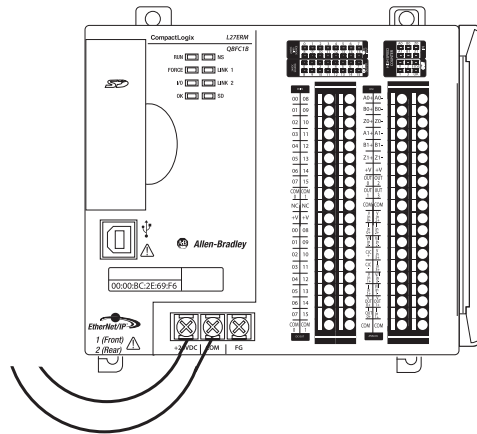

IMPORTANT If your application requires a power control device, for example, a switch or relay, between the external power supply and the embedded power supply of the CompactLogix 5370 L2 controller to control when the controller is powered, you must install the power control device at the +24VDC terminal on the controller.

If you install the power control device at the COM terminal, the CompactLogix 5370 L2 controller cannot power up or power down properly.

The following graphic shows an external 24V DC power source that is connected to a CompactLogix 5370 L2 controller.

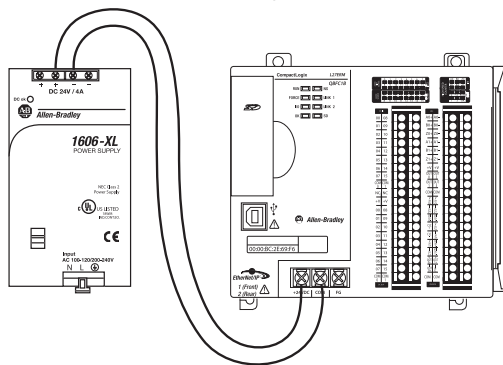

IMPORTANT When you remove power from the CompactLogix 5370 L2 controller to cycle power, the OK status indicator of the controller remains lit briefly as the controller passes through its shutdown sequence.

Do not reapply power from the external power supply to the embedded power supply of the CompactLogix 5370 L2 controller until after the OK status indicator of the controller is off.

Connect to the Controller Via a USB Cable

The controller has a USB port that uses a Type B receptacle. The port is USB 2.0-compatible and operates at 12 Mbps.

Use a USB cable to connect your computer to the USB port. With this connection, you can update firmware and download programs to the controller directly from your computer.



ATTENTION: The USB port is intended only for temporary local programming purposes and not intended for permanent connection. The USB cable is not to exceed 3.0 m (9.84 ft) and must not contain hubs.



WARNING: Do not use the USB port in hazardous locations.

Plug the USB cable into the CompactLogix 5370 L2 controller.

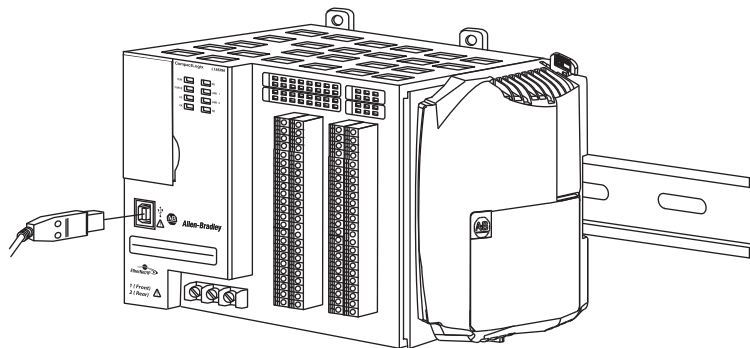

Connect the Controller to an EtherNet/IP Network



WARNING: If you connect or disconnect the communication cable with power applied to this module or any device on the network, an electrical arc can occur. This could cause an explosion in hazardous location installations.

Be sure that power is removed or the area is nonhazardous before proceeding.

Connect the RJ45 connector of the Ethernet cable to one of the Ethernet ports on the controller. The ports are on the bottom of the controller.



ATTENTION: Do not plug a DH-485 network cable or a NAP cable into the Ethernet port. Undesirable behavior and/or damage to the port can result.

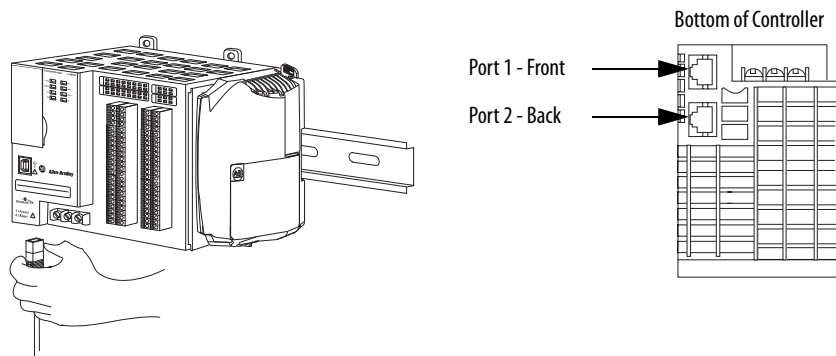

IMPORTANT This example shows how to connect the controller to the network through one port. Depending on the network topology of your application, you can connect both ports of the controller to the EtherNet/IP network.

For more information on EtherNet/IP network topologies, see [page 125](#).

Connecting to Different EtherNet/IP Network Topologies

CompactLogix 5370 L2 controllers have embedded switch technology and two EtherNet/IP ports that let you use it in various EtherNet/IP network topologies:

- Device Level Ring network topology - Both ports on the controller are connected to the network.
- Linear network topology - Both ports on the controller are connected to the network.
- Star network topology - One port on the controller is connected to the network.

There are connection and configuration requirements for each EtherNet/IP network topology.

For more information, see [EtherNet/IP Network Topologies on page 125](#).

Install the CompactLogix 5370 L3 Controller

Topic	Page
Before You Begin	70
Install the Secure Digital Card	72
Install the System	74
Connect to the Controller Via a USB Cable	84
Connect the Controller to an EtherNet/IP Network	85



ATTENTION: Environment and Enclosure

This equipment is intended for use in a Pollution Degree 2 industrial environment, in overvoltage Category II applications (as defined in IEC 60664-1), at altitudes up to 2000 m (6562 ft) without derating.

This equipment is considered Group 1, Class A industrial equipment according to IEC/CISPR 11. Without appropriate precautions, there may be difficulties with electromagnetic compatibility in residential and other environments due to conducted and radiated disturbances.

This equipment is supplied as open-type equipment. It must be mounted within an enclosure that is suitably designed for those specific environmental conditions that will be present and appropriately designed to prevent personal injury resulting from accessibility to live parts. The enclosure must have suitable flame-retardant properties to prevent or minimize the spread of flame, complying with a flame spread rating of 5VA, V2, V1, V0 (or equivalent) if nonmetallic. The interior of the enclosure must be accessible only by the use of a tool. Subsequent sections of this publication may contain additional information regarding specific enclosure type ratings that are required to comply with certain product safety certifications.

In addition to this publication, see the following:

- Industrial Automation Wiring and Grounding Guidelines, publication [1770-4.1](#), for additional installation requirements
 - NEMA 250 and IEC 60529, as applicable, for explanations of the degrees of protection provided by enclosures
-

North American Hazardous Location Approval

<p>The following information applies when operating this equipment in hazardous locations.</p>	<p>Informations sur l'utilisation de cet équipement en environnements dangereux.</p>
<p>Products marked "CL I, DIV 2, GP A, B, C, D" are suitable for use in Class I Division 2 Groups A, B, C, D, Hazardous Locations and nonhazardous locations only. Each product is supplied with markings on the rating nameplate indicating the hazardous location temperature code. When combining products within a system, the most adverse temperature code (lowest "T" number) may be used to help determine the overall temperature code of the system. Combinations of equipment in your system are subject to investigation by the local Authority Having Jurisdiction at the time of installation.</p>	<p>Les produits marqués "CL I, DIV 2, GP A, B, C, D" ne conviennent qu'à une utilisation en environnements de Classe I Division 2 Groupes A, B, C, D dangereux et non dangereux. Chaque produit est livré avec des marquages sur sa plaque d'identification qui indiquent le code de température pour les environnements dangereux. Lorsque plusieurs produits sont combinés dans un système, le code de température le plus défavorable (code de température le plus faible) peut être utilisé pour déterminer le code de température global du système. Les combinaisons d'équipements dans le système sont sujettes à inspection par les autorités locales qualifiées au moment de l'installation.</p>
<div style="display: flex; align-items: center;">  <div> <p>WARNING: EXPLOSION HAZARD -</p> <ul style="list-style-type: none"> • Do not disconnect equipment unless power has been removed or the area is known to be nonhazardous. • Do not disconnect connections to this equipment unless power has been removed or the area is known to be nonhazardous. Secure any external connections that mate to this equipment by using screws, sliding latches, threaded connectors, or other means provided with this product. • Substitution of components may impair suitability for Class I, Division 2. • If this product contains batteries, they must only be changed in an area known to be nonhazardous. </div> </div>	<div style="display: flex; align-items: center;"> <div style="margin-right: 10px;"></div> <div> <p>AVERTISSEMENT: RISQUE D'EXPLOSION –</p> <ul style="list-style-type: none"> • Couper le courant ou s'assurer que l'environnement est classé non dangereux avant de débrancher l'équipement. • Couper le courant ou s'assurer que l'environnement est classé non dangereux avant de débrancher les connecteurs. Fixer tous les connecteurs externes reliés à cet équipement à l'aide de vis, loquets coulissants, connecteurs filetés ou autres moyens fournis avec ce produit. • La substitution de composants peut rendre cet équipement inadapté à une utilisation en environnement de Classe I, Division 2. • S'assurer que l'environnement est classé non dangereux avant de changer les piles. </div> </div>

European Hazardous Location Approval

The following applies when the product bears the Ex Marking.

This equipment is intended for use in potentially explosive atmospheres as defined by European Union Directive 2014/34/EU and has been found to comply with the Essential Health and Safety Requirements relating to the design and construction of Category 3 equipment intended for use in Zone 2 potentially explosive atmospheres, given in Annex II to this Directive.

Compliance with the Essential Health and Safety Requirements has been assured by compliance with EN 60079-15 and EN 60079-0.



ATTENTION: This equipment is not resistant to sunlight or other sources of UV radiation.

WARNING:

- This equipment must be installed in an enclosure providing at least IP54 protection when applied in Zone 2 environments.
 - This equipment shall be used within its specified ratings defined by Rockwell Automation®.
 - Provision shall be made to prevent the rated voltage from being exceeded by transient disturbances of more than 40% when applied in Zone 2 environments.
 - Secure any external connections that mate to this equipment by using screws, sliding latches, threaded connectors, or other means provided with this product.
 - Do not disconnect equipment unless power has been removed or the area is known to be nonhazardous.
 - Enclosure must be marked with the following: "Warning - Do not open when energized." After installation of equipment into the enclosure, access to termination compartments shall be dimensioned so that conductors can be readily connected.
-



ATTENTION: Prevent Electrostatic Discharge

This equipment is sensitive to electrostatic discharge, which can cause internal damage and affect normal operation. Follow these guidelines when you handle this equipment:

- Touch a grounded object to discharge potential static.
 - Wear an approved grounding wriststrap.
 - Do not touch connectors or pins on component boards.
 - Do not touch circuit components inside the equipment.
 - Use a static-safe workstation, if available.
 - Store the equipment in appropriate static-safe packaging when not in use.
-

Before You Begin

Consider the following when planning your CompactLogix™ 5370 L3 control system:

- The controller is the leftmost device in the system.
- Only one controller can be used on a local 1769 CompactBus. The controller supports the local bank and up to two more banks.
- The controller has a power supply distance rating of four. This rating means that the controller must be within four slots of the power supply. You can install as many as three modules between the power supply and the controller, as shown in the following graphic.

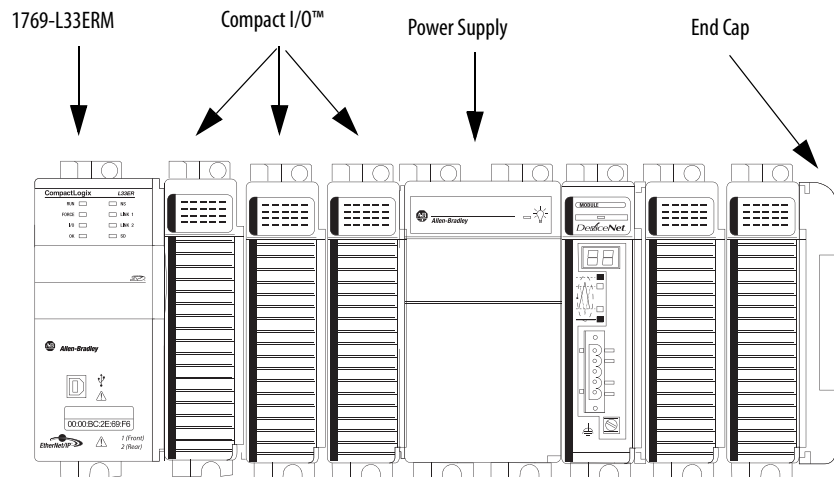

- The controllers support this many local expansion modules across multiple I/O banks.

Table 4 - Supported Local Expansion Modules

Cat. No.	Local Expansion Modules Supported, max
1769-L30ER 1769-L30ERM 1769-L30ERMK 1769-L30ER-NSE	8
1769-L33ER 1769-L33ERM 1769-L33ERMK	16
1769-L33ERMO	—
1769-L36ERM	30
1769-L36ERMO	—
1769-L37ERM, 1769-L37ERMK	31
1769-L37ERMO ⁽¹⁾	—
1769-L38ERM, 1769-L38ERMK	31
1769-L38ERMO ⁽¹⁾	—

(1) Available at software version 31 and firmware revision 31.

- Each I/O bank requires its own power supply.
- You must terminate the end of the last bank in a CompactLogix 5370 L3 control system. You can terminate a bank at the left or right end of the bank dependent upon your system design.

A 1769-ECx end cap is required to terminate the end of the last bank in the control system.

For example, if a CompactLogix 5370 L3 control system uses one bank, you must use a 1769-ECR right end cap to terminate the right end of the bank.

For graphics of CompactLogix 5370 L3 control systems that use one bank or multiple banks, see [Mount the System on page 78](#).



ATTENTION: The CompactLogix 5370 L3 control systems do not support removal and insertion under power (RIUP). These events occur while the CompactLogix system is under power:

- Any break in the connection between the power supply and the controller, for example, removing the power supply, controller, or an I/O module, can subject the logic circuitry to transient conditions above the normal design thresholds and can result in damage to system components or unexpected behavior.
 - Removing an end cap or an I/O module faults the controller and can also result in damage to system components.
-

CompactLogix 5370 L3 Controller Parts

These parts are included in the box when you order your controller:

- Controller - Specific catalog number varies by order
- 1784-SD1 Secure Digital (SD) card with 1 GB of memory storage

A 1784-SD2 SD card with 2 GB of memory storage, or more 1784-SD1 SD cards, are also available if you need more memory.

IMPORTANT The life expectancy of nonvolatile media is dependent on the number of write cycles that are performed. Nonvolatile media use a wear leveling technique or technology for prolonging the service life, but avoid frequent writes.

Avoid frequent writes when logging data. We recommend that you log data to a buffer in the memory of your controller and limit the number of times data is written to removable media.

Installation Summary

To install a CompactLogix 5370 L3 controller, follow these steps.

- [Install the Secure Digital Card](#)
- [Install the System](#)
- [Connect to the Controller Via a USB Cable.](#)
- [Connect the Controller to an EtherNet/IP Network.](#)

Install the Secure Digital Card

The CompactLogix 5370 L3 controllers ship from the factory with the 1784-SD1 SD card installed.

Complete these steps to reinstall an SD card that has been removed from the controller back into the controller or to install a new SD card into the controller.

IMPORTANT For more information on how to access the SD card in a 1769-L33ERMO, 1769-L36ERMO, 1769-L37ERMO⁽¹⁾ or 1769-L38ERMO⁽¹⁾ controller, see the Armor™ CompactLogix Controllers Installation Instructions, publication [1769-IN021](#).

(1) Available at software version 31 and firmware revision 31.

We recommend that you leave the SD card in the controller, even when it is not used. If the controller experiences a Major Non-recoverable Fault, extended fault information is saved to the card.



WARNING: When you insert or remove the Secure Digital (SD) Card while power is on, an electrical arc can occur. This could cause an explosion in hazardous location installations.

Be sure that power is removed or the area is nonhazardous before proceeding.

1. Verify that the SD card is locked or unlocked according to your preference. Consider the following when deciding to lock the card before installation:
 - If the card is unlocked, the controller can write data to it or read data from it.

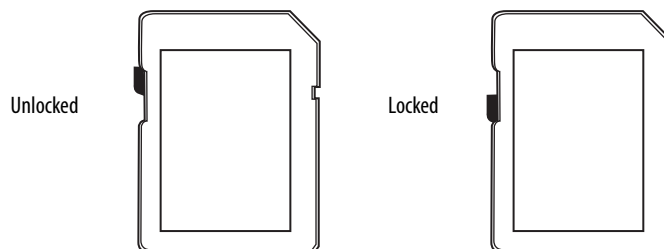

2. Open the door for the SD card.

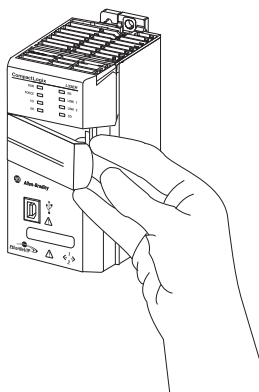

3. Insert the SD card into the SD card slot.

You can install the SD card in only one orientation. The beveled corner is at the top. An orientation logo is printed on the card.

If you feel resistance when inserting the SD card, pull it out and change the orientation.

4. Gently press the card until it clicks into place.

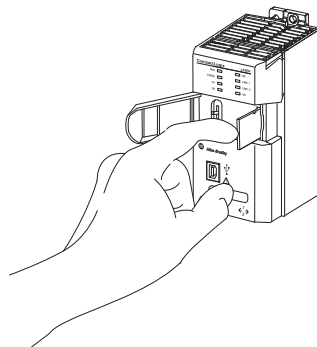

5. Close the SD card door.

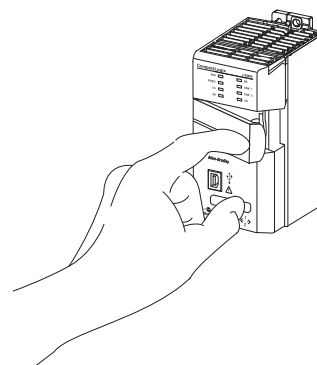

We recommend that you keep the SD card door closed during normal system operation. For more information on how to use the SD card, see [Use a Secure Digital Card on page 297](#).

Install the System

Complete the following steps to install the CompactLogix 5370 L3 control system.

- [Assemble the System](#)
- [Mount the System](#)
- [Ground the System](#)
- [Connect Power to the Control System](#)

Assemble the System

IMPORTANT For more information on how to install a 1769-L33ERMO, 1769-L36ERMO, 1769-L37ERMO⁽¹⁾, or 1769-L38ERMO⁽¹⁾ controller, see the Armor CompactLogix Controllers Installation Instructions, publication [1769-IN021](#).

(1) Available at software version 31 and firmware revision 31.

You can attach an adjacent Compact I/O module or 1769 Compact I/O power supply to a CompactLogix 5370 L3 controller before or after mounting. For mounting instructions, see [Ground the System on page 81](#) or [Mount the Controller on a Panel on page 82](#).



ATTENTION: Do not remove or replace this module while power is applied. Interruption of the backplane can result in unintentional operation or machine motion.



WARNING: Remove power before removing or inserting this module. If you insert or remove the module while backplane power is on, an electrical arc can occur. This could cause an explosion in hazardous location installations. Be sure that power is removed or the area is nonhazardous before proceeding.

Complete these steps to install the controller. This example describes how to attach a 1769 Compact I/O power supply to the controller.

1. Verify that line power is disconnected.
2. Make sure that the bus lever of the 1769 Compact I/O power supply is in the unlocked position. The bus lever leans to the right in the locked position.

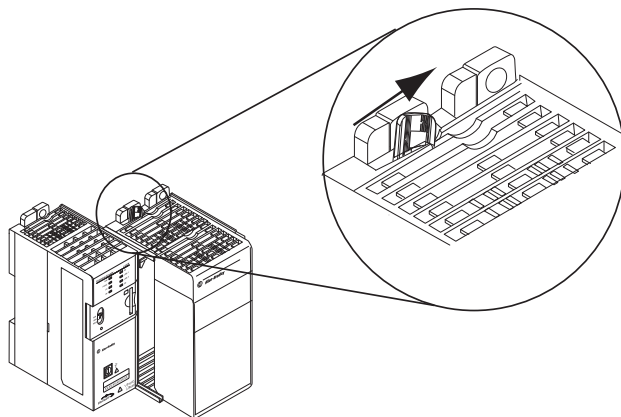

3. Use the upper and lower tongue-and-groove slots to secure the controller and power supply together.

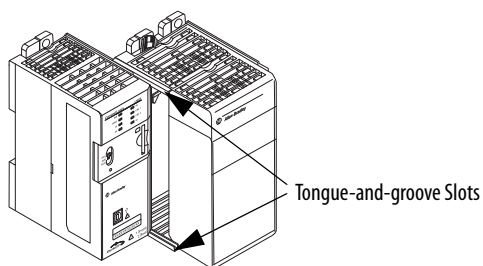

4. Move the power supply back along the tongue-and-groove slots until the bus connectors align with each other.

5. Use your fingers or a small screwdriver to push the bus lever of the power supply back slightly to clear the positioning tab.
6. Move the bus lever of the power supply fully to the left until it clicks, which makes sure that it locks.

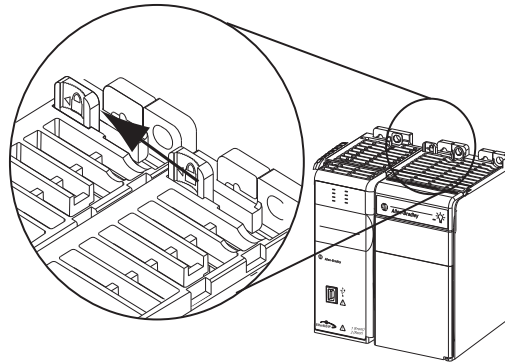

7. If your system does not use any local expansion modules, use the tongue-and-groove slots described earlier to attach a 1769-ECR Compact I/O end cap terminator to the last module in the system.

IMPORTANT You must install an end cap onto the right side of the CompactLogix 5370 L3 controller system either at the end of the controller. You must also install an end cap at the end of any local expansion modules that can be installed onto the controller.

8. Wire the 1769 Compact I/O power supply according to the directions in the Compact I/O Expansion Power Supplies installation instructions, publication [1769-IN028](#).

If you are using local expansion modules, see [Local Expansion Modules on page 236](#).

Remove and Replace the Removable Terminal Block

To remove the terminal block, loosen the upper and lower retaining screws. The terminal block backs away from the module as you remove the screws. When replacing the terminal block, torque the retaining screws to 0.46 N•m (4.1 lb•in).

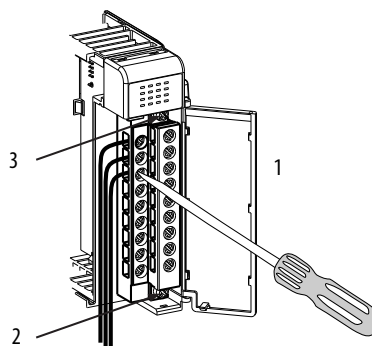

Item	Description
1	Wiring the fingersafe terminal block
2	Lower retaining screws
3	Upper retaining screws

Wire the Terminal Block

When wiring the terminal block, keep the fingersafe cover in place.

1. Loosen the terminal screws to be wired.
2. Route the wire under the terminal pressure plate.

You can use the bare wire or a spade lug. The terminals accept a 6.35 mm (0.25 in.) spade lug.

TIP The terminal screws are non-captive. You can use a ring lug [maximum 6.35 mm (0.25 in.) o.d. with a 3.53 mm (0.139 in.) minimum i.d. (M3.5)] with the module.

3. Tighten the terminal screw and make sure that the pressure plate secures the wire.

Recommended torque when you tighten the terminal screws is 0.68 N•m (6 lb•in).

TIP If you must remove the fingersafe cover, insert a screwdriver into one of the square wiring holes and gently pry the cover off. If you wire the terminal block with the fingersafe cover removed, you cannot put it back on the terminal block because of wires in the way.

Wire Size and Terminal Screw Torque

Each terminal accepts one or two wires with the following restrictions.

Wire Type		Wire Size	Terminal Screw Torque	Retaining Screw Torque
Solid	Cu-90 °C (194 °F)	#14...#22 AWG	0.68 N·m (6 lb·in)	0.46 N·m (4.1 lb·in)
Stranded	Cu-90 °C (194 °F)	#16...#22 AWG	0.68 N·m (6 lb·in)	0.46 N·m (4.1 lb·in)

Mount the System

You can mount a CompactLogix 5370 L3 control system on a DIN rail or on a panel.



ATTENTION: During panel or DIN rail mounting of all devices, be sure that all debris (such as metal chips or wire strands) is kept from falling into the controller. Debris that falls into the controller could cause damage while the controller is energized.

A CompactLogix 5370 L3 control system must be mounted so that the modules are horizontal to each other. If you separate modules into multiple banks, the banks can be vertical or horizontal to each other.

Figure 6 shows example systems with local expansion modules included.

Figure 6 - Example CompactLogix 5370 L3 Control Systems

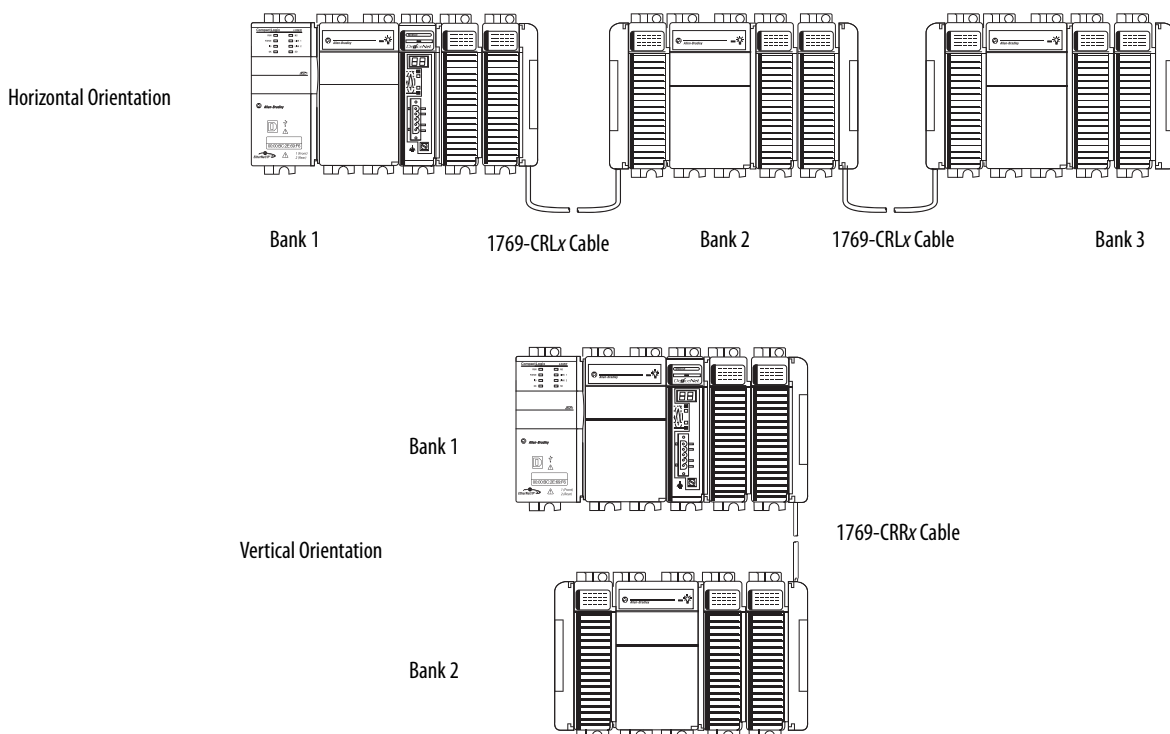

Before you mount a CompactLogix 5370 L3 control system, consider the following:

- [Minimum Spacing](#)
- [System Dimensions](#)
- [Power Supply Distance Rating](#)

Minimum Spacing

Maintain spacing from enclosure walls, wireways, and adjacent equipment. Allow 50 mm (2 in.) of space on all sides, as shown. This spacing provides ventilation and electrical isolation.

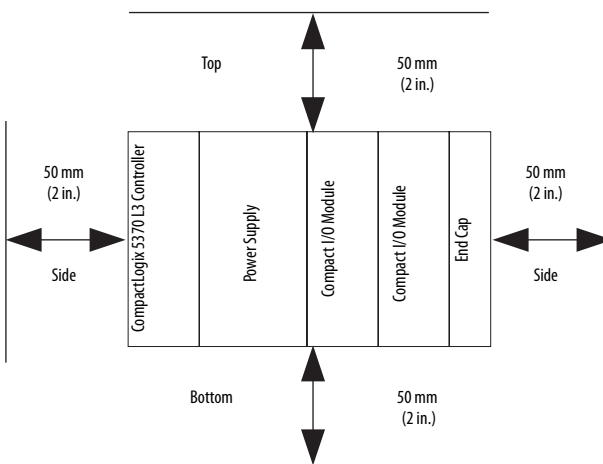

System Dimensions

This graphic shows the system dimensions.

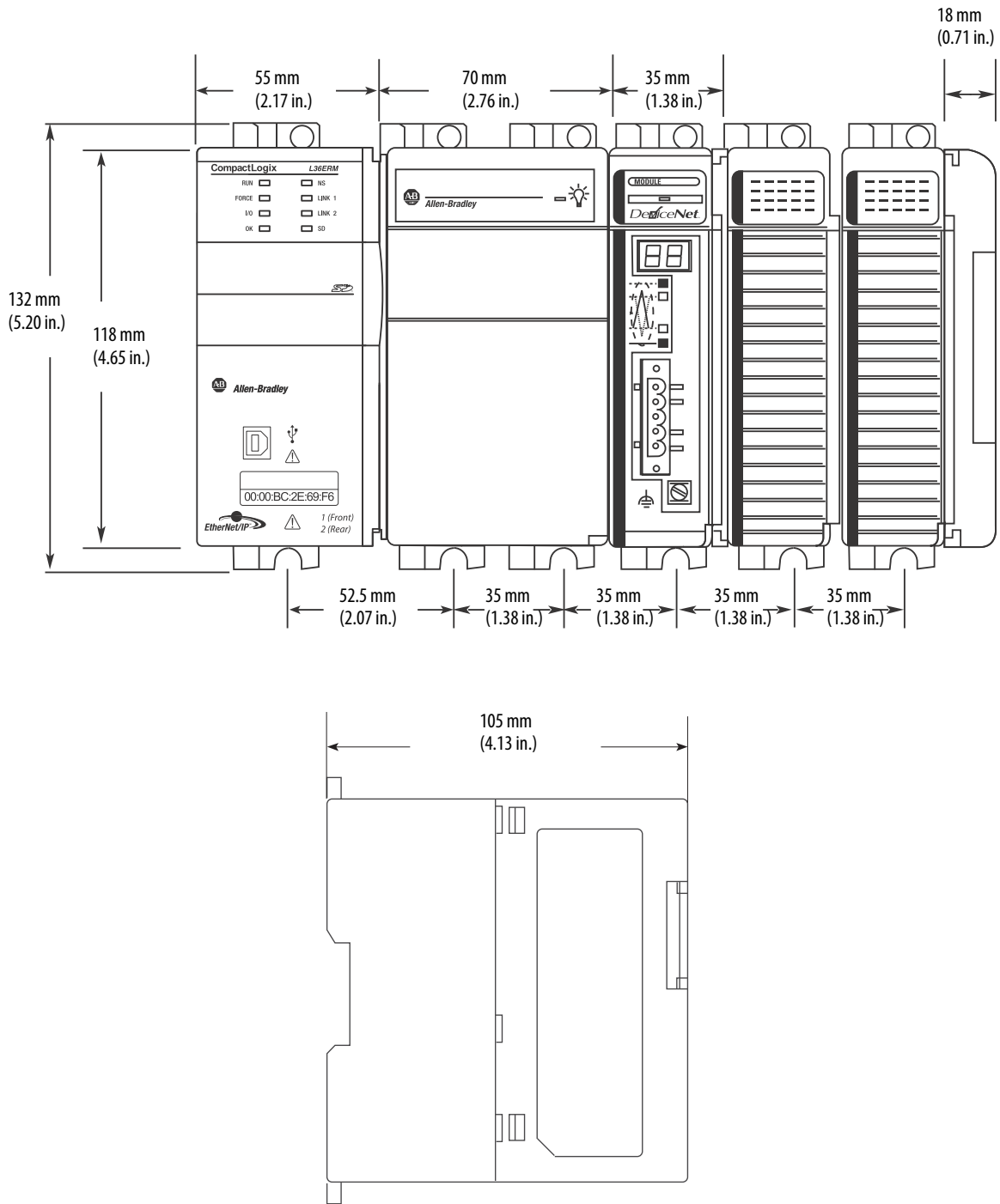

Power Supply Distance Rating

CompactLogix 5370 L3 controllers and the Compact I/O modules have power supply distance ratings. Power supply distance ratings determine how many slots in a bank that a device can be from the power supply.

For example, a product with a power supply distance rating of four can only have up to three slots between it and the power supply.

Device	Power Supply Distance Rating
CompactLogix 5370 L3 controller 1769 Compact I/O DeviceNet scanner	4
Compact I/O module	4...8, depending on module For more information about the power supply distance rating for a Compact I/O module, see CompactLogix Selection Guide, publication 1769-SG001

CompactLogix 5370 L3 controllers must be the leftmost device in the control system, and the system only enables up to three modules between the controller and the power supply. This graphic shows an example configuration.

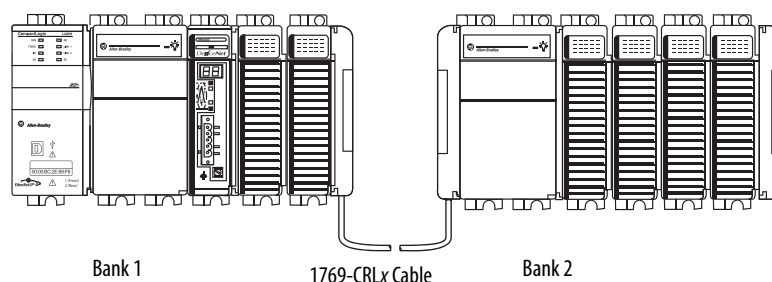

Ground the System



ATTENTION: This product is intended to be mounted to a well-grounded mounting surface such as a metal panel. Additional grounding connections from the power supply's mounting tabs or DIN rail (if used) are not required unless the mounting surface cannot be grounded.

See Industrial Automation Wiring and Grounding Guidelines, Rockwell Automation publication [1770-4.1](#), for additional information.

For more information, see the Industrial Automation Wiring and Grounding Guidelines, publication [1770-4.1](#).

Mount the Controller on a Panel

Use two M4 or #8 pan head screws to mount the controller. Mounting screws are required on many modules. Use this procedure to use the assembled modules as a template to drill holes in the panel.

IMPORTANT Due to module mounting hole tolerance, it is important to follow these procedures.

1. On a clean work surface, assemble no more than three modules.
2. Use the assembled modules as a template and carefully mark the center of all module-mounting holes on the panel.
3. Return the assembled modules to the clean work surface, including any previously mounted modules.
4. Drill and tap the mounting holes for the recommended M4 or #8 screw.
5. Place the modules back on the panel and check for proper hole alignment.

TIP The grounding plate, that is, where you install the mounting screws, grounds the module when it is panel-mounted.

6. Use the mounting screws to attach the modules to the panel.

TIP If you are mounting more modules, mount only the last one of this group and put the others aside. This process reduces remounting time when you are drilling and tapping the next group of modules.

7. Repeat steps 1...6 for any remaining modules.

Mount the Controller on the DIN Rail

You can mount the controller on the following DIN rails:

- EN 50 022 - 35 x 7.5 mm (1.38 x 0.30 in.)
- EN 50 022 - 35 x 15 mm (1.38 x 0.59 in.)



ATTENTION: This product is grounded through the DIN rail to chassis ground. Use zinc-plated yellow-chromate steel DIN rail to assure proper grounding. The use of other DIN rail materials (for example, aluminum or plastic) that can corrode, oxidize, or are poor conductors, can result in improper or intermittent grounding. Secure DIN rail to mounting surface approximately every 200 mm (7.8 in.) and use end-anchors appropriately.

1. Before mounting the controller on a DIN rail, close the DIN rail latches of the controller.
2. Press the DIN rail mounting area of the controller against the DIN rail.

The latches momentarily open and lock into place.

Connect Power to the Control System

Connect power to the CompactLogix 5370 L3 control system that is based on the 1769 Compact I/O power supply your application uses. For more information on how to connect power to your CompactLogix 5370 L3 control system, see the Compact I/O Expansion Power Supplies Installation Instructions, publication [1769-IN028](#).

Connect to the Controller Via a USB Cable

The controller has a USB port that uses a Type B receptacle. The port is USB 2.0-compatible and operates at 12 Mbps.

Use a USB cable to connect your computer to the USB port. With this connection, you can update firmware and download programs to the controller directly from your computer.



ATTENTION: The USB port is intended only for temporary local programming purposes and not intended for permanent connection. The USB cable is not to exceed 3.0 m (9.84 ft) and must not contain hubs.



WARNING: Do not use the USB port in hazardous locations.

IMPORTANT For more information on how to connect a USB cable to a 1769-L33ERMO, 1769-L36ERMO, 1769-L37ERMO⁽¹⁾, 1769-L38ERMO⁽¹⁾ controller, see the Armor CompactLogix Controllers Installation Instructions, publication [1769-IN021](#).

(1) Available at software version 31 and firmware revision 31.

Plug the USB cable into the CompactLogix 5370 L3 controller as shown.

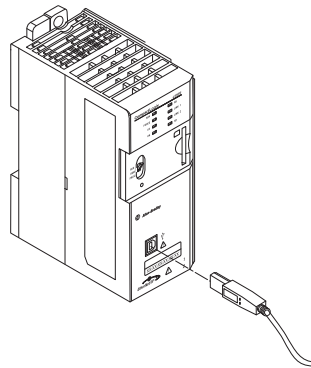

Connect the Controller to an EtherNet/IP Network



WARNING: If you connect or disconnect the communication cable with power applied to this module or any device on the network, an electrical arc can occur. This could cause an explosion in hazardous location installations.

Be sure that power is removed or the area is nonhazardous before proceeding.

Connect the RJ45 connector of the Ethernet cable to one of the Ethernet ports on the controller. The ports are on the bottom of the controller.



ATTENTION: Do not plug a DH-485 network cable or a NAP cable into the Ethernet port. Undesirable behavior or damage to the port can result.

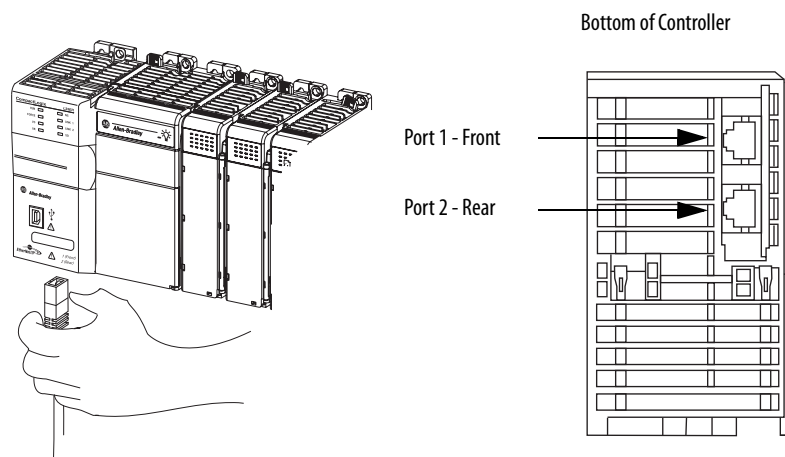

IMPORTANT This example shows how to connect the controller to the network through one port. Depending on the Ethernet network topology of your application, you can connect both ports of the controller to the EtherNet/IP network. For more information on EtherNet/IP network topologies, see [page 125](#).

Connecting to Different EtherNet/IP Network Topologies

The CompactLogix 5370 L3 controllers have embedded switch technology and two EtherNet/IP ports that let you use it in different EtherNet/IP network topologies:

- Device Level Ring network topology - Both ports on the controller are connected to the network with requirements about how the connections are made.
- Linear network topology - Both ports on the controller are connected to the network with requirements about how the connections are made.
- Star network topology - One port on the controller is connected to the network.

For more information, see [EtherNet/IP Network Topologies on page 125](#).

Complete Software Tasks Required at CompactLogix 5370 Controller Installation

Topic	Page
Set the IP Address of a Controller	89
Change the IP Address of a Controller	105
Load the Controller Firmware	109
Select the Operating Mode of the Controller	118

To complete the tasks that are described in this chapter, you must have the software that is described in the following table installed on your computer.

Software	Required Version
RSLinx® Classic	2.59.00 or later CompactLogix™ 5370 L2 controllers require RSLinx Classic software, version 2.59.01 or later. The 1769-L19ER-BB1B controller requires RSLinx Classic software, version 3.74.00
RSLogix 5000®	20 - For CompactLogix 5370 controllers using firmware revision 20. RSLogix 5000 software does not support the 1769-L19ER-BB1B controller.
Studio 5000® environment	21 or later - For CompactLogix™ 5370 controllers using firmware revision 21 or later. 28 or later - For the 1769-L19ER-BB1B controller.
BOOTP-DHCP server	Most current version is installed with RSLinx Classic software installation
ControlFLASH™	Installed with the installation of one of the following: <ul style="list-style-type: none"> • RSLogix 5000 software, version 20 • Studio 5000 environment, version 21 or later • Studio 5000 environment, version 28 or later for 1769-L19ER-BB1B controllers

CompactLogix 5370 controllers require a network Internet Protocol (IP) address to operate on an EtherNet/IP network.

The IP address uniquely identifies the controller. The IP address is in the form *xxx.xxx.xxx.xxx* where each *xxx* is a number from 000...254 with some exceptions for reserved values. These numbers are **examples** of reserved values you cannot use:

- 000.*xxx.xxx.xxx*
- 127.*xxx.xxx.xxx*
- 224 to 255.*xxx.xxx.xxx*

Some other values are reserved based on an application-by-application basis.

You can complete one of these tasks dependent on system conditions:

- **Set** the IP address for a controller that does not have one assigned.
- **Change** the IP address for a controller that has an IP address that is assigned to it.

IMPORTANT CompactLogix 5370 controllers have two EtherNet/IP ports to connect to an EtherNet/IP network. The ports carry the same network traffic as part of the embedded switch of the controller. However, the controller uses only one IP address.

Set the IP Address of a Controller

You must set the IP address of a CompactLogix 5370 controller when the controller powers up for the first time, that is, when commissioning the controller for the first time. You are not required to set an IP address each time the controller cycles power.

You can use these tools to **set** the IP address of a CompactLogix 5370 controller:

- Bootstrap Protocol (BOOTP) server
- Dynamic Host Configuration Protocol (DHCP) server
- RSLinx Classic software
- Studio 5000 Logix Designer® application
- SD card

IMPORTANT Each tool has connection requirements to set the IP address of the controller via that tool. For example, your computer must be connected to the controller via a USB cable to set the initial IP address of the controller with RSLinx Classic software or the application.

[Figure 7](#) describes how to set the IP address of your CompactLogix 5370 controller on a power cycle during initial installation or after operation has begun.

Figure 7 - Set the IP address on a power cycle during initial installation or after operation has begun

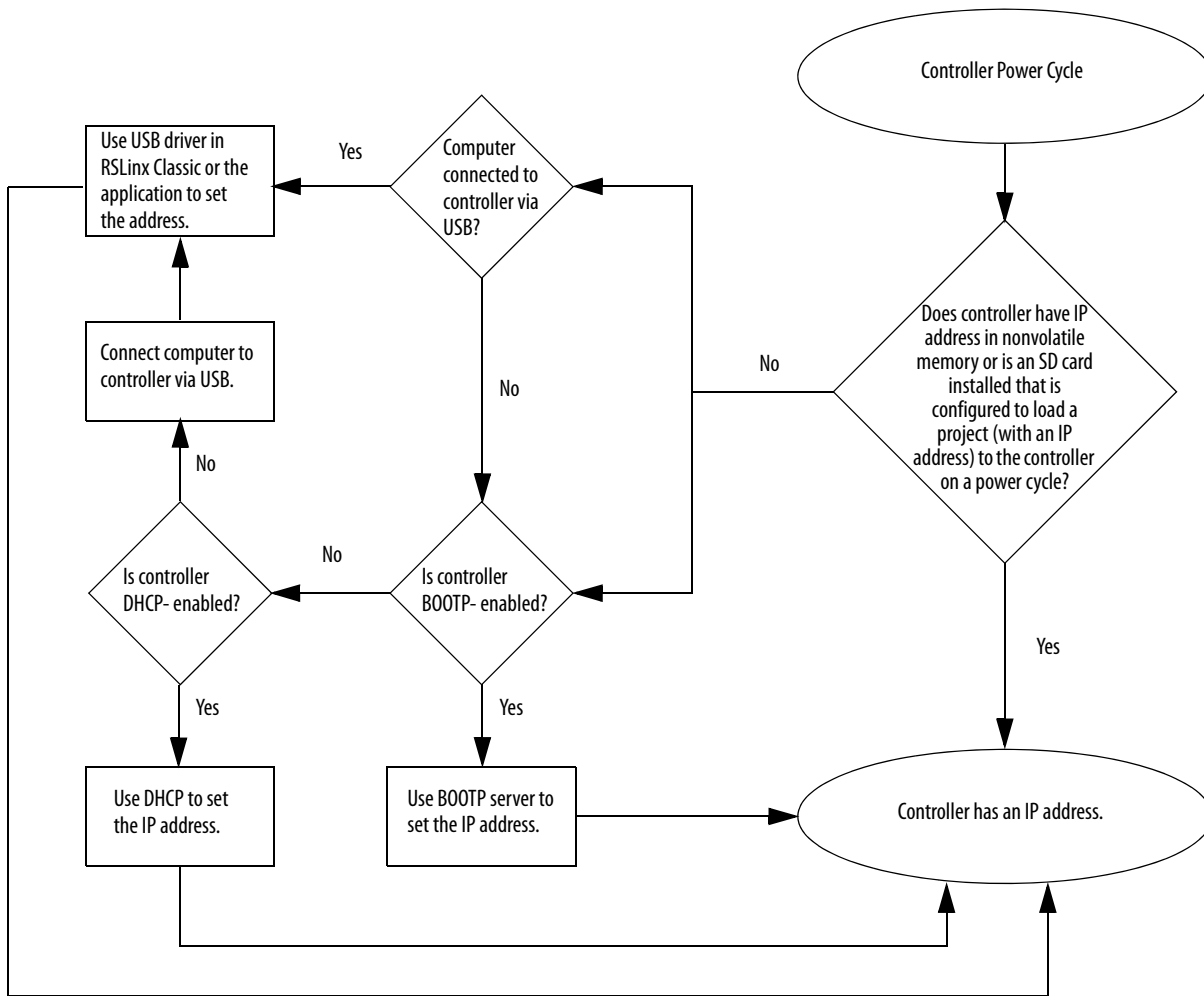

Use the BOOTP Server to Set the IP Address of the Controller

Bootstrap Protocol (BOOTP) is a protocol that enables the controller to communicate with a BOOTP server. The server can be used to assign an IP address. You can use the BOOTP server to set an IP address for your CompactLogix 5370 controller.

Consider these points when using the BOOTP server:

- The BOOTP server is installed automatically when you install RSLinx Classic or the Studio 5000 environment on your computer. The BOOTP server sets an IP address and other Transmission Control Protocol (TCP) parameters.
- A CompactLogix 5370 controller ships from the factory without an IP address and BOOTP-enabled.
- This section describes how to use a Rockwell Automation® BOOTP/DHCP server. If you use another BOOTP/DHCP server, contact your network administrator to verify that you are using it correctly.
- To use the BOOTP server, your computer and the controller must be connected to the same EtherNet/IP network.
- If the controller is BOOTP-disabled, you cannot use the BOOTP server to set the IP address.

There are two conditions in which the CompactLogix 5370 controllers use the BOOTP servers to set the IP address of the controller:

- **Initial powerup** - Because the CompactLogix 5370 controller ships with BOOTP-enabled, when it is first powered up, the controller sends a request for an IP address on the EtherNet/IP network. You can use the BOOTP server to set the IP address, as described later in this section.
- **Powerup after controller operation has begun** - When controller power is cycled after operation has begun, the BOOTP/DHCP server sets the IP address if one of these conditions exists:
 - Controller is BOOTP-enabled - You set the IP address manually with the BOOTP server.
 - Controller is DHCP-enabled - The IP address is set automatically via the DHCP server.

Access the BOOTP/DHCP utility from one of these locations:

- Start>Programs>Rockwell Software®>BOOTP-DHCP Server

If you have not installed the utility, you can download and install it from <http://www.ab.com/networks/ethernet/bootp.html>.

- Tools directory on the programming software installation CD

IMPORTANT Before you start the BOOTP/DHCP utility, make sure that you have the hardware (MAC) address of the controller. The hardware address is on the front of the controller and uses an address in a format similar to the following:

00:00:BC:2E:69:F6

1769-L18ERM-BB1B Controller

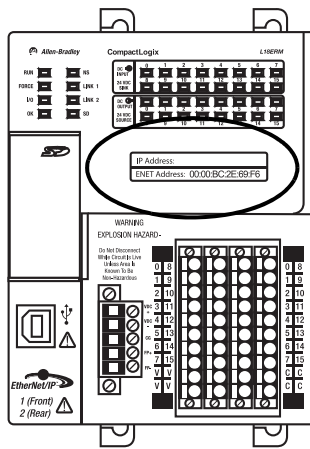

1769-L24ER-QB1B Controller

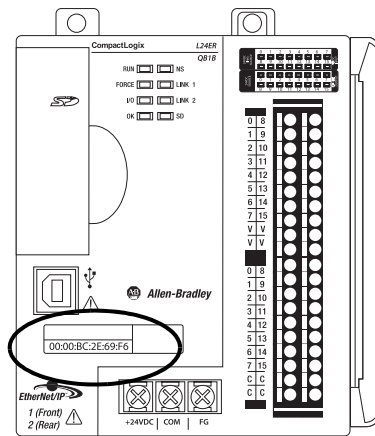

1769-L33ER Controller

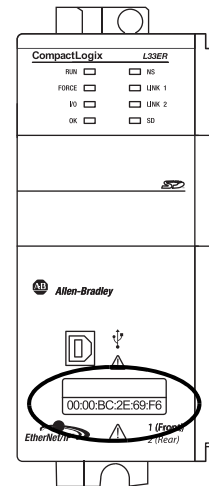

Complete these steps to set the IP address of the controller with the BOOTP/DHCP server.

IMPORTANT To use the BOOTP server, your computer and the controller must be connected to the same EtherNet/IP network.

1. Start the BOOTP/DHCP software.

- From the Tools menu, choose Network Settings.

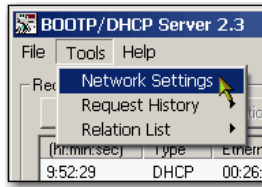

- Type the Subnet Mask of the network.

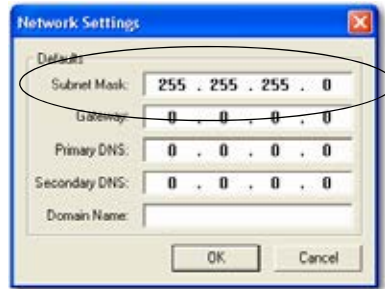

The Gateway address, Primary or Secondary DNS address, and Domain Name fields are optional.

- Click OK.

The Request History panel appears with the hardware addresses of all devices that issue BOOTP requests. This process can take some time to complete.

- Select the appropriate module.

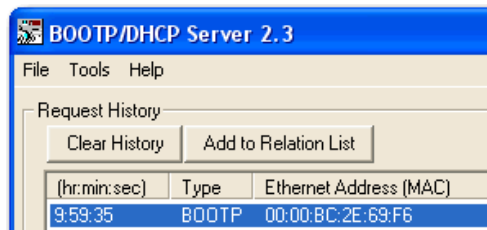

6. Click Add to Relation List.

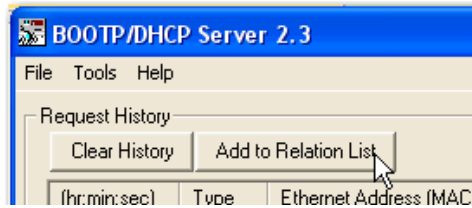

The New Entry dialog box appears.

7. Type an IP Address, Hostname, and Description for the controller.



8. Click OK.
9. To assign this configuration to the controller, wait for the controller to appear in the Relation List panel and select it.
10. Click Disable BOOTP/DHCP.

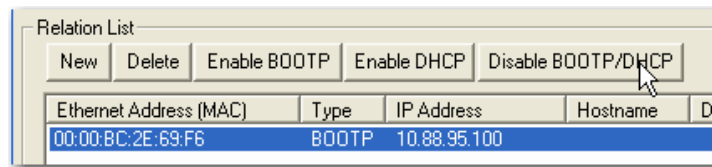

When power is cycled, the controller uses the assigned configuration and does not issue a BOOTP request.

IMPORTANT If you do not click Disable BOOTP/DHCP on a power cycle, the host controller clears the current IP configuration and begins sending BOOTP requests again.

If you click Disable BOOTP/DHCP and it does not disable BOOTP/DHCP, use RSLinx or the Studio 5000 environment to disable BOOTP/DHCP.

To disable BOOTP/DHCP from RSLinx, perform the following:

1. Make sure that a USB cable is connected to your computer and the controller.
2. Start RSLinx Classic software.

After several seconds, an RSWho dialog box appears.

3. If no RSWho dialog box appears, from the Communications pull-down menu, choose RSWho.



4. Navigate to the USB network.
5. Right-click on the controller and choose Module Configuration.



6. Click the Port Configuration tab.
7. From the Network Configuration Type, click Static to disable BOOTP/DHCP.

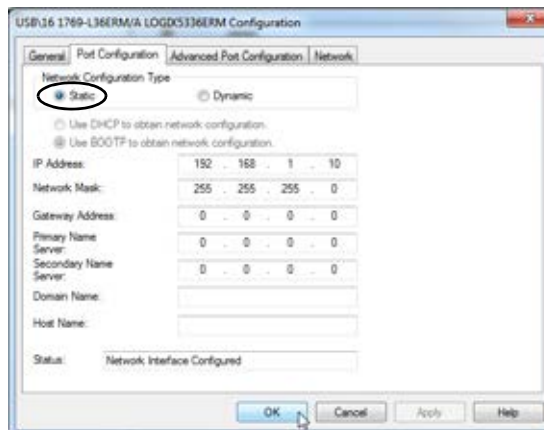

8. Click OK.

To disable BOOTP/DHCP from the Studio 5000 environment, perform the following:

1. Start the application.
2. Open the project.
3. Right-click on the controller and choose Properties.



4. On the Controller Properties dialog box, click the Internet Protocol tab.
5. Click Manually configure IP settings.



6. Click OK.
7. When prompted to confirm the IP address setting, click Yes.

Using DHCP Software

Dynamic Host Configuration Protocol (DHCP) software automatically assigns IP addresses to client stations logging on to a TCP/IP network. DHCP is based on BOOTP and maintains some backward compatibility. The main difference is that BOOTP allows for manual configuration (static), while DHCP allows for both static and dynamic allocation of network addresses and configurations to newly attached modules.

Be cautious when using DHCP software to configure a module. A BOOTP client, such as the EtherNet/IP communication modules, can start from a DHCP server only if the DHCP server is written to handle BOOTP queries. This requirement is specific to the DHCP software package used. Consult your system administrator to see if a DHCP package supports BOOTP commands and manual IP allocation.



ATTENTION: The EtherNet/IP communication module must be assigned a fixed network address. The IP address of this module must not be dynamically provided.

Failure to observe this precaution may result in unintended machine motion or loss of process control.

Use the DHCP Server to Set the IP Address of the Controller

Dynamic Host Configuration Protocol (DHCP) server automatically assigns IP addresses to client stations logging on to a TCP/IP network. DHCP is based on BOOTP and maintains some backward compatibility. The main difference is that BOOTP manual configuration (static), while DHCP enables static and dynamic allocation of network addresses and configurations to newly attached controllers.

Be cautious when using the DHCP server to configure a controller. A BOOTP client, such as the CompactLogix 5370 controllers, can start from a DHCP server only if the DHCP server is written to handle BOOTP queries. This requirement is specific to the DHCP server used. Consult your system administrator to see if a DHCP server supports BOOTP commands and manual IP allocation.



ATTENTION: Assign the CompactLogix 5370 controllers a fixed network address. The IP address of this controller is not to be dynamically provided.

Failure to observe this precaution can result in unintended machine motion or loss of process control.

If you use the Rockwell Automation BOOTP or DHCP server in an uplinked subnet where a DHCP server exists, a controller can procure an address from the enterprise server before the Rockwell Automation utility even sees the controller. Disconnect from the uplink to set the address and configure the controller to retain its static address before reconnecting to the uplink, if necessary.

Use RSLinx Software to Set the IP Address of the Controller

You can use RSLinx software to set the IP address of the CompactLogix 5370 controller.

IMPORTANT To set the IP address, that is, assign an IP address to a controller that does not have one, for a CompactLogix 5370 controller via RSLinx software, you must be connected to your controller via the USB port.

Complete these steps to set the IP address of the controller with RSLinx software.

IMPORTANT These steps show a 1769-L36ERM controller. The same steps also apply to all CompactLogix 5370 controllers with slight variations in screens.

1. Make sure that a USB cable is connected to your computer and the controller.
2. Start RSLinx software.

After several seconds, an RSWho dialog box appears.

3. If no RSWho dialog box appears, from the Communications pull-down menu, choose RSWho.



The RSWho dialog box appears and includes the USB driver.

4. Right-click the EtherNet/IP module and choose Module Configuration.

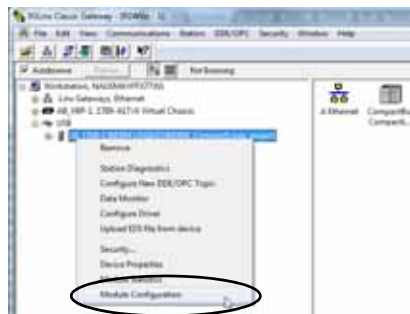

The Module Configuration dialog box appears.

5. Click the Port Configuration tab.

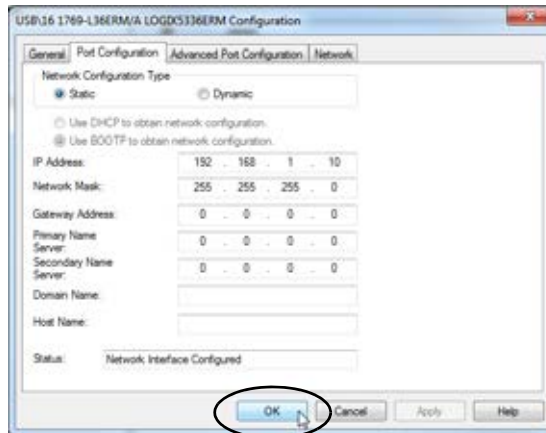

6. For Network Configuration Type, select Static to assign this configuration to the port.

IMPORTANT If you click Dynamic, on a power cycle, the controller clears the current IP configuration and starts to send BOOTP requests.

7. Type the new IP address and Network Mask.
8. Click OK.

As with all configuration changes, if desired, make sure that you are using the SD card in a way that does not overwrite the IP address at the next controller power cycle.

For more information on how to use the SD card, see Chapter 12, [Use a Secure Digital Card on page 297](#).

Use the Logix Designer Application to Set the IP Address of the Controller

You can use Logix Designer application to set the IP address of a CompactLogix 5370 controller. To set the IP address via the application, you must be connected to your controller via the USB port.

Complete these steps to set the IP address of the controller.

IMPORTANT These steps show a 1769-L18ERM-BB1B controller. The same steps also apply to all CompactLogix 5370 controllers with slight variations in screens.

1. Start the application.
2. Set the Project Path.
 - a. Click RSWHo.

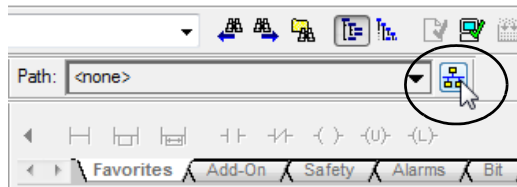

The RSWWho dialog box appears.

- b. Navigate over the USB network and select the CompactLogix 5370 controller.
 - c. Click Set Project Path.

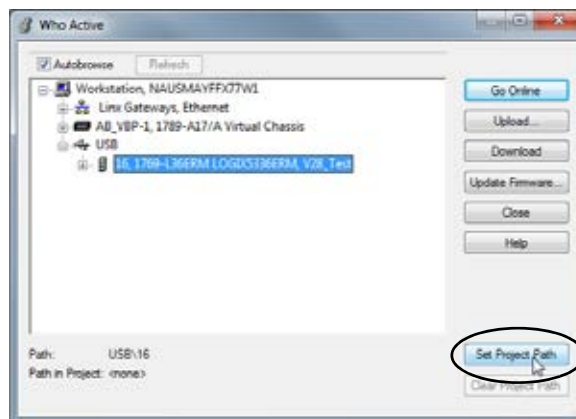

3. Click Download.



4. Click Download again.

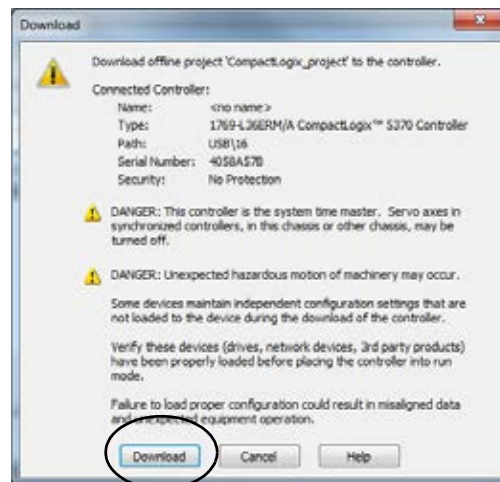

The new project is downloaded to the controller and the project goes online, in Remote Program or Program mode.

5. Right-click the controller name and choose Properties.

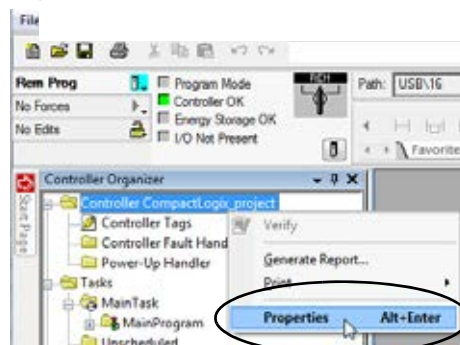

- On the Controller Properties dialog box, click the Internet Protocol tab.

The IP Settings Configuration values show that the controller has no IP address that is assigned to it.

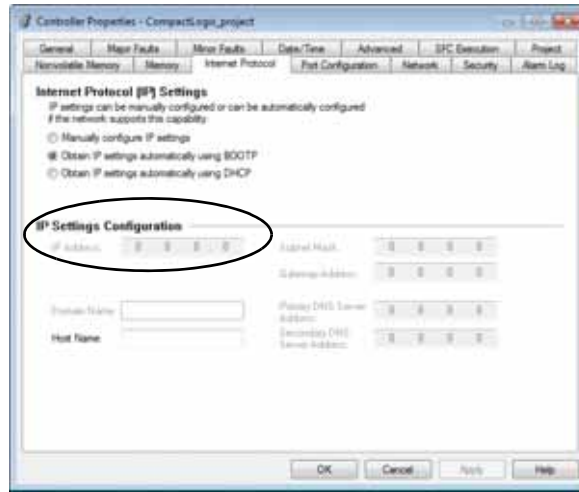

- Click Manually configure IP settings.
- Enter desired IP address and other configuration information and click OK.

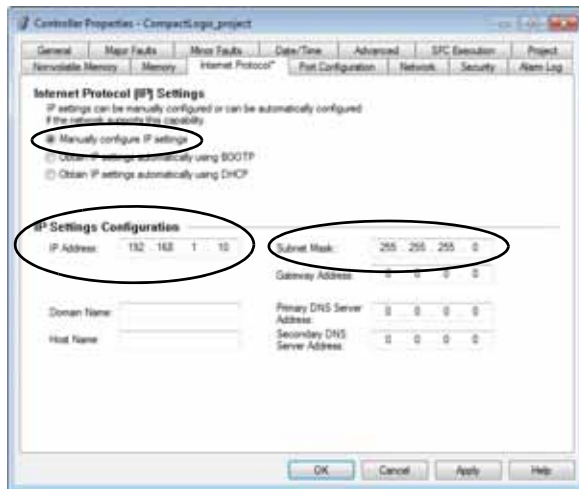

- When prompted to confirm the IP address setting, click Yes.

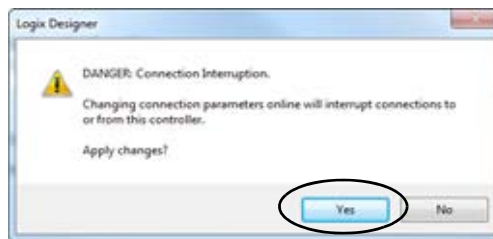

The controller now uses the newly set IP address.

Use the SD Card to Set the IP Address of the Controller

You can use an SD card to set the IP address for a CompactLogix 5370 controller. If you use the SD card to set the IP address, it eliminates the need for software to complete this task.

IMPORTANT To set the IP address from an SD card, software is not required during the power-up process. However, you must have previously saved the project to the SD card.

The IP address of the CompactLogix 5370 controller is automatically configured at power-up as long as you have configured an IP address, stored the program onto a controller, and set the SD card to the Load Image parameter set to On Power Up.

The option to set the IP address of a CompactLogix 5370 controller via an SD card at power-up is only one part of the process to load an entire project to the controller from the SD card.

Use this option carefully. For example, the SD card can contain a desirable IP address as part of an undesirable project, for example, a project that is older than the project currently used on the controller.

These requirements apply when using the SD card to set the IP address on a CompactLogix 5370 controller:

- A project must be stored on the SD card.
- The project that is stored on the SD card is configured with the Load Image parameter set to On Power Up.

For more information on how to use the SD card, see Chapter 12, [Use a Secure Digital Card on page 297](#).

Change the IP Address of a Controller

You can change the IP address of a CompactLogix 5370 controller after system operation has begun. In this case, the controller has an IP address that is assigned to it, but you must change that IP address.

You can use these tools to change the IP address of a controller:

- RSLinx Classic software
- Studio 5000 Logix Designer application
- SD card

IMPORTANT You **cannot** use any of these tools to **change** the IP address of a controller:

- Bootstrap Protocol (BOOTP) server
 - Dynamic Host Configuration Protocol (DHCP) server
-

Consider these factors when you determine how to change the IP address of a controller:

- Network isolation from, or integration into, the plant/enterprise network
- Network size - For large, isolated networks, it can be more convenient and safer to use a BOOTP/DHCP server rather than the Studio 5000 Logix Designer or RSLinx Classic software. A BOOTP/DHCP server limits the possibility of duplicate IP address assignment.

However, you can only use the BOOTP/DHCP server to **set** the IP address of the controller and not to change it. If you decide to change the IP address of the controller and want to use a BOOTP/DHCP server to limit the possibility of duplicate IP address assignment, you must first clear the IP address.

After clearing the IP address, use the steps that are described at [Use the BOOTP Server to Set the IP Address of the Controller on page 91](#) or [Use the DHCP Server to Set the IP Address of the Controller on page 98](#) to set the IP address of the controller.

- Company policies and procedures that deal with plant floor network installation and maintenance
- Level of involvement by IT personnel in plant-floor network installation and maintenance
- Type of training that is offered to control engineers and maintenance personnel

Change the Network IP Address with RSLinx Classic Software

IMPORTANT The steps in [Use RSLinx Software to Set the IP Address of the Controller on page 99](#) describe how to assign an IP address for a CompactLogix 5370 controller that does not have an IP address.

The steps in this section describe how to change the IP address on a CompactLogix 5370 controller that has an IP address that is assigned to it.

The graphics in this section show how to change the IP address for a 1769-L36ERM controller. The same steps also apply to all other CompactLogix 5370 controllers with slight variations in screens.

1. Right-click the controller and choose Module Configuration.



2. Click the Port Configuration tab when the Module Configuration dialog box appears.

The controller has an IP address and Network Configuration Type.

3. Type a new IP address and make any other desired changes.
4. To assign this configuration to the controller, click Static in the Network Configuration Type section of the dialog box.

IMPORTANT If you click Dynamic, on a power cycle, the controller clears the current IP configuration and starts to send BOOTP or DHCP requests, depending on the controller configuration.

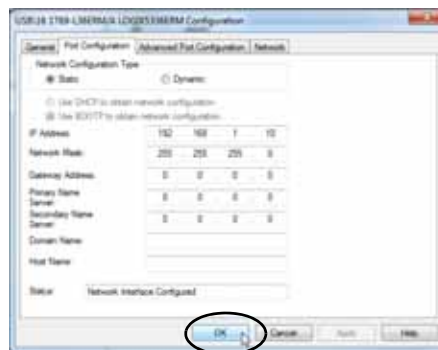

5. Click OK.

Change the Network IP Address with Logix Designer Application

IMPORTANT The steps in [Use the Logix Designer Application to Set the IP Address of the Controller on page 101](#) describe how to **assign an IP address** for a CompactLogix 5370 controller that does not have an IP address.

The steps in this section describe how to **change the IP address** on a CompactLogix 5370 controller that has an IP address that is assigned to it.

You can change the IP address of a CompactLogix 5370 controller via Logix Designer application over a USB or EtherNet/IP network connection.

The graphics in this section show how to change the IP address for a 1769-L18ERM-BB1B controller over a USB connection. The same steps also apply to all other CompactLogix 5370 controllers with slight variations in screens.

1. Verify that your computer is connected to the controller.
2. Verify that your project is online.
3. Right-click the controller name and choose Properties.

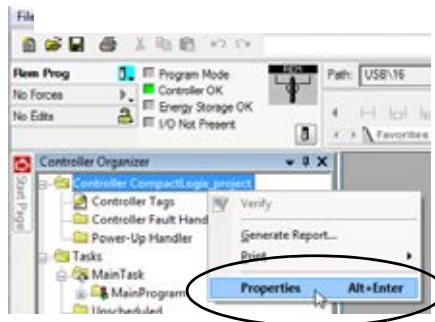

You can also right-click the Ethernet node in the I/O Configuration section and choose Properties. The Controller Properties dialog box appears on the Internet Protocol tab.

4. Change the IP address of the controller.
5. Make other changes where necessary.

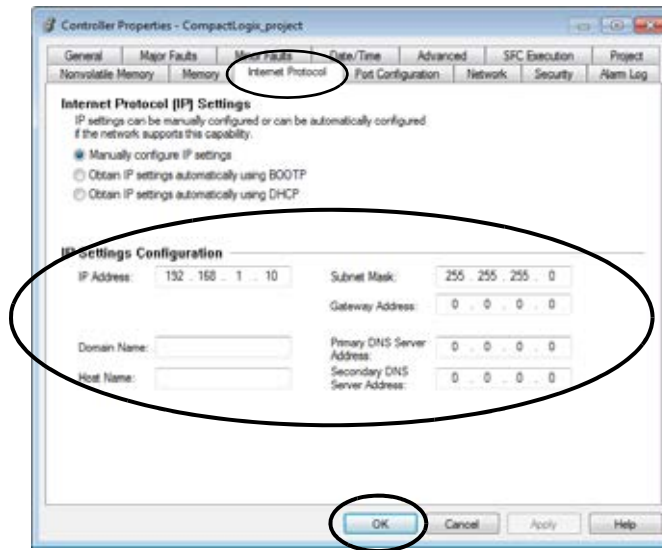

6. Click OK.

Change the Network IP Address with an SD Card

You can use an SD card to change the IP address for a CompactLogix 5370 controller when controller power is cycled. If you use the SD card to change the IP address, it removes the need for software to complete this task.

IMPORTANT To set the IP address from an SD card, software is not required during the power-up process. However, you must have previously saved the project to the SD card.

These requirements apply when using the SD card to change the IP address on a CompactLogix 5370 controller:

- A project is stored on the SD card.
- The project that is stored on the SD card includes another IP address for the CompactLogix 5370 controller than the IP address currently in use on the physical controller that houses the SD card.
- The project that is stored on the SD card is configured with the Load Image parameter set to On Power Up.
- Power is cycled to the controller with the SD card installed.

For more information on how to use the SD card, see Chapter 12, [Use a Secure Digital Card on page 297](#).

Load the Controller Firmware You must download the current firmware before you can use the CompactLogix 5370 controller.

IMPORTANT Do not interrupt a firmware update while it is in process. Firmware update interruption can cause the firmware revision of the CompactLogix 5370 controller to revert to its out-of-the-box revision level, that is, 1.xxx.

To load firmware, you can use any of the following:

- ControlFLASH software that installs with Logix Designer application
- AutoFlash that launches through the application when you download a project and the controller does not have the matching firmware revision
- SD card (catalog numbers 1784-SD1 or 1784-SD2) with an image stored on the card

If you use the ControlFLASH™ or AutoFlash utilities, you need an EtherNet/IP network or USB connection to the controller.

IMPORTANT The controller firmware revision that is loaded via the ControlFLASH software or the AutoFlash option can be overwritten after future controller power cycles if the conditions described in [Use the Secure Digital Card to Load Firmware on page 117](#) exist.

The firmware is available with the application or you can download it from the support website. Go to <http://www.rockwellautomation.com/support>.

Use the ControlFLASH Software to Load Firmware

You can use the ControlFLASH software to load firmware through a USB or EtherNet/IP network connection. We recommend the following when you load firmware via the ControlFLASH software:

- Use a USB connection to load the firmware.
- Remove the SD card, if one is installed in the controller.

Complete these steps to use the ControlFLASH software to load firmware.

IMPORTANT These steps show a 1769-L36ERM controller. The same steps also apply to all other CompactLogix 5370 controllers with slight variations in screens.

1. Verify that a connection exists between your computer and the CompactLogix 5370 controller.
2. Choose Start>All Programs>FLASH Programming Tools>ControlFLASH.

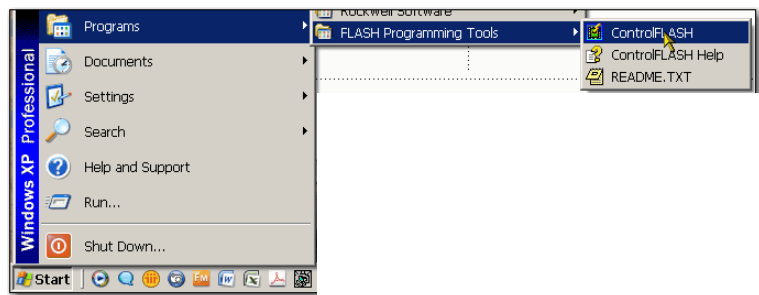

3. When the Welcome dialog box appears, click Next.

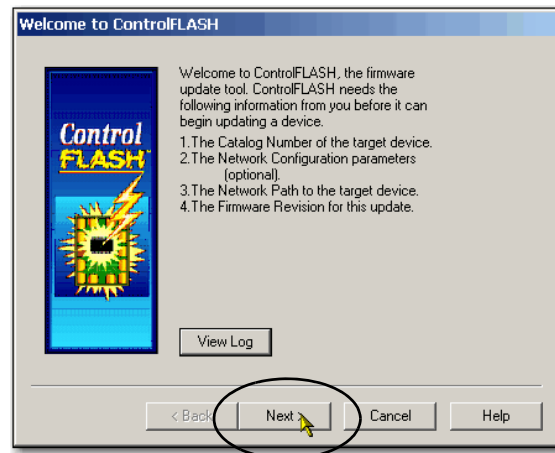

4. Choose the controller catalog number and click Next.

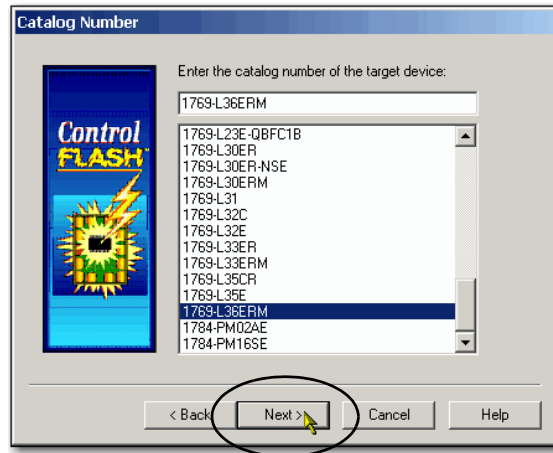

5. Expand the network until you see the controller.
6. Choose the controller at the first instance in which it appears, as shown in the following graphic, and click OK.

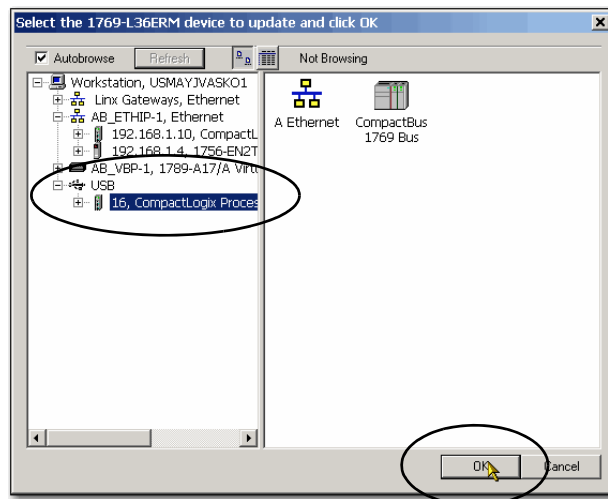

IMPORTANT If you expand the controller, that is, expand the network beyond the first instance in which it appears on the left side of the screen, you receive the following message:

- The target device is not in the proper mode to accept an update in ControlFLASH.

7. Choose the revision level to which you want to update the controller and click Next.

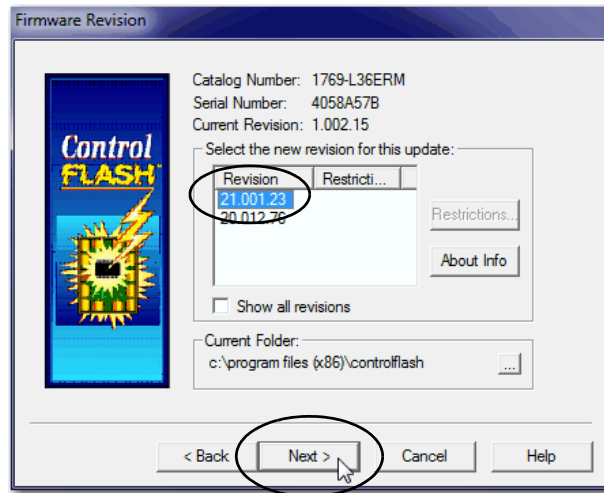

8. To start the update of the controller, click Finish and click Yes.

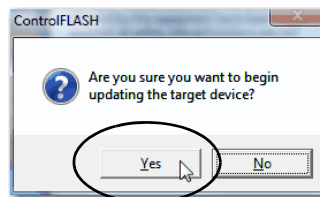
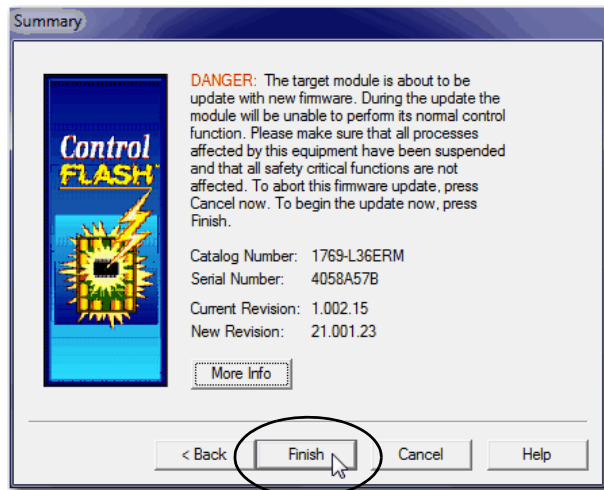

Before the firmware update begins, you see the following dialog box. Take the required action for your application. In this example, the update continues when OK is clicked.



After the controller is updated, the status dialog box displays the message Update complete.

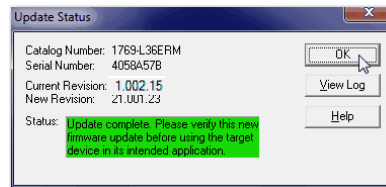

9. Click OK.
10. To close the ControlFLASH software, click Cancel and click Yes.

Automatic Update for CompactLogix 5370 L1 Embedded I/O Module

IMPORTANT This section applies only to CompactLogix 5370 L1 controllers.

After the controller firmware update process is complete, the controller can execute a firmware update for its embedded I/O module.

Remember these points regarding the automatic firmware update for the embedded I/O module:

- The firmware update occurs on only the embedded I/O module, not the local expansion modules.

If you must update the firmware revision on any 1734 POINT I/O™ modules that are used as local expansion modules, you must do so before installing them in the CompactLogix 5370 L1 control system.

- The firmware update on the embedded I/O module occurs automatically. No user action is required.
- The update process can take a few minutes to complete.
- During the firmware update process, the OK status indicator on the controller remains in a flashing red state.
- Do not cycle power to the controller while the firmware update for embedded I/O module is taking place.

Use AutoFlash to Load Firmware

You can use AutoFlash to load firmware through a USB or EtherNet/IP network connection.

Let the update complete without interruption. If you interrupt a firmware update that is in process, you are alerted that an error has occurred. In this case, cycle power to the controller. The firmware revision level reverts to the 1.xxx revision level and you can begin the update process again.

Complete these steps to use the AutoFlash utility to load firmware.

IMPORTANT These steps show a 1769-L36ERM controller. The same steps also apply to all CompactLogix 5370 controllers with slight variations in screens.

1. Make sure that the network connection is made and your network driver is configured in RSLinx Classic software.
2. Create a controller project.
3. To specify the controller path, click RSWho.

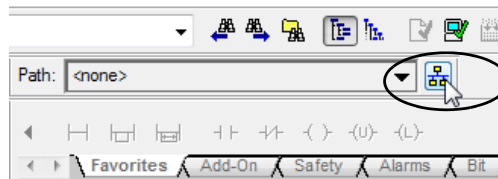

4. Select your controller and click Download.

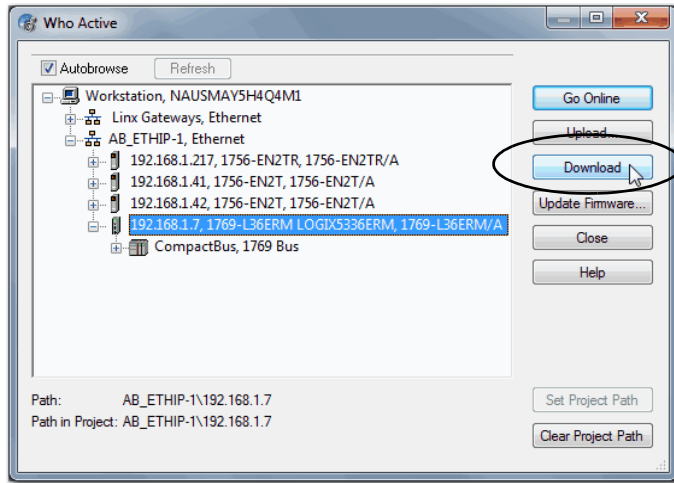

You can also choose to click Update Firmware to complete this process. If you do so, skip to [step 6](#).

A dialog box appears to indicate that the project revision and controller firmware revision are different.

5. Click Update Firmware.

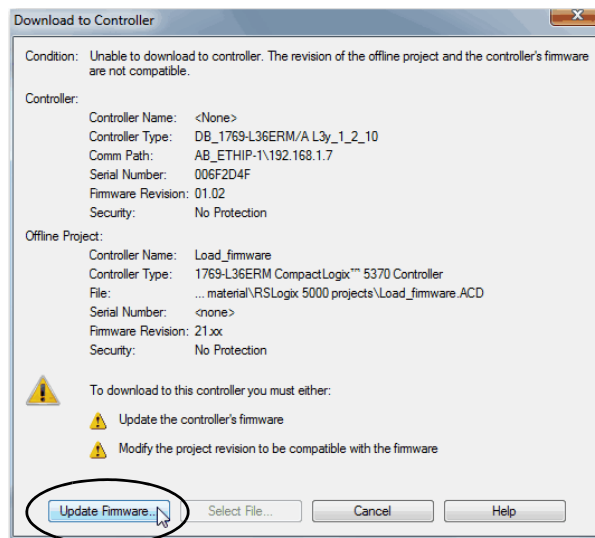

6. Use the checkbox and pull-down menu to choose your controller and firmware revision.

7. Click Update.

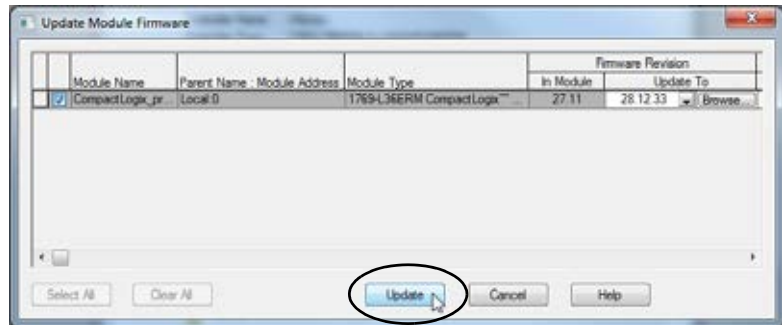

8. When the Update Firmware dialog box appears, click Yes.

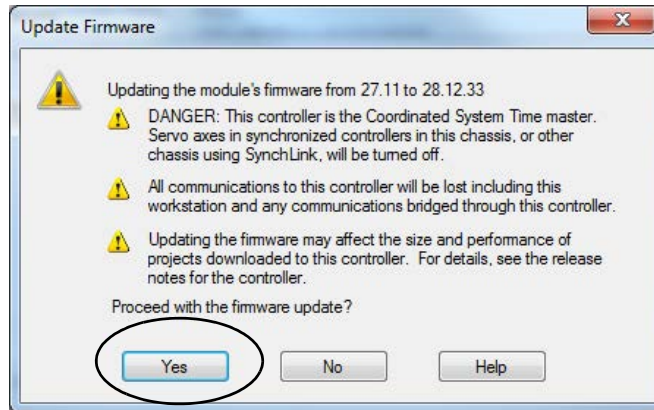

Before the firmware update begins, you can be warned about your controller missing its SD card. Take the required action, typically click OK.

The firmware update begins.

9. When the firmware update is complete, the Download dialog box appears and you can continue by downloading your project to the controller.

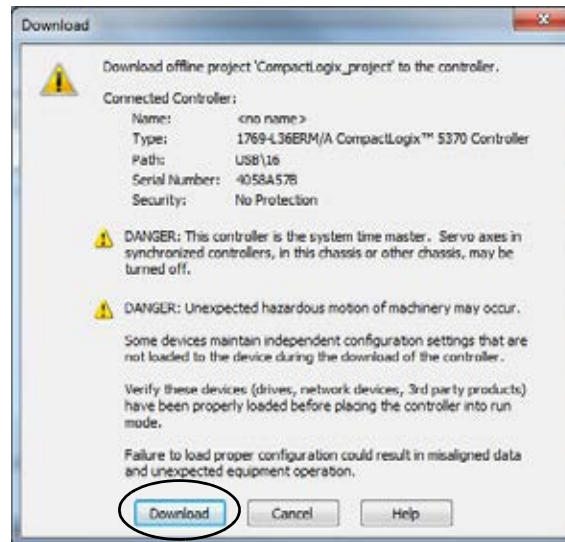

Use the Secure Digital Card to Load Firmware

You can use an installed SD card to load firmware on a CompactLogix 5370 controller. If you use the SD card to load firmware, it eliminates the need for software to complete this task.

IMPORTANT An installed SD card automatically updates the firmware of the controller if the SD card is configured with the Load Image parameter set to On Power Up. This feature is and cannot be disabled.

Your application requires the following to load firmware from an SD card at power-up:

- You must have saved the project to the SD card before the power cycle.
- The firmware revision in the project that is stored on the SD card differs from the firmware revision on the CompactLogix 5370 controller.

For more information on how to use the SD card, see Chapter 12, [Use a Secure Digital Card on page 297](#).

Select the Operating Mode of the Controller

CompactLogix 5370 controllers have slightly different front designs and mode switch placements.



WARNING: When you change switch settings while power is on, an electrical arc can occur. This could cause an explosion in hazardous location installations.

Be sure that power is removed or the area is nonhazardous before proceeding.

This graphic shows the mode switch on a CompactLogix 5370 L1 controller.

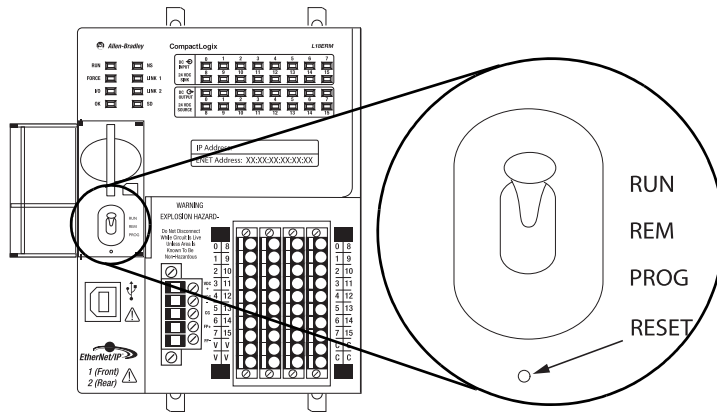

This graphic shows the mode switch on a CompactLogix 5370 L2 controller.

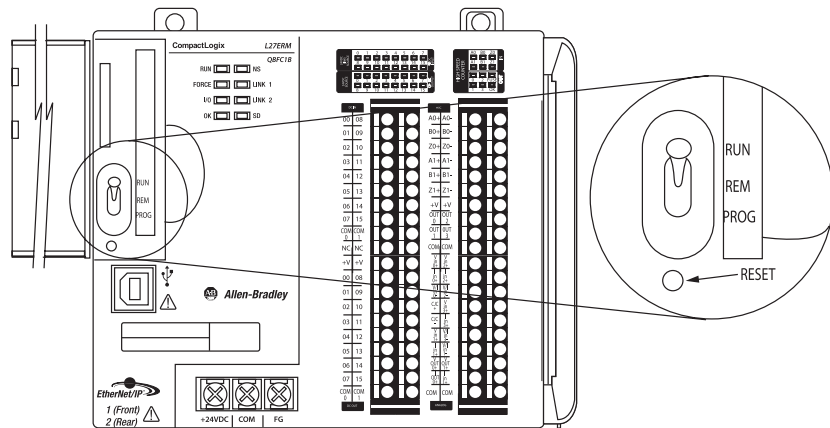

This graphic shows the mode switch on a CompactLogix 5370 L3 controller.

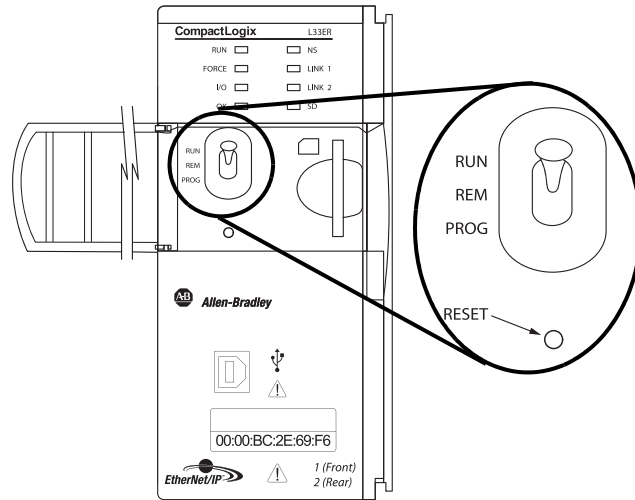

Use the mode switch on the controller to set the operating mode of the CompactLogix 5370 controller.

Mode Switch Position	Description
Run	<p>You can perform these tasks:</p> <ul style="list-style-type: none"> • Upload projects. • Run the program and enable outputs. <p>You cannot perform these tasks:</p> <ul style="list-style-type: none"> • Update controller firmware. • Create or delete tasks, programs, or routines. • Create or delete tags or edit online. • Import a program to the controller. • Change the port configuration of the controller, advanced port configuration, nor network configuration settings. • Change controller configuration parameters that are directly set for operation on a Device Level Ring (DLR) network topology.
Prog	<p>You can perform these tasks:</p> <ul style="list-style-type: none"> • Update controller firmware. • Disable outputs. • Upload/download projects. • Create, modify, and delete tasks, programs, or routines. • Change the port configuration of the controller, advanced port configuration, nor network configuration settings. <p>You cannot perform these tasks:</p> <ul style="list-style-type: none"> • Use the controller to execute (scan) tasks.

Mode Switch Position	Description
Rem	<p>You can perform these tasks:</p> <ul style="list-style-type: none"> • Upload/download projects. • Change the port configuration of the controller, advanced port configuration, nor network configuration settings. • Change between Remote Program, Remote Test, and Remote Run modes through the application.
Remote Run	<ul style="list-style-type: none"> • The controller executes (scans) tasks. • Enable outputs. • Edit online.
Remote Program	<ul style="list-style-type: none"> • Update controller firmware. • Disable outputs. • Create, modify, and delete tasks, programs, or routines. • Download projects. • Edit online. • The controller does not execute (scan) tasks.
Remote Test	<ul style="list-style-type: none"> • Execute tasks with outputs disabled. • Edit online.

Communicate over Networks

Topic	Page
EtherNet/IP Network Communication	121
DeviceNet Network Communication	134

All CompactLogix™ 5370 controllers support these tasks over an **EtherNet/IP network**:

- Control distributed I/O
- Send/receive messages to/from other devices on the same network or another network
- Produce/consume (interlock) data between controllers
- Socket interface

CompactLogix 5370 L2 and L3 controllers support these tasks over a **DeviceNet network**:

- Control distributed I/O
- Send messages to devices on the same network; the controller cannot receive messages from other devices on the network.

All CompactLogix 5370 controllers also support temporary connections from your computer via a USB connection.

EtherNet/IP Network Communication

The EtherNet/IP network offers a full suite of control, configuration, and data collection services by layering the Common Industrial Protocol (CIP) over the standard internet protocols, such as TCP/IP and UDP. This combination of well-accepted standards provides the capability that is required to support information data exchange and control applications.

The CompactLogix 5370 controllers use socket interface transactions and conventional communication over the EtherNet/IP network to communicate with Ethernet devices that do not support the EtherNet/IP application protocol.

For more information on socket interface transactions, see [Socket Interface with CompactLogix 5370 Controllers on page 131](#).

Available Software

Use the software that is listed in the following table with a CompactLogix 5370 controller on an EtherNet/IP network.

Software	Required Version	Functions	Required
RSLogix™ 5000	Version 20 - For CompactLogix 5370 controllers that are using firmware revision 20.	<ul style="list-style-type: none"> • Configure the CompactLogix project. • Define EtherNet/IP communication. • Change IP address for devices on network, including the CompactLogix 5370 controller. 	Yes. Studio 5000 Logix Designer application, version 28 or later - For 1769-L19ER-BB1B controllers
Studio 5000 Logix Designer® application	Version 21 or later - For CompactLogix 5370 controllers that are using firmware revision 21 or later. ⁽¹⁾		
RSLinx® Classic	2.59.00 or later CompactLogix 5370 L2 controllers require RSLinx Classic software, version 2.59.01 or later. The 1769-L19ER-BB1B controller requires RSLinx Classic software, version 3.74.00	<ul style="list-style-type: none"> • Assign or change IP addresses to devices on an EtherNet/IP network. • Configure communication devices. • Provide diagnostics. • Establish communication between devices. 	
BOOTP/DHCP utility	Most current version is installed with RSLinx Classic software installation.	Assign IP addresses to devices on an EtherNet/IP network.	No

(1) If you are using the L19 you must have at a minimum, Studio 5000®, version 28. There is no version of RSLogix 5000® (version 20) for support of the L19.

EtherNet/IP Network Functionality on CompactLogix 5370 Controllers

The CompactLogix 5370 controllers offer this EtherNet/IP network functionality:

- Dual built-in EtherNet/IP network ports
- Support for the following EtherNet/IP network topologies:
 - Device-level Ring Network topology
 - Linear Network Topology
 - Star Network Topology
- Support for CIP Sync technology
- Support for Integrated Motion over an EtherNet/IP network - Only the following controllers support this functionality:
 - 1769-L18ERM-BB1B
 - 1769-L27ERM-QBFC1B
 - 1769-L30ERM
 - 1769-L33ERM
 - 1769-L33ERMO
 - 1769-L36ERM
 - 1769-L36ERMO
 - 1769-L37ERM
 - 1769-L37ERMK
 - 1769-L37ERMO⁽¹⁾

- 1769-L38ERM
- 1769-L38ERMK
- 1769-L38ERMO⁽¹⁾
- Socket interface to communicate with Ethernet devices that do not support the EtherNet/IP application protocol
- Duplicate IP address detection
- Unicast and multicast communication
- Support messaging, produced/consumed tags, HMI, and distributed I/O
- Interface via RJ45, twisted-pair cables
- Support half/full-duplex 10 Mbps or 100 Mbps operation
- Support standard switches
- No network scheduling required
- No routing tables required

Nodes on an EtherNet/IP Network

When configuring your CompactLogix 5370 control system, you must account for the number of Ethernet nodes you include in the I/O configuration section of your project. CompactLogix 5370 controllers have limits on the number of nodes they support in the I/O configuration section.

[Table 5](#) lists the Ethernet node limits for CompactLogix controllers.

Table 5 - CompactLogix 5370 Controller Ethernet Node Guidelines

Cat. No.	Ethernet Nodes Supported
1769-L16ER-BB1B	4
1769-L18ER-BB1B	8
1769-L18ERM-BB1B	
1769-L19ER-BB1B	
1769-L24ER-QB1B	8
1769-L24ER-QBFC1B, 1769-L24ER-QBFC1BK	
1769-L27ERM-QBFC1B	16
1769-L30ER	
1769-L30ERM, 1769-L30ERMK	
1769-L30ER-NSE	
1769-L33ER	32
1769-L33ERM, 1769-L33ERMK	
1769-L33ERMO	

(1) Available at software version 31 and firmware revision 31.

(1) Available at software version 31 and firmware revision 31.

Cat. No.	Ethernet Nodes Supported
1769-L36ERM	48
1769-L36ERMO	
1769-L37ERM, 1769-L37ERMK	64
1769-L37ERMO ⁽¹⁾	
1769-L38ERM, 1769-L38ERMK	80
1769-L38ERMO	

(1) Available at software version 31 and firmware revision 31.

IMPORTANT While CompactLogix 5370 controllers offer the option of using Ethernet node count to effectively design a control system, the controllers do have connection limits on an EtherNet/IP network.

For more information on how to design EtherNet/IP network use in your CompactLogix 5370 control system, see these resources:

- The EtherNet/IP Capacity Tool available at the Integrated Architecture® Tools & Resources website: <http://www.rockwellautomation.com/global/products-technologies/integrated-architecture/tools/overview.page>
- The EtherNet/IP Capacity Tool helps you in the initial layout of your EtherNet/IP network.
- Ethernet Design Considerations Reference Manual, publication [ENET-RM002](#).

Devices Included in the Node Count

Any devices that you add directly to the local Ethernet I/O configuration are counted toward the node limitation of the controller. The following are example devices that are added to the I/O configuration section in your project and must be counted:

- Remote communication adapters
- I/O modules that are directly connected to the EtherNet/IP network, for example the 1732E-IB16M12R ArmorBlock® EtherNet/IP module
- Motion devices, such as drives
- Remote controllers
- HMI devices that are included in the I/O configuration section, for example, PanelView™ Plus terminals
- Linking devices, such as the 1788-EN2DNR, Ethernet-to-DeviceNet linking device or 1788-EN2DNROM, On-machine Ethernet-to-DeviceNet linking device

- Third-party devices that are directly connected to the EtherNet/IP network

Devices Excluded from the Node Count

When considering the Ethernet node limitation of a CompactLogix 5370 controller, you do not count Ethernet devices that exist on the EtherNet/IP network but are not added to the I/O configuration section of the project.

The following devices are not added to the I/O configuration section in your project and are not counted among the total number of nodes:

- Computer
- HMIs that are not added to the I/O configuration section, for example, PanelView Plus terminals
- MSG instructions
- Devices the CompactLogix 5370 controllers use a socket interface to communicate with.
For example, the following devices require communication via a socket interface:
 - Modbus TCP/IP device
 - Barcode scanners

EtherNet/IP Network Topologies

CompactLogix 5370 controllers support these EtherNet/IP network types:

- [Device-level Ring Network Topology](#)
- [Linear Network Topology](#)
- [Star Network Topology](#)

Each of these EtherNet/IP network topologies supports applications that use Integrated Motion over an EtherNet/IP network, if necessary.

Device-level Ring Network Topology

A DLR network topology is a single-fault tolerant ring network that is intended for the interconnection of automation devices. A DLR network is comprised of Supervisor (Active and Backup) nodes and Ring nodes.

DLR network topologies automatically convert to linear network topologies when a fault is detected. The conversion to the new network topology maintains communication of data on the network. The fault condition is typically easily detected and corrected.

CompactLogix 5370 controllers connect directly to a DLR network topology, that is, without requiring a 1783-ETAP tap to connect to the network. The controllers can function in any of the roles on a DLR network topology, that is, active supervisor node, back-up supervisor node or ring node.

IMPORTANT The topology graphics that are shown in this section are examples of applications that use only DLR network topologies. We recommend that you exercise caution if you consider designing an application that includes the connection of a DLR topology with a linear or star network topology.

For more information on using a DLR network topology, see the EtherNet/IP Embedded Switch Technology Application Guide, publication [ENET-AP005](#).

[Figure 8](#) shows an example 1769-L18ERM-BB1B control system using a DLR network topology.

Figure 8 - Example 1769-L18ERM-BB1B Control System Using DLR Network Topology

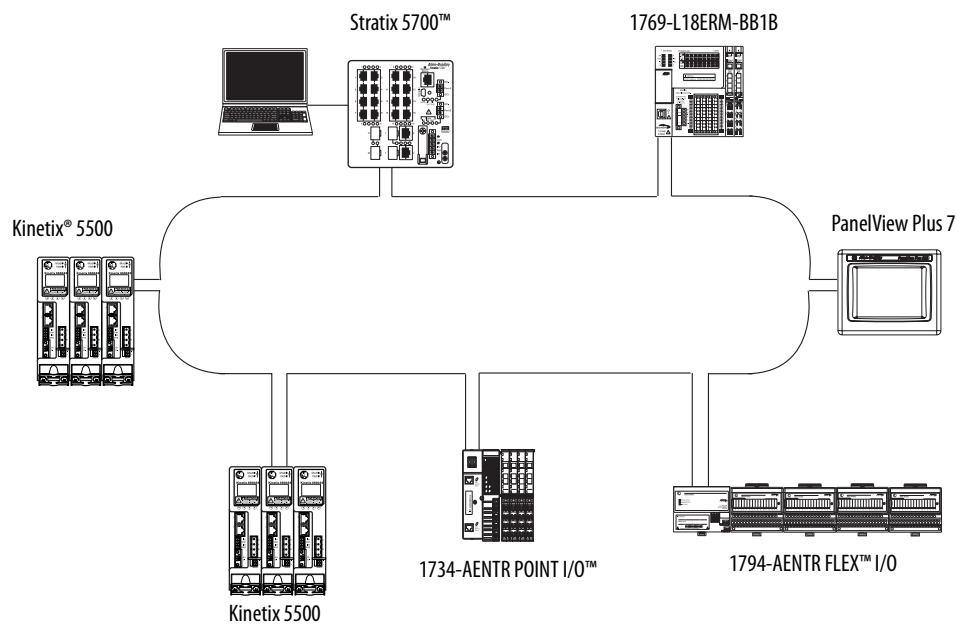

Figure 9 shows an example 1769-L27ERM-QBFC1B control system using a DLR network topology.

Figure 9 - Example 1769-L27ERM-QBFC1B Control System Using DLR Network Topology

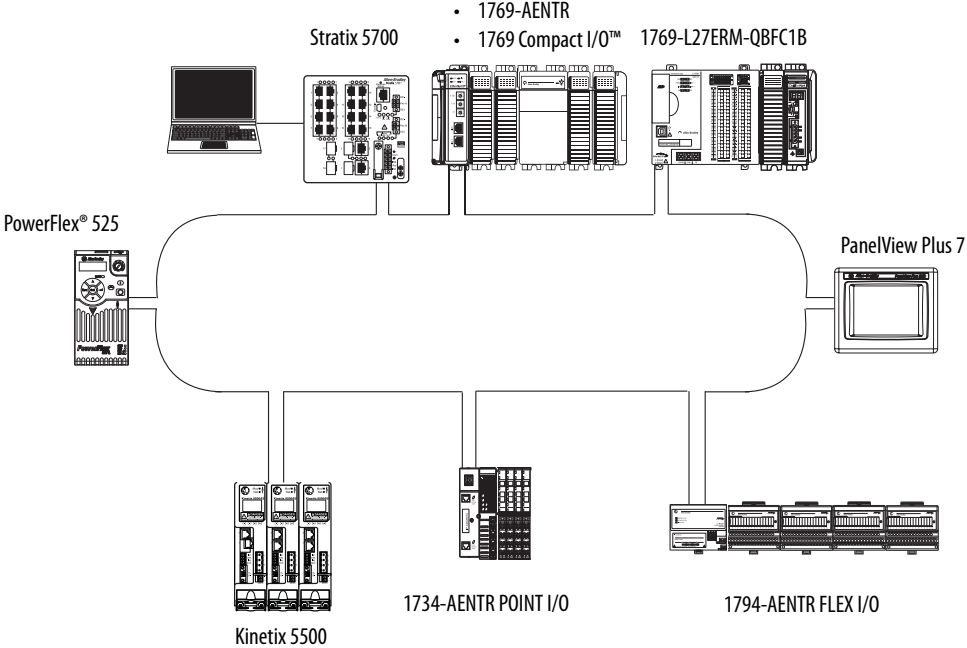
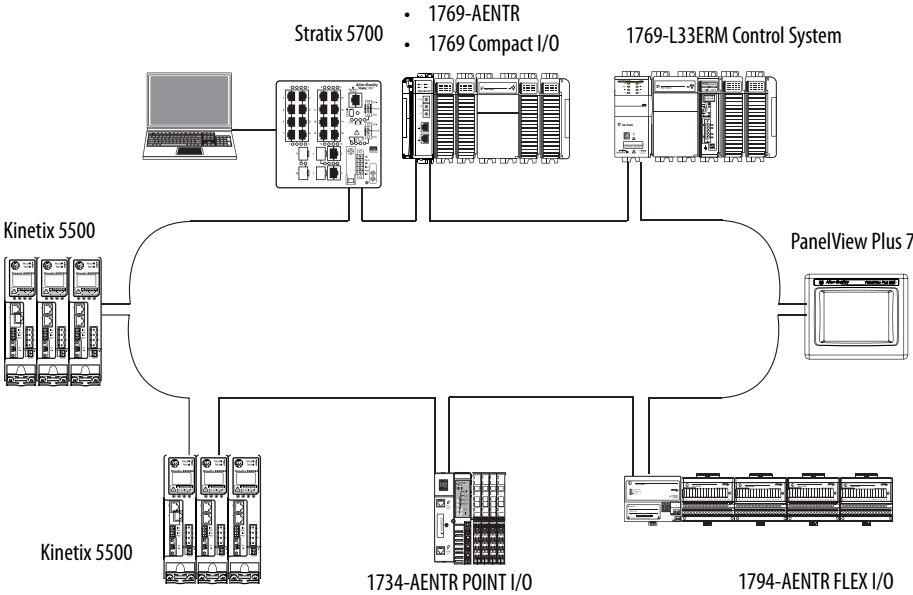

Figure 10 shows an example 1769-L33ERM control system using a DLR network topology.

Figure 10 - Example 1769-L33ERM Control System Using a DLR Network Topology



Linear Network Topology

A linear network topology is a collection of devices that are daisy-chained together across an EtherNet/IP network. Devices that can connect to a linear network topology use embedded switch technology to remove any need for a separate switch, as required in Star network topologies.

[Figure 11](#) shows an example 1769-L18ERM-BB1B control system using a linear network topology.

Figure 11 - Example 1769-L18ERM-BB1B Control System Using a Linear Network Topology

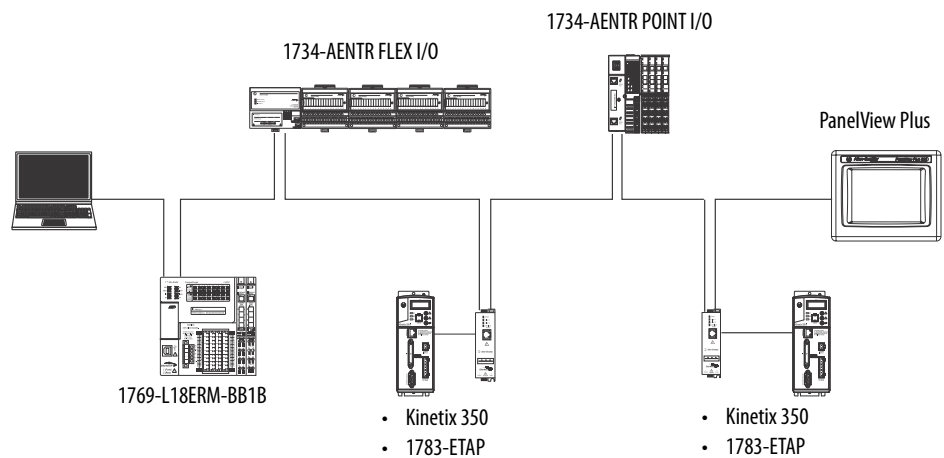

[Figure 12](#) shows an example 1769-L24ER-QB1B control system using a linear network topology.

Figure 12 - Example 1769-L24ER-QB1B Control System Using a Linear Network Topology

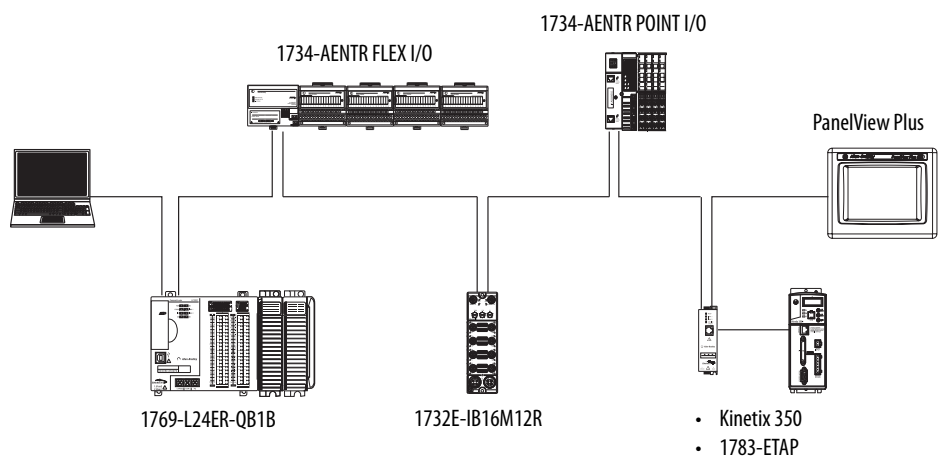
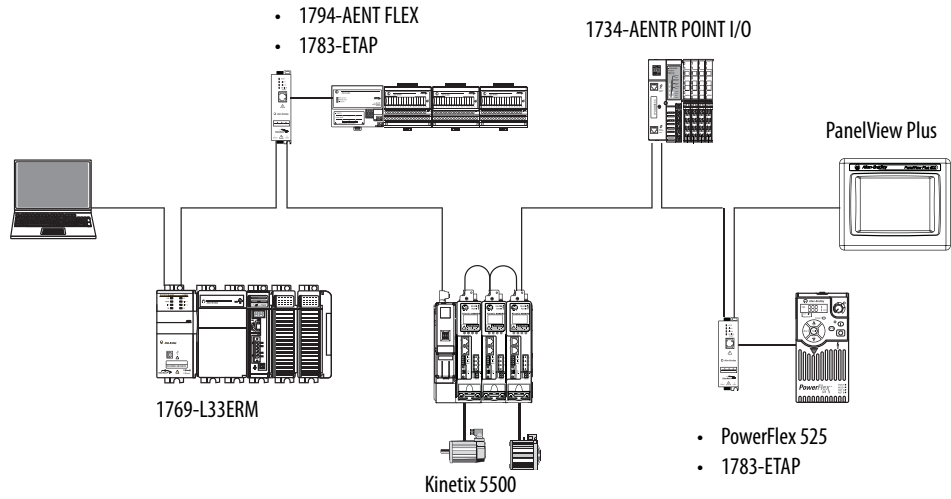

Figure 13 shows an example 1769-L33ERM control system using a linear network topology.

Figure 13 - Example 1769-L33ERM Control System Using a Linear Network Topology



Star Network Topology

A star network topology is a traditional EtherNet/IP network that includes multiple devices that are connected to each other via an Ethernet switch.

Figure 14 shows a 1769-L18ERM-BB1B control system using a star topology.

Figure 14 - Example 1769-L18ERM-BB1B Control System Using a Star Network Topology

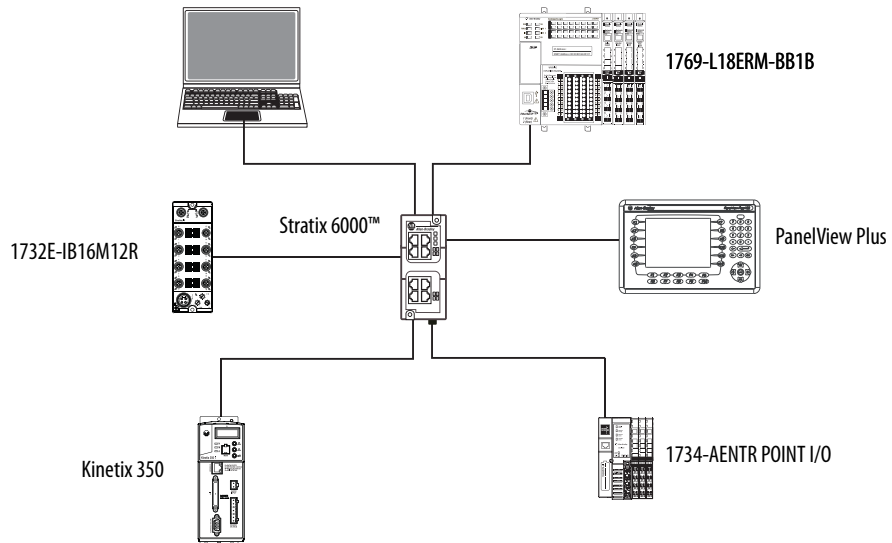

Figure 15 shows a 1769-L27ERM-QBFC1B control system using a star topology.

Figure 15 - Example 1769-L27ERM-QBFC1B Control System Using a Star Network Topology

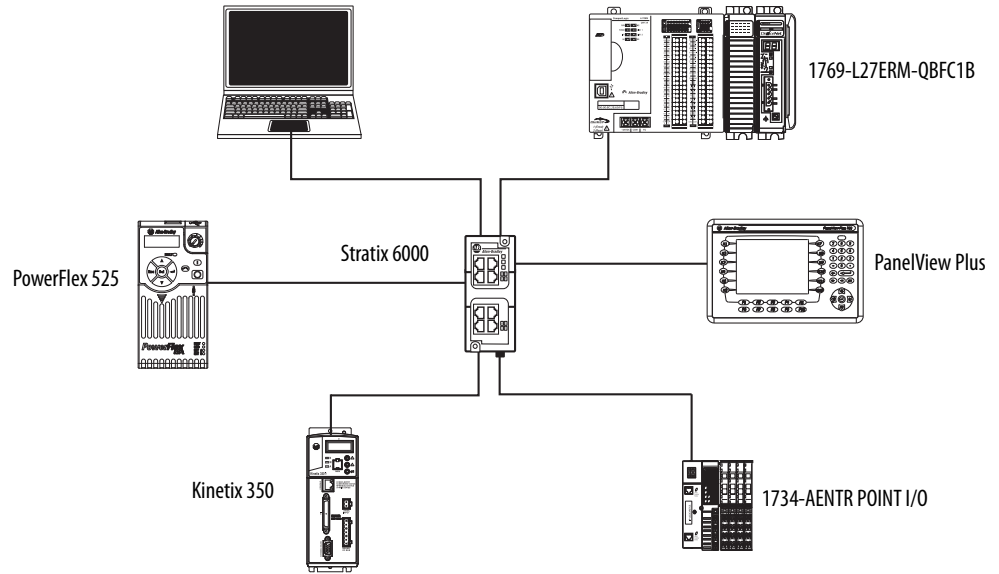
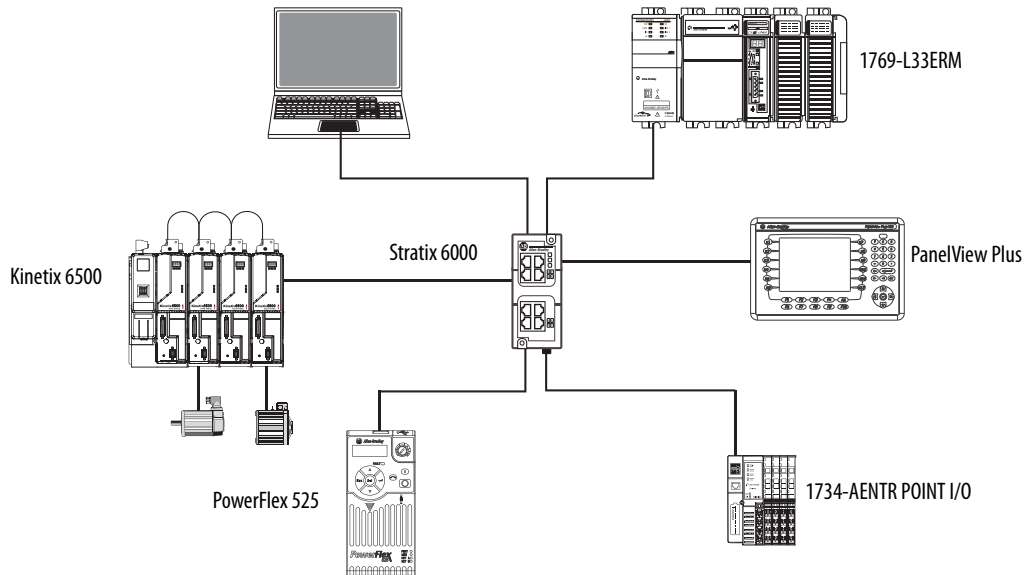

Figure 16 shows an example 1769-L33ERM control system using a star topology.

Figure 16 - Example 1769-L33ERM Control System Using a Star Network Topology



Socket Interface with CompactLogix 5370 Controllers

CompactLogix 5370 controllers can use socket interfaces to communicate with Ethernet devices that do not support the EtherNet/IP application protocol. The socket interface is implemented via the Socket Object. CompactLogix 5370 controllers communicate with the Socket Object via MSG instructions. To communicate with another device, you must understand the application protocol of the other device.

CompactLogix 5370 controllers support up to 32 socket instances.

-
- IMPORTANT** Keep the following in mind when using sockets with CompactLogix 5370 controllers:
- A significant difference between CompactLogix 5370 controllers and other Logix5000™ controllers is the communication path. CompactLogix 5370 controllers do not require a separate EtherNet/IP network communication module, for example, a 1756-EN2T module. In the case of the CompactLogix 5370 controllers, the MSG is sent to the controller itself by using the path '1,0'.
 - All CompactLogix 5370 controllers must use unconnected MSG instructions for socket servers. When you configure a message for a CompactLogix 5370 controller, make sure the Connected checkbox on the Message Configuration dialog box is cleared.
-

For more information on socket interface, see EtherNet/IP Socket Interface Application Technique, publication [ENET-AT002](#).

Quality of Service (QoS) and I/O Module Connections

CompactLogix 5370 controllers support Quality of Service (QoS) technology. QoS lets the controller prioritize EtherNet/IP network traffic. By default, the CompactLogix 5370 controllers are QoS-enabled. QoS can be disabled by configuring a message instruction in the Logix Designer application.

Some EtherNet/IP devices do not support QoS technology unless the firmware of the device is updated to a required minimum firmware revision level. For example, the ControlLogix® 1756-ENBT communication module must use firmware revision 4.005 or later to support QoS technology.

To make sure communication between CompactLogix 5370 controllers and I/O modules are maintained, verify that the EtherNet/IP devices use the minimum firmware revision level of the product that is required to support QoS technology.

For more information on the following, see Rockwell Automation Knowledgebase Tech Note 66325 (the document is available at <http://www.rockwellautomation.com/knowledgebase/>):

- Minimum firmware revision levels of EtherNet IP devices to support QoS technology
- Enable/disable QoS.

EtherNet/IP Network Connections

CompactLogix 5370 controllers use connections to manage communication on the EtherNet/IP network. A connection is a point-to-point communication mechanism that is used to transfer data between a transmitter and a receiver. Connections can be logical or physical.

You indirectly determine the number of connections the controller uses by configuring the controller to communicate with other devices in the system.

Connections are allocations of resources that provide more reliable communication between devices than unconnected messages.

All EtherNet/IP connections are unscheduled. An unscheduled connection is a message transfer between controllers that the requested packet interval (RPI) or the program, such as a MSG instruction, triggers. Unscheduled messaging lets you send and receive data when needed.

[Table 6](#) lists information for CompactLogix 5370 controllers.

Table 6 - CompactLogix 5370 Controller EtherNet/IP Network Port Specifications

Cat. No.	Connections			CIP Unconnected Messages (backplane + Ethernet)	Packet Rate Capacity (packets/second) ⁽²⁾		SNMP Support (password required)	Media Support	Produced/Consumed Tags	
	Controller	TCP	CIP		I/O	HMI/MSG			Number of Multicast Tags max ⁽³⁾	Unicast Available
1769-L16ER-BB1B	256	120	256	256	6000 @ 500 bytes/packet	400 messages/s @ 20% comm. timeslice	Yes	Twisted Pair	32 multicast produced tags 128 unicast produced tags	Yes
1769-L18ER-BB1B										
1769-L18ERM-BB1B										
1769-L24ER-QB1B										
1769-L19ER-BB1B										
1769-L24ER-QBFC1B										
1769-L27ERM-QBFC1B										
1769-L30ER										
1769-L30ERM										
1769-L30ER-NSE										
1769-L33ER										
1769-L33ERM										
1769-33ERMO										
1769-L36ERM										
1769-L36ERMO										
1769-L37ERM										
1769-L37ERMK										
1769-L37ERMO ⁽¹⁾										
1769-L38ERM										
1769-L38ERMK										
1769-L38ERMO ⁽¹⁾										

(1) Available at software version 31 and firmware revision 31.

(2) Total packet rate capacity = I/O Produced Tag, max + HMI/MSG, max Packet rates vary depending on packet size. For more detailed specifications, see the capacity section of the EDS file for the catalog number.

(3) These are the maximum numbers of CIP I/O connections.

DeviceNet Network Communication

The CompactLogix 5370 L2 and L3 controllers communicate with other devices over the DeviceNet network via a Compact I/O 1769-SDN DeviceNet scanner. The DeviceNet network uses the Common Industrial Protocol (CIP) to provide the control, configuration, and data collection capabilities for industrial devices.

IMPORTANT This section applies to applications using only CompactLogix 5370 L2 and L3 controllers.
CompactLogix 5370 L1 controllers do not operate on DeviceNet networks.

Available Software

The software applications that are listed in this table are required when using a CompactLogix 5370 L2 or L3 controller on a DeviceNet network.

Software	Required Version	Functions
RSLogix 5000®	20 - For CompactLogix 5370 controllers using firmware revision 20.	Configure the CompactLogix project
Studio 5000® environment	21 or later - For CompactLogix 5370 controllers using firmware revision 21 or later. Studio 5000 environment, version 28 or later - For 1769-L19ER-BB1B controllers.	
RSLinX Classic	2.59.00 or later ^{(1), (2), (3)}	<ul style="list-style-type: none"> • Configure communication devices • Provide diagnostics • Establish communication between devices
RSNetWorx™ for DeviceNet	One of the following: <ul style="list-style-type: none"> • 11.00.00 or later if used with RSLogix 5000 software, version 20.xx.xx • 21.00.00 or later if used with the Studio 5000 environment, version 21.00.00 or later 	<ul style="list-style-type: none"> • Configure DeviceNet devices • Define the scanlist for the DeviceNet network

(1) CompactLogix 5370 L2 controllers require RSLinx Classic software, version 2.59.01 or later.

(2) We recommend that you use RSLinx Classic software, version 3.51.00 or later, with the Studio 5000 environment, version 21.00.00 or later.

(3) RSLinx version 3.74.00 is recommended for use with the 1769-L19ER-BB1B controller.

Figure 17 shows an example 1769-L27ERM-QBFC1B control system using a DeviceNet network.

Figure 17 - Example 1769-L24ER-QB1B Control System Using a DeviceNet Network

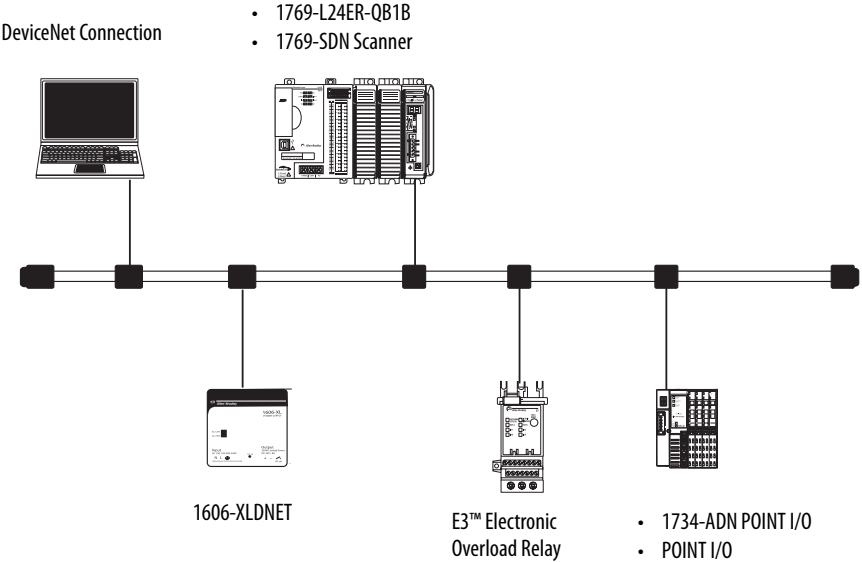
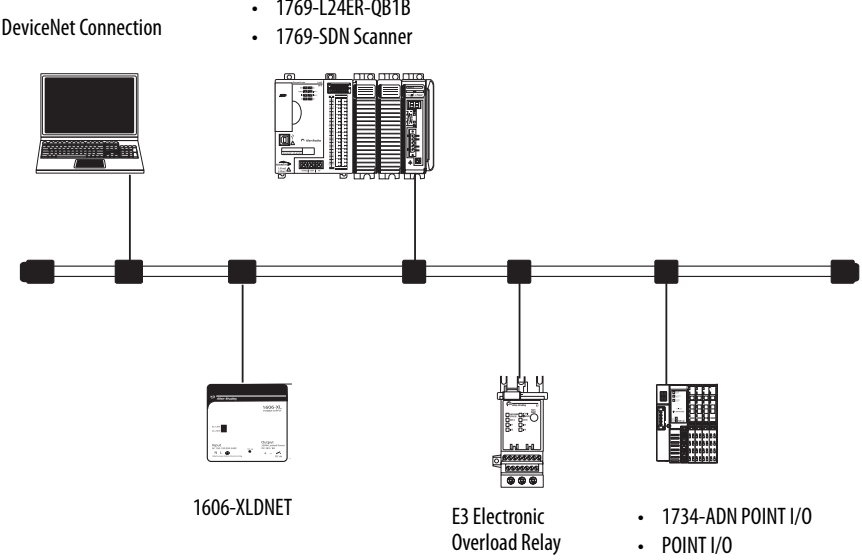

Figure 18 shows an example 1769-L33ERM using a DeviceNet network.

Figure 18 - Example 1769-L33ERM Control System Using a DeviceNet Network



Compact I/O 1769-SDN DeviceNet Scanner

You connect a CompactLogix 5370 L2 or L3 controller to a DeviceNet network via a Compact I/O 1769-SDN DeviceNet scanner.

Before installing the scanner, consider the following:

- You can connect the scanner to an adjacent controller, power supply, or I/O module.
- You must account for these two requirements jointly:
 - Power Supply Distance Rating - Described on [140](#)
 - Current Capacity in CompactLogix 5370 L3 Control Systems - Described on [140](#)
- The scanner, as a master, can own up to 63 slave I/O nodes.
- Another DeviceNet master can own a scanner that is simultaneously a master and be a slave.

The scanner has this functionality:

- Supports messaging to devices, not controller to controller
- Supports control-level network to device-level network for programming, configuration, control, or data collection
- Supports back up your CompactLogix 5370 L2 or L3 controller on the DeviceNet network

For more information on using the 1769-SDN to back up your CompactLogix 5370 L2 or L3 controller, see the 1769-SDN DeviceNet Scanner Module User Manual, publication [1769-UM009](#).

- Shares a common application layer with EtherNet/IP networks
- Offers diagnostics for improved data collection and fault detection

Power Supply Distance Rating

CompactLogix 5370 L2 and L3 control systems enable you to install 1769-SDN scanners as local expansion modules. The 1769-SDN scanner has a power supply distance rating that you must consider before installing it.

Power supply distance rating is the number of slots a 1769-SDN scanner can be installed away from the power supply. The 1769-SDN scanner has a power supply distance rating of four. Therefore, your CompactLogix 5370 L2 or L3 control system can include up to three modules between the 1769-SDN scanner and the power supply.

The power supply distance rating of the 1769-SDN scanner as a design consideration differs by CompactLogix L2 controller catalog number.

CompactLogix 5370 L2 Control Systems

In a CompactLogix 5370 L2 control system, you can install a 1769-SDN scanner on the right side of the control system. The controller has an embedded power supply, which disallows the installation of 1769-SDN scanners between the controller and the power supply.

Additionally, the controller has embedded I/O modules that disallow installation of the 1769-SDN scanner directly to the right of the embedded power supply. CompactLogix 5370 L2 control systems have one or two embedded I/O modules, described as follows:

- 1769-L24ER-QB1B controller - One embedded I/O module
- 1769-L24ER-QBFC1B and 1769-L27ERM-QBFC1B controllers - Two embedded I/O modules

While the embedded I/O modules are not considered local expansion modules, you must still include each embedded I/O module in the module slot count when determining where to install the 1769-SDN scanner as a local expansion module.

The farthest local expansion module slot where you can install the 1769-SDN scanner in a CompactLogix 5370 L2 control system is module slot number two or three as determined by the controller catalog number that is used in the control system.

[Table 7](#) describes the farthest local expansion module slot where you can install a 1769-SDN scanner and meet its power supply distance rating requirement.

Table 7 - Example CompactLogix 5370 L2 Control Systems with a 1769-SDN Scanner



Controller Cat. No.	Number of Embedded I/O Modules	1769-SDN Scanner Power Supply Distance Rating Calculation Impact
1769-L24ER-QB1B	1	<p>The embedded I/O module is the first module in the module count. At its maximum power supply distance rating, the 1769-SDN scanner can be installed in slot 3 of the local expansion modules, as shown in the following graphic.</p>  <p>Three modules between the power supply and the 1769-SDN scanner. With this controller catalog number, you can only install up to two local expansion modules between the controller and the 1769-SDN scanner.</p>

Table 7 - Example CompactLogix 5370 L2 Control Systems with a 1769-SDN Scanner

Controller Cat. No.	Number of Embedded I/O Modules	1769-SDN Scanner Power Supply Distance Rating Calculation Impact
1769-L24ER-QBFC1B 1769-L27ERM-QBFC1B	2	<p>The embedded I/O modules are the first two modules in the module count. At its maximum power supply distance rating, the 1769-SDN scanner can be installed in slot 2 of the local expansion modules, as shown in the following graphic.</p>  <p>Three modules between the power supply and the 1769-SDN scanner. With this controller catalog number, you can only install one local expansion modules between the controller and the 1769-SDN scanner.</p> <hr/> <p>IMPORTANT When counting I/O modules to determine the 1769-SDN scanner placement in a 1769-L24ER-QBFC1B or 1769-L27ERM-QBFC1B control system, the embedded I/O module appearance is different between the physical appearance and the appearance in the application of the module.</p> <p>The physical appearance is shown in the previous graphic. The second module is two rows of termination points below one set of status indicators.</p> <p>In the application, the second embedded I/O module appears as two modules in the Controller Organizer each with their own slot number, that is [2] and [3].</p> <p>When the 1769-SDN scanner is installed in the farthest local expansion module slot possible, that is the fourth module in the control system, it appears with a [5] designation in the Controller Organizer, as shown in the following graphic.</p>  <p>Modules [2] and [3] are shown separately but are considered one module when counting modules to meet power supply distance rating requirements.</p> <p>1769-SDN scanner is shown as module [5] in this location but considered the fourth module when counting modules to meet power supply distance rating requirements.</p>

CompactLogix 5370 L3 Control Systems

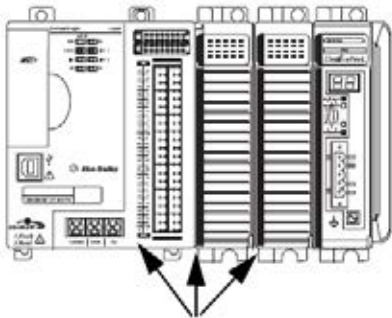
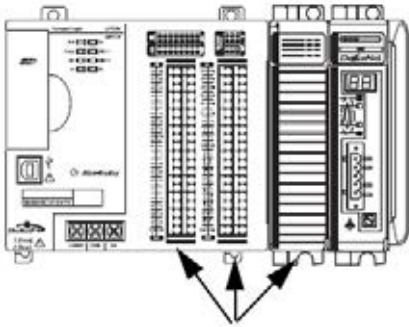
CompactLogix 5370 L3 control systems do not have embedded I/O modules. You begin counting local expansion slots with the first Compact I/O module installed next to the power supply when determining where to install a 1769-SDN scanner and meet its power supply distance rating.

In CompactLogix 5370 L3 control systems, you can install 1769-SDN scanners to the left or right side of the power supply. You can also use local and extra banks in CompactLogix 5370 L3 control systems, with each allowing the inclusion of a 1769-SDN scanner.

In the local bank, the controller must be the leftmost device in the system and you can only install up to three modules between the controller and the power supply. Therefore, any 1769-SDN scanners that are installed to the left of the power supply in the local bank, are in a module slot that meets the power supply distance rating requirements of the module.

CompactLogix 5370 L3 control systems also support the use of extra banks for the local expansion modules of the system. Each additional bank requires a 1769 Compact I/O power supply. The bank can be designed with local expansion modules on either side of the power supply.

In this case, you must install the 1769-SDN scanner with no more three Compact I/O modules between the scanner and the power, regardless of whether the modules are installed to the left or right of the power supply.

This graphic shows 1769-SDN scanners that are installed in a 1769-L36ERM control system that meet the power supply distance rating of the module.

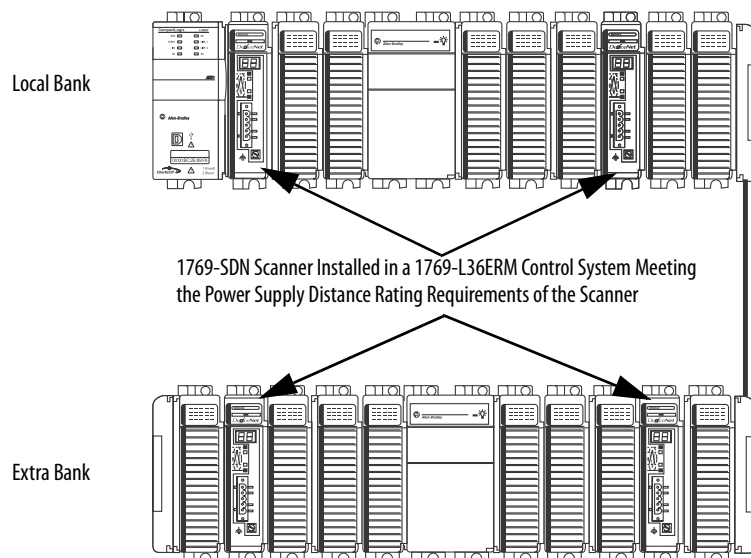

Current Capacity in CompactLogix 5370 L3 Control Systems

In a local or extra bank, the modules that are installed on either side of the power supply cannot draw more current than the power supply can supply. This requirement partially dictates module placement on the bank.

For example, if a bank uses a 1769-PA2 Compact I/O power supply, each side of the bank has a current capacity of 1 A at 5V DC and 0.4 A at 24V DC. Because a

1769-SDN scanner has a current draw of 440 mA at 5 V DC and 0 mA at 24 V DC, you can only install up to two scanners on each side of the power supply in the bank in this case.

For more information on 1769 Compact I/O power supply maximum current capacity and calculations you can use to design the modules that are used in local or extra banks, see [Calculate System Power Consumption on page 243](#).

Notes:

Use I/O Modules with CompactLogix 5370 L1 Controllers

This chapter explains how to use I/O modules in a CompactLogix™ 5370 L1 control system.

Topic	Page
Select I/O Modules	143
Validate I/O Layout	162
Use the Event Task	168
Configure I/O	172
Configure Distributed I/O Modules on an EtherNet/IP Network	174
Configure Distributed I/O Modules on an EtherNet/IP Network	174
Monitor I/O Modules	177

Select I/O Modules

CompactLogix 5370 L1 control systems offer these I/O module options:

- [Embedded I/O Modules](#)
- [Local Expansion Modules](#)
- [Distributed I/O Modules over an EtherNet/IP Network](#)

Connect Field Power to I/O Devices Connected to a CompactLogix 5730 L1 Control System

[Connect Power to the Controller \(Series B\) on page 37](#), describes how to connect a dedicated, Class 2/SELV-listed external 24V DC power source to the VDC+ and VDC- terminals on the removable connector that is shown in the following graphic. Those connections provide power to only the system-side of the embedded I/O and local expansion I/O modules.

IMPORTANT You must connect a separate external power source to the FP+ and FP- terminals on the removable connector on the controller to power the field-side circuitry of the embedded I/O modules and the local expansion modules for only series A L1 controllers. See [Appendix C](#) for further information.

Power connections to the FP+ and FP- terminals provides power to input and output devices that are connected to the embedded I/O modules or local expansion modules of the controller. For example, input or output devices, such as a barcode scanner.

The embedded I/O of the controller and the field-side power of the local expansion modules is 24V DC nominally with an input range of 10...28.8V DC.

This graphic shows the removable connector.

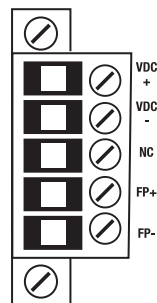

IMPORTANT The controller is grounded once it is installed on a DIN rail as described in [Mount the System on page 32](#).

Consider these points before completing the steps in this section:

- This section describes how to connect a 24V DC power source to power input or output devices that are connected to the embedded I/O or local expansion modules of the CompactLogix 5370 L1 controller via FP+ and FP- terminals.

For information on how to connect 24V DC power to the CompactLogix 5370 L1 controller and the POINTBus™ backplane via VDC+ and VDC- terminals on the removable connector, see [page 37](#).

- The external 24V DC power source that is connected to the FP+ and FP- terminals **must be separate** from the power source that is dedicated to power the controller via the VDC+ and VDC- terminals for only series A controllers (see [Appendix C](#)).
- You can use the external 24V DC power source that provides power to the FP+ and FP- terminals to power other components or devices in the application.
- The external 24V DC power source that provides power to the FP+ and FP- terminals can be installed on the same DIN rail as the external 24V DC power source that provides power to the VDC+ and VDC- terminals or you can install the external 24V DC power sources on separate DIN rails.
- Use a power source that most effectively meets your application needs. That is, calculate the power requirements of your application before choosing a power source to avoid using a power source that far exceeds your application requirements:
 - Limit field power current to 3 A or use a 1734-FPD module to avoid blowing the internal fuse.
 - Install a user-replaceable fuse with overcurrent protection of 4...6 A @ 52.5...68.25 I²t in line between the incoming power and the FP+ terminal.

- This section assumes that any DIN rail you use has been grounded following Industrial Automation Wiring and Grounding Guidelines, publication [1770-4.1](#).
- For example purposes, this section describes how to use a 1606-XLE80E, Class 2 switched-mode power supply with the FP+ and FP- terminals. The exact steps for other external power supplies can vary from the steps that are described here.

IMPORTANT Do **not** use the following steps to connect power to the CompactLogix 5370 series A L16ER, L18ER, and L18 ERM controllers controller. See [Appendix C](#) for steps to connect power to the CompactLogix 5370 series A L16ER, L18ER, and L18 ERM controllers controller. The steps in [Appendix C](#) provide an optional way to connect power to a series B L1 controller.

Complete these steps to connect power to the CompactLogix 5370 series B L16ER, L18ER, L18ERM, and series A L19 controllers.

1. Verify that the separate external 24V DC power source that powers the CompactLogix 5370 L1 controller is not powered.
2. Connect wires to the + and - connections on the external 24V DC power source.



WARNING: If you connect or disconnect wiring while the field-side power is on, an electrical arc can occur. This could cause an explosion in hazardous location installations. Be sure that power is removed or the area is nonhazardous before proceeding.

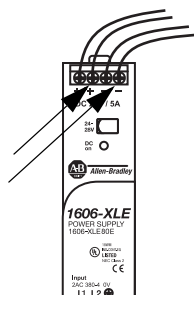

3. Loosen the screws that secure the removable connector to the CompactLogix 5370 L1 controller and pull the connector off the controller.

Wires that are connected between external 24V DC power source and VDC+ and VDC- terminals on the removable connector.

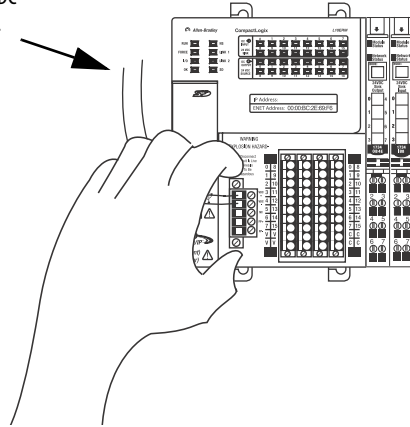

4. Connect the wire that is connected to the + terminal on the external 24V DC power source to the FP+ terminal. The FP+ terminal is the fourth terminal from the top on the removable connector.

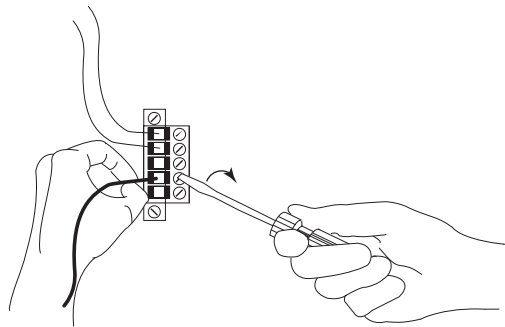

5. Connect the wire that is connected to the - terminal on the external 24V DC power source to the FP- terminal. The FP- terminal is the fifth terminal from the top on the removable connector.

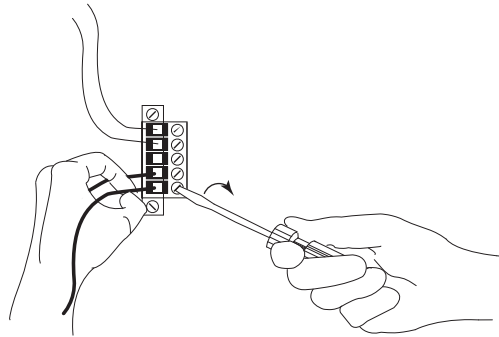

6. Plug the removable connector into the controller.
7. Secure the removable connector in place.

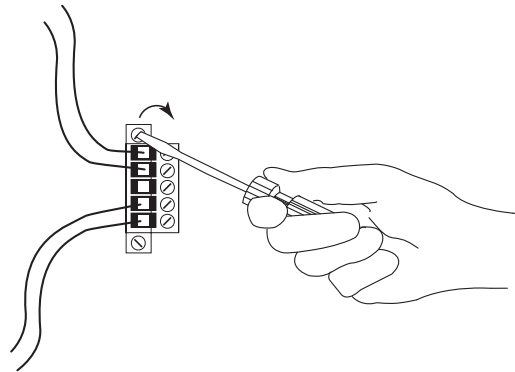

8. Turn on power to the separate external 24V DC power source connected to the removable connector.

The following graphic shows separate external 24V DC power supply that is connected to the VDC+/VDC- and FP+/FP- terminals on the removable connector, respectively.

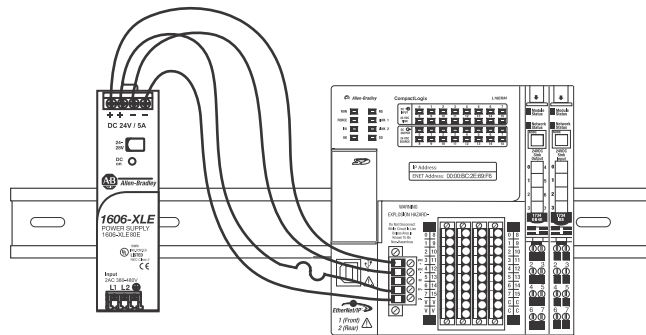

IMPORTANT: No wires are connected to the NC terminal.

Embedded I/O Modules

CompactLogix 5370 L1 controllers provide an embedded power supply and an embedded I/O module with these points:

- 16 sinking 24V DC digital input points
- 16 sourcing 24V DC digital output points

The following diagram shows the wiring terminals on the embedded I/O module.

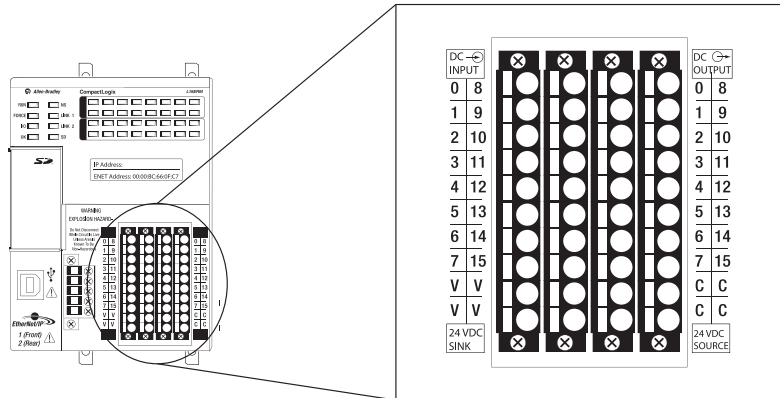

Consider the following when you connect input or output devices to the embedded I/O modules of your CompactLogix 5370 L1 controller:

- You must connect an external 24V DC power source to the FP+ and FP- terminals on the removable connector on the controller to power input and output devices that are connected to the embedded I/O modules on the controller:
 - Series A for L16ER, L18ER, and L18ERM controllers require an extra external 24V DC power source for the FP+ and FP- terminal connections. For more information on how to connect an extra external power source for series A L1 controller to the FP+ and FP- terminals, see [Appendix C](#).
 - Series B controllers use the external 24V DC power source that is connected to the VDC+ and VDC- terminals on the controller for the FP+ and FP- terminal connections. Series B controllers can also use an extra external 24V DC power source for the FP+ and FP- terminal connections. See [Appendix C](#) for more information on how to connect the extra external power source to the FP+ and FP- terminals. For more information on how to connect the external power source to the FP+ and FP- terminals on the series B controller, see [page 146](#).

The field-side power requirement of the embedded I/O modules of the controller is 24V DC nominally with an input range of 10...28.8V DC.

- The available RPI range of the I/O points is 1.0 ms...750.0 ms and can be changed by 0.5 ms increments. The default setting is 20 ms.

IMPORTANT • If you attempt to use an RPI value that is not valid, the application automatically rounds the value down to the closest 0.5 ms increment when you apply the change.

For example, if you set the RPI = 1.75 ms, when you click Apply or OK, the value is rounded down to 1.5 ms and applied.

- The RPI value for embedded I/O module is intended to establish a time interval at which data is transmitted. However, the configuration of your CompactLogix 5370 L1 control system can affect the actual time interval of data transmission.

For more information, see [Estimate Requested Packet Interval on page 164](#).

Complete these steps to wire the input and output points on the CompactLogix 5370 L1 controller.

1. Verify that the control system is not powered.
2. Use a small screwdriver to push the spring release clip and insert the wire.

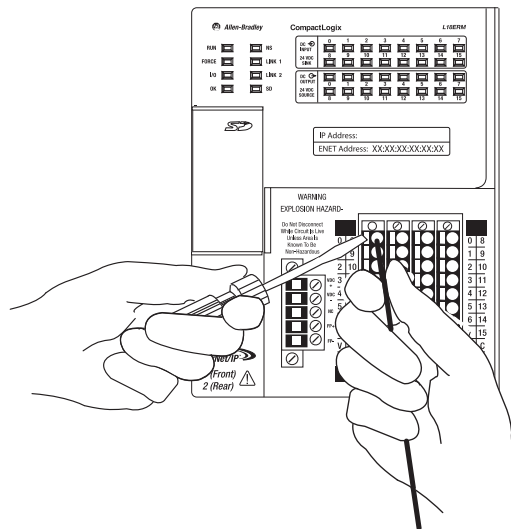

3. With the wire in place, pull the screwdriver off the spring release clip.
4. Repeat [step 2](#) for all embedded I/O wires that are needed in your application.

To remove a wire from the removable connector, complete these steps.

1. Verify that the control system is not powered.
2. Use a small screwdriver to push the spring release clip and pull out the wire.

Remove and Replace and I/O Module Connector

Complete these steps to remove and replace and I/O module connector.

1. Verify that the control system is not powered.
2. Use a small screwdriver to loosen the screws that secure the connector to the module.

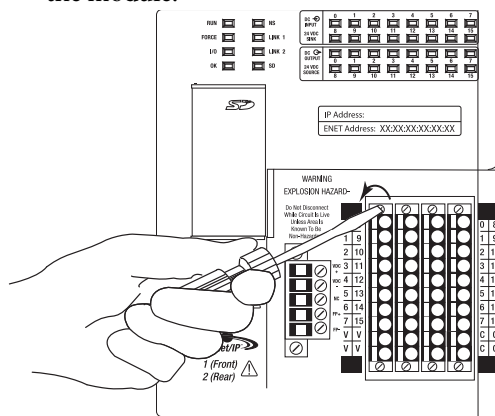

3. Pull the connector out from the I/O module to remove it.
4. Disconnect any wires from the connector.
5. Connect any wires to the replacement connector.
6. Push the replacement connector back into the I/O module.
7. Secure the connector to the I/O module with the small screwdriver.

Embedded Input Points

The embedded input points on the CompactLogix 5370 L1 controllers support 2-wire and 3-wire input devices. You can wire the input devices to be powered in one of the following methods:

- By using an **external power supply**, as shown in [Figure 19](#) - In this case, you can monitor the input devices even if field power is interrupted, for example, by the Master Control Relay (MCR).

This method is required if you must continue reading data from the input devices when the embedded output terminals are disabled, for example, when the use of a MCR disrupts output power.

- By using the **V terminal** on the embedded I/O module, as shown in [Figure 21](#) - In this case, you cannot monitor the input devices even if field power is interrupted, for example, by the MCR.

[Figure 19](#) and [Figure 20](#) show examples of how to power 2-wire and 3-wire input devices in your application.

IMPORTANT When using [Figure 19](#) and [Figure 20](#), use the following guidelines:

- With this wiring configuration, you can monitor the input devices even if field power is interrupted, for example, by the MCR. The FP- connection must be maintained as a reference for inputs to function.
- With this wiring configuration, the controller does not help protect field-side devices from overcurrent draw conditions.
- Design your application so that power consumption does not exceed the power supply ratings.
- The following figure is a wiring example that complies with the National Electrical Code (NEC) standard for isolation between system and field power.
- The FP+ terminal on the removable connector is the voltage connection.
- The FP- terminal on the removable connector is the common connection.
- The MCR must be closed for the removable connector to provide power to the embedded I/O module.
- Install a user-replaceable fuse with overcurrent protection of 4...6 A @ 52.5...68.25 I²t in line between the incoming power and the FP+ terminal.

For series A L1 controllers **only**, you must use a separate, dedicated Class 2 power supply for the CompactLogix 5370 L1 controller and a separate power supply for the embedded I/O module (see [Appendix C](#)).

Figure 19 - CompactLogix 5370 L16ER, L18ER, and L18ERM Controllers with Input Devices Powered by External Power Supplies (Series A [Alternate Series B])

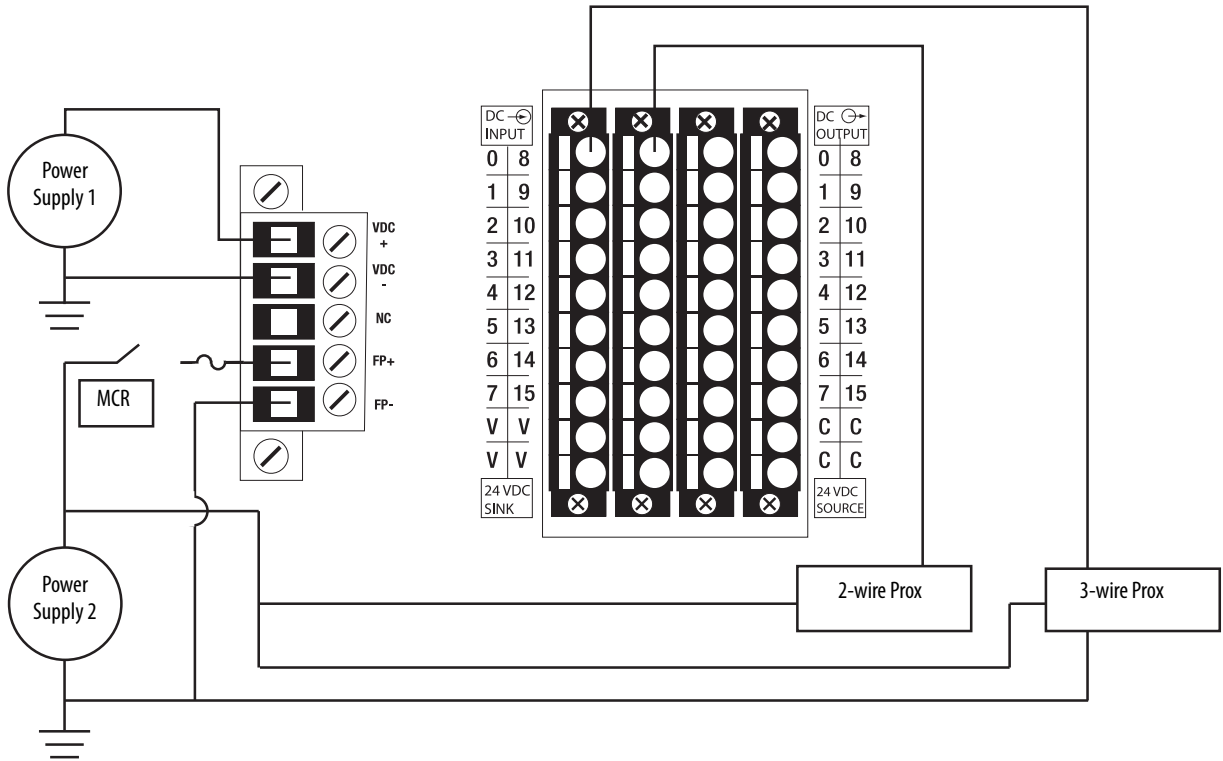
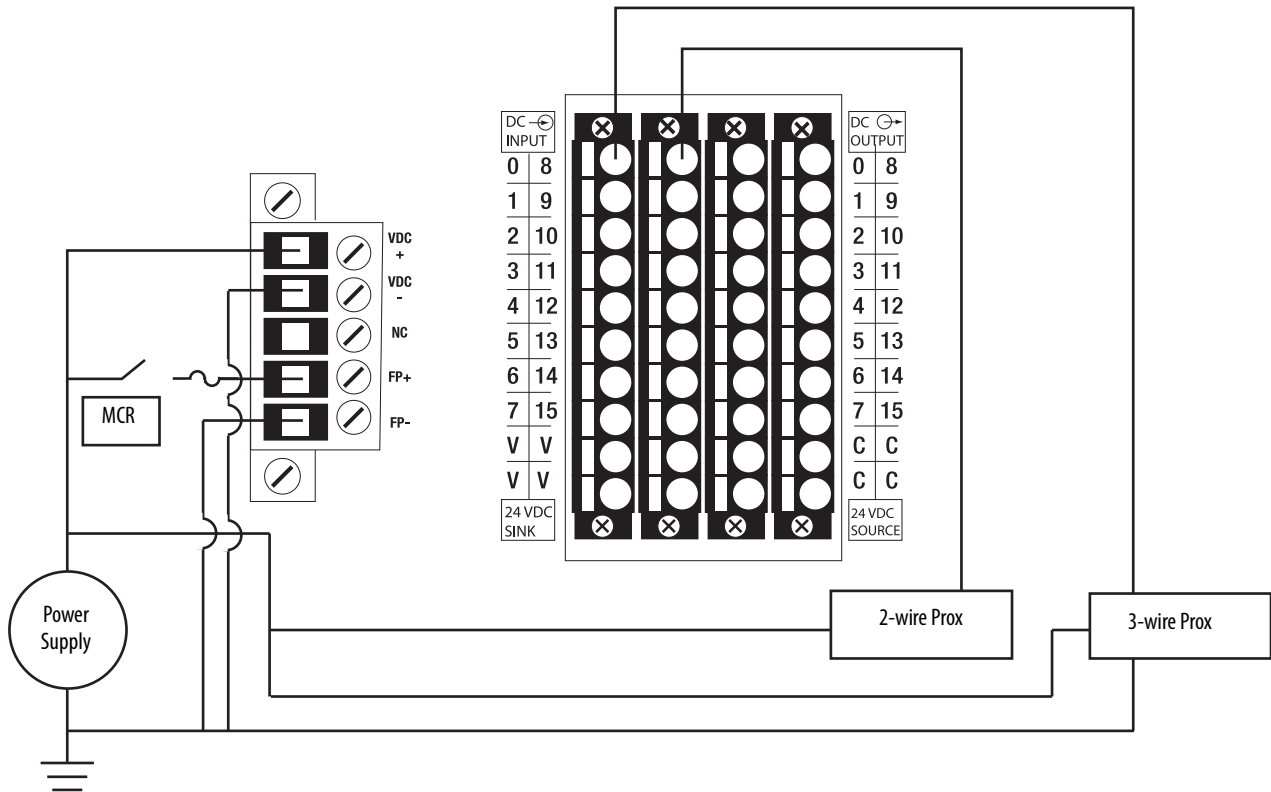

Figure 20 - CompactLogix 5370 L1 Controllers with Input Devices Powered by External Power Supplies (Series B)



[Figure 21](#) and [Figure 22](#) shows examples of how to power 2-wire and 3-wire input devices in your application with connections to a V terminal.

IMPORTANT

When using [Figure 21](#) and [Figure 22](#), use the following guidelines:

- With this wiring configuration, the input devices lose power if the removable connector does not power the embedded I/O modules.
- With this wiring configuration, the controller does not help protect field-side devices from overcurrent draw conditions.
- Design your application so that power consumption does not exceed the power supply ratings.
- The following figure is a wiring example that complies with the National Electrical Code (NEC) standard for isolation between system and field power.
- The FP+ terminal on the removable connector is the Voltage connection.
- The FP- terminal on the removable connector is the Common connection.
- The MCR must be closed for the removable connector to provide power to the embedded I/O module.
- Install a user-replaceable fuse with overcurrent protection of 4...6 A in line between the incoming power and the FP+ terminal.

For series A L1 controllers **only**, you must use a separate, dedicated Class 2 power supply for the CompactLogix 5370 L1 controller and a separate power supply for the embedded I/O module (see [Appendix C](#)).

Figure 21 - CompactLogix 5370 Series B L16ER, L18ER, L18ERM, and Series A L19 Controllers with Input Devices Powered by a V Terminal on Embedded I/O Module (Series A [Alternate Series B])

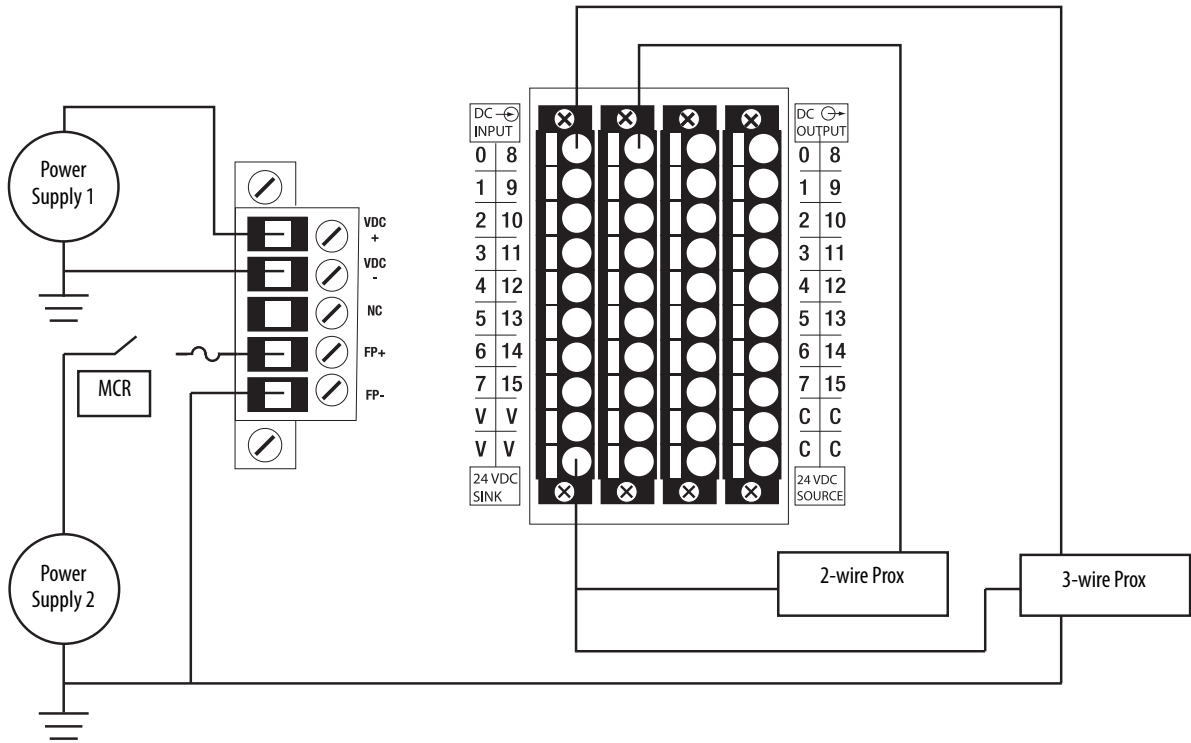
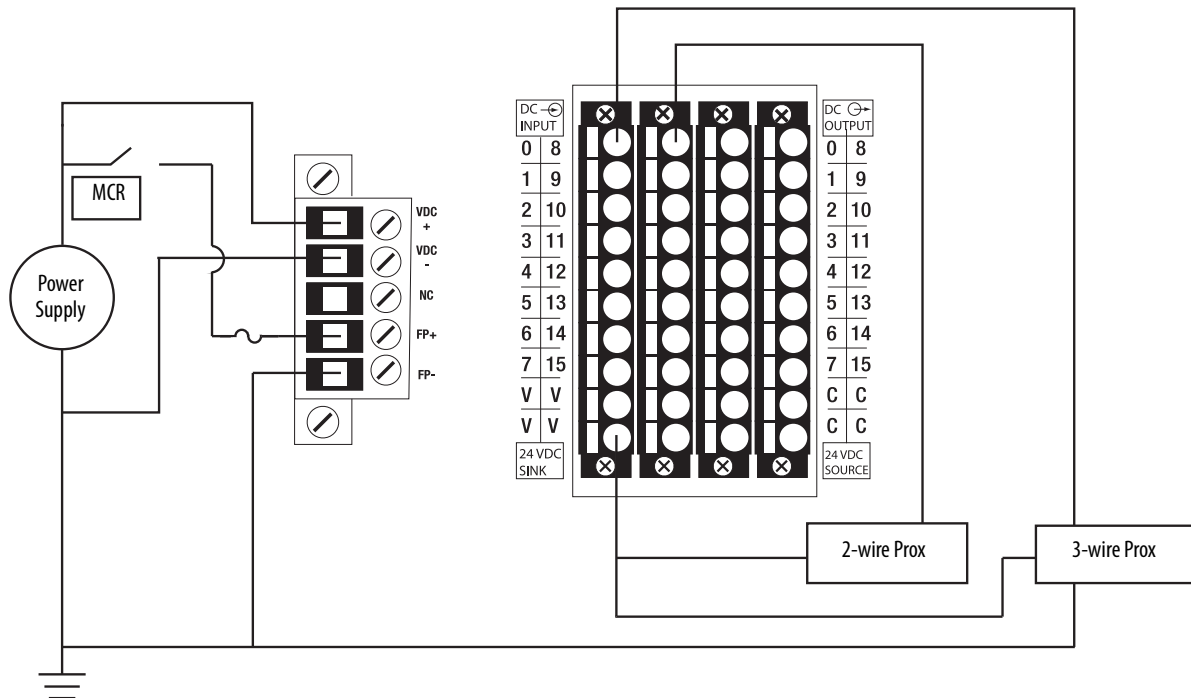

Figure 22 - CompactLogix 5370 L1 Controllers with Input Devices Powered by a V Terminal on Embedded I/O Module (Series B)



Embedded Output Points

The embedded output points on the CompactLogix 5370 L1 controllers support 2-wire systems. The embedded power supply in the controller powers the embedded output points over the POINTBus backplane.

The following graphic shows examples of how to connect 2-wire systems to embedded output points 0...7. The same wiring connections can be used with output points 8...15.

IMPORTANT Do not exceed the per point output current rating or the total output module current rating.

Figure 23 - CompactLogix 5370 L1 Controllers Embedded Digital Output Point Wiring Diagram

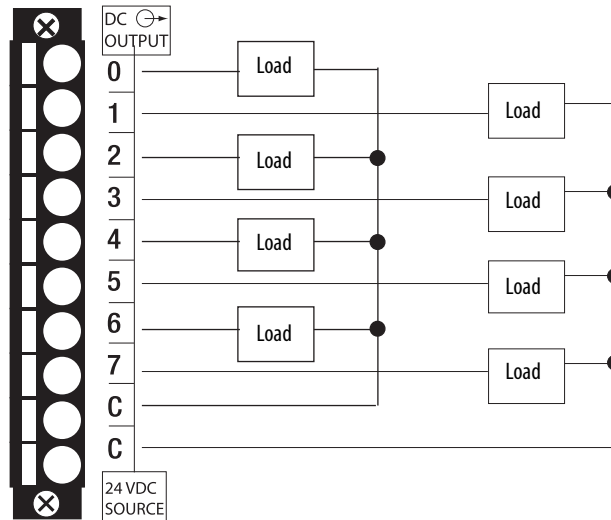

The following graphic shows an example of how to connect 2-wire systems to embedded output points 0...4 and use an external terminal block with a bus connector strip.

IMPORTANT Do not exceed the per point output current rating or the total output module current rating.

Figure 24 - CompactLogix 5370 L1 Controllers Embedded Digital Output Point Wiring Diagram

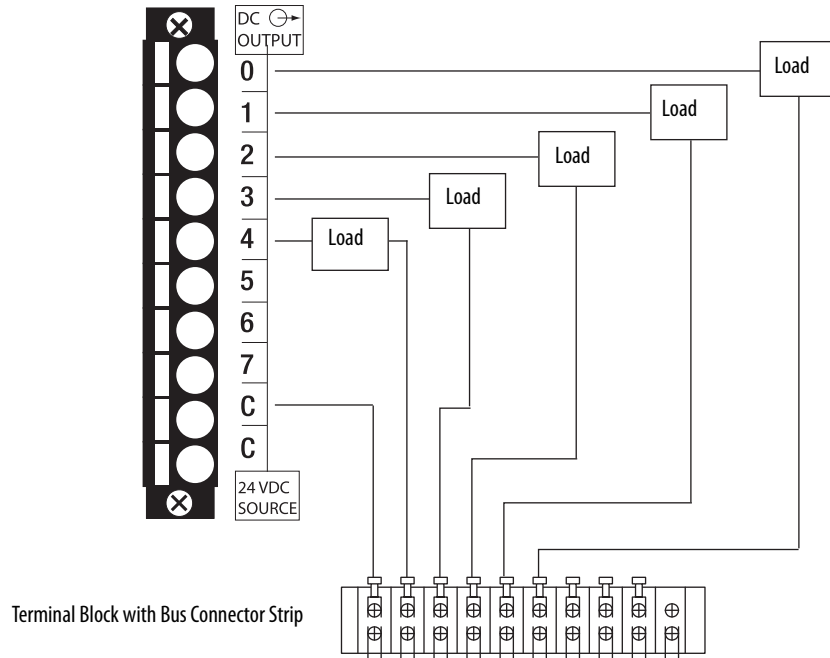

Local Expansion Modules

CompactLogix 5370 L1 controllers support the use of 1734 POINT I/O™ modules as local expansion modules along the POINTBus backplane.

IMPORTANT For a full description of how to use 1734 POINT I/O modules, see the POINT I/O Digital and Analog Modules and POINTBlock I/O Modules, publication [1734-UM001](#).

Consider the following when using local expansion modules:

- The controllers support this many local expansion modules.

Table 8 - Maximum 1734 POINT I/O Modules Available as Local Expansion Modules

Cat. No.	Local 1734 POINT I/O Modules Supported, max
1769-L16ER-BB1B	6
1769-L18ER-BB1B	8
1769-L18ERM-BB1B	
1769-L19ER-BB1B	

- You can use up to the maximum number of 1734 POINT I/O modules with the CompactLogix 5370 L1 controllers that are listed in [Table 8](#). This condition applies only as long as the total current drawn by the embedded I/O and local expansion modules does not exceed the available POINTBus backplane current of 1 A and field power current of 3 A.

IMPORTANT Do not put more than three of the 1734-IT2I or 1734-IR2 modules on the POINT I/O bus that draws power from the same power source. This restriction includes power sources such as from communication adapters or the 1734-EPAC or 1734-EP24DC expansion power supply modules. The inrush current exceeds the current limit of the DC to DC converter in the power source.

Based on the configuration of your application, you can use one of the following devices to make more POINTBus backplane current or field power current available:

- **1734-EP24DC POINT I/O Expansion Power Supply** - An expansion power supply is installed between embedded I/O modules and local expansion modules or between local expansion modules.

The expansion power supply breaks the available POINTBus backplane current between the modules to its left and right. With the expansion power supply installed, the modules to its left can draw up to 1 A of POINTBus backplane current. The modules to the right of the expansion power supply can draw as much current as is provided by the expansion power supply.

Additionally, the expansion power supply breaks the available field power current between the modules to its left and right. With the expansion power supply installed, the modules to its left can draw up to 3 A of field power current. The modules to the right of the expansion power supply can draw as much field power current as allowed by the expansion power supply.

For example, if you need six 1734-IR2 modules as local expansion modules for a 1769-L18ER-BB1B controller application, you must include the 1734-EP24DC expansion power supply in the local expansion-module installation.

For more information on the 1734-EP24DC expansion power supply, see the POINT I/O 24V DC Expansion Power Supply Installation Instructions, publication [1734-IN058](#).

- **1734-FPD POINT I/O Field Power Distributor Module** - A field power distributor module can also be installed between embedded I/O modules and local expansion modules or between local expansion modules.

The field power distributor module breaks the available field power current between the modules to its left and right. With the field power distributor module installed, the modules to its left can draw up to 3 A of field power current. The modules to the right of the field power distributor module can draw as much field power current as allowed by the field power distributor.

For more information on the 1734-FPD POINT I/O Field Power Distributor module, see the POINT I/O Field Power Distributor Module Installation Instructions, publication [1734-IN059](#).

IMPORTANT Remember, the field power distributor module changes only the level of field power current available in the system. It does not affect the level of POINTBus backplane current available.

- You must connect an external 24V DC power source to the FP+ and FP- terminals on the removable connector on the controller. This connection provides power to input and output devices that are connected to the local expansion modules.
 - Series A controllers require an extra external 24V DC power source for the FP+ and FP- terminal connections. For more information on how to connect an extra external power source for series A L1 controller to the FP+ and FP- terminals, see [Appendix C](#).
 - Series B controllers use the external 24V DC power source that is connected to the VDC+ and VDC- terminals on the controller for the FP+ and FP- terminal connections. Series B controllers can also use an extra external 24V DC power source for the FP+ and FP- terminal connections.

IMPORTANT Install a user-replaceable fuse with overcurrent protection of 4...6 A in line between the incoming power and the FP+ terminal.

The field-side power requirement of the local expansion modules of the controller is 24V DC nominally with an input range of 10...28.8V DC.

For more information on how to connect a power source to the FP+ and FP- terminals, see [page 144](#).

- We **recommend** that you update all 1734 POINT I/O modules designated as local expansion modules to the most current firmware revision before installing them in a CompactLogix 5370 L1 system.
- The available RPI range of each local expansion module is 1.0...750.0 ms and can be changed by 0.5 ms increments. The default setting is module-dependent.

You can configure RPI values for each local expansion module in your control system. However, the complete I/O configuration has an impact on the rate at which data is transmitted in a CompactLogix 5370 L1 control system. For more information, see [Estimate Requested Packet Interval on page 164](#).

- Before installing a 1734 POINT I/O module into a CompactLogix 5370 L1 control system, make sure the I/O module is set to Autobaud. 1734 POINT I/O modules are set to Autobaud by default.

If you must return a 1734 POINT I/O module to Autobaud, see the POINT I/O Digital and Analog Modules and POINTBlock I/O Modules, publication [1734-UM001](#).

- When possible, use specialty 1734 POINT I/O modules to meet unique application requirements.
- Make sure that there are no empty slots between the controller and local expansion modules or between local expansion modules.
- The Expansion I/O parameter in the project of the controller must match the number of local expansion modules that are installed in the system. This requirement is so the controller can establish connections to the local expansion modules.
- You must use a 1734-232ASC, firmware revision 4.002 or later, to access an RS-232 network in your CompactLogix 5370 L1 controller application.

IMPORTANT Field power is required for the 1734-232ASC module. The module cannot receive adequate power without the application of field power.

Distributed I/O Modules over an EtherNet/IP Network

You can include distributed I/O modules over an EtherNet/IP network in your CompactLogix 5370 L1 control system.

Consider the following when using distributed I/O modules over an EtherNet/IP network:

- Each remote EtherNet/IP adapter included in the system must be counted toward the maximum number of EtherNet/IP nodes of the controller.

For more information on maximum number of EtherNet/IP nodes, see [Nodes on an EtherNet/IP Network on page 123](#).

- The configurable RPI settings vary depending on which distributed I/O modules are used in the system.
- To add distributed I/O modules to your CompactLogix 5370 L1 control system, see [Configure Distributed I/O Modules on an EtherNet/IP Network on page 174](#).

The following graphic shows a CompactLogix 5370 L1 control system that uses all three I/O module options.

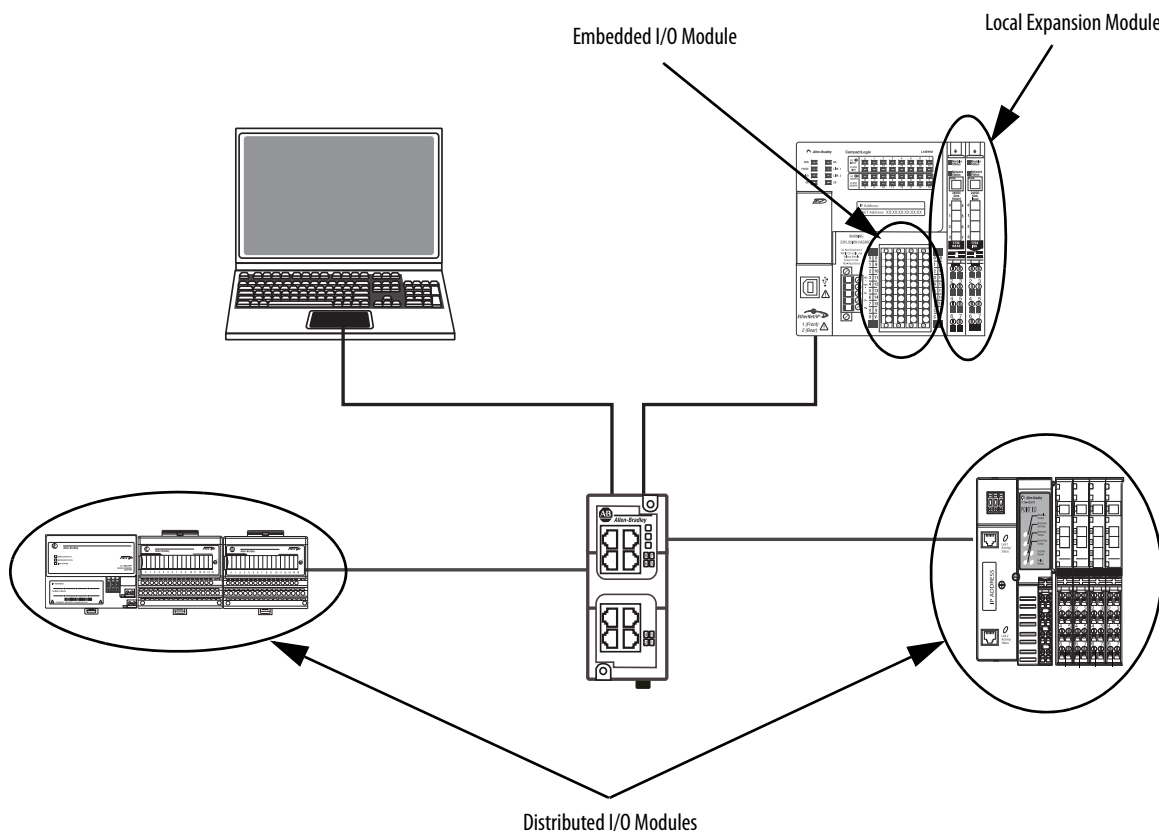

Validate I/O Layout

You must validate the layout of 1734 POINT I/O modules in your CompactLogix 5370 L1 control system. Consider these points when validating I/O layout placement:

- [Set the Number of Local Expansion Modules](#)
- [Empty Slots and Removal and Insertion Under Power Situations](#)
- [Estimate Requested Packet Interval](#)
- [Module Faults Related to RPI Estimates](#)
- [Physical Placement of I/O Modules](#)

Set the Number of Local Expansion Modules

You must specify the number of local expansion modules a CompactLogix 5370 L1 control system requires when creating a project or when you change the number of local expansion modules. This graphic depicts the module selection.

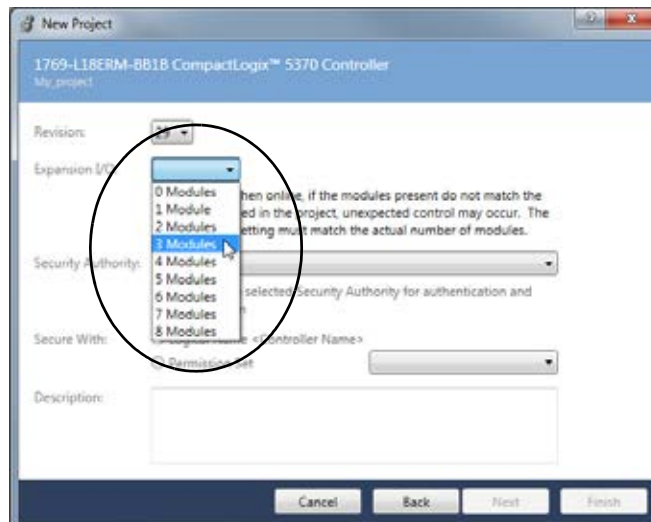

Each time the controller is powered up, it compares the number of local expansion modules present on the POINTBus backplane to the Expansion I/O value. The controller does not allow any I/O connections until the number of local expansion modules present equals the Expansion I/O value.

Empty Slots and Removal and Insertion Under Power Situations

The POINT I/O system cannot detect an empty terminal base. For this reason, there are numerous situations in which you can potentially configure a system that is unusable or one that exercises unintended control.

Follow these rules for I/O system configuration and RIUP of I/O modules.



WARNING: If you insert or remove the module while backplane power is on, an electrical arc can occur. This could cause an explosion in hazardous location installations.

Be sure that power is removed or the area is nonhazardous before proceeding.

IMPORTANT 1734 POINT I/O modules support RIUP in CompactLogix 5370 L1 control systems.

- A correct I/O system does not have any empty terminal bases. If necessary, you can use a 1734-ARM POINT I/O Address Reserve module to replace a 1734 POINT I/O module in a CompactLogix 5370 control system.
- After you cycle power, the controller only enables I/O connections if the number of local expansion modules present on POINTBus matches the value that is used for the Expansion I/O parameter in the project.
- If a 1734 POINT I/O module is removed under power, the operation of the other I/O modules is not disrupted.
- When you remove an I/O module that has an active connection from the controller, the controller I/O status indicator flashes green to indicate the condition.

IMPORTANT If you enabled the 'Major Fault On Controller If Connection Fails While in Run Mode' parameter when configuring the module in the Studio 5000® environment project, removal of the module causes the controller to transition to a major fault condition.

- If multiple contiguous modules are removed under power, connections to all modules in the contiguous missing module set are disallowed until all modules are replaced. The controller cannot detect an empty base. Therefore, it does not know the physical positioning of the modules until all missing modules are replaced.
- If a module that separates two sets of contiguous missing modules is removed, the two sets merge into one set. All modules must be replaced before connections are permitted to any module in the set.
- If modules of different types are removed and returned to the wrong locations, attempts to connect to these modules fail during verification of Electronic Keying.

IMPORTANT If Electronic Keying is set to Disable Keying, no verification of electronic keying occurs and unintended control can occur.

- If modules of the same type are removed and returned to the wrong locations, they accept connections from the controller. The modules also reconfigure with the correct data once they pass their electronic keying check.

Estimate Requested Packet Interval

The requested packet interval (RPI) defines the frequency at which the controller sends data to and receives data from I/O modules. You set an RPI rate for each I/O module in your system.

The CompactLogix 5370 L1 controllers attempt to scan an I/O module at the configured RPI rate. For individual I/O modules, a [Module RPI Overlap](#) minor fault occurs if there are enough I/O modules with RPI rates set too fast that they cannot all be serviced in the allotted interval.

The configuration parameters for a system determine the impact on actual RPI rates. These configuration factors can affect the effective scan frequency for any individual module:

- Other 1734 POINT I/O module RPI rate settings
- Number of other 1734 POINT I/O modules in the system
- Types of other 1734 POINT I/O modules in the system
- Application user task priorities

In general, follow these guidelines when setting the RPI rates in a CompactLogix 5370 L1 control system:

- For **digital** I/O modules:
 - 1...2 modules can be scanned in 2 ms.
 - 3...4 modules can be scanned in 4 ms.
 - 5...8 modules can be scanned in 8 ms.

IMPORTANT When considering digital I/O modules, remember that they can be the embedded I/O module on the controller or 1734 POINT I/O modules that are used as Local Expansion Modules. Therefore, the consideration for using two modules can be the embedded I/O module and a 1734 POINT I/O module or two 1734 POINT I/O modules.

- For **specialty and analog** I/O modules (except 1734-485ASC modules):
 - One module can be scanned at 20 ms.
 - For each additional module, add 20 ms.For example, if a CompactLogix 5370 L1 control system uses two analog modules, the module can be scanned in 40 ms.
- For **1734-485ASC** modules, the total data size for all ASC modules determines the RPI rates:
 - For total data size less than 20 bytes, each module can be scanned in 20 ms.
 - For data size greater than 20 bytes, use the size value as the RPI.For example, if the total data size is 40 bytes, each ASC module can be scanned in 40 ms.

You are not required to set individual RPI values of 1734 POINT I/O modules to the values listed previously. For example, if your application scans one or two modules, you do not have to use RPI rates of 2 ms. Remember, though, that higher RPI rates result in less frequent data scans.

The RPI shows how quickly modules can be scanned, not how quickly an application can use the data. The RPI is asynchronous to the program scan. Other factors, such as program execution duration, affect I/O throughput.

Module Faults Related to RPI Estimates

When following the guidelines described on [page 165](#), most CompactLogix 5370 L1 control systems operate as expected.

Some systems that follow the guidelines can experience minor faults that are described in the following table.

Name	Fault Information	Condition In Which Fault Occurs
Module RPI Overlap	(Type 03) I/O fault (Code 94) Module RPI overlap detected Module Slot = x , where x is the slot number of the I/O module in the I/O Configuration section	This fault is logged when the current RPI update of an I/O module overlaps with its previous RPI update. The Minor Faults tab in the Controller Properties dialog box indicates which module the RPI overlaps. If multiple I/O modules experience the fault, the application indicates that the fault occurred on the first such I/O module. Typically, it is an I/O module with a lower RPI rate and/or an I/O module with large input/output data sizes. For example, the 1734-232ASC and 1734-485ASC modules use large input/output data sizes. Once the fault is cleared from the first I/O module, the application indicates the next module that experiences the fault. This pattern continues until the fault is cleared from all affected I/O modules. To avoid this fault, set the RPI rate of the I/O modules to a higher numerical value.

Calculate System Power Consumption

An embedded 24V DC nominal, non-isolated power supply with an input range of 10...28.8V DC powers the CompactLogix 5370 L1 control system.

The embedded power supply provides 1 A @ 5V DC to the POINTBus backplane to power all system components, including local expansion modules, in most system configurations. Local expansion modules include 1734 POINT I/O modules.

In some circumstances, you can configure a system that requires more current than the embedded power supply of the system provides. This type of configuration results from using a combination of local expansion modules that, when combined with current consumption of the rest of the system, exceeds 1 A @ 5V DC.

In this case, you can take any of the following actions to make sure that your system configuration has enough power:

- Insert a 1734-EP24DC POINT I/O expansion power supply between local expansion modules to increase the POINTBus backplane power.
- Insert a 1734-FPD POINT I/O Field Potential Distribution module between local expansion modules to renew field power or change the field power from DC to AC. The Field Potential Distribution module separates DC I/O modules from AC I/O modules on the same POINTBus.

IMPORTANT The 1734-FPD POINT I/O Field Power Distributor is required if the devices connected to the local expansion modules consume more than 3 A.

Physical Placement of I/O Modules

Before you physically install the I/O modules, you must assemble, mount, and ground the system as described in Chapter 2, [Install the CompactLogix 5370 L1 Controller on page 23](#).

Use the Event Task

The CompactLogix 5370 L1 controllers support the use of an Event task with their embedded input points. You can configure embedded input point terminals to trigger an Event task if a change of state (COS) occurs.

-
- IMPORTANT** When using the Event task with the CompactLogix 5370 L1 controllers, consider these points:
- You can use the Event task only with Logix Designer application, version 21.00.00 and later.
 - You can use the Event task only with the embedded input points of the controller. You cannot use the Event task with input points in the local expansion modules, for example, a 1734-IB4 module.
 - You can use the Event task only if the input point has an input data state change.
 - An event is recognized only when it maintains the same state for at least the duration of the input filter time specified.
 - Configure the Event task at a rate that stops task overlap conditions.
 - Configure the Event task at a rate that is likely to succeed.
- A 2 ms signal width is the minimum pulse width that can be used at which the Event task succeeds.
-

You can configure multiple embedded input points to trigger an Event task. However, we recommend that you enable COS for only one point. If you enable COS for multiple points, a task overlap of the Event task can occur.

You can configure an Event task to trigger if one of these events occurs:

- An event occurs on one point on an input module.
- A trigger event does not occur in a time interval.

You configure whether the task updates output modules at the end of the task. After the task executes, it does not execute again until the event occurs again. Each Event task requires a trigger.

This table describes the triggers for an Event task available in a CompactLogix 5370 L1 control system.

Trigger	Description
Input Data State Change	The input point triggers the Event task that is based on the change of state (COS) configuration for the point. The COS configuration is set on the Module Definition dialog box.
Consumed Tag	Only one consumed tag can trigger an Event task. Use an Immediate Output (IOT) instruction in the producing controller to signal the production of new data.
Axis Registration 1 or 2	A registration input triggers the Event task.
Axis Watch	A watch position triggers the Event task.
Motion Group Execution	The coarse update period for the motion group triggers the execution of the motion planner and the Event task. Because the motion planner interrupts all other tasks, it executes first.
EVENT Instruction	Multiple EVENT instructions can trigger the same task.

For more information on Event tasks, see the following publications:

- Logix5000™ Controllers Common Procedures Programming Manual, publication [1756-PM001](#)
- Using Event Tasks with Logix5000 Controllers, publication [LOGIX-WP003](#)

Complete the following steps to configure the Event task.

1. Open the project.
2. Right-click Embedded Discrete_IO and choose Properties.

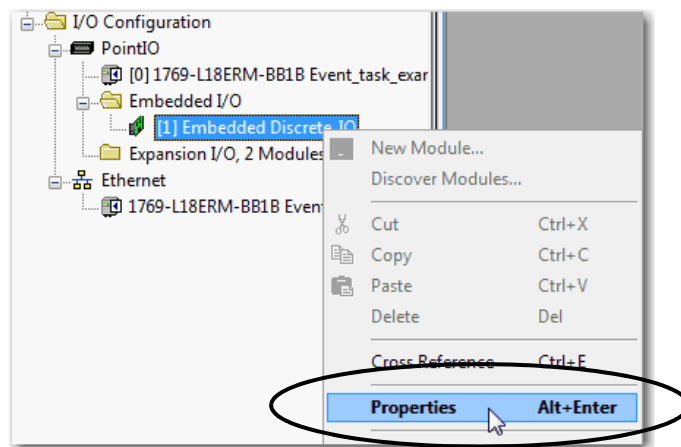

3. On the Module Properties dialog box, complete the following steps.
 - a. Click the Input Configuration tab.
 - b. Enable COS for the digital input points on which a state change, that is, Off to On or On to Off, triggers the Event task.
 - c. Set the desired input filter time for each COS-enabled input point.

IMPORTANT An event is recognized only when it maintains the same state for at least the duration of the input filter time specified.

- d. Click OK.

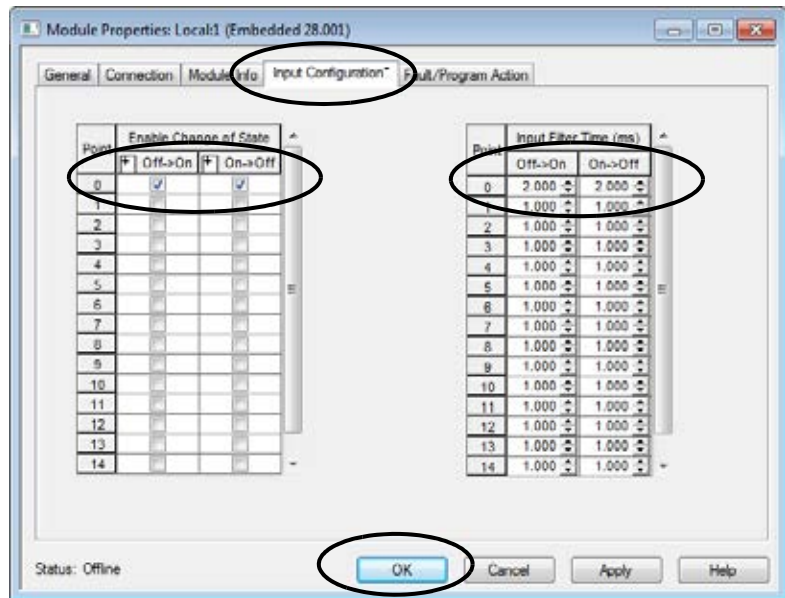

4. Right-click Tasks and choose New Task.

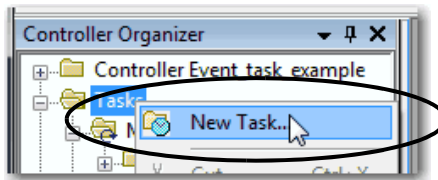

5. On the New Task dialog box, complete the following steps.
 - a. Name the task.
 - b. Change the task type to Event.
 - c. Choose the trigger.
 - d. Select the tag.
 - e. If desired, set a time so the Event task executes if no event occurs with the value.
On the following example dialog box, the time is 10 ms. If no event occurs for 10 ms, the Event task executes.
 - f. Set the task priority.
The default Event task priority level is 10. For more information about Event tasks, see *Using Event Tasks with Logix5000 Controllers* white paper, [LOGIX-WP003](#).
 - g. Make more desired configuration changes.
 - h. Click OK.

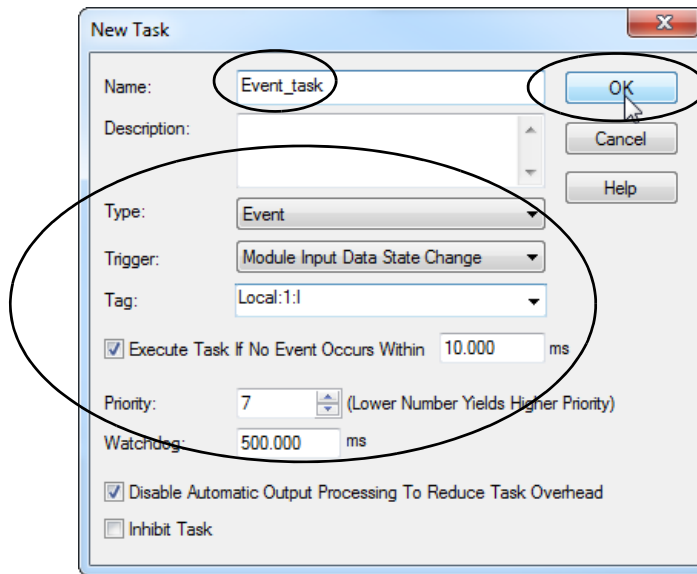

The new Event task appears in the Controller Organizer.

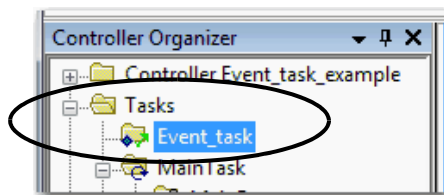

Configure I/O

Complete these steps to add a 1734 POINT I/O module to your CompactLogix 5370 L1 control system.

1. Right-click PointIO and choose New Module.

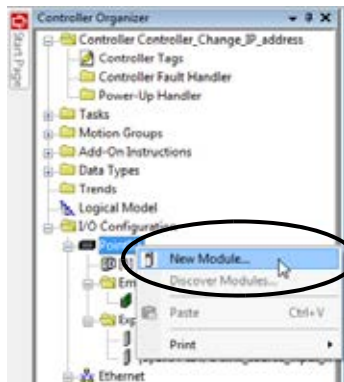

You can also right-click Expansion I/O.

2. Select the desired I/O module and click Create.

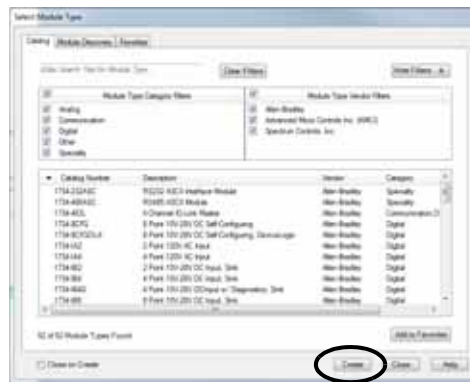

The New Module dialog box appears.

3. Configure the new I/O module as necessary and click OK.

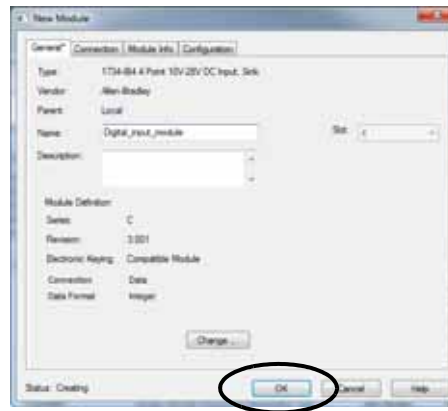

Common Configuration Parameters

While the configuration options vary from module to module, there are some common options you typically configure when using 1734 POINT I/O modules in a CompactLogix 5370 L1 control system, as described in [Table 9](#).

Table 9 - Common Configuration Parameters

Configuration Option	Description
Requested packet interval (RPI)	<p>The RPI specifies the interval at which data is transmitted or received over a connection. For POINTBus backplane local expansion modules, data is transmitted to the controller at the RPI.</p> <p>When scanned on the local bus or over an EtherNet/IP network, I/O modules are scanned at the RPI specified in the module configuration. Typically, you configure an RPI in milliseconds (ms).</p> <ul style="list-style-type: none"> For local expansion modules, the range is 1.0...750 ms and the RPI must be configured in 0.5 ms increments. That is, you cannot set the RPI to a value of 2.3 ms. It must be 2.0 or 2.5. For remote I/O modules over an EtherNet/IP network, the range is 2.0...750 ms and the RPI must be configured in 1.0 ms increments. That is, you cannot set the RPI to a value of 2.3 ms. It must be 2.0 or 3.0.
Module definition	<p>Set of configuration parameters that affect data transmission between the controller and the I/O module. The parameters include the following:</p> <ul style="list-style-type: none"> Series - Hardware series of the module. Revision - Major and minor firmware revision levels that are used on the module. Electronic Keying - See LOGIX-AT001 for Electronic Keying information. Connection - Type of connection between the controller that writes the configuration and the I/O module, such as Output. Data format - Type of data that is transferred between the controller and I/O module and what tags are generated when the configuration is complete.
Major Fault on Controller If Connection Fails While in Run Mode	<p>This option determines how the controller is affected if the connection to an I/O module fails in Run mode or if the controller is unable to establish a connection to the module. You can configure the project so that a connection failure causes a major fault on the controller or not. The default setting is for the option to be disabled.</p> <p>For example, if this option is enabled and an I/O module is removed while in Run mode, a major fault occurs on the controller. The default setting for the embedded I/O module is that this option is enabled. The default setting for local expansion modules is that this option is disabled.</p>

I/O Connections

A CompactLogix 5370 L1 control system uses connections to transmit I/O data. [Table 10](#) describes the connection types.

IMPORTANT You can only use direct connections with the local expansion modules in a CompactLogix 5370 L1 control system.

Table 10 - I/O Module Connections

Connection	Description
Direct	A direct connection is a real-time, data-transfer link between the controller and an I/O module. The controller maintains and monitors the connection. Any break in the connection, such as a module fault, causes the controller to set fault status bits in the data area that is associated with the module. Typically, analog I/O modules, diagnostic I/O modules, and specialty modules require direct connections.
Rack-optimized	Rack-optimized connections are not available with local expansion modules used in CompactLogix 5370 L1 control systems. For digital I/O modules, you can select rack-optimized connections. This option is used with distributed I/O modules and the Rack Optimization connection selection is made when configuring the remote adapter. For example, if you want to use a rack-optimized connection with digital I/O modules in a remote 1734 POINT I/O system, you configure the 1734-AENT(R) module to use a connection type of Rack Optimization. A rack-optimized connection consolidates connection usage between the controller and all digital I/O modules in a remote chassis or on one DIN rail. Rather than having individual, direct connections for each I/O module, there is one connection for the entire rack (or DIN rail).

Configure Distributed I/O Modules on an EtherNet/IP Network

Your CompactLogix 5370 L1 control system can use distributed I/O modules on an EtherNet/IP network.

IMPORTANT When adding distributed I/O modules, remember to count the remote Ethernet adapter to remain within the maximum number of EtherNet/IP network nodes limitation for your controller.

The distributed I/O modules that are connected to the controller via the remote Ethernet adapter are not counted toward the maximum Ethernet node limit for the controller.

For example, a 1769-L16ER-BB1B controller supports up to four Ethernet nodes. You can add up to four remote Ethernet adapters to the I/O Configuration section because each remote adapter counts against the node count. However, you can add as many remote I/O modules to the chassis of the adapter as necessary. Remote I/O modules do not count against the node count.

For more information on node limitations, see [Nodes on an EtherNet/IP Network on page 123](#).

Complete these steps to configure distributed I/O modules on an EtherNet/IP network.

1. Right-click Ethernet and choose New Module.

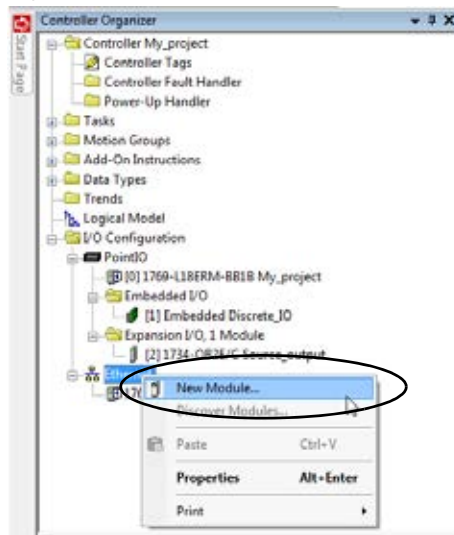

2. Select the desired Ethernet adapter and click Create.



The New Module dialog box appears.

3. Configure the new Ethernet adapter as necessary and click OK.



4. Right-click the new adapter and choose New Module.

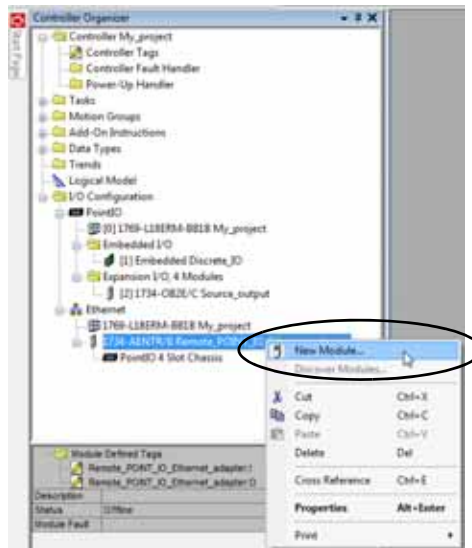

5. Select the desired I/O module and click Create.



The New Module dialog box appears.

6. Configure the new I/O module as necessary and click OK.

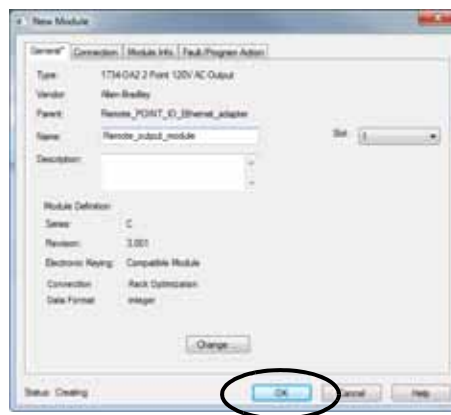

7. Repeat these steps to add all desired distributed I/O modules to the project.

The following graphic is an example of a 1769-L18ERM-BB1B control system that uses distributed I/O modules over an EtherNet/IP network.

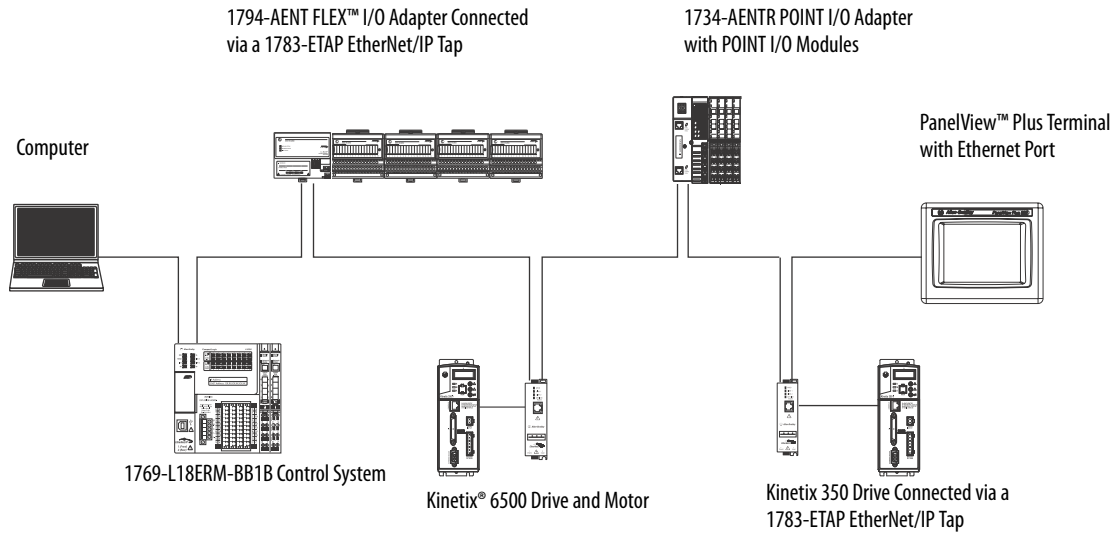

Monitor I/O Modules

With CompactLogix 5370 L1 controllers, you can use the following options to monitor I/O modules:

- QuickView™ Pane below the Controller Organizer
- Connection tab in the Module Properties dialog box
- Programming logic to monitor fault data so you can act

When a fault occurs on an I/O module, a yellow triangle on the module listing in the Controller Organizer alerts you to the fault.

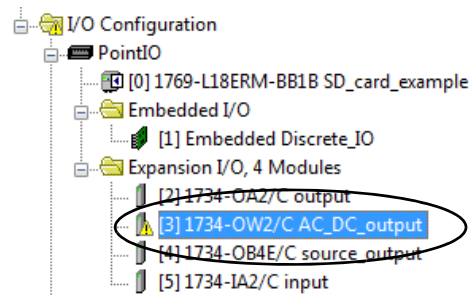

The following graphic shows the **Quick View Pane**, which indicates the type of fault.

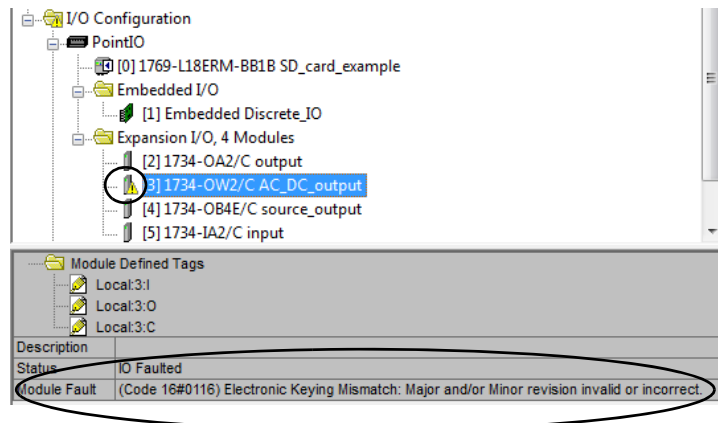

To see the fault description on the **Connection tab** in Module Properties dialog box, complete these steps.

1. In the I/O Configuration, right-click the faulted I/O module and choose Properties.

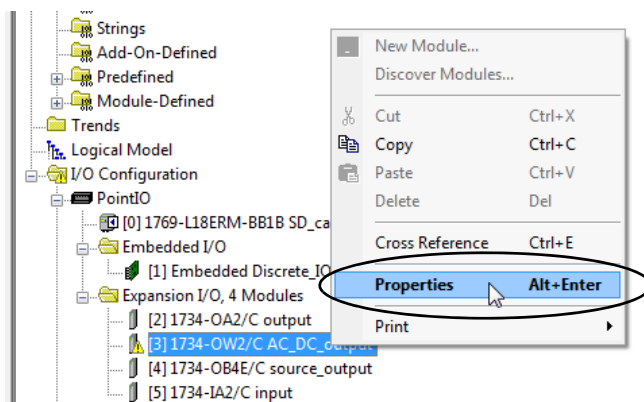

- Click the Connection tab and use the fault description, in the Module Fault section, to diagnose the issue.

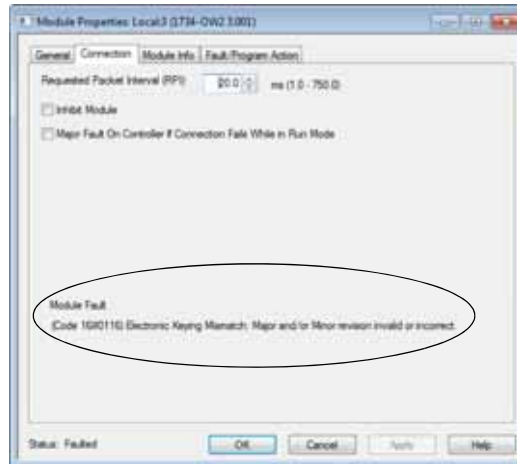

- Click OK to close the dialog box and remedy the issue.

Bus Off Detection and Recovery

When the POINTBus backplane experiences a bus off condition, the CompactLogix 5370 L1 controller indicates this condition via a BUS OFF minor fault (Type 03, Code 01). When this fault occurs, the connections between the controller and I/O modules are broken.

Complete these steps to identify the source of the BUS OFF minor fault.

- Make sure the number of local expansion modules in the project matches the number of modules that are physically installed in the system.
- Make sure that all mounting bases are locked and I/O modules are securely installed on mounting bases.
- Make sure all 1734 POINT I/O modules are configured to use the Autobaud rate.

IMPORTANT You cannot change the Autobaud setting for a 1734 POINT I/O when the module is installed in a CompactLogix 5370 L1 control system. If you must return a 1734 POINT I/O module to Autobaud, see the POINT I/O Digital and Analog Modules and POINTBlock I/O Modules, publication [1734-UM001](#).

If these steps do not remedy the fault condition, contact Rockwell Automation® technical support.

Notes:

Use I/O Modules with CompactLogix 5370 L2 Controllers

This chapter explains how to use I/O modules in a CompactLogix™ 5370 L2 control system.

Topic	Page
Select I/O Modules	181
Embedded Analog I/O Modules Data Arrays	202
Validate I/O Layout	217
Configure Local I/O Modules	223
Configure Distributed I/O Modules on an EtherNet/IP Network	226
Configure Distributed I/O Modules on an EtherNet/IP Network	226
Configure Distributed I/O Modules on a DeviceNet Network	230
Monitor I/O Modules	232

Select I/O Modules

CompactLogix 5370 L2 control systems offer these I/O module options:

- [Embedded I/O Modules](#)
- [Local Expansion Modules - Optional](#)
- [Distributed I/O Modules over an EtherNet/IP Network](#)

Embedded I/O Modules

CompactLogix 5370 L2 controllers provide embedded I/O modules. The catalog number determines the number and type of points. This table describes which embedded I/O modules CompactLogix 5370 L2 controllers support.

Cat. No.	Sinking/Sourcing 24V DC Digital Input Points	Sinking 24V DC Digital Output Points	High-speed Counters	High-speed Counter Output Points	Universal Analog Input Points	Analog Output Points
1769-L24ER-QB1B	16	16	-	-	-	-
1769-L24ER-QBFC1B			4	4	4	2
1769-L27ERM-QBFC1B						

IMPORTANT Remember the following when using the embedded I/O modules on CompactLogix 5370 L2 controllers:

- 1769-L24ER-QB1B controller - The digital input points and digital output points are on one embedded I/O module. Therefore, the 1769-L24ER-QB1B controller is considered to have one embedded I/O module.
- 1769-L24ER-QBFC1B and 1769-L27ERM-QBFC1B controllers - The digital input points and digital output points are on one embedded I/O module. The high-speed counter input/output points, universal analog input points, and analog output points are on another single embedded I/O module. Therefore, the 1769-L24ER-QBFC1B and 1769-L27ERM-QBFC1B controllers are considered to have two embedded I/O modules.

You configure an RPI rate for the embedded I/O modules to establish time intervals at which data is transmitted between the controller and each embedded I/O point. The available RPI range of the embedded I/O points is 0.5...750.0 ms and can be changed by 0.5 ms increments. The default setting is 20 ms.

- IMPORTANT**
- If you attempt to use an RPI value that is not valid, the application automatically rounds the value down to the closest 0.5 ms increment when you apply the change.
For example, if you set the RPI = 1.75 ms, when you click Apply or OK, the value is rounded down to 1.5 ms and applied.
 - The RPI value for an embedded I/O module is intended to establish a time interval at which data is transmitted. However, the configuration of your CompactLogix 5370 L2 control system can affect the actual time interval of data transmission.
For more information, see [Estimate Requested Packet Interval on page 217](#).

Embedded Digital I/O Points

The embedded digital I/O module on CompactLogix 5370 L2 contains 16 24V DC sinking inputs and 16 24V DC sourcing outputs. The inputs can be configured to use digital filtering by input group. Filter times can be specified for OFF to ON and ON to OFF.

Group 0 is used to configure inputs 0...7. Group 1 is used to configure inputs 8...15. The default filter time for each group is 8 ms. You can the filter times to 0.0 ms, 0.1 ms, 0.5 ms, 1.0 ms, 2.0 ms, and 4.0 ms, as shown in this graphic.

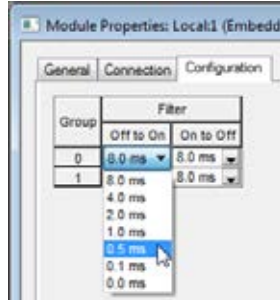

Figure 25 shows the embedded digital I/O points of the CompactLogix 5370 L2 controllers.

IMPORTANT Figure 25 shows the embedded digital I/O points on the 1769-L24ER-QB1B controller. The embedded digital I/O points on the 1769-L24ER-QBFC1B and 1769-L27ERM-QBFC1B controllers are organized and wired the same.

Figure 25 - CompactLogix 5370 L2 Controllers Embedded Digital I/O Module Wiring Termination Points

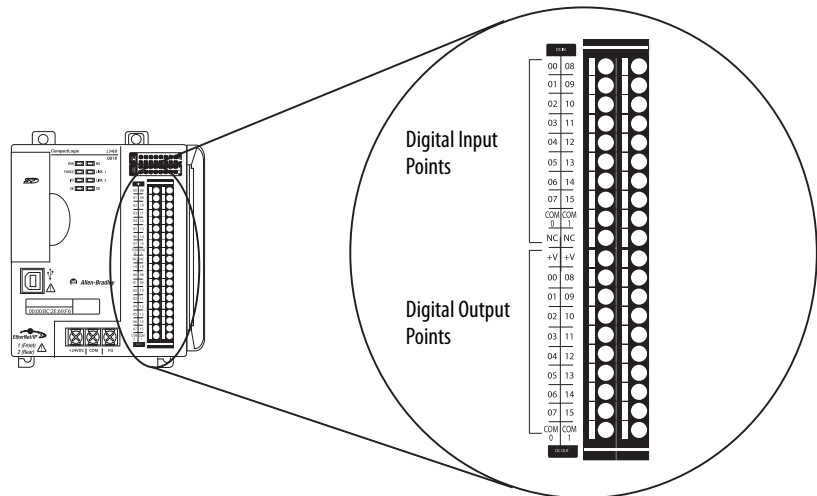

Figure 26 shows an example wiring diagram for the embedded digital input points.

Figure 26 - CompactLogix 5370 L2 Controllers Embedded Digital Input Point Wiring Diagram

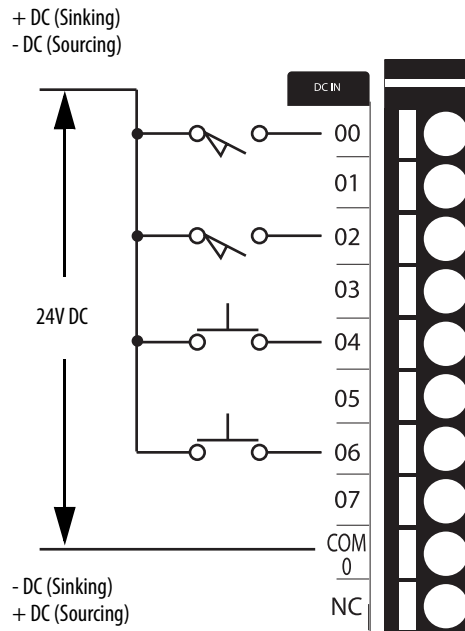
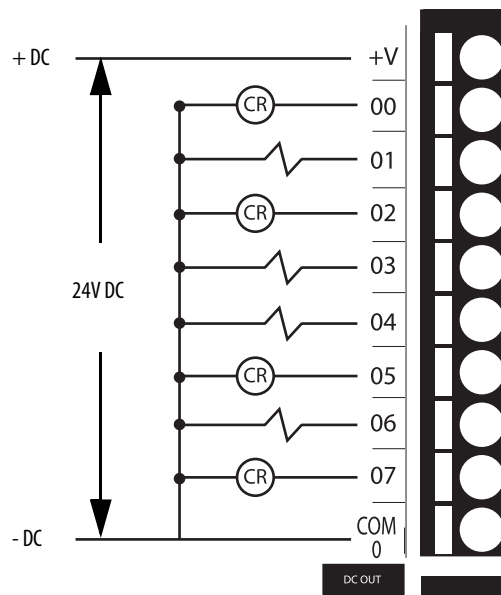

Figure 27 shows an example wiring diagram for the embedded digital output points.

Figure 27 - CompactLogix 5370 L2 Controllers Embedded Digital Output Point Wiring Diagram



Embedded Analog I/O Points

IMPORTANT The embedded analog I/O points are available on only the 1769-L24ER-QBFC1B and 1769-L27ERM-QBFC1B controllers.

The 1769-L24ER-QBFC1B and 1769-L27ERM-QBFC1B controllers support four embedded universal analog inputs that can function as differential or single-ended inputs. This capability applies only if you do not use RTDs. If you use RTDs in your system, you can use up to two RTDs or a combination of one RTD and two universal analog inputs. The 1769-L24ER-QBFC1B and 1769-L27ERM-QBFC1B controllers also support two embedded standard analog outputs that can function as single-ended outputs. The inputs and outputs are considered channels. Each channel configuration offers multiple configuration options.

[Table 11](#) lists the available embedded analog input channel types and ranges for the channel type. The configuration choices are made on the Input Configuration tab of the Module Properties dialog box, as shown in [Table 11](#).

Table 11 - Input Types

Input Type	Input Ranges	Project Configuration
Voltage	<ul style="list-style-type: none"> Type -50...50 mV Type -100...100 mV 0...5V 1...5V 0...10V -10V...10V 	
Current	<ul style="list-style-type: none"> 0...20 mA 4...20 mA 	
Thermocouple	<ul style="list-style-type: none"> J K at 1370...1372 °C (2498...2501.6 °F) K at -200...1370 °C (-328...2498 °F) T E S and R at 0...1768 °C (32...3214.4 °F) S and R at -50...0 °C (-58...32 °F) B at 300...1820 °C (572...3308 °F) B at 250...300 °C (482...572 °F) N C 	
RTD	<ul style="list-style-type: none"> 100 Ω Platinum 385 200 Ω Platinum 385 500 Ω Platinum 385 1000 Ω Platinum 385 100 Ω Platinum 3916 200 Ω Platinum 3916 500 Ω Platinum 3916 1000 Ω Platinum 3916 10 Ω Copper 426 120 Ω Nickel 618 120 Ω Nickel 672 604 Ω Nickel-Iron 518 	
Resistance	<ul style="list-style-type: none"> 0...150 Ω 0...500 Ω 0...1000 Ω 0...3000 Ω 	

[Figure 28](#) shows the embedded analog I/O points and how each termination point is used with different analog input types.

IMPORTANT [Figure 28](#) shows the embedded analog I/O points on the 1769-L27ERM-QBFC1B controller. The embedded analog I/O points on the 1769-L24ER-QBFC1B and 1769-L27ERM-QBFC1B controllers are organized and wired the same.

Figure 28 - 1769-L27ERM-QBFC1B Controller Embedded Analog I/O Wiring Termination Points

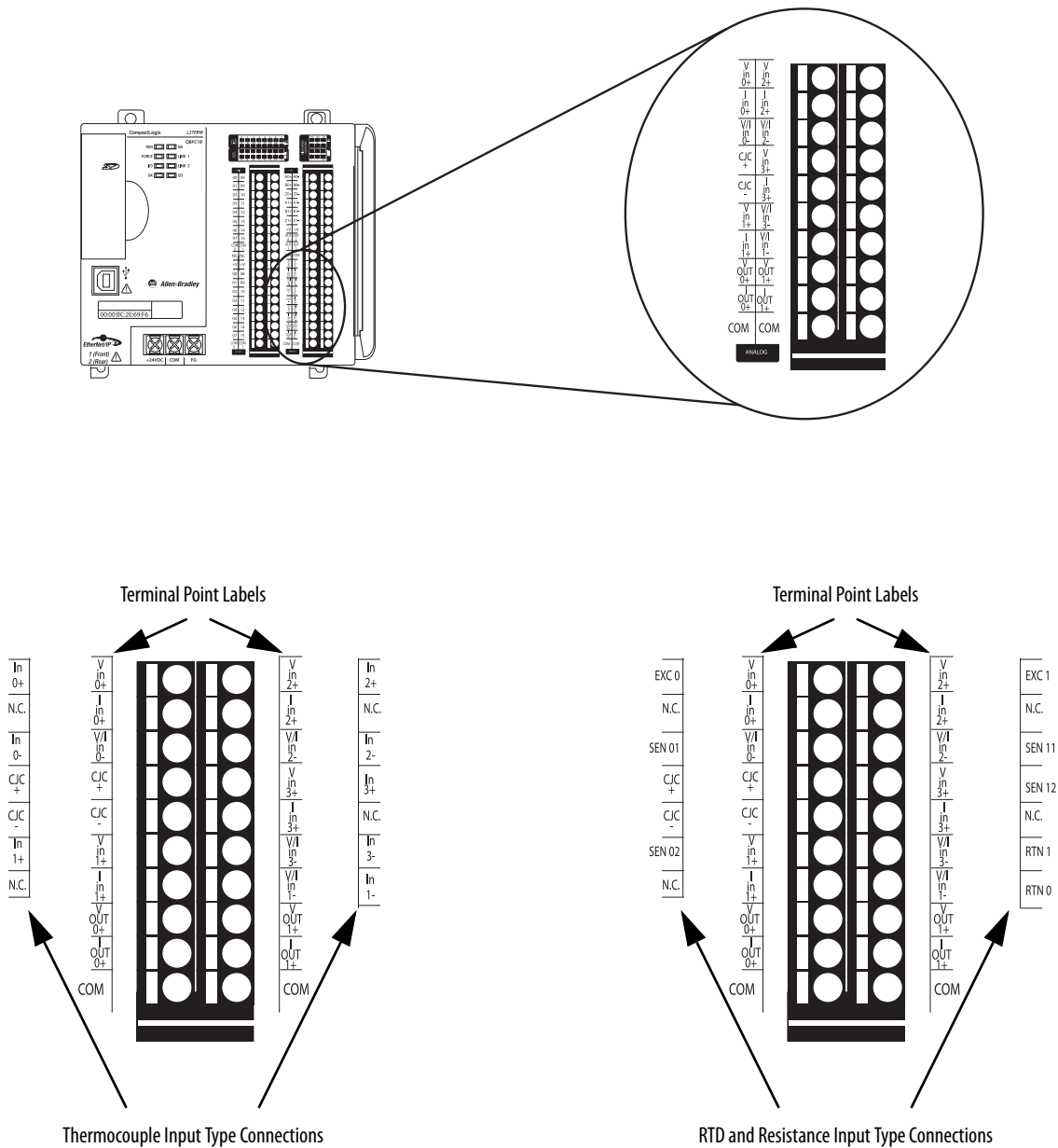
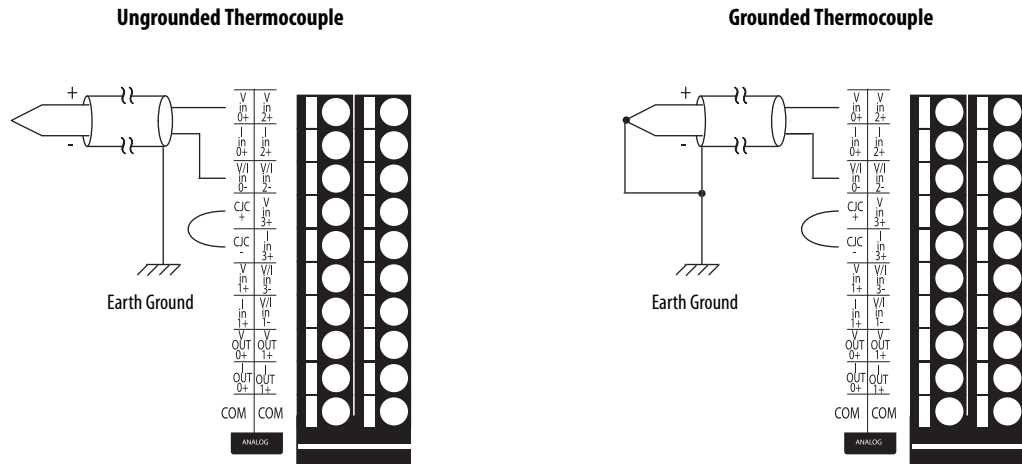

Figure 29 shows an example of ungrounded and grounded thermocouple wiring diagrams on a 1769-L27ERM-QBFC1B controller.

Figure 29 - 1769-L27ERM-QBFC1B Controller Thermocouple Wiring Diagrams



IMPORTANT: You must order Cold Junction Connectors, catalog number 1769-CJC, separately from the CompactLogix 5370 L2 controllers.

Figure 30 shows an example of devices with differential connections wired to the embedded analog inputs on a 1769-L27ERM-QBFC1B controller when it is operating with voltage or current input types.

Figure 30 - 1769-L27ERM-QBFC1B Controller Differential Connections Diagrams

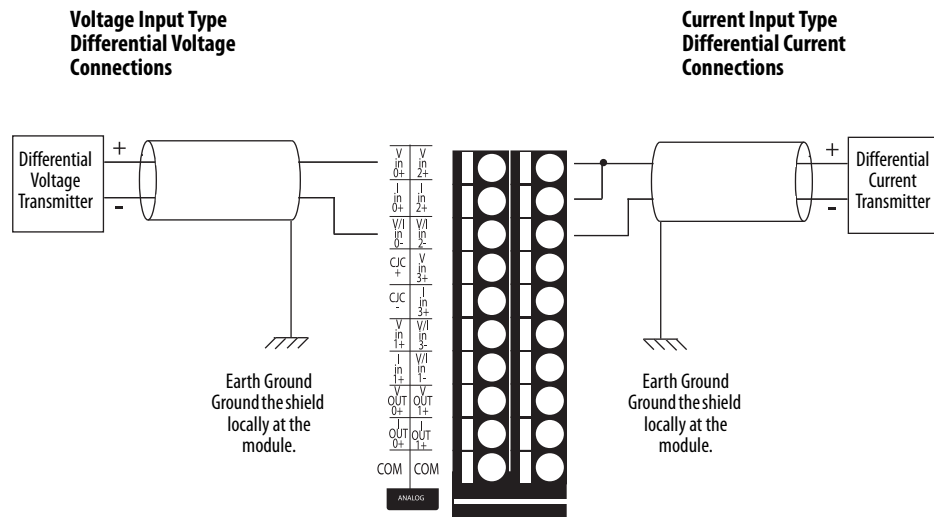

IMPORTANT: For both input types, we recommend that you use Belden #8761 or equivalent cable.

Figure 31 shows an example of devices with single-ended connections wired to the embedded analog inputs on a 1769-L27ERM-QBFC1B controller when it is operating with voltage or current input types.

Figure 31 - 1769-L27ERM-QBFC1B Controller Single-ended Connections Wiring Diagrams

IMPORTANT: For single-ended connections, remember the following:

- For both input types, we recommend that you use Belden #8761 or equivalent cable.
- The mV ranges with the Voltage input type do not support single-ended encoder wiring.
- All commons are electrically tied together in the controller.
- If multiple power supplies are used, the commons must have the same reference.

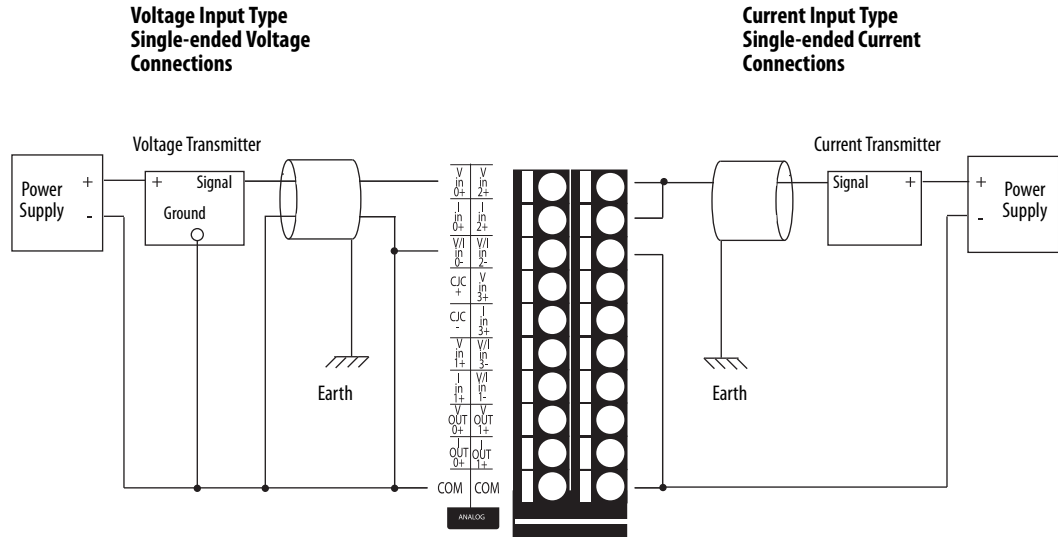
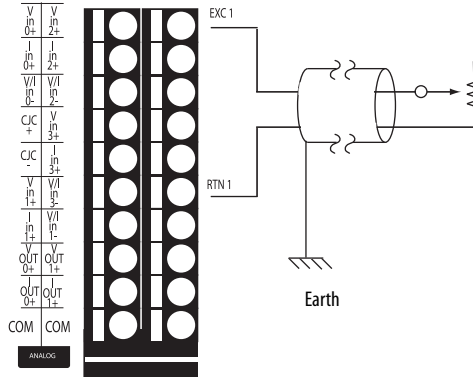

Figure 32 shows an example of 2-wire, 3-wire, and 4-wire RTD/Resistance wiring diagrams on a 1769-L27ERM-QBFC1B controller.

Figure 32 - 1769-L27ERM-QBFC1B RTD/Resistance Wiring Diagrams

2-wire Device Wiring Diagram



IMPORTANT: For all wiring diagrams, we recommend that you use Belden #83503 or 9533 cable.

3-wire Device Wiring Diagram

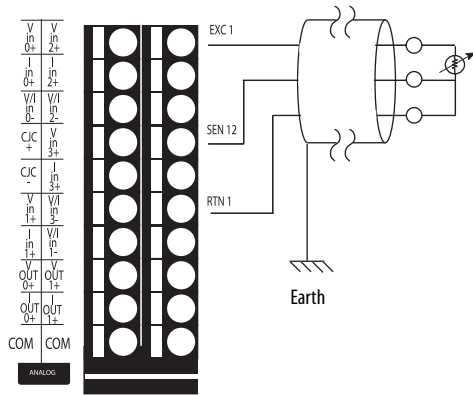

4-wire Device Wiring Diagram

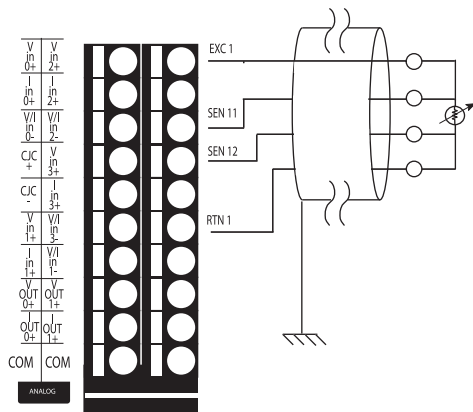

Table 12 lists the available embedded analog output channel types and ranges for the channel type. The configuration choices are made on the Output Configuration tab of the Module Properties dialog box, as shown in the table.

Table 12 - Output Types

Output Type	Output Ranges	Project Configuration
Voltage	<ul style="list-style-type: none"> -10...10V 0...5V 0...10V 1...5V 	
Current	<ul style="list-style-type: none"> 4...20 mA 0...20 mA 	

Figure 33 shows an example of wiring input devices to the analog output points on the 1769-L27ERM-QBFC1B controller when it is operating in voltage or current mode.

Figure 33 - 1769-L27ERM-QBFC1B Controller Analog Output Wiring Diagrams

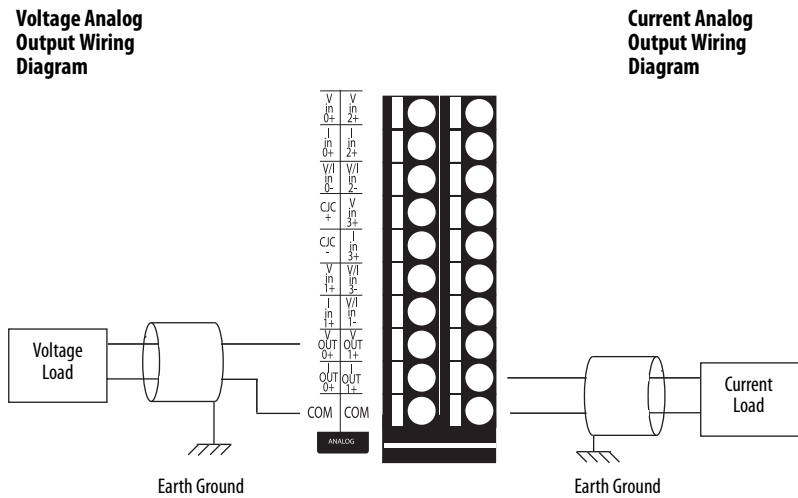

Embedded High-speed Counters

IMPORTANT The embedded high-speed counters are available on only the 1769-L24ER-QBFC1B and 1769-L27ERM-QBFC1B controllers.

The 1769-L24ER-QBFC1B and 1769-L27ERM-QBFC1B controllers support four embedded high-speed counters. Each counter is a differential input. Therefore, two input terminals are required for one counter. For example, the A0+ and A0- terminals are required for counter A0.

The L2 embedded high-speed counters operate like the 1769-HSC module. See [1769-UM006](#) for further information.

Each counter uses differential inputs that are compatible with standard differential-line driver output devices and single-ended devices. [Figure 34](#) shows the embedded high-speed counter input points.

IMPORTANT [Figure 34](#) shows the embedded high-speed counters on the 1769-L27ER-QB1B controller. The embedded high-speed counter points on the 1769-L24ER-QBFC1B and 1769-L27ERM-QBFC1B controllers are organized and wired the same.

Figure 34 - 1769-L27ERM-QBFC1B Controller Embedded High-speed Counter Wiring Termination Points

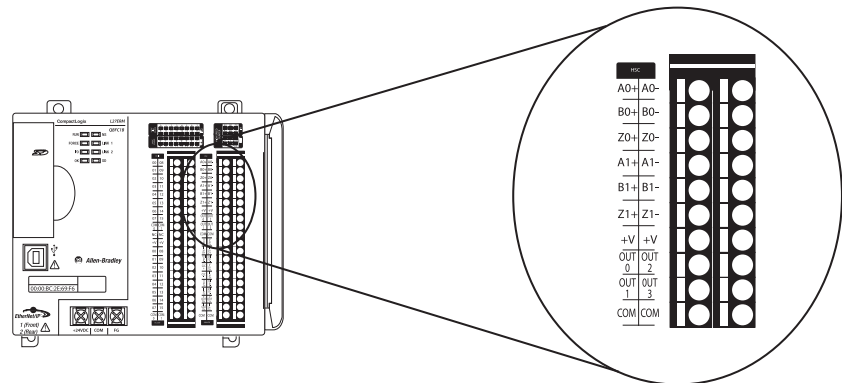

[Figure 35](#) shows an example of a differential encoder that is wired to the embedded high-speed counter inputs on a 1769-L27ERM-QBFC1B controller.

Figure 35 - 1769-L27ERM-QBFC1B Controller Differential Encoder with High-speed Counter Input Wiring Diagram

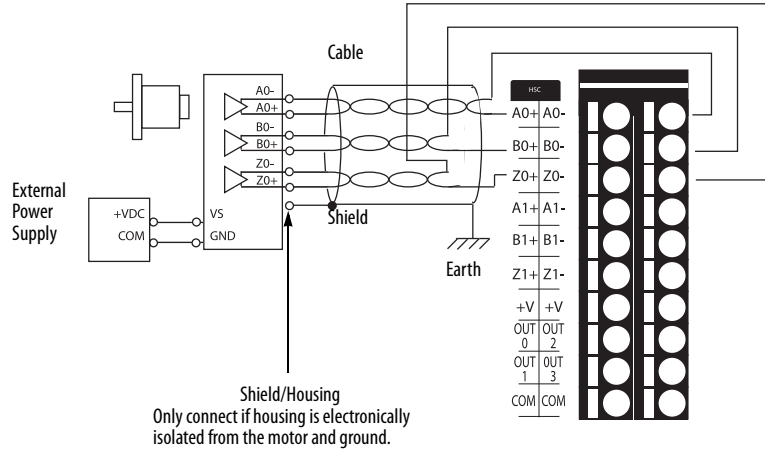

[Figure 36](#) shows an example of a single-ended encoder that is wired to the embedded high-speed counter inputs on a 1769-L27ERM-QBFC1B controller.

Figure 36 - 1769-L27ERM-QBFC1B Controller Single-ended Encoder with High-speed Counter Input Wiring Diagram

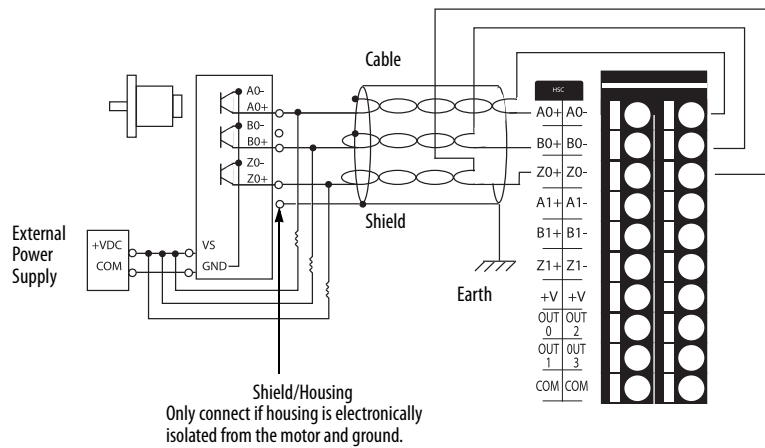

The embedded high-speed counter also supports four output points. [Figure 37](#) shows a wiring diagram for the embedded high-speed counter output points.

IMPORTANT [Figure 37](#) shows the embedded high-speed counter output points on the 1769-L27ER-QB1B controller. The embedded high-speed counter points on the 1769-L24ER-QBFC1B and 1769-L27ERM-QBFC1B controllers are organized and wired the same.

Figure 37 - 1769-L27ERM-QBFC1B Controller Embedded High-speed Counter Output Wiring Diagram

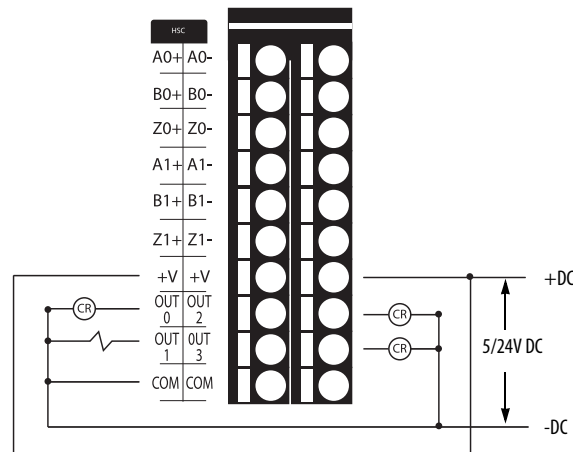

Wiring the Embedded I/O Modules

Complete these steps to wire the input and output points on the CompactLogix 5370 L2 controller.

1. Verify that the control system is not powered.
2. Strip 10 mm (0.39 in.) insulation from the end of the wire.
3. Push the wire into the open terminal until it is secure.

If your wire is too thin to push into the open terminal for secure placement, we recommend that you connect the wire to a ferrule and insert it into the open terminal.

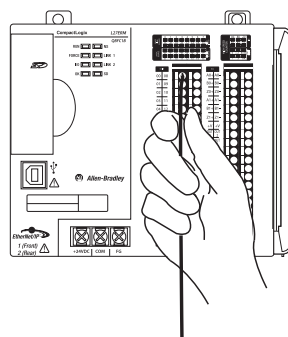

4. Repeat [step 3](#) for all embedded I/O wires that are needed in your application.

To remove a wire from the removable connector, complete these steps.

1. Verify that the control system is not powered.
2. Use a small screwdriver to push the spring release clip and pull out the wire.

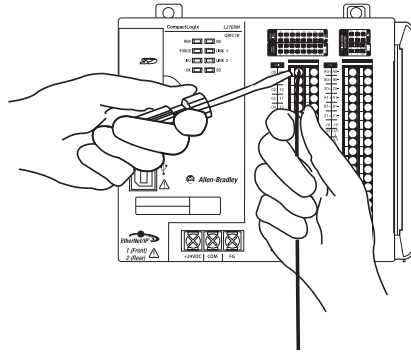

You can use a continuity tester to determine if the connection point is operating correctly, that is, the connection point is a complete circuit. You use a continuity tester if any issues arise with a removable connector and you suspect that a connection point can no longer be functioning as a complete circuit.

The indication mechanism, for example, a light that illuminates on the tester, varies by continuity tester. The following example graphic shows a continuity tester with one connection point. In this case, if the circuit is operating correctly, the indicator light turns on.

Insert a continuity tester into the suspected I/O connection point as shown in the following graphic.

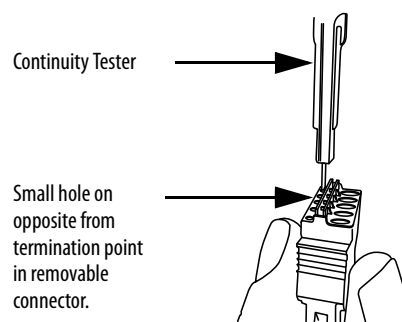

Remove and Replace the Connector

Complete these steps to remove and replace an embedded I/O module connector.

1. Verify that the control system is not powered.
2. Compress the small release clips at the top and bottom of the connector and tilt the top of the connector away from the module.

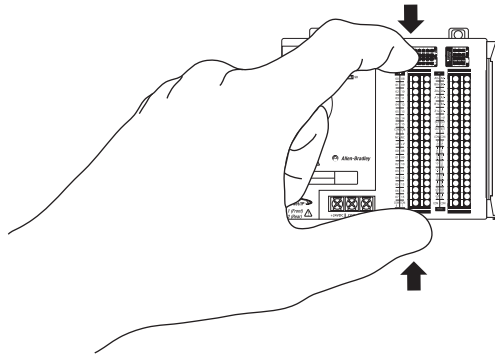

3. Pull the connector away from the module and disconnect any wires.
4. Connect the wires to the replacement connector.
5. Push the connector back into the module and engage the clips to secure the connector.

Determine Embedded Module Update Time

IMPORTANT This section applies to the 1769-L24ER-QBFC1B and 1769-L27ERM-QBFC1B controllers because only those controllers have embedded universal analog input points.

The module update time is the time that the module requires to sample and convert the input signals of all enabled analog input channels and provide the resulting data values to the controller.

You calculate the module update time by adding the update times for each enabled analog input channel on the module. Each channel update time calculation is the result of several configuration choices that are described in the following section.

Channel Update Times

Some combination of the following times determines the channel update time for an enabled analog input channel:

- [Channel Input Type and Filter Frequency Selection Update Time](#) - Required for channel update time calculation
- [Cold Junction Compensation Update Times](#) - Optional for channel update time calculation time
- [Open Circuit Detection Update Time](#) - Optional for channel update time calculation time

Channel Input Type and Filter Frequency Selection Update Time

When you enable an embedded analog input channel, you must select an input type and a filter frequency for that input. The selections that you make determine the value that is required when calculating channel update time.

IMPORTANT Each channel input type has multiple ranges or types. For example, a voltage input type can use one of six voltage ranges, as listed in [Table 11 on page 186](#). Regardless of which voltage range the channel uses, the channel update time remains the same. For more information, see [Table 13](#).

[Table 13](#) shows the channel update times for each channel input type and filter frequency selection.

Table 13 - Channel Update Times

Filter Frequency Selection ⁽¹⁾	Channel Update Times Based on Input Type Selection	
	Voltage, Current, or Thermocouple Input Type	Resistance or RTD Input Type
10 Hz	307 ms	614 ms
50 Hz	67 ms	134 ms
60 Hz	57 ms	114 ms
250 Hz	19 ms	38 ms
500 Hz	13 ms	26 ms
1 kHz	11 ms	22 ms

(1) Filter frequency selections are made on the Input Configuration tab of the Module Properties dialog box.

Cold Junction Compensation Update Times

You must account for more voltage at the junction of the thermocouple field wires and the input point. This condition applies when you use any of the thermocouple input types on your embedded analog input. More voltage can alter the input signal on that point and, therefore, affect the update time of that channel.

The process to account for increased voltage at an input point by using a thermocouple type input is cold junction compensation (CJC). You enable CJC for a given channel on the Input Configuration tab of the Module Configuration dialog box, as shown in the following graphic.

By default, CJC is disabled. You must clear the Disable Cold Junction Compensation checkbox to use CJC for a given channel.

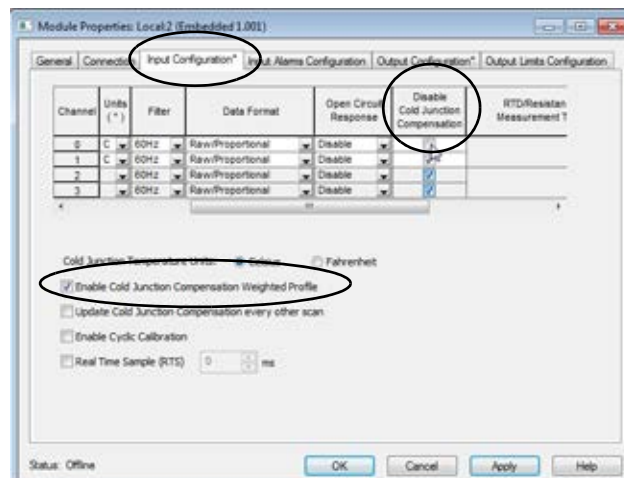

You are not required to enable CJC for a channel by using the thermocouple input type. If you enable CJC and select Update Cold Junction Compensation every other scan, an extra update time exists on the channel. This extra update time increases the overall channel update time.

The filter frequency selection for the channel determines the CJC update time. [Table 14](#) shows the CJC update times that are based on filter frequency selections.

Table 14 - Channel Update Times

Filter Frequency Selection ⁽¹⁾	CJC Update Time
10 Hz	614 ms
50 Hz	134 ms
60 Hz	114 ms
250 Hz	38 ms
500 Hz	26 ms
1 kHz	22 ms

(1) Filter frequency selections are made on the Input Configuration tab of the Module Properties dialog box.

IMPORTANT Keep the following in mind when calculating the CJC update time:

- If multiple input channels are configured to use a thermocouple input type and another filter value is selected for each, the filter frequency selection with the slowest update time determines the CJC update time. For example, if one input channel uses a thermocouple input with a 50 Hz filter frequency and another input channel uses a thermocouple input with a 60 Hz filter frequency, the CJC channel update time is 134 ms.
 - The CJC update time that increases overall module update time is only used once regardless of the number of input channels on a module that have CJC enabled to scan every other scan. In other words, if your module uses a filter frequency selection of 250 Hz and includes three channels with CJC enabled to scan every other scan, you add only one instance of CJC update time to the overall equation. Instead of including 38 ms for each channel, you include 38 ms once.
-

Open Circuit Detection Update Time

Open circuit detection is used to verify that the field wiring is physically connected to the embedded analog input point. If this feature is enabled and field wiring is disconnected from the input, the application alerts you to the condition and an open wire bit is set for the respective input channel in the tags for the project.

Open circuit detection can be enabled or disabled on any channel input type except for an input channel that is configured to use the 0...20 mA input range. The configuration selection is made on the Input Configuration tab on the Module Properties dialog box, as shown in the following graphic. The configuration choice, that is, enabled or disabled, is the result of an Open Circuit Response selection for the channel.

To disable open circuit detection, choose Disable. To enable open circuit detection, choose any of the other four options.

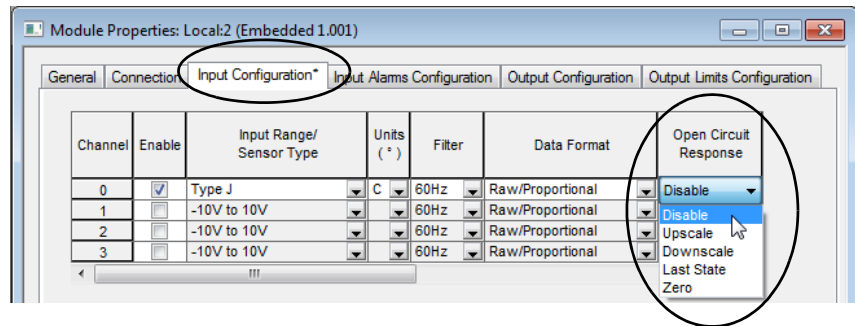

[Table 15](#) describes the module response that is associated with each enable selection.

Table 15 - Open Circuit Detection Response Definitions

Response Option	Definition
Upscale	Sets the input data value to full upper-scale value of channel data word. The selected input type and data format determines the full-scale value.
Downscale	Sets the input data value to full lower-scale value of channel data word. The selected input type and data format determines the low scale value.
Last State	Sets the input data value to the last input value before the detection of the open-circuit.
Zero	Sets the input data value to 0 to force the channel data word to 0.

When you enable open circuit detection for an input channel, an extra update time is used to calculate the overall channel type. The **increase** in channel update time is **11 ms** for each channel that enables open circuit detection response.

[Table 16](#) lists example module update times that are based on channel configurations.

Table 16 - Example Module Update Times

Example Enabled Analog Input Channel Configuration	Channel Update Time Calculations	Module Update Time
<ul style="list-style-type: none"> • Channel 0: <ul style="list-style-type: none"> – Input type = Current – Filter Frequency Selection = 60 Hz 	57 ms	57 ms
<ul style="list-style-type: none"> • Channel 0: <ul style="list-style-type: none"> – Input type = Current – Filter Frequency Selection = 60 Hz • Channel 2: <ul style="list-style-type: none"> – Input type = RTD – Filter Frequency Selection = 60 Hz 	Channel 0 update time + Channel 2 update time 57 ms + 114 ms	171 ms
<ul style="list-style-type: none"> • Channel 0: <ul style="list-style-type: none"> – Input type = Voltage – Filter Frequency Selection = 60 Hz – Open Circuit Detection = Enabled • Channel 2: <ul style="list-style-type: none"> – Input type = RTD – Filter Frequency Selection = 10 Hz 	(Channel 0 update time + Open Circuit Detection time) + Channel 2 update time (57 ms + 11 ms) + 614 ms	682 ms
<ul style="list-style-type: none"> • Channel 0: <ul style="list-style-type: none"> – Input type = RTD – Filter Frequency Selection = 10 Hz – Open Circuit Detection = Enabled • Channel 2: <ul style="list-style-type: none"> – Input type = Thermocouple – Filter Frequency Selection = 60 Hz – CJC = Enabled – Open Circuit Detection = Enabled • Channel 3: <ul style="list-style-type: none"> – Input type = Thermocouple – Filter Frequency Selection = 500 Hz – CJC = Enabled – Open Circuit Detection = Enabled 	(Channel 0 update time + Open Circuit Detection time) + (Channel 2 update time + Open Circuit Detection time) + (Channel 3 update time + Open Circuit Detection time) + CJC Update time (614 ms + 11 ms) + (57 ms + 11 ms) + (13 ms + 11 ms) + 114 ms ⁽¹⁾	831 ms

(1) If you select multiple thermocouples for your system, use the largest CJC Update time for your calculations.

Embedded Analog I/O Modules Data Arrays

The section describes the data table structures for the embedded analog I/O modules on the CompactLogix 5370 L2 controllers. The embedded analog I/O modules have arrays for the following data:

- Input data
- Output data
- Configuration data

You can access the data via the tags in the application.

IMPORTANT The analog I/O modules data structures apply to only the 1769-L24ER-QBFC1B and 1769-L27ERM-QBFC1B controllers. The 1769-L24ER-QB1B controller does not have an embedded analog I/O module.

Input Array

The input data array for the embedded analog I/O module contains 11 words as described in [Table 17](#). This array is read-only and the default value for all bits is 0.

Table 17 - CompactLogix 5370 L2 Controller Embedded Analog I/O Module Input Data Array

Word	Bit															
	15	14	13	12	11	10	9	8	7	6	5	4	3	2	1	0
0	S	Analog Read (Input) Data Value Channel 0														
1	S	Analog Read (Input) Data Value Channel 1														
2	S	Analog Read (Input) Data Value Channel 2														
3	S	Analog Read (Input) Data Value Channel 3														
4	Nu	Timestamp Value														
5	Nu	UI4	OI4	OC4	OC3	OC2	OC1	OC0	Nu			SI4	SI3	SI2	SI1	SI0
6	LI3	HI3	UI3	OI3	LI2	HI2	UI2	OI2	LI1	HI1	UI1	OI1	LI0	HI0	UI0	OI0
7	S	Cold Junction Compensation Value														
8	S	Output Data Loopback/Echo Channel 0														
9	S	Output Data Loopback/Echo Channel 1														
10	Nu		U01	O01	Nu		U00	O00	Nu					S01	S00	

Table 17 - CompactLogix 5370 L2 Controller Embedded Analog I/O Module Input Data Array (continued)

Word	Bit															
	15	14	13	12	11	10	9	8	7	6	5	4	3	2	1	0
Where:	Analog Read (Input) Data Value Channel x is the data that is read from the field device that is connected to the channel.															
	Timestamp Value is the timestamp of when data was received at the corresponding channel.															
	Cold Junction Compensation value is the converted CJC data. The data is calculated in the following manner: <ul style="list-style-type: none"> • If the CJC is open, the converted value is 25 °C (77 °F). • If the CJC is not opened and the Update CJC sensor every other scan option is disabled, the converted value is 25 °C (77 °F). • If the CJC is not opened and the Update CJC sensor every other scan option is enabled, the converted value is the measured temperature. 															
S	Sign bit															
Nu	Bit not used															
Slx	General status bit for an input channel. Bits 0...3 are for input channels. Bit 4 is for CJC. If the bit is 0, the channel is operating normally. If the bit is 1, a fault has occurred on the channel.															
Olx	Overrange alarm bit for an input channel. 0 = Channel is operating normally 1 = Input signal is over normal range.															
Ulx	Underrange alarm bit for an input channel. 0 = Channel is operating normally 1 = For bits 0...3, that is, input channels, the input signal is under the normal range. For bit 4, that is, channel using the thermocouple/mV, RTD/Resistance input type, the input value equals the minimum value of the range.															
Hlx	High alarm bit for an input channel 0. 0 = Channel is operating normally 1 = Input signal is above the user-defined range															
Llx	Low alarm bit for an input channel 0. 0 = Channel is operating normally 1 = Input signal is below the user-defined range.															
OCx	Open circuit detection bit. 0 = Channel is not experiencing an open circuit condition 1 = Channel is experiencing an open circuit condition															
SOx	General status bit for output channel 0 or 1. 0 = Channel operating normally 1 = A fault has occurred on the channel															
OOx	Overrange alarm bit for output channel 0 or 1. 0 = Channel is operating normally 1 = Output signal is over the normal range															
UOx	Underrange alarm bit for output channel 0 or 1. 0 = Channel is operating normally 1 = Output signal is below the normal range															

Output Array

The embedded analog I/O output image array of the module contains four words as described in [Table 18](#). This array is write only and the default value for all bits is 0.

Table 18 - CompactLogix 5370 L2 Controller Embedded Analog I/O Module Output Data Array

Word	Bit															
	15	14	13	12	11	10	9	8	7	6	5	4	3	2	1	0
0	S	Analog Output Data Value Channel 0														
1	S	Analog Output Data Value Channel 1														
2	Nu								CL I3	CH I3	CL I2	CH I2	CL I1	CH I1	CL I0	CH I0
3	Nu											CL O1	CH O1	CL O0	CH O0	
Where:	Analog Output Data Value Channel x is the data written to the channel.															
	S	Sign bit														
	Nu	Bit not used														
	CH Ix	Use this bit to cancel High Process Alarm Latch functionality for an input. 0 = Do not cancel 1 = Cancel the alarm latch														
	CL Ix	Use this bit to cancel Low Process Alarm Latch functionality for an input. 0 = Do not cancel 1 = Cancel the alarm latch														
	CH Ox	Use this bit to cancel High Process Alarm Latch functionality for an output. 0 = Do not cancel 1 = Cancel the alarm latch														
	CL Ox	Use this bit to cancel Low Process Alarm Latch functionality for an output. 0 = Do not cancel 1 = Cancel the alarm latch														

Configuration Array

The embedded analog I/O configuration image array of the module contains 43 words as described in [Table 19](#).

Table 19 - CompactLogix 5370 L2 Controller Embedded Analog I/O Module Configuration Image Array

Word	Bit															
	15	14	13	12	11	10	9	8	7	6	5	4	3	2	1	0
0	Real Time Sample Value															
1	ETS	Nu														
2	EC	Nu				EA	AL	EI	EO	Open Circuit Ch0	OV Adj	Filter Setting Ch0				
3	Wire & CLCD		TU Ch0	Nu		Inpt Dta Fm Ch0			Nu		Inpt Tp/RngeSel Ch0					
4	S	Process Alarm High Data Value Universal Input Channel 0														
5	S	Process Alarm Low Data Value Universal Input Channel 0														
6	S	Alarm Dead Band Value Universal Input Channel 0														
7	Nu															
8	EC	Nu				EA	AL	EI	EO	Open Circuit Ch1	OV Adj	Filter Setting Ch1				
9	Nu		TU Ch1	Nu		Inpt Dta Fm Ch1			Nu		Inpt Tp/RngeSel Ch1					
10	S	Process Alarm High Data Value Universal Input Channel 1														
11	S	Process Alarm Low Data Value Universal Input Channel 1														
12	S	Alarm Dead Band Value Universal Input Channel 1														
13	Nu															
14	EC	Nu				EA	AL	EI	EO	Open Circuit Ch2	OV Adj	Filter Setting Ch2				
15	Wire & CLCD		TU Ch1	Nu		Inpt Dta Fm Ch2			Nu		Inpt Tp/RngeSel Ch2					
16	S	Process Alarm High Data Value Universal Input Channel 2														
17	S	Process Alarm Low Data Value Universal Input Channel 2														
18	S	Alarm Dead Band Value Universal Input Channel 2														
19	Nu															
20	EC	Nu				EA	AL	EI	EO	Open Circuit Ch3	OV Adj	Filter Setting Ch3				
21	Nu		TU Ch1	Nu		Inpt Dta Fm Ch3			Nu		Inpt Tp/RngeSel Ch3					
22	S	Process Alarm High Data Value Universal Input Channel 3														
23	S	Process Alarm Low Data Value Universal Input Channel 3														
24	S	Alarm Dead Band Value Universal Input Channel 3														
25	Nu															
26	CJC Ses	Cycle Calib	Nu	CJC WP	Nu											TU CJC
27	Nu															
28	EC	NU							EHI	ELI	LC	ER	FM	PM	Nu	PFE
29	Nu				Outpt Fm Ch0				Nu				Outpt Tp/RngeSel Ch0			
30	S	Fault Value Channel 0														

Table 19 - CompactLogix 5370 L2 Controller Embedded Analog I/O Module Configuration Image Array (continued)

Word	Bit																
	15	14	13	12	11	10	9	8	7	6	5	4	3	2	1	0	
31	S	Program (Idle) Value Channel 0															
32	S	Clamp High Data Value Channel 0															
33	S	Clamp Low Data Value Channel 0															
34	S	Ramp Rate Channel 0															
35	Nu																
36	EC	Nu						EHI	ELI	LC	ER	FM	PM	Nu	PFE		
37	Nu					Outpt Fm Ch1			Nu				Outpt Tp/RngeSel Ch1				
38	S	Fault Value Channel 1															
39	S	Program (Idle) Value Channel 1															
40	S	Clamp High Data Value Channel 1															
41	S	Clamp Low Data Value Channel 1															
42	S	Ramp Rate Channel 1															

Table 19 - CompactLogix 5370 L2 Controller Embedded Analog I/O Module Configuration Image Array (continued)

Word	Bit															
	15	14	13	12	11	10	9	8	7	6	5	4	3	2	1	0
Where:	EC	Use to enable or disable a channel. Each channel can be individually enabled. 0 = Disable 1 = Enable														
	Inpt Dta FM Chlx	Use this bit to select the form in which the analog data is returned to the controller and used in the control program.														
	EA	Use this bit to enable or disable the process alarms of a channel. 0 = Disable 1 = Enable														
	AL	Use this bit to enable or disable alarm latching on the process alarm of a channel. 0 = No latch 1 = Latch														
	EI	Use this bit to enable or disable interrupts on the process alarms of a channel. 0 = Disable 1 = Enable														
	EO	Use this bit to enable or disable Open Circuit functionality on a channel. 0 = Disable 1 = Enable														
	Open Circuit Chx	Use to set the Open Circuit Response for a channel. 0 = Upscale 1 = Downscale 2 = Last State 3 = Zero														
	OV adjust	CJC is performed by default by taking the CJC sensor temperature value for a given channel, converting that to a thermocouple voltage, and adding that voltage from the measured value before converting to a user value. If this bit is set for a given channel, the signal value is directly converted to a user value (No cold junction compensation performed).														
	Wire & CLCD	Use to set the wire mode. The combination of values in bits 14 and 15 determine the mode, as listed in the following table.														
		Bit 15 Value	Bit 14 Value	Mode												
		0	0	3-wire and cycle lead compensation - Enable												
		0	1	3-wire and cycle lead compensation - Disable												
		1	0	2-wire (No lead compensation)												
		1	1	4-wire (No lead compensation)												
	TU Chx	Use to set the temperature units. 0 = Degrees Celsius 1 = Degrees Fahrenheit														

Table 19 - CompactLogix 5370 L2 Controller Embedded Analog I/O Module Configuration Image Array (continued)

Word	Bit														
	15	14	13	12	11	10	9	8	7	6	5	4	3	2	1
Where (cont.)	Inpt Dta Fm Chlx	Use these bits to select the form the analog input data is presented to the controller and used by the controller. The combination of multiple selections in words and bits determines this value. For more information on what selections determine the input data form that is used, see Table 21 on page 211 .													
	Inpt Tp / Rnge Sel Chlx	Use these bits to select the input type and operating range for a channel. For more information on what selections determine the input type and operating range for a channel, see Table 22 on page 211 .													
	Filter Setting Chx	Use these bits to select the filter setting for a channel. For more information on what selections determine the filter settings for a channel, see Table 20 on page 210 .													
	Process Alarm High Data Value Channel x	Use to configure the Process Alarm High value for a channel. Configuration is done by using words 4, 10, 16, and 22 to set the Alarm High value.													
	Process Alarm Low Data Value Channel x	Use to configure the Process Alarm Low value for a channel. Configuration is done by using words 5, 11, 17, and 23 to set the Low High value.													
	Alarm Dead Band Data Value Channel x	Use to configure the Alarm Deadband value for a channel. Configuration is done by using words 6, 12, 18, and 24 to set the deadband alarm value.													
	ETS	Use to enable or disable the timestamping function on the module. 0 = Disable 1 = Enable													
	Real Time Stamp Value	Use to set the Real Time Sample value. The available range = 0...5000 ms.													
	Update CJC Compensation Enable	Use this bit to enable or disable a CJC sensor. <ul style="list-style-type: none"> If enabled, the CJC is read once every other module scan, and its value is updated in the CJC status word. This value is also used for thermocouple cold junction compensation. If disabled, the CJC sensor value is not acquired, and the CJC temperature is fixed at 25 °C (77 °F) for all channels. The CJC is also fixed at 25 °C (77 °F) for all channels if it is determined to be broken (short or open circuit). 0 = Disable 1 = Enable													
	Cycle Calib	Use this bit to enable Cycle Calibration. <ul style="list-style-type: none"> If enabled, the internal calibration of the module occurs once every 5 minutes. If disabled, the internal calibration of the module occurs only once at power on/ reset. Cycle Calibration enables the module to readjust for environmental changes such as variations in temperature. However, the module throughput is slightly reduced during the calibration operation. 0 = Disable 1 = Enable													

Table 19 - CompactLogix 5370 L2 Controller Embedded Analog I/O Module Configuration Image Array (continued)

Word	Bit															
	15	14	13	12	11	10	9	8	7	6	5	4	3	2	1	0
Where (cont.)	CJC WP	Use this bit to enable or disable the CJC Weighted Profile. <ul style="list-style-type: none"> If enabled, the CJC temperature for each channel is scaled by multiplying the single CJC reading by a predefined scale factor that is derived from lab measurements of the stable temperature of each terminal block pin. In this condition, all channel data is overridden with the CJC temperature of that channel. If disabled, the single CJC reading is applied directly to all channels. If the CJC sensors are installed in a remote terminal block, the weighted profile must be disabled. In this condition, channel data is presented in the input table as normal. 0 = Disable 1 = Enable														
	PFE	Use this bit to select whether data from the Program/Idle mode or the Fault Enable mode is applied. 0 = Program/Idle mode data applied 1 = Fault mode data applied														
	ER	Use this bit to enable or disable ramping for each channel. 0 = Disable 1 = Enable														
	EHI	Use this bit to enable or disable the output channel interrupt function when a High Clamp alarm is set. 0 = Disable 1 = Enable														
	ELI	Use this bit to enable or disable the output channel interrupt function when a Low Clamp alarm is set. 0 = Disable 1 = Enable														
	PM	Use this bit to set data a channel uses when it is in Program/Idle mode. 0 = Hold Last State value 1 = User-defined value														
	FM	Use this bit to set data a channel uses when it is in Fault mode. 0 = Hold Last State value 1 = User-defined value														
	LC	Use this bit to enable or disable latch functionality when Low/High clamp and Under/Over range alarm conditions exist on a channel. 0 = Disable 1 = Enable														
	Output Data Form Chlx	Use these bits to select the form the analog output data is presented to the controller and used by the controller. The combination of multiple selections in words and bits determines this value. For more information on what selections determine the output data form that is used, see Table 23 on page 212 .														
	Output Type / Range Sel Chlx	Use these bits to select the output type and operating range for a channel. For more information on what selections determine the input type and operating range for a channel, see Table 24 on page 213 .														
	Fault Value Channel x	Use this bit to configure the Fault mode value for a channel.														
	Program (Idle) Value Channel x	Use this bit to configure the Program/Idle mode value for a channel.														

Table 19 - CompactLogix 5370 L2 Controller Embedded Analog I/O Module Configuration Image Array (continued)

Word	Bit															
	15	14	13	12	11	10	9	8	7	6	5	4	3	2	1	0
Where (cont.)	Clamp High Data Value Channel x	Use this bit to configure the Clamp High data value for a channel.														
	Clamp Low Data Value Channel x	Use this bit to configure the Clamp Low data value for a channel.														
	Ramp Rate Channel x	Use this bit to set the Ramp Rate value for a channel.														

Input Filter Selections

[Table 20](#) lists the bit value combinations you can use to select a filter setting for a channel. You use bits 0...3 in words 2, 8, 14, and 20 to make this selection.

Table 20 - Input Filter Selections

Filter Value	Bit Settings (Words 3, 9, 15, and 21)			
	Bit 03	Bit 02	Bit 01	Bit 00
60 Hz	0	0	0	0
50 Hz	0	0	0	1
10 Hz	0	0	1	
250 Hz	0	0	1	1
500 Hz	0	1	0	0
1 kHz	0	1	0	1
Spare ⁽¹⁾	Values 6...15			

(1) An attempt to write a non-valid (any Spare value) or Not Used bit configuration into the Input Filter Response Select field causes a Module Configuration Error (contained in the Mod_Condition Array).

Analog Input Data Format

[Table 21](#) lists the bit value combinations you can use to select the output data format for analog data that is sent to the controller for a channel. You use bits 8...10 in words 3, 9, 15, and 21 to make this selection.

Table 21 - Analog Input Data Format

Analog Output Data Format	Bit Settings (Words 3, 9, 15, and 21)		
	Bit 10	Bit 09	Bit 08
Raw/Proportional Data	0	0	0
Engineering Units	0	0	1
Engineering Units x 10	0	1	0
Scaled for PID	0	1	1
Percent Range	1	0	0
Spare ⁽¹⁾	Values 5...7		

(1) An attempt to write a non-valid (any Spare value) bit configuration into the Input/Output Data Format Select field causes a Module Configuration Error (contained in Mod_Condition Array). All bits shown as 0 in [Table 21](#) are set to 0.

Analog Input Type and Operating Range

[Table 22](#) lists the bit value combinations you can use to select the input type and operating range for a channel. You use bits 0...5 in words 3, 9, 15, 21, 29, and 37 to make the selections.

Table 22 - Analog Input Type and Operating Range

Input Type and Normal Operating Range	Bit Settings (Words 3, 9, 15, and 21)					
	Bit 05	Bit 04	Bit 03	Bit 02	Bit 01	Bit 00
-10...10V DC	0	0	0	0	0	0
0...5V DC	0	0	0	0	0	1
0...10V DC	0	0	0	0	1	0
4...20 mA	0	0	0	0	1	1
1...5V DC	0	0	0	1	0	0
0...20 mA	0	0	0	1	0	1
-50 mV...50 mV	0	0	0	1	1	0
-100...100 mV	0	0	0	1	1	1
Thermocouple J	0	0	1	0	0	0
Thermocouple K	0	0	1	0	0	1
Thermocouple T	0	0	1	0	1	0
Thermocouple E	0	0	1	0	1	1
Thermocouple R	0	0	1	1	0	0
Thermocouple S	0	0	1	1	0	1
Thermocouple B	0	0	1	1	1	0
Thermocouple N	0	0	1	1	1	1

Table 22 - Analog Input Type and Operating Range (continued)

Input Type and Normal Operating Range	Bit Settings (Words 3, 9, 15, and 21)					
	Bit 05	Bit 04	Bit 03	Bit 02	Bit	Bit 00
Thermocouple C	0	1	0	0	0	0
100 Ω PT 385	0	1	0	0	0	1
200 Ω PT 385	0	1	0	0	1	0
500 Ω PT 385	0	1	0	0	1	1
1000 Ω PT 385	0	1	0	1	0	0
100 Ω PT 3916	0	1	0	1	0	1
200 Ω PT 3916	0	1	0	1	1	0
500 Ω PT 3916	0	1	0	1	1	1
1000 Ω PT 3916	0	1	1	0	0	0
10 Ω CU 426	0	1	1	0	0	1
120 Ω Ni 618	0	1	1	0	1	0
120 Ω Ni 672	0	1	1	0	1	1
604 Ω NiFe 518	0	1	1	1	0	0
150 Ω	0	1	1	1	0	1
500 Ω	0	1	1	1	1	0
1000 Ω	0	1	1	1	1	1
3000 Ω	1	0	0	0	0	0

Analog Output Data Format

[Table 23](#) lists the bit value combinations you can use to select the output data format for analog data that is sent to the controller for a channel. You use bits 8...10 in words 29 and 37 to make this selection.

Table 23 - Analog Output Data Format

Analog Output Data Format	Bit Settings (Words 29 and 37)		
	Bit 10	Bit 09	Bit 08
Raw/Proportional Data	0	0	0
Engineering Units	0	0	1
Scaled for PID	0	1	0
Percent Range	0	1	1
Spare ⁽¹⁾	Values 4...7		

(1) An attempt to write a non-valid (any Spare value) bit configuration into the Input/Output Data Format Select field causes a Module Configuration Error (contained in Mod_Condition Array). All bits shown as 0 in [Table 23](#) are set to 0.

Analog Output Type and Operating Range

[Table 24](#) lists the bit value combinations you can use to select the input type and operating range for a channel. You use bits 0...5 in words 29 and 37 to make the selections.

Table 24 - Analog Output Type and Operating Range

Output Type and Normal Operating Range	Bit Settings (Words 29 and 37)					
	Bit 05	Bit 04	Bit 03	Bit 02	Bit 01	Bit 00
-10...10V DC	0	0	0	0	0	0
0...5V DC	0	0	0	0	0	1
0...10V DC	0	0	0	0	1	0
4...20 mA	0	0	0	0	1	1
1...5V DC	0	0	0	1	0	0
0...20 mA	0	0	0	1	0	1

Local Expansion Modules - Optional

CompactLogix 5370 L2 control systems support the use of Compact I/O™ modules as local expansion modules along a CompactBus backplane:

- The controllers support as many as four Compact I/O modules as local expansion modules.
- When possible, use specialty Compact I/O modules to meet unique application requirements.
- Consider using a 1492 wiring system for each I/O module as an alternative to the terminal block that comes with the module.
- Use 1492 PanelConnect™ modules and cables if you are connecting input modules to sensors.
- Install local expansion modules in the same local bank as the CompactLogix 5370 L2 controller.

Install Local Expansion Modules

Complete these steps to install local expansion modules in your CompactLogix 5370 L2 control system.

1. Attach the Compact I/O modules as described in these publications:
 - Compact I/O Modules Installation Instructions, publication [1769-IN088](#)
 - Compact I/O DeviceNet Scanner Module Installation Instructions, publication [1769-IN060](#)
2. Use the tongue-and-groove slots to attach a 1769-ECR Compact I/O end cap terminator to the last module in the system.
3. Move the lever of the end cap bus terminator fully to the left until it clicks to lock the end cap bus terminator.

Wire Local Expansion Modules

Wire each Compact I/O module that is used as a local expansion module according to the technical documentation for that module.

Distributed I/O Modules over an EtherNet/IP Network

You can include distributed I/O modules over an EtherNet/IP network in your CompactLogix 5370 L2 control system.

Consider the following when using distributed I/O modules over an EtherNet/IP network:

- Each remote EtherNet/IP adapter included in the system must be counted toward the maximum number of EtherNet/IP nodes of the controller.

For more information on maximum number of EtherNet/IP nodes, see [Nodes on an EtherNet/IP Network on page 123](#).

- The configurable RPI settings vary depending on which distributed I/O modules are used in the system.
- For information to add distributed I/O modules to your CompactLogix 5370 L2 control system, see [Configure Distributed I/O Modules on a DeviceNet Network on page 230](#).

The following graphic shows a CompactLogix 5370 L2 control system on an EtherNet/IP network that uses all three I/O module options.

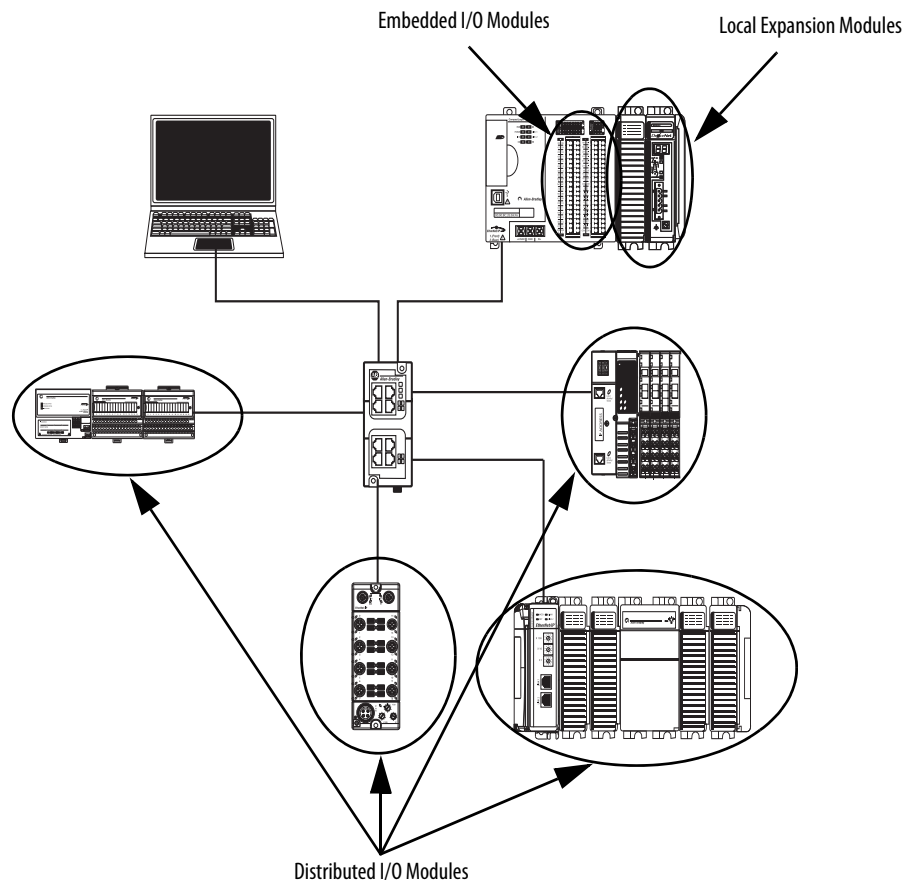

Distributed I/O Modules over a DeviceNet Network

You can include distributed I/O modules over a DeviceNet network in your CompactLogix 5370 L2 control system.

You must use the following to use distributed I/O modules over a DeviceNet network in your CompactLogix 5370 L2 control system:

- Logix Designer application or the Studio 5000® environment - For more information, see [Configure Distributed I/O Modules on an EtherNet/IP Network on page 226](#).
- RSNetWorx™ for DeviceNet software - For more information, see [Configure Distributed I/O Modules on a DeviceNet Network on page 230](#).

The following graphic shows a CompactLogix 5370 L2 control system on a DeviceNet network that uses all three I/O module options.

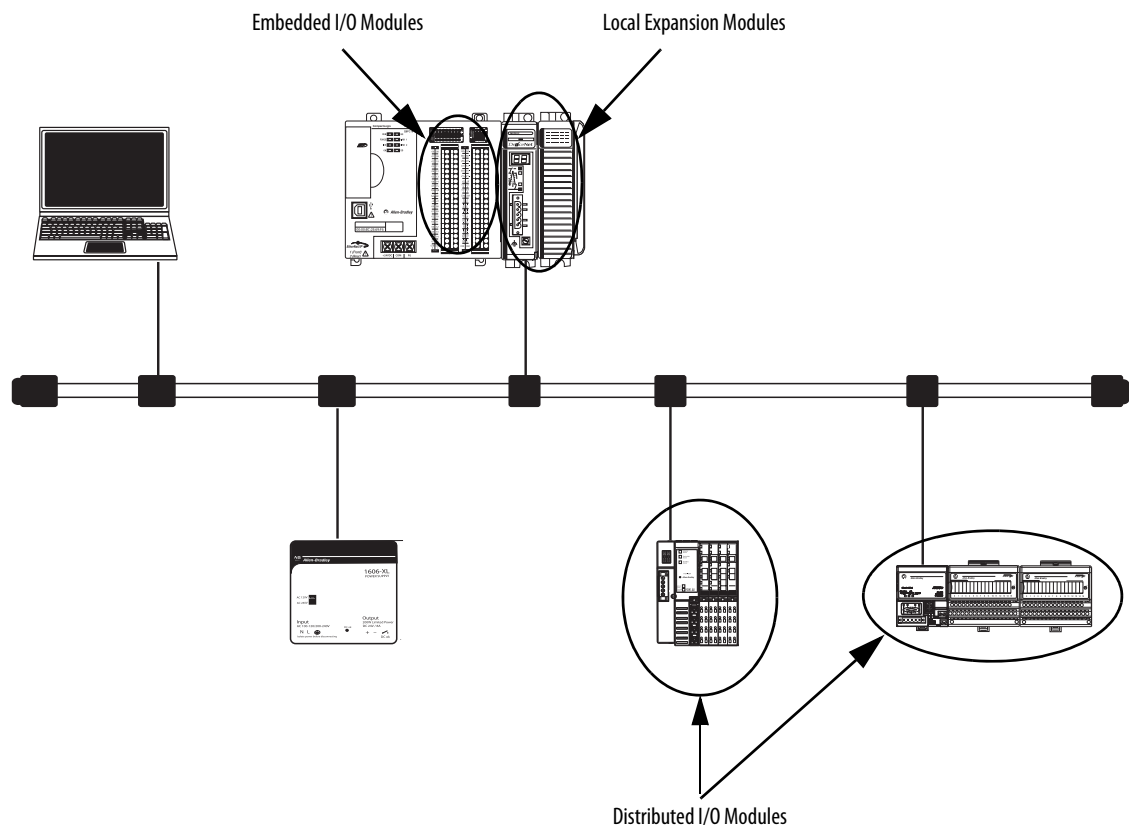

Validate I/O Layout

You must validate the layout of I/O modules in your CompactLogix 5370 L2 control system. Consider these points when validating I/O layout placement:

- [Estimate Requested Packet Interval](#)
- [Module Fault Related to RPI Estimates](#)
- [System Power Availability](#)
- [Power Supply Distance Rating](#)

Estimate Requested Packet Interval

The requested packet interval (RPI) defines the frequency at which the controller sends data to and receives data from I/O modules. You set an RPI rate for each I/O module in your system, including embedded I/O modules, local expansion modules, or distributed I/O modules over an EtherNet/IP network.

The CompactLogix 5370 L2 controllers attempt to scan an I/O module at the configured RPI rate. The controller scans distributed I/O modules at the configured RPI rates.

With embedded I/O modules and local expansion modules, however, some system configuration parameters determine the actual rate at which the controller scans the modules. That is, the controller can be configured to scan an I/O module at one rate but actually scan the module at another rate.

For individual I/O modules, a [Module RPI Overlap](#) minor fault occurs if there is at least one I/O module that cannot be serviced within its RPI time.

The configuration parameters for a system determine the impact on actual RPI rates. These configuration factors can affect the effective scan frequency for any individual embedded or local expansion module:

- Rates at which RPI values are set for embedded I/O modules
- Number of embedded I/O modules that are used in the system
- Types of embedded I/O modules that are used in the system
- Rates at which RPI values are set for Compact I/O modules
- Number of Compact I/O modules in the system
- Types of Compact I/O modules in the system
- Application user task priorities

[Table 25](#) describes RPI rate guidelines.

Table 25 - Requested Packet Interval Guidelines

Type of Module	Guidelines ⁽¹⁾
All digital	The following guidelines apply: <ul style="list-style-type: none"> • 1...2 modules can be scanned in 0.5 ms. • 3...4 modules can be scanned in 1 ms. • 5...30 modules can be scanned in 2 ms.
Mix of digital and analog or all analog	The following guidelines apply: <ul style="list-style-type: none"> • 1...2 modules can be scanned in 0.5 ms. • 3...4 modules can be scanned in 1 ms. • 5...13 modules can be scanned in 2 ms. • 14...30 modules can be scanned in 3 ms.
Specialty	The following conditions apply: <ul style="list-style-type: none"> • For every 1769-SDN module in the system, increase every RPI by 2 ms for every other module. • For every 1769-HSC module in the system, increase every RPI by 1 ms for every other module. • For every 1769-ASCII module in the system, increase every RPI by 1 ms for every other module. • For every 1769-SM2 module in the system, increase every RPI by 2 ms for every other module.

(1) The guidelines in [Table 25](#) do not factor in the following items, which affect CMX5370 controller CPU loading:
 I/O RPI timing does not affect the task priority. Event and periodic tasks have higher priority than I/O and user tasks.
 IOT (Immediate Output Instruction)
 Messaging
 CompactBus browsing such as accessing DeviceNet network through 1769-SDN using CMX5370 Ethernet or USB connection
 Module RPI guidelines can require adjustment (increase of 1 ms or more) if CMX5370 controller application includes one or more of the listings in [Table 25](#). Monitor controller minor faults to determine if Module RPI overlaps have occurred.

IMPORTANT When considering the number of I/O modules, remember that they can be the embedded I/O modules on the controller or Compact I/O modules that are used as local expansion modules. Therefore, the consideration for using modules can be any of the following system configurations:

- Only embedded I/O modules
- Only Compact I/O modules
- Some combination of embedded I/O modules and Compact I/O modules

You can set RPI rates higher for individual Compact I/O modules than the rates listed in [Table 25](#). The RPI shows how quickly modules can be scanned, not how quickly an application can use the data. The RPI is asynchronous to the program scan. Other factors, such as program execution duration, affect I/O throughput.

Module Fault Related to RPI Estimates

When following the guidelines described in [Table 25](#), most CompactLogix 5370 L2 control systems operate as expected. Some systems that follow the guidelines can experience a Module RPI Overlap minor fault that is described in the following table.

Name	Fault Information	Condition in Which Fault Occurs
Module RPI Overlap	(Type 03) I/O fault (Code 94) Module RPI overlap detected Module Slot = x , where x is the slot number of the I/O module in the I/O Configuration section	<p>This fault is logged when the current RPI update of an I/O module overlaps with its previous RPI update. The Minor Faults tab in the Controller Properties dialog box indicates in which module the RPI overlap occurs.</p> <p>If multiple I/O modules experience the fault, the application indicates that the fault occurred on the first such I/O module. Typically, it is an I/O module with a large Input/Output array sizes. Example modules that use large Input/Output array sizes include the 1769-SDN and 1769-HSC modules. In these cases, we recommend that you adjust the RPI of the module to eliminate the fault.</p> <p>Once the fault is cleared from the first I/O module, the application indicates the next module that experiences the fault. This pattern continues until the fault is cleared from all affected I/O modules.</p> <p>To avoid this fault, set the RPI rate of the I/O modules to higher numerical values. We recommend that you use an RPI value that is not a common multiple of other module RPI values, such as 2.5 ms, 5.5 ms, or 7 ms:</p> <ul style="list-style-type: none"> • We recommend that you do not run CompactLogix 5370 L2 control systems with Module RPI Overlap faults. • A system that experiences many Module RPI Overlap faults cannot operate optimally because I/O data is not sampled at the expected rate that RPI settings determine. • When the project is downloaded or the RPI value of a module is adjusted, it is expected to have a minor fault. Faults under these conditions are transitional. Clear the fault and wait for the fault to reappear before adjusting the RPI value or the task priorities.

System Power Availability

An embedded 24V DC Input, nonisolated power supply powers all components in a CompactLogix 5370 L2 control system.

The embedded power supply provides the following power to the CompactBus:

- 1769-L24ER-QB1B controller:
 - 1.54 A @ 5V DC
 - 0.95 A @ 24V DC
- 1769-L24ER-QBFC and 1769-L27ERM-QBFC1B controllers:
 - 1 A @ 5V DC
 - 0.8 A @ 24V DC

The embedded power supply can power any combination of controller, embedded I/O modules, and local expansion modules that are used in your application.

Power Supply Distance Rating

In a CompactLogix 5370 L2 control system, you can install Compact I/O modules on as local expansion modules to the right of the controller system. Compact I/O modules each have a power supply distance rating that you must consider before you install them.

Power supply distance rating is the number of slots a Compact I/O module can be installed away from the power supply. If a Compact I/O module has a distance rating of three, you can include up to two modules between the Compact I/O module and the power supply.

Additionally, the controller has embedded I/O modules that are designed to protect against installation of a Compact I/O module directly to the right of the embedded power supply. CompactLogix 5370 L2 control systems have embedded I/O modules in the controller. CompactLogix 5370 L2 control systems have one or two embedded I/O modules as described as follows:

- 1769-L24ER-QB1B controller - One embedded I/O module
- 1769-L24ER-QBFC1B and 1769-L27ERM-QBFC1B controllers - Two embedded I/O modules

The embedded I/O modules are not considered local expansion modules. However, you must still include each embedded I/O module in the module slot count when determining where to install Compact I/O module as a local expansion module.

Because CompactLogix 5370 L2 control systems only allow up to four local expansion modules in the system, you can install most Compact I/O modules in any local expansion module slot. Some Compact I/O modules have power supply distance ratings that affect where you can install them in the CompactLogix 5370 L2 control system.

For example, the 1769-ASCII Compact ASCII and 1769-HSC Compact high-speed counter modules each have a power supply distance rating of four. The farthest local expansion module slot where you can install one of these modules in a CompactLogix 5370 L2 control system is module slot number two or three. The slot number is determined by the controller catalog number that is used in the control system.

[Table 26](#) describes the farthest local expansion module slot where you can install a 1769-HSC high-speed counter module and meet its power supply distance rating requirement.

Table 26 - Example CompactLogix 5370 L2 Control Systems with a 1769-HSC High-speed Counter Module

Controller Cat. No.	Number of Embedded I/O Modules	1769-HSC High-speed Counter Module Power Supply Distance Rating Calculation Impact
1769-L24ER-QB1B	1	<p>The embedded I/O module is the first module in the module count. At its maximum power supply distance rating, the 1769-HSC high-speed counter module can be installed in slot 3 of the local expansion modules, as shown in the following graphic.</p>  <p>Three modules between the power supply and the 1769-HSC high-speed counter module. With this controller catalog number, you can only install up to two local expansion modules between the controller and the 1769-HSC high-speed counter module.</p>

Table 26 - Example CompactLogix 5370 L2 Control Systems with a 1769-HSC High-speed Counter Module (continued)

Controller Cat. No.	Number of Embedded I/O Modules	1769-HSC High-speed Counter Module Power Supply Distance Rating Calculation Impact
1769-L24ER-QBFC1B 1769-L27ERM-QBFC1B	2	<p>The embedded I/O modules are the first two modules in the module count. At its maximum power supply distance rating, the 1769-HSC high-speed counter module can be installed in slot 2 of the local expansion modules, as shown in the following graphic.</p>  <p>Three modules between the power supply and the 1769-HSC high-speed counter module. With this controller catalog number, you can only install one local expansion module between the controller and the 1769-HSC high-speed counter.</p> <hr/> <p>IMPORTANT When counting I/O modules to determine the 1769-HSC high-speed counter module placement in a 1769-L24ER-QBFC1B or 1769-L27ERM-QBFC1B control system, the embedded I/O module appearance is different between the physical appearance and the appearance of the module in the application.</p> <p>The physical appearance is a shown in the previous graphic. The second module is two rows of termination points below one set of status indicators.</p> <p>In the application, the second embedded I/O module appears as two modules in the Controller Organizer each with their own slot number, that is [2] and [3].</p> <p>When the 1769-HSC high-speed counter module is installed in the farthest local expansion module slot possible, that is the fourth module in the system, it appears with a [5] designation in the Controller Organizer, as shown in the following graphic.</p>  <p>Modules [2] and [3] are shown separately but are considered one module when counting modules to meet power supply distance rating requirements.</p> <p>1769-HSC high-speed counter module is shown as module [5] in this location but considered the fourth module when counting modules to meet power supply distance rating requirements.</p>

For more information about the power supply distance rating for a Compact I/O module, see CompactLogix Selection Guide, publication [1769-SG001](#).

Configure Local I/O Modules

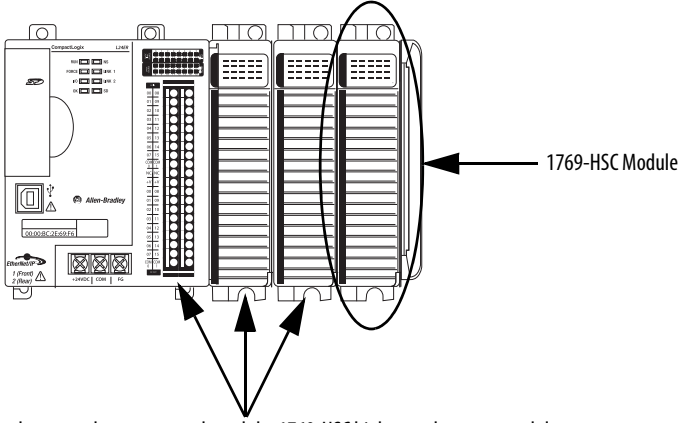
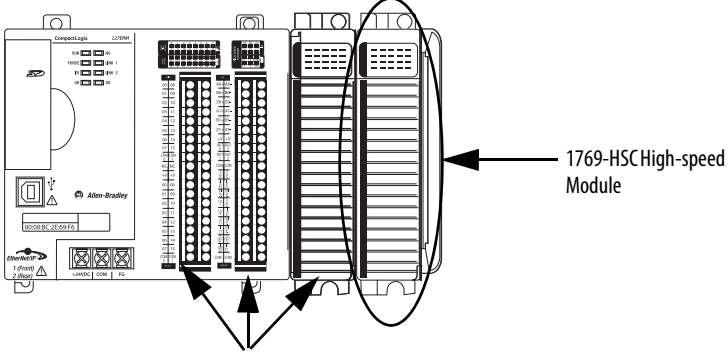
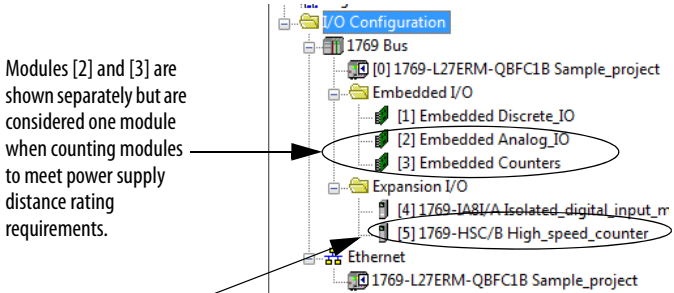
You can configure one of these types of local I/O modules in the programming software environment:

- [Configure Embedded I/O Modules](#)
- [Configure Local Expansion Modules](#)

Configure Embedded I/O Modules

Embedded I/O modules are automatically created in the I/O Configuration portion of the Controller Organizer. Complete these steps to configure an embedded I/O module in your CompactLogix 5370 L2 control system.

1. Right-click the embedded I/O module and choose Properties.

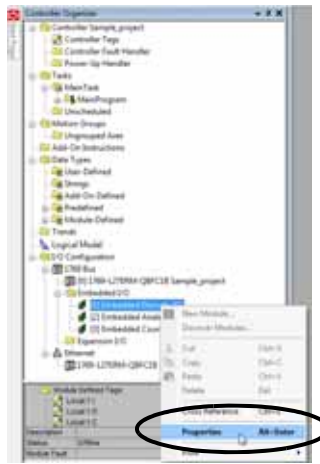

2. Click the required tab, make the necessary changes, and click OK.



IMPORTANT You can also use the tags to configure the embedded I/O modules of the CompactLogix 5370 L2 controller. When attempting to use the tags to make analog I/O module selections in the input, output and configuration data arrays, the options are complicated.

Configure Local Expansion Modules

Complete these steps to add a Compact I/O module to your CompactLogix 5370 L2 control system and configure it.

1. Right-click the 1769 Bus and choose New Module.

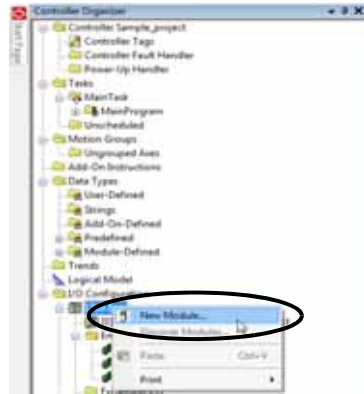

2. Select the desired I/O module and click Create.

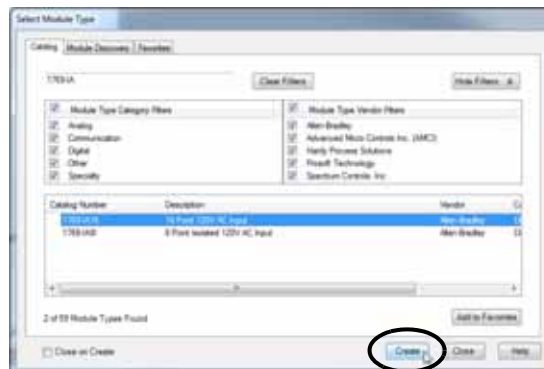

The New Module dialog box appears.

3. Configure the new I/O module as necessary and click OK.

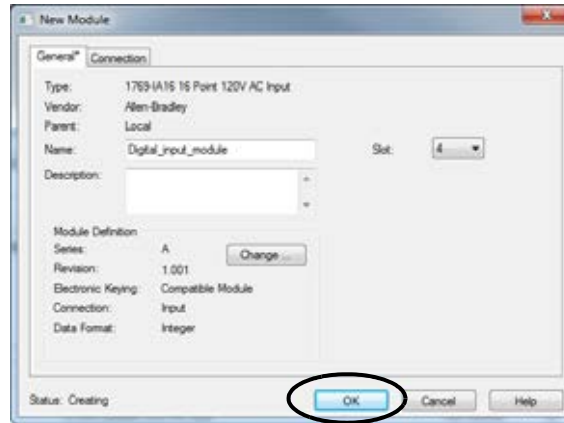

Common Configuration Parameters

While the configuration options vary from module to module, there are some common options you typically configure when using Compact I/O modules in a CompactLogix 5370 L2 control system, as described in [Table 27](#).

Table 27 - Common Configuration Parameters

Configuration Option	Description
Requested packet interval (RPI)	<p>The RPI specifies the interval at which data is transmitted or received over a connection. For 1769 Compact Local I/O modules, data is transmitted to the controller at the RPI.</p> <p>When scanned on the local bus or over an EtherNet/IP network, input modules are scanned at the RPI specified in the module configuration. Typically, you configure an RPI in milliseconds (ms). For I/O modules, the range is 0.5 . . . 750 ms.</p> <p>When scanned over a DeviceNet network via a 1769-SDN scanner in the CompactLogix 5370 L2 control system, distributed input modules are scanned at the rate the DeviceNet adapter that connects the input modules to the network supports. For example, if your system includes a remote system of 1734 POINT I/O™ modules on a DeviceNet network, the 1769-SDN scanner can only scan the distributed 1734 POINT I/O modules as quickly as the 1734-ADN DeviceNet adapter can transmit the data.</p>
Module definition	<p>Set of configuration parameters that affect data transmission between the controller and the I/O module. The parameters include the following:</p> <ul style="list-style-type: none"> • Series - Hardware series of the module. • Revision - Major and minor firmware revision levels that are used on the module. • Electronic Keying - See LOGIX-AT001 for Electronic Keying information. • Connection - Type of connection between the controller writing the configuration and the I/O module, such as Output. • Data format - Type of data that is transferred between the controller and I/O module and what tags are generated when the configuration is complete.
Module Fault on Controller If Connection Fails While in Run Mode	<p>This option determines how the controller is affected if the connection to an I/O module fails in Run mode. You can configure the project so that a connection failure causes a major fault on the controller or not.</p> <p>The default setting is for the option to be enabled, that is, if the connection to an I/O module fails in Run mode, a major fault occurs on the controller.</p>

I/O Connections

IMPORTANT You can only use direct connections with the local expansion modules in a CompactLogix 5370 L2 control system.

A Logix5000™ system uses connections to transmit I/O data, as described in [Table 28](#).

Table 28 - I/O Module Connections

Connection	Description
Direct	A direct connection is a real-time, data-transfer link between the controller and an I/O module. The controller maintains and monitors the connection. Any break in the connection, such as a module fault, causes the controller to set fault status bits in the data area that is associated with the module. Typically, analog I/O modules, diagnostic I/O modules, and specialty modules require direct connections.
Rack-optimized	For digital I/O modules, you can select rack-optimized communication. This option is used with distributed I/O modules and the Rack Optimization connection selection is made when configuring the remote adapter. For example, if your CompactLogix 5370 L2 control system includes distributed digital I/O modules over an EtherNet/IP and you want to use a rack-optimized connection with those digital I/O modules, you must configure the EtherNet/IP adapter of the distributed digital I/O modules to use a connection type of Rack Optimization. A rack-optimized connection consolidates connection usage between the controller and the digital I/O modules in a remote chassis or on one DIN rail. Rather than having individual, direct connections for each I/O module, there is one connection for the entire rack (or DIN rail).

Configure Distributed I/O Modules on an EtherNet/IP Network

Your CompactLogix 5370 L2 control system can use distributed I/O modules on an EtherNet/IP network.

IMPORTANT When adding distributed I/O modules, remember to count the remote Ethernet adapter to remain within the maximum number of EtherNet/IP network nodes limitation for your controller.

The distributed I/O modules that are connected to the controller via the remote Ethernet adapter are not counted toward the maximum Ethernet node limit for the controller.

For example, a 1769-L27ERM-QBFC1B controller supports up to 16 Ethernet nodes. You can add up to 16 remote Ethernet adapters to the I/O Configuration section because each remote adapter counts against the node count. However, you can add as many remote I/O modules to the chassis of the adapter as necessary. Remote I/O modules do not count against the node count.

For more information on node limitations, see [Nodes on an EtherNet/IP Network on page 123](#).

Complete these steps to configure distributed I/O modules on an EtherNet/IP network.

1. Right-click Ethernet and choose New Module.

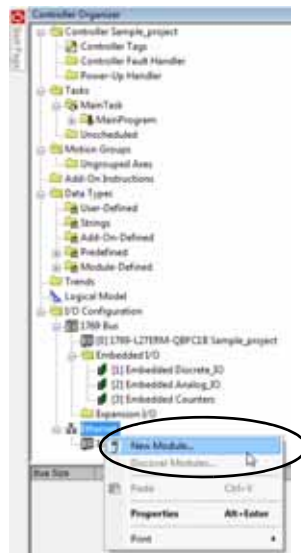

2. Select the desired Ethernet adapter and click Create.

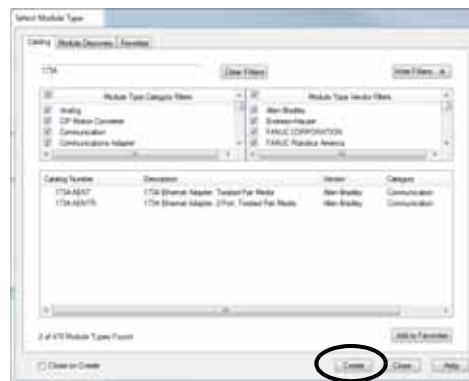

The New Module dialog box appears.

- Configure the new Ethernet adapter as necessary and click OK.



- Right-click the new adapter and choose New Module.

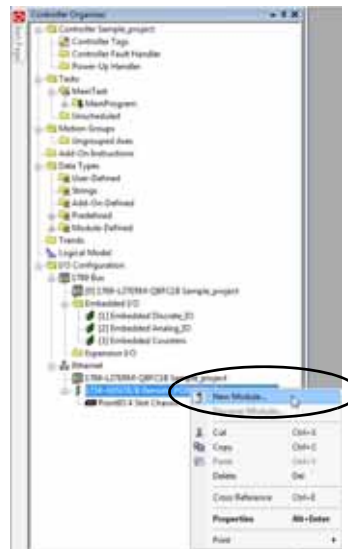

- Select the desired I/O module and click Create.



The New Module dialog box appears.

6. Configure the new I/O module as necessary and click OK.

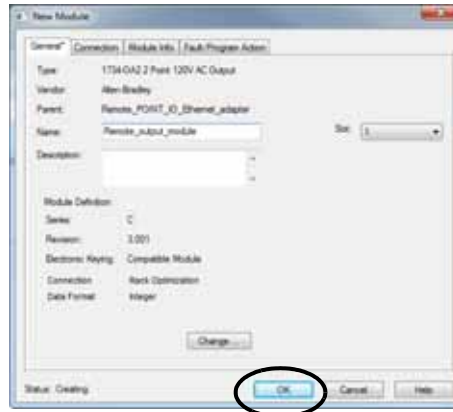

7. Repeat these steps to add all desired distributed I/O modules.

The following graphic is an example of a 1769-L27ERM-QBFC1B control system that uses distributed I/O modules over an EtherNet/IP network.

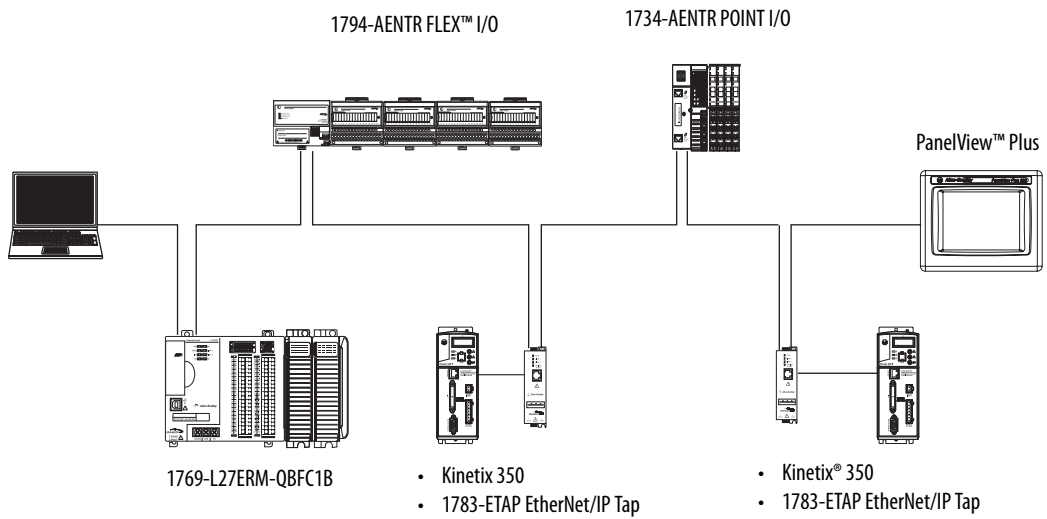

Configure Distributed I/O Modules on a DeviceNet Network

Your CompactLogix 5370 L2 control system can use distributed I/O modules on a DeviceNet network.

Complete these steps to configure distributed I/O modules on a DeviceNet network.

1. If you have not done so, install a 1769-SDN Compact I/O DeviceNet scanner into the local bank of your CompactLogix 5370 L2 control system.
2. Right-click 1769 Bus and choose New Module.

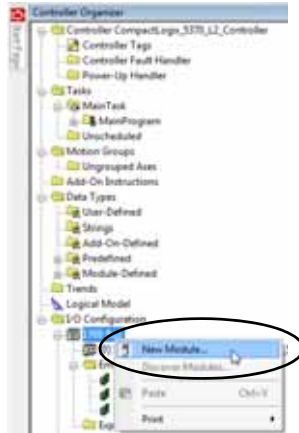

3. Select the 1769-SDN scanner and click Create.



4. Choose a Major Revision and click OK.

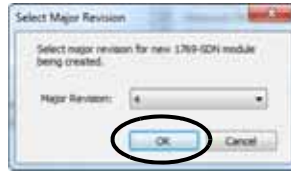

The New Module dialog box appears.

5. Configure the new 1769-SDN scanner as necessary and click OK.

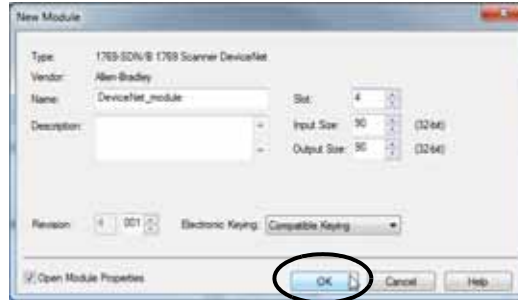

6. Use RSNetWorx for DeviceNet software to define the scan list in the 1769-SDN scanner to communicate data between the devices and the controller through the scanner.

The following graphic is an example of a 1769-L27ERM-QBFC1B control system that uses distributed I/O modules on a DeviceNet network.

- 1769-L27ERM-QBFC1B
- 1769-SDN

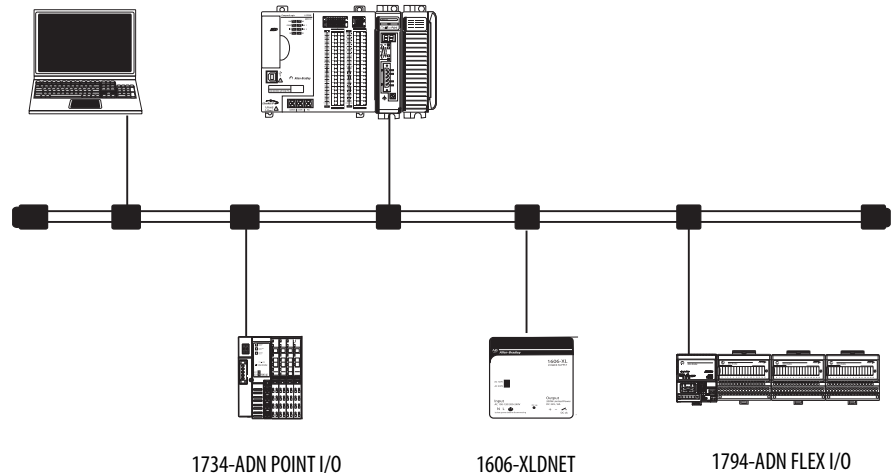

Monitor I/O Modules

With CompactLogix 5370 L2 controllers, you can use the following options to monitor I/O modules:

- QuickView™ Pane below the Controller Organizer
- Connection tab in the Module Properties dialog box
- Programming logic to monitor fault data so you can act.

When a fault occurs on an I/O module, a yellow triangle on the module listing in the Controller Organizer alerts you to the fault, as shown in this graphic.

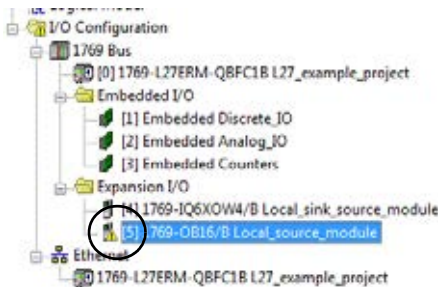

This graphic shows the **Quick View Pane**, which indicates the type of fault.

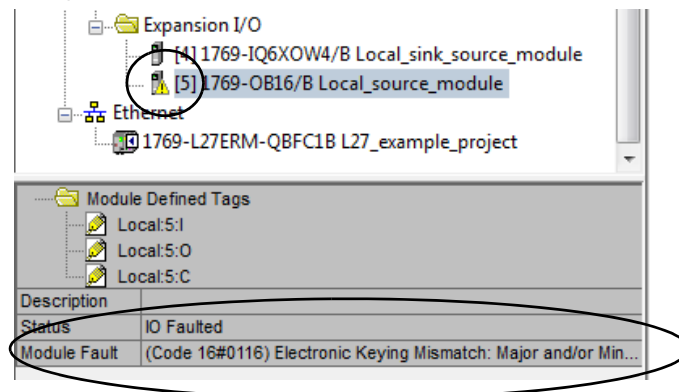

To see the fault description on the **Connection tab** in Module Properties dialog box, complete these steps.

1. In the I/O Configuration, right-click the faulted I/O module and choose Properties.

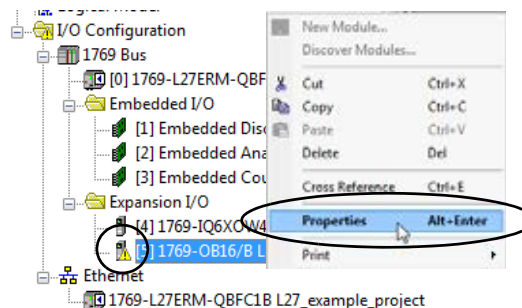

2. Click the Connection tab and use the fault description, in the Module Fault section, to diagnose the issue.

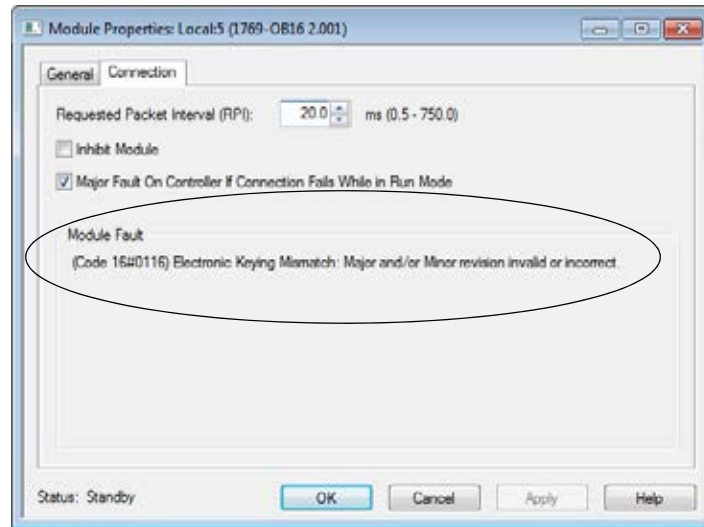

3. Click OK to close the dialog box and remedy the issue.

End Cap Detection and Module Faults

End cap detection is performed through the last module on a 1769 Bus. If that module experiences a fault such that it cannot communicate on the 1769 Bus, the following events occur:

- End cap detection fails
- Controller faults

Notes:

Use I/O Modules with CompactLogix 5370 L3 Controllers

This chapter explains how to use Compact I/O™ modules in a CompactLogix™ 5370 L3 control system.

Topic	Page
Select I/O Modules	235
Validate I/O Layout	240
Configure I/O	251
Configure Distributed I/O Modules on an EtherNet/IP Network	253
Configure Distributed I/O Modules on a DeviceNet Network	256
Monitor I/O Modules	258

Select I/O Modules

CompactLogix 5370 L3 control systems offer these I/O module options:

- [Local Expansion Modules](#)
- [Distributed I/O Modules over an EtherNet/IP Network](#)
- [Configure Distributed I/O Modules on a DeviceNet Network](#)

Local Expansion Modules

CompactLogix 5370 L3 control systems support the use of Compact I/O modules as local expansion modules along a CompactBus backplane.

Consider the following when using local expansion modules:

- The controllers support this many local Compact I/O modules across up to three I/O banks, that is, the local bank and two more banks.

Cat. No.	Local Expansion Modules Supported, max
1769-L30ER 1769-L30ERM 1769-L30ER-NSE	8
1769-L33ER 1769-L33ERM	16
1769-L33ERMO	—
1769-L36ERM	30
1769-L36ERMO	—
1769-L37ERM, 1769-L37ERMK	31
1769-L37ERMO ⁽¹⁾	—
1769-L38ERM, 1769-L38ERMK	31
1769-L38ERMO ⁽¹⁾	—

(1) Available at software version 31 and firmware revision 31.

- When possible, use specialty Compact I/O modules to meet unique application requirements.
- Consider using a 1492 wiring system for each I/O module as an alternative to the terminal block that comes with the module.
- Use 1492 PanelConnect™ modules and cables if you are connecting input modules to sensors.

Install Local Expansion Modules

Complete these steps to install local expansion modules in your CompactLogix 5370 L3 control system:

1. Attach the 1769 Compact communication or I/O modules as described in these publications:
 - Compact I/O Modules Installation Instructions, publication [1769-IN088](#)
 - Compact I/O DeviceNet Scanner Module Installation Instructions, publication [1769-IN060](#)

2. If your system uses only a **local bank**, complete these steps.
 - a. Use the tongue-and-groove slots to attach a 1769-ECR Compact I/O end cap terminator to the last module in the system.
 - b. Move the lever of the end cap bus terminator fully to the left until it clicks to lock the end cap bus terminator.
3. If your system uses **more banks**, follow these steps.
 - a. Install a 1769-CR x Compact I/O communication bus expansion cable at the right end of the **local bank**.
 - b. Connect the 1769-CR x cable to the additional bank as necessary.

How you connect to the first extra bank—on the right or left side of the bank, determines the expansion cable that is installed at the end of the local bank. See [Figure 38](#) for examples of how to connect a local bank to extra banks.

- c. Complete the installation of the remaining banks in your system.

IMPORTANT Make sure that you install an end cap at the end of the last bank in your system.

The following example shows example systems with local expansion modules included.

Figure 38 - Example CompactLogix 5370 L3 Control Systems

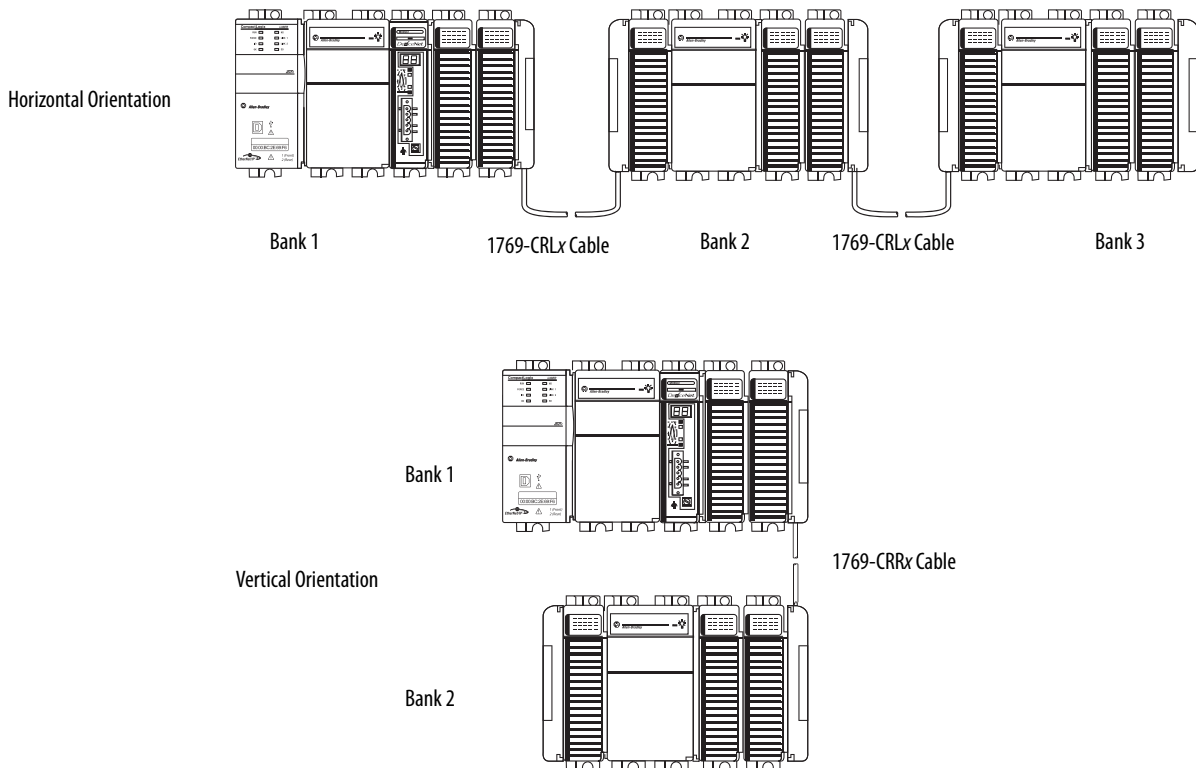

Wire Local Expansion Modules

Wire each Compact I/O module that is used as a local expansion module according to the technical documentation for that module.

Distributed I/O Modules over an EtherNet/IP Network

You can include distributed I/O modules over an EtherNet/IP network in your CompactLogix 5370 control system. Consider the following when using distributed I/O modules over an EtherNet/IP network:

- Each remote EtherNet/IP adapter included in the system must be counted toward the maximum number of EtherNet/IP nodes for the controller.

For more information on maximum number of EtherNet/IP nodes, see [Nodes on an EtherNet/IP Network on page 123](#).

- The configurable RPI settings vary depending on which distributed I/O modules are used in the system.
- For information to add distributed I/O modules to your CompactLogix 5370 control system, see [Configure Distributed I/O Modules on a DeviceNet Network on page 256](#).

The following graphic shows an example 1769-L33ERM control system that uses local expansion modules and distributed I/O modules over an EtherNet/IP network.

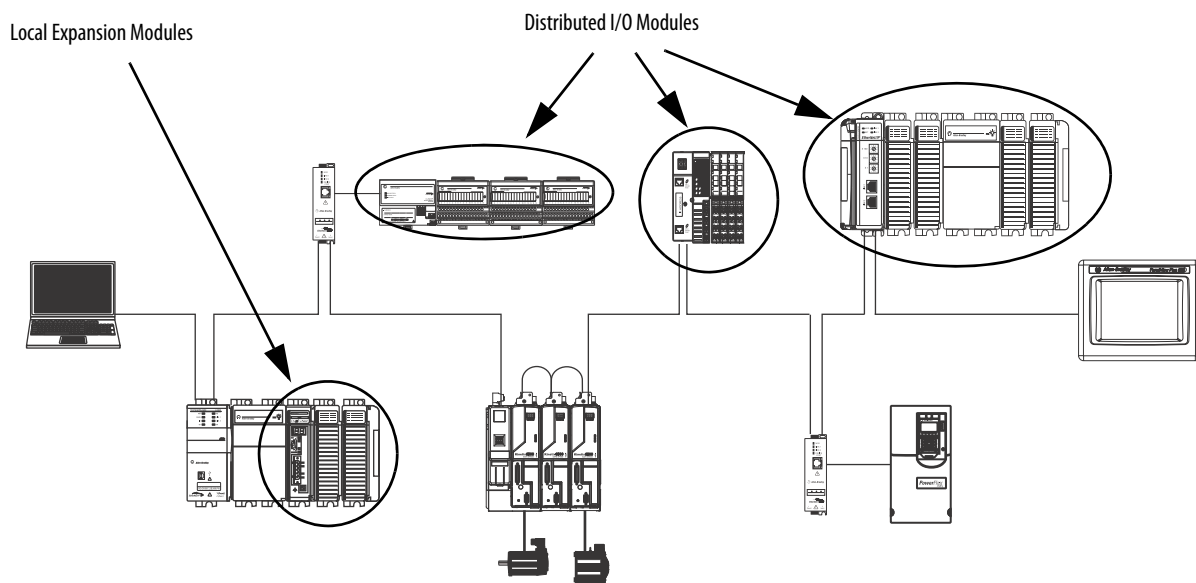

Distributed I/O Modules over a DeviceNet Network

You can include distributed I/O modules over a DeviceNet network in your CompactLogix 5370 L3 control system. Consider the following when using distributed I/O modules over a DeviceNet network:

You must use the following to use distributed I/O modules over a DeviceNet network in your CompactLogix 5370 L3 control system:

- Logix Designer application or the Studio 5000® environment - For more information, see [Configure Distributed I/O Modules on an EtherNet/IP Network on page 253](#).
- RSNetWorx™ for DeviceNet software - For more information, see [DeviceNet Network Communication on page 134](#).

The following graphic shows an example 1769-L33ERM control system that uses local expansion modules and distributed I/O modules over a DeviceNet network.

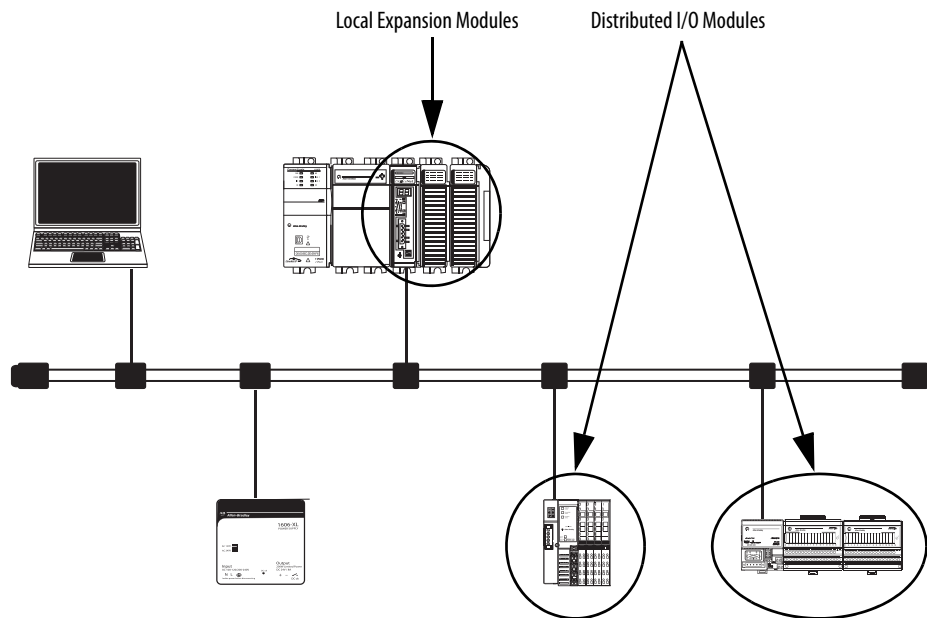

Validate I/O Layout

After you have selected your I/O modules, you must validate the system that you want to design. Consider these points when validating I/O layout placement:

- [Estimate Requested Packet Interval](#)
- [Module Fault Related to RPI Estimates](#)
- [Calculate System Power Consumption](#)
- [Power Supply Distance Rating](#)
- [Physical Placement of I/O Modules](#)

Estimate Requested Packet Interval

The requested packet interval (RPI) defines the frequency at which the controller sends data to and receives data from I/O modules. You set an RPI rate for each I/O module in your system.

The CompactLogix 5370 L3 controllers attempt to scan an I/O module at the configured RPI rate. For individual I/O modules, a [Module RPI Overlap](#) minor fault occurs if there is at least one I/O module that cannot be serviced within its RPI time.

The configuration parameters for a system determine the impact on actual RPI rates. These configuration factors can affect the effective scan frequency for any individual module:

- Rates at which RPI rates are set for other Compact I/O modules
- Number of other Compact I/O modules in the system
- Types of other Compact I/O modules in the system
- Application user task priorities

[Table 29](#) describes RPI rate guidelines.

Table 29 - Requested Packet Interval Guidelines

Type of Module	Guidelines ⁽¹⁾
All digital	The following guidelines apply: <ul style="list-style-type: none"> 1...2 modules can be scanned in 0.5 ms. 3...4 modules can be scanned in 1 ms. 5...30 modules can be scanned in 2 ms.
Mix of digital and analog or all analog	The following guidelines apply: <ul style="list-style-type: none"> 1...2 modules can be scanned in 0.5 ms. 3...4 modules can be scanned in 1 ms. 5...13 modules can be scanned in 2 ms. 14...30 modules can be scanned in 3 ms.
Specialty	The following conditions apply: <ul style="list-style-type: none"> For every 1769-SDN module in the system, increase the RPI of every other module by 2 ms. For every 1769-HSC module in the system, increase the RPI of every other module by 1 ms. For every 1769-ASCII module in the system, increase the RPI of every other module by 1 ms. For every 1769-SM2 module in the system, increase the RPI of every other module by 2 ms.

- (1) The guidelines in [Table 29](#) do not factor in the following items, which affect CMX5370 controller CPU loading:
 I/O RPI timing does not affect the task priority. Event and periodic tasks have higher priority than I/O and user tasks.
 IOT (Immediate Output Instruction)
 Messaging
 CompactBus browsing such as accessing DeviceNet network through 1769-SDN by using CMX5370 Ethernet or USB connection
 Module RPI guidelines can require adjustment (increase of 1 ms or more) if CMX5370 controller application includes one or more of the listings in [Table 29](#). Monitor controller minor faults to determine if Module RPI overlaps have occurred.

You can set the RPI rates of individual Compact I/O modules higher than the rates listed in [Table 29](#). The RPI shows how quickly modules can be scanned, not how quickly an application can use the data. The RPI is asynchronous to the program scan. Other factors, such as program execution duration, affect I/O throughput.

Module Fault Related to RPI Estimates

When following the guidelines described in [Table 29](#), most CompactLogix 5370 L3 control systems operate as expected. Some systems that follow the guidelines can experience a Module RPI Overlap minor fault as described in the following table.

Name	Fault Information	Condition In Which Fault Occurs
Module RPI Overlap	<p>(Type 03) I/O fault (Code 94) Module RPI overlap detected</p> <p>Module Slot = x, where x is the slot number of the I/O module in the I/O Configuration section</p>	<p>This fault is logged when the current RPI update of an I/O module overlaps with its previous RPI update. The Minor Faults tab in the Controller Properties dialog box indicates in which module the RPI overlap occurs.</p> <p>If multiple I/O modules experience the fault, the application indicates that the fault occurred on the first such I/O module. Typically, it is an I/O module with a large Input/Output array sizes. Example modules that use large Input/Output array sizes include the 1769-SDN and 1769-HSC modules. In these cases, we recommend that you adjust the RPI of the module to eliminate the fault.</p> <p>Once the fault is cleared from the first I/O module, the application indicates the next module that experiences the fault. This pattern continues until the fault is cleared from all affected I/O modules.</p> <p>To avoid this fault, set the RPI rate of the I/O modules to higher numerical values. We recommend that you use an RPI value that is not a common multiple of other module RPI values, such as 2.5 ms, 5.5 ms, or 7 ms.</p> <ul style="list-style-type: none"> • We recommend that you do not run CompactLogix 5370 L3 control systems with Module RPI Overlap faults. • A system that experiences many Module RPI Overlap faults cannot operate optimally because I/O data is not sampled at the expected rate that the RPI settings determine. • When the project is downloaded or the RPI value of an I/O module is adjusted, it is expected to have a minor fault. Faults under these conditions are transitional. Clear the fault and wait for the fault to reappear before adjusting the RPI value or the task priorities.

Calculate System Power Consumption

The 1769 Compact I/O power supplies provide power to CompactLogix local and more banks. The provided power is measured in current capacity.

Consider these points when designing your CompactLogix 5370 L3 control system banks:

- 1769 Compact I/O power supplies have two maximum current capacity requirements that affect how you design and configure one bank.

The following are the maximum current capacity requirements:

- Maximum current capacity for one bank
- Maximum current capacity for each side of the power supply

Current Capacity for Single Bank

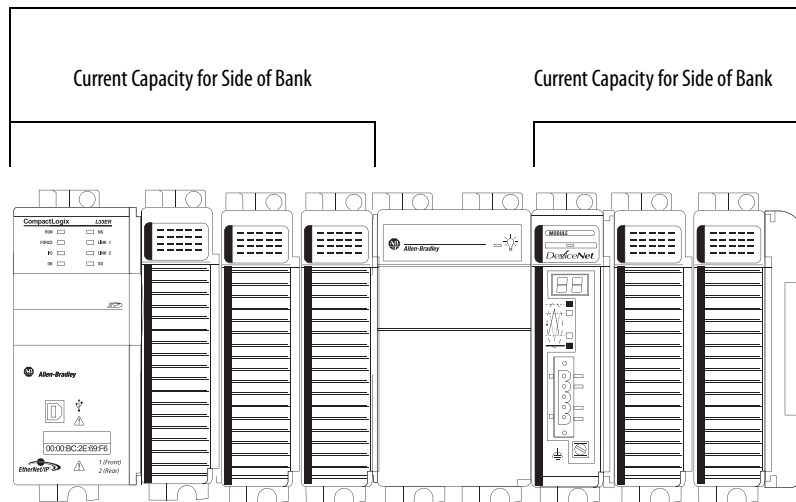

- The maximum current capacity requirements vary by the power supply that is used in the bank.

Power Supply Cat. No.	Current Capacity, max, for Single Bank	Current Capacity, max, for Each Side of Bank ⁽¹⁾
1769-PA2	2 A at 5V DC and 0.8 A at 24V DC	1 A at 5V DC and 0.4 A at 24V DC
1769-PB2		
1769-PA4	4 A at 5V DC and 2 A at 24V DC	2 A at 5V DC and 1 A at 24V DC
1769-PB4		

(1) Specification for banks with devices on left and right sides of the power supply.

Calculate Power Consumption in Single Bank

IMPORTANT One bank requires the CompactLogix 5370 L3 controllers to reside in the leftmost slot. At minimum, you must calculate the power consumption of the controller on the left side of the power supply.

If more modules are installed on the left side of the power supply, you must calculate the power consumption for those modules as well.

If more modules are installed to the right of the power supply, you must calculate the power consumption for that side separately.

Use [Table 30](#) to calculate power consumption in one bank.

Table 30 - Module Power Consumption Calculation for a Local Bank

Side of Power Supply	Device Cat. No.	Number of Modules ⁽³⁾	Module Current Requirements		Calculated Current = (Number of Modules) x (Module Current Requirements)	
			at 5V DC (in mA)	at 24V DC (in mA)	at 5V DC (in mA)	at 24V DC (in mA)
Left - Required	1769-L30ER	1	500	225	500	225
	1769-L30ERM					
	1769-L30ER-NSE					
	1769-L33ER					
	1769-L33ERM					
	1769-L36ERM					
	1769-L37ERM					
	1769-L37ERMK					
	1769-L38ERM					
	1769-L38ERMK					
Left - Optional	I/O Module-specific	Up to 3	Module-specific	Module-specific		
	Total Current Required⁽²⁾:					
Right	I/O Module-specific	Up to 8	Module-specific	Module-specific		
	Total Current Required⁽²⁾:					
Total Current Required for Single Bank if Modules Are Installed on Both Sides of the Power Supply⁽¹⁾:						

- (1) This number must not exceed the power supply current capacity for the bank.
- (2) This number must not exceed the power supply current capacity for this side of the bank.
- (3) In the local bank, you can only install up to three modules to the left of the power supply. This limitation is because the CompactLogix 5370 L3 controllers have a power supply distance rating of four and must be within four slots of the Compact I/O power supply. On the right side of the power supply in the local bank and both sides of the power supply in more banks, you can install up to eight modules. This configuration is possible only if the power supply distance ratings for the modules validate the system design.

Calculate Power Consumption in an Additional Bank

IMPORTANT In extra banks, you can install I/O modules to the left side, right side, or both sides of the power supply.
The system design determines how to use [Table 31](#).

Use this table to calculate power consumption in an extra bank.

Table 31 - Module Power Consumption Calculation for an Additional Bank

Side of Power Supply	Device Cat. No.	Number of Modules ⁽³⁾	Module Current Requirements		Calculated Current = (Number of Modules) x (Module Current Requirements)	
			at 5V DC (in mA)	at 24V DC (in mA)	at 5V DC (in mA)	at 24V DC (in mA)
Left - Optional in an extra bank	I/O Modules IMPORTANT: Insert a separate row in this calculation for each I/O module.	Up to 8	Module-specific	Module-specific		
			Total Current Required⁽²⁾:			
Right - Optional in one bank	I/O Modules IMPORTANT: Insert a separate row for each I/O module.	Up to 8	Module-specific	Module-specific		
			Total Current Required⁽²⁾:			
Total Current Required for Bank if Modules Are Installed on Both Sides of the Power Supply⁽¹⁾:						

- (1) This number must not exceed the power supply current capacity for the bank.
- (2) This number must not exceed the power supply current capacity for this side of the bank.
- (3) You can install up to eight modules in additional banks if the power supply distance ratings for the modules validate the system design.

Physical Placement of I/O Modules

Depending on the controller catalog number, CompactLogix 5370 L3 controllers support from 8 to 30 I/O modules. For more information on catalog numbers, see [Local Expansion Modules on page 236](#).

Consider these factors when determining the physical placement of the I/O modules:

- You can install I/O modules in local and extra banks.
- You can install I/O modules to the left and right of the power supply.
- When a system requires multiple banks, you can install the additional banks horizontally or vertically, as shown in this graphic.

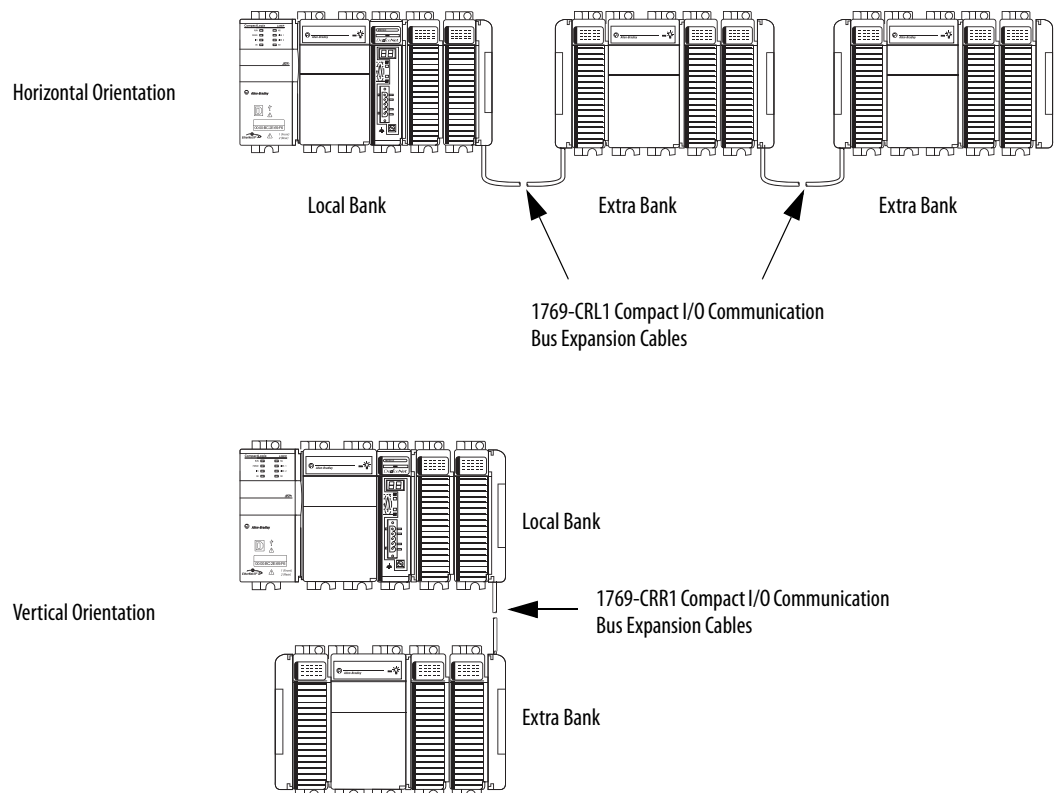

- Each I/O module also has a power supply distance rating and maximum current draw. Considered jointly, distance ratings and current draw determine where I/O modules can be placed in a bank and what configuration of modules can be installed in the bank.

For more information on power supply distance ratings, see [Power Supply Distance Rating on page 81](#). For more information on system power consumption, see [Calculate System Power Consumption on page 243](#).

Local Bank

To validate the local bank design, confirm that the design meets these requirements:

- The controller is the leftmost device in the local bank.
- No more than three modules are installed between the controller and the left side of the power supply.
- No more than eight modules are installed to the right of the power supply.
- The power consumption of the modules on each side of the power supply does not exceed the capacity of the power supply for that side.
- The total power consumption by all modules in the bank does not exceed the capacity of the power supply for the entire bank.
- Modules are installed such that all power supply distance rating and system power consumption requirements are met.

For example, the 1769-SDN scanner has a power supply distance rating of four. If the design includes the installation of a 1769-SDN scanner with greater than three modules between it and the power supply, the design is invalid.

IMPORTANT Make sure that you take power supply distance ratings into consideration when you design a system. If you install a module that violates its power supply distance rating specification, the system can operate normally for a time, but experience operational issues, such as I/O faults.

The following example graphic shows a local bank.

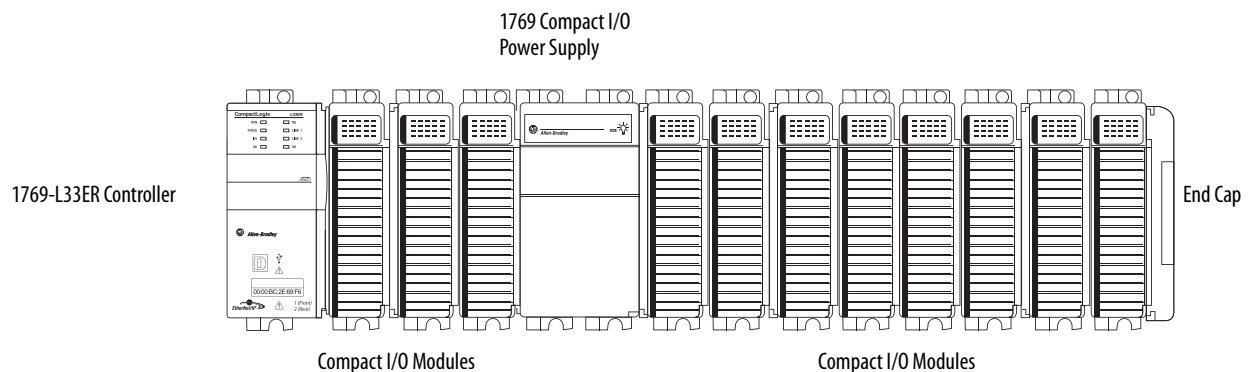

Additional Banks

If your application calls for twelve or more I/O modules, at minimum, you must install the modules in extra banks. The conditions of each application determine the number of extra banks.

Once the local bank design is validated, you must validate the design for any additional banks. To validate extra bank designs, confirm that the design meets these requirements:

- Compact I/O communication bus expansion cables are used properly.

TIP Compact I/O expansion cables have the same dimensions as the end caps regardless of whether they are installed at the right or left side of the communication bus.

- No more than eight modules are installed on either side of the power supply.
- The power consumption of the modules on each side of the power supply does not exceed the capacity of the power supply for that side.
- Modules are installed such that all power supply distance rating requirements are met.
- End caps are installed properly, as shown in the following graphic.

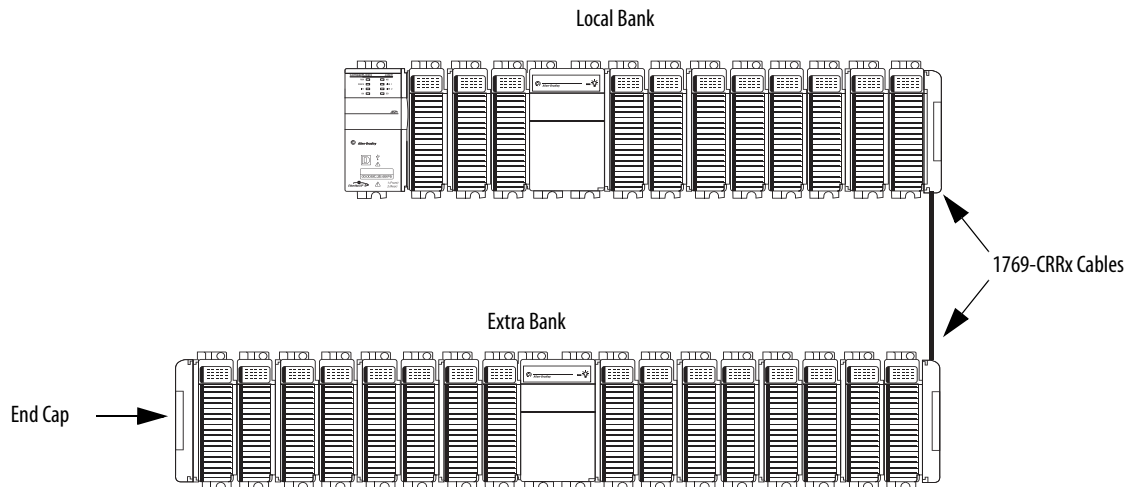

Power Supply Distance Rating

CompactLogix 5370 L3 control systems do not have embedded I/O modules. You begin counting local expansion slots with the first Compact I/O module installed next to the power supply when determining where to install a Compact I/O module and meet its power supply distance rating.

In CompactLogix 5370 L3 control systems, you can install Compact I/O modules to the left or right side of the power supply. You can also use local and extra banks in CompactLogix 5370 L3 control systems, with each allowing the inclusion of Compact I/O modules.

Local Bank

In the local bank, the controller must be the leftmost device in the system and you can only install up to three modules between the controller and the power supply. Therefore, any Compact I/O modules that are installed to the left of the power supply in the local bank are in a module slot that meets the power supply distance rating requirements for the module.

Additional Banks

CompactLogix 5370 L3 control systems also support the use of extra banks for the local expansion modules of the system. Every additional bank requires a 1769 Compact I/O power supply. The bank can be designed with local expansion modules on either side of the power supply.

Most Compact I/O modules have power supply distance rating values that allow you to install them in any slot on either side of the power supply in extra banks. Some Compact I/O modules have power supply distance ratings that affect where you can install them in the CompactLogix 5370 L3 control system.

For example, the 1769-ASCII Compact ASCII and 1769-HSC Compact high-speed counter modules each have a power supply distance rating of four. These modules can be installed in local expansion module slots one through three.

In this case, you must install the 1769-ASCII module and 1769-HSC high-speed counter module with no more three Compact I/O modules between the module and the power. This requirement is true regardless of whether the modules are installed to the left or right of the power supply.

This graphic shows 1769-HSC high-speed counter modules that are installed in a 1769-L36ERM control system that meet the power supply distance rating of the module.

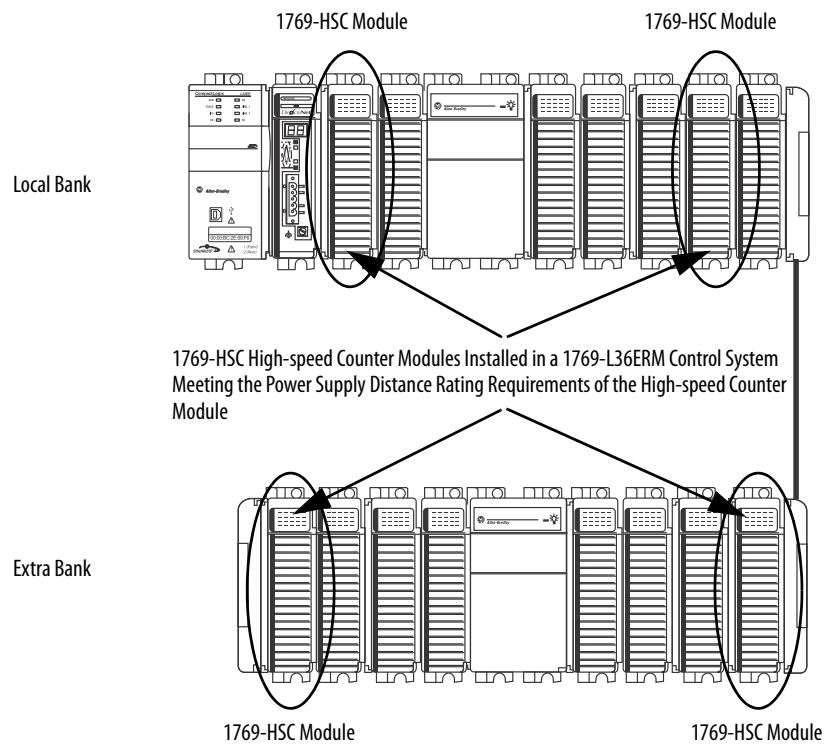

IMPORTANT [Table 31](#) shows example systems with 1769-HSC high-speed counter modules in each control system because it has a power supply distance rating of four and cannot be installed as far from the Compact I/O power supply. Most Compact I/O modules have power supply distance ratings that allow you to install them anywhere in the local expansion slots of a CompactLogix 5370 L2 control system.

For more information about the power supply distance rating for a Compact I/O module, see CompactLogix Selection Guide, publication [1769-SG001](#).

Configure I/O

Complete these steps to add a Compact I/O module to your CompactLogix 5370 L3 control system and configure it.

1. Right-click the 1769 Bus and choose New Module.

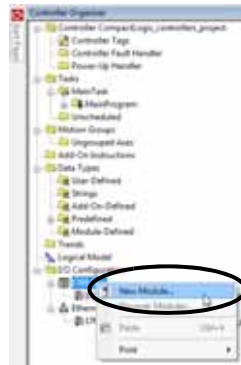

2. Select the desired I/O module and click Create.



The New Module dialog box appears.

3. Configure the new I/O module as necessary and click OK.

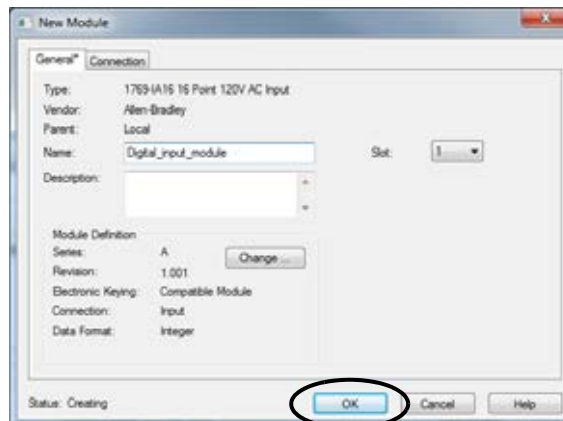

Common Configuration Parameters

While the configuration options vary from module to module, there are some common options you typically configure when using Compact I/O modules in a CompactLogix 5370 L3 control system, as described in [Table 32](#).

Table 32 - Common Configuration Parameters

Configuration Option	Description
Requested packet interval (RPI)	<p>The RPI specifies the interval at which data is transmitted or received over a connection. For 1769 Compact Local I/O modules, data is transmitted to the controller at the RPI.</p> <p>When scanned on the local bus or over an EtherNet/IP network, input modules are scanned at the RPI specified in the module configuration. Typically, you configure an RPI in milliseconds (ms). For I/O modules, the range is 0.5 . . . 750 ms.</p> <p>When scanned over a DeviceNet network, distributed input modules are scanned at the rate that the DeviceNet adapter that connects the input modules to the network supports. For example, the scan rate for distributed 1734 POINT I/O™ over DeviceNet can only occur as quickly as the 1734-ADN DeviceNet adapter can transmit the data.</p>
Module definition	<p>Set of configuration parameters that affect data transmission between the controller and the I/O module. The parameters include the following:</p> <ul style="list-style-type: none"> • Series - Hardware series of the module. • Revision - Major and minor firmware revision levels that are used on the module. • Electronic Keying - See LOGIX-AT001 for Electronic Keying information. • Connection - Type of connection between the controller writing the configuration and the I/O module, such as Output. • Data format - Type of data that is transferred between the controller and I/O module and what tags are generated when the configuration is complete.
Module Fault on Controller If Connection Fails While in Run Mode	<p>This option determines how the controller is affected if the connection to an I/O module fails in Run mode. You can configure the project so that a connection failure causes a major fault on the controller or not.</p> <p>The default setting is for the option to be enabled, that is, if the connection to an I/O module fails in Run mode, a major fault occurs on the controller.</p>

I/O Connections

A Logix5000™ system uses connections to transmit I/O data, as described in [Table 33](#).

Table 33 - I/O Module Connections

Connection	Description
Direct	<p>A direct connection is a real-time, data-transfer link between the controller and an I/O module. The controller maintains and monitors the connection. Any break in the connection, such as a module fault, causes the controller to set fault status bits in the data area that is associated with the module.</p> <p>Typically, analog I/O modules, diagnostic I/O modules, and specialty modules require direct connections.</p>
Rack-optimized	<p>For digital I/O modules, you can select rack-optimized communication.</p> <p>This option is used with distributed I/O modules and the Rack Optimization connection selection is made when configuring the remote adapter. For example, if you want to use a rack-optimized connection with digital I/O modules in a remote 1734 POINT I/O system, you configure the 1734-AENT(R) module to use a connection type of Rack Optimization.</p> <p>A rack-optimized connection consolidates connection usage between the controller and the digital I/O modules in a remote chassis or on one DIN rail. Rather than having individual, direct connections for each I/O module, there is one connection for the entire rack (or DIN rail).</p>

Configure Distributed I/O Modules on an EtherNet/IP Network

Your CompactLogix 5370 L3 control system can use distributed I/O modules on an EtherNet/IP network.

IMPORTANT When adding distributed I/O modules, remember to count the remote Ethernet adapter to remain within the maximum number of EtherNet/IP network nodes limitation for your controller.

The remote I/O modules that are connected to the controller via the Ethernet adapter are not counted toward the maximum Ethernet node limit for the controller.

For more information on node limitations, see [Nodes on an EtherNet/IP Network on page 123](#).

Complete these steps to configure distributed I/O modules on an EtherNet/IP network.

1. Right-click Ethernet and choose New Module.

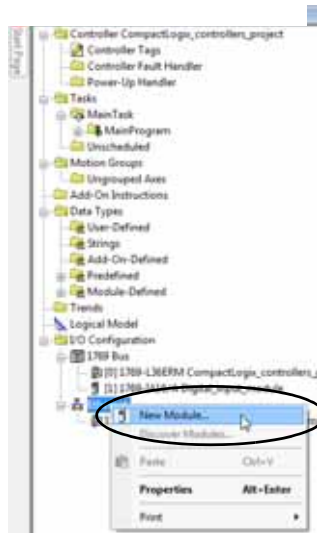

2. Select the desired Ethernet adapter and click Create.



The New Module dialog box appears.

- Configure the new Ethernet adapter as necessary and click OK.



- Right-click the new adapter and choose New Module.

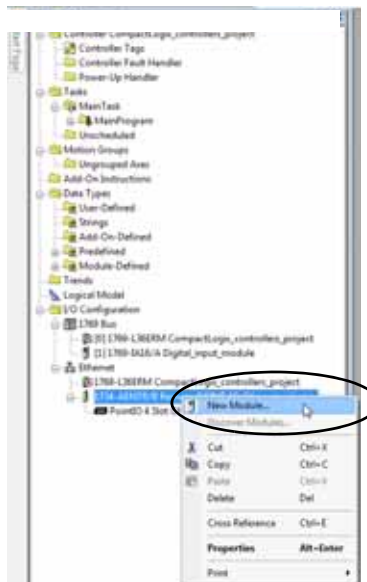

- Select the desired I/O module and click Create.

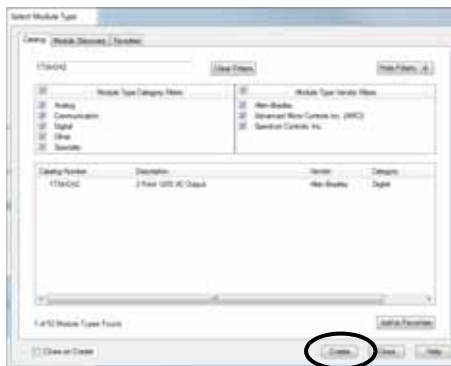

The New Module dialog box appears.

6. Configure the new I/O module as necessary and click OK.



7. Repeat these steps to add the desired distributed I/O modules.

The following graphic is an example of a 1769-L33ERM control system that uses distributed I/O modules over an EtherNet/IP network.

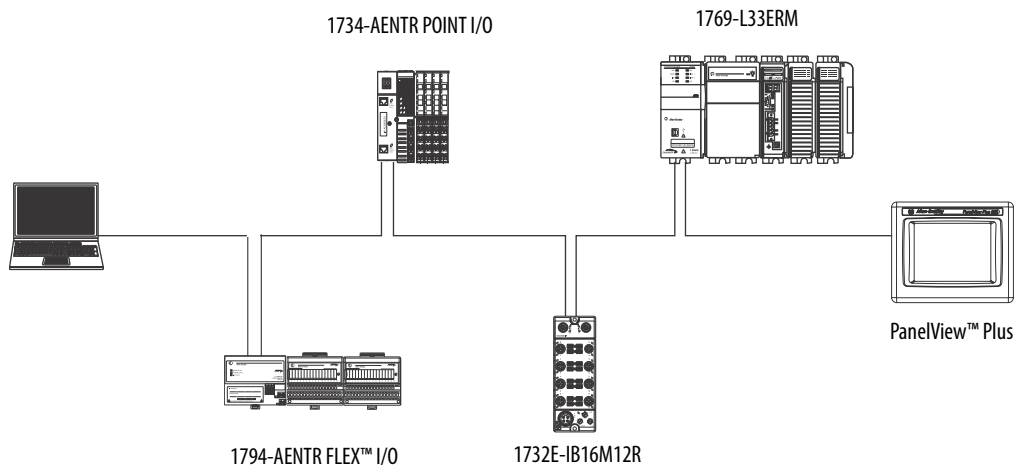

5. Configure the new 1769-SDN scanner as necessary and click OK.

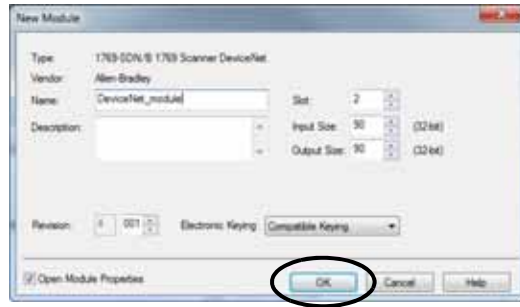

6. Use RSNetWorx for DeviceNet software to define the scan list in the 1769-SDN scanner to communicate data between the devices and the controller through the scanner.

The following graphic is an example of a 1769-L33ERM control system that uses distributed I/O modules on a DeviceNet network.

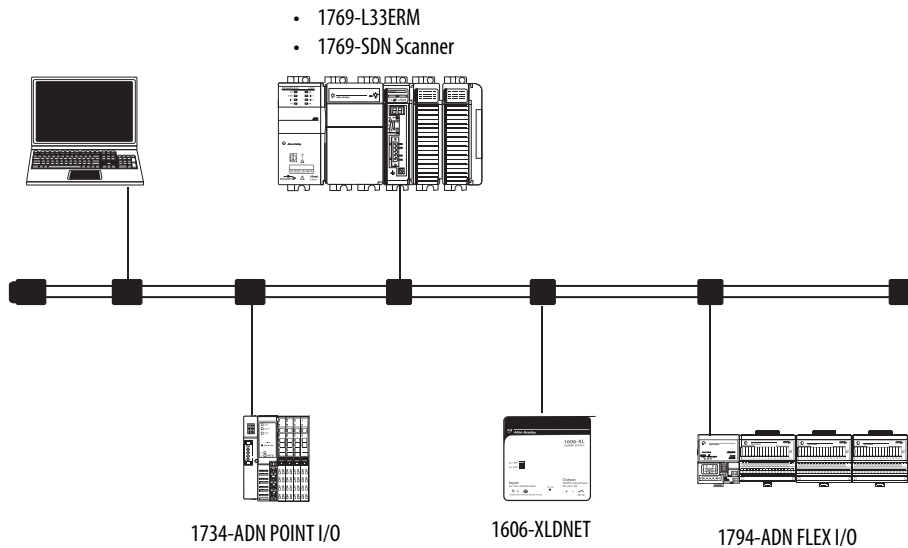

Monitor I/O Modules

With CompactLogix 5370 L3 controllers, you can monitor I/O modules in the following ways:

- QuickView™ Pane below the Controller Organizer
- Connection tab in the Module Properties dialog box
- Programming logic to monitor fault data so you can act

When a fault occurs on an I/O module, a yellow triangle on the module listing in the Controller Organizer alerts you to the fault.

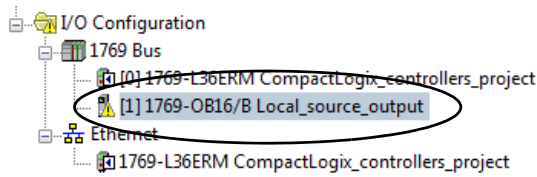

This graphic shows the **Quick View Pane**, which indicates the type of fault.

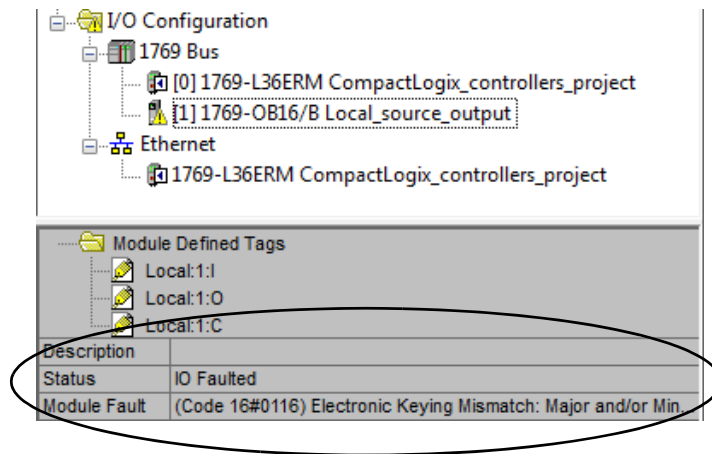

To see the fault description on the **Connection tab** in Module Properties dialog box, complete these steps.

1. In the I/O Configuration, right-click the faulted I/O module and choose Properties.

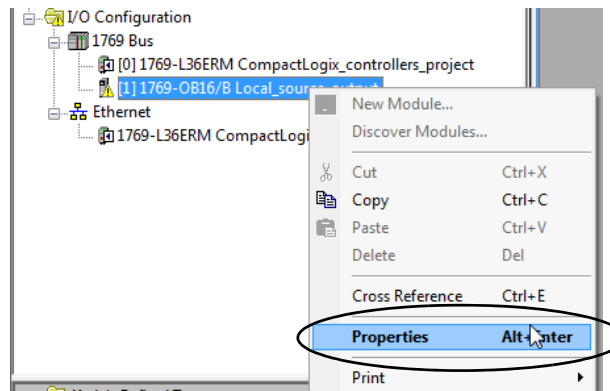

2. Click the Connection tab and use the fault description, in the Module Fault section, to diagnose the issue.

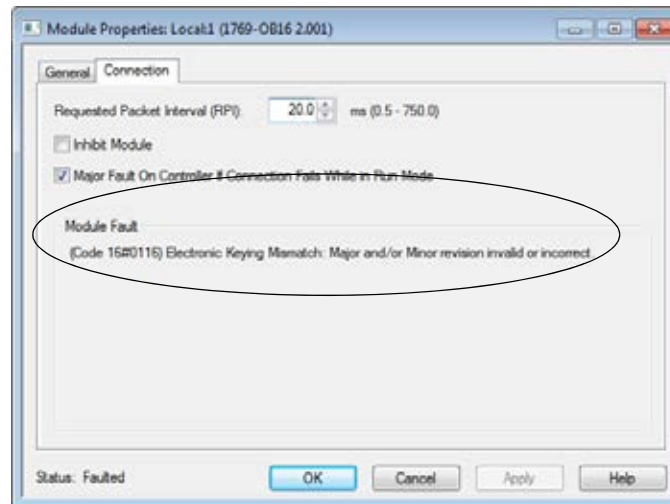

3. Click OK to close the dialog box and remedy the issue.

End Cap Detection and Module Faults

End cap detection is performed through the last module on a 1769 Bus. If that module experiences a fault such that it cannot communicate on the 1769 Bus, the following events occur:

- End cap detection fails
- Controller faults

Notes:

Develop Applications

Topic	Page
Elements of a Control Application	261
Tasks	262
Programs	266
Routines	268
Tags	269
Programming Languages	272
Add-On Instructions	273
Access the Module Object	274
Monitoring Controller Status	276
Monitoring I/O Connections	277
System Overhead Time Slice	280

Elements of a Control Application

A control application is composed of several elements that require planning for efficient application execution. Application elements include the following:

- Tasks
- Programs
- Routines
- Parameters and Local Tags

Figure 39 - Elements of a Control Program

Control Application

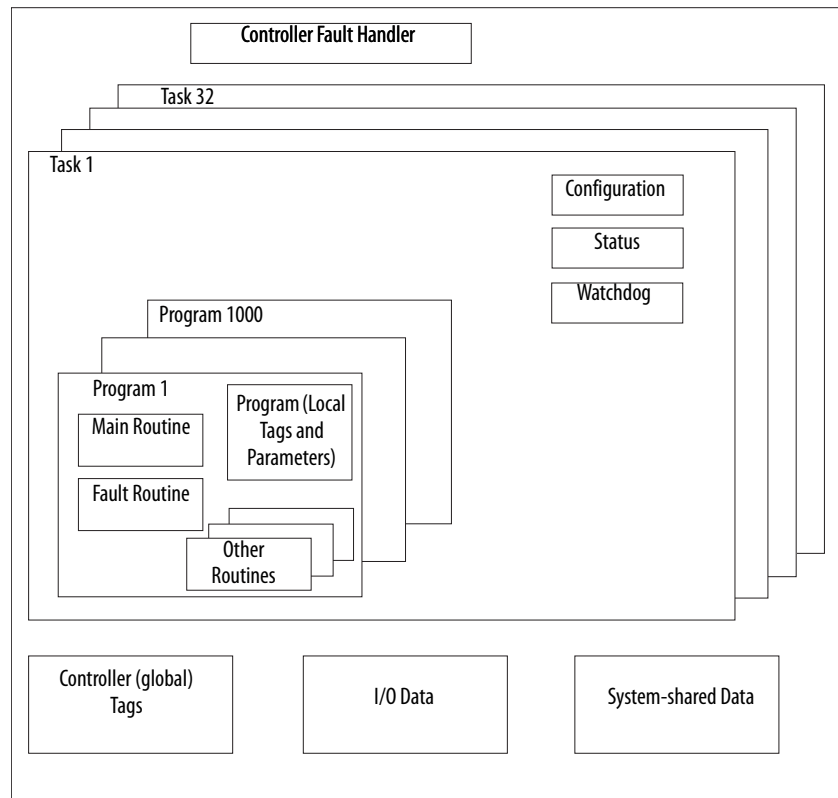

Tasks

A Logix5000™ controller lets you use multiple tasks to schedule and prioritize the execution of your programs that are based on criteria. This multitasking allocates the processing time of the controller among the different operations in your application:

- The controller executes only one task at a time.
- One task can interrupt the execution of another task and take control.
- In any given task, multiple programs can be used. However, only one program executes at a time.
- You can display tasks in the Controller or Logical Organizer views, as necessary.

Figure 40 - Task in a Control Application

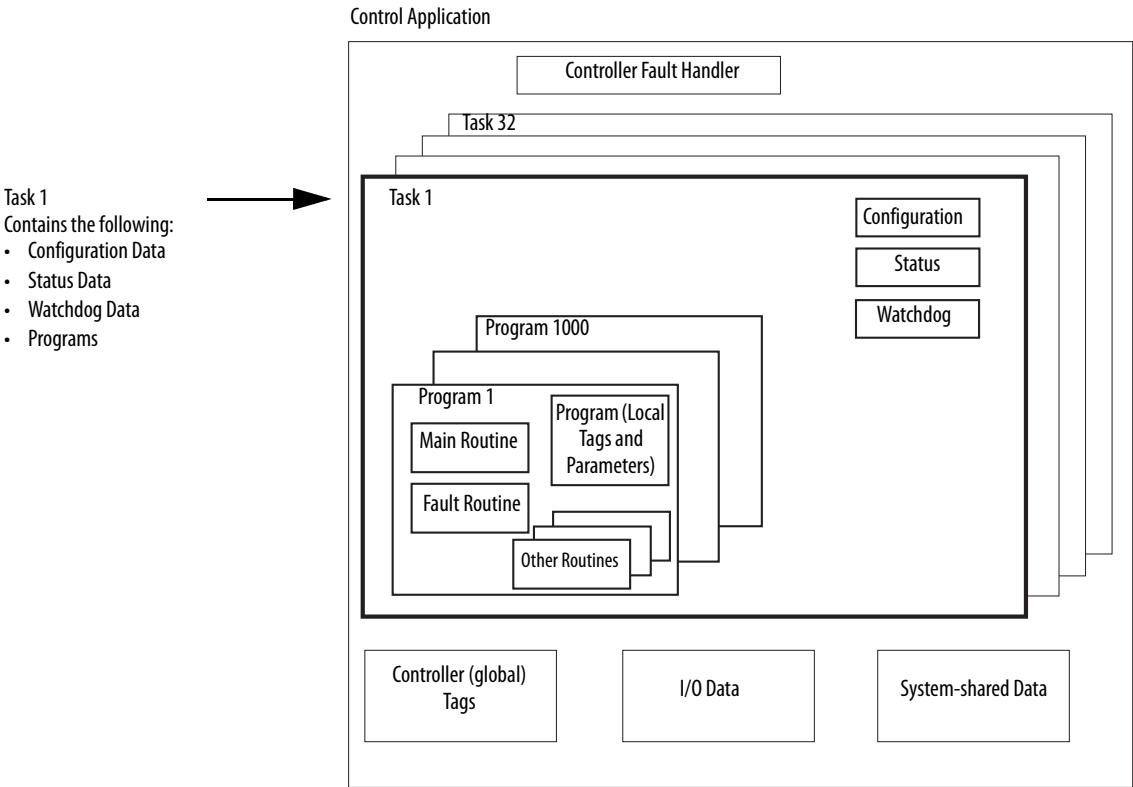
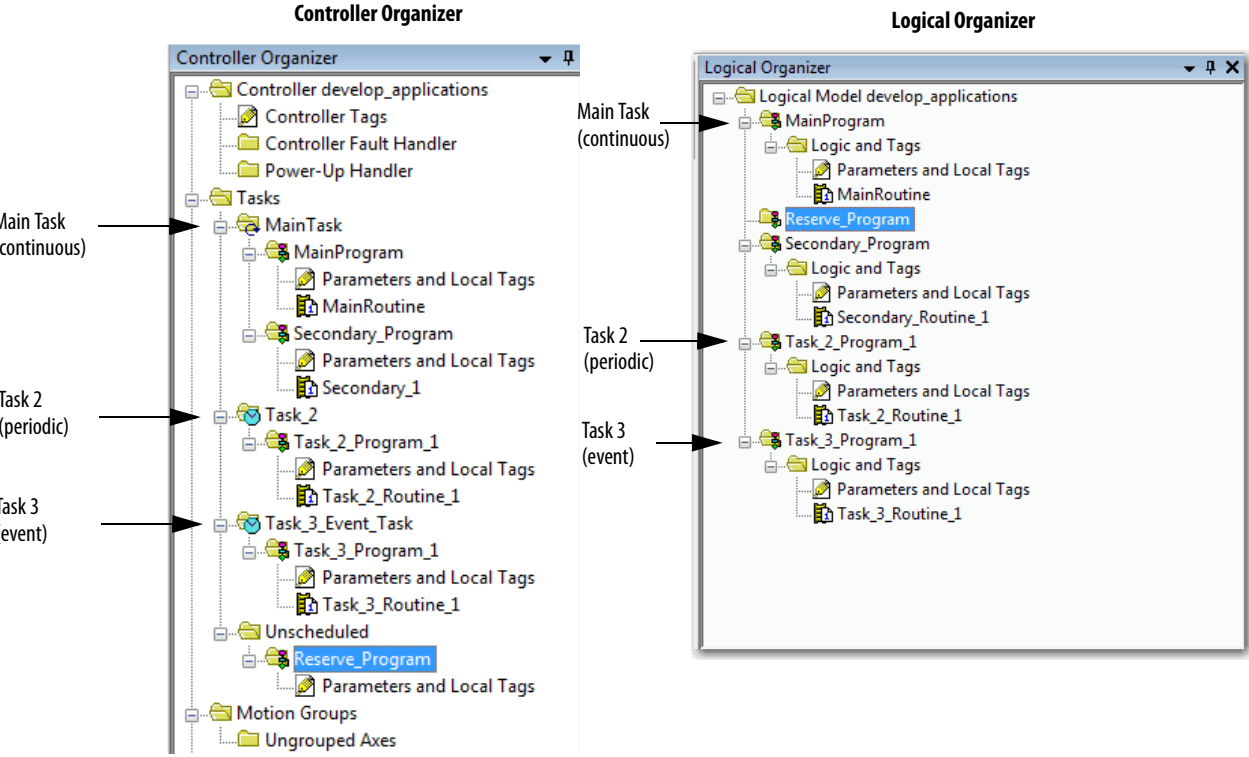
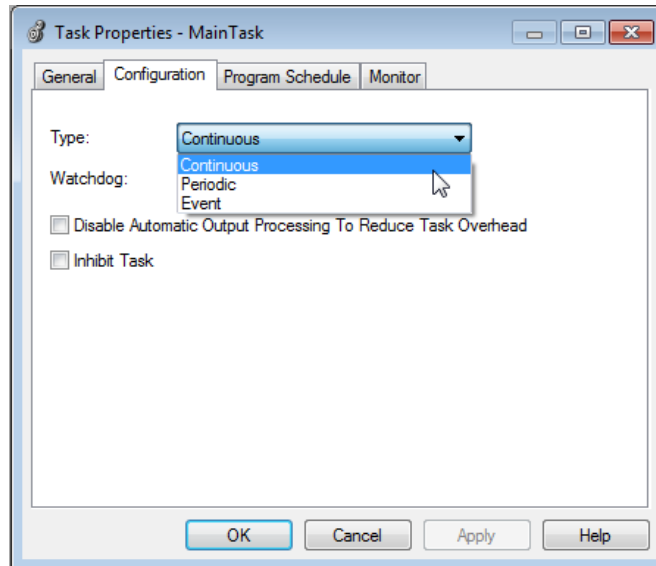

Figure 41 - Tasks in Application



A task provides scheduling and priority information for a set of one or more programs. Configure tasks as continuous, periodic, or event by using the Task Properties dialog box.

Figure 42 - Configuring the Task Type



This table explains the types of tasks you can configure.

Table 34 - Task Types and Execution Frequency

Task Type	Task Execution	Description
Continuous	Always	The continuous task runs in the background. Any CPU time that is not allocated to other operations (such as motion, communication, and other tasks) is used to execute the programs in the continuous task: <ul style="list-style-type: none"> • The continuous task runs constantly. When the continuous task completes a full scan, it restarts immediately. • A project does not require a continuous task. If used, there can be only one continuous task.
Periodic	<ul style="list-style-type: none"> • At a set interval, such as every 100 ms • Multiple times in the scan of your other logic 	A periodic task performs a function at an interval: <ul style="list-style-type: none"> • Whenever the time for the periodic task expires, the task interrupts any lower priority tasks, executes once, and returns control to where the previous task left off. • You can configure the time period from 0.1...2,000,000.00 ms. The default is 10 ms. It is also controller and configuration dependent. • The performance of a periodic task depends on the type of Logix5000 controller and on the logic in the task. • The periodic task processes I/O data for CompactLogix™, FlexLogix™, DriveLogix™, and SoftLogix™ controllers with the following considerations: <ul style="list-style-type: none"> – For CompactLogix, FlexLogix, and DriveLogix controllers, operates at priority 6 – For SoftLogix controllers, operates at Windows priority 16 (Idle) – Higher-priority tasks take precedence over the I/O task and can affect processing – Executes at the fastest RPI you have scheduled for the system – Executes for as long as it takes to scan the configured I/O modules
Event	Immediately when an event occurs	An Event task performs a function only when an event (trigger) occurs. The trigger for the Event task can be the following: <ul style="list-style-type: none"> • A consumed tag trigger • An EVENT instruction • An axis trigger • A motion event trigger • Module input data state change <p>IMPORTANT: With Logix Designer application, version 21.00.00 or later, you can use this trigger with 1756 ControlLogix®, 1789 SoftLogix, and CompactLogix 5370 L1 applications.</p>

The CompactLogix controller supports up to 32 tasks, only one of which can be continuous.

A task can have up to 1000 separate [Programs](#) per task, each with its own executable routines and program-scoped tags. Once a task is triggered (activated), all programs that are assigned to the task execute in the order in which they are grouped. Multiple tasks cannot share Programs and Programs appear only once in the Controller Organizer.

Task Priority

Each task in the controller has a priority level. The operating system uses the priority level to determine which task to execute when multiple tasks are triggered. A higher priority task interrupts any lower priority task. A periodic or event task interrupts the continuous task, which has the lowest priority.

You can configure periodic tasks to execute from the lowest priority of 15 up to the highest priority of 1. Configure the task priority by using the Task Properties dialog box.

Figure 43 - Configure the Task Priority

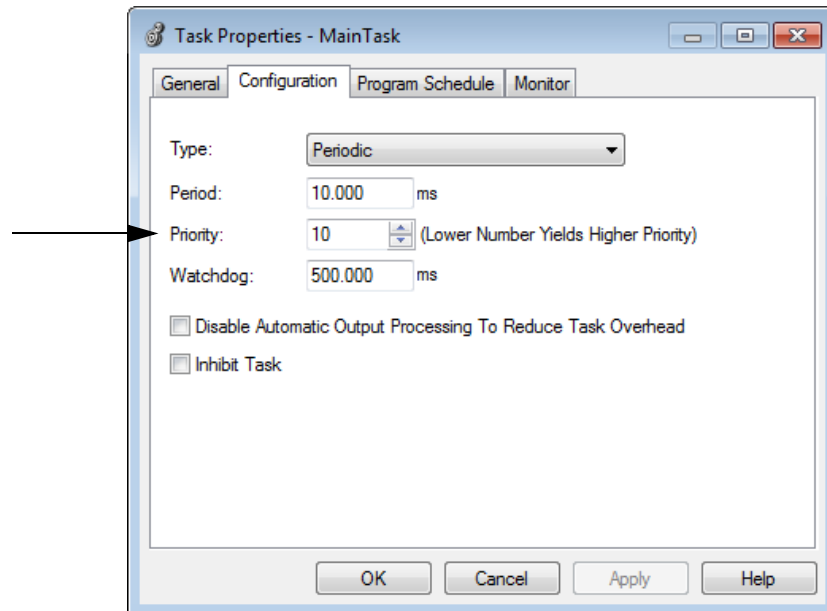

Programs

The controller operating system is a preemptive multitasking system that is in compliance with IEC 1131-3. This system provides the following:

- Programs to group data and logic
- Routines to encapsulate executable code that is written in one programming language

Each program contains the following:

- Local Tags
- Parameters
- A main executable routine
- Other routines
- An optional fault routine

Figure 44 - Program in a Control Application

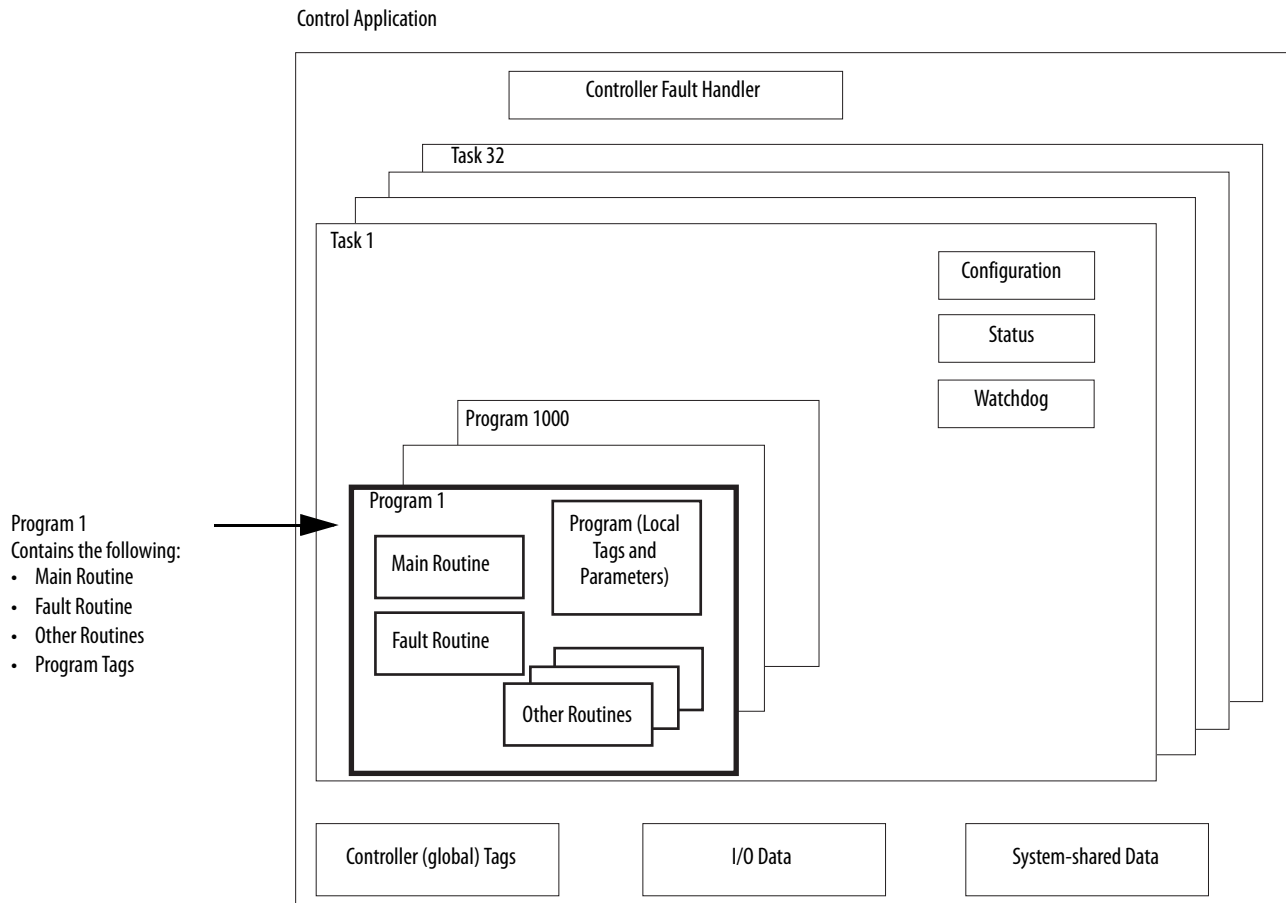
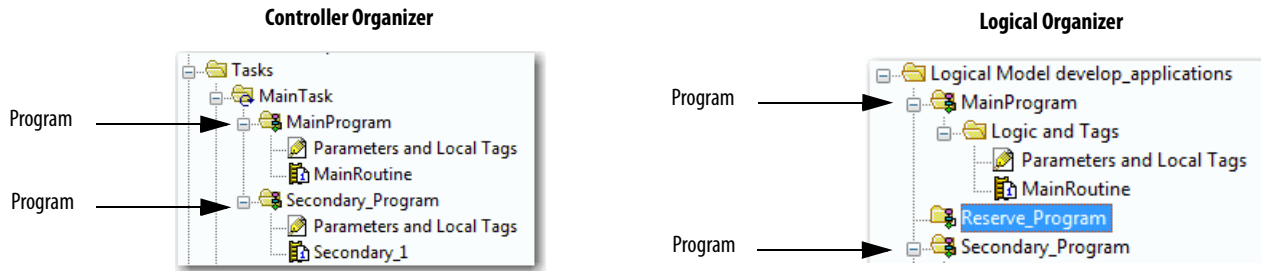

Figure 45 - Programs in Application



Scheduled and Unscheduled Programs

The scheduled programs in a task execute to completion from first to last. Programs that are not attached to any task show up as unscheduled programs.

Unscheduled programs in a task are downloaded to the controller with the entire project. The controller verifies unscheduled programs but does not execute them.

You must schedule a program in a task before the controller can scan the program. To schedule an unscheduled program, use the Program/Phase Schedule tab of the Task Properties dialog box.

Figure 46 - Scheduling an Unscheduled Program

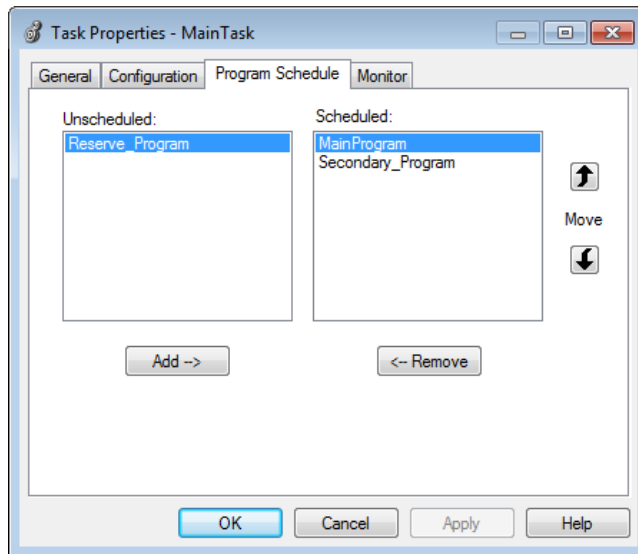

Routines

A routine is a set of logic instructions in one programming language, such as Ladder Diagram (ladder logic). Routines provide the executable code for the project in a controller. A routine is similar to a program file or subroutine in a PLC or SLC™ processor.

Each program has a main routine. This routine is the first routine to execute when the controller triggers the associated task and calls the associated program. Use logic, such as the Jump to Subroutine (JSR) instruction, to call other routines.

You can also specify an optional program fault routine. The controller executes this routine if it encounters an instruction-execution fault in any of the routines in the associated program.

Figure 47 - Routines in a Control Application

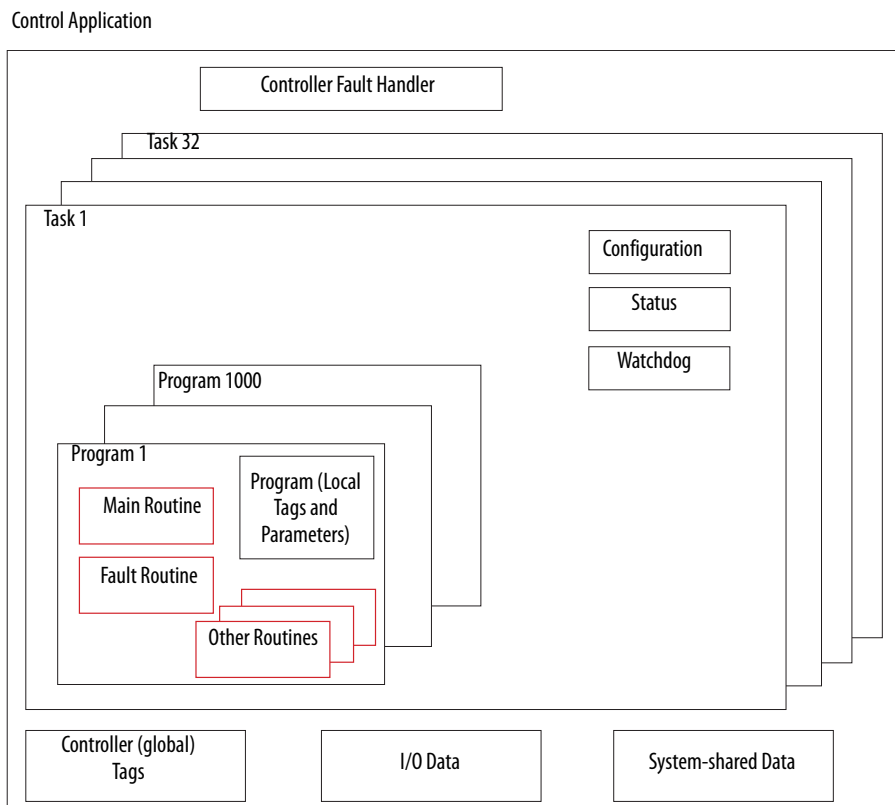
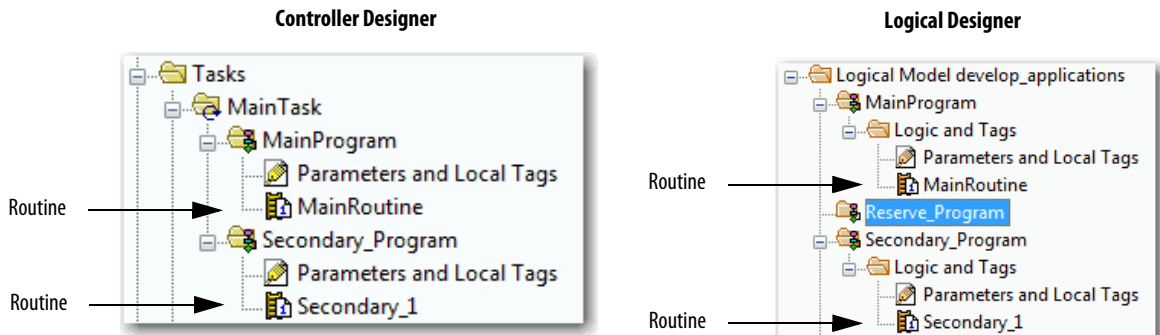

Figure 48 - Routines in Application



Tags

With a Logix5000 controller, you use a tag (alphanumeric name) to address data (variables). In Logix5000 controllers, there is no fixed, numeric format. For example, as shown in the following figure, you can use the tag name **north_tank_mix** instead of a numeric format, such as N7:0.0.

The tag name itself identifies the data. The tag lets you do the following:

- Organize your data to mirror your machinery.
- Document your application as you develop it.

This example shows data tags that are created in the scope of the Main Program of the controller.

Figure 49 - Tags Example

Controller Organizer - Main Program Parameters and Local Tags

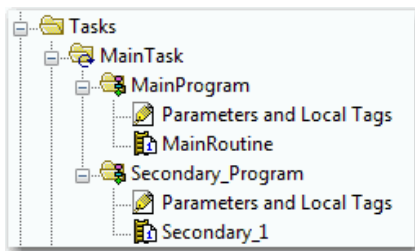

Program Tags Window - Main Program Tags

		Scope: MainProgram	Show: All Tags	Y. Enter Name Filter...						
	Name	Usage	Alias For	Base Tag	Data Type	Description	External Access	Constant	Style	
Analog I/O Device	north_tank_mix	Local			BOOL		Read/Write	<input type="checkbox"/>	Decimal	
	north_tank_pr...	Local			REAL		Read/Write	<input type="checkbox"/>	Float	
	north_tank_temp	Local			REAL		Read/Write	<input type="checkbox"/>	Float	
Integer Value	one_shots	Local			DINT		Read/Write	<input type="checkbox"/>	Decimal	
	recipe	Local			TANK		Read/Write	<input type="checkbox"/>		
Storage Bit	recipe_number	Local			DINT		Read/Write	<input type="checkbox"/>	Decimal	
	replace_bit	Local			BOOL		Read/Write	<input type="checkbox"/>	Decimal	
Counter	running_hours	Local			COUNTER		Read/Write	<input type="checkbox"/>		
	running_secon...	Local			TIMER		Read/Write	<input type="checkbox"/>		
Digital I/O Device	start	Local			BOOL		Read/Write	<input type="checkbox"/>	Decimal	
	stop	Local			BOOL		Read/Write	<input type="checkbox"/>	Decimal	

There are several guidelines to create and configure parameters and local tags for optimal task and program execution. For more information, see the Logix5000 Controllers and I/O Tag Data Programming Manual, publication [1756-PM004](#).

Extended Properties

The Extended Properties feature lets you define more information, such as limits, engineering units, or state identifiers, for various components within your controller project.

Component	Extended Properties
Tag	In the Tag Editor, add extended properties to a tag.
User-defined data type	In the Data Type Editor, add extended properties to data types.
Add-On Instructions	In the properties that are associated with the Add-On Instruction definition, add extended properties to Add-On Instructions.

Pass-through behavior is the ability to assign extended properties at a higher level of a structure or Add-On Instruction and have that extended property automatically available for all members. Pass-through behavior is available for descriptions, state identifiers, and engineering units and you can configure it. Configure pass-through behavior on the Project tab of the Controller Properties dialog box. If you choose not to show pass-through properties, only extended properties that have been configured for a given component are displayed.

Pass-through behavior is **not** available for limits. When an instance of a tag is created, if limits are associated with the data type, the instance is copied.

You must know which tags have limits that are associated with them as there is no indication in the tag browser that extended properties are defined for a tag. If, however, you try to use extended properties that have not been defined for a tag, the editors show a visual indication and the routine does not verify.

Access Extended Properties in Logic

You can access limits that are defined on tags by using the `.@Min` and `.@Max` syntax:

- You cannot write to extended properties values in logic.
- To use extended tag properties in an Add-On Instruction, you must pass them in as input operands to the Add-On Instruction.
- Alias tags that have extended properties cannot access the extended properties in logic.
- Limits can be configured for input and output parameters in Add-On Instructions. However, limits cannot be defined on an InOut parameter of an Add-On Instruction.
- Limits cannot be accessed inside Add-On Instruction logic. Limits are for use only by HMI applications.

If an array tag is using indirect addressing to access limits in logic, the following conditions apply:

- If the array tag has limits that are configured, the extended properties are applied to any array element that does not explicitly have that particular extended property configured. For example, if the array tag `MyArray` has `Max` configured to 100, any element of the array that does not have `Max` configured inherits the value of 100 when being used in logic. However, it is not visible to you that the value inherited from `MyArray` is configured in the tag properties.
- At least one array element must have a limit that is configured for indirectly referenced array logic to verify. For example, if `MyArray[x].@Max` is being used in logic, at least one array element of `MyArray[]` must have `Max` extended property that is configured if `MyArray` has not configured `Max`.
- Under the following circumstances a data type default value is used:
 - Array is accessed programmatically with indirect reference.
 - Array tag does not have the extended property configured.
 - A member of an array does not have the extended property configured.

For example, for an array of `SINT` type, when `max` limit is called in logic for a member, use the value of 127.

If an array element is directly accessed, the element has to have the extended property defined. If not, verification fails.

Programming Languages

The CompactLogix controller supports these programming languages, online, and offline.

Table 35 - CompactLogix Controller Programming Languages

Language	Is best-used in programs with
Relay ladder	Continuous or parallel execution of multiple operations (not sequenced)
	Boolean or bit-based operations
	Complex logical operations
	Message and communication processing
	Machine interlocking
Function block diagram	Operations that service or maintenance personnel can have to interpret to troubleshoot the machine or process
	Continuous process and drive control
	Loop control
Sequential function chart (SFC)	Calculations in circuit flow
	High-level management of multiple operations
	Repetitive sequence of operations
	Batch process
	Motion control using structured text
Structured text	State machine operations
	Complex mathematical operations
	Specialized array or table loop processing
	ASCII string handling or protocol processing

For information about programming in these languages, see the Logix5000 Controllers Common Procedures Programming Manual, publication [1756-PM001](#).

Add-On Instructions

You can design and configure sets of commonly used instructions to increase project consistency. Similar to the built-in instructions contained in Logix5000 controllers, these instructions you create are called Add-On Instructions. Add-On Instructions reuse common control algorithms. With them, you can do the following:

- Ease maintenance by animating logic for one instance.
- Protect intellectual property with Source Protection.
- Reduce documentation development time.

You can use Add-On Instructions across multiple projects. You can define your instructions, obtain them from somebody else, or copy them from another project.

This table explains some of the capabilities and advantages of use Add-On Instructions.

Table 36 - Add-On Instruction Capabilities

Capability	Description
Save Time	With Add-On Instructions, you can combine your most commonly used logic into sets of reusable instructions. You save time when you create instructions for your projects and share them with others. Add-On Instructions increase project consistency because commonly used algorithms all work in the same manner, regardless of who implements the project.
Use Standard Editors	You create Add-On Instructions by using one of three editors: <ul style="list-style-type: none"> • Relay Ladder • Function Block Diagram • Structured Text Once you have created instructions, you can use them in any editor.
Export Add-On Instructions	You can export Add-On Instructions to other projects and copy and paste them from one project to another. Give each instruction a unique name so that you don't accidentally overwrite another instruction of the same name.
Use Context Views	Context views let you visualize the logic of an instruction for an instant, which simplifies online troubleshooting of your Add-On Instructions. Each instruction contains a revision, a change history, and an auto-generated help page.
Create Custom Help	When you create an instruction, you enter information for the description fields in dialogs, information that becomes what is known as Custom Help. Custom Help makes it easier for you to get the help you need when implementing the instructions.
Apply Source Protection	As the creator of Add-On Instructions, you can limit users of your instructions to read-only access. You can also bar access to the internal logic or local parameters that are used by the instructions. This source protection lets you stop unwanted changes to your instructions and protects your intellectual property.

Once defined in a project, Add-On Instructions behave similarly to the built-in instructions in Logix5000 controllers. They appear on the instruction toolbar for easy access, as do internal instructions.

Figure 50 - Add-On Instructions

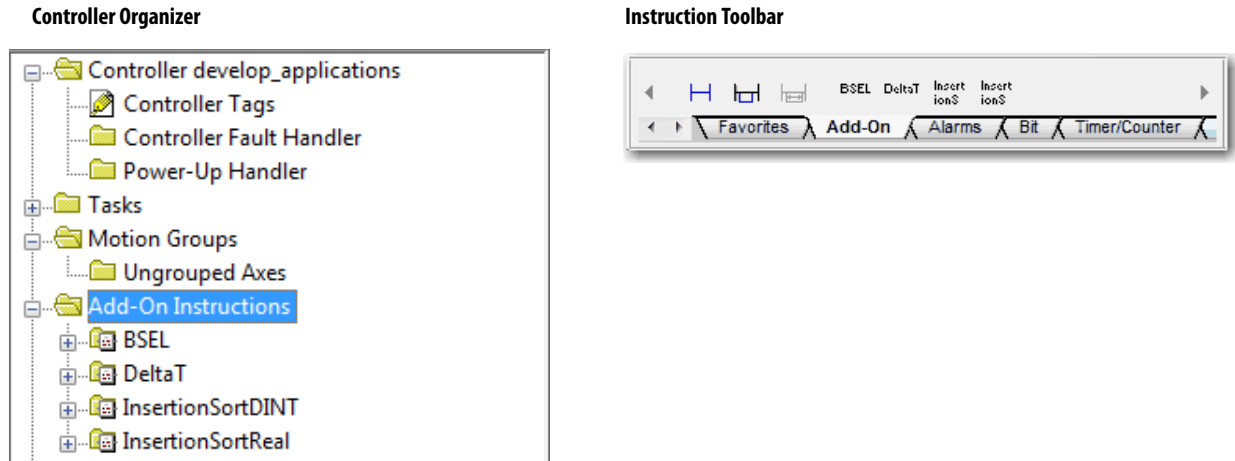

Access the Module Object

The MODULE object provides status information about a module. To select a particular module object, set the Object Name operand of the GSV/SSV instruction to the module name. The specified module must be present in the I/O Configuration section of the controller organizer and must have a device name.

Create the Add-On Instruction

With Logix Designer application, version 24.00.00 and later, you can access a MODULE object directly from an Add-On Instruction. Previously, you could access the MODULE object data but not from within an Add-On Instruction.

You must create a Module Reference parameter when you define the Add-On Instruction to access the MODULE object data. A Module Reference parameter is an InOut parameter of the MODULE data type that points to the MODULE Object of a hardware module. You can use module reference parameters in both Add-On Instruction logic and program logic.

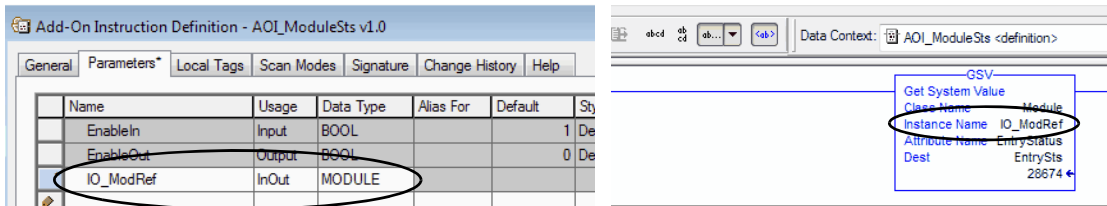

For more information on the Module Reference parameter, see the Logix5000 Controllers Add-On Instructions Programming Manual, publication [1756-PM010](#), and the Logix Designer application online help.

The MODULE object uses the following attributes to provide status information:

- EntryStatus
- FaultCode
- FaultInfo
- FWSupervisorStatus
- ForceStatus
- Instance
- LEDStatus
- Mode
- Path

The Path attribute is available with Logix Designer application, version 24.00.00 and later. This attribute provides a communication path to the module.

For more information on the attributes available in the MODULE object, see the Logix5000™ Controllers General Instructions Reference Manual, publication [1756-RM003](#).

Monitoring Controller Status

The CompactLogix controller uses Get System Value (GSV) and Set System Value (SSV) instructions to get and set (change) controller data. The controller stores system data in objects. There is no status file, as in the PLC-5[®] processor.

The GSV instruction retrieves the specified information and places it in the destination. The SSV instruction sets the specified attribute with data from the source. The instructions are available from the Input/Output tab of the Instruction tool bar.

Figure 51 - GSV and SSV Instructions for Monitoring

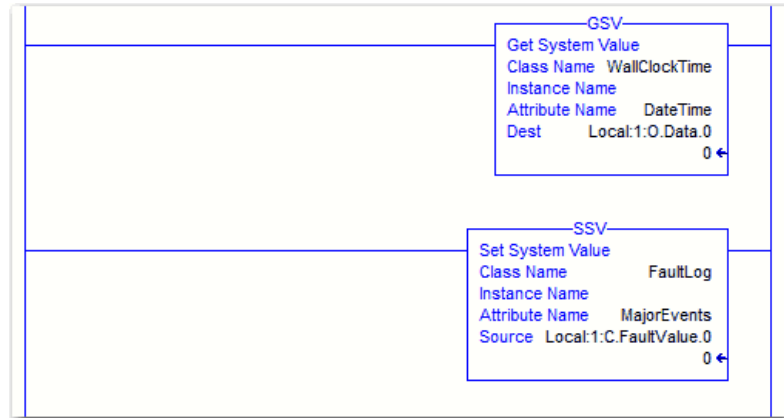

When you add a GSV/SSV instruction to the program, the object classes, object names, and attribute names for each instruction are displayed. For the GSV instruction, you can get values for the available attributes. For the SSV instruction, only those attributes you are allowed to set are displayed.

Some object types appear repeatedly, so you have to specify the object name. For example, there can be several tasks in your application. Each task has its own Task object that you access by the task name.

There are several objects and attributes that you can use the GSV and SSV instructions to monitor and set the system. For more information about GSV instructions, SSV instructions, objects, and attributes see the Logix5000 Controllers General Instructions Reference Manual, publication [1756-RM003](#).

Monitoring I/O Connections

If communication with a device in the I/O configuration of the controller does not occur in an application-specific period, the communication times out and the controller produces warnings.

The minimum timeout period that, once expired without communication, causes a timeout is 100 ms. The timeout period can be greater, depending on the RPI of the application. For example, if your application uses the default RPI = 20 ms, the timeout period is 160 ms.

For more information on how to determine the time for your application, see Rockwell Automation Knowledgebase Tech Note 38535. The document is available at <http://www.rockwellautomation.com/knowledgebase/>.

When a timeout does occur, the controller produces these warnings:

- An I/O fault status code is indicated on the status display of the CompactLogix 5370 controller.
- The I/O status indicator on the front of the CompactLogix 5370 controller flashes green.
- A  shows over the I/O configuration folder and over the devices that have timed out.
- A module fault code is produced, which you can access via the following:
 - The Module Properties dialog box
 - A GSV instruction

For more information about I/O faults, see the Logix5000 Controllers Major, Minor, and I/O Faults Programming Manual, publication [1756-PM014](#).

Determine if I/O Communication has Timed Out

This example can be used with the CompactLogix 5370 controllers:

- The GSV instruction gets the status of the I/O status indicator (via the LEDStatus attribute of the Module object) and stores it in the IO_LED tag.
- IO_LED is a DINT tag that stores the status of the I/O status indicator or status display on the front of the controller.
- If IO_LED equals 2, then at least one I/O connection has been lost and the Fault_Alert is set.

Figure 52 - GSV Used to Identify I/O Timeout

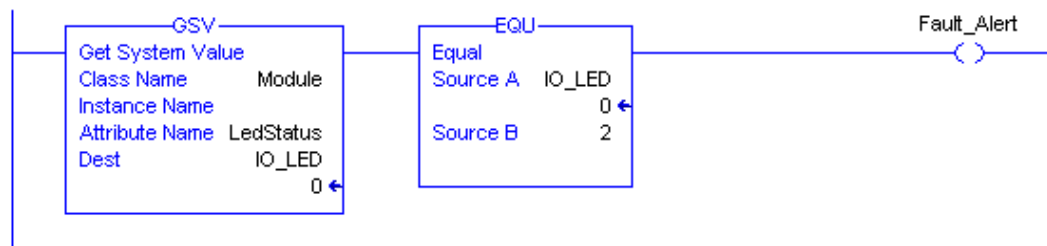

For more information about attributes available with the Module object, see the Logix5000 Controllers General Instructions Reference Manual, publication [1756-RM003](#).

Determine if I/O Communication to a Specific I/O Module has Timed Out

If communication times out with a device (module) in the I/O configuration of the controller, the controller produces a fault code and fault information for the module. You can use GSV instructions to get fault code and information via the FaultCode and FaultInfo attributes of the Module object.

For more information about attributes available with the Module object, see the Logix5000 Controllers General Instructions Reference Manual, publication [1756-RM003](#).

Interrupt the Execution of Logic and Execute the Fault Handler

Depending on your application, you can want an I/O connection error to cause the Controller Fault Handler to execute. To do so, set the module property that causes a major fault to result from an I/O connection error. The major fault causes the execution of the Controller Fault Handler.

First, develop a routine in the Controller Fault Handler that can respond to I/O connection faults. In the Module Properties dialog box of the I/O module or parent communication module, check Major Fault On Controller If Connection Fails While in Run Mode.

Figure 53 - I/O Connection Fault Causes Major Fault

I/O Module Properties

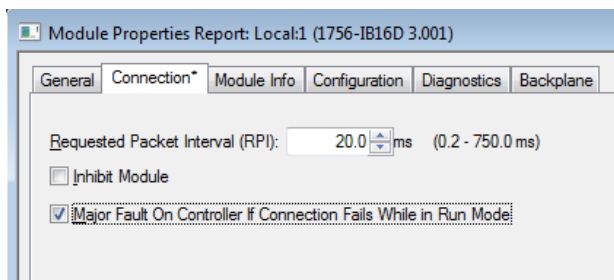

Parent Communication Module Properties

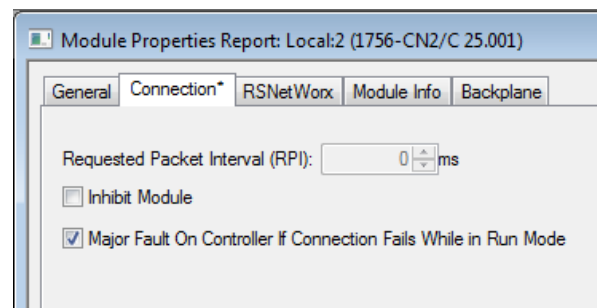

For more information about programming the Controller Fault Handler, see the Logix5000 Controllers Major, Minor, and I/O Faults Programming Manual, publication [1756-PM014](#).

System Overhead Time Slice

The controller communicates with other devices at a specified rate (scheduled) or when there is processing time available to service the communication.

The system overhead time slice specifies the percentage of time a controller devotes to service communication. If you have a continuous task, the System Overhead Time Slice entered in the Advanced tab of the Controller Properties dialog box specifies continuous task/service communication ratio. However, if there is no continuous task, the overhead time slice has no effect.

The table shows the ratio between the continuous task and service communication at various system overhead time slices.

Table 37 - Ratio between Continuous Task and Service Communication

At this time slice	The continuous task runs	Service communication occurs for up to
10%	9 ms	1 ms
20%	4 ms	1 ms
25%	3 ms	1 ms
33%	2 ms	1 ms
50%	1 ms	1 ms
66%	1 ms	2 ms
75%	1 ms	3 ms
80%	1 ms	4 ms
90%	1 ms	9 ms

As shown in [Table 37](#), if the system overhead time slice is less than or equal to 50%, the duration stays fixed at 1 ms. The same applies for 66% and higher, except there are multiple 1 ms intervals. For example, at 66% there are two 1 ms intervals of consecutive time and at 90% there are nine 1 ms intervals of consecutive time.

Configure the System Overhead Time Slice

To configure the system overhead time slice, perform this procedure.

1. In the Controller Organizer, right-click the controller and choose Properties.

The Controller Properties dialog box appears.

2. Click the Advanced tab.
3. Enter a numeric value in the System Overhead Time Slice box.
4. Use Run Continuous Task (default) or Reserve for System Tasks.
 - Click Run Continue Task when there is no communication or background tasks to process; controller immediately returns to the continuous task.
 - Click Reserve for System Task to allocates the entire 1 ms of the system overhead time slice whether the controller has communication or background tasks to perform before returning back to the continuous task. This lets you simulate a communication load on the controller during design and programming before HMIs, controller to controller messaging, and so forth, are configured.
5. Click OK.

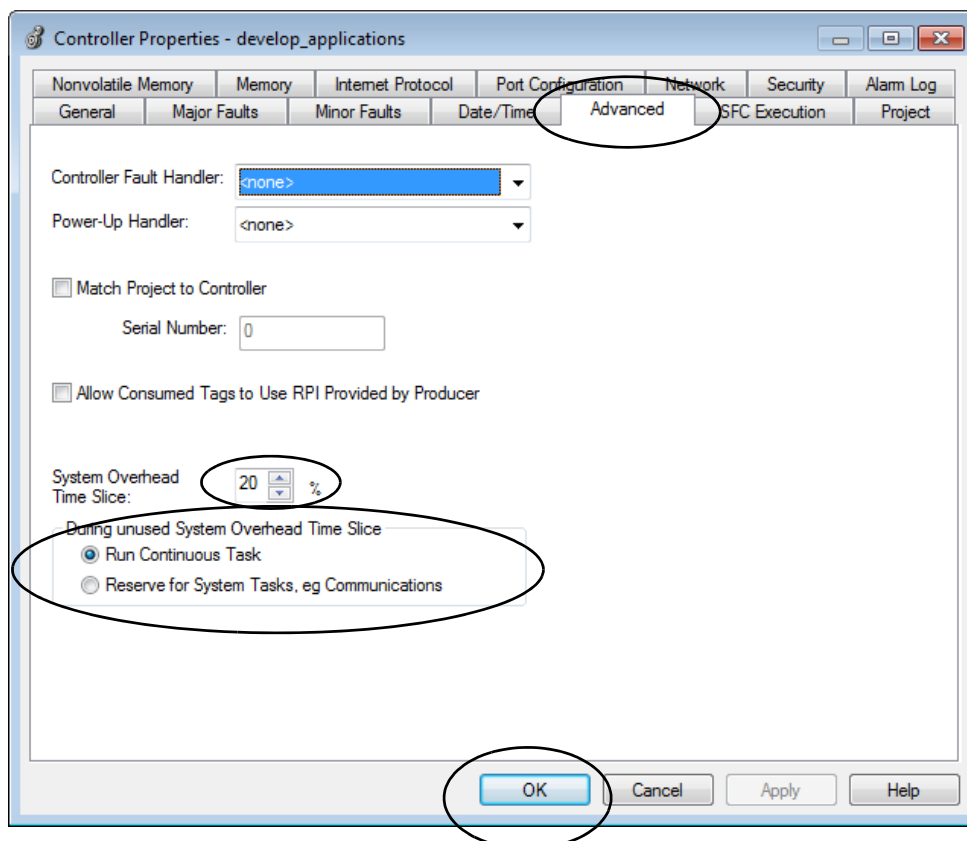

Sample Controller Projects

The application includes sample projects that you can copy and modify to fit your application. To access the sample projects, complete these steps.

1. From the File menu, choose Open.

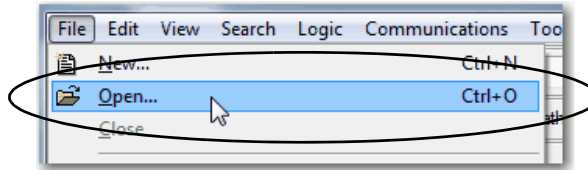

2. Browse to the sample projects list and select a sample project.
3. Click Open.

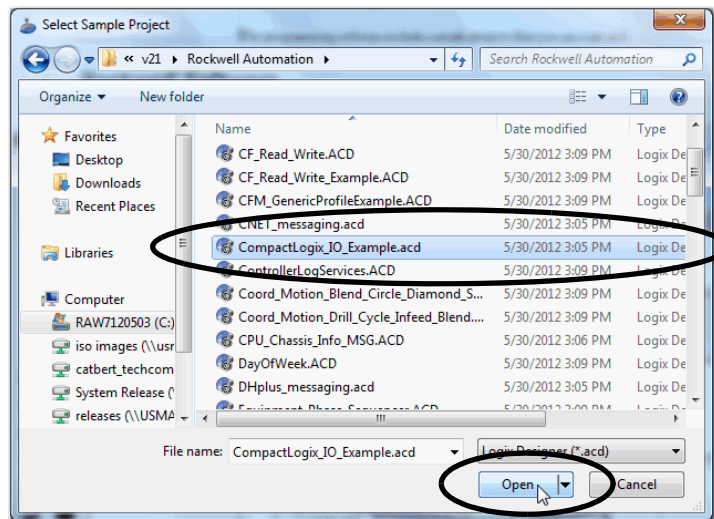

Develop Integrated Motion over an EtherNet/IP Network Application

Topic	Page
Motion Axes Support	284
Maximum Number of Position Loop-configured Drives	286
Time Synchronization	287
Configure Integrated Motion on the EtherNet/IP Network	288
Scalability in Applications Using Integrated Motion on EtherNet/IP Networks	292

Some of the CompactLogix™ 5370 controllers support Integrated Motion over an EtherNet/IP network. This motion solution is on standard, unmodified EtherNet/IP network with simple design or configuration as compared to traditional motion applications.

IMPORTANT The following CompactLogix 5370 controllers support Integrated Motion over an EtherNet/IP network:

- 1769-L18ERM-BB1B controller
- 1769-L27ERM-QBFC1B controller
- 1769-L30ERM controller
- 1769-L30ERMK controller
- 1769-L33ERM controller
- 1769-L33ERMK controller
- 1769-L33ERMO controller
- 1769-L36ERM controller
- 1769-L36ERMO controller
- 1769-L37ERM controller
- 1769-L37ERMK controller
- 1769-L37ERMO controller⁽¹⁾
- 1769-L38ERM
- 1769-L38ERMK
- 1769-L38ERMO controller⁽¹⁾

(1) Available at software version 31 and firmware revision 31.

Integrated Motion on EtherNet/IP applications use the following:

- Standard EtherNet/IP network
- High performance drives, including the following:
 - Kinetix® 350 drives
 - Kinetix 5500 drives
 - Kinetix 5700 drives
 - Kinetix 6500 drives
 - PowerFlex® 755 drives
- Standard infrastructure components
- Programming software

For a complete description of how to use a CompactLogix 5370 controller in an application that uses Integrated Motion over an EtherNet/IP network, see the Integrated Motion on the EtherNet/IP Network: Configuration and Startup User Manual, publication [MOTION-UM003](#).

Motion Axes Support

The 1769-L18ERM-BB1B, 1769-L27ERM-QBFC1B, 1769-L30ERM, 1769-L30ERMK, 1769-L33ERM, 1769-L33ERMK, 1769-L33ERMO, 1769-L36ERM, 1769-L36ERMO, 1769-L37ERM, 1769-L37ERMK, 1769-L37ERMO⁽¹⁾, 1769-L38ERM, 1769-L38ERMK, and 1769-L38ERMO⁽¹⁾ controllers support these axes:

- AXIS_VIRTUAL
- AXIS_CIP_DRIVE

AXIS_VIRTUAL Axis

The AXIS_VIRTUAL axis is an internal axis representation that is not associated with any physical drives. That is, you can configure the axis but it does not cause any physical motion in your system.

(1) Available at software version 31 and firmware revision 31.

AXIS_CIP_DRIVE Axis

The `AXIS_CIP_DRIVE` axis is a motion axis that is used with physical drives to cause physical motion in your system as determined by your application.

Configuration Types

When adding an axis to your project, you must associate the axis to a drive. Among other configuration parameters, you must select a configuration type. The axis configuration type is also considered the drive configuration type.

For example, an `AXIS_CIP_DRIVE` axis can use a Position Loop configuration and be associated with a Kinetix 350 drive. The axis is considered a Position Loop-configured axis and the associated drive is considered a Position Loop-configured drive.

The following drives support these configuration types:

- Kinetix 350, Kinetix 5500, Kinetix 5700, and Kinetix 6500 drives
 - Position loop
 - Velocity loop
 - Torque loop

- PowerFlex 755 drive
 - Position loop
 - Velocity loop
 - Torque loop
 - Frequency control

Maximum Number of Position Loop-configured Drives

The CompactLogix 5370 controllers support a maximum number of EtherNet/IP nodes in a project. Any device added to the local Ethernet node in the I/O configuration is counted toward the node limitation of the controller. For more information, see [Nodes on an EtherNet/IP Network on page 123](#).

Drives are counted among the number of nodes in the I/O Configuration section of the Studio 5000® environment. If you use the maximum number of drives that a 1769-L18ERM-BB1B, 1769-L27ERM-QBFC1B, 1769-L30ERM, 1769-L30ERMK, 1769-L33ERM, 1769-L33ERMK, 1769-L33ERMO, 1769-L36ERM, 1769-L36ERMO, 1769-L37ERM, 1769-L37ERMK, 1769-L37ERMO⁽¹⁾, 1769-L38ERM, 1769-L38ERMK, or 1769-L38ERMO⁽¹⁾ controller supports in one system, you cannot add other EtherNet/IP devices to that project.

Position Loop-configured Drive Limits

Among the maximum number drives supported by the controllers, there is a maximum number of Position Loop-configured drives that are supported in the project for the controller.

For example, the 1769-L30ERM controller supports a maximum of four Position Loop-configured drives.

[Table 38](#) lists motion-related specification information for the controllers that support Integrated Motion over an EtherNet/IP network.

Table 38 - CompactLogix 5370 Controllers Supporting Integrated Motion on the EtherNet/IP Network

Controller Type	Drive Types Supported	Number of Drives Supported, max	Number of Position Loop-configured Drives Supported, max
1769-L18ERM-BB1B	Kinetix 350 Kinetix 5700 Kinetix 6500 PowerFlex 755	8	2
1769-L27ERM-QBFC1B 1769-L30ERM 1769-L30ERMK		16	4
1769-L33ERM 1769-L33ERMK 1769-L33ERMO		32	8
1769-L36ERM 1769-L36ERMO 1769-L37ERM 1769-L37ERMK 1769-L37ERMO ⁽¹⁾		48	16
1769-L38ERM 1769-L38ERMK 1769-L38ERMO ⁽¹⁾		80	16

(1) Available at software version 31 and firmware revision 31.

(1) Available at software version 31 and firmware revision 31.

If your solution requires more than 16 Position Loop-configured drives, consider using the ControlLogix® platform. The ControlLogix platform enables up to 100 Position Loop-configured drives.

Time Synchronization

Integrated Motion over an EtherNet/IP network requires Time Synchronization, also known as CIP Sync. CIP Sync provides accurate real-time (real-world time) or Coordinated Universal Time (UTC) synchronization of CompactLogix 5370 controllers and devices that are connected over an EtherNet/IP network.

CIP Sync is a time-synchronization protocol that can be applied to various applications. This chapter focuses on how to use the protocol in applications with Integrated Motion over an EtherNet/IP network.

In a CompactLogix system, the following devices are CIP Sync-capable:

- All CompactLogix 5370 controllers - Required

IMPORTANT While all CompactLogix 5370 controllers are CIP Sync-capable, not all controllers support Integrated Motion over an EtherNet/IP network.

A controller must be CIP Sync-capable and synchronized with other devices on the EtherNet/IP network to support Integrated Motion over an EtherNet/IP network. However, the condition of being CIP Sync-capable does not exclusively qualify a CompactLogix 5370 controller to support Integrated Motion over an EtherNet/IP network.

[Table 38 on page 286](#) lists the CompactLogix 5370 controllers that support Integrated Motion over an EtherNet/IP network.

All controllers and communication modules must have time synchronization enabled to participate in CIP Sync.

CIP Sync requires that devices in the system function in the following roles:

- Grandmaster, also known as the coordinated system time (CST) master
 - Sets time for entire system and passes the time to a Master
- Master - Sets time for its backplane
- Slave - Uses time set by Master

Configure Integrated Motion on the EtherNet/IP Network

To use Integrated Motion on the EtherNet/IP network, complete these steps.

IMPORTANT These steps show a 1769-L36ERM controller. The same steps apply to other CompactLogix 5370 controllers that support Integrated Motion over an EtherNet/IP network with slight variations in screens.

1. [Enable Time Synchronization](#).
2. [Add a Drive](#).

IMPORTANT This section assumes that you have previously created a project for your 1769-L36ERM controller. If you have not, do so before continuing.

Enable Time Synchronization

Integrated Motion on the EtherNet/IP network configuration begins with enabling time synchronization in a CompactLogix 5370 controller.

To enable Time Synchronization on a CompactLogix 5370 controller, complete these steps.

1. In the Controller Organizer, right-click your controller and choose Properties.

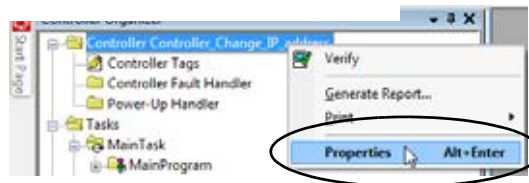

The Controller Properties dialog box appears.

2. Click the Date/Time tab.
3. Click Enable Time Synchronization.

4. Click OK.

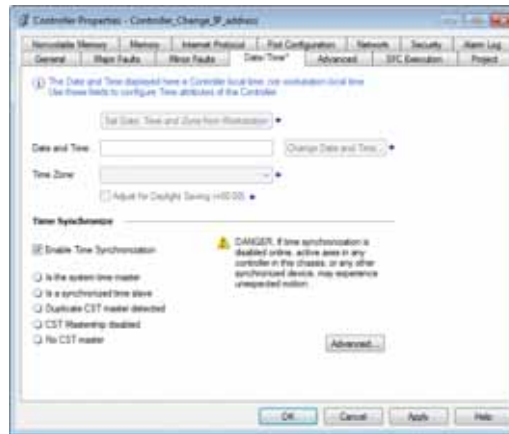

Add a Drive

You can only use these drives in an application that uses Integrated Motion over an EtherNet/IP network:

- Kinetix 350 drive
- Kinetix 5700 drive
- Kinetix 6500 drive
- PowerFlex 755 AC drive

IMPORTANT These steps show a Kinetix 350 drive in a 1769-L36ERM control system. The same steps apply to other CompactLogix 5370 controllers that support Integrated Motion over an EtherNet/IP network with slight variations in screens.

1. In the I/O configuration tree, right-click the Ethernet network and choose New Module.

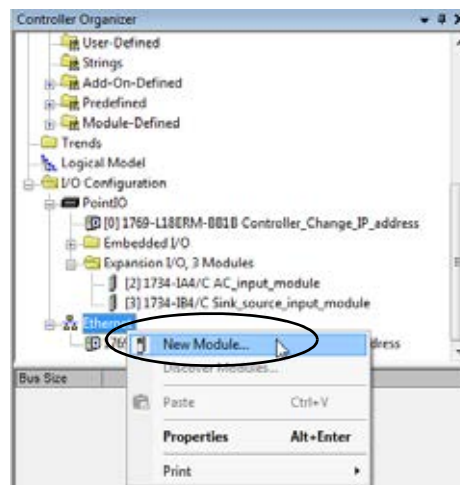

The Select Module Type dialog box appears.

2. Select the desired drive and click Create.



The New Module dialog box appears.

3. Type a name for the module.
4. Type a description, if desired.
5. Assign an EtherNet/IP address.

For information on setting the IP addresses, see the publications for each drive type that is listed on [page 11](#).



6. If you must change the configuration for any of the following parameters, click Change in the Module Definition area:
 - Revision
 - Electronic Keying
 - Connection
 - Power Structure
 - Verify Power Rating on Connection

The Module dialog box appears.

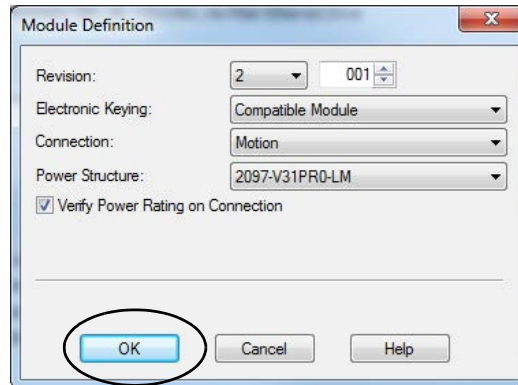

7. Make the desired changes and click OK.
8. Click OK to create the drive in your project.
9. Add other components that your project requires.

Scalability in Applications Using Integrated Motion on EtherNet/IP Networks

CompactLogix 5370 controllers offer various levels of flexibility and scalability to operate in control systems that use Integrated Motion on EtherNet/IP networks.

1769-L30ERM, 1769-L30ERMK, 1769-L33ERM, 1769-L33ERMK, 1769-L33ERMO, 1769-L36ERM, 1769-L36ERMK, 1769-L37ERM, 1769-L37ERMK, 1769-L37ERMO, 1769-L38ERM, 1769-L38ERMK, and 1769-L38ERMO Controllers

You can use the following controllers in control systems that require simpler configuration and complex configuration of Integrated Motion on EtherNet/IP networks parameters:

- 1769-L30ERM, 1769-L30ERMK
- 1769-L33ERM, 1769-L33ERMK
- 1769-L33ERMO
- 1769-L36ERM
- 1769-L36ERMK
- 1769-L36ERMO
- 1769-L37ERM, 1769-L37ERMK
- 1769-L37ERMO⁽¹⁾
- 1769-L38ERM, 1769-L38ERMK
- 1769-L38ERMO⁽¹⁾

Control Systems Requiring Simple Configuration

Relatively simple control systems that use Integrated Motion over an EtherNet/IP networks often include unmanaged switches, such as a Stratix™ 2000 switch, and Kinetix 350 drives, as shown in this example.

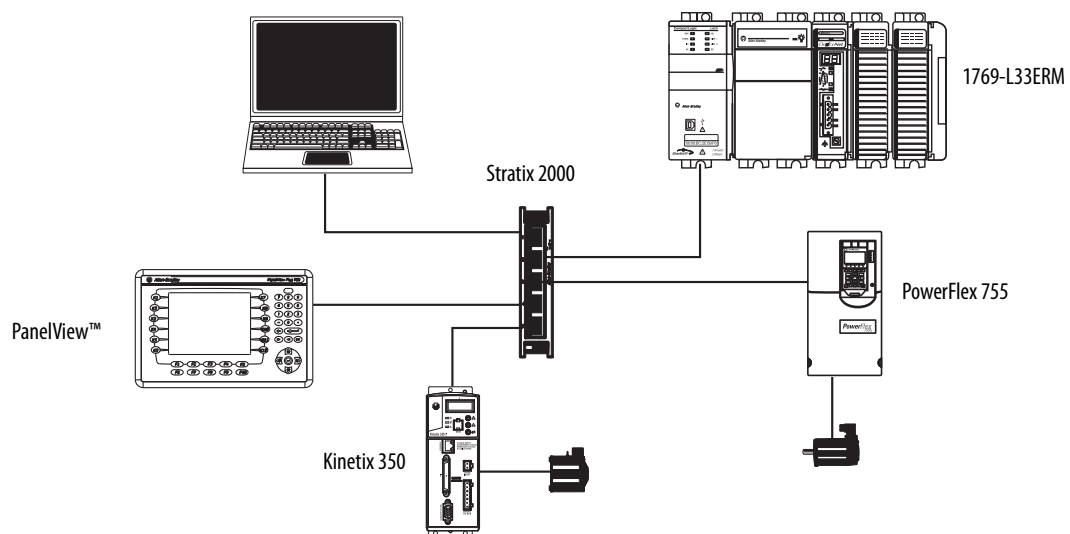

(1) Available at software version 31 and firmware revision 31.

Control Systems Requiring Complex Configuration

Complex control systems that use Integrated Motion over an EtherNet/IP network often include managed switches. This example shows such a configuration with Stratix 6000 switch, and Kinetix 6500 and PowerFlex 755 drives. S

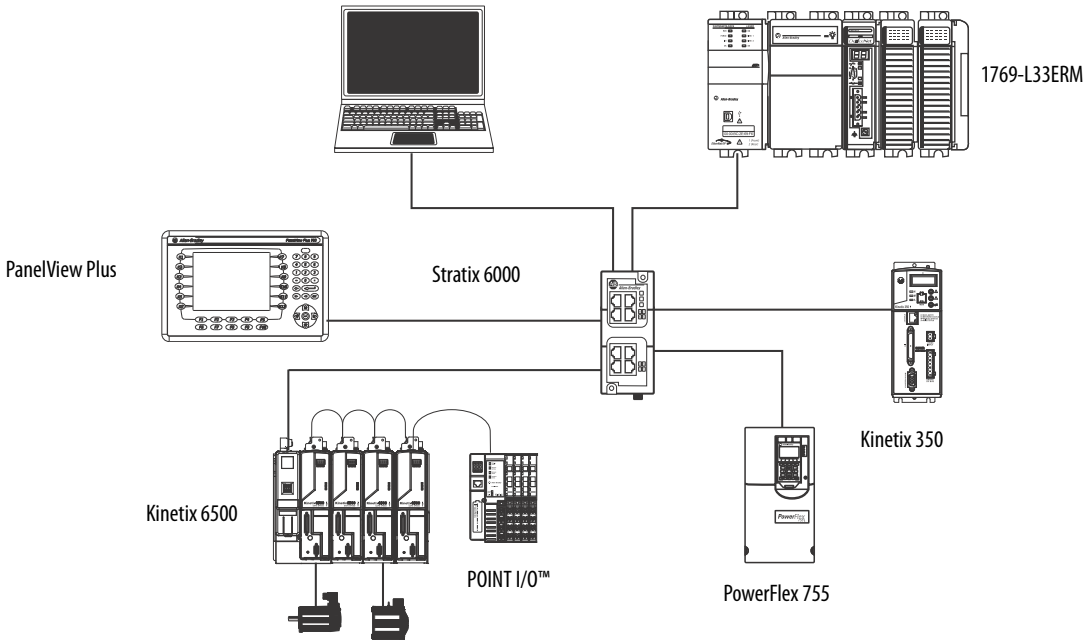

1769-L18ERM-BB1B

The 1769-L18ERM-BB1B controller is typically used in control systems that require simpler configuration regarding using Integrated Motion over an EtherNet/IP network.

The simpler control system often includes unmanaged switches, such as a Stratix 2000 switch, and Kinetix 350 drives, as shown in this example.

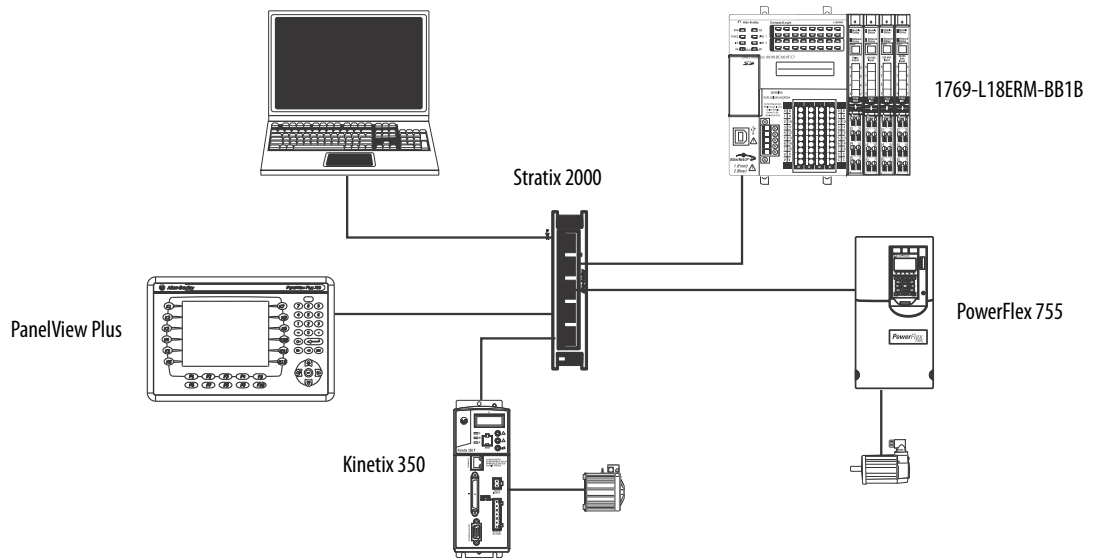

1769-L27ERM-QBFC1B Controller

The 1769-L27ERM-QBFC1B controller is typically used in control systems that require simpler configuration regarding using Integrated Motion over an EtherNet/IP network.

The simpler control system often includes unmanaged switches, such as a Stratix 2000 switch, and Kinetix 350 drives, as shown in this example.

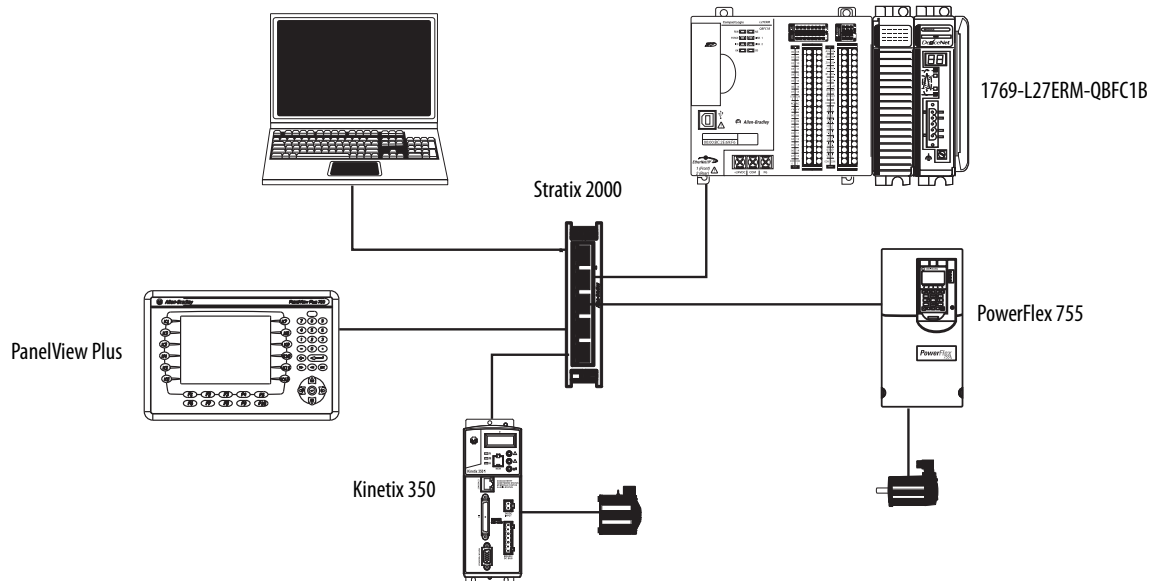

For more information on Integrated Motion over an EtherNet/IP network, see the publications that are listed on [page 11](#).

Notes:

Use a Secure Digital Card

This chapter describes the primary tasks that are required to store a project on an SD card or load a project from an SD card to the CompactLogix™ 5370 controller.

Topic	Page
Store or Load a Project with the Secure Digital Card	299
Store a Project	299
Load a Project	303

IMPORTANT The life expectancy of nonvolatile media is dependent on the number of write cycles that are performed. Nonvolatile media use a wear leveling technique, or technology for prolonging the service life, but avoid frequent writes.

Avoid frequent writes when logging data. We recommend that you log data to a buffer in the memory of your controller and limit the number of times data is written to removable media.

CompactLogix 5370 controllers support nonvolatile storage through the following SD cards:

- 1784-SD1 - Ships with CompactLogix 5370 controller and offers 1 GB of memory. You can order more 1784-SD1 cards if desired.
- 1784-SD2 cards - Available for separate purchase and offer 2 GB of memory.

For information on how to install or remove an SD card from a CompactLogix 5370 controller, see [Install the Secure Digital Card on page 72](#)

IMPORTANT We recommend that you leave the SD card installed in the controller and the card unlocked. The SD card saves extended diagnostic information that you can send to Rockwell Automation that provides enhanced diagnostics of your application and firmware revision if circumstances require this data.

This section briefly describes how to use the SD card when installed in a CompactLogix 5370 controller. The section details how to store a project from the controller to the SD card and how to load a project from the SD card to the controller.

However, you can complete other tasks by using the SD card, such as the following:

- Change the image that is loaded from the card
- Check for a load that was completed
- Clear an image from the memory card
- Store an empty image
- Change load parameters
- Read/write application data to the card

For more detailed information on how to use an SD card, see the Logix5000™ Controllers Nonvolatile Memory Card Programming Manual, publication [1756-PM017](#).

Store or Load a Project with the Secure Digital Card

There are several options for when to load the project back into the user memory (RAM) of the CompactLogix 5370 controller. The controller configuration determines the option that is used.

[Table 39](#) describes the conditions and necessary configuration settings that are required for a project to be loaded from an SD card.

Table 39 - Conditions and Settings for Project Loading

Condition to Load Project from an SD Card into Controller RAM	Required Setting in Controller Configuration	Notes
Controller power-up	On Power Up	<ul style="list-style-type: none"> During a power cycle, you lose any online changes and tag values you have not stored on the memory card. A load from a memory card can also change the firmware of the controller. For more information, see the Logix5000™ Controllers Nonvolatile Memory Card Programming Manual, publication 1756-PM017. You can use the application to load the project.
No project in the controller and you power up the controller	On Corrupt Memory	<ul style="list-style-type: none"> During a power cycle, you lose any online changes and tag values you have not stored on the memory card. A load from a memory card can also change the firmware of the controller. For more information, see the Logix5000 Controllers Nonvolatile Memory Card Programming Manual, publication 1756-PM017. You can use the application to load the project.
Only through application	User Initiated	You lose any online changes and tag values you have not stored on the memory card.

Store a Project

Follow these steps to store a project. These steps show a 1769-L18ERM-BB1B controller. The same steps apply for other CompactLogix 5370 controllers.

1. Go online with the controller.
2. Put the controller in Program mode, that is, Remote Program or Program.
3. On the Online tool bar, click the controller properties icon.

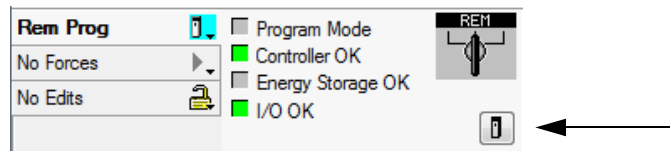

4. Click the Nonvolatile Memory tab.
5. Click Load/Store.

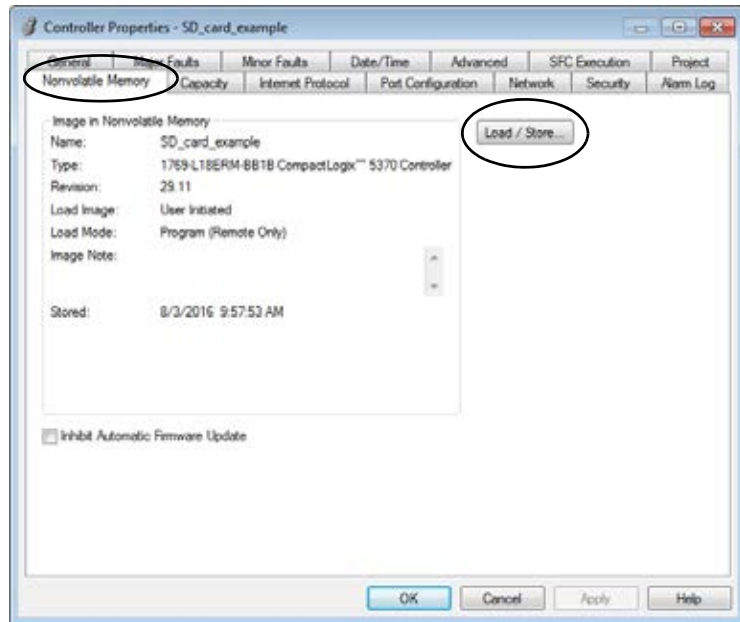

TIP If Load/Store is dimmed (unavailable), verify the following:

- You have specified the correct communication path and are online with the controller.
- The memory card is installed.

If the memory card is not installed, a message in the lower-left corner of the Nonvolatile Memory tab indicates the missing card as shown here.

 Nonvolatile memory not present.

- Choose under what conditions to load the project into the user memory of the controller.

Project that is on the memory card of the controller (if any project is there).

Project that is in the user memory of the controller.

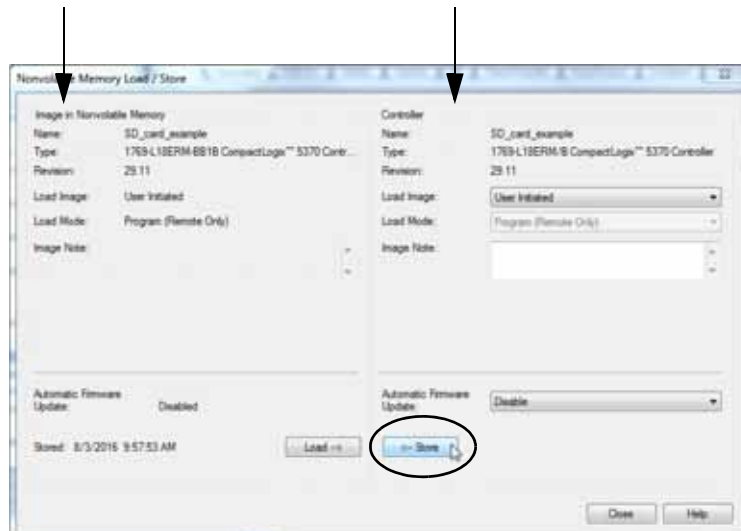

If you choose On Power Up or On Corrupt Memory, you must also choose the mode that you want the controller to go to after the load:

- Remote Program
 - Remote Run
- In the Automatic Firmware Update box, use the default (disable) or choose the Firmware Supervisor option.

IMPORTANT The Firmware Supervisor option is not used to update the controller firmware.

- Click <- Store.

IMPORTANT Store is not active if a SD card is locked.

A dialog box displays to confirm the store.

- To store the project, click Yes.
- Click OK.

After you click Store, the project is saved to the SD card as indicated by the controller status indicators. These conditions can exist:

- While the **store is in progress**, the following occurs:
 - The OK indicator is flashing green.
 - The SD indicator is flashing green.
 - A dialog box indicates that the store is in progress.

- When the **store is complete**, the following occurs:

- The controller resets itself.

When the controller is resetting itself, the status indicators execute a sequence of state changes, for example, a brief time with the OK status indicator in the solid red state. Wait for the controller to complete the sequence.

- After the controller fully resets itself, the OK indicator is solid green.
- The SD indicator is off.

IMPORTANT Allow the store to complete without interruption. If you interrupt the store, data corruption or loss can occur.

Load a Project

Follow these steps to use the application to load the project from an SD card. These steps show a 1769-L18ERM-BB1B controller. The same steps apply for other CompactLogix 5370 controllers.

1. Go online with the controller.
2. Put the controller in Program mode, that is, Remote Program or Program.
3. On the Online tool bar, click the controller properties icon.

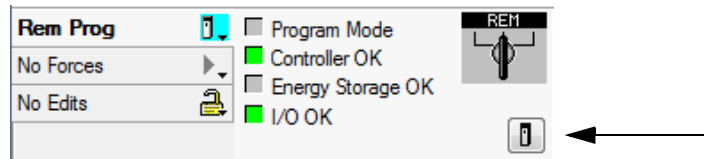

4. Click the Nonvolatile Memory tab.
5. Click Load/Store.

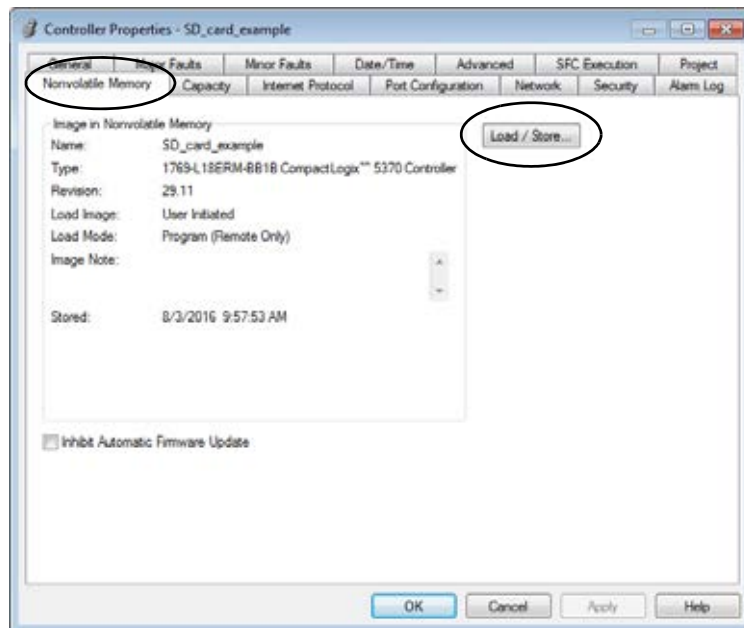

6. Click Load.

Project that is on the memory card of the controller (if any project is there).

Project that is in the user memory of the controller.

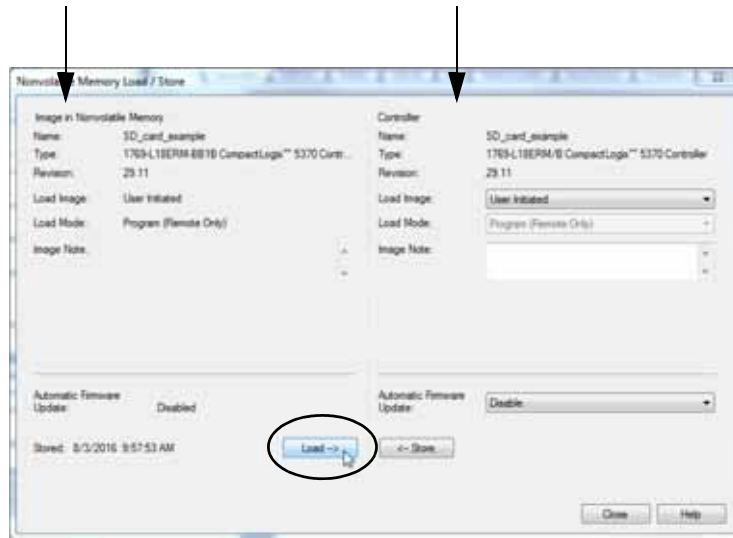

A dialog box prompts you to confirm the load.

7. To load the project, click Yes.

8. Click OK.

After you click Load, the project is loaded into the controller as indicated by the controller status indicators. These conditions can exist:

- While the **load is in progress**, the following occurs:
 - The controller resets itself.

When the controller is resetting itself, the status indicators execute a sequence of state changes, for example, a brief time with the OK status indicator in the solid red state. Wait for the controller to complete the sequence.
 - After the controller fully resets itself, the OK indicator is solid green.
 - The SD indicator is off.

Troubleshoot the Module

This section explains how to interpret the status indicators on your CompactLogix™ 5370 controllers. All controllers use the status indicators that are described in this table.

Status Indicator	Description
RUN	Indicates the operating mode of the controller.
FORCE	Indicates the force state.
I/O	Indicates the current state of communication between the controller and I/O modules.
OK	Indicates the state of the controller.
NS	Indicates the EtherNet/IP network status regarding the controller operating on the network.
LINK 1	Indicates the EtherNet/IP link status for port 1 of the controller.
LINK 2	Indicates the EtherNet/IP link status for port 2 of the controller.
SD	Indicates if there is activity on the SD card.

Use Logix Designer Application for Troubleshooting

The Logix Designer application indicates fault conditions in the following ways:

- Warning signal
- Message
- Notification in the tag editor

Warning signal on the main screen next to the module - This occurs when the connection to the module is broken. The controller state also indicates Faulted and the Controller fault is illuminated in red.

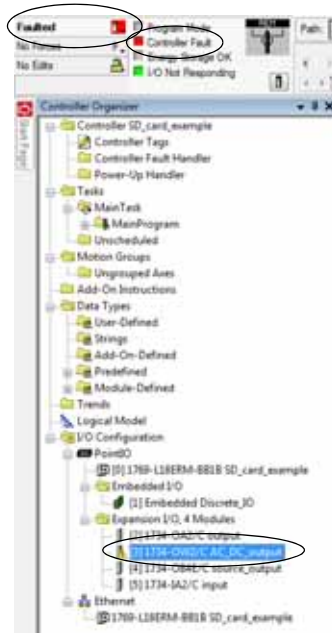

Message in the status line of a screen.



On the Module Info tab, in the Status section, the Major and Minor Faults are listed along with the Internal State of the module.

Notification in the Tag Editor - General module faults are also reported in the Tag Editor. Diagnostic faults are reported only in the tag editor.

The Value field indicates a fault with the number 1.

Name	Value	Force Mask	Style	Data Type
Local:1:C	{...}	{...}		AB:Embedded_Di...
Local:1:I	{...}	{...}		AB:Embedded_Di...
Local:1:1.Fault	2#0000_0000_0...		Binary	DINT
Local:1:1.Fault.0	0		Decimal	BOOL
Local:1:1.Fault.1	0		Decimal	BOOL
Local:1:1.Fault.2	0		Decimal	BOOL
Local:1:1.Fault.3	0		Decimal	BOOL
Local:1:1.Fault.4	0		Decimal	BOOL

Fault Type Determination

To display recent fault information in the Major Faults tab of the Module Properties screen, you must check the Major Fault on Controller if Connection Fails While in Run Mode in the Connection tab.

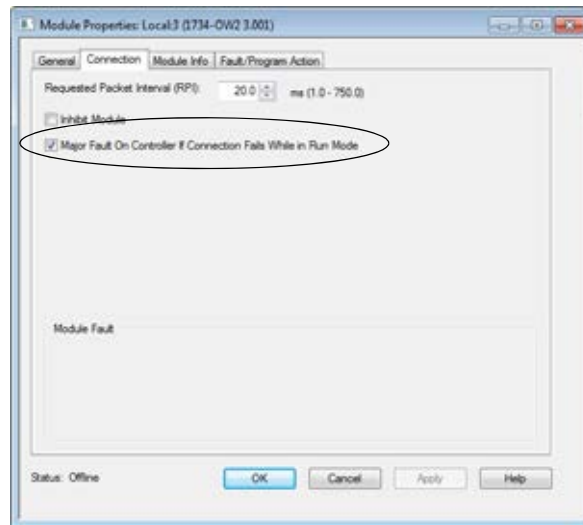

The Major Faults tab indicates the type of fault under Recent Faults. A fault displays here when you are monitoring the configuration properties of a module in the Logix Designer application and receive a Communication fault message.

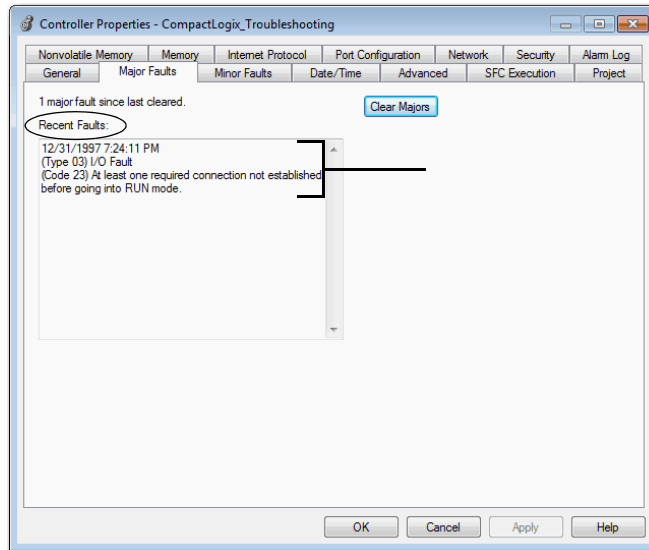

Use the CompactLogix 5370 Controllers Status Indicators

The following graphic shows the controller status indicators for all CompactLogix 5370 controllers.

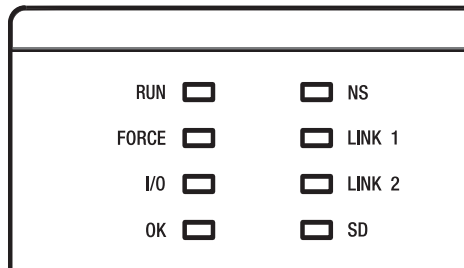

Table 40 - Controller Mode (RUN) Status Indicator

Status	Description
Off	The controller is in Program or Test mode.
Green	The controller is in Run mode.

Table 41 - Force State (FORCE) Status Indicator

Status	Description
Off	No tags contain I/O force values. I/O forces are inactive (disabled).
Yellow	I/O forces are active (enabled). I/O force values can exist.
Flashing yellow	One or more input or output addresses have been forced to an On or Off condition, but the forces have not been enabled.

Table 42 - I/O State (I/O) Status Indicator

Status	Description
Off	One of the following conditions exists: <ul style="list-style-type: none"> • There are no devices in the I/O configuration of the controller. - Applies to only CompactLogix 5370 L3 controllers. • The controller does not contain a project.
Green	The controller is communicating with all devices in its I/O configuration.
Flashing green	One or more devices in the I/O configuration of the controller are not responding.
Flashing red	One of the following conditions exists: <ul style="list-style-type: none"> • The controller is not communicating with any devices. • A fault has occurred on the controller. - Only CompactLogix 5370 L1 and L2 controllers.

Table 43 - Controller Status (OK) Status Indicator

Status	Description
Off	No power is applied.
Green	The controller is OK.
Flashing green	The controller is storing a project to or loading a project from the SD card.
Red	The controller detected a nonrecoverable major fault and cleared the project from memory.
Flashing red	One of the following: <ul style="list-style-type: none"> • The controller requires a firmware update. • A major recoverable fault occurred on the controller. • A nonrecoverable major fault occurred on the controller and cleared the program from memory. • A controller firmware update is in process. • An embedded I/O module firmware update is in process. - Only CompactLogix 5370 L1 controllers.
Dim green to red	Save to Flash at power-down.

Table 44 - Ethernet Network Status (NS) Status Indicator

Status	Description
Off	The port is not initialized; it does not have an IP address and is operating in BOOTP or DHCP mode.
Green	The port has an IP address and CIP connections are established.
Flashing green	The port has an IP address, but no CIP connections are established.
Red	The port has detected that the assigned IP address is in use.
Flashing red/green	The port is performing its power-up self test.

Table 45 - Ethernet Link Status (LINK 1/LINK 2) Status Indicator

Status	Description
Off	One of the following conditions exists: <ul style="list-style-type: none"> • No link. • Port administratively disabled. • Port disabled because rapid ring fault condition was detected (LINK2).
Green	One of the following conditions exists: <ul style="list-style-type: none"> • A 100 Mbps link (half- or full-duplex) exists, no activity. • A 10 Mbps link (half- or full-duplex) exists, no activity. • Ring network is operating normally and the controller is the active supervisor. • Ring network has encountered a rare partial network fault and the controller is the active supervisor.
Flashing green	One of the following conditions exists: <ul style="list-style-type: none"> • A 100 Mbps link exists and there is activity. • A 10 Mbps link exists and there is activity.

Table 46 - SD Card Activity (SD) Status Indicator

Status	Description
Off	There is no activity to the SD card.
Flashing green	The controller is reading from or writing to the SD card.
Flashing red	The SD card does not have a file system.

Replacement Considerations

The CompactLogix™ L1 Series B controller is a direct replacement for the Series A controller. The Series B controller has an improved power supply circuit to the isolated power supply so that a second power supply is no longer needed.

The Series A controller requires two power supplies:

- One to supply the controller power (VDC)
- One to supply the field power (FP)

Product Comparison

Power Considerations

CompactLogix L1 Series A and Series B

Characteristics	CompactLogix L1 Series B	CompactLogix L1 Series A
Power dissipation	11.5 W	12 W
Recommended external short circuit protection, field power	User-provided 4...5 A @ 3.15...5.5 I ² t fuse	User-provided 4...6 A @ 52.5...68.25 I ² t fuse
Embedded power supply	24V DC input, isolated	24V DC input, non-isolated
Line requirement (V DC), min	30VA	50VA
Current draw @ 24V DC, field power, max	3 A @ 24V DC	–

Embedded DC Input Considerations

CompactLogix L1 Series A and Series B

Characteristics	CompactLogix L1 Series B	CompactLogix L1 Series A
Off-state current, max	1 mA	1.5 mA
Input impedance, max	5.4 kΩ	4.7 kΩ

Firmware Compatibility

CompactLogix L1 Series A and Series B

Firmware Revision							
	20.011	20.012	20.013	20.014	20.011	23.012	24.011
Series A	yes	yes	yes	yes	yes	yes	yes
Series B	no	no	no	yes	no	no	yes

Series A Wiring

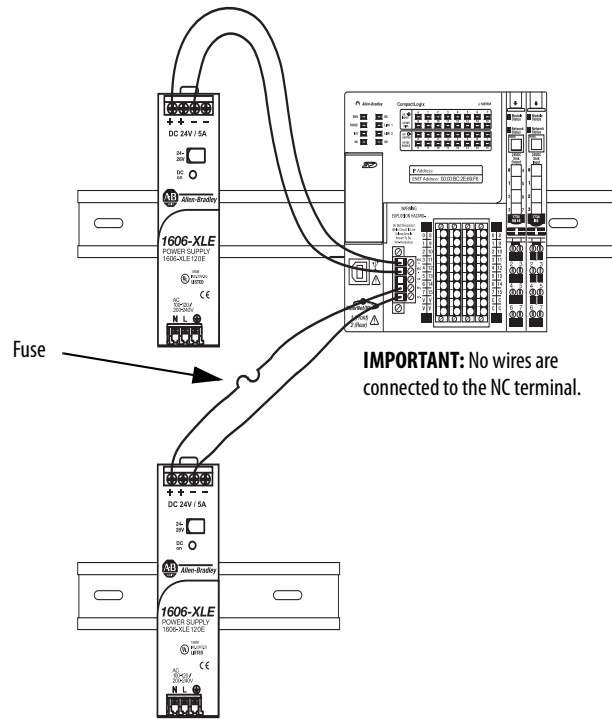

Examples

Replace the Controller and Update the Firmware

In this example:

- Replace a Series A controller with a Series B controller
- Update controller firmware from V21 to V23

Requirements:

Category	Tasks
Power Supply Wiring	The series B controller requires only one power supply, but the Series B controller does support two power supplies. You can retain the current power supply design for the Series A controller and avoid rewiring.
Controller Firmware	Install firmware, V24
Programming Software	Install the Studio 5000® environment, V24
Personal Computer	Windows 7

Replace the Controller

In this example:

- Replace a Series A controller with a Series B controller
- Leave controller at firmware revision 20

Requirements:

Category	Tasks
Power Supply Wiring	The Series B controller requires only one power supply, but the Series B controller does support two power supplies. You can retain the current power supply design for the Series A controller and avoid rewiring.
Controller Firmware	Install Firmware, V20
Programming Software	No change required
Personal Computer	Windows XP

Connect Power to the Series A CompactLogix 5370 L1 Controllers

This appendix explains how to connect power to the series A L1 CompactLogix™ 5370 controllers.

Topic	Page
CompactLogix 5370 L1, Series A, Controller Power Connection	315
CompactLogix 5370 L1, Series A, Controller Field Power to I/O Devices Connection	320

CompactLogix 5370 L1, Series A, Controller Power Connection

IMPORTANT This section describes how to power the controller via the VDC+ and VDC- terminals.

Connections to the VDC+ and VDC- terminals **do not** provide power to input or output devices that are connected to the embedded I/O modules of the controller or local expansion modules. You must connect power to the FP+ and FP- terminals to provide power to I/O devices that are connected to the embedded I/O modules of the controller or local expansion modules.

For more information on how to provide power to input or output devices that are connected to the embedded I/O modules of the controller and local expansion modules, see [page 320](#).

The external power supply must be dedicated to the embedded supply of the controller. The external power supply converts 115/230V AC power to 24V DC or other application-required DC voltage that is within the operating range of the controller.



WARNING: Do not connect directly to line voltage. Line voltage must be supplied by a suitable, approved isolating transformer or power supply having short circuit capacity not exceeding 100VA maximum or equivalent. The controller power requirement is 50VA.

Power is connected to the controller via a removable connector that is connected to the front of the controller. The following graphic shows the connector.

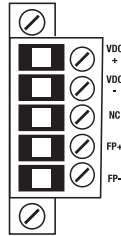

IMPORTANT The controller is grounded once it is installed on a DIN rail as described in [Mount the System on page 32](#).

Consider these points before completing the steps in this section:

- This section describes how to connect an external 24V DC power source to the CompactLogix 5370 L1 controller.

For information on how to provide field power to input and output devices that are connected to the embedded I/O modules of the controller and local expansion modules via the removable connector, see [page 144](#).



ATTENTION: You must use an external power supply that is Class 2 or SELV-listed.

-
- The external power supply that provides power to the CompactLogix 5370 L1 controller must be dedicated to power the controller.
 - You must use a separate, dedicated external 24V DC power source to connect power to other terminals on the removable connector and devices in the system, for example, the FP+ terminal or a barcode scanner, respectively.
 - The external 24V DC power source that is connected to the VDC+ and VDC- terminals on the removable connector must reside in the same enclosure as the CompactLogix 5370 L1 controller.

- Use a power source that most effectively meets your application needs. That is, calculate the power requirements for your application before choosing a power source to avoid using a power source that far exceeds your application requirements.
- This section assumes that any DIN rail you use has been grounded following Industrial Automation Wiring and Grounding Guidelines, publication [1770-4.1](#).
- The embedded power supply of the CompactLogix 5370 L1 controller provides power to the controller and POINTBus™ backplane. It does not provide field-side power to the embedded I/O or local expansion modules.
- Not all Class 2/SELV-listed power supplies are certified for use in all applications, for example, use in nonhazardous and hazardous environments.

Before installing an external power supply, consult all specification and certification information to verify that you are using an acceptable external power supply.

- Only for example purposes, this section describes how to use a 1606-XLE120E, NEC Class 2 switched-mode power supply. The exact steps for other external power supplies can vary from the steps that are described here.

Complete these steps to connect power to the CompactLogix 5370 L1 controller. Series B L1 CompactLogix 5370 controllers can also be connected to power as instructed in this procedure.

1. Verify that the external 24V DC power source is not powered.
2. Mount the external 24V DC power source on a DIN rail.

The external 24V DC power source can be installed on the same DIN rail as the controller or a separate DIN rail.

3. Connect wires to the 24V DC+ and 24V DC- connections on the external 24V DC power source.



WARNING: If you connect or disconnect wiring while the field-side power is on, an electrical arc can occur. This could cause an explosion in hazardous location installations. Be sure that power is removed or the area is nonhazardous before proceeding.

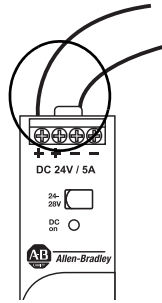

4. Pull the removable connector off the CompactLogix 5370 L1 controller.

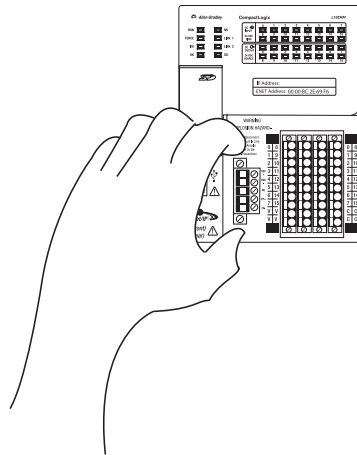

5. Connect the wire that is connected to the 24V DC+ terminal on the external 24V DC power source to the VDC+ terminal. The VDC+ terminal is the top terminal on the removable connector.

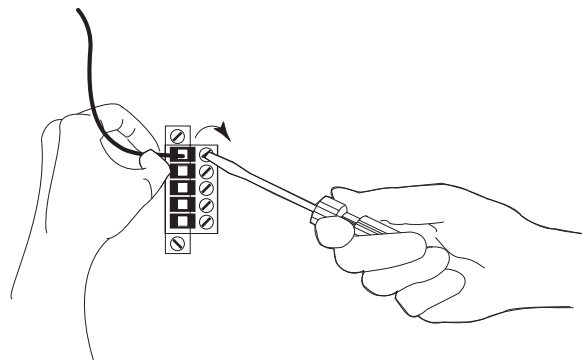

- Connect the wire that is connected to the 24V DC- terminal on the external 24V DC power source to the VDC- terminal. The VDC- terminal is second from the top on the removable connector.

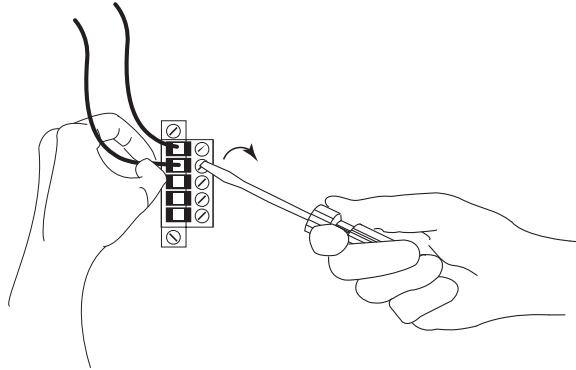

IMPORTANT If your application requires a power control device, for example, a switch or relay, between the external 24V DC power source and the CompactLogix 5370 L1 controller to control when the controller is powered, you must install the power control device at the VDC+ terminal on the removable connector.

If you install the power control device at the VDC- terminal, the CompactLogix 5370 L1 controller can have problems powering up or powering down properly.

- Plug the removable connector back into the controller.
- Secure the removable connector in place.

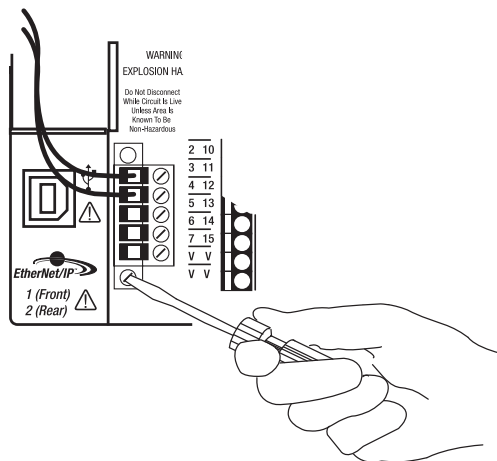

- Turn on power to the external 24V DC power source.

The following graphic shows an external 24V DC power source that is connected to a CompactLogix 5370 L1 controller.

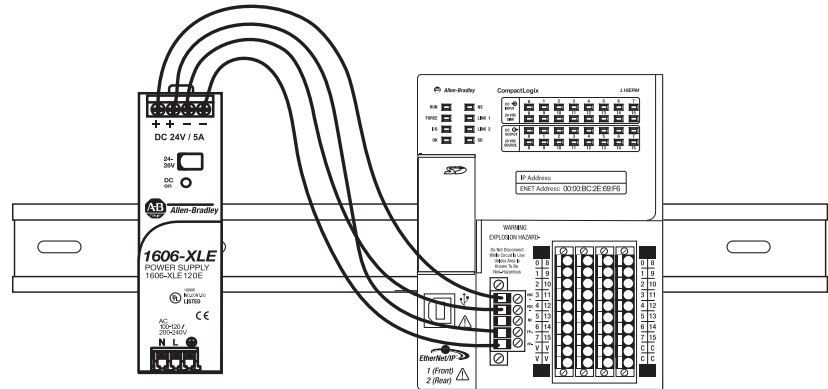

CompactLogix 5370 L1, Series A, Controller Field Power to I/O Devices Connection

Complete these steps to connect field power to the CompactLogix 5370 L1 series A controller. Series B L1 CompactLogix 5370 controllers can also be connected to field power as instructed in this procedure.

1. Verify that the separate external 24V DC power source that powers the CompactLogix 5370 L1 controller is not powered.
2. Verify that the external 24V DC power source that is connected to the FP+ and FP- terminals is not powered.
3. Mount the external power supply that connects to the FP+ and FP- terminals on a DIN rail.

The external power supply can be installed on the same DIN rail as the controller or a separate DIN rail.

4. Connect wires to the appropriate + and - connections on the external 24V DC power source.

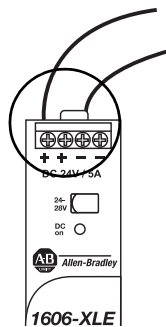

WARNING: If you connect or disconnect wiring while the field-side power is on, an electrical arc can occur. This could cause an explosion in hazardous location installations. Be sure that power is removed or the area is nonhazardous before proceeding.

5. Pull the removable connector off of the CompactLogix 5370 L1 controller.

Wires connected between external 24V DC power source and VDC+ and VDC- terminals on the removable connector.

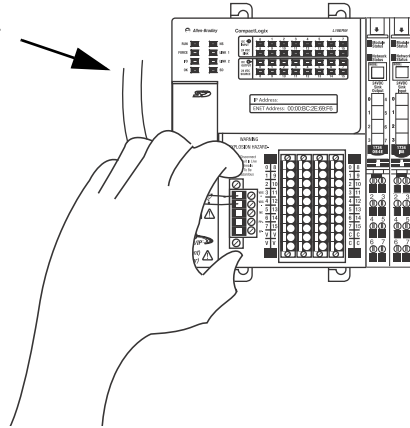

6. Connect the wire that is connected to the + terminal on the external 24V DC power source to the FP+ terminal. The FP+ terminal is the fourth terminal from the top on the removable connector.

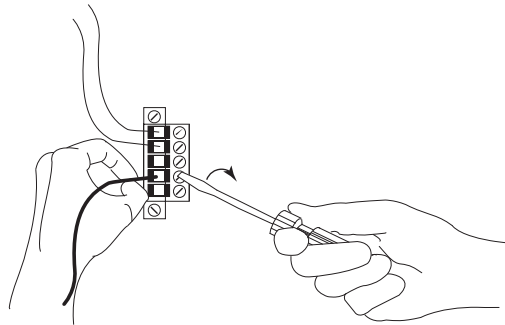

7. Connect the wire that is connected to the - terminal on the external 24V DC power source to the FP- terminal. The FP- terminal is the fifth terminal from the top on the removable connector.

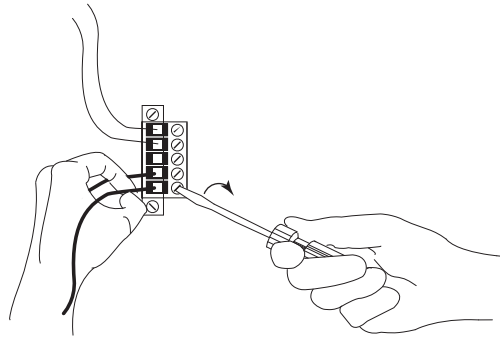

8. Plug the removable connector into the controller.
9. Secure the removable connector in place.

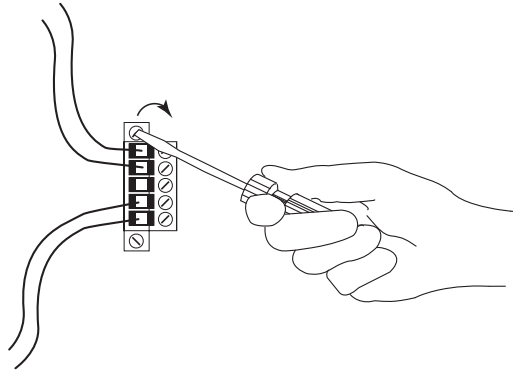

10. Turn on power to the separate external 24V DC power source connected to the VDC+ and VDC- terminals of the removable connector.
11. Turn on power to the external 24V DC power source connected to the FP+ and FP- terminals of the removable connector.

The following graphic shows **separate** external 24V DC power supplies connected to the VDC+/VDC- and FP+/FP- terminals on the removable connector, respectively.

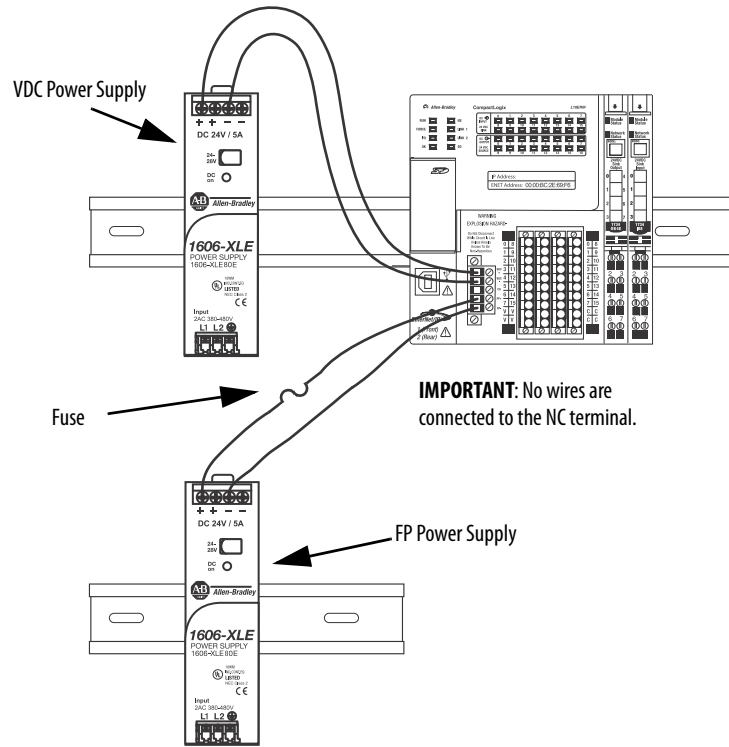

IMPORTANT Install a user-replaceable fuse with overcurrent protection of 4...6 A @ 52.5...68.25 I²t in line between the incoming power and the FP+ terminal.

Notes:

Numerics

- 1734 POINT I/O modules** 143 ... 179
 - BUS OFF detection and recovery 179
 - configure 172 ... 177
 - monitor faults 177
 - removal and insertion under power 163
 - requested packet interval 164
 - select 143
 - using as local expansion modules with CompactLogix 5370 L1 controllers 28
 - validate layout 162 ... 167
- 1769 Compact I/O modules** 235 ... 259
 - calculate system power consumption 243 ... 245
 - CompactLogix 5370 L3 controllers 70
 - configure 223 ... 226, 251 ... 257
 - connections 226, 252
 - end cap detection 233, 259
 - local banks available with CompactLogix 5370 L3 controllers 70
 - monitor faults 232, 258
 - requested packet interval 217, 225, 240, 252
 - select 181, 235
 - using as local expansion modules with CompactLogix 5370 L2 controllers 48
 - validate layout 240 ... 248
- 1769 Compact I/O power supplies**
 - calculate system power consumption 243 ... 245
- 1784-SD1 and 1784-SD2 cards** 29, 49
 - installation
 - CompactLogix 5370 L1 controllers 30 ... 31
 - CompactLogix 5370 L2 controllers 50 ... 51
 - CompactLogix 5370 L3 controllers 72 ... 73

A

- additional resources** 11
- Add-On Instructions**
 - in project 273
- application**
 - elements 261
- AutoFlash** 109
 - load firmware 114 ... 117

B

- BOOTP server** 87
 - set IP address 91 ... 95

C

- CompactLogix 5370 L1 controllers**
 - connecting power 37 ... 41, 315 ... 323
 - connections to I/O modules 174
 - DIN rail use 32
 - direct connections 174
 - embedded I/O module 27
 - wiring diagrams 152
 - embedded power supply 27, 317
 - example EtherNet/IP network system
 - configuration 18
 - grounding 32, 35
 - I/O modules 143 ... 179
 - installation 23 ... 43
 - grounding 35
 - minimum spacing 33
 - mounting 32 ... 34
 - SD card 30 ... 31
 - system dimensions 34
 - integrated motion over an EtherNet/IP network 283 ... 295
 - local expansion modules 28
 - BUS OFF detection and recovery 179
 - removal and insertion under power 163
 - minimum spacing 33
 - mounting 32 ... 34
 - networks
 - EtherNet/IP network connection 43
 - USB connection 42
 - parts 29
 - place I/O modules 167
 - rack-optimized connections 174
 - select I/O modules 143
 - selecting operating mode 118 ... 119
 - status indicators 305 ... 310
 - system components 14, 26
 - system dimensions 34
 - wiring diagrams 152
- CompactLogix 5370 L2 controllers**
 - connecting power 62 ... 64
 - connections to I/O modules 226
 - DIN rail use 52, 57
 - direct connections 226
 - embedded I/O module 48
 - embedded power supply 48, 62
 - example DeviceNet network system
 - configuration 20
 - example EtherNet/IP network system
 - configuration 19
 - grounding 52, 58
 - installation 45 ... 66
 - grounding 58
 - minimum spacing 53
 - mounting 52 ... 53, 56
 - SD card 50 ... 51

- system dimensions 53
 - integrated motion over an EtherNet/IP network 283 ... 295
 - local expansion modules 48
 - minimum spacing 53
 - mounting 52 ... 53, 56
 - networks
 - EtherNet/IP network connection 66
 - USB connection 65
 - parts 49
 - rack-optimized connections 226
 - select I/O modules 181
 - selecting operating mode 118 ... 119
 - status indicators 305 ... 310
 - system components 14, 48
 - system dimensions 53
 - CompactLogix 5370 L3 controllers**
 - available local I/O banks 70
 - calculate system power consumption 243 ... 245
 - connecting power 76
 - connections to I/O modules 252
 - DIN rail use 83
 - direct connections 252
 - example DeviceNet network system configuration 20
 - example EtherNet/IP network system configuration 19
 - grounding 81
 - I/O modules 235 ... 259
 - installation 67 ... 86
 - grounding 81
 - minimum spacing 79
 - mounting 82
 - SD card 72 ... 73
 - system dimensions 80
 - integrated motion over an EtherNet/IP network 283 ... 295
 - local 1769 Compact I/O modules 70
 - removal and insertion under power 74
 - minimum spacing 79
 - mounting 78 ... 81, 82
 - networks
 - EtherNet/IP network connection 85
 - USB connection 84
 - parts 71
 - power supply
 - distance rating 70, 81
 - rack-optimized connections 252
 - select I/O modules 235
 - selecting operating mode 118 ... 119
 - status indicators 305 ... 310
 - system components 14, 70
 - system dimensions 80
 - configure**
 - I/O modules
 - for use with CompactLogix 5370 L1 controllers 172 ... 177
 - for use with CompactLogix 5370 L2 controllers 223 ... 226
 - for use with CompactLogix 5370 L3 controllers 251 ... 257
 - system overhead time slice 281
 - connections**
 - direct
 - CompactLogix 5370 L1 controllers 174
 - CompactLogix 5370 L2 controllers 226
 - CompactLogix 5370 L3 controllers 252
 - rack-optimized
 - CompactLogix 5370 L1 controllers 174
 - CompactLogix 5370 L2 controllers 226
 - CompactLogix 5370 L3 controllers 252
 - to I/O modules
 - CompactLogix 5370 L1 controllers 174
 - CompactLogix 5370 L2 controllers 226
 - CompactLogix 5370 L3 controllers 252
 - continuous task** 264
 - ControlFLASH utility** 87, 109
 - load firmware 110 ... 113
 - controller**
 - monitor
 - connections 277
 - program 266
 - routine 268
 - tags 269
 - tasks 262
- ## D
- develop**
 - applications 261
 - Device Level Ring topology** 86
 - DHCP server** 87
 - set IP address 98
 - DIN rail**
 - CompactLogix 5370 L1 controllers 32
 - CompactLogix 5370 L2 controllers 52, 57
 - CompactLogix 5370 L3 controllers 83
 - direct connections**
 - CompactLogix 5370 L1 controllers 174
 - CompactLogix 5370 L2 controllers 226
 - CompactLogix 5370 L3 controllers 252
 - distance rating**
 - power supply
 - CompactLogix 5370 L3 controllers 70, 81

E**elements**

- control application 261

embedded I/O module

- CompactLogix 5370 L1 controllers 27
- CompactLogix 5370 L2 controllers 48
- wiring diagrams 152

embedded power supply

- CompactLogix 5370 L1 controllers 317
 - calculate system power consumption 166, 219
- CompactLogix 5370 L2 controllers 62

enclosures

- minimum spacing
 - CompactLogix 5370 L1 controllers 33
 - CompactLogix 5370 L2 controllers 53
- system dimensions
 - CompactLogix 5370 L1 controllers 34
 - CompactLogix 5370 L2 controllers 53

EtherNet/IP network

- available network topologies 43, 66, 86
- change IP address 105 ... 108
 - via Logix Designer application 107 ... 108
 - via RSLinx Classic software 106
 - via SD card 108
- connection for CompactLogix 5370 L1 controllers 43
- connection for CompactLogix 5370 L2 controllers 66
- connection for CompactLogix 5370 L3 controllers 85
- example configurations 18 ... 19
- Integrated Motion over an EtherNet/IP network 16, 283 ... 295
- set IP address 89 ... 104
 - via BOOTP server 91 ... 95
 - via DHCP server 98
 - via Logix Designer application 101 ... 103
 - via RSLinx Classic software 99 ... 100
 - via SD card 104

- event task** 168 ... 171, 264

F**fault code**

- use GSV to get 278

faults

- monitor I/O module faults
 - CompactLogix 5370 L1 controllers 177
 - CompactLogix 5370 L2 controllers 232
 - CompactLogix 5370 L3 controllers 258

firmware

- load 109 ... 117
 - via AutoFlash 114 ... 117
 - via ControlFLASH utility 110 ... 113
 - via SD card 117

G**grounding**

- CompactLogix 5370 L1 controllers 32, 35
- CompactLogix 5370 L2 controllers 52, 58
- CompactLogix 5370 L3 controllers 81

GSV

- fault code 278
- monitor
 - connection 278

I**I/O modules**

- calculate system power consumption
 - CompactLogix 5370 L1 controllers 166
 - CompactLogix 5370 L2 controllers 219
 - CompactLogix 5370 L3 controllers 243 ... 245
- CompactLogix 5370 L1 controllers 143 ... 179
 - BUS OFF detection and recovery 179
 - local expansion modules 157
- CompactLogix 5370 L2 controllers 181 ... 233
 - local expansion modules 213
- CompactLogix 5370 L3 controllers 235 ... 259
 - local 1769 Compact I/O modules 70
- configure
 - for use with CompactLogix 5370 L1 controllers 172 ... 177
 - for use with CompactLogix 5370 L2 controllers 223 ... 226
 - for use with CompactLogix 5370 L3 controllers 251 ... 257
- connections
 - CompactLogix 5370 L1 controllers 174
 - CompactLogix 5370 L2 controllers 226
 - CompactLogix 5370 L3 controllers 252
- embedded I/O module on CompactLogix 5370 L1 controllers 27
- embedded I/O module on CompactLogix 5370 L2 controllers 48
- end cap detection
 - CompactLogix 5370 L2 controllers 233
 - CompactLogix 5370 L3 controllers 259
- monitor faults
 - CompactLogix 5370 L1 controllers 177
 - CompactLogix 5370 L2 controllers 232
 - CompactLogix 5370 L3 controllers 258
- place
 - CompactLogix 5370 L1 controllers 167
- requested packet interval 225, 252
 - CompactLogix 5370 L1 controllers 164, 173
 - CompactLogix 5370 L2 controllers 217
 - CompactLogix 5370 L3 controllers 240
- select
 - CompactLogix 5370 L1 controllers 143
 - CompactLogix 5370 L2 controllers 181
 - CompactLogix 5370 L3 controllers 235
- validate layout
 - 1734 POINT I/O modules 162 ... 167
 - 1769 Compact I/O modules 217 ...

- 222, 240 ... 248
 - CompactLogix 5370 L1 controllers 162 ... 167
 - CompactLogix 5370 L2 controllers 217 ... 222
 - CompactLogix 5370 L3 controllers 240 ... 248
 - installation**
 - CompactLogix 5370 L1 controllers 23 ... 43
 - CompactLogix 5370 L2 controllers 45 ... 66
 - CompactLogix 5370 L3 controllers 67 ... 86
 - DIN rail
 - CompactLogix 5370 L1 controllers 32
 - CompactLogix 5370 L2 controllers 52, 57
 - CompactLogix 5370 L3 controllers 83
 - grounding
 - CompactLogix 5370 L1 controllers 35
 - CompactLogix 5370 L2 controllers 58
 - CompactLogix 5370 L3 controllers 81
 - local 1769 Compact I/O modules
 - CompactLogix 5370 L3 controllers 236
 - minimum spacing
 - CompactLogix 5370 L1 controllers 33
 - CompactLogix 5370 L2 controllers 53
 - CompactLogix 5370 L3 controllers 79
 - mounting
 - CompactLogix 5370 L1 controllers 32 ... 34
 - CompactLogix 5370 L2 controllers 52 ... 53, 56
 - CompactLogix 5370 L3 controllers 78 ... 81, 82
 - panel mounting
 - CompactLogix 5370 L2 controllers 56
 - CompactLogix 5370 L3 controllers 82
 - power supply connections to CompactLogix
 - 5370 L1 controllers 37 ... 41, 315 ... 323
 - power supply connections to CompactLogix
 - 5370 L2 controllers 62 ... 64
 - required software tasks 87 ... 119
 - SD card
 - CompactLogix 5370 L1 controllers 30 ... 31
 - CompactLogix 5370 L2 controllers 50 ... 51
 - CompactLogix 5370 L3 controllers 72 ... 73
 - system dimensions
 - CompactLogix 5370 L1 controllers 34
 - CompactLogix 5370 L2 controllers 53
 - CompactLogix 5370 L3 controllers 80
 - Integrated Motion over an EtherNet/IP network** 16, 283 ... 295
 - configure 288 ... 291
 - drive limits 286
 - example configuration
 - CompactLogix 5370 L1 controllers 294
 - CompactLogix 5370 L2 controllers 295
 - CompactLogix 5370 L3 controllers 292
 - supported axes 284
 - time synchronization 287
 - IP address** 87
 - change 105 ... 108
 - via Logix Designer application 107 ... 108
 - via RSLinx Classic software 106
 - via SD card 108
 - set 89 ... 104
 - via BOOTP server 91 ... 95
 - via DHCP server 98
 - via Logix Designer application 101 ... 103
 - via RSLinx Classic software 99 ... 100
 - via SD card 104
- ## L
- linear network topology** 86
 - local 1769 Compact I/O modules**
 - CompactLogix 5370 L3 controllers 70
 - local expansion modules**
 - 1734 POINT I/O modules 28
 - 1769 Compact I/O modules 48
 - CompactLogix 5370 L1 controllers 28
 - CompactLogix 5370 L2 controllers 48
 - local I/O banks**
 - CompactLogix 5370 L3 controllers 70
 - Logix Designer application**
 - AutoFlash 109
 - change IP address 107 ... 108
 - configure I/O modules
 - for use with CompactLogix 5370 L1 controllers 172 ... 177
 - for use with CompactLogix 5370 L2 controllers 223 ... 226
 - for use with CompactLogix 5370 L3 controllers 251 ... 257
 - Integrated Motion over an EtherNet/IP network 283 ... 295
 - load a project to an SD card 303 ... 304
 - set IP address 101 ... 103
 - store a project to an SD card 299 ... 302
 - using event task 168 ... 171
- ## M
- memory storage**
 - SD cards 29, 49
 - minimum spacing**
 - CompactLogix 5370 L1 controllers 33
 - CompactLogix 5370 L2 controllers 53
 - CompactLogix 5370 L3 controllers 79
 - mounting**
 - CompactLogix 5370 L1 controllers 32 ... 34
 - CompactLogix 5370 L2 controllers 52 ... 53, 56
 - CompactLogix 5370 L3 controllers 78 ... 81, 82

N**networks**

- DeviceNet
 - example CompactLogix 5370 L2 controller system configuration 20
 - example CompactLogix 5370 L3 controller system configuration 20
- EtherNet/IP
 - change IP address via Logix Designer application 107 ... 108
 - change IP address via RSLinx Classic software 106
 - change IP address via SD card 108
 - example configurations 18 ... 19
 - network connection for CompactLogix 5370 L1 controllers 43
 - network connection for CompactLogix 5370 L2 controllers 66
 - network connection for CompactLogix 5370 L3 controllers 85
 - set IP address via BOOTP server 91 ... 95
 - set IP address via DHCP server 98
 - set IP address via Logix Designer application 101 ... 103
 - set IP address via RSLinx Classic software 99 ... 100
 - set IP address via SD card 104
- USB
 - connection for CompactLogix 5370 L1 controllers 42
 - connection for CompactLogix 5370 L2 controllers 65
 - connection for CompactLogix 5370 L3 controllers 84

O**operating mode**

- selecting 118 ... 119

P**panel mounting**

- CompactLogix 5370 L2 controllers 56
- CompactLogix 5370 L3 controllers 82

periodic task 264**power supply**

- connections to CompactLogix 5370 L1 controllers 37 ... 41, 315 ... 323
- connections to CompactLogix 5370 L2 controllers 62 ... 64
- connections to CompactLogix 5370 L3 controllers 76
- distance rating
 - CompactLogix 5370 L3 controllers 81
- embedded power supply with
 - CompactLogix 5370 L1 controllers 27, 317
- embedded power supply with
 - CompactLogix 5370 L2 controllers 48, 62

priority

- task 265

program

- in project 266
- scheduled 267
- system overhead time slice 280
- unscheduled 267

programming languages 272**project**

- elements 261

R**rack-optimized connections**

- CompactLogix 5370 L1 controllers 174
- CompactLogix 5370 L2 controllers 226
- CompactLogix 5370 L3 controllers 252

removal and insertion under power

- local 1769 Compact I/O modules
 - CompactLogix 5370 L3 controllers 74
- local expansion modules
 - CompactLogix 5370 L1 controllers 163

requested packet interval

- CompactLogix 5370 L1 controllers 164, 173
- CompactLogix 5370 L2 controllers 217, 225
- CompactLogix 5370 L3 controllers 240, 252

routine

- in project 268

RSLinx Classic software 87

- change IP address 106
- set IP address 99 ... 100

RSLogix 5000 software 87**RSNetWorx for DeviceNet software** 87**S****sample projects** 282**scheduled**

- program 267

SD card 109, 297 ... 304

- change IP address 108
- installation
 - CompactLogix 5370 L1 controllers 30 ... 31
 - CompactLogix 5370 L2 controllers 50 ... 51
 - CompactLogix 5370 L3 controllers 72 ... 73

- load a project 303 ... 304

- load firmware 117

- set IP address 104

- store a project 299 ... 302

software

- BOOTP 87
 - set IP address 91 ... 95

- DHCP 87

- set IP address 98

- Logix Designer application

- AutoFlash 109

- required installation tasks 87 ... 119

- RSLinx Classic 87

- change IP address 106

- set IP address 99 ... 100
 - RSLogix 5000 87
 - RSNetWorx for DeviceNet 87
 - Studio 5000 environment 87
- star network topology** 86
- status**
 - monitor
 - connections 277
- status indicators** 305 ... 310
- Studio 5000 environment** 87
- Studio 5000 Logix Designer application. See Logix Designer application**
- system assembly**
 - calculate system power consumption
 - CompactLogix 5370 L1 controllers 166, 219
 - CompactLogix 5370 L3 controllers 243 ... 245
 - CompactLogix 5370 L3 controllers
 - select I/O modules 235
 - place I/O modules
 - CompactLogix 5370 L1 controllers 167
 - select I/O modules
 - CompactLogix 5370 L1 controllers 143
 - CompactLogix 5370 L2 controllers 181
 - validate I/O modules layout
 - 1734 POINT I/O modules 162 ... 167
 - 1769 Compact I/O modules 217 ... 222
 - CompactLogix 5370 L1 controllers 162 ... 167
 - CompactLogix 5370 L2 controllers 217 ... 222
 - CompactLogix 5370 L3 controllers 240 ... 248
- system components**
 - CompactLogix 5370 L1 controllers 14, 26
 - CompactLogix 5370 L2 controllers 14, 48
 - CompactLogix 5370 L3 controllers 14, 70
- system dimensions**
 - CompactLogix 5370 L1 controllers 34
 - CompactLogix 5370 L2 controllers 53
 - CompactLogix 5370 L3 controllers 80
- system overhead time slice** 280
 - configure 281
- system power consumption**
 - calculate
 - CompactLogix 5370 L1 controllers 166, 219
 - CompactLogix 5370 L3 controllers 243 ... 245

T

- tag**
 - in project 269
- task**
 - continuous 264
 - event 168 ... 171, 264
 - in project 262
 - periodic 264
 - priority 265
- time slice** 280

U

- unscheduled**
 - program 267
- USB cable**
 - CompactLogix 5370 L1 controllers 42
 - CompactLogix 5370 L2 controllers 65
 - CompactLogix 5370 L3 controllers 84

V

- validate I/O modules layout**
 - 1734 POINT I/O modules 162 ... 167
 - 1769 Compact I/O modules 217 ... 222, 240 ... 248

W

- wiring diagrams**
 - CompactLogix 5370 L1 controllers 152

Rockwell Automation Support

Use the following resources to access support information.

Technical Support Center	Knowledgebase Articles, How-to Videos, FAQs, Chat, User Forums, and Product Notification Updates.	https://rockwellautomation.custhelp.com/
Local Technical Support Phone Numbers	Locate the phone number for your country.	http://www.rockwellautomation.com/global/support/get-support-now.page
Direct Dial Codes	Find the Direct Dial Code for your product. Use the code to route your call directly to a technical support engineer.	http://www.rockwellautomation.com/global/support/direct-dial.page
Literature Library	Installation Instructions, Manuals, Brochures, and Technical Data.	http://www.rockwellautomation.com/global/literature-library/overview.page
Product Compatibility and Download Center (PCDC)	Get help determining how products interact, check features and capabilities, and find associated firmware.	http://www.rockwellautomation.com/global/support/pcdc.page

Documentation Feedback

Your comments will help us serve your documentation needs better. If you have any suggestions on how to improve this document, complete the How Are We Doing? form at http://literature.rockwellautomation.com/idc/groups/literature/documents/du/ra-du002_-en-e.pdf.

Rockwell Automation maintains current product environmental information on its website at <http://www.rockwellautomation.com/rockwellautomation/about-us/sustainability-ethics/product-environmental-compliance.page>.

Allen-Bradley, Armor, ArmorBlock, Compact I/O, CompactLogix, ControlFLASH, ControlLogix, DriveLogix, E3, FLEX I/O, FlexLogix, Kinetix, Logix5000, PanelConnect, PanelView, PLC-5, POINT I/O, POINTBus, PowerFlex, QuickView, Rockwell Automation, Rockwell Software, RSLinx, RSLogix 5000, RSNetWorx, SLC, SoftLogix, Stratix, Studio 5000, and Studio 5000 Logix Designer are trademarks of Rockwell Automation, Inc.

Trademarks not belonging to Rockwell Automation are property of their respective companies.

Rockwell Otomasyon Ticaret A.Ş., Kar Plaza İş Merkezi E Blok Kat:6 34752 İçerenköy, İstanbul, Tel: +90 (216) 5698400

www.rockwellautomation.com

Power, Control and Information Solutions Headquarters

Americas: Rockwell Automation, 1201 South Second Street, Milwaukee, WI 53204-2496 USA, Tel: (1) 414.382.2000, Fax: (1) 414.382.4444

Europe/Middle East/Africa: Rockwell Automation NV, Pegasus Park, De Kleetlaan 12a, 1831 Diegem, Belgium, Tel: (32) 2 663 0600, Fax: (32) 2 663 0640

Asia Pacific: Rockwell Automation, Level 14, Core F, Cyberport 3, 100 Cyberport Road, Hong Kong, Tel: (852) 2887 4788, Fax: (852) 2508 1846

Publication 1769-UM021I-EN-P - May 2018

Supersedes Publication 1769-UM021H-EN-P - November 2016

Copyright © 2018 Rockwell Automation, Inc. All rights reserved. Printed in the U.S.A.