

ALTERNATING STEP CROSS-OVER LADDER - COLA-3-56-56

APPROX WEIGHT: 351.97 lbs.
DOES NOT INCLUDE WEIGHT OF POWER OR PACKAGING!!!

*** ANY ADDITIONS, DELETIONS, OR OMISSIONS MUST BE CORRECTED ON THIS DRAWING AS THIS DRAWING WILL BE CONSIDERED ALL INCLUSIVE ***

ALL GRAPHICS PROVIDED ARE FOR REFERENCE ONLY. IF CERTAIN DIMENSIONS ARE CRITICAL PLEASE VERIFY THOSE DIMENSIONS WITH YOUR SALESPERSON

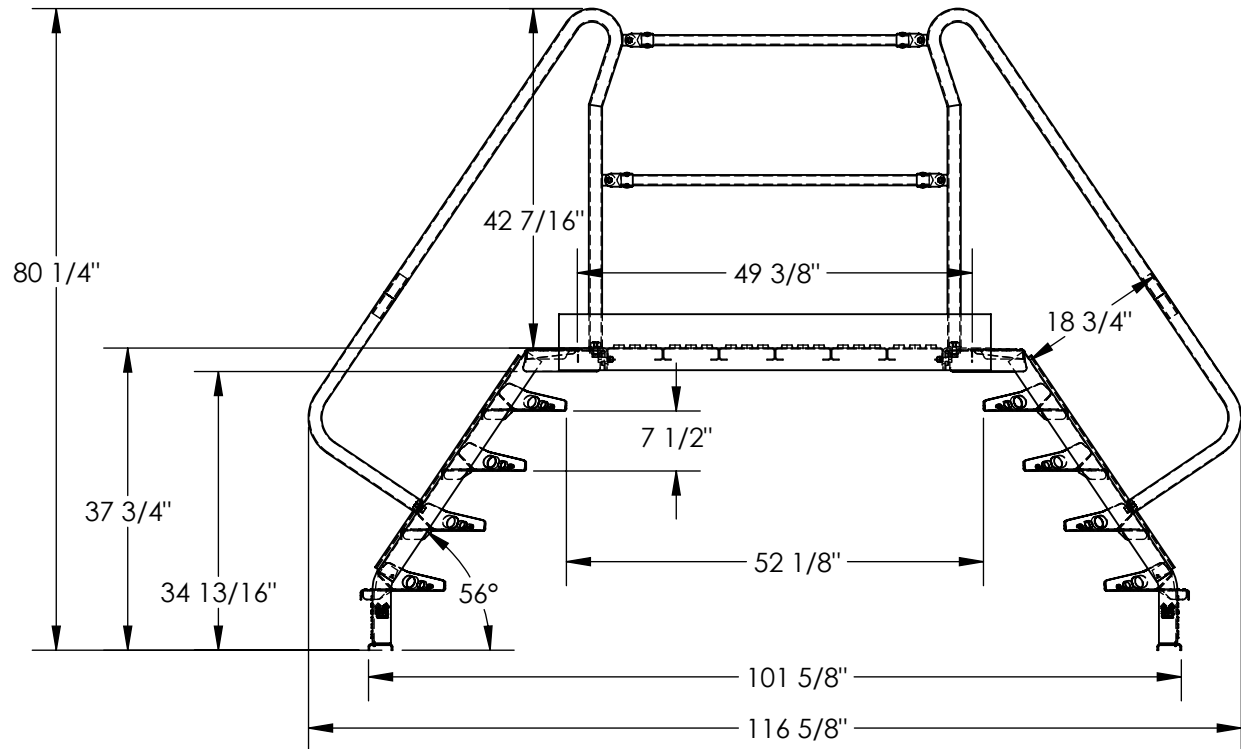
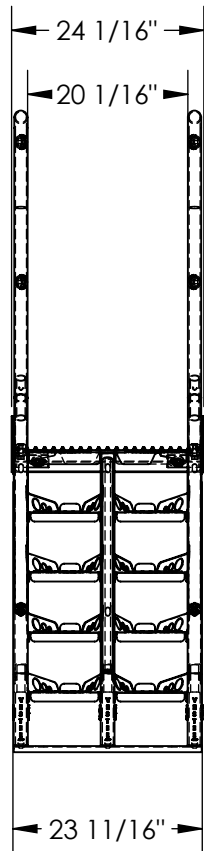

DIMENSION TOLERANCE $\pm 1/4$ "

STANDARD FEATURES

- MODEL NUMBER IS COLA-3-56-56
- OVERALL WIDTH IS 24 1/16"
- OVERALL LENGTH IS 116 5/8"
- OVERALL HEIGHT IS 80 1/4"
- MAX CAPACITY IS 350 LBS
- PLATFORM HEIGHT IS 37 3/4"
- PLATFORM WIDTH IS 23 11/16"
- USABLE PLATFORM WIDTH IS 20 1/16"
- PLATFORM LENGTH IS 49 3/8"
- STEP HEIGHT SPACING IS 7 1/2"
- CLIMB ANGLE IS 56°
- CLEARANCE WIDTH IS 52 1/8"
- CLEARANCE HEIGHT IS 34 13/16"
- KNOCK-DOWN DESIGN
(UNIT SHIPS KNOCKED-DOWN, ASSEMBLY REQUIRED)
- UNIT MUST BE ANCHORED TO THE FLOOR!
(ANCHORING HARDWARE NOT INCLUDED)
- TOUGH BAKED IN POWDER COATED YELLOW FINISH

SPECIAL FEATURES

NONE

APPROVAL	I, THE UNDERSIGNED, AGREE THAT THE PRODUCT AS REPRESENTED SATISFIES DESIGN AND DIMENSION REQUIREMENTS. I ALSO ACKNOWLEDGE MY DUTY TO CONFIRM PRODUCT AND INSTALLATION COMPLIANCE WITH ALL APPLICABLE FEDERAL, STATE AND LOCAL REGULATIONS AND STANDARDS.	
	ANY MODIFIED UNITS ARE NON-RETURNABLE	
	[] As drawn [] As marked	
Signed: _____		Date: _____
Printed Name: _____		
LEAD TIME WILL START UPON RECEIPT OF SIGNED APPROVAL DRAWING		

FOR INTERNAL USE ONLY PROJECT SIGN OFF	
SALES	
ENG.	
FAB.	
POWER	

DISTRIBUTOR'S NAME:		P.O.#
VESTIL MANUFACTURING		X
DRAWN BY: KGH		W.O.#
DATE: 1/11/2017		X
REFERENCE: X	SCALE: 1:24	SALES: X
QUOTED LEAD TIME: X	QUOTE #	FILE NAME:
	X	44-007-637