

DOUBLE SIDED STEP LADDER, PORTABLE, 4-STEP, PERFORATED- LAD-DD-P-32-4-P

APPROX WEIGHT: 129.54 lbs.
 DOES NOT INCLUDE WEIGHT OF POWER OR PACKAGING!!!

*** ANY ADDITIONS, DELETIONS, OR OMISSIONS MUST BE CORRECTED ON THIS DRAWING AS THIS DRAWING WILL BE CONSIDERED ALL INCLUSIVE ***
 ALL GRAPHICS PROVIDED ARE FOR REFERENCE ONLY. IF CERTAIN DIMENSIONS ARE CRITICAL PLEASE VERIFY THOSE DIMENSIONS WITH YOUR SALESPERSON

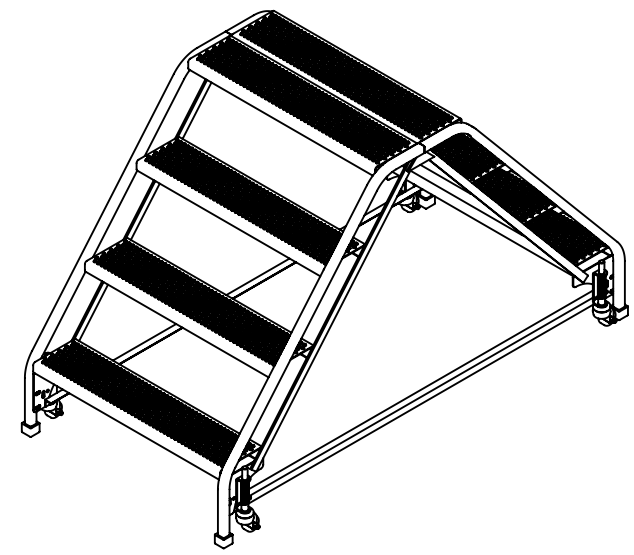
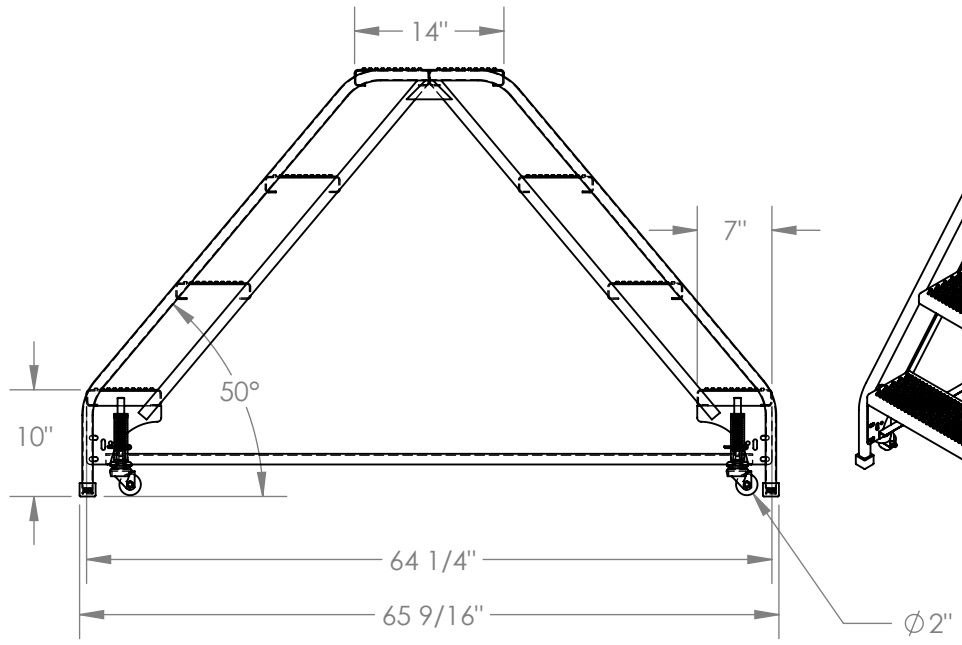
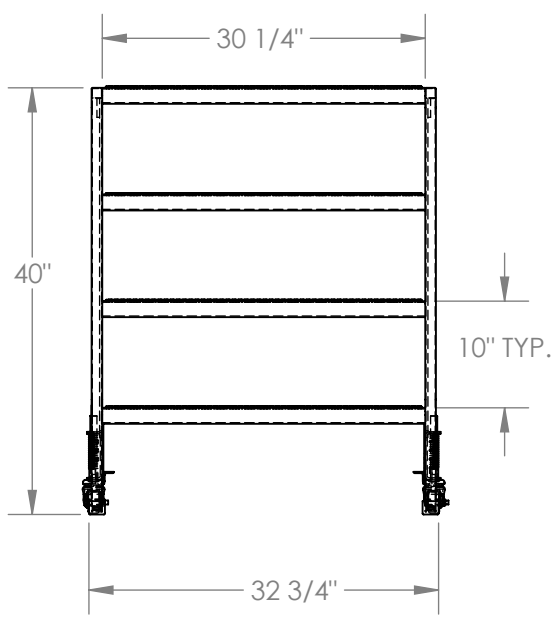

STANDARD FEATURES

- MODEL NUMBER IS LAD-DD-P-32-4-P
- OVERALL WIDTH IS 32 3/4"
- USABLE WIDTH IS 30 1/4"
- OVERALL LENGTH IS 65 9/16"
- USABLE LENGTH IS 64 1/4"
- OVERALL HEIGHT IS 40"
- STEP DEPTH IS 7"
- TOP PLATFORM DEPTH IS 14"
- ANGLE OF INCLINE IS 50°
- STEP STYLE IS PERFORATED
- COLOR IS VESTIL YELLOW
- MAX CAPACITY IS 350 LBS
- WHEEL SIZE IS Ø 2"

NOTE

NONE

SPECIAL FEATURES

NONE

DIMENSION TOLERANCE ± 1/4"

APPROVAL

I, THE UNDERSIGNED, AGREE THAT THE PRODUCT AS REPRESENTED SATISFIES DESIGN AND DIMENSION REQUIREMENTS. I ALSO ACKNOWLEDGE MY DUTY TO CONFIRM PRODUCT AND INSTALLATION COMPLIANCE WITH ALL APPLICABLE FEDERAL, STATE AND LOCAL REGULATIONS AND STANDARDS.

ALL SPECIAL UNITS ARE NON-RETURNABLE
 As drawn As marked

Signed: _____ Date: _____

LEAD TIME WILL START UPON RECEIPT OF SIGNED APPROVAL DRAWING

FOR INTERNAL USE ONLY PROJECT SIGN OFF	
SALES	
ENG.	
FAB.	
POWER	

DISTRIBUTOR'S NAME:		P.O.#
VESTIL MANUFACTURING		X
DRAWN BY:	DATE:	W.O.#
B.NOETHNAGEL	08/27/2014	X
REFERENCE:	SCALE:	SALES:
X	1:18	X
QUOTED LEAD TIME:	QUOTE #	FILE NAME:
X	X	44-007-542