

ENERPAC®

POWERFUL SOLUTIONS. GLOBAL FORCE.



US

E 3 2 7

INDUSTRIAL TOOLS

Table of Contents

Introduction

The World of Enerpac 2-3

Cylinders (Hydraulic) 4-55

Introduction 4-5
RC-DUO Series, Single-Acting Cylinders 6-9
RC-DUO Series, Cylinder Accessories 10
RA-Series,
Aluminum Cylinders Introduction 11
RAC-Series,
Single-Acting Aluminum Cylinders 12-13
RACL-Series, Single-Acting
Aluminum Lock-nut Cylinders 14-15
RACH-Series, Single-Acting
Aluminum Hollow Cylinders 16-17
RAR-Series, Double-Acting
Aluminum Cylinders 18-19
CLP-Series, Single-acting
Pancake Cylinders 20-21
RSM/RCS-Series, Single-Acting
Low Height Cylinders 22-23
BRC-Series, Single-Acting
Pull Cylinders 24-25
BRP-Series, Single-Acting
Pull Cylinders 24-25
RCH-Series, Single-Acting
Hollow Plunger Cylinders 26-27
RRH-Series, Double-Acting
Hollow Plunger Cylinders 28-29
RD-Series, Double-Acting
Precision Cylinders 30-31
RR-Series, Double-Acting
Cylinders 32-35
CLSG-Series, Single-Acting
High Tonnage Cylinders 36-39
CLRG-Series, Double-Acting
High Tonnage Cylinders 40-43
CLL-Series, Single-Acting
Lock Nut Cylinders 44-47
JH/JHA-Series, Aluminum
and Steel Jacks 48
GBJ-Series, Industrial Bottle Jacks 49
PR-Series, Pow'R Riser® 50-51
RC, P, V-Series,
Extreme Environment Products 52-53
SC-Series, Cylinder-Pump Sets 54-55

Pumps and Directional Control Valves 56-111

Introduction 56-57
P-Series, Lightweight Hand Pumps 58-59
P-Series, ULTIMA Steel Hand Pumps 60-61
P-Series, Low Pressure Hand Pumps 62-63
P-Series, Lightweight Foot Pump 64
MP-Series, Multifluid Hand Pumps 65
P- and 11-Series, Ultra-High
Pressure Hand Pumps 66-67
XC-Series, Cordless Pump 68-69
PU-Series Economy Pumps 70-71
PE-Series,
Submerged Electric Pumps 72-75
Z-Class Electric Pump Intro 76-77
ZU-Series, Electric Pumps 78-83
ZE-Series, Electric Pumps 84-89
8000-Series, Electric Pumps 90-91
ZA-Series, Air Hydraulic Pumps 92-93
XA-Series Air Pumps 94-95
PA-Series, Turbo II Air Pumps 96-97
PA and PAM-Series,
Air Hydraulic Pumps 98-99
ZG-Series Gasoline Powered Pumps 100-101
PGM-Series, Atlas Gasoline Powered Pumps 102
8000-Series, Gasoline Powered Pumps 103

Pump Mounted Directional Control Valves 104-111

Introduction 104-105
VM, VE-Series, Pump-Mounted
Valves 106-107, 110-111
VC-Series, Remote Mounted Valves 108
Valve Dimensions 109

System Components and Control Valves 112-129

Introduction 112-113
High-Pressure Hoses 114-115
Hydraulic Couplers 116-117
Hydraulic Oil,
Manifolds and Fittings 118-119
GF and GP-Series, Hydraulic Force
and Pressure Gauges 120-121
G and H-Series,
Hydraulic Pressure Gauges 122-123
T-Series, Test System Gauges 124
DGR-Series, Digital Hydraulic Gauges 125
Gauge Adapter Assembly 126
GA, NV, V Gauge Accessories 127
Flow and Pressure Control Valves 128-129

Hydraulic Presses 130-143

Introduction 130-131
IP-Series, H-Frame Presses 132-135
IPR-Series, Roll Frame Presses 136-137
A-Series Arbor, C-Clamps and IP-Series
Bench Frame Presses 138-139
Press Accessories 140
Press Speed Chart 140
Custom Built Presses 141
TM, LH Tension Meter and Load Cells 142
Press Application Ideas 143

Pullers (Mechanical and Hydraulic) 144-157

Introduction 144-145
BHP-Series, Hydraulic Puller Sets 146-149
EP and EPPMI-Series,
Mechanical Posi-Lock® Pullers 150-153
EPH-Series,
Hydraulic Posi-Lock® Pullers 154-155
Posi-Lock® Puller Accessories 156
EPH-Series,
Posi-Lock® 100-Ton Pullers 157

Tools (Mechanical and Hydraulic) 158-177

Introduction 158-159
MS-Series, Maintenance Sets 160-163
SP-Series,
35-Ton Hydraulic Punch 164-165
SP-Series,
50-Ton Hydraulic Punch 166-167
LW-Series, Vertical Lifting Wedge 168
SOH-Series, Hydraulic Machine Lifts 169
ER, ES and ELP-Series,
Heavy-Duty Load Skates 170-171
CM-Series, Storage Cases 172
A, WR-Series,
Wedgies and Spread Cylinders 173
WHC and WHR-Series,
Hydraulic Cutter Heads 174
WMC-Series,
Self-Contained Hydraulic Cutters 175
STB-Series, Pipe Benders 176-177

Bolting Tools 178-227

Introduction 178-179
E-Series, Manual Torque Multipliers 180-181
S-Series, Square Drive Steel
Torque Wrenches 182-185
BSH-Series Sockets 186
Bolting Application Ideas 187
W-Series, Low Profile Hexagon
Wrenches 188-189
W-Series Hexagon Cassettes 190-197
WCR-Series Roller Cassette Torque Wrench
. 198-199
W-Series Accessories 200
Bolting Application Ideas 201
Torque Wrench & Pump Selection Chart 202
PMU-Series, Portable Electric
Torque Wrench Pumps 203
ZU4 Electric Torque Wrench Pumps 204-207
TQ-700 Series, Electric Torque Wrench Pump
. 208-209
ZE-Series Torque Wrench Pumps 210-211
PTA-Series, Pneumatic
Torque Wrench Pumps 212-213
ZA4-Series, Air Driven
Torque Wrench Pumps 214-217
ZUTP-Series, Electric Tensioning Pump 218-219
ATP Ultra-Pressure Air Hydraulic Pump 220
NC-Series, Hydraulic Nut Splitters 221
NS-Series Hydraulic Nut Splitters 222-223
FS-Series, Hydraulic Flange Spreaders 224
FSM/FSH-Series Hydraulic and Mechanical
Industrial Spreaders 225
ATM-Series, Flange Alignment Tools 226
FF-Series, Mechanical Flange Face Tool 227

Integrated Solutions 228-240

Introduction 228-229
SL/SBL-Series Hydraulic Gantries 230
HSL-Series Strand Jacks 231
HSK-Series Skidding Systems 232
SPMU Self-propelled Modular Unit 233
EVO & SLCG Synchronized Lifting Systems 234
Custom Solutions 235-236
Uni-Lift® Mechanical Actuators 237-240

Yellow Pages (Information Section) 241-257

Warranty Statement,
Introduction and Standards 241
Safety Instructions 242-243
Cylinder-Pump Matching
and Selection 244
Hydraulic Work Sheet 245
Basic Hydraulic System Set-ups 246-247
Basic Hydraulics 248-249
Conversion Tables 250
Cylinder Speed Charts 251
Valve Information 252
Bolting Guide 253-254
About Enerpac 255
Enerpac Worldwide Locations 256

All information in this catalog can be changed due to product improvements without prior notice.

© Copyright 2014, Actuant Corp. All rights reserved. Any copying or other use of material in this catalog (text, illustrations, drawings, photos) without express written consent is prohibited.

Model Number Index

Section Index

Page(s) ▼ Page(s) ▼ Page(s) ▼ Page(s) ▼

A
A 116-118, 138-139, 138-139, 140, 173
A5-A10 162
A12 10
A13-A28 162
A29-A53 10
A64-A66 118
A92 162, 173
A102 10, 33
A128-A192 162-163
A185 163
A200R 140
A205-A220 138
A218 162
A242-A305 162
A252 10, 33
A258 138
A310, A330 138
A530-A595 162-163
A604 116-117
A607 163
A630 116-117
A650 163
AD 31, 140
AH 116-117
AM 118
AR 116-117
ATM 226
ATP 220
AW 10

B
B 237-238
BHP 146-149
BRC 24-25
BRP 24-25
BSH 186
BZ 177

C
C 116-117
CAT 10, 23, 33, 47
CATG 13, 15
..... 19, 39, 43
CD 117
CH 117
CLL 44-47
CLP 20-21
CLRG 40-43
CLSG 36-39
CM 172
CR 116-117
CT 117
CW 146

D
DGR 125

E
E 180-181
EGM 103
ELP 170-171

EMB 170
EP 150-153
EPH 154-157
EPP 150-153
EPT 154
EPX 153
ER 170-171
ES 170-171
EVO 234

F
F 116-117
FF 227
FH 116-117
FR 116-117
FS 224
FSB 225
FSH 225
FSM 225
FZ 119

G
G 122-123
GA 126-127
GBJ 49
GF 120-121
GP 120-121

H
H 115, 122-123
HA 115
HB 115
HC 115
HF 118
HP 27, 29
HSK 232
HSL 231

I
IP 132-135,
..... 138-139, 140-141
IPL 140
IPR 136-137

J
JBI 10
JH 48
JHA 48

L
LH 142
LW 168
LX 118

M
M 237-238
MP 65
MS 160-163
MSP 164-165
MTW 180
MZ 162-163

N
NC 221
NCB 221
NS 222-223
NV 127

P
P 52-53, 58-67
P392AL 59
P392FP 64
PA 98
PAM 99
PAMG 96-97
PATG 96-97
PARG 96-97
PC 60
PE 72-75, 90-91
PEM 90-91
PER 90-91
PGM 102
PK 140
PMB 140
PMU 203
PR 50-51
PTA 212-213
PU 70-71

R
RA 11
RAC 12-13
RACH 16-17
RACL 14-15
RAR 18-19
RB 10
RC 6-10, 52-53
RCH 26-27
RCS 22-23
RD 30-31
REB 10
REP 10
RFL 95
RR 32-35
RRH 28-29
RSM 22-23
RTE 185
RWH 146-147

S
S 182-185
SB 82, 88, 207,
..... 217, 225
SBL 230
SC 54-55
SCH 54-55
SCL 54-55
SCP 54-55
SCR 54-55
SDA 184
SL 230
SLCG 234
SOH 169
SP 164-167
SPD 164-165

SPK 164
SPMU 233
SRS 185
STB 176-177
STC 174
STF 225
STN 221
STP 165
SW 225

T
T 124
THC 206, 212, 214
THQ 206, 212, 214
TM 142
TQ 208-209
TSP 185, 200

V
V 52-53, 127,
..... 128-129
VA2 99
VC 108-109
VE 106-111
VM 106-109

W
W 188-196
WCB 174-175
WCR 198-199
WHC 174
WHR 174
WMC 175
WR 163, 173
WRP 200
WTE 200

X
XA 94-95
XC 68-69

Z
Z 117
ZA 92-93
ZA4T 204, 214-217
ZC 82, 88-89
ZE 77, 84-89
ZE 210-211
ZG 100-101
ZH 83, 89, 207
ZL 83, 88
ZP 82-83, 88-89
ZR 82-83, 88, 207,
..... 217
ZU 78-83
ZU4T 204-207
ZUTP 218-219
ZTM 207, 217

11 66-67
41 67
43 67, 124
45 67
83 66-67



Cylinders and Lifting Products
Page 4-55



Pumps & Directional Control Valves
Page 56-111



System Components & Control Valves
Page 112-129



Presses
Page 130-143



Pullers
Page 144-157



Tools
Page 158-177



Bolting Tools
Page 178-227



Integrated Solutions
Page 228-240

The World

A complete range of quality high force tools for all industrial applications, with local availability and after sale service anywhere in the world.... this is what has made Enerpac the undisputed global market leader in high pressure hydraulics.

Across every continent, Enerpac's network of authorized distributors and service centers can reach even the most remote locations, supplying and servicing products that are designed to enhance productivity and performance, while making the workplace safer.

With over 150 sales specialists and a network of service and engineering support in 17 countries across the globe, Enerpac has become the product of choice in industries such as manufacturing, construction, energy, oil & gas, shipbuilding, railroads, mining, and metals transformation.

Always at the leading edge of technology, Enerpac has continued to develop its range of time and cost-savings tools, utilizing modern engineered materials to improve productivity and minimize operator fatigue.

Enerpac's commitment to the continued development of quality high force tools ensures that the products you purchase are the best tools in the industry. We will continue to lead the way in the development of quality high force tools for all industrial applications.



Class Brand

10 Reasons to Work with Enerpac

- Expert Design
- Highly Reliable
- Service Excellence
- Worldwide Experience
- Application Support
- Availability
- Quality
- Value
- Innovative Products
- Systems Solutions



Total Quality

Our products are tested to the most exacting standards. These high standards guarantee the quality, price and performance requirements of the markets we serve around the globe.

Global Network

Enerpac has an extensive network of authorized distributors and service centers located in more than 90 countries worldwide. You can rely on Enerpac for the products and technical support you need to get your job done, anywhere in the world.

Logistics Excellence

Enerpac's mission is to maintain service excellence in the ever-changing world of modern distribution. Providing our extensive range of products to our thousands of distributors worldwide demands a logistic expertise only a market leader can provide.



A Tradition of Innovation

Enerpac has a long history of finding new solutions to better meet the challenges of the industries we serve. We were the first to develop a composite hand pump and the first to offer a computerized lifting system. Our latest innovations include the XA-Series of air driven foot pumps, designed for less operator fatigue - with the unique XVARI® technology, delivering variable oil flow and fine metering for precise control, a full range of aluminum cylinders with the strength of steel and the advantages of aluminum and the Z-Class series of power pumps... pumps that were designed to run cooler, use less electricity and are easy to service.

To support the demands of the construction industry, Enerpac continues to develop Integrated Solutions capabilities. These capabilities include controlled hydraulic movement for your most challenging applications.

ENERPAC 
POWERFUL SOLUTIONS. GLOBAL FORCE.

ENERPAC hydraulic cylinders are available in hundreds of different configurations. Whatever the industrial application... lifting, pushing, pulling, bending, holding... whatever the force capacity, stroke length, or size restrictions... single- or double-acting, solid or hollow plunger, you can be sure that Enerpac has the cylinder to suit your high force application. Enerpac jacking cylinders fully comply to ASME B30.1 (except RD-Series).



GR2 Bearing Technology

The exclusive GR2 is a unique bearing design on RC-Series DUO cylinders which absorbs eccentric load stresses to protect your cylinder against abrasion, over-extending or plunger blow-outs and jamming or top-end mushrooming. As a result, RC-Series DUO cylinders provide long, trouble-free operation.

Easy assembly and disassembly using only standard shop tools.

Heavy-duty, pre-tensioned spring improves retraction rate for enhanced productivity.

Unique GR2 Bearing System surrounds the seal of longer stroke models resulting in improved side-load resistance and extended operating life.



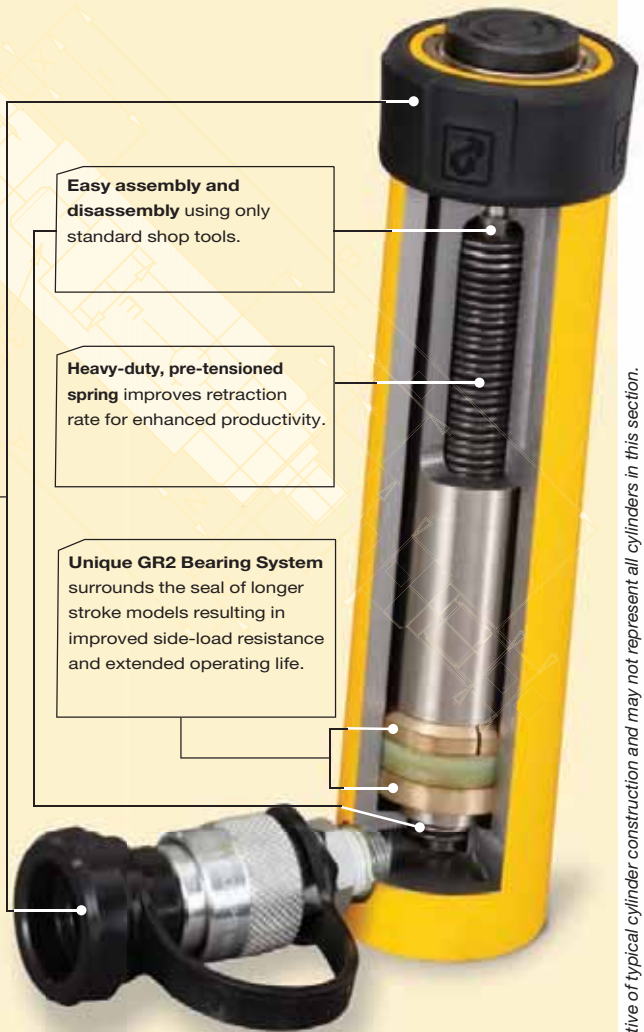





















Additional shape and texture to the **cylinder thread protector** and pliable plug-in/pop-off coupler cap for easy operation with gloved and oily hands.



Note: The cut-away drawing is representative of typical cylinder construction and may not represent all cylinders in this section.



Cylinder & Lifting Products Section Overview

* Capacity (tons)	Stroke Range (in)	Cylinder Type and Functions	Series		Page
5-100	.63-14.25	General Purpose Cylinders, Single-acting Cylinder Accessories 	RC-DUO		6 ▶ 10 ▶
20-150	1.97-9.84	Aluminum Cylinders Single-Acting, Solid Plunger, Lock Nut, Hollow Plunger 	RAC RACL RACH		12 ▶ 14 ▶ 16 ▶
20-150	1.97-9.84	Aluminum Cylinders Double-Acting Solid Plunger 	RAR		18 ▶
5-500	.25-2.44	Pancake and Low Height Cylinders, Single-Acting 	CLP RSM RCS		20 ▶ 22 ▶ 23 ▶
2.5-60	5.00-6.00	Pull Cylinders, Single-Acting 	BRC BRP		24 ▶
12-150	.31-10.13	Hollow Plunger Cylinders Single- and Double-Acting 	RCH RRH		26 ▶ 28 ▶
4-25	1.13-10.25	Precision Production Cylinders, Double-Acting 	RD		30 ▶
10-500	2.25-48.00	Long Stroke Cylinders, Double-Acting 	RR		32 ▶
50-1000	1.97-11.81	High Tonnage Cylinders Single-Acting (S/A), S/A with Mechanical Locknut, Double-Acting 	CLSG CLRG CLL		36 ▶ 40 ▶ 44 ▶
7-150 2-100	3.00-6.13 3.94-18.11	Aluminum and Steel Jacks Industrial Bottle Jack 	JHA/JH GBJ		48 ▶ 49 ▶
60-200	14.0-27.0	POW'R-RISER® Lifting Jack	PR		50 ▶
5-25	2.0-6.0	Extreme Environment Products (Valves, cylinders, hand pumps) 	RC P V		52 ▶
5-100	1.50-14.25	Cylinder - Pump Sets (Single-Acting) 	SC		54 ▶

* All cylinder capacities are nominal values, unless otherwise stated. [Maximum] capacities are theoretical and may vary, depending on cylinder condition and application.

▼ Shown from left to right: RC-506, RC-50, RC-2510, RC-154, RC-10010, RC-55, RC-1010



- Unique GR2 Bearing Design, reduces wear, extending life
- Collar threads, plunger threads and base mounting holes enable easy fixturing (on most models)
- Designed for use in all positions
- High strength alloy steel for durability
- Redesigned cylinder thread protector for ease of use
- Heavy-duty, pretensioned spring improves retraction speed
- Baked enamel finish for increased corrosion resistance
- CR-400 coupler and dust cap included on all models
- Plunger wiper reduces contamination, extending cylinder life

▼ Stage lifting set up in Greece, where assembled pipes, 82 feet in length, were stage lifted with six RC-2514 cylinders.



The Industry Standard General Purpose Cylinder



Saddles

All RC cylinders are equipped with hardened removable grooved saddles. For tilt and flat saddles, see the RC-Series accessory page.

Page: 10



Base Plates

To ensure the stability of cylinders for lifting applications, base plates are available for 10, 25 and 50 ton RC cylinders.

Page: 10



Specialty Attachments

For solving all kinds of application problems, specialty attachments are available for 5, 10 and 25 ton RC cylinders.

Page: 162

▼ RC cylinder mounting attachments greatly extend the application possibilities (available for 5, 10, 15 and 25 ton cylinders).



Single-Acting, General Purpose Cylinders



GR2 Bearing Technology

The exclusive GR2 is a unique bearing design on RC-Series DUO cylinders which absorbs eccentric load stresses to protect your cylinder against abrasion, over-extending or plunger blow-outs and jamming or top-end mushrooming. As a result, RC-Series DUO cylinders provide long, trouble-free operation.

▼ QUICK SELECTION CHART

For complete technical information see next page.

Cylinder Capacity	Stroke	Model Number	Cylinder Effective Area	Oil Capacity	Collapsed Height	Weight
tons (maximum)	(in)		(in ²)	(in ³)	(in)	(lbs)
5 (4.9)	.63	RC-50**	.99	.62	1.63	2.2
	1.00	RC-51	.99	.99	4.34	2.3
	3.00	RC-53	.99	2.98	6.50	3.3
	5.00	RC-55*	.99	4.97	8.50	4.1
	7.00	RC-57	.99	6.96	10.75	5.3
	9.13	RC-59	.99	9.07	12.75	6.1
10 (11.2)	1.00	RC-101	2.24	2.24	3.53	4.0
	2.13	RC-102*	2.24	4.75	4.78	5.1
	4.13	RC-104	2.24	9.23	6.75	7.2
	6.13	RC-106*	2.24	13.70	9.75	9.8
	8.00	RC-108	2.24	17.89	11.75	12.0
	10.13	RC-1010*	2.24	22.65	13.75	14.0
	12.00	RC-1012	2.24	26.84	15.75	15.0
	14.00	RC-1014	2.24	31.31	17.75	18.0
15 (15.7)	1.00	RC-151	3.14	3.14	4.88	7.2
	2.00	RC-152	3.14	6.28	5.88	9.0
	4.00	RC-154*	3.14	12.57	7.88	11.0
	6.00	RC-156*	3.14	18.85	10.69	15.0
	8.00	RC-158	3.14	25.13	12.69	18.0
	10.00	RC-1510	3.14	31.42	14.69	21.0
	12.00	RC-1512	3.14	37.70	16.69	24.0
	14.00	RC-1514	3.14	43.98	18.69	26.0
25 (25.8)	1.00	RC-251	5.16	5.16	5.50	13.0
	2.00	RC-252*	5.16	10.31	6.50	14.0
	4.00	RC-254*	5.16	20.63	8.50	18.0
	6.25	RC-256*	5.16	32.23	10.75	22.0
	8.25	RC-258	5.16	42.55	12.75	27.0
	10.25	RC-2510	5.16	52.86	14.75	31.0
	12.25	RC-2512	5.16	63.18	16.75	36.0
	14.25	RC-2514*	5.16	73.49	18.75	39.0
30 (32.4)	8.25	RC-308	6.49	53.56	15.25	40.0
50 (55.2)	2.00	RC-502	11.04	22.09	6.94	33.0
	4.00	RC-504	11.04	44.18	8.94	42.0
	6.25	RC-506*	11.04	69.03	11.13	51.0
	13.25	RC-5013	11.04	146.34	18.13	83.0
75 (79.5)	6.13	RC-756	15.90	97.41	11.25	65.0
	13.13	RC-7513	15.90	208.74	19.38	130.0
100 (103.1)	6.63	RC-1006	20.63	136.67	14.06	130.0
	10.25	RC-10010	20.63	211.45	17.69	160.0

* Available as a set. See note on this page.

** RC-50 cylinder has non-removable grooved saddle and no collar thread.

RC Series



Capacity:

5-100 tons

Stroke:

.63-14.25 inches

Maximum Operating Pressure:

10,000 psi



Think Safety
Manufacturer's rating of load and stroke are maximum safe limits.

Good practice encourages using only 80% of these ratings!

Page: 242



RAC-Series, Single-Acting Cylinders

The lightweight general purpose spring return aluminum cylinders.

Page: 12



RC-Series DUO Cylinders

maintain external dimensions for use with existing fixtures.



Gauges

Minimize the risk of overloading and ensure long, dependable service from your equipment. Refer to

the System Components section for a full range of gauges.

Page: 113

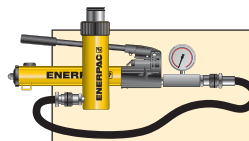

Pump and Cylinder Sets

All cylinders marked with an * are available as sets (cylinder, gauge, couplers, hose and pump) for your ordering convenience.

Page: 54

RC-Series DUO Cylinders, Single-Acting



Speed Chart

See the Enerpac Cylinder Speed Chart in our "Yellow Pages" to determine your approximate cylinder speed.

Page: 251

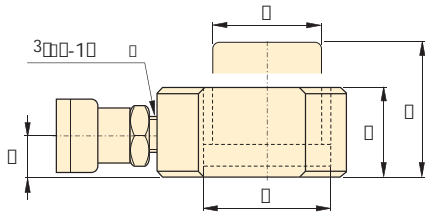
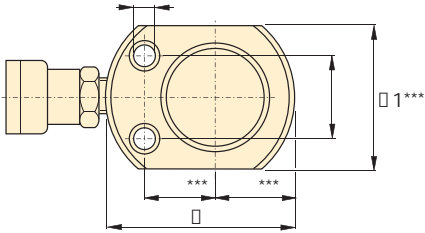

RC-50

RC-101 only
(U1 = .75 inch)

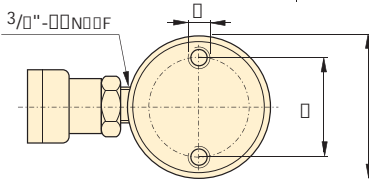
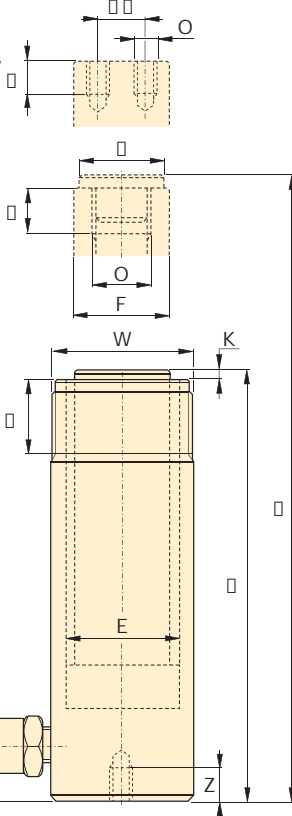

RC-51 to RC-5013 models

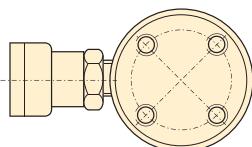

RC-1006 and RC-10010 models

◀ For full features see page 6.

Cylinder Capacity	Stroke	Model Number	Cylinder Effective Area	Oil Capacity	Collapsed Height	Extended Height	Outside Diameter
tons (maximum)	(in)		(in ²)	(in ³)	A (in)	B (in)	D (in)
5 (4.9)	.63	RC-50**	.99	.62	1.63	2.25	2.31
	1.00	RC-51	.99	.99	4.34	5.34	1.50
	3.00	RC-53	.99	2.98	6.50	9.50	1.50
	5.00	RC-55*	.99	4.97	8.50	13.50	1.50
	7.00	RC-57	.99	6.96	10.75	17.75	1.50
	9.13	RC-59	.99	9.07	12.75	21.88	1.50
10 (11.2)	1.00	RC-101	2.24	2.24	3.53	4.53	2.25
	2.13	RC-102*	2.24	4.75	4.78	6.91	2.25
	4.13	RC-104	2.24	9.23	6.75	10.88	2.25
	6.13	RC-106*	2.24	13.70	9.75	15.88	2.25
	8.00	RC-108	2.24	17.89	11.75	19.75	2.25
	10.13	RC-1010*	2.24	22.65	13.75	23.88	2.25
	12.00	RC-1012	2.24	26.84	15.75	27.75	2.25
	14.00	RC-1014	2.24	31.31	17.75	31.75	2.25
15 (15.7)	1.00	RC-151	3.14	3.14	4.88	5.88	2.75
	2.00	RC-152	3.14	6.28	5.88	7.88	2.75
	4.00	RC-154*	3.14	12.57	7.88	11.88	2.75
	6.00	RC-156*	3.14	18.85	10.69	16.69	2.75
	8.00	RC-158	3.14	25.13	12.69	20.69	2.75
	10.00	RC-1510	3.14	31.42	14.69	24.69	2.75
	12.00	RC-1512	3.14	37.70	16.69	28.69	2.75
	14.00	RC-1514	3.14	43.98	18.69	32.69	2.75
25 (25.8)	1.00	RC-251	5.16	5.16	5.50	6.50	3.38
	2.00	RC-252*	5.16	10.31	6.50	8.50	3.38
	4.00	RC-254*	5.16	20.63	8.50	12.50	3.38
	6.25	RC-256*	5.16	32.23	10.75	17.00	3.38
	8.25	RC-258	5.16	42.55	12.75	21.00	3.38
	10.25	RC-2510	5.16	52.86	14.75	25.00	3.38
	12.25	RC-2512	5.16	63.18	16.75	29.00	3.38
	14.25	RC-2514*	5.16	73.49	18.75	33.00	3.38
30 (32.4)	8.25	RC-308	6.51	53.56	15.25	23.50	4.00
50 (55.2)	2.00	RC-502	11.04	22.09	6.94	8.94	5.00
	4.00	RC-504	11.04	44.18	8.94	12.94	5.00
	6.25	RC-506*	11.04	69.03	11.13	17.38	5.00
	13.25	RC-5013	11.04	146.34	18.13	31.38	5.00
75 (79.5)	6.13	RC-756	15.90	97.41	11.25	17.38	5.75
	13.13	RC-7513	15.90	208.74	19.38	32.50	5.75
100 (103.1)	6.63	RC-1006	20.63	136.67	14.06	20.69	7.00
	10.25	RC-10010	20.63	211.45	17.69	27.94	7.00

* Available as a set. See page 54.

** RC-50 cylinder has non-removable grooved saddle and no collar thread.

*** D1 = 1.63 inch, L = .81 inch, M = 1.00 inch.

Single-Acting, General Purpose Cylinders

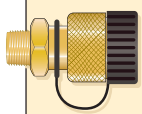

Couplers Included!
CR-400 couplers included on all models. Fits all HC-Series hoses.

Capacity:
5-100 tons

Stroke:
.63-14.25 inches





Maximum Operating Pressure:
10,000 psi

RC Series



Cylinder Bore Diam.	Plunger Diam.	Base to Adv. Port	Saddle Diam.	Saddle Protrusion from Plngr.	Plunger Internal Thread	Plunger Thread Length	Base Mounting Holes			Collar Thread	Collar Thread Length	Weight (lbs)	Model Number
							Bolt Circle U (in)	Thread V (in)	Thrd. Depth Z (in)				
E (in)	F (in)	H (in)	J (in)	K (in)	O (in)	P (in)	U (in)	V (in)	Z (in)	W (in)	X (in)		
1.13	1.00	.75	**	**	**	**	1.13	.22	—	—	—	2.2	RC-50**
1.13	1.00	.75	1.00	.25	3/4"-16	.56	1.00	1/4"-20UN	.56	1 1/2"-16	1.13	2.3	RC-51
1.13	1.00	.75	1.00	.25	3/4"-16	.56	1.00	1/4"-20UN	.56	1 1/2"-16	1.13	3.3	RC-53
1.13	1.00	.75	1.00	.25	3/4"-16	.56	1.00	1/4"-20UN	.56	1 1/2"-16	1.13	4.1	RC-55*
1.13	1.00	.75	1.00	.25	3/4"-16	.63	1.00	1/4"-20UN	.56	1 1/2"-16	1.13	5.3	RC-57
1.13	1.00	.75	1.00	.25	3/4"-16	.63	1.00	1/4"-20UN	.56	1 1/2"-16	1.13	6.1	RC-59
1.69	1.50	.75	—	—	#10-24UN	.25	1.56	5/16"-18UN	.50	2 1/4"-14	1.06	4.0	RC-101
1.69	1.50	.75	1.38	.25	1"-8	.75	1.56	5/16"-18UN	.50	2 1/4"-14	1.13	5.1	RC-102*
1.69	1.50	.75	1.38	.25	1"-8	.75	1.56	5/16"-18UN	.50	2 1/4"-14	1.06	7.2	RC-104
1.69	1.50	.75	1.38	.25	1"-8	.75	1.56	5/16"-18UN	.50	2 1/4"-14	1.13	9.8	RC-106*
1.69	1.50	.75	1.38	.25	1"-8	.75	1.56	5/16"-18UN	.50	2 1/4"-14	1.06	12	RC-108
1.69	1.50	.75	1.38	.25	1"-8	.75	1.56	5/16"-18UN	.50	2 1/4"-14	1.13	14	RC-1010*
1.69	1.50	.75	1.38	.25	1"-8	.75	1.56	5/16"-18UN	.50	2 1/4"-14	1.06	15	RC-1012
1.69	1.50	.75	1.38	.25	1"-8	.75	1.56	5/16"-18UN	.50	2 1/4"-14	1.06	18	RC-1014
2.00	1.63	.75	1.50	.38	1"-8	1.00	1.88	3/8"-16UN	.50	2 3/4"-16	1.19	7.2	RC-151
2.00	1.63	.75	1.50	.38	1"-8	1.00	1.88	3/8"-16UN	.50	2 3/4"-16	1.19	9	RC-152
2.00	1.63	.75	1.50	.38	1"-8	1.00	1.88	3/8"-16UN	.50	2 3/4"-16	1.19	11	RC-154*
2.00	1.63	1.00	1.50	.38	1"-8	1.00	1.88	3/8"-16UN	.50	2 3/4"-16	1.19	15	RC-156*
2.00	1.63	1.00	1.50	.38	1"-8	1.00	1.88	3/8"-16UN	.50	2 3/4"-16	1.19	18	RC-158
2.00	1.63	1.00	1.50	.38	1"-8	1.00	1.88	3/8"-16UN	.50	2 3/4"-16	1.19	21	RC-1510
2.00	1.63	1.00	1.50	.38	1"-8	1.00	1.88	3/8"-16UN	.50	2 3/4"-16	1.19	24	RC-1512
2.00	1.63	1.00	1.50	.38	1"-8	1.00	1.88	3/8"-16UN	.50	2 3/4"-16	1.19	26	RC-1514
2.56	2.25	1.00	2.00	.41	1 1/2"-16	1.00	2.31	1/2"-13UN	.75	3-12	1.94	13	RC-251
2.56	2.25	1.00	2.00	.41	1 1/2"-16	1.00	2.31	1/2"-13UN	.75	3 5/16"-12	1.94	14	RC-252*
2.56	2.25	1.00	2.00	.41	1 1/2"-16	1.00	2.31	1/2"-13UN	.75	3 5/16"-12	1.94	18	RC-254*
2.56	2.25	1.00	2.00	.41	1 1/2"-16	1.00	2.31	1/2"-13UN	.75	3 5/16"-12	1.94	22	RC-256*
2.56	2.25	1.00	2.00	.41	1 1/2"-16	1.00	2.31	1/2"-13UN	.75	3 5/16"-12	1.94	27	RC-258
2.56	2.25	1.00	2.00	.41	1 1/2"-16	1.00	2.31	1/2"-13UN	.75	3 5/16"-12	1.94	31	RC-2510
2.56	2.25	1.00	2.00	.41	1 1/2"-16	1.00	2.31	1/2"-13UN	.75	3 5/16"-12	1.94	36	RC-2512
2.56	2.25	1.00	2.00	.41	1 1/2"-16	1.00	2.31	1/2"-13UN	.75	3 5/16"-12	1.94	39	RC-2514*
2.88	2.25	2.25	2.00	.41	1 1/2"-16	1.00	—	—	—	3 5/16"-12	1.94	40	RC-308
3.75	3.13	1.31	2.81	.11	—	—	3.75	1/2"-13UN	.75	5"-12	2.19	33	RC-502
3.75	3.13	1.31	2.81	.11	—	—	3.75	1/2"-13UN	.75	5"-12	2.19	42	RC-504
3.75	3.13	1.38	2.81	.11	—	—	3.75	1/2"-13UN	.75	5"-12	2.19	51	RC-506*
3.75	3.13	1.38	2.81	.11	—	—	3.75	1/2"-13UN	.75	5"-12	2.19	83	RC-5013
4.50	3.75	1.19	2.81	.23	—	—	—	—	—	5 3/4"-12	1.75	65	RC-756
4.50	3.75	1.19	2.81	.23	—	—	—	—	—	5 3/4"-12	1.75	130	RC-7513
5.13	4.13	1.63	2.81	.11	—	—	5.50	3/4"-10UN	1.00	6 7/8"-12	1.75	130	RC-1006
5.13	4.13	1.63	2.81	.11	—	—	5.50	3/4"-10UN	1.00	6 7/8"-12	1.75	160	RC-10010

▼ SELECTION CHART

For Use with Cylinder Capacity (tons)	Saddles			Base Plate	Mounting Block	Clevis Eyes	
	Flat	Grooved ¹⁾	Tilt			Base ⁴⁾	Plunger
							
5	A-53F ²⁾	A-53G ²⁾	–	–	RB-5 ²⁾ , AW-51 ²⁾ , AW-53 ²⁾	REB-5 ²⁾	REP-5 ²⁾
10	A-12 ³⁾ , A-102F ³⁾	A-102G ³⁾	CAT-10 ³⁾	JB-10	RB-10, AW-102	REB-10	REP-10 ³⁾
15	–	A-152G	CAT-10	–	RB-15	REB-15	REP-10
25	A-29	A-252G	CAT-50	JB-25	RB-25	REB-25	REP-25
30	A-29	A-252G	CAT-50	–	RB-25	–	REP-25
50	–	–	CAT-100	JB-50	–	–	–
75	–	–	CAT-100	–	–	–	–
100	–	–	CAT-100	–	–	–	–

¹⁾ Standard on 5-30 ton RC-cylinders ²⁾ Except RC-50 ³⁾ Except RC-101 ⁴⁾ Mounting screws are included.

▼ DIMENSION CHARTS

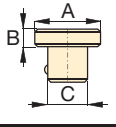
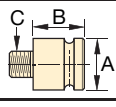
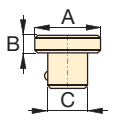
Model Number	Saddle Dimensions (in)			
	A	B	C	
Flat				
A-53F	1.00	.25	.68	
A-102F	1.38	.24	.88	
A-12	2.00	1.88	1"–8UNC	
A-29	2.00	1.88	1½"–16UN	
Grooved				
A-53G	1.00	.25	.68	
A-102G	1.38	.24	.88	
A-152G	1.50	.37	.88	
A-252G	1.97	.37	1.40	

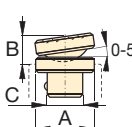
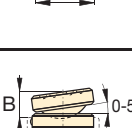
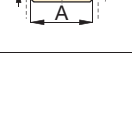
Model Number	Tilt Saddle Dimensions (in)			
	A	B	C	
Tilt				
CAT-10	1.38	.79	.88	
CAT-50	1.97	.83	1.40	
Tilt				
CAT-100	2.80	.98	–	

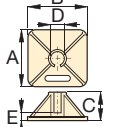
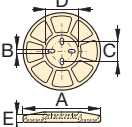
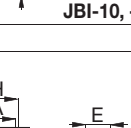
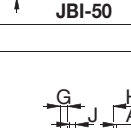
Model Number	Base Plate Dimensions (in)						
	A	B	C	D	E		
JB-10	9.00	9.00	5.34	2.29	.81		
JB-25	11.00	11.00	5.53	3.41	1.03		
JB-50	12.00	.60	3.75	5.19	1.25		

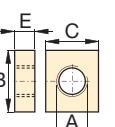
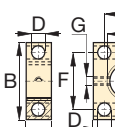
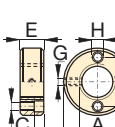
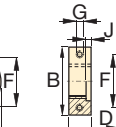
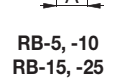
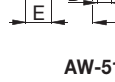
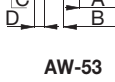
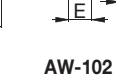
Model Number	Mounting Block Dimensions (in)											
	A	B	C	D	E	F	G	H				
RB-5	1½"–16	3.50	3.00	–	1.00	–	–	–				
AW-51	1½"–16	2.76	2.36	.43	.98	2.13	¼"–20	1.62				
AW-53	1½"–16	2.87	.28	.31	.75	2.25	¼"–20	.41				
RB-10	2¼"–14	4.50	3.50	–	1.00	–	–	–				
AW-102	2¼"–14	3.94	3.25	.63	1.18	3.00	7/16"–20	2.31				
RB-15	2¾"–16	4.00	4.50	–	1.50	–	–	–				
RB-25	3⅝"–12	5.00	6.50	–	2.00	–	–	–				

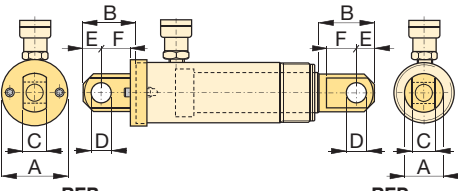
Type	Model Number	Clevis Eye Dimensions (in)						Pin to Pin* (in)	
		A	B	C	D	E	F		
Base ⁴⁾	REB-5	1.75	1.88	.56	.63	.63	1.00	2.37	
	REB-10	2.50	2.63	1.00	.88	1.00	1.38	3.07	
	REB-15	3.00	2.63	1.00	.88	1.00	1.38	3.07	
	REB-25	3.75	3.13	1.50	1.25	1.25	1.63	3.45	
Plunger	REP-5	1.13	1.75	.56	.63	.63	.75	–	
	REP-10	1.69	2.43	1.00	.88	1.00	1.13	–	
	REP-25	2.25	2.81	1.50	1.25	1.25	1.38	–	

* Pin to Pin– REB and REP Clevises fitted. Add cylinder collapsed height.

⁴⁾ Mounting screws are included.

The Enerpac Lightweight Aluminum Cylinders

▼ Shown: RAC, RACL, RACH, and RAR



RA Series

Capacity:
20-150 tons

Stroke:
1.97-9.84 inches

Maximum Operating Pressure:
10,000 psi



Think Safety
Manufacturer's rating of load and stroke are maximum safe limits.

Good practice encourages using only 80% of these ratings!

Page: 242

- Lightweight, easy to carry and position to allow a higher cylinder capacity-to-weight-ratio
- Non-corrosive by design, aluminum has always been a good material for use in many caustic environments
- Composite bearings on all moving surfaces guarantee **NO** metal-to-metal contact, to resist side loads and increase cylinder life



Aluminum vs. Steel

Aluminum cylinders, while offering the most lightweight solution also have some unique limitations due to material properties. It differs from steel in that it has a lower finite fatigue life. Aluminum cylinders should **NOT** be used in high-cycle applications such as production.

These cylinders are designed to provide 5000 cycles at their recommended pressure. **This limit should not be exceeded.** In normal lifting and many maintenance applications, this should provide a lifetime of use.

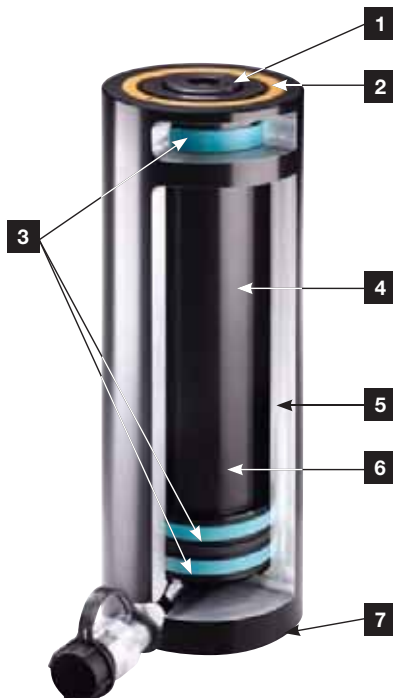

1. **Removable Hardened Saddle** protects plunger from being damaged by abrasive surface contact.
2. **Stop Ring** on all models absorbs eccentric loading and prevents plunger over-extension.
3. **Composite Bearing** material to prevent metal-to-metal contact, reducing side-load issues and increasing life.
4. **Hard-coated Plunger and Base** resist wear and prevent galling.
5. **7075-T6 Aluminum Alloy Components** for maximum strength and minimum weight.
6. **Plunger Return Spring** on all single-acting models for prompt cylinder return.
7. **Standard Steel Base Plate** protects cylinder base from abrasive surfaces.

▼ Shown from left to right: RAC-508, RAC-1506, RAC-304, and RAC-206



Lightweight for Maximum Portability



Saddles

All RAC cylinders are equipped with bolt-on removable saddles of hardened steel.



Lightweight Hand Pumps

Enerpac hand pumps **P-392** or **P-802** make the optimal lightweight set.

Page: **58**

- Composite bearings prevent metal-to-metal contact, increasing cylinder life and resistance to side-loads of up to 10%
- Hard coat finish on all surfaces resists damage and extends cylinder life
- Handles included on all models
- Steel baseplate and saddle for protection against load-induced damage
- Integral stop ring prevents plunger over-travel and is capable of withstanding the full cylinder capacity
- High-strength return spring for rapid cylinder retraction
- CR-400 coupler and dustcap included on all models
- All cylinders meet ASME B-30.1 and ISO 10100 standards



◀ Enerpac lightweight aluminum RAC-506 cylinders are ideal for wet environments such as this tunnel under the river (Holland High-Speed Train Line).

Cylinder Capacity	Stroke*	Model Number	Cylinder Effective Area
tons (maximum)	(in)		(in ²)
20 (24.2)	1.97	RAC-202	4.83
	3.94	RAC-204	4.83
	5.91	RAC-206	4.83
	7.87	RAC-208	4.83
	9.84	RAC-2010	4.83
30 (34.2)	1.97	RAC-302	6.85
	3.94	RAC-304	6.85
	5.91	RAC-306	6.85
	7.87	RAC-308	6.85
	9.84	RAC-3010	6.85
50 (54.9)	1.97	RAC-502	10.99
	3.94	RAC-504	10.99
	5.91	RAC-506	10.99
	7.87	RAC-508	10.99
	9.84	RAC-5010	10.99
100 (110.9)	1.97	RAC-1002	22.19
	3.94	RAC-1004	22.19
	5.91	RAC-1006	22.19
	7.87	RAC-1008	22.19
	9.84	RAC-10010	22.19
150 (175.9)	1.97	RAC-1502	35.18
	3.94	RAC-1504	35.18
	5.91	RAC-1506	35.18
	7.87	RAC-1508	35.18
	9.84	RAC-15010	35.18

* Custom strokes available.

Single-Acting, Spring Return Cylinders



Steel Base Plate

The steel base plate protects the cylinder base from damage, it should not be removed.

The base holes in these aluminum cylinders are designed for securing the steel base plate. **They will not withstand the capacity of the cylinder.**

Do not use the base holes in these aluminum cylinders to attach any device to the cylinder.

Capacity:

20-150 tons

Stroke:

1.97-9.84 inches

Maximum Operating Pressure:

10,000 psi

RAC Series



Optional Bolt-on Tilt Saddle Dimensions (in)

Cylinder Model / Capacity (ton)	Model Number*	Saddle Diameter J1	Saddle Protrusion from Plunger K1
RAC-50	CATG-50	1.95	1.02
RAC-100	CATG-150	3.57	1.30
RAC-150	CATG-200	4.64	1.44

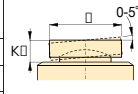

* Tilt saddle not available for less than 50 ton.

Steel Base Plate Mounting Holes

Cylinder Model / Capacity (ton)	Bolt Circle U (in)	Thread V (mm)	Thread Depth ¹⁾ Z (in)
RAC-20	2.76	M6	.47
RAC-30	3.15	M6	.47
RAC-50	4.33	M6	.47
RAC-100	5.91	M10	.47
RAC-150	7.87	M10	.47

¹⁾ Including Base Plate Height of .25 inches. Four (4) base plate bolts included.

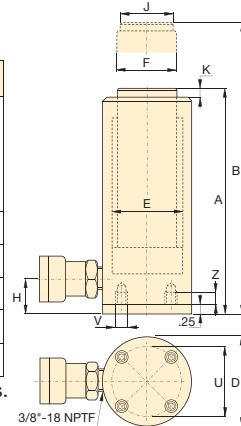

Oil Capacity (in ³)	Collapsed Height A (in)	Extended Height B (in)	Outside Diameter D (in)	Cylinder Bore Diameter E (in)	Plunger Diameter F (in)	Base to Advance Port H (in)	Saddle Diameter J (in)	Saddle Protrusion from Plunger K (in)	Weight (lbs)	Model Number
9.52	6.86	8.83	3.35	2.48	1.97	1.07	1.58	0.12	7.9	RAC-202
19.03	8.83	12.76	3.35	2.48	1.97	1.07	1.58	0.12	9.0	RAC-204
28.55	10.80	16.70	3.35	2.48	1.97	1.07	1.58	0.12	10.1	RAC-206
38.01	12.76	20.64	3.35	2.48	1.97	1.07	1.58	0.12	11.2	RAC-208
47.53	14.73	24.58	3.35	2.48	1.97	1.07	1.58	0.12	12.3	RAC-2010
13.49	7.13	9.10	3.94	2.95	2.36	1.31	1.58	0.12	9.9	RAC-302
26.99	9.10	13.04	3.94	2.95	2.36	1.31	1.58	0.12	11.5	RAC-304
40.48	11.07	16.98	3.94	2.95	2.36	1.31	1.58	0.12	13.0	RAC-306
53.91	13.04	20.91	3.94	2.95	2.36	1.31	1.58	0.12	14.5	RAC-308
67.40	15.01	24.85	3.94	2.95	2.36	1.31	1.58	0.12	16.1	RAC-3010
21.65	7.33	9.90	5.12	3.74	3.15	1.19	1.97	0.12	18.7	RAC-502
43.30	9.30	13.24	5.12	3.74	3.15	1.19	1.97	0.12	21.6	RAC-504
64.95	11.27	17.17	5.12	3.74	3.15	1.19	1.97	0.12	24.5	RAC-506
86.49	13.24	21.11	5.12	3.74	3.15	1.19	1.97	0.12	27.3	RAC-508
108.14	15.21	25.05	5.12	3.74	3.15	1.19	1.97	0.12	30.2	RAC-5010
43.71	8.71	10.68	7.09	5.32	4.33	1.82	3.70	0.12	38.1	RAC-1002
87.43	10.68	14.61	7.09	5.32	4.33	1.82	3.70	0.12	43.2	RAC-1004
131.14	12.65	18.55	7.09	5.32	4.33	1.82	3.70	0.12	48.3	RAC-1006
174.64	14.61	22.49	7.09	5.32	4.33	1.82	3.70	0.12	53.4	RAC-1008
218.35	16.58	26.43	7.09	5.32	4.33	1.82	3.70	0.12	58.4	RAC-10010
69.30	9.56	11.53	9.06	6.69	5.51	2.02	4.45	0.12	55.8	RAC-1502
138.61	11.53	15.47	9.06	6.69	5.51	2.02	4.45	0.12	64.6	RAC-1504
207.91	13.50	19.41	9.06	6.69	5.51	2.02	4.45	0.12	73.4	RAC-1506
276.87	15.47	23.34	9.06	6.69	5.51	2.02	4.45	0.12	82.2	RAC-1508
346.17	17.44	27.28	9.06	6.69	5.51	2.02	4.45	0.12	91.1	RAC-15010

▼ Shown from left to right: RACL-1006, RACL-504 and RACL-506



- Aluminum Lock Nut provides mechanical load holding for extended periods
- Hardened steel stop ring increases cylinder life and resistance to side-loads of up to 5%
- Hard coat finish on all surfaces resists damage and extends cylinder life
- Composite bearings increase cylinder life and side load resistance
- Handles included on all models
- Steel base plate and saddle for protection against load-induced damage
- Integral stop ring prevents plunger over-travel and is capable of withstanding the full cylinder capacity
- High-strength return spring for rapid cylinder retraction
- CR-400 coupler and dustcap included on all models
- All cylinders meet ASME B-30.1 and ISO 10100 standards



◀ The portable Lock Nut cylinder RACL-1506 used for extended load support during epoxy injection for bridge reinforcement.

To Secure Loads Mechanically



Saddles

All RACL cylinders are equipped with bolt-on removable saddles of hardened steel. For tilt saddles see next page.

Page: 15



Hoses

Enerpac offers a complete line of high-quality hydraulic hoses. To ensure the integrity of your system, specify only Enerpac hydraulic hoses.

Page: 114

Cylinder Capacity	Stroke*	Model Number	Cylinder Effective Area
ton (maximum)	(in)		(in ²)
20 (24.2)	1.97	RACL-202	4.83
	3.94	RACL-204	4.83
	5.91	RACL-206	4.83
	7.87	RACL-208	4.83
	9.84	RACL-2010	4.83
30 (34.2)	1.97	RACL-302	6.85
	3.94	RACL-304	6.85
	5.91	RACL-306	6.85
	7.87	RACL-308	6.85
	9.84	RACL-3010	6.85
50 (54.9)	1.97	RACL-502	10.99
	3.94	RACL-504	10.99
	5.91	RACL-506	10.99
	7.87	RACL-508	10.99
	9.84	RACL-5010	10.99
100 (110.9)	1.97	RACL-1002	22.19
	3.94	RACL-1004	22.19
	5.91	RACL-1006	22.19
	7.87	RACL-1008	22.19
	9.84	RACL-10010	22.19
150 (175.9)	1.97	RACL-1502	35.18
	3.94	RACL-1504	35.18
	5.91	RACL-1506	35.18
	7.87	RACL-1508	35.18
	9.84	RACL-15010	35.18

* Custom strokes available.

Single-Acting, Spring Return, Lock Nut Cylinders



Steel Base Plate

The steel base plate protects the cylinder base from damage, it should not be removed.

The base holes in these aluminum cylinders are designed for securing the steel base plate. **They will not withstand the capacity of the cylinder.**

Do not use the base holes in these aluminum cylinders to attach any device to the cylinder.

Capacity:

20-150 tons

Stroke:

1.97-9.84 inches

Maximum Operating Pressure:

10,000 psi

RACL Series



Optional Bolt-on Tilt Saddle Dimensions (in)

Cylinder Model / Capacity (ton)	Model Number*	Saddle Diameter J1	Saddle Protrusion from Plunger K1
RACL-50	CATG-50	1.95	1.02
RACL-100	CATG-150	3.57	1.30
RACL-150	CATG-200	4.64	1.44

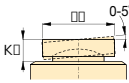

* Tilt saddle not available for less than 50 ton.

Steel Base Plate Mounting Holes

Cylinder Model / Capacity (ton)	Bolt Circle U (in)	Thread V (mm)	Thread Depth ¹⁾ Z (in)
RACL-20	2.76	M6	.47
RACL-30	3.15	M6	.47
RACL-50	4.33	M6	.47
RACL-100	5.91	M10	.47
RACL-150	7.87	M10	.47

¹⁾ Including Base Plate Height of .25 inches. Four (4) base plate bolts included.

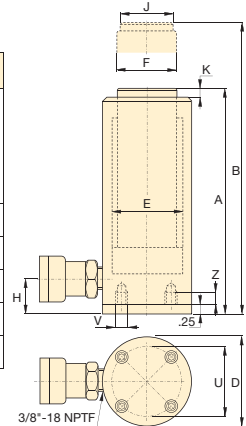

Oil Capacity (in ³)	Collapsed Height A (in)	Extended Height B (in)	Outside Diameter D (in)	Cylinder Bore Diameter E (in)	Plunger Diameter (Threaded) F (in)	Base to Advance Port H (in)	Saddle Diameter J (in)	Saddle Protrusion from Plunger K (in)	Lock Nut Height S (in)	Weight (lbs)	Model Number
9.52	8.83	10.80	3.35	2.48	2.17	1.07	1.58	0.12	1.97	8.8	RACL-202
19.03	10.80	14.73	3.35	2.48	2.17	1.07	1.58	0.12	1.97	10.1	RACL-204
28.55	12.76	18.67	3.35	2.48	2.17	1.07	1.58	0.12	1.97	11.4	RACL-206
38.01	14.73	22.61	3.35	2.48	2.17	1.07	1.58	0.12	1.97	12.7	RACL-208
47.53	16.70	26.54	3.35	2.48	2.17	1.07	1.58	0.12	1.97	14.1	RACL-2010
13.49	9.10	11.07	3.94	2.95	2.36	1.31	1.58	0.12	1.97	11.9	RACL-302
26.99	11.07	15.01	3.94	2.95	2.36	1.31	1.58	0.12	1.97	13.4	RACL-304
40.48	13.04	18.95	3.94	2.95	2.36	1.31	1.58	0.12	1.97	14.9	RACL-306
53.91	15.01	22.88	3.94	2.95	2.36	1.31	1.58	0.12	1.97	16.5	RACL-308
67.40	16.98	26.82	3.94	2.95	2.36	1.31	1.58	0.12	1.97	18.0	RACL-3010
21.65	9.30	11.27	5.12	3.74	3.15	1.19	1.97	0.12	2.95	20.5	RACL-502
43.30	11.27	15.21	5.12	3.74	3.15	1.19	1.97	0.12	2.95	23.4	RACL-504
64.95	13.24	19.14	5.12	3.74	3.15	1.19	1.97	0.12	2.95	26.2	RACL-506
86.49	15.20	23.08	5.12	3.74	3.15	1.19	1.97	0.12	2.95	29.1	RACL-508
108.14	17.17	27.02	5.12	3.74	3.15	1.19	1.97	0.12	2.95	31.9	RACL-5010
43.71	11.66	13.63	7.09	5.32	4.33	1.82	3.70	0.12	2.95	48.2	RACL-1002
87.43	13.63	17.57	7.09	5.32	4.33	1.82	3.70	0.12	2.95	53.3	RACL-1004
131.14	15.60	21.50	7.09	5.32	4.33	1.82	3.70	0.12	2.95	58.4	RACL-1006
174.64	17.57	25.44	7.09	5.32	4.33	1.82	3.70	0.12	2.95	63.4	RACL-1008
218.35	19.54	29.38	7.09	5.32	4.33	1.82	3.70	0.12	2.95	68.5	RACL-10010
69.30	12.71	14.68	9.06	6.69	5.51	2.02	4.45	0.12	3.15	71.0	RACL-1502
138.61	14.68	18.62	9.06	6.69	5.51	2.02	4.45	0.12	3.15	79.8	RACL-1504
207.91	16.65	22.56	9.06	6.69	5.51	2.02	4.45	0.12	3.15	88.6	RACL-1506
276.87	18.62	26.49	9.06	6.69	5.51	2.02	4.45	0.12	3.15	97.4	RACL-1508
346.17	20.59	30.43	9.06	6.69	5.51	2.02	4.45	0.12	3.15	106.3	RACL-15010

▼ Shown from left to right: RACH-1508, RACH-304 and RACH-208



The Lightweight Solution for Tensioning and Testing



Saddles

All RACH-cylinders are equipped with bolt-on removable hardened steel hollow saddles.



Lightweight Hand Pumps

Enerpac hand pumps **P-392** or **P-802** make the optimal lightweight set.

Page: 58

- Hollow plunger design allows for both pull and push forces
- Composite bearings increase cylinder life and side load resistance
- Hard coat finish on all surfaces resists damage and extends cylinder life
- Handles included on all models
- Floating center tube increases seal life
- Steel baseplate and saddle for protection against load-induced damage
- Integral stop ring prevents plunger over-travel and is capable of withstanding the full cylinder capacity
- High-strength return spring for rapid cylinder retraction



◀ An RACH-306, powered by a P-392 hand pump, is used to extract corroded carriage pins from refuse collection vehicles.

Cylinder Capacity tons (maximum)	Stroke* (in)	Model Number	Cylinder Effective Area (in ²)
20 (25.4)	1.97	RACH-202	5.07
	3.94	RACH-204	5.07
	5.91	RACH-206	5.07
	7.87	RACH-208	5.07
	9.84	RACL-2010	5.07
30 (39.6)	1.97	RACH-302	7.92
	3.94	RACH-304	7.92
	5.91	RACH-306	7.92
	7.87	RACH-308	7.92
	9.84	RACH-3010	7.92
60 (65.6)	1.97	RACH-602	13.13
	3.94	RACH-604	13.13
	5.91	RACH-606	13.13
	7.87	RACH-608	13.13
	9.84	RACH-6010	13.13
100 (127.5)	1.97	RACH-1002	25.51
	3.94	RACH-1004	25.51
	5.91	RACH-1006	25.51
	7.87	RACH-1008	25.51
	9.84	RACH-10010	25.51
150 (175.0)	1.97	RACH-1502	35.00
	3.94	RACH-1504	35.00
	5.91	RACH-1506	35.00
	7.87	RACH-1508	35.00
	9.84	RACH-15010	35.00

* Custom strokes available.

Single-Acting, Spring Return, Hollow Plunger Cylinders



Steel Base Plate

The steel base plate protects the cylinder base from damage, it should not be removed.

The base holes in these aluminum cylinders are designed for securing the steel base plate. **They will not withstand the capacity of the cylinder.**

Do not use the base holes in these aluminum cylinders to attach any device to the cylinder.

RACH Series



Capacity:

20-150 tons

Stroke:

1.97-9.84 inches

Center Hole Diameter:

1.06-3.11 inches

Maximum Operating Pressure:

10,000 psi

Steel Base Plate Mounting Holes			
Cylinder Model / Capacity (ton)	Bolt Circle U (in)	Thread V (mm)	Thread Depth ¹⁾ Z (in)
RACH-20	3.15	M6	.47
RACH-30	4.33	M6	.47
RACH-60	6.30	M6	.47
RACH-100	8.66	M10	.47
RACH-150	9.65	M10	.47

¹⁾ Including Base Plate Height of .25 inches. Four (4) baseplate bolts included.

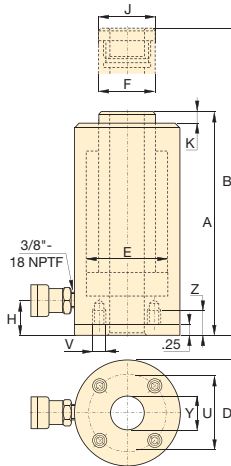

Oil Capacity (in ³)	Collapsed Height A (in)	Extended Height B (in)	Outside Diameter D (in)	Cylinder Bore Diameter E (in)	Plunger Diameter F (in)	Base to Advance Port G (in)	Saddle Diameter H (in)	Saddle Protrusion from Plunger I (in)	Center Hole Diameter J (in)	Weight (lbs)	Model Number
9.98	7.41	9.38	3.93	2.95	2.17	1.14	2.17	0.40	1.06	11.5	RACH-202
19.96	9.89	13.83	3.93	2.95	2.17	1.14	2.17	0.40	1.06	13.5	RACH-204
29.94	12.41	18.32	3.93	2.95	2.17	1.14	2.17	0.40	1.06	15.6	RACH-206
39.87	14.89	22.76	3.93	2.95	2.17	1.14	2.17	0.40	1.06	17.7	RACH-208
49.90	17.41	27.25	3.93	2.95	2.17	1.14	2.17	0.40	1.06	19.8	RACH-210
15.59	8.20	10.17	5.12	3.74	2.76	1.14	2.76	0.40	1.34	17.6	RACH-302
31.18	10.52	14.46	5.12	3.74	2.76	1.14	2.76	0.40	1.34	20.9	RACH-304
46.77	13.12	19.02	5.12	3.74	2.76	1.14	2.76	0.40	1.34	24.6	RACH-306
62.35	15.56	23.43	5.12	3.74	2.76	1.14	2.76	0.40	1.34	28.4	RACH-308
77.94	18.04	27.88	5.12	3.74	2.76	1.14	2.76	0.40	1.34	31.9	RACH-310
25.84	9.89	11.86	7.09	5.12	3.94	2.41	3.94	0.47	2.13	35.6	RACH-602
51.69	12.41	16.35	7.09	5.12	3.94	2.41	3.94	0.47	2.13	42.8	RACH-604
77.53	14.97	20.87	7.09	5.12	3.94	2.41	3.94	0.47	2.13	50.3	RACH-606
103.37	17.52	25.40	7.09	5.12	3.94	2.41	3.94	0.47	2.13	57.2	RACH-608
129.21	20.09	29.93	7.09	5.12	3.94	2.41	3.94	0.47	2.13	65.1	RACH-6010
50.21	10.16	12.13	9.84	7.28	5.71	2.41	5.71	0.55	3.11	74.6	RACH-1002
100.43	12.80	16.74	9.84	7.28	5.71	2.41	5.71	0.55	3.11	87.8	RACH-1004
150.64	15.40	21.31	9.84	7.28	5.71	2.41	5.71	0.55	3.11	101.9	RACH-1006
200.85	18.08	25.95	9.84	7.28	5.71	2.41	5.71	0.55	3.11	115.7	RACH-1008
251.07	20.76	30.60	9.84	7.28	5.71	2.41	5.71	0.55	3.11	129.3	RACH-10010
66.08	11.03	13.00	10.83	8.07	5.91	2.41	5.91	0.55	3.11	107.7	RACH-1502
132.17	14.18	18.12	10.83	8.07	5.91	2.41	5.91	0.55	3.11	122.8	RACH-1504
206.72	16.93	22.84	10.83	8.07	5.91	2.41	5.91	0.55	3.11	138.9	RACH-1506
275.62	19.69	27.57	10.83	8.07	5.91	2.41	5.91	0.55	3.11	154.5	RACH-1508
344.53	22.45	32.29	10.83	8.07	5.91	2.41	5.91	0.55	3.11	170.2	RACH-15010

▼ Shown from left to right: RAR-506, RAR-508, RAR-302



The Lightweight Solution for Double-Acting Applications



Saddles

All RAR-cylinders are equipped with bolt-on removable hardened steel saddles. For tilt saddles see next page.

Page: 19



Hoses

Enerpac offers a complete line of high-quality hydraulic hoses. To ensure the integrity of your system, specify only Enerpac hydraulic hoses.

Page: 114

- Double-acting for rapid retraction, regardless of hose lengths and system losses
- Composite bearings increase cylinder life and side load resistance
- Hard coat finish on all surfaces resists damage and extends cylinder life
- Handles included on all models
- Steel base plate and saddle for protection against load-induced damage
- Integral stop ring prevents plunger over-travel and is capable of withstanding the full cylinder capacity
- Built-in safety valve prevents accidental over-pressurization



◀ An RAR-506 was easy to position under a bulldozer for repair of frame member.

Cylinder Capacity (ton)	Stroke* (in)	Model Number	Maximum Cylinder Capacity (ton)		Cylinder Effective Area (in ²)		Oil Capacity (in ³)	
			Push	Pull	Push	Pull	Push	Pull
20 (24.2)	1.97	RAR-202	24.2	14.4	4.83	2.88	9.52	5.67
	3.94	RAR-204	24.2	14.4	4.83	2.88	19.03	11.34
	5.91	RAR-206	24.2	14.4	4.83	2.88	28.55	17.02
	7.87	RAR-208	24.2	14.4	4.83	2.88	38.01	22.66
	9.84	RAR-2010	24.2	14.4	4.83	2.88	47.53	28.34
30 (34.2)	1.97	RAR-302	34.2	19.0	6.85	3.80	13.49	7.49
	3.94	RAR-304	34.2	19.0	6.85	3.80	26.99	14.97
	5.91	RAR-306	34.2	19.0	6.85	3.80	40.48	22.46
	7.87	RAR-308	34.2	19.0	6.85	3.80	53.91	29.91
	9.84	RAR-3010	34.2	19.0	6.85	3.80	67.40	37.39
50 (54.9)	1.97	RAR-502	54.9	17.1	10.99	3.54	21.65	6.97
	3.94	RAR-504	54.9	17.1	10.99	3.54	43.30	13.95
	5.91	RAR-506	54.9	17.1	10.99	3.54	64.95	20.92
	7.87	RAR-508	54.9	17.1	10.99	3.54	86.49	27.86
	9.84	RAR-5010	54.9	17.1	10.99	3.54	108.14	34.83
100 (110.9)	1.97	RAR-1002	110.9	61.7	22.19	12.33	43.71	24.29
	3.94	RAR-1004	110.9	61.7	22.19	12.33	87.43	48.58
	5.91	RAR-1006	110.9	61.7	22.19	12.33	131.14	72.87
	7.87	RAR-1008	110.9	61.7	22.19	12.33	174.64	97.04
	9.84	RAR-10010	110.9	61.7	22.19	12.33	218.35	121.33
150 (175.9)	1.97	RAR-1502	175.9	102.25	35.18	20.45	69.30	40.29
	3.94	RAR-1504	175.9	102.25	35.18	20.45	138.61	80.57
	5.91	RAR-1506	175.9	102.25	35.18	20.45	207.91	120.86
	7.87	RAR-1508	175.9	102.25	35.18	20.45	276.87	160.94
	9.84	RAR-15010	175.9	102.25	35.18	20.45	346.17	201.23

* Custom strokes available.

Double-Acting, Aluminum Cylinders



Steel Base Plate

The steel base plate protects the cylinder base from damage, it should not be removed.

The base holes in these aluminum cylinders are designed for securing the steel base plate. **They will not withstand the capacity of the cylinder.**

Do not use the base holes in these aluminum cylinders to attach any device to the cylinder.

Capacity:
20-150 tons

Stroke:
1.97-9.84 inches

Maximum Operating Pressure:
10,000 psi

RAR Series



Optional Bolt Tilt Saddle Dimensions (in)

Cylinder Model / Capacity (ton)	Model Number*	Saddle Diameter J1	Saddle Protrusion from Plunger K1
RAR-50	CATG-50	1.95	1.02
RAR-100	CATG-100	2.81	1.22
RAR-150	CATG-150	3.57	1.30

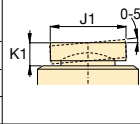

* Tilt saddle not available for less than 50 ton.

Steel Base Plate Mounting Holes

Cylinder Model / Capacity (ton)	Bolt Circle U (in)	Thread V (mm)	Thread Depth ¹⁾ Z (in)
RAR-20	3.66	M6	.47
RAR-30	4.13	M6	.47
RAR-50	4.33	M6	.47
RAR-100	6.10	M10	.47
RAR-150	7.87	M10	.47

¹⁾ Including Base Plate Height of .25 inches. Four (4) base plate bolts included.

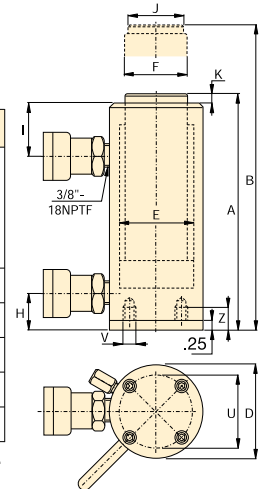

Collapsed Height	Extended Height	Outside Diameter	Cylinder Bore Diameter	Plunger Diameter	Base to Advance Port	Top to Retract Port	Saddle Diameter	Saddle Protrusion from Plunger	Weight	Model Number
A (in)	B (in)	D (in)	E (in)	F (in)	H (in)	I (in)	J (in)	K (in)	(lbs)	
7.45	9.42	4.45	2.48	1.58	1.19	1.97	1.18	0.12	16.3	RAR-202
9.42	13.35	4.45	2.48	1.58	1.19	1.97	1.18	0.12	17.6	RAR-204
11.29	17.29	4.45	2.48	1.58	1.19	1.97	1.18	0.12	19.0	RAR-206
13.35	21.23	4.45	2.48	1.58	1.19	1.97	1.18	0.12	20.3	RAR-208
15.32	25.17	4.45	2.48	1.58	1.19	1.97	1.18	0.12	21.6	RAR-2010
7.92	9.89	4.92	2.95	1.97	1.19	2.17	1.58	0.12	19.0	RAR-302
9.89	13.83	4.92	2.95	1.97	1.19	2.17	1.58	0.12	20.9	RAR-304
11.86	17.76	4.92	2.95	1.97	1.19	2.17	1.58	0.12	22.9	RAR-306
13.83	21.70	4.92	2.95	1.97	1.19	2.17	1.58	0.12	24.9	RAR-308
15.80	25.64	4.92	2.95	1.97	1.19	2.17	1.58	0.12	26.9	RAR-3010
7.92	9.89	5.71	3.74	2.95	1.19	2.21	1.97	0.12	24.5	RAR-502
9.89	13.83	5.71	3.74	2.95	1.19	2.21	1.97	0.12	28.0	RAR-504
11.86	17.76	5.71	3.74	2.95	1.19	2.21	1.97	0.12	31.5	RAR-506
13.83	21.70	5.71	3.74	2.95	1.19	2.21	1.97	0.12	35.1	RAR-508
15.80	25.64	5.71	3.74	2.95	1.19	2.21	1.97	0.12	38.6	RAR-5010
9.89	11.86	7.28	5.32	3.54	1.70	3.15	2.95	0.12	36.2	RAR-1002
11.86	15.80	7.28	5.32	3.54	1.70	3.15	2.95	0.12	42.6	RAR-1004
13.83	19.73	7.28	5.32	3.54	1.70	3.15	2.95	0.12	48.9	RAR-1006
15.80	23.67	7.28	5.32	3.54	1.70	3.15	2.95	0.12	55.3	RAR-1008
17.76	27.61	7.28	5.32	3.54	1.70	3.15	2.95	0.12	61.7	RAR-10010
9.77	11.74	9.06	6.70	4.33	1.50	2.95	3.70	0.12	53.4	RAR-1502
11.74	16.68	9.06	6.70	4.33	1.50	2.95	3.70	0.12	63.7	RAR-1504
13.71	19.61	9.06	6.70	4.33	1.50	2.95	3.70	0.12	73.2	RAR-1506
15.68	23.55	9.06	6.70	4.33	1.50	2.95	3.70	0.12	83.6	RAR-1508
19.61	29.46	9.06	6.70	4.33	1.50	2.95	3.70	0.12	93.9	RAR-15010

▼ Shown from left to right: CLP-4002, CLP-5002



The Shortest Power Lifter

- Flat design for use in confined areas
- Safety lock nut for mechanical load holding
- Single-acting load return
- Special bearing design resists sideload forces
- Overflow port functions as a stroke limiter
- CR-400 coupler and dust cap included on all models



Saddles

All CLP-Series cylinders include integral tilt saddles with maximum tilt angles up to 5°.



Gauges

Minimize the risk of overloading and ensure long, dependable service from your equipment. Refer to the

System Components section for a full range of gauges.

Page: 113



Hoses

Enerpac offers a complete line of high-quality hydraulic hoses. To ensure the integrity of your system, specify only Enerpac hydraulic hoses.

Page: 114

▼ Only the extreme low height CLP-cylinder fits in this confined area to lift the construction. The V-82 needle valve is used to control cylinder speed during lifting and lowering.



Cylinder Capacity (ton) [maximum]	Stroke (in)	Model Number	Cylinder Effective Area (in ²)	Oil Capacity (in ³)
60 [67.1]	1.97	CLP-602	13.42	26.42
100 [113.7]	1.97	CLP-1002	22.75	44.78
160 [179.2]	1.77	CLP-1602	35.85	63.51
200 [221.3]	1.77	CLP-2002	44.27	78.43
250 [284.2]	1.77	CLP-2502	56.85	100.72
400 [433.6]	1.77	CLP-4002	86.72	153.64
500 [566.2]	1.77	CLP-5002	113.25	200.63

Single-Acting, Pancake Lock Nut Cylinders



Speed Chart

See the Enerpac Cylinder Speed Chart in our "Yellow Pages" to determine your approximate cylinder speed.

Page: 251



Longer Stroke Lock Nut Cylinders

For lock nut applications that require longer stroke lengths, see **CLL-Series** cylinders.

Page: 44

CLP Series



Capacity:

60-500 tons

Stroke:

1.77-1.97 inches

Maximum Operating Pressure:

10,000 psi

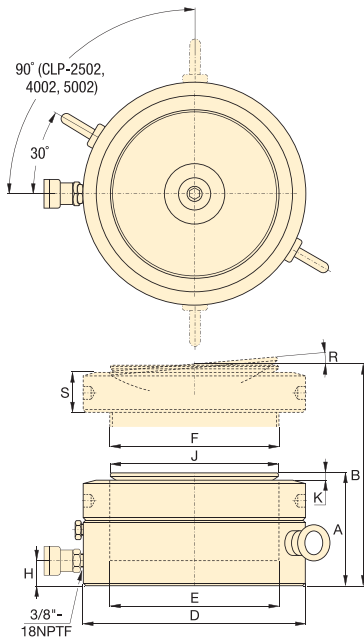

CLP-4002, CLP-5002

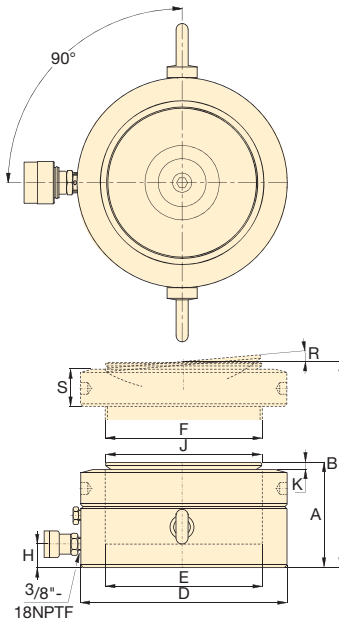

CLP-602, CLP-1002,
CLP-1602, CLP-2002,
CLP-2502



All CLP-series cylinders require a solid lifting surface for correct support.

Use of pancake cylinders on surfaces such as sand, mud or dirt may result in cylinder damage!

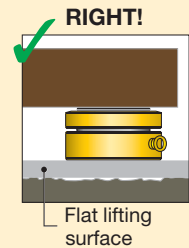
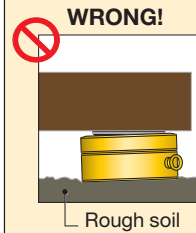

For more safety instructions see our "Yellow Pages".

Page: 241

Collapsed Height	Extended Height	Outside Diameter	Cyl. Bore Diameter	Plunger Diameter	Base to Advance Port	Saddle Diameter	Saddle Protrusion from Plunger	Saddle Max. Tilt Angle	Lock Nut Height	Weight	Model Number
A (in)	B (in)	D (in)	E (in)	F (mm)	H (in)	J (in)	K (in)	R	S (in)	(lbs)	
4.92	6.89	5.51	4.13	Tr 104 x 4	.75	3.78	.24	5°	1.10	33	CLP-602
5.39	7.36	6.89	5.38	Tr 136 x 6	.83	4.96	.31	5°	1.22	57	CLP-1002
5.83	7.60	8.66	6.76	Tr 171 x 6	1.06	6.30	.35	5°	1.57	97	CLP-1602
6.10	7.87	9.65	7.51	Tr 190 x 6	1.18	7.09	.39	5°	1.69	125	CLP-2002
6.26	8.03	10.83	8.51	Tr 216 x 6	1.26	7.87	.43	5°	1.73	163	CLP-2502
7.01	8.78	13.78	10.51	Tr 266 x 6	1.54	9.84	.43	4°	2.17	295	CLP-4002
7.56	9.33	15.75	12.01	Tr 305 x 6	1.89	11.42	.39	3°	2.44	416	CLP-5002

▼ Shown from left to right: RSM-1000, RSM-300, RSM-50, RCS-1002, RCS-302



Maximum Power to Height Ratio



Saddles

All **RCS-Series** cylinders have plunger mounting holes for installation of tilt saddles. See table for selection and dimensional information.

Page: **23**



Low Clearance Lifting

The **LW-16** Lifting Wedge and **SOH-Series** Machine Lifts are the perfect choices for lifting loads that have low clearance.

Page: **159**

RSM-Series, Flat-Jac® Cylinders

- Compact, flat design for use where other cylinders will not fit
- RSM-750, 1000 and 1500 have handles for easy carrying
- Mounting holes permit easy fixturing
- Baked enamel finish for increased corrosion resistance
- CR-400 coupler and dust cap included on all models*
- Hard chrome plated high-quality steel plungers
- Grooved plunger ends require no saddle
- Single-acting spring return

RCS-Series, Low Height Cylinders

- Lightweight, low profile design for use in confined spaces
- Baked enamel finish for increased corrosion resistance
- Plunger wiper reduces contamination, extending cylinder life
- CR-400 coupler and dust cap included on all models
- Grooved plunger end with threaded holes for mounting tilt saddles
- Integral handle on RCS-1002 for easy carrying
- Plated steel plungers
- Single-acting spring return

▼ Only a couple of inches are needed for an RSM-cylinder to lift this large steel construction.



Cylinder Capacity	Stroke	Model Number	Cyl. Effect. Area	Oil Cap.
(tons) [max.]	(in)		(in ²)	(in ³)
5 [4.9]	.25	RSM-50*	.99	.25
10 [11.2]	.44	RSM-100	2.24	.98
20 [22.1]	.44	RSM-200	4.43	1.94
30 [32.4]	.50	RSM-300	6.49	3.25
50 [48.1]	.63	RSM-500	9.62	6.01
75 [79.5]	.63	RSM-750	15.90	9.94
100 [98.1]	.63	RSM-1000	19.63	12.27
150 [153.4]	.63	RSM-1500	30.68	19.17
10 [11.2]	1.50	RCS-101**	2.24	3.35
20 [22.1]	1.75	RCS-201**	4.43	7.75
30 [32.4]	2.44	RCS-302**	6.49	15.82
50 [48.1]	2.38	RCS-502**	9.62	22.85
100 [98.1]	2.25	RCS-1002**	19.63	44.18

* RSM-50 is fitted with an AR-400 coupler.

** Available as a set. See note on next page.

Single-Acting, Low Height Cylinders

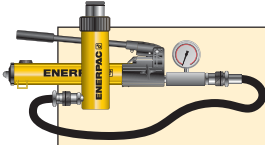

Pump and Cylinder Sets

All cylinders marked with an ** are available as **sets** (cylinder, gauge, couplers, hose and pump) for your ordering convenience.

Page: 54

Optional Bolt On Tilt Saddle Dimensions (in)

For cylinder model:	Model Number	A	B	C*
RCS-201, -302, -502	CAT-51	1.97	.59	1.14
RCS-1002	CAT-101	2.80	.67	1.39

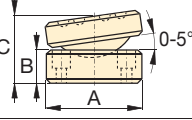

* "C" dimension equals saddle protrusion from plunger. Mounting screws are included.

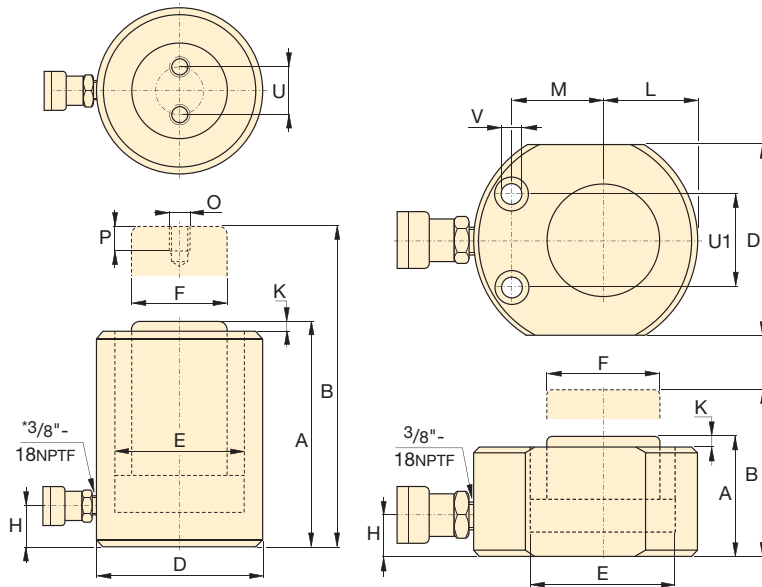

RCS-Series

RSM-Series

* 5° angle position of coupler on RCS-101, 201, 302.

RSM RCS Series



Capacity:

5-150 tons

Stroke:

.25-2.44 inches

Maximum Operating Pressure:

10,000 psi

RSM Cylinder Mounting Hole Dimensions (in)

Model Number	Hole Pitch U1	Hole Diam. V	Counter Bore Diam.	Counter Bore Depth
RSM-50	1.12	.20	.312	.17
RSM-100	1.44	.28	.422	.31
RSM-200	1.94	.40	.594	.39
RSM-300	2.06	.40	.625	.44
RSM-500	2.62	.47	.750	.50
RSM-750	3.00	.53	.812	.56
RSM-1000	3.00	.53	.812	.56
RSM-1500	4.62	.53	.812	.56

Collapsed Height	Extended Height	Outside Diameter	Cylinder Bore Diameter	Plunger Diameter	Base to Advance Port	Plunger Protrusion from Base	Plunger to Base	Plunger to Mtg. Hole	Thread	Thread Depth	Bolt Circle	Weight	Model Number
A (in)	B (in)	D (in)	E (in)	F (in)	H (in)	K (in)	L (in)	M (in)	O (mm)	P (in)	U (in)	(lbs)	
1.28	1.53	2.31 x 1.63	1.13	1.00	.63	.04	.81	.88	-	-	-	2.3	RSM-50*
1.69	2.13	3.25 x 2.19	1.69	1.50	.75	.04	1.09	1.34	-	-	-	3.1	RSM-100
2.03	2.47	4.00 x 3.00	2.38	2.00	.75	.04	1.56	1.56	-	-	-	6.8	RSM-200
2.31	2.81	4.63 x 3.75	2.88	2.50	.75	.08	1.88	1.75	-	-	-	10	RSM-300
2.63	3.25	5.50 x 4.50	3.50	2.75	.75	.08	2.25	2.13	-	-	-	15	RSM-500
3.13	3.75	6.50 x 5.50	4.50	3.25	.75	.08	2.75	2.63	-	-	-	25	RSM-750
3.38	4.00	7.00 x 6.00	5.00	3.63	.75	.08	3.00	2.94	-	-	-	32	RSM-1000
3.94	4.56	8.50 x 7.50	6.25	4.50	.94	.08	3.75	3.25	-	-	-	58	RSM-1500
3.47	4.97	2.75	1.69	1.50	.69	.20	-	-	M4	.32	1.03	9	RCS-101**
3.88	5.63	3.63	2.38	2.00	.69	.13	-	-	M5	.32	1.57	11	RCS-201**
4.63	7.06	4.00	2.88	2.62	.75	.13	-	-	M5	.32	1.57	15	RCS-302**
4.81	7.19	4.88	3.50	2.75	.94	.08	-	-	M5	.32	1.57	24	RCS-502**
5.56	7.81	6.50	5.00	3.63	1.25	.06	-	-	M8	.40	2.17	50	RCS-1002**

▼ Shown from left to right: BRC-25, BRC-46, BRP-306, BRP-606, BRP-106C



- High strength alloy steel construction
- Plunger blow-out protection to prevent over-extension
- Hard chrome-plated plunger for long life
- Baked enamel finish for increased corrosion resistance
- CR-400 coupler and dust cap included on all models
- Plunger wiper reduces contamination, extending cylinder life
- Single-acting spring-return
- Replaceable links on BRP-models

▼ Ship building, welding and Enerpac pull cylinders go hand in hand.



The Ultimate in Pulling Power

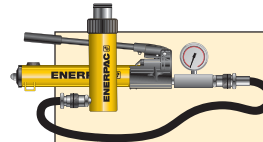

Pump and Cylinder Sets

All cylinders marked with an * are available as **sets** (cylinder, gauge, couplers, hose and pump) for your ordering convenience.

Page: 54



Gauges

Minimize the risk of over-loading and ensure long, dependable service from your equipment. Refer to the System Components section for a full range of gauges.

Page: 113



Attachments and Accessories

The BRC-25 and BRC-46 units have base, collar and plunger threads to affix a range of optional attachments and accessories, such as chains, saddles and extension tubes.

Page: 160

▼ To lift a load bearing mast into place, BRP cylinders were used to tension the supporting cables.



Single-Acting, Pull Cylinders

BRC Cylinder Mounting Dimensions (in)				
Model Number	Base Mounting Hole V	Collar Thread W	Collar Thread Length X	Mtg. Thread Length Z
BRC-25	3/4"-14 NPT	1 1/2"-16 UN	.98	.67
BRC-46	1 1/4"-11 1/2" NPT	2 1/4"-14 UN	1.06	.98
BRC-106	M30 x 2	M85 x 2	1.02	.98

**BRC
BRP
Series**



Capacity:
2.5-60 tons

Stroke:
5.00-6.00 inches

Maximum Operating Pressure:
10,000 psi

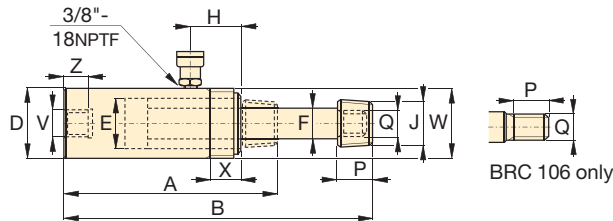

BRC-25 to BRC-106

Cylinder Capacity (tons) [maximum]	Stroke (in)	Model Number	Cyl. Effect. Area (in ²)	Oil Cap. (in ³)	Collap. Height A (in)	Ext. Height B (in)	Outside Diam. D (in)	Cyl. Bore Diam. E (in)	Plgr. Diam. F (in)	Top to Inlet Port H (in)	Saddle Diameter J (in)	Plunger Thread Length P (in)	Plunger Outside Thread Q	Weight (lbs)
2.5 [2.7]	5.00	BRC-25	.55	2.76	10.44	15.44	1.89	1.13	.75	1.77	3/4"-14 NPT	1.13	1 1/16"-24	4
5 [5.6]	5.50	BRC-46	1.13	6.21	11.88	17.38	2.25	1.69	1.19	1.69	1 1/4"-11 1/2" NPT	1.25	1 3/16"-16	10
10 [11.6]	5.95	BRC-106	2.32	13.80	11.38	17.33	3.35	2.13	1.25	1.57	-	1.02	M30x2	21

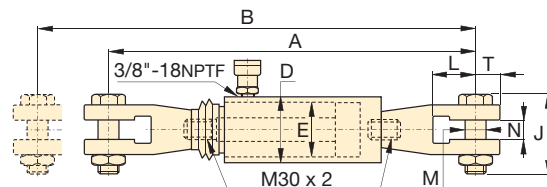

BRP-106C

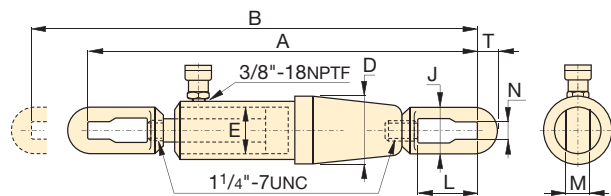

BRP-306

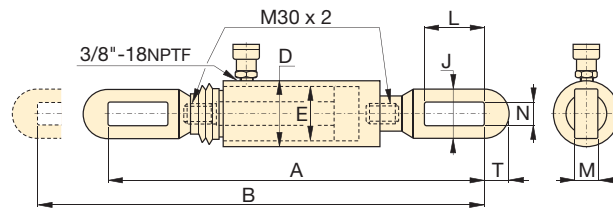

BRP-106L

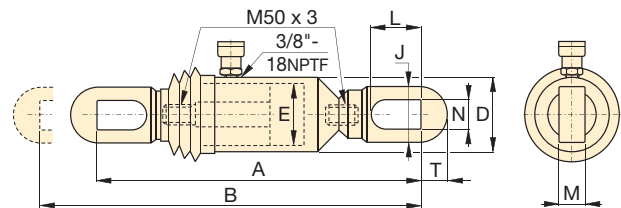

BRP-606

Cylinder Capacity (tons) [maximum]	Stroke (in)	Model Number	Cyl. Effect. Area (in ²)	Oil Capacity (in ³)	Collap. Height A (in)	Ext. Height B (in)	Outside Diam. D (in)	Cyl. Bore Diam. E (in)	Link Height J (in)	Link Opening L (in)	Link Thickness M (in)	Link Width N (in)	Slot to Link End T (in)	Weight (lbs)
10 [11.6]	6.00	BRP-106C*	2.32	13.80	23.11	29.06	3.35	2.13	4.72	2.44	1.19	1.38	1.26	35
	6.00	BRP-106L*	2.32	13.80	22.24	28.19	3.35	2.13	2.64	4.53	0.88	1.19	1.26	24
30 [36.1]	6.00	BRP-306*	7.22	43.27	42.72	48.82	5.39	3.50	4.49	5.71	1.38	1.57	1.97	106
60 [58.8]	6.00	BRP-606*	11.78	70.43	28.34	34.32	5.51	4.33	5.13	5.90	1.57	1.97	2.76	118

Note: BRP-106C, BRP-106L and BRP-606 are fitted with rubber bellows for rod protection.

*Available as a set. See note on previous page. Please refer to drawings above for BRP-106C and BRP-106L.

▼ Shown from left to right: RCH-306, RCH-120, RCH-1003



- Hollow plunger design allows for both pull and push forces
- Single-acting spring return
- Nickel-plated, floating center tube on models over 20 tons increases product life
- Baked enamel finish for increased corrosion resistance
- Collar threads for easy fixturing
- RCH-120 includes AR-630 coupler and has 1/4 NPTF port
- RCH-121 and RCH-1211 have FZ-1630 reducer and AR-630 coupler, all other models feature CR-400 coupler

▼ Hollow plunger cylinder RCH-1003 used in an application for intermediate boom suspension on a dragline.



Versatility in Testing, Maintenance and Tensioning Applications

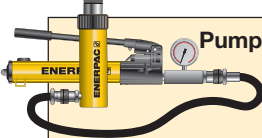

Pump and Cylinder Sets
All cylinders marked with an * are available as sets (cylinder, gauge, couplers, hose and pump) for your ordering convenience. **Page: 54**



Lightweight Aluminum Hollow Plunger Cylinders
If you need a higher cylinder capacity-to-weight ratio the lightweight RACH-Series Aluminum Hollow Plunger Cylinders are the perfect choice. **Page: 16**



Saddles
Most RCH-Series cylinders are equipped with smooth saddles. See table at next page for optional threaded saddles and all dimensional information. **Page: 27**

Cylinder Capacity	Stroke	Model Number	Cyl. Effect. Area	Oil Cap.
(tons) [maximum]	(in)		(in ²)	(in ³)
12 [13.8]	0.31	RCH-120	2.76	0.86
	1.63	RCH-121*	2.76	4.49
	1.63	RCH-1211	2.76	4.49
	3.00	RCH-123	2.76	8.29
20 [23.6]	2.00	RCH-202*	4.73	9.46
	6.10	RCH-206	4.73	28.67
30 [36.1]	2.50	RCH-302*	7.22	18.05
	6.13	RCH-306	7.22	44.23
60 [63.6]	3.00	RCH-603*	12.73	38.20
	6.00	RCH-606	12.73	76.41
100 [103.1]	3.00	RCH-1003*	20.63	61.88

* Available as a set. See note on this page.

Single-Acting, Hollow Plunger Cylinders



Hoses

Enerpac offers a complete line of high quality hydraulic hoses. To ensure the integrity of your system, specify only Enerpac hydraulic hoses.

Page: 114

RCH Series

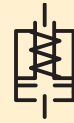

Capacity:

12-100 tons

Stroke:

.31-6.13 inches

Center Hole Diameter:

.77-3.11 inches

Maximum Operating Pressure:

10,000 psi

Optional Heat Treated Hollow Saddles

Saddle Type	Cylinder Model No.	Saddle Model No.	Saddle Dimensions (in)		
			A	B	C
Threaded Hollow	RCH-202, 206	HP-2015	2.11	1"-8	.38
	RCH-302, 306	HP-3015	2.49	1 1/4"-7	.38
	RCH-603, 606	HP-5016	3.61	1 5/8"-5 1/2"	.50
	RCH-1003	HP-10016	4.97	2 1/2"-8	.51

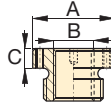

Smooth hollow saddles are standard on all RCH-models (12-ton models are not equipped with saddles).

RCH-121 and RCH-1211 have a 1.88" diameter boss that protrudes 0.25" from base.

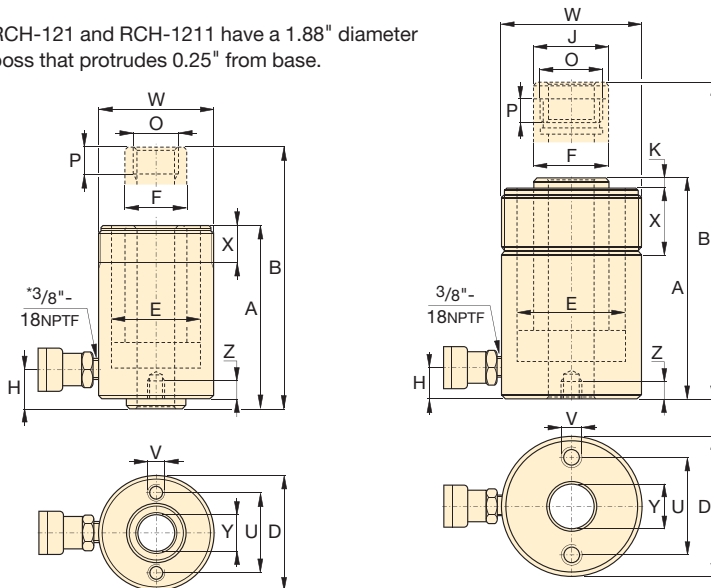

RCH-120 to RCH-123 models

RCH-202 to RCH-1003 models

* 1/4" NPT for RCH-120 only

Base Mounting Hole Dimensions (in)

Model Number	Bolt Circle			Thread	Thread Depth Z
	U	V	Z		
RCH-120	2.00	5/16"-18 UNC	.35		
RCH-121	-	-	-		
RCH-1211	-	-	-		
RCH-123	2.00	5/16"-18 UNC	.50		
RCH-202	3.25	3/8"-16 UNC	.37		
RCH-206	3.25	3/8"-16 UNC	.37		
RCH-302	3.63	3/8"-16 UNC	.55		
RCH-306	3.63	3/8"-16 UNC	.55		
RCH-603	5.13	1/2"-13 UNC	.55		
RCH-606	5.13	1/2"-13 UNC	.55		
RCH-1003	7.00	5/8"-11 UNC	.75		

Collap. Height	Ext. Height	Outside Diam.	Cyl. Bore Diam.	Plngr. Diam.	Cyl. Base to Advance Port	Saddle Diameter	Saddle Protrusion from Plngr.	Plunger Internal Thread	Plunger Thread Length	Collar Thread	Collar Thread Length	Center Hole Diam.	Weight	Model Number
A (in)	B (in)	D (in)	E (in)	F (in)	H (in)	J (in)	K (in)	O (in)	P (in)	W (in)	X (in)	Y (in)	(lbs)	
2.19	2.50	2.75	2.13	1.38	.38	-	-	3/4"-16 UN	.63	2 3/4"-16	1.19	.77	3.2	RCH-120
4.75	6.38	2.75	2.13	1.38	.98	-	-	-	-	2 3/4"-16	1.19	.77	6.2	RCH-121*
4.75	6.38	2.75	2.13	1.38	.98	-	-	3/4"-16 UN	.63	2 3/4"-16	1.19	.77	6.2	RCH-1211
7.25	10.25	2.75	2.13	1.38	.98	-	-	-	-	2 3/4"-16	1.19	.77	9.8	RCH-123
6.38	8.38	3.88	2.88	2.13	.75	2.13	.27	1 9/16"-16 UN	.75	3 7/8"-12	1.50	1.06	17	RCH-202*
12.05	18.11	3.88	2.88	2.13	.75	2.13	.27	1 9/16"-16 UN	.75	3 7/8"-12	1.50	1.06	31	RCH-206
7.03	9.53	4.50	3.50	2.50	.85	2.50	.38	1 13/16"-16 UN	.88	4 1/2"-12	1.66	1.31	24	RCH-302*
13.00	19.13	4.50	3.50	2.50	1.00	2.50	.38	1 13/16"-16 UN	.88	4 1/2"-12	1.66	1.31	48	RCH-306
9.75	12.75	6.25	4.88	3.63	1.25	3.61	.50	2 3/4"-16 UN	.75	6 1/4"-12	1.91	2.12	62	RCH-603*
12.75	18.75	6.25	4.88	3.63	1.25	3.61	.50	2 3/4"-16 UN	.75	6 1/4"-12	1.91	2.12	78	RCH-606
10.00	13.00	8.38	6.50	5.00	1.50	4.97	.50	4"-16 UN	1.00	8 3/8"-12	2.38	3.11	132	RCH-1003*

▼ Shown from left to right: RRH-3010, RRH-1001, RRH-6010



Versatility in Testing, Maintenance and Tensioning Applications



Pump Selection

A double-acting cylinder must be powered by a pump with a 4-way valve.

Page: 57



Gauges

Minimize the risk of overloading and ensure long, dependable service from your equipment. Refer to the System Components section for a full range of gauges.

Page: 113



Saddles

All RRH-Series cylinders are equipped with smooth saddles. See table on next page for optional threaded saddles and all dimensional information.

Page: 29

- Relief valves prevent damage in case of over-pressurization
- Baked enamel finish for increased corrosion resistance
- Collar threads enable easy fixturing (except RRH-1001 and RRH-1508)
- Double-acting operation for fast retraction
- Nickel-plated, floating center tube increases product life
- Hollow plunger allows for both pull and push forces
- CR-400 couplers and dust caps included on all models
- Plunger wiper reduces contamination, extending cylinder life

▼ Double-acting hollow plunger cylinders are applied for bridge launching systems.



Cylinder Capacity (ton)	Stroke (in)	Model Number	Max. Cylinder Capacity (ton)		Cylinder Effective Area (in ²)		Oil Capacity (in ³)	
			Advance	Retract	Advance	Retract	Advance	Retract
30	7.00	RRH-307	36	24	7.22	4.71	50.55	32.99
	10.13	RRH-3010	36	24	7.22	4.71	73.12	47.71
60	3.50	RRH-603	64	42	12.73	8.37	44.57	29.21
	6.50	RRH-606	64	42	12.73	8.37	82.77	54.24
	10.12	RRH-6010	64	42	12.73	8.37	128.94	84.49
100	1.50	RRH-1001	103	68	20.63	13.54	30.94	20.32
	3.00	RRH-1003	103	68	20.63	13.54	61.88	40.64
	6.00	RRH-1006	103	68	20.63	13.54	123.76	81.29
	10.13	RRH-10010	103	68	20.63	13.54	208.84	137.17
150	8.00	RRH-1508	158	80	31.62	15.91	252.97	127.23

Double-Acting, Hollow Plunger Cylinders



Hoses

Enerpac offers a complete line of high quality hydraulic hoses. To ensure the integrity of your system, specify only Enerpac hydraulic hoses.

Page: 114

RRH Series



Capacity:

30-150 tons

Stroke:

1.50-10.13 inches

Center Hole Diameter:

1.31-3.13 inches

Maximum Operating Pressure:

10,000 psi

Optional Heat Treated Saddles

Saddle Type	Cylinder Model Number	Saddle Model No.	Saddle Dimensions (in)		
			A	B	C
Threaded Hollow	RRH-307, 3010	HP-3015	2.49	1¼"-7	.38
	RRH-603, 606, 6010	HP-5016	3.61	1½"-5½	.50
	RRH-1001, 1003, RRH-1006, 10010	HP-10016	4.97	2½"-8	.51

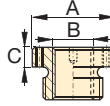

Smooth hollow saddles are standard on all RRH-models.

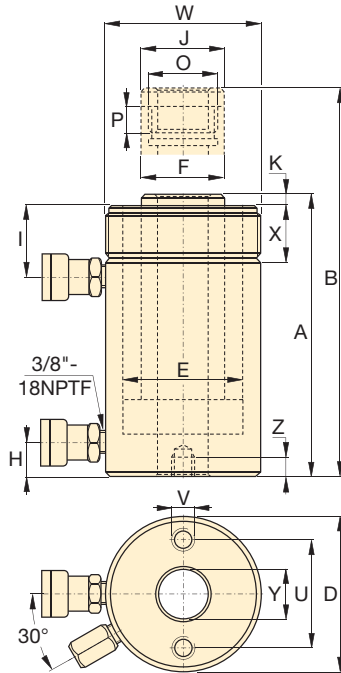

Base Mounting Hole Dimensions (in)

Model Number	Bolt Circle U	Thread V	Thread Depth Z
RRH-307	3.63	¾" - 16	.62
RRH-3010	3.63	¾" - 16	.62
RRH-603	5.12	½" - 13	.55
RRH-606	5.12	½" - 13	.55
RRH-6010	5.12	½" - 13	.55
RRH-1001	7.00	⅝" - 11	.75
RRH-1003	7.00	⅝" - 11	.75
RRH-1006	7.00	⅝" - 11	.75
RRH-10010	7.00	⅝" - 11	.75
RRH-1508	-	-	-

Collap. Height	Ext. Height	Out. Diam.	Cyl. Bore Diam.	Plngr. Diam.	Cyl. Base to Adv. Port	Cyl. Top to Return Port	Saddle Diam.	Saddle Protrusion from Plngr.	Thread	Plunger Thread Length	Collar Thread	Collar Thread Length	Center Hole Diam.	Wt.	Model Number
A	B	D	E	F	H	I	J	K	O	P	W	X	Y	(lbs)	
13.00	20.00	4.50	3.50	2.50	1.00	2.38	2.50	.38	1 ¹³ / ₁₆ "-16	.88	4½"-12	1.66	1.31	48	RRH-307
17.00	27.13	4.50	3.50	2.50	1.00	2.38	2.50	.38	1 ¹³ / ₁₆ "-16	.88	4½"-12	1.66	1.31	60	RRH-3010
9.75	13.25	6.25	4.88	3.63	1.25	2.63	3.61	.50	2¾"-16	.75	6¼"-12	1.91	2.13	62	RRH-603
12.75	19.25	6.25	4.88	3.63	1.25	2.63	3.61	.50	2¾"-16	.75	6¼"-12	1.91	2.13	78	RRH-606
17.25	27.38	6.25	4.88	3.63	1.25	2.63	3.61	.50	2¾"-16	.75	6¼"-12	1.91	2.13	101	RRH-6010
6.50	8.00	8.38	6.50	5.00	1.50	1.75	4.97	.50	4"-16	1.00	-	-	3.13	85	RRH-1001
10.00	13.00	8.38	6.50	5.00	1.50	3.38	4.97	.50	4"-16	1.00	8¾"-12	2.38	3.13	135	RRH-1003
13.50	19.50	8.38	6.50	5.00	1.50	3.38	4.97	.50	4"-16	1.00	8¾"-12	2.38	3.13	175	RRH-1006
18.13	28.25	8.38	6.50	5.00	1.50	3.38	4.97	.50	4"-16	1.00	8¾"-12	2.38	3.13	235	RRH-10010
13.75	21.75	9.75	7.50	6.00	1.50	2.38	5.00	.19	4¼"-12	1.00	-	-	3.13	245	RRH-1508

▼ Shown from left to right: RD-2510, RD-96, RD-256, RD-41, RD-166



High Precision and High Cycle Performance



Speed Chart

See the Enerpac Cylinder Speed Chart in our 'Yellow Pages' to determine your approximate cylinder speed.

Page: 251

- Designed for long life, the best choice for production applications
- Unique mounting configurations simplify fixturing
- Baked enamel finish for increased corrosion resistance
- Double-acting operation develops force in both directions, providing maximum versatility
- Plunger wiper reduces contamination, extending cylinder life

▼ Clamping application using Enerpac RD cylinders (with clevis eye attachments on both ends) for their high-pressure capability and mounting flexibility.



Cylinder Capacity (tons)	Stroke (in)	Model Number	Max. Cylinder Capacity (tons)		Cylinder Effective Area (in ²)		Oil Capacity (in ³)		Collap. Height A (in)	Ext. Height B (in)	Body Length C (in)	Outside Diam. D (in)	Cylinder Bore Diam. E (in)	Plunger Diam. F (in)
			Advance	Retract	Advance	Retract	Advance	Retract						
4	1.13	RD-41	4	2	.79	.34	.88	.39	7.31	8.44	6.38	2.00	1.00	.75
	3.13	RD-43	4	2	.79	.34	2.45	1.07	9.31	12.44	8.38	2.00	1.00	.75
	6.13	RD-46	4	2	.79	.34	4.81	2.10	12.31	18.44	11.38	2.00	1.00	.75
9	1.13	RD-91	9	5	1.77	.98	1.99	1.10	8.75	9.88	7.80	2.50	1.50	1.00
	3.13	RD-93	9	5	1.77	.98	5.52	3.07	10.78	13.91	9.80	2.50	1.50	1.00
	6.13	RD-96	9	5	1.77	.98	10.82	6.01	13.78	19.91	12.80	2.50	1.50	1.00
	10.13	RD-910	9	5	1.77	.98	17.89	9.94	17.78	27.91	16.81	2.50	1.50	1.00
16	6.25	RD-166	16	8	3.14	1.66	19.63	10.35	15.31	21.56	14.13	3.00	2.00	1.38
	10.25	RD-1610	16	8	3.14	1.66	32.20	16.98	19.31	29.56	18.11	3.00	2.00	1.38
25	6.25	RD-256	25	11	4.91	2.15	30.68	13.42	16.69	22.94	15.63	3.63	2.50	1.88
	10.25	RD-2510	25	11	4.91	2.15	50.31	22.01	20.69	30.94	19.61	3.63	2.50	1.88

Double-Acting, Precision Production Cylinders

▼ RD CYLINDER ATTACHMENTS

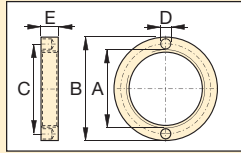

Retainer Nut
For locking foot or flange mountings. Tightens onto cylinder collar threads (included with foot and flange mounting kits)

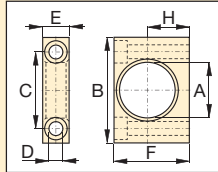

Foot Mounting
Mounts onto cylinder collar. Mounting screws not included.

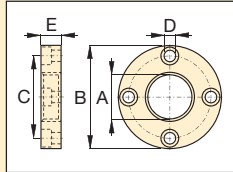

Flange Mounting
Mounts onto cylinder collar. Mounting screws not included.

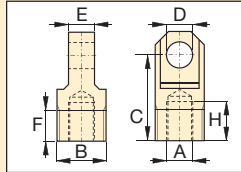

Clevis Eye
Threads onto plunger or into cylinder base

Model Number	RD-Cyl: (tons)	Dimensions (in)							
		A	B	C	D	E	F	H	
Foot Mounting with Retainer Nut									
AD-141	4	1.38	3.00	2.00	.41	.75	2.25	1.25	
AD-171	9	2.00	4.00	2.88	.53	1.00	3.25	1.75	
AD-181	16	2.63	5.00	3.75	.78	1.38	4.00	2.06	
AD-191	25	3.25	6.25	4.62	1.03	1.75	4.88	2.50	
Flange Mounting with Retainer Nut									
AD-142	4	1.38	3.88	3.09	.41	.75	-	-	
AD-172	9	2.00	4.75	3.88	.41	1.00	-	-	
AD-182	16	2.63	5.63	4.56	.53	1.38	-	-	
AD-192	25	3.25	6.50	5.34	.66	1.75	-	-	
Retainer Nut									
AD-143	4	1.375-12 UNF	2.25	1.81	.25	.38	-	-	
AD-173	9	2.000-12 UN	3.00	2.50	.27	.50	-	-	
AD-183	16	2.625-16 UN	3.63	3.12	.27	.75	-	-	
AD-193	25	3.250-16 UN	4.25	3.75	.27	1.00	-	-	
Clevis Eye									
AD-150	4	.500-20 UNF	1.125-20 UN	2.06	.63	.62	.75	.94	
AD-151	9	.750-16 UNF	1.688-18 UNEF	2.25	.75	1.00	1.00	.94	
AD-152	16	1.125-12 UNF	2.188-16 UNS	3.06	1.00	1.25	1.00	1.19	
AD-153	25	1.500-12 UNF	2.750-16	3.06	1.25	1.50	1.00	1.06	

RD Series



Capacity:
4-25 tons

Stroke:
1.13-10.25 inches

Maximum Operating Pressure:
10,000 psi

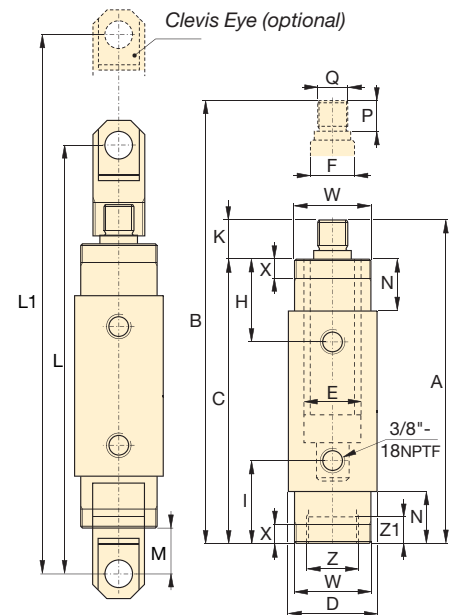

Top to Ret. Port H (in)	Bottom to Adv. Port I (in)	Plunger Protrusion K (in)	Clevis Eye Mounting Dimensions			Neck Length N (in)	Plunger Thread Length P (in)	Plunger External Thread Q (in)	Cylinder Mounting Dimensions (in)				Wt. (lbs)	Model Number
			L (in)	L1 (in)	M (in)				Collar Thread W	Collar Thread Length X	Int. Base Thread Z	Int. Base Thread Length Z1		
1.88	1.88	.94	10.12	11.25	1.61	1.13	.75	1/2"-20	1 3/8"-12	.44	1 1/8"-20	.35	4.8	RD-41
1.88	1.88	.94	12.12	15.25	1.61	1.13	.75	1/2"-20	1 3/8"-12	.44	1 1/8"-20	.35	6.4	RD-43
1.88	1.88	.94	15.12	21.25	1.61	1.13	.75	1/2"-20	1 3/8"-12	.44	1 1/8"-20	.35	9.0	RD-46
2.27	2.27	.98	11.61	12.76	1.50	1.50	.75	3/4"-16	2"-12	.56	1 11/16"-18	.55	9.0	RD-91
2.27	2.27	.98	13.66	16.79	1.50	1.50	.75	3/4"-16	2"-12	.56	1 11/16"-18	.55	11.0	RD-93
2.27	2.27	.98	16.66	22.79	1.50	1.50	.75	3/4"-16	2"-12	.56	1 11/16"-18	.55	14.0	RD-96
2.27	2.27	.98	20.66	30.79	1.50	1.50	.75	3/4"-16	2"-12	.56	1 11/16"-18	.55	19.0	RD-910
2.90	2.90	1.19	19.32	25.57	2.05	2.13	1.00	1 1/8"-12	2 5/8"-16	.88	2 3/16"-16	.94	22.0	RD-166
2.90	2.90	1.19	23.32	33.57	2.05	2.13	1.00	1 1/8"-12	2 5/8"-16	.88	2 3/16"-16	.94	29.0	RD-1610
3.50	3.50	1.06	20.86	27.11	2.09	2.75	1.00	1 1/2"-12	3 1/4"-16	1.13	2 3/4"-16	1.02	36.0	RD-256
3.50	3.50	1.08	24.86	35.11	2.09	2.75	1.00	1 1/2"-12	3 1/4"-16	1.13	2 3/4"-16	1.02	46.0	RD-2510

▼ Shown from left to right: RR-10013, RR-1502, RR-20013, RR-1010, RR-7513



- Collar threads, plunger threads and base mounting holes for easy fixturing (on most models)
- Baked enamel finish for increased corrosion resistance
- Removable hardened saddles protect plunger during lifting and pressing
- Built-in safety valve prevents accidental over-pressurization
- CR-400 couplers included on all models
- Plunger wiper reduces contamination, extending cylinder life

▼ These long stroke RR-cylinders are attached to a sliding and guiding system pulling the arched roof assembly of Athen's Olympic Stadium step by step into the final position.



Most Versatile Performers

Rugged enough for the toughest job site uses and precision designed for high-cycle industrial uses.



Pump Selection

A double-acting cylinder must be powered by a pump with a 4-way valve.

Page: 57



Saddles

RR-Series cylinders up to 75-ton have plunger thread for installation of CAT-Series tilt saddles.

Page: 33



Optimum Performance

Enerpac's range of Z-Class electric pumps, fitted with manual or solenoid operated 4-way valves, offer optimum combinations with RR cylinders.

Page: 76

▼ RR-cylinders provide power and precision in a special hydraulic press.



Double-Acting Long Stroke Cylinders

▼ QUICK SELECTION CHART

For complete technical information see next page.

Cylinder Capacity (tons)	Stroke (in)	Model Number	Cylinder Effective Area (in ²)		Oil Capacity (in ³)		Collap. Height (in)
			Push	Pull	Push	Pull	
			10	10.00	RR-1010*	2.23	
	12.00	RR-1012*	2.23	.80	26.80	9.00	18.00
30	8.25	RR-308*	6.51	3.00	53.67	25.00	15.25
	14.50	RR-3014*	6.51	3.00	92.70	43.00	21.63
50	6.13	RR-506	11.06	3.40	67.77	21.00	13.06
	13.13	RR-5013	11.06	3.40	145.17	44.00	20.06
	20.13	RR-5020	11.06	3.40	222.56	68.00	28.88
75	6.13	RR-756	15.92	4.90	97.58	29.00	13.69
	13.13	RR-7513	15.92	4.90	209.00	64.00	20.69
100	6.63	RR-1006	20.65	9.60	136.93	63.00	14.06
	13.13	RR-10013	20.65	9.60	271.17	126.00	20.63
	18.13	RR-10018	20.65	9.60	374.44	174.00	27.06
150	2.25	RR-1502	30.71	14.80	69.11	33.00	7.72
	6.13	RR-1506	30.71	14.80	188.28	91.00	15.19
	13.13	RR-15013	30.71	14.80	403.27	194.00	22.20
	32.13	RR-15032	30.71	14.80	986.84	475.00	43.94
200	6.00	RR-2006	44.21	22.50	265.28	135.00	16.94
	13.00	RR-20013	44.21	22.50	574.78	293.00	23.94
	18.00	RR-20018	44.21	22.50	795.85	396.00	30.13
	24.00	RR-20024	44.21	22.50	1,061	528.00	36.13
	36.00	RR-20036	44.21	22.50	1,592	792.00	48.13
300	48.00	RR-20048	44.21	22.50	2,122	1,056	60.13
	6.00	RR-3006	70.93	38.00	425.56	228.00	19.13
	12.00	RR-30012	70.93	38.00	851.12	456.00	25.13
	18.00	RR-30018	70.93	38.00	1,277	684.00	31.13
	24.00	RR-30024	70.93	38.00	1,702	912.00	37.13
400	36.00	RR-30036	70.93	38.00	2,553	1,368	49.13
	48.00	RR-30048	70.93	38.00	3,405	1,824	61.13
	6.00	RR-4006	95.09	51.00	570.51	306.00	21.19
	12.00	RR-40012	95.09	51.00	1,141	612.00	27.19
	18.00	RR-40018	95.09	51.00	1,712	918.00	33.19
500	24.00	RR-40024	95.09	51.00	2,282	1,224	39.19
	36.00	RR-40036	95.09	51.00	3,423	1,836	51.19
	48.00	RR-40048	95.09	51.00	4,564	2,448	63.19
	6.00	RR-5006	113.15	63.00	678	378.00	22.75
	12.00	RR-50012	113.15	63.00	1,358	756.00	28.75
500	18.00	RR-50018	113.15	63.00	2,037	1,134	34.75
	24.00	RR-50024	113.15	63.00	2,716	1,512	40.75
	36.00	RR-50036	113.15	63.00	4,074	2,264	52.75
	48.00	RR-50048	113.15	63.00	5,431	3,024	64.75

RR Series



Capacity:
10-500 tons

Stroke:
2.25-48.00 inches

Maximum Operating Pressure:
10,000 psi



Energac CLRG-Series

If you do not have a high cycle application, Energac **CLRG-Series** cylinders may be the right alternative.

Page: 40



Speed Chart

See the Energac Cylinder Speed Chart in our "Yellow Pages" to determine your approximate cylinder speed.

Page: 251



Optional Snap-in Saddles

Optional snap-in saddles for RR-Series double-acting cylinders:

Saddle Type	Cylinder Model Number	Saddle Model Number
Flat	RR-1010, 1012	A-102F
	RR-1010, 1012	CAT-10
Tilt	RR-308, 3014	CAT-50
	RR-506, 5013	CAT-100
	RR-5020, 756	
	RR-7513	

Standard Saddles

Grooved	RR-1010, 1012	A-102G
	RR-308, 3014	A-252G

For additional information on saddles:

Page: 10

RR-Series, Double-Acting Cylinders

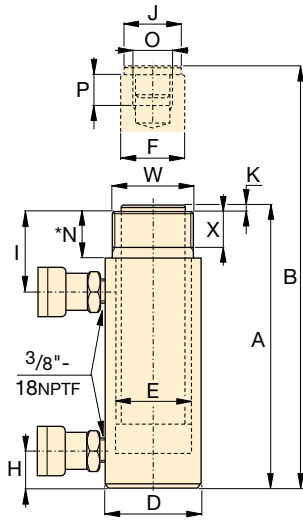

RR-1010 to RR-3014 models

* For RR-1010 and RR-1012:
N = 1.26 inch; for RR-308 and
RR-3014: N = 2.20 inch.

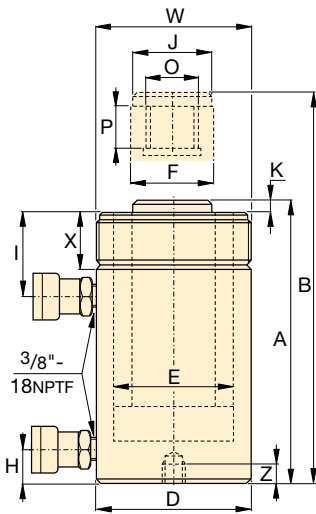

RR-506 to RR-50048 models

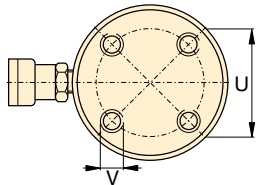

RR-1006 to RR-30048

No mounting holes:
RR-506, 5013
RR-756, 7513
RR-1502, 15032



Cylinder retract capacity for certain RR cylinders may be less than theoretical values, as a result of reduced relief valve pressure settings:

RR-308/3014: 4000 psi
RR-506/5013/5020: 6950 psi
RR-756/7513: 7200 psi

◀ For full features see page 32.

Cylinder Capacity (ton)	Stroke (in)	Model Number	Max. Cylinder Capacity (tons)		Cylinder Effective Area (in ²)		Oil Capacity (in ³)		Collap. Height A (in)	Ext. Height B (in)	Outside Diam. D (in)
			Push	Pull	Push	Pull	Push	Pull			
10	10.00	RR-1010*	11.1	4.0	2.23	.80	22.33	8.00	16.13	26.13	2.88
	12.00	RR-1012*	11.1	4.0	2.23	.80	26.80	9.00	18.00	30.00	2.88
30	8.25	RR-308*	32.5	6.0	6.51	3.00	53.67	25.00	15.25	23.50	4.00
	14.50	RR-3014*	32.5	6.0	6.51	3.00	92.70	43.00	21.63	36.13	4.00
50	6.13	RR-506	55.3	11.8	11.06	3.40	67.77	21.00	13.06	19.19	5.00
	13.13	RR-5013	55.3	11.8	11.06	3.40	145.17	44.00	20.06	33.19	5.00
	20.13	RR-5020	55.3	11.8	11.06	3.40	222.56	68.00	28.88	49.00	5.00
75	6.13	RR-756	79.6	17.6	15.92	4.90	97.58	29.00	13.69	19.81	5.75
	13.13	RR-7513	79.6	17.6	15.92	4.90	209.00	64.00	20.69	33.81	5.75
100	6.63	RR-1006	103.2	48.0	20.65	9.60	136.93	63.00	14.06	20.69	7.00
	13.13	RR-10013	103.2	48.0	20.65	9.60	271.17	126.00	20.63	33.75	7.00
	18.13	RR-10018	103.2	48.0	20.65	9.60	374.44	174.00	27.06	45.19	7.00
150	2.25	RR-1502	153.5	74.0	30.71	14.80	69.11	33.00	7.19	9.44	8.00
	6.13	RR-1506	153.5	74.0	30.71	14.80	188.28	91.00	15.19	21.31	8.00
	13.13	RR-15013	153.5	74.0	30.71	14.80	403.27	194.00	22.20	35.31	8.00
	32.13	RR-15032	153.5	74.0	30.71	14.80	986.84	475.00	43.94	76.06	8.00
200	6.00	RR-2006	221.0	112.5	44.21	22.50	265.28	135.00	16.94	22.94	9.75
	13.00	RR-20013	221.0	112.5	44.21	22.50	574.78	293.00	23.94	36.94	9.75
	18.00	RR-20018	221.0	112.5	44.21	22.50	795.85	396.00	30.13	48.13	9.75
	24.00	RR-20024	221.0	112.5	44.21	22.50	1,061	528.00	36.13	60.13	9.75
	36.00	RR-20036	221.0	112.5	44.21	22.50	1,592	792.00	48.13	84.13	9.75
300	48.00	RR-20048	221.0	112.5	44.21	22.50	2,122	1,056	60.13	108.13	9.75
	6.00	RR-3006	354.6	190.0	70.93	38.00	425.56	228.00	19.13	25.13	12.25
	12.00	RR-30012	354.6	190.0	70.93	38.00	851.12	456.00	25.13	37.13	12.25
	18.00	RR-30018	354.6	190.0	70.93	38.00	1,277	684.00	31.13	49.13	12.25
	24.00	RR-30024	354.6	190.0	70.93	38.00	1,702	912.00	37.13	61.13	12.25
400	36.00	RR-30036	354.6	190.0	70.93	38.00	2,553	1368	49.13	85.13	12.25
	48.00	RR-30048	354.6	190.0	70.93	38.00	3,405	1824	61.13	109.13	12.25
	6.00	RR-4006	475.4	255.0	95.09	51.00	570.51	306.00	21.19	27.19	14.13
	12.00	RR-40012	475.4	255.0	95.09	51.00	1,141	612.00	27.19	39.19	14.13
	18.00	RR-40018	475.4	255.0	95.09	51.00	1,712	918.00	33.19	51.19	14.13
500	24.00	RR-40024	475.4	255.0	95.09	51.00	2,282	1224	39.19	63.19	14.13
	36.00	RR-40036	475.4	255.0	95.09	51.00	3,423	1836	51.19	87.19	14.13
	48.00	RR-40048	475.4	255.0	95.09	51.00	4,564	2448	63.19	111.19	14.13
	6.00	RR-5006	565.7	315.0	113.15	63.00	678.92	378.00	22.75	28.75	15.63
	12.00	RR-50012	565.7	315.0	113.15	63.00	1,358	756.00	28.75	40.75	15.63
500	18.00	RR-50018	565.7	315.0	113.15	63.00	2,037	1134	34.75	52.75	15.63
	24.00	RR-50024	565.7	315.0	113.15	63.00	2,716	1512	40.75	64.75	15.63
	36.00	RR-50036	565.7	315.0	113.15	63.00	4,074	2268	52.75	88.75	15.63
48.00	RR-50048	565.7	315.0	113.15	63.00	5,431	3024	64.75	112.75	15.63	

* For RR-1010 and RR-1012: N = 1.26 inch; for RR-308 and RR-3014: N = 2.20 inch.

Double-Acting Long Stroke Cylinders

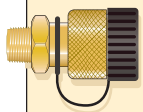

Couplers Included!
CR-400 couplers included on all models. Fits all HC-Series hoses.

Capacity:
10-500 tons

Stroke:
2.25-48.00 inches

Maximum Operating Pressure:
10,000 psi

RR Series



Cylinder Bore Diameter	Plunger Diameter	Base to Adv. Port	Top to Return Port	Saddle Diameter	Saddle Protrusion from Plngr.	Plunger Internal Thread	Plunger Thread Length	Base Mounting Holes			Collar Thread	Collar Thread Length	Weight (lbs)	Model Number
								Bolt Cir. Diam. U (in)	Thread V (in)	Thread Depth Z (in)				
E (in)	F (in)	H (in)	I (in)	J (in)	K (in)	O (in)	P (in)	U (in)	V (in)	Z (in)	W (in)	X (in)		
1.69	1.38	1.44	2.25	1.38	.24	1-8	1.00	-	-	-	2 1/4-14	1.06	28	RR-1010*
1.69	1.38	1.44	2.25	1.38	.24	1-8	1.00	-	-	-	2 1/4-14	1.06	31	RR-1012*
2.88	2.13	1.44	3.19	2.00	.41	1 1/2-16	1.00	-	-	-	3 5/16-12	1.94	40	RR-308*
2.88	2.13	1.56	3.19	2.00	.41	1 1/2-16	1.00	-	-	-	3 5/16-12	1.94	64	RR-3014*
3.75	3.13	1.13	3.00	2.81	.11	1-12	1.00	-	-	-	5-12	2.00	67	RR-506
3.75	3.13	1.13	3.00	2.81	.11	1-12	1.00	-	-	-	5-12	2.00	115	RR-5013
3.75	3.13	2.25	3.00	2.81	.11	1-12	1.00	3.00	-	-	5-12	2.00	150	RR-5020
4.50	3.75	1.19	3.00	2.81	.25	1-12	1.50	-	-	-	5 3/4-12	1.50	92	RR-756
4.50	3.75	1.19	3.19	2.81	.25	1-12	1.50	-	-	-	5 3/4-12	1.50	150	RR-7513
5.13	3.75	1.50	2.81	3.00	.13	1 3/4-12	1.38	5.50	3/4-10	1.00	6 7/8-12	2.00	135	RR-1006
5.13	3.75	1.50	2.81	3.00	.13	1 3/4-12	1.38	5.50	3/4-10	1.00	6 7/8-12	2.00	205	RR-10013
5.13	3.75	1.63	3.63	3.00	.13	1 3/4-12	1.38	5.50	3/4-10	1.00	6 7/8-12	2.00	260	RR-10018
6.25	4.50	.88	2.63	3.67	.06	-	-	-	-	-	-	-	110	RR-1502
6.25	4.50	1.94	3.31	4.49	.75	3 3/8-16	1.38	6.25	3/4-16	1.00	8-12	2.36	205	RR-1506
6.25	4.50	1.94	3.31	4.49	.75	3 3/8-16	1.38	6.25	3/4-16	1.00	8-12	2.36	275	RR-15013
6.25	4.50	3.31	3.31	4.49	.75	3 3/8-16	1.38	-	-	-	8-12	2.36	525	RR-15032
7.50	5.25	2.25	3.81	5.25	.88	-	-	5.00	1-8	1.00	-	-	325	RR-2006
7.50	5.25	2.25	3.81	5.25	.88	2 1/2-12	2.50	5.00	1-8	1.00	9 3/4-12	2.13	440	RR-20013
7.50	5.25	3.38	4.00	5.25	.88	2 1/2-12	2.50	5.00	1-8	1.00	9 3/4-12	2.13	450	RR-20018
7.50	5.25	3.38	4.00	5.25	.88	2 1/2-12	2.50	5.00	1-8	1.00	9 3/4-12	2.13	616	RR-20024
7.50	5.25	3.38	4.00	5.25	.88	2 1/2-12	2.50	5.00	1-8	1.00	9 3/4-12	2.13	845	RR-20036
7.50	5.25	3.38	4.00	5.25	.88	2 1/2-12	2.50	5.00	1-8	1.00	9 3/4-12	2.13	1065	RR-20048
9.50	6.50	3.50	4.50	6.50	1.13	2 1/2-12	3.25	6.25	1 1/4-7	1.75	12 1/4-12	2.31	441	RR-3006
9.50	6.50	3.50	4.50	6.50	1.13	2 1/2-12	3.25	6.25	1 1/4-7	1.75	12 1/4-12	2.31	608	RR-30012
9.50	6.50	3.50	4.50	6.50	1.13	2 1/2-12	3.25	6.25	1 1/4-7	1.75	12 1/4-12	2.31	776	RR-30018
9.50	6.50	3.50	4.50	6.50	1.13	2 1/2-12	3.25	6.25	1 1/4-7	1.75	12 1/4-12	2.31	1034	RR-30024
9.50	6.50	3.50	4.50	6.50	1.13	2 1/2-12	3.25	6.25	1 1/4-7	1.75	12 1/4-12	2.31	1385	RR-30036
9.50	6.50	3.50	4.50	6.50	1.13	2 1/2-12	3.25	6.25	1 1/4-7	1.75	12 1/4-12	2.31	1720	RR-30048
11.00	7.50	4.25	5.25	7.50	1.13	3-12	3.75	8.00	1 1/2-6	2.00	14 1/8-8	2.56	670	RR-4006
11.00	7.50	4.25	5.25	7.50	1.13	3-12	3.75	8.00	1 1/2-6	2.00	14 1/8-8	2.56	880	RR-40012
11.00	7.50	4.25	5.25	7.50	1.13	3-12	3.75	8.00	1 1/2-6	2.00	14 1/8-8	2.56	1000	RR-40018
11.00	7.50	4.25	5.25	7.50	1.13	3-12	3.75	8.00	1 1/2-6	2.00	14 1/8-8	2.56	1317	RR-40024
11.00	7.50	4.25	5.25	7.50	1.13	3-12	3.75	8.00	1 1/2-6	2.00	14 1/8-8	2.56	1746	RR-40036
11.00	7.50	4.25	5.25	7.50	1.13	3-12	3.75	8.00	1 1/2-6	2.00	14 1/8-8	2.56	2162	RR-40048
12.00	8.00	4.75	6.00	8.00	1.13	3 1/4-12	4.25	8.00	1 3/4-5	2.12	15 5/8-8	3.13	953	RR-5006
12.00	8.00	4.75	6.00	8.00	1.13	3 1/4-12	4.25	8.00	1 3/4-5	2.12	15 5/8-8	3.13	1300	RR-50012
12.00	8.00	4.75	6.00	8.00	1.13	3 1/4-12	4.25	8.00	1 3/4-5	2.12	15 5/8-8	3.13	1500	RR-50018
12.00	8.00	4.75	6.00	8.00	1.13	3 1/4-12	4.25	8.00	1 3/4-5	2.12	15 5/8-8	3.13	1800	RR-50024
12.00	8.00	4.75	6.00	8.00	1.13	3 1/4-12	4.25	8.00	1 3/4-5	2.12	15 5/8-8	3.13	2210	RR-50036
12.00	8.00	4.75	6.00	8.00	1.13	3 1/4-12	4.25	8.00	1 3/4-5	2.12	15 5/8-8	3.13	2700	RR-50048

▼ Shown from left to right: CLSG-1506, CLSG-2006, CLSG-506



- Integral stop ring provides piston blow-out protection
- Baked enamel outside finish and plated pistons provide superior corrosion protection
- Base mounting holes standard on all models
- Plunger wiper reduces contamination, extending cylinder life
- Single-acting load return

▼ Eight CLSG-2506 cylinders equipped with tilting saddles lifted the planking of the bridge as the pier heads were being rebuilt.



The Single-Acting Heavy Lifting Solution with Integral Stop Ring



Saddles

All **CLSG-Series** cylinders are equipped with bolt-on removable grooved saddles.

For information on optional tilt saddles, see selection chart.

Page: 39



Gauges

Minimize the risk of overloading and ensure long, dependable service from your equipment. Refer to

the **System Components** section for a full range of gauges.

Page: 113



Optimum Performance

Enerpac's range of **Z-Class** electric pumps, fitted with manual or solenoid operated 3-way valves, offer optimum combinations with CLSG cylinders.

Page: 76



Low Height - High Tonnage

When low height with high force is required, **CLP-Series** Pancake Cylinders with lock nut offer the solution to lift the first few inches.

Page: 20

Single-Acting, High Tonnage Cylinders

▼ QUICK SELECTION CHART

For complete technical information see next page.

Cylinder Capacity (ton) [maximum]	Stroke (in)	Model Number	Cylinder Effective Area (in ²)	Oil Capacity (in ³)	Collapsed Height (in)	Weight (lbs)
50 [59.1]	1.97	CLSG-502	11.81	23.25	6.38	37
	3.94	CLSG-504	11.81	46.50	8.35	44
	5.91	CLSG-506	11.81	69.75	10.31	51
	7.87	CLSG-508	11.81	93.00	12.28	60
	9.84	CLSG-5010	11.81	116.25	14.25	68
	11.81	CLSG-5012	11.81	139.50	16.22	75
100 [102.9]	1.97	CLSG-1002	20.57	40.50	7.16	42
	3.94	CLSG-1004	20.57	81.00	9.13	64
	5.91	CLSG-1006	20.57	121.50	11.09	88
	7.87	CLSG-1008	20.57	162.00	13.06	110
	9.84	CLSG-10010	20.57	202.50	15.03	134
	11.81	CLSG-10012	20.57	242.99	17.00	157
150 [153.9]	1.97	CLSG-1502	30.78	60.58	7.72	86
	3.94	CLSG-1504	30.78	121.17	9.69	115
	5.91	CLSG-1506	30.78	181.75	11.65	143
	7.87	CLSG-1508	30.78	242.33	13.62	172
	9.84	CLSG-15010	30.78	302.92	15.59	203
	11.81	CLSG-15012	30.78	363.50	17.56	231
200 [206.1]	1.97	CLSG-2002	41.22	81.13	8.50	121
	5.91	CLSG-2006	41.22	243.40	12.44	201
	11.81	CLSG-20012	41.22	486.79	18.35	322
250 [284.0]	1.97	CLSG-2502	56.80	111.81	9.25	196
	5.91	CLSG-2506	56.80	335.42	13.19	300
	11.81	CLSG-25012	56.80	670.84	19.09	456
300 [353.6]	1.97	CLSG-3002	70.71	139.19	12.28	406
	5.91	CLSG-3006	70.71	417.56	16.22	511
	11.81	CLSG-30012	70.71	835.11	22.13	668
400 [433.9]	1.97	CLSG-4002	86.78	170.84	14.74	595
	5.91	CLSG-4006	86.78	512.51	18.68	728
	11.81	CLSG-40012	86.78	1025.02	24.59	928
500 [566.3]	1.97	CLSG-5002	113.25	222.92	16.50	884
	5.91	CLSG-5006	113.25	668.77	20.43	1058
	11.81	CLSG-50012	113.25	1337.55	26.34	1321
600 [662.9]	1.97	CLSG-6002	132.57	260.97	16.89	1045
	5.91	CLSG-6006	132.57	782.90	20.83	1246
	11.81	CLSG-60012	132.57	1565.81	26.73	1545
800 [911.6]	1.97	CLSG-8002	182.32	358.91	18.66	1634
	5.91	CLSG-8006	182.32	10776.72	22.60	1941
	11.81	CLSG-80012	182.32	2153.44	28.50	2332
1000 [1136]	1.97	CLSG-10002	227.19	447.23	22.20	2341
	5.91	CLSG-10006	227.19	1341.68	26.14	2674
	11.81	CLSG-100012	227.19	2683.35	32.05	3172

CLSG Series



Capacity:
50-1,000 tons

Stroke:
1.97-11.81 inches

Maximum Operating Pressure:
10,000 psi



Standard Features

- Interchangeable, hardened grooved saddles
- CR-400 Coupler and dust cap
- Top and side mount lifting eye capability
- All cylinders meet ASME B-30.1 and ISO 10100 Standards



Additional Stroke Lengths

Models above 150 tons are also available with standard stroke lengths of 4, 8 and 10 inches. Please contact Enerpac for ordering information and dimensional details.



Lifting an Unbalanced Load

When lifting an unbalanced load **Enerpac Synchronous Lift Systems** can be the solution with multiple lift point capabilities from 4 to 64 points. See our "Yellow Pages" for multi-cylinder set-ups.

CLSG-Series, High Tonnage Cylinders



Mounting Hole Orientation

Top mounting hole orientation is maintained to port location. Base mounting hole orientation is not maintained to port location.

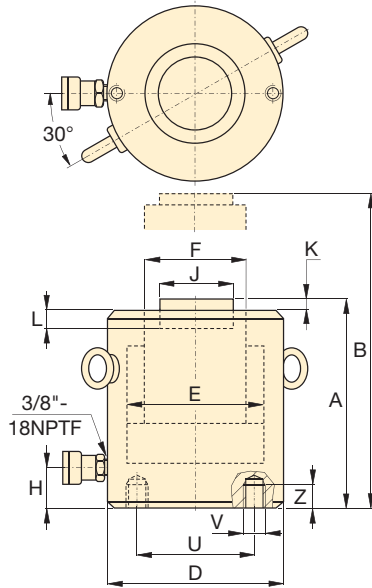

CLSG-50 to CLSG-150 models

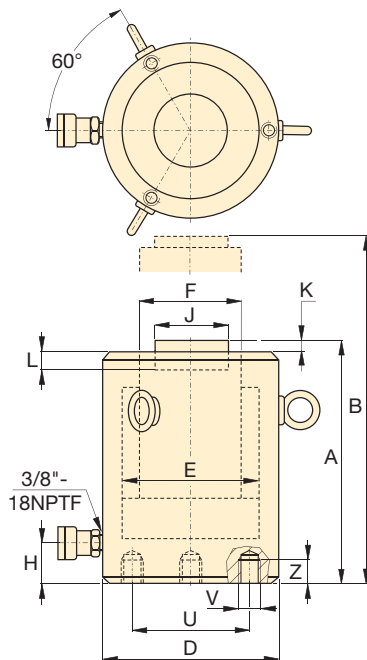

CLSG-200 to CLSG-1000 models

◀ For full features see page 36.

Cylinder Capacity (ton) [maximum]	Stroke (in)	Model Number	Cylinder Effective Area (in ²)	Oil Capacity (in ³)	Collapsed Height A (in)	Extended Height B (in)	Outside Diam. D (in)
50 [59.1]	1.97	CLSG-502	11.81	23.25	6.38	8.35	5.12
	3.94	CLSG-504	11.81	46.50	8.35	12.28	5.12
	5.91	CLSG-506	11.81	69.75	10.31	16.22	5.12
	7.87	CLSG-508	11.81	93.00	12.28	20.16	5.12
	9.84	CLSG-5010	11.81	116.25	14.25	24.09	5.12
100 [102.9]	1.97	CLSG-1002	20.57	40.50	7.16	9.13	6.50
	3.94	CLSG-1004	20.57	81.00	9.13	13.06	6.50
	5.91	CLSG-1006	20.57	121.50	11.09	17.00	6.50
	7.87	CLSG-1008	20.57	162.00	13.06	20.94	6.50
	9.84	CLSG-10010	20.57	202.50	15.03	24.87	6.50
150 [153.9]	1.97	CLSG-1502	30.78	60.58	7.72	9.69	8.07
	3.94	CLSG-1504	30.78	121.17	9.69	13.62	8.07
	5.91	CLSG-1506	30.78	181.75	11.65	17.56	8.07
	7.87	CLSG-1508	30.78	242.33	13.62	21.50	8.07
	9.84	CLSG-15010	30.78	302.92	15.59	25.43	8.07
200 [206.1]	1.97	CLSG-2002	41.22	81.13	8.50	10.47	9.25
	5.91	CLSG-2006	41.22	243.40	12.44	18.35	9.25
	11.81	CLSG-20012	41.22	486.79	18.35	30.16	9.25
	1.97	CLSG-2502	56.80	111.81	9.25	11.22	10.83
	5.91	CLSG-2506	56.80	335.42	13.19	19.09	10.83
250 [284.0]	11.81	CLSG-25012	56.80	670.84	19.09	30.91	10.83
	1.97	CLSG-3002	70.71	139.19	12.28	14.25	12.20
	5.91	CLSG-3006	70.71	417.56	16.22	22.13	12.20
300 [353.6]	11.81	CLSG-30012	70.71	835.11	22.13	33.94	12.20
	1.97	CLSG-4002	86.78	170.84	14.74	16.71	13.78
400 [433.9]	5.91	CLSG-4006	86.78	512.51	18.68	24.59	13.78
	11.81	CLSG-40012	86.78	1025.02	24.59	36.40	13.78
	1.97	CLSG-5002	113.25	222.92	16.50	18.46	15.75
500 [566.3]	5.91	CLSG-5006	113.25	668.77	20.43	26.34	15.75
	11.81	CLSG-50012	113.25	1337.55	26.34	38.15	15.75
600 [662.9]	1.97	CLSG-6002	132.57	260.97	16.89	18.86	16.93
	5.91	CLSG-6006	132.57	782.90	20.83	26.73	16.93
	11.81	CLSG-60012	132.57	1565.81	26.73	38.54	16.93
800 [911.6]	1.97	CLSG-8002	182.32	358.91	18.66	20.63	19.88
	5.91	CLSG-8006	182.32	1076.72	22.60	28.50	19.88
	11.81	CLSG-80012	182.32	2153.44	28.50	40.31	19.88
1000 [1136]	1.97	CLSG-10002	227.19	447.23	22.20	24.17	22.05
	5.91	CLSG-10006	227.19	1341.68	26.14	32.05	22.05
	11.81	CLSG-100012	227.19	2683.35	32.05	43.86	22.05

Single-Acting, High Tonnage Cylinders

Optional Tilt Saddle *

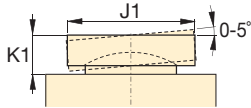

Capacity:
50-1,000 tons

Stroke:
1.97-11.81 inches

Maximum Operating Pressure:
10,000 psi

CLSG
Series



Cylinder Bore Diam.	Plunger Diam.	Base to Advance Port	Standard Saddle Diam.	Saddle Protrusion from Plngr.	Depth of Plunger Hole	Base Mounting Holes			Weight (lbs)	Model Number	* Optional Tilt Saddle		
						Bolt Cir. Diam.	Thread	Thread Depth			Diam.	Height	Model Number
E (in)	F (in)	H (in)	J (in)	K (in)	L (in)	U (in)	V (mm)	Z (in)		J1 (in)	K1 (in)		
3.88	2.76	2.05	1.97	.04	.75	2.56	M12	.87	37	CLSG-502	1.95	.94	CATG-50
3.88	2.76	2.05	1.97	.04	.75	2.56	M12	.87	44	CLSG-504	1.95	.94	CATG-50
3.88	2.76	2.05	1.97	.04	.75	2.56	M12	.87	51	CLSG-506	1.95	.94	CATG-50
3.88	2.76	2.05	1.97	.04	.75	2.56	M12	.87	60	CLSG-508	1.95	.94	CATG-50
3.88	2.76	2.05	1.97	.04	.75	2.56	M12	.87	68	CLSG-5010	1.95	.94	CATG-50
3.88	2.76	2.05	1.97	.04	.75	2.56	M12	.87	75	CLSG-5012	1.95	.94	CATG-50
5.12	3.74	2.13	2.95	.04	.75	3.74	M12	.87	42	CLSG-1002	2.87	1.14	CATG-100
5.12	3.74	2.13	2.95	.04	.75	3.74	M12	.87	64	CLSG-1004	2.87	1.14	CATG-100
5.12	3.74	2.13	2.95	.04	.75	3.74	M12	.87	88	CLSG-1006	2.87	1.14	CATG-100
5.12	3.74	2.13	2.95	.04	.75	3.74	M12	.87	110	CLSG-1008	2.87	1.14	CATG-100
5.12	3.74	2.13	2.95	.04	.75	3.74	M12	.87	134	CLSG-10010	2.87	1.14	CATG-100
5.12	3.74	2.13	2.95	.04	.75	3.74	M12	.87	157	CLSG-10012	2.87	1.14	CATG-100
6.26	4.49	2.40	3.70	.04	.75	5.12	M12	.87	86	CLSG-1502	3.57	1.22	CATG-150
6.26	4.49	2.40	3.70	.04	.75	5.12	M12	.87	115	CLSG-1504	3.57	1.22	CATG-150
6.26	4.49	2.40	3.70	.04	.75	5.12	M12	.87	143	CLSG-1506	3.57	1.22	CATG-150
6.26	4.49	2.40	3.70	.04	.75	5.12	M12	.87	172	CLSG-1508	3.57	1.22	CATG-150
6.26	4.49	2.40	3.70	.04	.75	5.12	M12	.87	203	CLSG-15010	3.57	1.22	CATG-150
6.26	4.49	2.40	3.70	.04	.75	5.12	M12	.87	231	CLSG-15012	3.57	1.22	CATG-150
7.24	5.24	2.62	4.45	.04	.94	6.50	M12	.87	121	CLSG-2002	4.64	1.37	CATG-200
7.24	5.24	2.62	4.45	.04	.94	6.50	M12	.87	201	CLSG-2006	4.64	1.37	CATG-200
7.24	5.24	2.62	4.45	.04	.94	6.50	M12	.87	322	CLSG-20012	4.64	1.37	CATG-200
8.50	6.50	2.87	5.71	.04	.94	7.48	M12	.87	196	CLSG-2502	5.67	1.81	CATG-250
8.50	6.50	2.87	5.71	.04	.94	7.48	M12	.87	300	CLSG-2506	5.67	1.81	CATG-250
8.50	6.50	2.87	5.71	.04	.94	7.48	M12	.87	456	CLSG-25012	5.67	1.81	CATG-250
9.49	7.76	3.98	6.97	.04	.75	7.09	M16	1.42	406	CLSG-3002	6.30	2.43	CATG-300
9.49	7.76	3.98	6.97	.04	.75	7.09	M16	1.42	511	CLSG-3006	6.30	2.43	CATG-300
9.49	7.76	3.98	6.97	.04	.75	7.09	M16	1.42	668	CLSG-30012	6.30	2.43	CATG-300
10.51	8.50	4.49	7.72	.12	1.06	8.07	M16	1.42	595	CLSG-4002	7.59	2.32	CATG-400
10.51	8.50	4.49	7.72	.12	1.06	8.07	M16	1.42	728	CLSG-4006	7.59	2.32	CATG-400
10.51	8.50	4.49	7.72	.12	1.06	8.07	M16	1.42	928	CLSG-40012	7.59	2.32	CATG-400
12.01	9.76	4.49	8.98	.12	1.06	9.84	M24	1.50	884	CLSG-5002	8.98	2.48	CATG-500
12.01	9.76	4.49	8.98	.12	1.06	9.84	M24	1.50	1058	CLSG-5006	8.98	2.48	CATG-500
12.01	9.76	4.49	8.98	.12	1.06	9.84	M24	1.50	1321	CLSG-50012	8.98	2.48	CATG-500
12.99	10.51	4.49	9.72	.12	1.06	10.83	M24	1.50	1045	CLSG-6002	9.47	3.08	CATG-600
12.99	10.51	4.49	9.72	.12	1.06	10.83	M24	1.50	1246	CLSG-6006	9.47	3.08	CATG-600
12.99	10.51	4.49	9.72	.12	1.06	10.83	M24	1.50	1545	CLSG-60012	9.47	3.08	CATG-600
15.24	12.48	5.87	11.69	.12	1.06	12.99	M24	1.50	1634	CLSG-8002	11.28	3.41	CATG-800
15.24	12.48	5.87	11.69	.12	1.06	12.99	M24	1.50	1914	CLSG-8006	11.28	3.41	CATG-800
15.24	12.48	5.87	11.69	.12	1.06	12.99	M24	1.50	2332	CLSG-80012	11.28	3.41	CATG-800
17.01	13.50	6.85	12.72	.12	1.06	14.76	M24	1.50	2341	CLSG-10002	12.26	3.65	CATG-1000
17.01	13.50	6.85	12.72	.12	1.06	14.76	M24	1.50	2674	CLSG-10006	12.26	3.65	CATG-1000
17.01	13.50	6.85	12.72	.12	1.06	14.76	M24	1.50	3172	CLSG-100012	12.26	3.65	CATG-1000

▼ Shown from left to right: CLRG-506, CLRG-2006, CLRG-1506



- Integral stop ring provides piston blow-out protection
- Double-acting for positive retraction
- Baked enamel outside finish and plated pistons provide superior corrosion resistance
- Safety valve in retract side of cylinder helps to prevent damage in case of accidental over-pressurization
- Interchangeable, hardened grooved saddles are standard
- Plunger wiper reduces contamination, extending cylinder life

▼ CLRG-Series cylinders supported and positioned these automobile deck elements.



Double-Acting Power Lifters



Saddles

All CLRG cylinders are equipped with bolt-on removable grooved saddles. For information on optional tilt saddles, see selection chart.

Page: 43



Safety Device

A pilot-operated check valve (V-42) can be inserted between cylinder ports.

This valve provides a safety lock on the cylinder under load at any position and remote control for unlocking.

Page: 129



Optimum Performance

Enerpac's range of Z-Class electric pumps, fitted with manual or solenoid operated 4-way valves, offer optimum combinations with CLRG cylinders.

Page: 76

▼ Replacing adjustment rolls under a fly-over with CLRG cylinders, for controlled lifting and lowering.



Double-Acting, High Tonnage Cylinders

▼ QUICK SELECTION CHART

For complete technical information see next page.

Cylinder Capacity (ton)	Stroke (in)	Model Number	Cylinder Effective Area (in ²)		Oil Capacity (in ³)		Collapsed Height (in)
			Push	Pull	Push	Pull	
			50	1.97	CLRG-502	11.81	
	3.94	CLRG-504	11.81	5.85	46.50	23.02	8.35
	5.91	CLRG-506	11.81	5.85	69.75	34.52	10.31
	7.87	CLRG-508	11.81	5.85	93.00	46.03	12.28
	9.84	CLRG-5010	11.81	5.85	116.25	57.54	14.25
	11.81	CLRG-5012	11.81	5.85	139.50	69.05	16.22
100	1.97	CLRG-1002	20.57	9.59	40.50	18.87	7.16
	3.94	CLRG-1004	20.57	9.59	81.00	37.74	9.13
	5.91	CLRG-1006	20.57	9.59	121.50	56.61	11.09
	7.87	CLRG-1008	20.57	9.59	162.00	75.49	13.06
	9.84	CLRG-10010	20.57	9.59	202.50	94.36	15.03
	11.81	CLRG-10012	20.57	9.59	242.99	113.23	17.00
150	1.97	CLRG-1502	30.78	14.96	60.58	29.44	7.72
	3.94	CLRG-1504	30.78	14.96	121.17	58.88	9.69
	5.91	CLRG-1506	30.78	14.96	181.75	88.32	11.65
	7.87	CLRG-1508	30.78	14.96	242.33	117.76	13.62
	9.84	CLRG-15010	30.78	14.96	302.92	147.20	15.59
	11.81	CLRG-15012	30.78	14.96	363.50	176.64	17.56
200	1.97	CLRG-2002	41.22	19.68	81.13	38.74	8.50
	5.91	CLRG-2006	41.22	19.68	243.40	116.23	12.44
	11.81	CLRG-20012	41.22	19.68	486.79	232.46	18.35
250	1.97	CLRG-2502	56.80	23.65	111.81	46.56	9.25
	5.91	CLRG-2506	56.80	23.65	335.42	139.69	13.19
	11.81	CLRG-25012	56.80	23.65	670.84	279.39	19.09
300	1.97	CLRG-3002	70.71	23.46	139.19	46.18	12.28
	5.91	CLRG-3006	70.71	23.46	417.56	138.55	16.22
	11.81	CLRG-30012	70.71	23.46	835.11	277.10	22.13
400	1.97	CLRG-4002	86.79	29.99	170.84	59.03	14.74
	5.91	CLRG-4006	86.79	29.99	512.51	177.09	18.68
	11.81	CLRG-40012	86.79	29.99	1,025	354.18	24.59
500	1.97	CLRG-5002	113.25	38.37	222.92	75.54	16.50
	5.91	CLRG-5006	113.25	38.37	668.77	226.61	20.43
	11.81	CLRG-50012	113.25	38.37	1,338	453.22	26.34
600	1.97	CLRG-6002	132.57	45.79	260.97	90.13	16.89
	5.91	CLRG-6006	132.57	45.79	782.90	270.39	20.83
	11.81	CLRG-60012	132.57	45.79	1,566	540.79	26.73
800	1.97	CLRG-8002	182.32	59.99	358.91	118.09	18.66
	5.91	CLRG-8006	182.32	59.99	1,077	354.28	22.60
	11.81	CLRG-80012	182.32	59.99	2,153	708.57	28.50
1000	1.97	CLRG-10002	227.19	83.97	447.23	165.29	22.20
	5.91	CLRG-10006	227.19	83.97	1,342	495.87	26.14
	11.81	CLRG-100012	227.19	83.97	2,683	991.75	32.05

CLRG Series



Capacity:
50-1,000 tons

Stroke:
1.97-11.81 inches

Maximum Operating Pressure:
10,000 psi



Standard Features

- Interchangeable, hardened grooved saddles
- CR-400 Coupler and dust cap
- Top and side mount lifting eye capability
- All cylinders meet ASME B-30.1 and ISO 10100 Standards



Pump Selection

A double-acting cylinder must be powered by a pump with a 4-way valve.

Page: 57



RR-Series

For higher cycle applications, Enerpac RR cylinders are a good alternative.

Page: 32



Additional Stroke Lengths

Models above 150 tons are also available with standard stroke lengths of 4, 8 and 10 inches. Please contact Enerpac for ordering information.

CLRG-Series, High Tonnage Cylinders

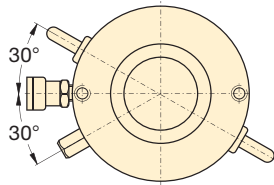

Mounting Hole Orientation

Top mounting hole orientation is maintained to port location. Base mounting hole orientation is not maintained to port location.

◀ For full features see page 40.

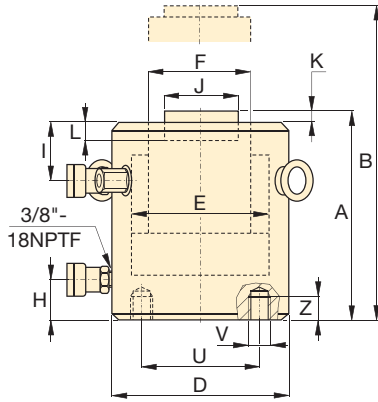

CLRG-50 to CLRG-150 models

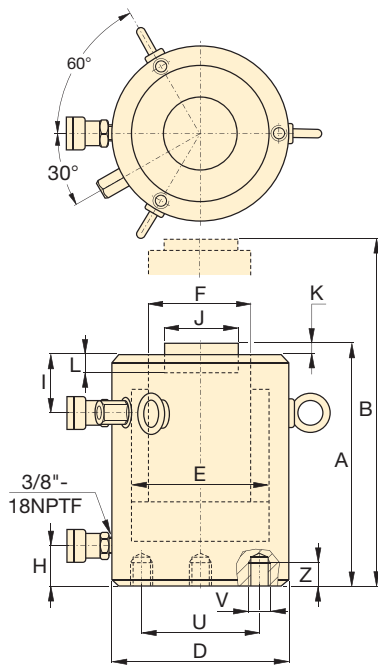

CLRG-200 to CLRG-1000 models

Base Mounting Hole Dimensions (in)			
Model / Capacity ton	Bolt Circle U	Thread Size V (mm)	Minimum Thread Depth Z
CLRG-50	2.56	M12	.87
CLRG-100	3.74	M12	.87
CLRG-150	5.12	M12	.87
CLRG-200	6.50	M12	.87
CLRG-250	7.48	M12	.87
CLRG-300	7.09	M16	1.42
CLRG-400	8.07	M16	1.42
CLRG-500	9.84	M24	1.50
CLRG-600	10.83	M24	1.50
CLRG-800	12.99	M24	1.50
CLRG-1000	14.76	M24	1.50

Cylinder Capacity (ton)	Stroke (in)	Model Number	Maximum Cylinder Capacity (ton)		Cylinder Effective Area (in ²)		Oil Capacity (in ³)	
			Push	Pull	Push	Pull	Push	Pull
50	1.97	CLRG-502	59.1	29	11.81	5.85	23.25	11.51
	3.94	CLRG-504	59.1	29	11.81	5.85	46.50	23.02
	5.91	CLRG-506	59.1	29	11.81	5.85	69.75	34.52
	7.87	CLRG-508	59.1	29	11.81	5.85	93.00	46.03
	9.84	CLRG-5010	59.1	29	11.81	5.85	116.25	57.54
11.81	CLRG-5012	59.1	29	11.81	5.85	139.50	69.05	
100	1.97	CLRG-1002	102.9	48	20.57	9.59	40.50	18.87
	3.94	CLRG-1004	102.9	48	20.57	9.59	81.00	37.74
	5.91	CLRG-1006	102.9	48	20.57	9.59	121.50	56.61
	7.87	CLRG-1008	102.9	48	20.57	9.59	162.00	75.49
	9.84	CLRG-10010	102.9	48	20.57	9.59	202.50	94.36
11.81	CLRG-10012	102.9	48	20.57	9.59	242.99	113.23	
150	1.97	CLRG-1502	153.9	75	30.78	14.96	60.58	29.44
	3.94	CLRG-1504	153.9	75	30.78	14.96	121.17	58.88
	5.91	CLRG-1506	153.9	75	30.78	14.96	181.75	88.32
	7.87	CLRG-1508	153.9	75	30.78	14.96	242.33	117.76
	9.84	CLRG-15010	153.9	75	30.78	14.96	302.92	147.20
11.81	CLRG-15012	153.9	75	30.78	14.96	363.50	176.64	
200	1.97	CLRG-2002	206.1	98	41.22	19.68	81.13	38.74
	5.91	CLRG-2006	206.1	98	41.22	19.68	243.40	116.23
	11.81	CLRG-20012	206.1	98	41.22	19.68	486.79	232.46
250	1.97	CLRG-2502	284.0	118	56.80	23.65	111.81	46.56
	5.91	CLRG-2506	284.0	118	56.80	23.65	335.42	139.69
	11.81	CLRG-25012	284.0	118	56.80	23.65	670.84	279.39
300	1.97	CLRG-3002	353.6	117	70.71	23.46	139.19	46.18
	5.91	CLRG-3006	353.6	117	70.71	23.46	417.56	138.55
	11.81	CLRG-30012	353.6	117	70.71	23.46	835.11	277.10
400	1.97	CLRG-4002	433.9	150	86.79	29.99	170.84	59.03
	5.91	CLRG-4006	433.9	150	86.79	29.99	512.51	177.09
	11.81	CLRG-40012	433.9	150	86.79	29.99	1,025	354.18
500	1.97	CLRG-5002	566.3	192	113.25	38.37	222.92	75.54
	5.91	CLRG-5006	566.3	192	113.25	38.37	668.77	226.61
	11.81	CLRG-50012	566.3	192	113.25	38.37	1,338	453.22
600	1.97	CLRG-6002	662.9	229	132.57	45.79	260.97	90.13
	5.91	CLRG-6006	662.9	229	132.57	45.79	782.90	270.39
	11.81	CLRG-60012	662.9	229	132.57	45.79	1,566	540.79
800	1.97	CLRG-8002	911.6	300	182.32	59.99	358.91	118.09
	5.91	CLRG-8006	911.6	300	182.32	59.99	1,077	354.28
	11.81	CLRG-80012	911.6	300	182.32	59.99	2,153	708.57
1000	1.97	CLRG-10002	1136	420	227.19	83.97	447.23	165.29
	5.91	CLRG-10006	1136	420	227.19	83.97	1,342	495.87
	11.81	CLRG-100012	1136	420	227.19	83.97	2,683	991.75

Double-Acting, High Tonnage Cylinders

* Optional Tilt Saddle

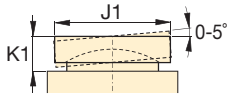

Capacity:

50-1,000 tons

Stroke:

1.97-11.81 inches

Maximum Operating Pressure:

10,000 psi

**CLRG
Series**



Collap. Height	Ext. Height	Outside Diam.	Cyl. Bore Diam.	Plunger Diam.	Base to Advance Port	Top to Retract Port	Standard Saddle Diam.	Saddle Protrusion from Plngr.	Depth of Plunger Hole	Weight (lbs)	Model Number	*Optional Tilt Saddle		
												Diam.	Height	Model Number
A (in)	B (in)	D (in)	E (in)	F (in)	H (in)	I (in)	J (in)	K (in)	L (in)		J1 (in)	K1 (in)		
6.38	8.35	5.12	3.88	2.76	1.65	1.29	1.97	.04	.75	37	CLRG-502	1.95	.94	CATG-50
8.35	12.28	5.12	3.88	2.76	1.65	1.29	1.97	.04	.75	44	CLRG-504	1.95	.94	CATG-50
10.31	16.22	5.12	3.88	2.76	1.65	1.29	1.97	.04	.75	51	CLRG-506	1.95	.94	CATG-50
12.28	20.16	5.12	3.88	2.76	1.65	1.29	1.97	.04	.75	60	CLRG-508	1.95	.94	CATG-50
14.25	24.09	5.12	3.88	2.76	1.65	1.29	1.97	.04	.75	68	CLRG-5010	1.95	.94	CATG-50
16.22	28.03	5.12	3.88	2.76	1.65	1.29	1.97	.04	.75	75	CLRG-5012	1.95	.94	CATG-50
7.16	9.13	6.50	5.12	3.74	2.13	1.89	2.95	.04	.75	42	CLRG-1002	2.87	1.14	CATG-100
9.13	13.06	6.50	5.12	3.74	2.13	1.89	2.95	.04	.75	64	CLRG-1004	2.87	1.14	CATG-100
11.09	17.00	6.50	5.12	3.74	2.13	1.89	2.95	.04	.75	88	CLRG-1006	2.87	1.14	CATG-100
13.06	20.94	6.50	5.12	3.74	2.13	1.89	2.95	.04	.75	110	CLRG-1008	2.87	1.14	CATG-100
15.03	24.87	6.50	5.12	3.74	2.13	1.89	2.95	.04	.75	134	CLRG-10010	2.87	1.14	CATG-100
17.00	28.81	6.50	5.12	3.74	2.13	1.89	2.95	.04	.75	157	CLRG-10012	2.87	1.14	CATG-100
7.72	9.69	8.07	6.26	4.49	2.40	2.22	3.70	.04	.75	86	CLRG-1502	3.57	1.22	CATG-150
9.69	13.62	8.07	6.26	4.49	2.40	2.22	3.70	.04	.75	115	CLRG-1504	3.57	1.22	CATG-150
11.65	17.56	8.07	6.26	4.49	2.40	2.22	3.70	.04	.75	143	CLRG-1506	3.57	1.22	CATG-150
13.62	21.50	8.07	6.26	4.49	2.40	2.22	3.70	.04	.75	172	CLRG-1508	3.57	1.22	CATG-150
15.59	25.43	8.07	6.26	4.49	2.40	2.22	3.70	.04	.75	203	CLRG-15010	3.57	1.22	CATG-150
17.56	29.37	8.07	6.26	4.49	2.40	2.22	3.70	.04	.75	231	CLRG-15012	3.57	1.22	CATG-150
8.50	10.47	9.25	7.24	5.24	2.62	2.22	4.45	.04	.94	121	CLRG-2002	4.64	1.37	CATG-200
12.44	18.35	9.25	7.24	5.24	2.62	2.22	4.45	.04	.94	201	CLRG-2006	4.64	1.37	CATG-200
18.35	30.16	9.25	7.24	5.24	2.62	2.22	4.45	.04	.94	322	CLRG-20012	4.64	1.37	CATG-200
9.25	11.22	10.83	8.50	6.50	2.87	3.07	5.71	.04	.94	196	CLRG-2502	5.67	1.81	CATG-250
13.19	19.09	10.83	8.50	6.50	2.87	3.07	5.71	.04	.94	300	CLRG-2506	5.67	1.81	CATG-250
19.09	30.91	10.83	8.50	6.50	2.87	3.07	5.71	.04	.94	456	CLRG-25012	5.67	1.81	CATG-250
12.68	14.25	12.20	9.49	7.76	3.98	2.95	6.97	.04	.75	406	CLRG-3002	6.30	2.43	CATG-300
16.22	22.13	12.20	9.49	7.76	3.98	2.95	6.97	.04	.75	511	CLRG-3006	6.30	2.43	CATG-300
22.13	33.94	12.20	9.49	7.76	3.98	2.95	6.97	.04	.75	668	CLRG-30012	6.30	2.43	CATG-300
14.74	16.71	13.78	10.51	8.50	4.49	4.13	7.72	.12	1.06	595	CLRG-4002	7.59	2.32	CATG-400
18.68	24.59	13.78	10.51	8.50	4.49	4.13	7.72	.12	1.06	728	CLRG-4006	7.59	2.32	CATG-400
24.59	36.40	13.78	10.51	8.50	4.49	4.13	7.72	.12	1.06	928	CLRG-40012	7.59	2.32	CATG-400
16.50	18.46	15.75	12.01	9.76	4.49	5.31	8.98	.12	1.06	884	CLRG-5002	8.98	2.48	CATG-500
20.43	26.34	15.75	12.01	9.76	4.49	5.31	8.98	.12	1.06	1058	CLRG-5006	8.98	2.48	CATG-500
26.34	38.15	15.75	12.01	9.76	4.49	5.31	8.98	.12	1.06	1321	CLRG-50012	8.98	2.48	CATG-500
16.89	18.86	16.93	12.99	10.51	4.49	5.31	9.72	.12	1.06	1045	CLRG-6002	9.47	3.08	CATG-600
20.83	26.73	16.93	12.99	10.51	4.49	5.31	9.72	.12	1.06	1246	CLRG-6006	9.47	3.08	CATG-600
26.73	38.54	16.93	12.99	10.51	4.49	5.31	9.72	.12	1.06	1545	CLRG-60012	9.47	3.08	CATG-600
18.66	20.63	19.88	15.24	12.48	5.87	5.31	11.69	.12	1.06	1634	CLRG-8002	11.28	3.41	CATG-800
22.60	28.50	19.88	15.24	12.48	5.87	5.31	11.69	.12	1.06	1914	CLRG-8006	11.28	3.41	CATG-800
28.50	40.31	19.88	15.24	12.48	5.87	5.31	11.69	.12	1.06	2332	CLRG-80012	11.28	3.41	CATG-800
22.20	24.17	22.05	17.01	13.50	6.85	6.69	12.72	.12	1.06	2341	CLRG-10002	12.26	3.65	CATG-1000
26.14	32.05	22.05	17.01	13.50	6.85	6.69	12.72	.12	1.06	2674	CLRG-10006	12.26	3.65	CATG-1000
32.05	43.86	22.05	17.01	13.50	6.85	6.69	12.72	.12	1.06	3172	CLRG-100012	12.26	3.65	CATG-1000

▼ Shown from left to right: CLL-1006, CLL-2506, CLL-1506, CLL-506



- Safety Lock Nut for mechanical load holding
- Baked enamel outside finish and plated pistons provide superior corrosion resistance
- Overflow port functions as a stroke limiter
- Interchangeable, hardened grooved saddles are standard
- CR-400 coupler and dust cap included on all models
- Single-acting load return

▼ For this curved bridge, CLL-Series cylinders were used to support the concrete beams to level the pierhead and to place 4000 ton slide bearings between pier and pierhead.



To Secure Loads Mechanically



Saddles

All CLL cylinders are equipped with bolt-on removable grooved saddles. For information on optional tilt saddles, see the selection chart.

Page: 47



Gauges

Minimize the risk of overloading and ensure long, dependable service from your equipment. Refer to the System Components section for a full range of gauges.

Page: 113



Low Height - High Tonnage

When low height with high force is required, pancake cylinders with lock nut offer the solution to lift the first few inches.

Page: 20

▼ CLL cylinder, mechanically locked, after positioning the curved bridge.



Single-Acting, Lock Nut Cylinders

▼ QUICK SELECTION CHART

For complete technical information see next page.

Cylinder Capacity	Stroke	Model Number	Cylinder Effective Area	Oil Capacity	Collapsed Height	Weight
(ton) [maximum]	(in)		(in ²)	(in ³)	(in)	(lbs)
50 [59.1]	1.97	CLL-502	10.99	21.63	6.46	35
	3.94	CLL-504	10.99	43.25	8.43	46
	5.91	CLL-506	10.99	64.88	10.39	57
	7.87	CLL-508	10.99	86.51	12.36	68
	9.84	CLL-5010	10.99	108.14	14.33	79
	11.81	CLL-5012	10.99	129.76	16.30	90
100 [102.9]	1.97	CLL-1002	20.57	40.50	7.36	68
	3.94	CLL-1004	20.57	81.00	9.33	87
	5.91	CLL-1006	20.57	121.50	11.30	106
	7.87	CLL-1008	20.57	162.00	13.27	125
	9.84	CLL-10010	20.57	202.50	15.24	143
	11.81	CLL-10012	20.57	242.99	17.20	162
150 [153.9]	1.97	CLL-1502	30.78	60.58	8.23	117
	3.94	CLL-1504	30.78	121.17	10.20	146
	5.91	CLL-1506	30.78	181.75	12.17	174
	7.87	CLL-1508	30.78	242.33	14.13	203
	9.84	CLL-15010	30.78	302.92	16.10	231
	11.81	CLL-15012	30.78	363.50	18.07	260
200 [206.1]	1.97	CLL-2002	41.17	81.04	9.57	183
	5.91	CLL-2006	41.17	243.13	13.50	260
	11.81	CLL-20012	41.17	486.27	19.41	376
250 [284.0]	1.97	CLL-2502	56.75	111.70	9.80	256
	5.91	CLL-2506	56.75	335.11	13.74	359
	11.81	CLL-25012	56.75	670.22	19.65	515
300 [353.6]	1.97	CLL-3002	70.71	139.19	11.61	382
	5.91	CLL-3006	70.71	417.56	15.55	514
	11.81	CLL-30012	70.71	835.11	21.46	712
400 [433.9]	1.97	CLL-4002	86.79	170.84	13.19	553
	5.91	CLL-4006	86.79	512.51	17.13	721
	11.81	CLL-40012	86.79	1025.02	23.03	972
500 [566.3]	1.97	CLL-5002	113.25	222.99	14.76	809
	5.91	CLL-5006	113.25	668.77	18.70	1029
	11.81	CLL-50012	113.25	1337.55	24.61	1360
600 [662.9]	1.97	CLL-6002	132.57	260.97	15.55	985
	5.91	CLL-6006	132.57	782.90	19.49	1241
	11.81	CLL-60012	132.57	1565.81	25.39	1625
800 [911.6]	1.97	CLL-8002	182.42	359.09	17.91	1565
	5.91	CLL-8006	182.42	1077.27	21.85	1918
	11.81	CLL-80012	182.42	2154.55	27.76	2446
1000 [1136]	1.97	CLL-10002	227.30	447.43	19.49	2094
	5.91	CLL-10006	227.30	1342.30	23.43	2517
	11.81	CLL-100012	227.30	2684.59	29.33	3151

CLL Series



Capacity:

50-1,000 tons

Stroke:

1.97-11.81 inches

Maximum Operating Pressure:

10,000 psi



Additional Stroke Lengths

Models above 150 tons are also available with standard stroke lengths of 4, 8 and 10 inches. Please contact

Enerpac for ordering information and dimensional details.



Lifting an Unbalanced Load?

See our "Yellow Pages" for multi-cylinder set ups.

Page: 242



Speed Chart

See the Enerpac Cylinder Speed Chart in our "Yellow Pages" section.

Page: 251

CLL-Series, Lock Nut Cylinders

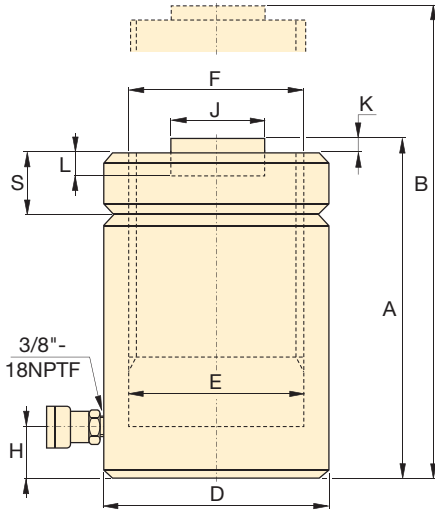
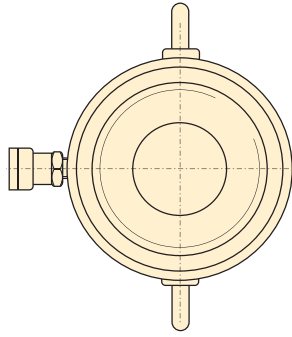

CLL-50 to CLL-250 models

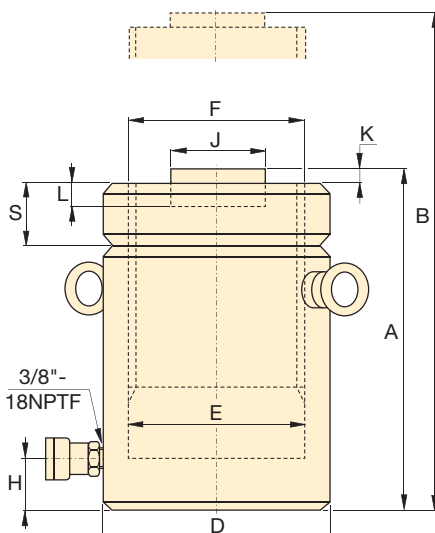
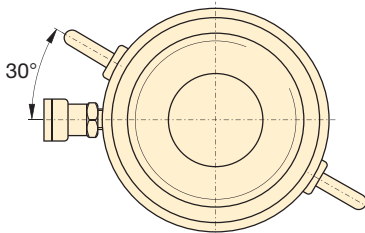

CLL-300 to CLL-1000 models

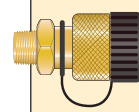

Coupler Included!

CR-400 coupler included on all models.
Fits all HC-Series hoses.

◀ For full features see page 44.

Cylinder Capacity (ton) [maximum]	Stroke (in)	Model Number	Cylinder Effective Area (in ²)	Oil Capacity (in ³)
50 [59.1]	1.97	CLL-502	10.99	21.63
	3.94	CLL-504	10.99	43.25
	5.91	CLL-506	10.99	64.88
	7.87	CLL-508	10.99	86.51
	9.84	CLL-5010	10.99	108.14
100 [102.9]	11.81	CLL-5012	10.99	129.76
	1.97	CLL-1002	20.57	40.50
	3.94	CLL-1004	20.57	81.00
	5.91	CLL-1006	20.57	121.50
	7.87	CLL-1008	20.57	162.00
150 [153.9]	9.84	CLL-10010	20.57	202.50
	11.81	CLL-10012	20.57	242.99
	1.97	CLL-1502	30.78	60.58
	3.94	CLL-1504	30.78	121.17
	5.91	CLL-1506	30.78	181.75
200 [206.1]	7.87	CLL-1508	30.78	242.33
	9.84	CLL-15010	30.78	302.92
	11.81	CLL-15012	30.78	363.50
	1.97	CLL-2002	41.17	81.04
	5.91	CLL-2006	41.17	243.13
250 [284.0]	11.81	CLL-20012	41.17	486.27
	1.97	CLL-2502	56.75	111.70
	5.91	CLL-2506	56.75	335.11
300 [353.6]	11.81	CLL-25012	56.75	670.22
	1.97	CLL-3002	70.71	139.19
	5.91	CLL-3006	70.71	417.56
400 [433.9]	11.81	CLL-30012	70.71	835.11
	1.97	CLL-4002	86.79	170.84
	5.91	CLL-4006	86.79	512.51
500 [566.3]	11.81	CLL-40012	86.79	1025.02
	1.97	CLL-5002	113.25	222.99
	5.91	CLL-5006	113.25	668.77
600 [662.9]	11.81	CLL-50012	113.25	1337.55
	1.97	CLL-6002	132.57	260.97
	5.91	CLL-6006	132.57	782.90
800 [911.6]	11.81	CLL-60012	132.57	1565.81
	1.97	CLL-8002	182.42	359.09
	5.91	CLL-8006	182.42	1077.27
1000 [1136]	11.81	CLL-80012	182.42	2154.55
	1.97	CLL-10002	227.30	447.43
	5.91	CLL-10006	227.30	1342.30
	11.81	CLL-100012	227.30	2684.59

Single-Acting, Lock Nut Cylinders

*Optional Tilt Saddle

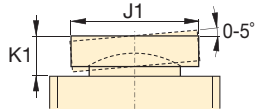

Capacity:

50-1,000 tons

Stroke:

1.97-11.81 inches

Maximum Operating Pressure:

10,000 psi

**CLL
Series**



Collap. Height	Ext. Height	Outside Diam.	Cyl. Bore Diam.	Plunger Diameter (threaded)	Base to Advance Port	Stand. Saddle Diam.	Saddle Protrusion from Plgr.	Depth of Plunger Hole	Lock Nut Height	Weight (lbs)	Model Number	* Optional Tilt Saddle		
												Diam. J1 (in)	Height K1 (in)	Model Number
A (in)	B (in)	D (in)	E (in)	F (mm)	H (in)	J (in)	K (in)	L (in)	S (in)			J1 (in)	K1 (in)	
6.46	8.43	4.92	3.74	Tr 95 x 4	1.18	2.80	.08	.51	1.42	35	CLL-502	2.80	.94	CAT-100
8.43	12.36	4.92	3.74	Tr 95 x 4	1.18	2.80	.08	.51	1.42	46	CLL-504	2.80	.94	CAT-100
10.39	16.30	4.92	3.74	Tr 95 x 4	1.18	2.80	.08	.51	1.42	57	CLL-506	2.80	.94	CAT-100
12.36	20.24	4.92	3.74	Tr 95 x 4	1.18	2.80	.08	.51	1.42	68	CLL-508	2.80	.94	CAT-100
14.33	24.17	4.92	3.74	Tr 95 x 4	1.18	2.80	.08	.51	1.42	79	CLL-5010	2.80	.94	CAT-100
16.30	28.11	4.92	3.74	Tr 95 x 4	1.18	2.80	.08	.51	1.42	90	CLL-5012	2.80	.94	CAT-100
7.36	9.33	6.50	5.12	Tr 130 x 6	1.18	2.80	.08	.51	1.73	68	CLL-1002	2.80	.94	CAT-100
9.33	13.27	6.50	5.12	Tr 130 x 6	1.18	2.80	.08	.51	1.73	87	CLL-1004	2.80	.94	CAT-100
11.30	17.20	6.50	5.12	Tr 130 x 6	1.18	2.80	.08	.51	1.73	106	CLL-1006	2.80	.94	CAT-100
13.27	21.14	6.50	5.12	Tr 130 x 6	1.18	2.80	.08	.51	1.73	125	CLL-1008	2.80	.94	CAT-100
15.24	25.08	6.50	5.12	Tr 130 x 6	1.18	2.80	.08	.51	1.73	143	CLL-10010	2.80	.94	CAT-100
17.20	29.02	6.50	5.12	Tr 130 x 6	1.18	2.80	.08	.51	1.73	162	CLL-10012	2.80	.94	CAT-100
8.23	10.20	8.07	6.26	Tr 159 x 6	1.54	5.12	.08	.98	1.73	117	CLL-1502	5.12	.79	CAT-200
10.20	14.13	8.07	6.26	Tr 159 x 6	1.54	5.12	.08	.98	1.73	146	CLL-1504	5.12	.79	CAT-200
12.17	18.07	8.07	6.26	Tr 159 x 6	1.54	5.12	.08	.98	1.73	174	CLL-1506	5.12	.79	CAT-200
14.13	22.01	8.07	6.26	Tr 159 x 6	1.54	5.12	.08	.98	1.73	203	CLL-1508	5.12	.79	CAT-200
16.10	25.94	8.07	6.26	Tr 159 x 6	1.54	5.12	.08	.98	1.73	231	CLL-15010	5.12	.79	CAT-200
18.07	29.88	8.07	6.26	Tr 159 x 6	1.54	5.12	.08	.98	1.73	260	CLL-15012	5.12	.79	CAT-200
9.57	11.54	9.25	7.24	Tr 184 x 6	1.97	5.12	.08	.98	1.97	183	CLL-2002	5.12	.79	CAT-200
13.50	19.41	9.25	7.24	Tr 184 x 6	1.97	5.12	.08	.98	1.97	260	CLL-2006	5.12	.79	CAT-200
19.41	31.22	9.25	7.24	Tr 184 x 6	1.97	5.12	.08	.98	1.97	376	CLL-20012	5.12	.79	CAT-200
9.80	11.77	10.83	8.50	Tr 216 x 6	1.97	5.91	.08	.98	2.20	256	CLL-2502	5.91	.83	CAT-250
13.74	19.65	10.83	8.50	Tr 216 x 6	1.97	5.91	.08	.98	2.20	359	CLL-2506	5.91	.83	CAT-250
19.65	31.46	10.83	8.50	Tr 216 x 6	1.97	5.91	.08	.98	2.20	515	CLL-25012	5.91	.83	CAT-250
11.61	13.58	12.20	9.49	Tr 241 x 6	2.32	5.47	.20	.98	2.36	382	CLL-3002	7.68	2.95	CAT-300
15.55	21.46	12.20	9.49	Tr 241 x 6	2.32	5.47	.20	.98	2.36	514	CLL-3006	7.68	2.95	CAT-300
21.46	33.27	12.20	9.49	Tr 241 x 6	2.32	5.47	.20	.98	2.36	712	CLL-30012	7.68	2.95	CAT-300
13.19	15.16	13.78	10.51	Tr 266 x 6	2.76	6.26	.20	.98	2.76	553	CLL-4002	8.86	3.35	CAT-400
17.13	23.03	13.78	10.51	Tr 266 x 6	2.76	6.26	.20	.98	2.76	721	CLL-4006	8.86	3.35	CAT-400
23.03	34.84	13.78	10.51	Tr 266 x 6	2.76	6.26	.20	.98	2.76	972	CLL-40012	8.86	3.35	CAT-400
14.76	16.73	15.75	12.01	Tr 305 x 6	3.15	7.05	.20	.98	3.15	809	CLL-5002	9.84	3.58	CAT-500
18.70	24.61	15.75	12.01	Tr 305 x 6	3.15	7.05	.20	.98	3.15	1029	CLL-5006	9.84	3.58	CAT-500
24.61	36.42	15.75	12.01	Tr 305 x 6	3.15	7.05	.20	.98	3.15	1360	CLL-50012	9.84	3.58	CAT-500
15.55	17.52	16.93	12.99	Tr 330 x 6	3.35	7.64	.20	.98	3.35	985	CLL-6002	10.83	3.78	CAT-600
19.49	25.39	16.93	12.99	Tr 330 x 6	3.35	7.64	.20	.98	3.35	1241	CLL-6006	10.83	3.78	CAT-600
25.39	37.20	16.93	12.99	Tr 330 x 6	3.35	7.64	.20	.98	3.35	1625	CLL-60012	10.83	3.78	CAT-600
17.91	19.88	19.88	15.24	Tr 387 x 6	3.94	8.82	.20	.98	3.94	1565	CLL-8002	12.60	4.84	CAT-800
21.85	27.76	19.88	15.24	Tr 387 x 6	3.94	8.82	.20	.98	3.94	1918	CLL-8006	12.60	4.84	CAT-800
27.76	39.57	19.88	15.24	Tr 387 x 6	3.94	8.82	.20	.98	3.94	2446	CLL-80012	12.60	4.84	CAT-800
19.49	21.46	22.05	17.01	Tr 432 x 6	4.33	9.80	.20	.98	4.33	2094	CLL-10002	14.17	5.35	CAT-1000
23.43	29.33	22.05	17.01	Tr 432 x 6	4.33	9.80	.20	.98	4.33	2517	CLL-10006	14.17	5.35	CAT-1000
29.33	41.14	22.05	17.01	Tr 432 x 6	4.33	9.80	.20	.98	4.33	3151	CLL-100012	14.17	5.35	CAT-1000

▼ Shown from left to right: JHA-356, JHA-156



JH, JHA Series

Capacity:
7-150 tons

Stroke:
3.00-6.13 inches

Maximum Operating Pressure:
10,000 psi

- All-directional operation on 7, 15 and 35 ton models (JHA- Series)
- Internal relief valve to prevent overloading
- Machined flat front and bottom surfaces permit flush alignment in tight corners
- All models include pumping handle
- Chrome plated plungers
- Automatic by-pass port to prevent over-extension (JH-Series)



Lifting Wedge and Machine Lifts

Ideal to lift the load the first few inches. The **LW-16** Lifting Wedge requires a very small access gap of only .39 inch.

Page: 168



Load Skates

For moving heavy loads easily and safely.

Page: 170

Style	Jack Capacity (ton)	Stroke (in)	Model Number	Jack Effective Area (in ²)	Collapsed Height (in)	Extended Height (in)	Bottom Plate Dimensions (W x L) (in)	Plunger Diameter (in)	Pump Speed	Weight (lbs)
Aluminum Jack	7	3.00	JHA-73	1.49	5.25	8.25	2.88 x 6.25	1.19	Single	11
	15	6.06	JHA-156	3.14	9.75	15.81	3.63 x 9.38	1.63	Single	29
	35	6.13	JHA-356	7.07	10.13	16.25	4.63 x 10.00	2.13	Single	40
	75	6.06	JHA-756	15.90	11.25	17.31	6.88 x 12.81	4.50	Single	94
	150	6.13	JHA-1506	30.68	12.88	19.00	9.50 x 16.06	6.25	2-Speed	210
Steel Jack	30	6.13	JH-306	5.94	10.00	16.13	3.75 x 9.56	2.75	Single	59
	50	6.09	JH-506	9.62	10.25	16.34	5.00 x 10.19	3.50	2-Speed	90
	100	6.06	JH-1006	20.63	11.31	17.37	7.13 x 12.94	5.12	2-Speed	184

Industrial Bottle Jacks

▼ Shown: GBJ-010, GBJ-030, GBJ-003



GBJ Series

Capacity:
2-100 tons

Stroke:
2.44-18.11 inches

- Lower handle effort reduces operator fatigue
- Fully serviceable
- High-strength beam and pump linkage for long life
- Pumping handle included on all models
- Safety relief valve to prevent overload
- Automatic by-pass port to prevent over-extension
- Wiper seal for extended life
- Thick base material with large area for increased strength and stability during lifting



Screw Feature

Heat treated, adjustable extension screw with cleated saddle on selected GBJ models helps adjusting and prevents slipping.

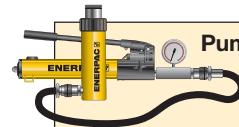

Pump and Cylinder Sets

As an alternative to Industrial Bottle Jacks where the operator is required to stand remote from the jacking point, see the range of pump and cylinder sets.

Page: 54

Jack Capacity (ton)	Stroke (in)	Model Number	Screw Extension (in)	Minimum Height (in)	Maximum Height (in)	Plunger Diameter (in)	Saddle Diameter (in)	Base Dimensions L x W (in)	Weight (lbs)
2	18.11	GBJ002L	-	22.44	40.55	1.14	-	5.00 x 5.00	13.2
2	3.94	GBJ002	1.97	6.30	12.20	0.83	0.83	3.74 x 4.37	7.9
3	4.13	GBJ003	2.56	6.61	13.31	0.94	0.94	3.74 x 4.57	8.6
5	5.91	GBJ005	2.95	8.35	17.20	1.14	1.14	3.74 x 4.84	11.0
8	5.91	GBJ008	2.95	8.62	17.48	1.30	1.46	3.74 x 5.43	13.0
10	5.91	GBJ010	2.95	8.62	17.48	1.46	1.46	3.74 x 5.59	14.3
10	2.44	GBJ010S	1.18	5.16	8.78	1.46	1.46	3.74 x 5.59	12.1
15	5.91	GBJ015	2.95	8.98	17.83	1.75	1.73	4.41 x 6.42	19.8
20	5.91	GBJ020	2.95	9.21	18.07	2.01	2.28	5.00 x 6.73	26.7
20	4.13	GBJ020S	2.17	7.48	13.78	2.01	2.28	5.00 x 6.73	22.0
30	5.91	GBJ030	2.95	9.53	18.39	2.26	2.56	5.59 x 7.72	34.2
50	5.91	GBJ050	-	9.92	15.83	3.15	3.15	7.09 x 9.06	62.8
100	5.91	GBJ100	-	11.81	17.72	4.33	3.70	11.65 x 13.11	191.8

All GBJ Jacks meet or exceed: ANSI, PALD, CE

▼ Shown: PRASA10027L



Safe, Efficient, Mobile Load Lifting

- 60, 100, 150 and 200-ton capacities with pneumatic or electric pumps for the toughest jobs
- 4" ground clearance for transport over rail and rough terrain
- Three position handle provides easy tilt back and transport
- Complies with ASME/ANSI B30.1:2015 & CE specifications
- Easy to change external filter minimizes down time
- Rugged, fully enclosed 24" wide frame with no exposed fittings or hoses
- SUP-R-STACK™ Extension System allows lifting at all heights without blocking.



Pendant Cord

Standard 12' pendant cord for air driven units with pneumatic valves and 20' pendant cord for electric driven units keeps operator away from the load.

▼ Versatility for rail maintenance. One jack for all cars from Intermodal to High Hopper with 28 heights in between.



Capacity	Stroke	Electric Pump Model Number	Weight
(ton)	(in)	(115 VAC)	(lbs)
60	14	PREMB06014L	390
	27	PREMB06027L	600
100	16	PREMB10016L	510
	27	PREMB10027L	600
	16	-	-
150	27	-	-
	15.5	-	-
	26.5	-	-
	15.5	PREMB15016L	570
200	26.5	PREMB15027L	708
	15.5	-	-
	26.5	-	-

(PR-Series not available in Canada. Contact Enerpac.)

POW'R-RISER® Lifting Jack



SUP-R-STACK™ Extensions

Increase useful height from 5" to 18".

Model No.	Size (in)	Model No.	Size (in)
PRE5	5	PRE11	11
PRE7	7	PRE14	14
PRE9	9	PRE18	18
PRES6024	Extension set includes PRE5, PRE7, PRE11, PRE18		

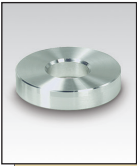

Spacers

Fine tune your Extension stack height.

Model No.	Size (in)	Model No.	Size (in)
PRS1	1	PRS3	3
PRS2	2	-	-
PRS4	Set includes (2) PRS1, (1) PRS2 and (1) PRS3		

PR Series



Rated Lifting Capacity:

60-200 tons

Stroke:

14-27 inches

Maximum Operating Pressure:

10,000 psi



WARNING!

Extensions: Any two Extensions may be stacked for loads up to 60 tons. For loads over 60 tons or strokes over 14" only one Extension and one Spacer can be used.

Spacers: Never exceed 3" in total Spacer height.

Cap. (ton)	Swivel Load Cap	Locking U-Rings					Set Model Number	Locking U-Ring Sets Include						
		1 in.	3 in.	4 1/4 in.	5 1/2 in.	10 in.		(quantity and model numbers)						
							2X	1X	2X	1X				
60	PRTS60	PRU11	PRU13	PRU14	-	PRU110	1) PRUS126	PRU11	PRU13	PRU14	-			
							2) PRUS137	PRU11	PRU13	PRU14	PRU10			
100	PRTS60	PRU11	PRU13	PRU14	-	PRU110	1) PRUS126	PRU11	PRU13	PRU14	-			
							2) PRUS137	PRU11	PRU13	PRU14	PRU110			
150	PRTS150	PRU151	PRU153	-	PRU155	PRU1510	3) PRUS1526	PRU151	PRU153	PRU155	-			
							2) PRUS1537	PRU151	PRU1510	PRU155	-			
200	PRTS200	PRU201	PRU203	-	PRU205	PRU2010	3) PRUS2026	PRU201	PRU203	PRU205	-			
							2) PRUS2037	PRU201	PRU2010	PRU205	-			

¹⁾ For 14 and 16" stroke models

²⁾ For 27" stroke models

³⁾ For 15.5" stroke models

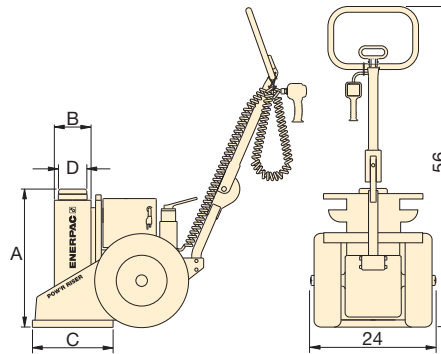

Air Pump	Weight (lbs)	A (in)	B (in)	C (in)	D (in)	Max. Additional Stack Height Using Optional Ext. System (in)	Valve Type
PRAMA06014L	390	24	6.4	14	4	32*	Manual
PRAMA06027L	600	37	6.4	14	4	11	
PRAMA10016L	510	26	7.0	18	4	21**	Pneumatic
PRAMA10027L	600	37	7.0	18	4	11	
PRASA10016L	510	26	7.0	18	4	21**	
PRASA10027L	600	37	7.0	18	4	11	
PRASA15016L	570	26	8.0	18	5	21**	Pneumatic
PRASA15027L	708	37	8.0	18	5	11	
-	-	26	8.0	18	5	21**	Manual
-	-	37	8.0	18	5	11	
PRASA20016L	640	26	9.5	20	6	21**	Pneumatic
PRASA20027L	825	37	9.5	20	6	11	

For power source, the following characters should be inserted in the 5th space of the model number.

Ordering Example:

Model No. PREMI06014L is a 14" stroke, 60 ton model, with a manual valve and a 208-240 VAC, 1-ph electric motor.

- A Air Pump, 50 scfm, 80 psi
- B 115 VAC, 1-ph., 50-60 Hz, 20 A
- E 208-240 VAC, 1-ph., 50-60 Hz, Euro Plug, 10 A
- I 208-240 VAC, 1-ph., 50-60 Hz, USA Plug, 10 A
- G ¹⁾208-240 VAC, 3-ph., 50-60 Hz
- W ¹⁾380-415 VAC, 3-ph., 50-60 Hz
- J ¹⁾440-480 VAC, 3-ph., 50-60 Hz
- R ¹⁾575 VAC, 3-ph., 50-60 Hz

¹⁾ Not available for 60-ton capacity

* Based on one 18" and one 11" Extension and one 3" Spacer.

** Based on one 18" Extension and one 3" Spacer.

▼ Shown from left to right: P-142ALSS, P-392ALSS, V-152NV, V-66NV, RC256NV, RC-106NV, RC-53NV



Maximum Corrosion Resistance



Applications

Use Enerpac **Extreme Environment Products** in wet environments such as food processing, pulp and paper, mining, construction and applications in high temperature or in welding areas.

- Corrosion resistant, nickel-plated valves and cylinders
- Stainless steel pump inserts will not corrode
- Viton® Seals provide heat and chemical resistance
- Anodized aluminum pump reservoirs and plastic encapsulated pump bodies resist wet environments
- Two-speed operation reduces pump handle strokes 78% compared to single-speed pumps
- Pump handles lock for easy carrying



700, 900 Series Hoses

Enerpac offers a complete line of high-quality hydraulic hoses. To ensure the integrity of your system, specify only genuine Enerpac hydraulic hoses.

Page: **114**

▼ CYLINDER CHART



Cylinder Capacity (ton)	Stroke (in)	Model Number	Oil Capacity (in ³)	Pressure Rating (psi)	Port Dimension (in)	Collapsed Height	Extended Height	Outside Diameter
						A (in)	B (in)	D (in)
5	3.0	RC-53NV	2.98	10,000	3/8"-18 NPTF	6.50	9.50	1.50
10	2.0	RC-102NV	4.75	10,000	3/8"-18 NPTF	4.78	6.91	2.25
10	6.0	RC-106NV	13.70	10,000	3/8"-18 NPTF	9.75	15.88	2.25
25	6.0	RC-256NV	32.23	10,000	3/8"-18 NPTF	10.75	17.00	3.38

▼ HAND PUMP CHART



Pump Type	Oil Capacity (in ³)	Model Number	Pressure Rating (psi)	Oil Displacement per Stroke (in ³)	Port Dimension (in)	Piston Stroke (in)
Two Speed	20	P-142ALSS	200/10,000	0.221/0.055	1/4"-18 NPTF	.50
	55	P-392ALSS	200/10,000	0.687/0.151	3/8"-18 NPTF	1.00

▼ VALVE CHART*



Valve Type	Model Number	Pressure Function	Pressure Rating (psi)
Manual Check Valve	V-66NV	Check	10,000
Pressure Relief Valve	V-152NV	+ 3% Repeatability	800-10,000

* See page 128 for valve function information of standard model products.

P-392ALSS

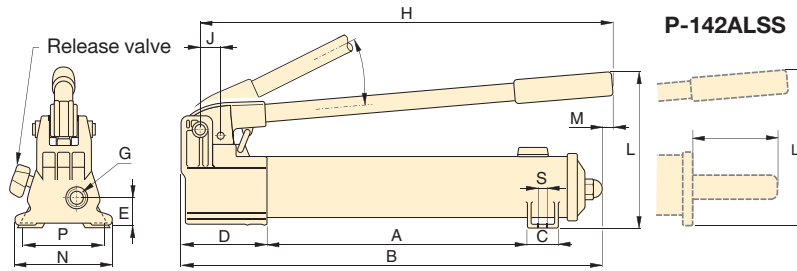

RC P V Series



Cylinder Capacity:
5-25 tons

Stroke:
2-6 inches

Maximum Operating Pressure:
10,000 psi

RC-102NV, RC-106NV, RC-256NV

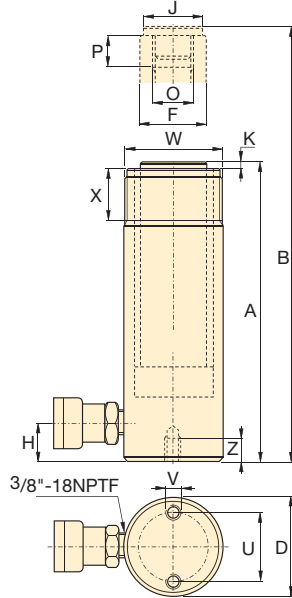

V-66NV

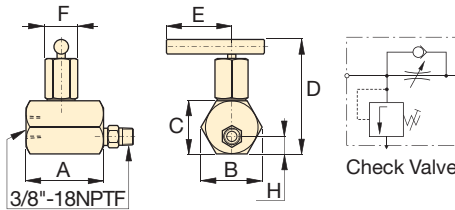

V-152NV

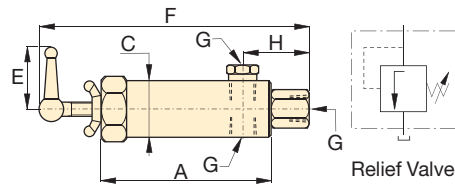

Multifluid Hand Pumps

MP-Series corrosion resistant hand pumps for low pressure filling and high pressure testing applications, suitable for a wide range of fluids.

Page: **65**

Plunger Diam.	Base to Adv. Port	Saddle Diam.	Saddle Protrusion from Plng.	Plunger Internal Thread	Plunger Thread Length	Base Mounting Holes			Collar Thread	Collar Thread Length	Weight (lbs)	Model Number
						Bolt Circle U (in)	Thread V (in)	Thrd. Depth Z (in)				
1.00	.75	1.00	.25	3/4"-16	.56	1.00	1/4"-20UN	.56	1 1/2"-16	1.13	3.3	RC-53NV
1.50	.75	1.38	.25	1"-8	.75	1.56	5/16"-18UN	.50	2 1/4"-14	1.13	5.1	RC-102NV
1.50	.75	1.38	.25	1"-8	.75	1.56	5/16"-18UN	.50	2 1/4"-14	1.13	9.8	RC-106NV
2.25	1.00	2.00	.41	1 1/2"-16	1.00	2.31	1/2"-13UN	.75	3 5/16"-12	1.94	22.0	RC-256NV

Pump Dimensions (in)													Weight (lbs)	Model Number
A	B	C	D	E	G	H	J	L	M	N	P	S		
7.31	13.25	1.13	3.37	1.13	1/4"-18 NPTF	12.56	.75	5.63	-	3.75	3.18	.28	4.5	P-142ALSS
13.56	21.00	1.44	3.93	1.31	3/8"-18 NPTF	20.56	1.19	7.00	.63	4.75	-	-	9.0	P-392ALSS

Valve Dimensions (in)									Weight (lbs)	Model Number
A	B	C	D	E	F	G	H			
3.50	2.25	2.00	4.00	2.00	0.87	3/8"-18 NPTF	1.00	3.9	V-66NV	
4.53	-	1.50	-	3.12	7.62	3/8"-18 NPTF	1.53	3.5	V-152NV	

▼ Shown cylinder-pump set: **SCR-1010H**



The Quickest and Easiest Way to Start Working Right Away





- Optimum match of individual components
- Sets include 6 foot safety hose, calibrated gauge with gauge adaptor
- All hand pumps are two-speed



Speed Chart

See the Enerpac Cylinder Speed Chart in our “Yellow Pages” section.

Page: 251

 Cylinder Selection (See Cylinder Section of this catalog for full product descriptions)		Nominal Set Capacity (ton)	Cylinder Model No.	Stroke (in)	Collapsed Height (in)
 <p>Single-acting, General Purpose Cylinders: For maximum versatility. RC-Series DUO</p> <p style="text-align: right;">Page: 6</p>	5	RC-55	5.00	8.50	
		10	RC-102	2.13	4.78
	RC-106		6.13	9.75	
	RC-1010		10.13	13.75	
	15	RC-154	4.00	7.88	
		RC-156	6.00	10.69	
	25	RC-252	2.00	6.50	
		RC-254	4.00	8.50	
RC-256		6.25	10.75		
RC-2514		14.25	18.75		
 <p>Single-acting, Low Height Cylinders: Ideal where space is restricted. RCS-Series</p> <p style="text-align: right;">Page: 22</p>	50	RC-506	6.25	11.13	
	10	RCS-101	1.50	3.47	
		RCS-201	1.75	3.88	
	30	RCS-302	2.44	4.63	
	50	RCS-502	2.38	4.81	
 <p>Single-acting, Hollow Cylinders: For pushing and pulling applications. RCH-Series</p> <p style="text-align: right;">Page: 26</p>	100	RCS-1002	2.25	5.56	
	12	RCH-121	1.63	4.75	
		RCH-202	2.00	6.31	
	30	RCH-302	2.50	7.03	
	60	RCH-603	3.00	9.75	
 <p>Pull Cylinders: The ultimate in pulling power. BRP-Series</p> <p style="text-align: right;">Page: 24</p>	10	BRP-106C	5.95	23.11	
		BRP-106L	5.95	21.33	
	30	BRP-306	6.10	42.72	
	60	BRP-606	5.98	28.34	
	–	–	–	–	

Single-Acting, Cylinder Pump Sets

SELECTION EXAMPLE

Selected cylinder:

- RC-106, Single-acting cylinder with 6.13" stroke

Selected pump:

- P-392, Lightweight hand pump

Set model number:

- SCR-106H

Included:

- HC-7206 hose
- GF-10P gauge
- GA-2 adaptor

SET SELECTION:

- 1 Select the cylinder
- 2 Select the pump
- 3 Find the set model number in the blue field of the matrix

SC Series



Capacity:

5-100 tons

Stroke:

1.50-14.25 inches

Maximum Operating Pressure:

10,000 psi

2

Pump selection (See Pump Section of this catalog for full product descriptions)

Accessories Included

Hand Pump P-142	Hand Pump P-392	Hand Pump P-80	Foot Pump P-392FP	XA-Series Air Pump XA-11	Hose Model No.	Gauge Model No.	Gauge Adaptor Model No.
SCR-55H	-	-	-	-	HC-7206	GP-10S	GA-4
-	SCR-102H	-	SCR-102FP	SCR-102XA	HC-7206	GF-10P	GA-2
-	SCR-106H	-	SCR-106FP	SCR-106XA	HC-7206	GF-10P	GA-2
-	SCR-1010H	-	SCR-1010FP	SCR-1010XA	HC-7206	GF-10P	GA-2
-	SCR-154H	-	SCR-154FP	SCR-154XA	HC-7206	GP-10S	GA-2
-	SCR-156H	-	SCR-156FP	SCR-156XA	HC-7206	GP-10S	GA-2
-	SCR-252H	-	SCR-252FP	SCR-252XA	HC-7206	GF-20P	GA-2
-	SCR-254H	-	SCR-254FP	SCR-254XA	HC-7206	GF-20P	GA-2
-	SCR-256H	-	-	SCR-256XA	HC-7206	GF-20P	GA-2
-	-	SCR-2514H	-	SCR-2514XA ¹⁾	HC-7206	GF-20P	GA-2
-	-	SCR-506H	-	SCR-506XA ¹⁾	HC-7206	GF-50P	GA-2
-	SCL-101H	-	SCL-101FP	SCL-101XA	HC-7206	GF-10P	GA-2
-	SCL-201H	-	SCL-201FP	SCL-201XA	HC-7206	GF-230P	GA-2
-	SCL-302H	-	SCL-302FP	SCL-302XA	HC-7206	GF-230P	GA-2
-	SCL-502H	-	SCL-502FP	SCL-502XA	HC-7206	GF-510P	GA-2
-	-	SCL-1002H	-	-	HC-7206	GF-510P	GA-2
SCH-121H	-	-	-	-	HB-7206	GF-120P	GA-4
-	SCH-202H	-	SCH-202FP	SCH-202XA	HC-7206	GF-813P	GA-3
-	SCH-302H	-	SCH-302FP	SCH-302XA	HC-7206	GF-813P	GA-3
-	-	SCH-603H	-	SCH-603XA ¹⁾	HC-7206	GF-813P	GA-3
-	-	SCH-1003H	-	-	HC-7206	GP-10S	GA-2
-	SCP-106CH	-	SCP-106CFP	-	HC-7206	GP-10S	GA-2
-	SCP-106LH	-	SCP-106LFP	-	HC-7206	GP-10S	GA-2
-	-	SCP-306H	-	-	HC-7206	GP-10S	GA-2
-	-	SCP-606H	-	-	HC-7206	GP-10S	GA-2
-	-	-	-	-	-	-	-

¹⁾ XA-12

ENERPAC hydraulic pumps are available in over 1,000 different configurations. Whatever your high pressure pump needs are... speed, control, intermittent or heavy-duty performance... you can be sure that Enerpac has the pump to suit the application.

Featuring Hand, Battery, Electric, Air and Gasoline powered models, with multiple reservoir and valve configurations, Enerpac offers the most comprehensive high pressure pump line available.



Pump Selection

For help in selecting the correct pump for your application, please review our **“Yellow Pages.”** If you require further assistance, contact the Enerpac office located near you.

Page: 244





















Torque Wrench Pumps

System matched air and electric pumps provide control to operate Enerpac Torque Wrenches.

Page: 204



Pumps and Directional Control Valves Section Overview

Power Source	Pump Types	Maximum Reservoir Capacity	Max. Flow at Rated Pressure (in ³ /min)	Series		Page
Manual	Lightweight Hand Pumps Exclusively from Enerpac	155 in ³	.15 (in ³ /stroke)	P		58 ▶
	ULTIMA Steel Hand Pumps Low Pressure Hand Pumps	453 in ³ 200 in ³	.29 .58 (in ³ /stroke)	P P		60 ▶ 62 ▶
	Foot Pump For Hands Free Operation	38 in ³	.15 (in ³ /stroke)	P		64 ▶
	Multifluid Hand Pumps Pumping Fluids up to 14,500 psi	-	1.28 (in ³ /stroke)	MP		65 ▶
	Ultra-High Pressure Hand Pumps Pressure up to 40,000 psi	60 in ³	.15 (in ³ /stroke)	P/11		66 ▶
Electric	Battery Powered Hydraulic Pump Cordless Hydraulic Power	120 in ³	15	XC		68 ▶
	Economy Series Compact and Portable	1 gal.	20	PU		70 ▶
	Submerged Series Powerful and Low-Noise	1.5 gal.	20	PE		72 ▶
	Z-Class Portable and Powerful	10 gal.	60 200	ZU ZE		78 ▶ 84 ▶
	8000-Series The Maximum Flow Pump	25 gal.	462	PE		90 ▶
Air	ZA4 Air Hydraulic Pumps The Standard for Air-Hydraulic Pumps	10 gal.	80	ZA		92 ▶
	XA-Series Air Hydraulic Pumps XVARI® Technology for Productivity and Ergonomics	122 in ³	15	XA		94 ▶
	Turbo II Air Hydraulic Pumps Compact Air Over Hydraulic	305 in ³	10	PA		96 ▶
	Air Hydraulic Pumps Single and Twin-Air Motor	80 in ³ 2 gal.	8 9	PA PAM		98 ▶ 99 ▶
Gasoline	ZG5/ZG6 Gasoline Hydraulic Pumps Gas Powered High Flow Pumps	10 gal.	200	ZG5/ ZG6		100 ▶
	Atlas Series Small and Lightweight	2 gal.	40	PGM		102 ▶
	8000-Series Gasoline Pumps For the Largest Jobs	25 gal.	1.5 (gal/min)	EGM		103 ▶
Directional Control Valves						104 ▶

P-Series, Lightweight Hand Pumps

▼ Pumps shown, from top to bottom: P-802, P-842, P-202, P-142



- Lightweight and compact design
- Durable glass-filled nylon reservoir and nylon encapsulated aluminum pump base for maximum corrosion resistance
- Two-speed operation on most models reduces handle strokes by as much as 78% over single speed pumps
- Lower handle effort to minimize operator fatigue
- Integral 4-way valve on P-842 for operation of double-acting cylinders
- Handle lock and lightweight construction for easy carrying
- Large oil capacities to power a wide range of cylinders or tools
- Non-conductive fiberglass handle for operator safety
- Internal pressure relief valve for overload protection

▼ P-392 in action with RC-256 cylinders.



Exclusively from Enerpac



Cylinder Matching Chart

For help in selecting the correct hand pump for your application, please refer to the Cylinder Matching Chart located in the “Yellow Pages”.

Page: 244



Speed Chart

To determine how a specific pump will operate your cylinder, see the Pump/Cylinder Speed Chart in the “Yellow Pages”.

Page: 251



Tank Kits

When a return-to-tank port is required, the Tank Kits provide a 7/16-20 port at the rear of the reservoir.

PC-20	Fits P-141, P-142
PC-25	Fits P-202, P-391, P-392



LX-101 Hand Pump Oil

A medium viscosity oil specially formulated for hand pumps. Performs well in low temperatures and requires less pumping effort than standard Enerpac HF blue oil.

Page: 118

Pump Type	Usable Oil Capacity (in ³)	Model Number	Pressure Rating*		Oil Displacement per Stroke (in ³)		Max. Handle Effort (lbs)
			(psi)		(in ³)		
			1 st stage	2 nd stage	1 st stage	2 nd stage	
Single speed	20	P-141	N/A	10,000	N/A	.055	72
	55	P-391	N/A	10,000	N/A	.151	85
Two speed	20	P-142**	200	10,000	.221	.055	78
	55	P-202	200	10,000	.221	.055	63
	55	P-392**	200	10,000	.687	.151	93
	155	P-802	400	10,000	2.40	.151	95
	155	P-842***	400	10,000	2.40	.151	95

* Contact Enerpac for applications where operating pressure is less than 10% of pressure rating.

** Available as set, see note on top of next page.

*** For use with double-acting cylinders.

Lightweight Hand Pumps

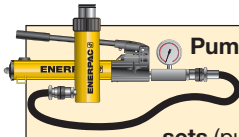

Pump and Cylinder Sets

Pumps marked with an ** are available as sets (pump, cylinder, gauge, couplers and hose) for your ordering convenience.

Page: 54

P Series



Reservoir Capacity:
20-155 in³

Flow at Rated Pressure:
.055-.15 in³/stroke

Maximum Operating Pressure:
10,000 psi

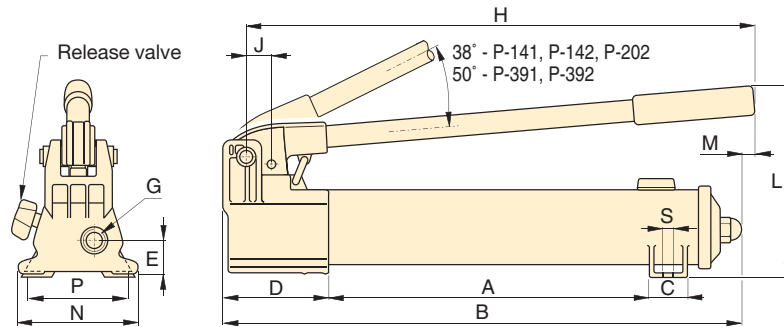

P-141, P-142, P-202, P-391, P-392

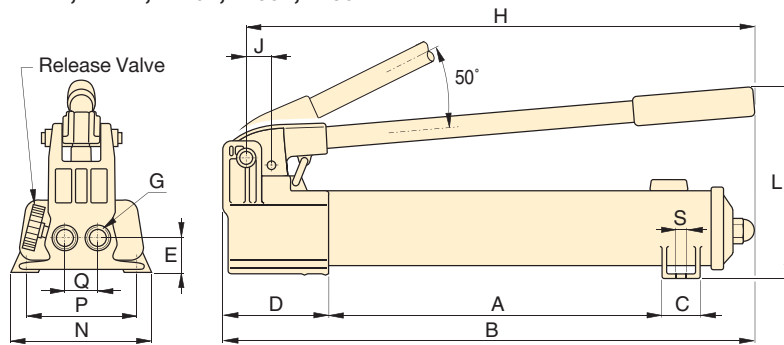

P-802

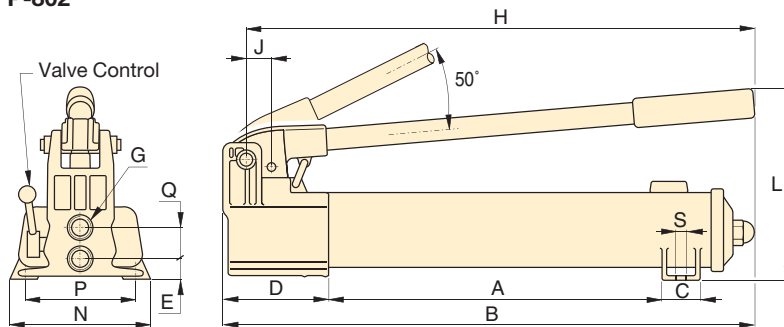

P-842



Hoses

Enerpac offers a complete line of high-quality hydraulic hoses. To ensure the integrity of your system, specify only genuine Enerpac hydraulic hoses.

Page: 114



Gauges

Minimize the risk of overloading and ensure long, dependable service from your equipment. Refer to the System Components section for a full range of gauges.

Page: 113



Aluminum Reservoir

For applications where composite reservoirs may not be suitable, the P-392AL utilizes an extruded aluminum reservoir. Also included is a second handle for two-hand use. Contact Enerpac for details.

Piston Stroke	Dimensions (in)															Weight (lbs)	Model Number
	(in)	A	B	C	D	E	G	H	J	L	M	N	P	Q	S		
.50	7.31	13.25	1.13	3.37	1.13	1.13	1/4"-18 NPTF	12.56	.75	5.63	-	3.75	3.25	-	.28	4.5	P-141
1.00	13.56	21.00	1.44	3.93	1.31	1.31	3/8"-18 NPTF	20.56	1.19	7.00	.63	4.75	-	-	-	9.0	P-391
.50	7.31	13.25	1.13	3.37	1.13	1.13	1/4"-18 NPTF	12.56	.75	5.63	-	3.75	3.25	-	.28	5.3	P-142**
.50	13.56	20.06	1.44	3.37	1.13	1.13	1/4"-18 NPTF	15.75	.75	5.69	.63	3.75	-	-	-	7.5	P-202
1.00	13.56	21.00	1.44	3.93	1.31	1.31	3/8"-18 NPTF	20.56	1.19	7.00	.63	-	-	-	-	9.0	P-392**
1.00	13.30	21.75	1.78	5.25	1.39	1.39	3/8"-18 NPTF	20.75	2.19	9.00	-	7.12	6.02	1.40	.41	18.0	P-802
1.00	13.30	21.75	1.78	5.25	.81	.81	3/8"-18 NPTF	20.75	2.19	9.00	-	7.12	6.02	1.44	.41	22.0	P-842***

▼ Shown from left to right: P-77, P-80, P-84, P-801, P-39



- Reduced handle effort and ergonomic grip for less operator fatigue
- Two-speed operation for fast and easy operation (except P-39)
- Vent free reservoir eliminates spills
- Quick grip handle allows for easy transport
- Integral reservoir over-pressurization protection
- All steel construction, chrome plated plunger and wiper system for durable, long lasting performance
- 4-way valving on the P84 and P-464 for operation of double-acting cylinders

▼ In the absence of a power supply, the P-80 Hand Pump offers a powerful solution.



The Solution for Tough Jobs



Two Speed Pumps

Recommended for applications where cylinder plunger must advance rapidly to contact load, and applications where greater oil capacities are required, such as multiple cylinder hook-ups.



Foot Pump Conversion Kits

Convert your **P39, P77, P80, or P801** to foot power with the **PC-11 Kit**. Includes instructions for easy conversion.



Gauges

Minimize the risk of overloading and ensure long, dependable service from your equipment. Refer to the System Components section for a full range of gauges.

Page: 113



4-Way Control Valve

P-84 and P-464 feature a manual 4-way control valve, designed for use with one double-acting or two single-acting cylinders. For system set-up information:

Page: 247

Pump Type	Usable Oil Capacity (in ³)	Model Number	Pressure Rating*		Oil Displacement per Stroke		Max. Handle Effort (lbs)
			(psi)		(in ³)		
			1 st stage	2 nd stage	1 st stage	2 nd stage	
Single	47	P-39	N/C	10,000	N/C	.15	85
	47	P-77	500	10,000	1.00	.15	88
Two-speed	134	P-80**	500	10,000	1.00	.15	77
	250	P-801	500	10,000	1.00	.15	77
	134	P-84***	500	10,000	1.00	.15	77
	453	P-462	200	10,000	7.69	.29	110
	453	P-464***	200	10,000	7.69	.29	110

* Contact Enerpac for applications where operating pressure is less than 10% of pressure rating.

** Available as a set, see note on next page.

*** For use with double-acting cylinders.

Steel Hand Pumps

P Series

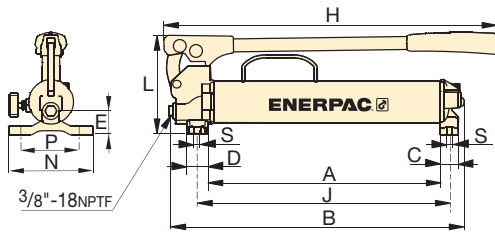

P-39, P-77

Reservoir Capacity:
47-453 in³

Flow at Rated Pressure:
.15-.29 in³/stroke

Maximum Operating Pressure:
10,000 psi

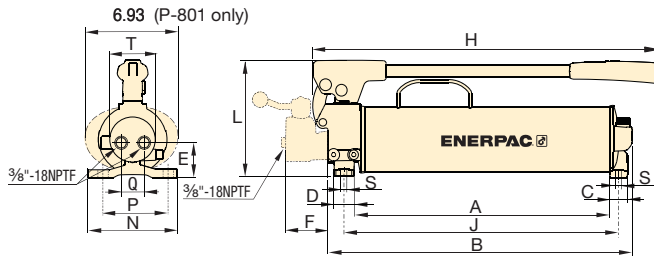

P-80, P-801, P-84



Extra Capacity Hand Pumps

P-462 and P-464 feature extra large reservoirs and a high first-stage flow rate.

These pumps are ideally suited for powering high-capacity cylinders.

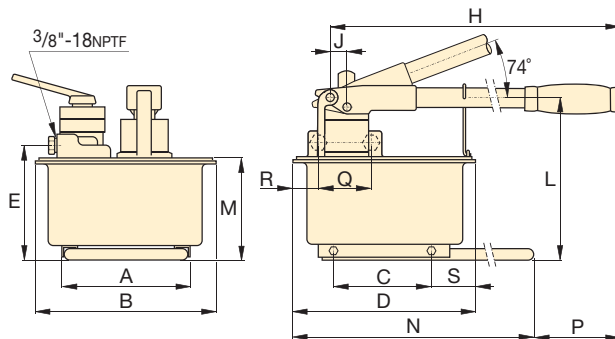

P-462, P-464

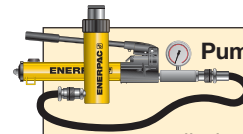

Pump and Cylinder Sets

P-80 is also available as a set (pump, cylinder, gauge, couplers and hose) for your ordering convenience.

Page: 54



Cylinder Matching Chart

For help in selecting the correct hand pump for your application, please refer to the Cylinder Matching Chart located in the "Yellow Pages"

Page: 244

Piston Stroke	Dimensions (in)																Weight (lbs)	Model Number
	(in)	A	B	C	D	E	F	H	J	L	M	N	P	Q	R	S		
1.00	15.09	18.91	1.18	1.38	1.48	-	21.63	16.37	6.39	-	5.51	4.37	-	-	0.33	-	13.6	P-39
1.00	15.39	19.19	1.18	1.38	1.86	-	21.63	16.67	6.39	-	5.51	4.37	-	-	0.33	-	15.6	P-77
1.00	16.83	20.12	1.18	1.38	2.17	-	23.50	18.11	7.65	-	5.91	4.76	1.65	-	0.33	2.93	23.6	P-80**
1.00	16.83	20.12	1.18	1.38	2.17	-	23.50	18.11	7.65	-	5.91	4.76	1.65	-	0.33	2.93	31.0	P-801
1.00	16.83	20.06	1.18	1.38	2.30	2.77	22.78	18.11	7.65	-	5.91	4.76	1.50	-	0.33	2.93	26.0	P-84***
1.50	8.25	12.13	6.42	12.63	7.68	-	26.44	.98	10.63	6.89	25.6	3.63	-	-	3.13	-	61.0	P-462
1.50	8.35	12.13	6.42	12.63	7.68	-	26.44	.98	10.63	6.89	25.6	3.63	3.50	2.68	3.13	-	61.0	P-464***

▼ Shown from left to right: P-25, P-51, P-18



When Less Than 10,000 psi is All You Need

- P-25 and P-50 pump oil in both forward and reverse handle movement improving overall efficiency, ideal when mounting space is restricted
- External load-release valve
- Internal pressure-relief valve for overload protection
- P-51 can be operated in horizontal and vertical position with pump head and oil outlet facing downwards



LX-101 Hand Pump Oil

A medium viscosity oil specially formulated for hand pumps. Performs well in low temperatures and requires less pumping effort than standard Enerpac HF blue oil.

Page: 118



Gauges

Minimize the risk of overloading and ensure long, dependable service from your equipment. Refer to the System Components section for a full range of gauges.

Page: 113

▼ P-18 hand pump used for locking the rotating table for marble polishing.



Pump Type	Usable Oil Capacity (in ³)	Model Number	Pressure Rating (psi)	Oil Displacement per Stroke (in ³)	Max. Handle Effort (lbs)
Single-speed	22	P-18	2,850	0.15	34
	200	P-25	2,500	0.58	60
	200	P-50	5,000	0.29	60
	50	P-51	3,000	0.25	61

Low Pressure Hand Pumps

P Series



Reservoir Capacity:
22-200 in³

Flow at Rated Pressure:
.15-.58 in³/stroke

Maximum Operating Pressure:
2,500-5,000 psi

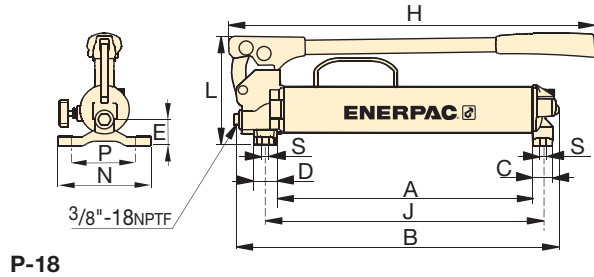

P-18

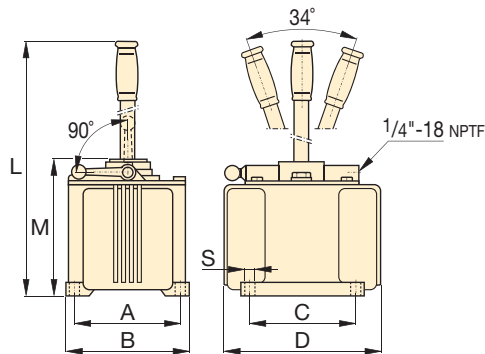

P-25, P-50

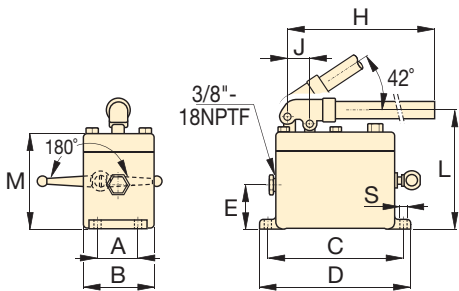

P-51



Hoses

Enerpac offers a complete line of high quality hydraulic hoses. To ensure the integrity of your system, specify only genuine Enerpac hydraulic hoses.

Page: 114

P-51 hand pumps used with RC-series cylinders to keep wooden layers under pressure during lamination of plates.



Piston Stroke	Dimensions (in)												Weight (lbs)	Model Number
	(in)	A	B	C	D	E	H	J	L	M	N	P		
1.00	8.70	12.44	1.18	1.38	1.48	15.17	9.98	6.39	-	5.51	4.37	.33	11	P-18
1.50	6.00	6.82	6.00	9.43	-	-	-	26.94	7.88	-	-	.40	36	P-25
1.50	6.00	6.82	6.00	9.43	-	-	-	26.94	7.88	-	-	.40	37	P-50
1.00	2.06	3.63	7.12	7.88	2.25	24.00	1.16	6.31	5.06	-	-	.34	12	P-51

Lightweight Hydraulic Foot Pump

▼ Shown: P-392FP



- **Robust, durable and compact**
 - Steel frame for maximum stability
 - Steel pumping handle
 - Aluminium reservoir
- **Foot pedal lock and lightweight construction for portability**
- **Two-speed operation reduces foot pedal strokes**
- **Large foot-pad release valve for controlling load descent**
- **Internal pressure relief valve for overload protection**

▼ P-392FP offers the advantage of hands free operation to handle and control the tool or cylinder.



P Series

Reservoir Capacity:

38 in³

Flow at Rated Pressure:

.151 in³/stroke

Maximum Operating Pressure:

10,000 psi

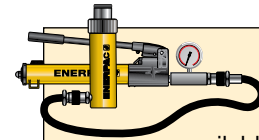

Pump and Cylinder Sets

The P-392FP is available as **sets** (pump, cylinder, gauge, couplers and hose) for your ordering convenience.

Page: 54



Hoses

Enerpac offers a complete line of high quality hydraulic hoses. To ensure the integrity of your system, specify only genuine Enerpac hydraulic hoses.

Page: 114

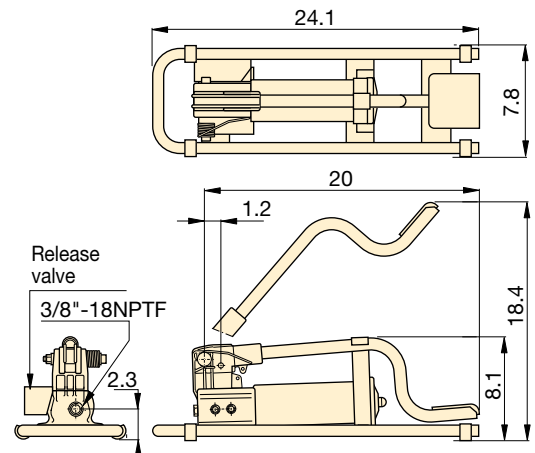

Usable Oil Capacity (in ³)	Model Number	Pressure Rating (psi)		Oil Displacement per Stroke (in ³)		Max. Handle Effort (lbs)	Piston Stroke (in)	Weight (lbs)
		1st stage	2nd stage	1st stage	2nd stage			
30	P-392FP *	200	10,000	.687	.151	125	1	16

* Available as set, see note on this page.

Multifluid Hand Pumps

▼ Shown: **MP-110**



- Superior corrosion resistance
- Impregnated aluminum anodized pump housing with stainless steel internal pumping components
- Standard Nitrile seals – excellent for demineralized water, oil/water emulsions, water glycols, mineral oils, hydraulic fluids
- Custom EPDM seals available for use with Skydrol® or brake fluids
- Two speed pumps up to 14,500 psi pressure
- Externally adjustable pressure relief valve
- 1/4" NPTF gauge port

▼ MP-Series pumps are ideal for testing and filling applications.



MP Series

Reservoir Capacity:
2 gal. (optional)

Flow at Rated Pressure:
.12-1.28 in³/stroke

Maximum Operating Pressure:
1,500-14,500 psi



Optional Reservoir Kit

The 2 gallon reservoir kit **MP-10T*** includes tank with skid frame, top plate with reservoir seal, suction pipe and mounting bolts. Useable oil capacity is 1.5 gal.

*For use with mineral oil applications only.



Also available is model number **11-400**.

Page: **66**

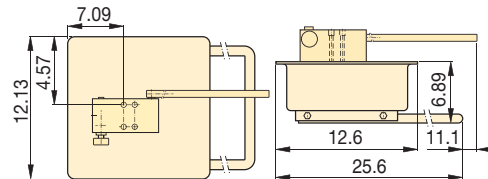
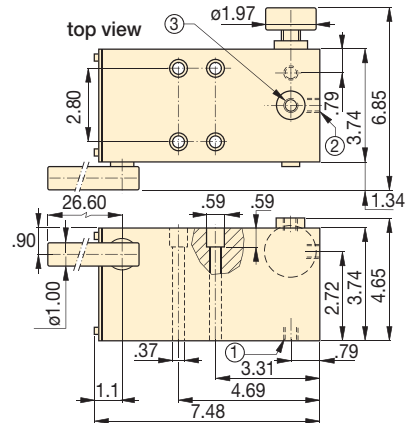

MP-10T

MP-110, 350, 700, 1000

- ① Suction / Tank return port 3/8"-18 NPTF
- ② Pressure port 3/8"-18 NPTF
- ③ Gauge port 1/4"-18 NPTF

Pump Type	Usable Oil Capacity (in ³)	Model Number	Pressure Rating (psi)		Oil Displacement per Stroke (in ³)		Max. Handle Effort (lbs)	Piston Stroke (in)	Weight (lbs)
			1st stage	2nd stage	1st stage	2nd stage			
Two Speed	*	MP-110	500	1500	3.2	1.28	99	1.04	14.5
	*	MP-350	500	5000	3.2	.43	99	1.04	14.5
	*	MP-700	500	10,000	3.2	.18	99	1.04	14.5
	*	MP-1000	500	14,500	3.2	.12	99	1.04	14.5

Note: MP-Pump includes .060 in. thick gasket for reservoir mounting.

* MP-Series pumps require the use of an external reservoir.

▼ Shown from left to right: 11-100, P-2282



- Two-speed operation on the P-2282 allows for faster fill, reducing cycle times for many testing applications
- 303 Stainless steel construction on the 11-100 and 11-400 models enable use with many different fluids, such as distilled water, alcohol, diesters, silicones, soluble oils and petroleum
- Large release knob for improved control of pressure release
- Outlet ports are 3/4"-16 cone for 40,000 psi rating

Ultra-High Pressure up to 40,000 psi



2-Way Shut-Off Valve 72-750

For 40,000 psi applications requiring a shut-off valve or gauge snubber. Made of 318 Stainless Steel and utilizing .38 inch cone fittings, it is the perfect selection for use with your Ultra-High Pressure Hand Pump.



Test System Gauges

Ideal for monitoring pressure in your hydraulic circuit, Test System Gauges, such as the T-6010L, are available with cone threads or NPTF threads and in a variety of pressure ranges.

Page: 124

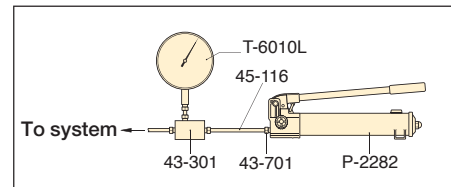

▲ Typical Test System

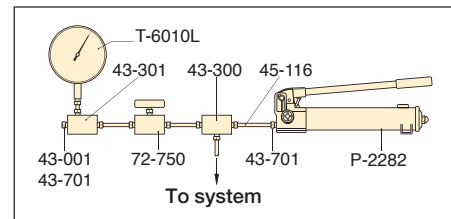

▲ Test System with Gauge and Snubber

Cone Seal

Stainless Steel High Pressure fittings seal on a "cone" surface and do not require pipe sealer. The Gland Nut holds the sleeve and tubing tight against the cone surface to provide a 40,000 psi seal.

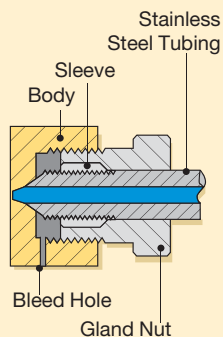

Pump Type	Usable Oil Capacity (in ³)	Model Number	Pressure Rating* (psi)		Oil Displacement per Stroke (in ³)		Max. Handle Effort (lbs)
			1st stage	2nd stage	1st stage	2nd stage	
Two-speed	60	P-2282	200	40,000	.99	.037	106
Single-speed	45	11-100	N/C	10,000	N/C	.152	120
	45	11-400	N/C	40,000	N/C	.038	120

* Contact Enerpac for applications where operating pressure is less than 10% of pressure rating.

Ultra-High Pressure Hand Pumps

▼ Optional Ultra-High Pressure Fittings and Tubing

Description	Connection	Model No.
40,000 psi		
Gland Nut Plug	.38" cone	43-001
Elbow	.38" cone	43-200
Tee	.38" cone	43-300
Gauge Tee	.38" cone side/ .25" cone gauge port	43-301
Gauge Adaptor	.38" cone side/ .25" cone gauge port	83-011
Coupling	.38" cone	43-400
Cross	.38" cone	43-600
Gland Nut with Sleeve	.38" cone	43-701
Gauge Connector	.25" cone	43-704
Tubing	4" tube, O.D. .38" * 8" tube, O.D. .38" * 12" tube, O.D. .38" *	45-116 45-126 45-136
WARNING: Maximum working pressure: 10,000 psi only		
Adaptor	.38" F cone to 1/4" M NPTF .38" F cone to 3/8" M NPTF	41-146 41-166
Adaptor	.38" F cone to 1/4" F NPTF .38" F cone to 3/8" F NPTF	41-246 41-266
Adaptor	.38" M cone to 3/8" F NPTF	41-366

Note: .25" cone fittings use 3/16"-18 threads, 3/8" cone fittings use 1/4"-16 threads.

* Actual tubing lengths are .75" less than nominal size shown. These dimensions make distance between centers of valves and fittings multiples of 4" spaces.

P/11 Series



Reservoir Capacity:
45-60 in³

Flow at Rated Pressure:
.037-.152 in³/stroke

Maximum Operating Pressure:
10,000-40,000 psi



Stainless Steel Construction

Ultra-high Pressure Fittings feature all stainless steel construction except adaptor 41-366, which features nickel plated carbon steel construction.



Ultra-High Pressure pumps DO NOT have an internal safety pressure relief valve.

11-100*, 11-400

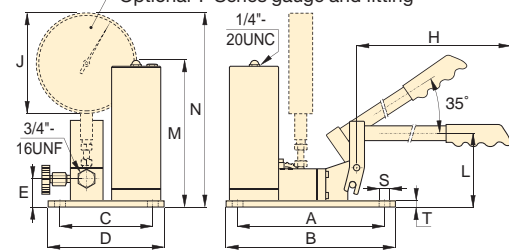

*NOTE: Maximum operating pressure for model 11-100 is 10,000 psi.

P-2282

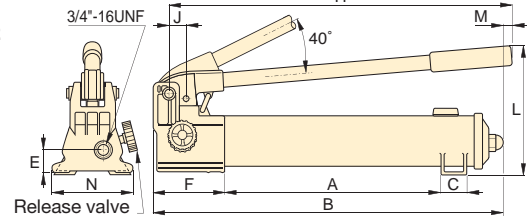

Piston Stroke	Dimensions (in)													Weight (lbs)	Model Number
	A	B	C	D	E	F	H	J	L	M	N	S	T		
1.00	13.56	22.00	1.40	—	1.24	5.25	20.75	1.16	9.00	.28	4.74	—	—	14	P-2282
.78	9.45	10.50	5.98	7.00	1.77	—	25.00	6.41	4.50	9.33	12.38	.31	.37	22	11-100
.78	9.45	10.50	5.98	7.00	1.77	—	25.00	6.41	4.50	9.33	12.38	.31	.37	22	11-400

▼ Shown: XC-1201



- Lightweight design with integrated handle and carrying strap for portability
- Bladder reservoir prevents contamination and allows pump usage in any position
- Powerful ½ horsepower motor and 28 volt Lithium-Ion battery deliver exceptional speed and run time
- High-strength fiberglass reinforced composite shroud for superior durability in demanding job site environments
- Cordless technology eliminates tripping hazards found in other powered pumps



Performance of a Powered Pump Portability of a Hand Pump



G2535L Gauge

Minimize the risk of overloading and ensure long dependable service from your cordless pump.

Page: 123



Battery packs contain no cadmium, so they are environmentally friendly. Enerpac encourages recycling.



28-Volt Battery

The XC-28V with Lithium-Ion technology for maximum battery performance.



Battery Charger

1-hour quick charger.

XC-115VC	115 VAC
XC-230VC	230 VAC



Hydraulic Swivel Connector

Customer installed swivel connector for optimal orientation of the hydraulic hose.

Order model number ¹⁾ XSC1

¹⁾ Accessories must be ordered separately.

◀ Power and simplicity for the toughest jobs.

Cordless Hydraulic Pump



XC-Series Cordless Hydraulic Pump

The XC-Series cordless pump is ideal for jobs using small to medium size cylinders and hydraulic tools, and is compatible with over 140 Enerpac tools and cylinders. These cordless pumps combine the performance of a powered pump with the portability of a hand pump making them a perfect solution for remote applications with limited or no access to a power supply or for locations where corded solutions present trip hazards.

The Lithium-Ion battery provides superior run time, even under extreme job site conditions.*

- 279 cuts of 3/8 inch reinforcing bar using the WHC-750 cutter
- 112 lifts with the WR-5 spreader
- 44 splits on 1-inch, grade 8 nuts using the NC-3241 nut splitter
- 28 lifts of an RC-104

The XC-Series cordless pump is CSA and CE compliant.

*Actual number of cycles per charge will vary depending on condition of tool, battery and ambient conditions.



XC Series



Reservoir Capacity:
60-120 in³

Flow at Rated Pressure:
15 in³/min.

Maximum Operating Pressure:
10,000 psi

- ① Outlet "Advance" Port
- ② Oil Fill (must use funnel)
- ③ User Adjustable Relief Valve Access Port
- ④ Directional Control Valve
- ⑤ Shoulder Strap Connection Points
- ⑥ Safety Lock Feature
- ⑦ On/Off Switch

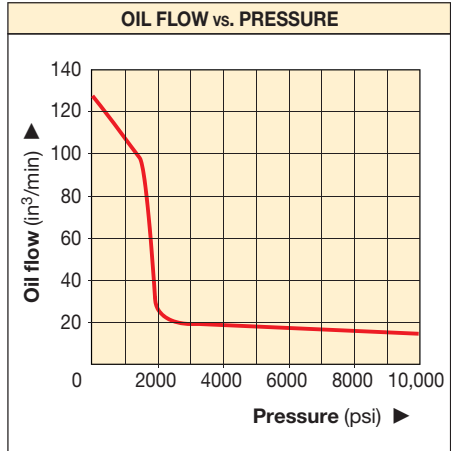
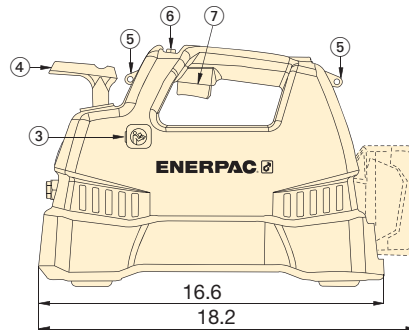
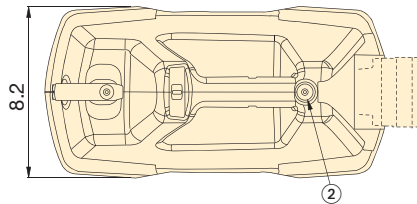
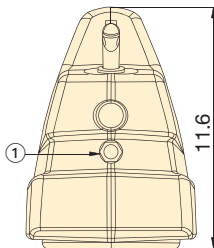

▼ Take the battery pump anywhere without power cords or air hoses.



▼ SELECTION CHART

Oil Capacity (in ³)	Model Number	Output Flow Rate (in ³ /min)			Valve Function	Charger Voltage (VAC)	Weight (lbs)
		No Load	2000 psi	10,000 psi			
60	XC-1201MB	125	30	15	3-way, 2-pos.	115	21.85
120	XC-1202MB	125	30	15			23.75
60	XC-1201ME	125	30	15	3-way, 2-pos.	230	21.85
120	XC-1202ME	125	30	15			23.75
60	XC-1201M*	125	30	15	3-way, 2-pos.	-	21.85
120	XC-1202M*	125	30	15			23.75

* Batteries and charger not included.

▼ Shown: PUJ-1200B



Heavy on Performance, Light on Weight

- Lightweight and compact design
- Large easy-carry handle for maximum portability
- Two-speed operation reduces cycle times for improved productivity
- 115 VAC 50/60-cycle universal motor will operate on voltages as low as 60 volts
- 24 VAC remote motor control, 10-ft length for operator safety
- Starts under full load
- High strength molded shroud with integral handle, protects motor from contamination and damage
- Designed for intermittent duty cycle



Gauges

Minimize the risk of overloading and ensure long, dependable service from your equipment. For use with the Economy pump the **G-2535L** gauge and **GA-3** gauge adaptor are suggested.

For a full range of gauges, please refer to the System Components section.

Page: 113



Speed Chart

To determine how the 0.5 hp Economy pump will operate your cylinder, see the Pump/Cylinder Speed Chart in the "Yellow Pages".

Page: 251

▼ An Economy Pump PUJ-1200B is used with an RC-2514 to reposition a stamping die to simplify maintenance.



Used with Cylinder	Usable Oil Capacity (gal)	Model Number*	Pressure Rating (psi)	
			1 st stage	2 nd stage
Single-acting	.50	PUD-1100B	200	10,000
	1.00	PUD-1101B	200	10,000
	.50	PUD-1300B	200	10,000
	1.00	PUD-1301B	200	10,000
	.50	PUJ-1200B	200	10,000
	1.00	PUJ-1201B	200	10,000
Double-acting	.50	PUJ-1400B	200	10,000
	1.00	PUJ-1401B	200	10,000



About the Economy Pump

The Economy pump is best suited to power small to medium size cylinders

or hydraulic tools. Its lightweight and compact design makes it ideal for applications which require easy transport of the pump.

The Universal motor works well on long extension cords or generator-driven electrical power supplies.

For further application assistance refer to the "Yellow Pages".

PUD-1100 Series

- Provides advance/auto-retract of single-acting cylinders
- Ideal for punching applications

- For applications not requiring load holding
- 10-ft pendant controls motor and valve operation

PUD-1300 Series

- Provides advance/hold/retract of single-acting cylinders
- 10-foot pendant controls motor and valve operation
- Ideal for applications requiring remote valve operation.

PUJ-Series

- Available with 3- and 4-way valves for single- or double-acting cylinders
- 10-ft pendant controls the motor operation
- Manual valves provide advance/retract tool control



Page: 244

* NOTE: CE conformity marking only applies to pumps with an "E" suffix.

PU Series



Reservoir Capacity:
0.5-1.0 gal.

Flow at Rated Pressure:
20 in³/min.

Motor Size:
.5 hp

Maximum Operating Pressure:
10,000 psi

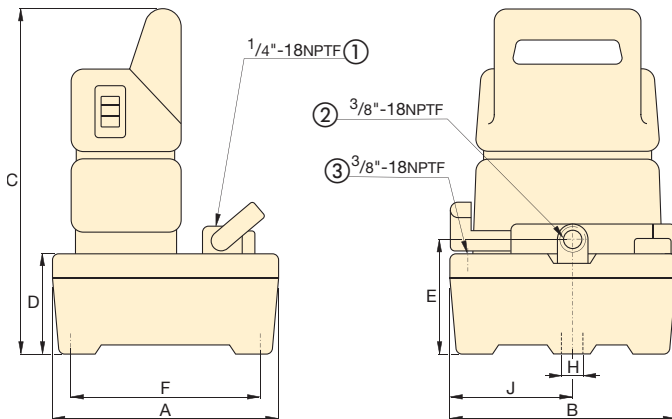

- ① Gauge Port (PUJ-1200/1201 only)
- ② Outlet Port
- ③ Tank Port

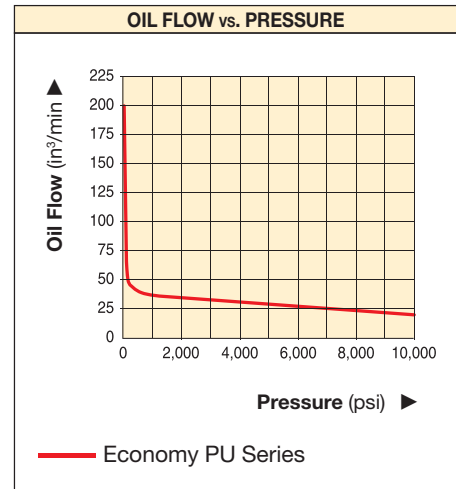

Output Flow Rate		Valve Type	Current Draw	Motor Voltage	Sound Level	Dimensions (in)								Weight	Model Number*
1 st stage	2 nd stage					A	B	C	D	E	F	H	J		
200	20	Dump **	9.5	115	85	9.62	9.62	14.25	4.00	4.72	8.00	.40	5.25	26	PUD-1100B
200	20		9.5	115	85	14.50	12.18	14.72	4.15	5.12	12.74	.40	5.62	35	PUD-1101B
200	20	Dump and Hold	9.5	115	85	9.62	9.62	14.25	4.00	4.72	8.00	.40	5.25	26	PUD-1300B
200	20		9.5	115	85	14.50	12.18	14.72	4.15	5.12	12.74	.40	5.62	35	PUD-1301B
200	20	3-way, 2-pos.	9.5	115	85	9.62	9.62	14.25	4.00	4.72	8.00	.40	5.25	24	PUJ-1200B
200	20		9.5	115	85	14.50	12.18	14.72	4.15	5.12	12.74	.40	5.62	31	PUJ-1201B
200	20	4-way, 3-pos.	9.5	115	85	9.62	9.62	14.25	4.00	4.72	8.00	.40	5.25	29	PUJ-1400B
200	20		9.5	115	85	14.50	12.18	14.72	4.15	5.12	12.74	.40	5.62	36	PUJ-1401B

* For 230 volt applications replace "B" suffix with "E". (CE conformity marking only applies to pumps with an "E" suffix.)

** Electric dump valve for auto-retract of cylinders.

▼ Shown: PEJ-1401B



- Two-speed operation reduces cycle times for improved productivity
- Powerful .5 hp induction motor is submerged in the oil reservoir to run cooler, protect the motor, simplify the pump interface, save space and reduce noise
- Large 1.5 gallon reservoir allows operation of a wide range of cylinders
- 24 VDC remote pendant control on certain models for safer operation
- Externally adjustable relief valve allows control of operating pressure without opening the pump
- 40-micron internal return line filter keeps oil clean, promoting longer pump life
- Full length side tube for easy monitoring of oil level



◀ The Remote Jog model of the Submerged Pump simplifies repair on this construction crane.

Best Performance for Mid-Range Cylinders and Tools

▼ SELECTION CHART

For more technical information see next page.

5 BASIC PUMP TYPES	
Select the model that suits your application. For special requirements see page 73 or contact your Enerpac office.	
PED-Series: with Dump Valve	
<ul style="list-style-type: none"> • Ideal for punching, crimping and cutting • For use when load holding is not required • Control pendant with 10 ft. cord controls valve and motor 	
PEM-Series: with Manual Valve	
<ul style="list-style-type: none"> • Ideal choice for most applications • Manual valve control, for both single-acting and double-acting applications • Manual motor control 	
PER-Series: with Solenoid Valve	
<ul style="list-style-type: none"> • Ideal for production and lifting • All valves are 3-position for Advance/Hold/Retract • Control pendant with 10 ft. cord for remote valve operation 	
PEJ-Series: with Remote Jog	
<ul style="list-style-type: none"> • For light production and lifting applications • Manual valve control for single-acting or double-acting cylinders • Control pendant with 10 ft. cord for remote motor operation 	
PES-Series: with Pressure Switch	
<ul style="list-style-type: none"> • Designed for maintaining pressure applications, such as clamping, workholding and testing • All versions include manual valves for directional control 	

* Contact Enerpac for details on VM style valves.

Submerged Electric Pumps



Submerged Pump Application

The Submerged pump is best suited to power small to medium size cylinders or hydraulic tools, or whenever a quiet, intermittent duty cycle is needed. With its low sound level and the addition of the optional oil cooler, the Submerged pump is suited to light production work as well.

Its lightweight and compact design also make it ideal for applications which require some transport of the pump.

For further application assistance see the "Yellow Pages" or contact your local Enerpac office.



Page: 244

* NOTE: CE conformity marking only applies to pumps with an "E" suffix.

PE Series



Reservoir Capacity:

1.5 gal.

Flow at Rated Pressure:

20 in³/min.

Motor Size:

.5 hp

Maximum Operating Pressure:

10,000 psi

Pump Type	Used with Cylinder	Valve Function	Valve Type*	Usable Oil Capacity	Model Number* 115 VAC, 1 ph	Weight (lbs)
				(gal)		
	Single-acting	Advance/Retract	Dump	1.5	PED-1101B	55
	Single-acting	Advance/Retract	Manual VMP 10000D	1.5	PEM-1201B	53
	Single-acting	Advance/Hold/Retract	Manual VMF 10000D	1.5	PEM-1301B	53
	Double-acting	Advance/Hold/Retract	Manual VMC 10000D	1.5	PEM-1401B	53
	Single-acting	Advance/Hold/Retract	Solenoid (VEF-15500D)	1.5	PER-1301B	65
	Double-acting	Advance/Hold/Retract	Solenoid (VEC-15600D)	1.5	PER-1401B	65
	Single-acting	Advance/Retract	Manual VMP 10000D	1.5	PEJ-1201B	55
	Single-acting	Advance/Hold/Retract	Manual VMF 10000D	1.5	PEJ-1301B	55
	Double-acting	Advance/Hold/Retract	Manual VMC 10000D	1.5	PEJ-1401B	55
	Single-acting	Advance/Retract	Manual VMP 10000D	1.5	PES-1201B	62
	Double-acting	Advance/Hold/Retract	Manual VMC 10000D	1.5	PES-1401B	62

* For 230 volt applications replace "B" suffix with "E". (CE conformity marking only applies to pumps with an "E" suffix.)

PE-Series, Submerged Electric Pumps

◀ For full features see page 72.

Submerged Pump Performance							
Motor Size	Pressure Rating		Output Flow Rate**		Motor Electrical Specifications*	Sound Level	Relief Valve Adjustment Range
	(psi)		(in ³ /min)				
	(hp)	1 st stage	2 nd stage	1 st stage			
0.5	1,000	10,000	150	20	13 @ 115-1-50/60 6.75 @ 230-1-50/60	62-70	1,000-10,000

* At bypass and maximum pressure. See matrix footnotes on next page for Hz limitations.
** All flow data at 60 Hz, 50 Hz data will be 5/6 th this number.

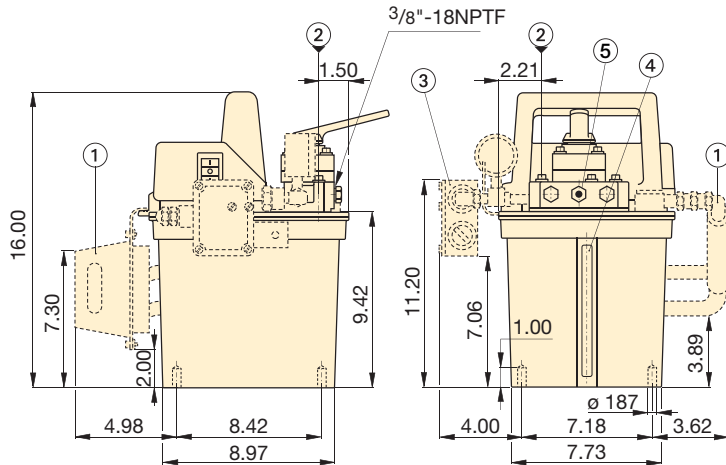

Dimensions shown in inches.

- ① Heat Exchanger (optional for all models)
- ② Fill Port
- ③ Pressure Switch (PES-Series, optional for other models)
- ④ Oil Level Indicator
- ⑤ Adjustable Relief Valve

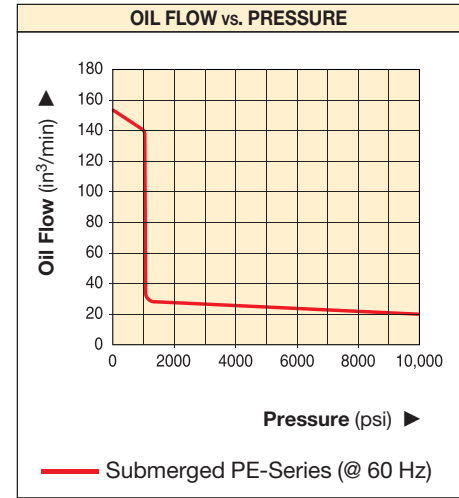

Speed Chart

To determine how a submerged pump will operate your cylinder, see the Pump/Cylinder Speed Chart in the "Yellow Pages".

Page: 251



◀ This PED-1101B Submerged pump quickly and quietly powers a hydraulic nut cutter in this bucket maintenance application.

Submerged Electric Pumps Ordering Matrix

CUSTOM BUILD YOUR SUBMERGED PUMP

If the Submerged Pump that would best fit your application cannot be found in the chart on page 72, you can easily build your custom submerged pump here.

▼ This is how a Submerged Pump Model Number is built up:

P	E	M	-	1	3	01	B
1 Product Type	2 Motor Type	3 Pump Type		4 Pump Series	5 Valve Type	6 Reservoir Size	7 Motor Voltage

1 Product Type

P = Pump

2 Motor Type

E = Electric motor

3 Pump Type

D = Dump
J = Jog
M = Manual
R = Remote (Solenoid)^{1) 2)}
S = Pressure switch

4 Pump Series

1 = .5 hp, 10,000 psi

5 Valve Type

0 = No valve (PER only)
1 = Dump
2 = 3-way, 2-position, normally open
3 = 3-way, 3-position, tandem center
4 = 4-way, 3-position, tandem center
5 = Modular valve (PER only)

6 Reservoir Size

01 = 1.5 gallon

7 Motor Voltage and Heat Exchanger

B = 115 V, 1 Ph, 60 Hz ¹⁾
D = 115 V, 1 Ph, 60 Hz ¹⁾
with heat exchanger
E = 230 V, 1 Ph, 50 Hz ²⁾
F = 230 V, 1 Ph, 50 Hz ²⁾
with heat exchanger
I = 230 V, 1 Ph, 60 Hz

¹⁾ Solenoid valves operate only at 60 Hz.
Can also run at 50 Hz with manual valve

²⁾ Solenoid valves operate only at 50 Hz.
Can also run at 60 Hz with manual valve

Ordering Example

Model Number: PER-1301B

The PER-1301B is a .5 hp, 10,000 psi, submerged electric pump, with 1.5 gallon usable oil capacity, a 3-way, 3-position modular, remote solenoid valve and a 115 V, 1 Phase, 60 Hz motor.

PE Series



Reservoir Capacity:

1.5 gal.

Flow at Rated Pressure:

20 in³/min.

Motor Size:

.5 hp

Maximum Operating Pressure:

10,000 psi



Hoses

Enerpac offers a complete line of high-quality hydraulic hoses. To ensure the integrity of your system, specify only genuine Enerpac hydraulic hoses.

Page: 114



Gauges

Minimize the risk of overloading and ensure long, dependable service from your equipment. Refer to the System Components section for a full range of gauges.

Page: 113



The **PER-1301B**, **PER-1401B**, **PER-1301D** and **PER-1401D** include a Modular (solenoid) Valve and pilot operating check.

Page: 110

Introducing the *Z-Class* power pumps from Enerpac – pumps that run cooler, use less electricity and are easy to service.



Enerpac has used the latest metallurgical, bearing and seal technologies to produce a pump whose features and benefits far surpass the electric pumps that are available today. By reducing the number of moving parts, improving flow dynamics and decreasing friction, *Z-Class* pumps will stay on the job longer, require less energy to operate and when needed, have lower service costs.

Z-Class electric pumps from Enerpac – simply the best pump you will ever use.



Z Tough.
Dependable.
Innovative.
ZCLASS

Z-Class Pumping Element — The Heart of Your Hydraulic System

Highly efficient design provides increased flow rates, reduced heat generation and a decrease in power consumption. This means improved tool speed and increased service life — which results in higher productivity and lower operating costs.

Heavy-duty bearings extend pump life by reducing friction, reducing surface-loading and lowering bearing stresses.

Pump cavity oil bath extends pump life by reducing heat, improving lubrication and reducing wear.

Self-priming, high-flow 1st stage pump increases pump performance by super-charging the 2nd stage piston pump — improving oil flow in both hot and cold weather operation.

Balanced rotating components reduce vibration creating a smoother running pump — reducing wear, friction and sound levels.

Replaceable piston check-valves increase service life of major pump components.

Ergonomic low-voltage pendant features sealed switches and operates at 24 VDC for improved operator safety.

Z-Class factory installed options & accessories

Extensive list of accessories including heat exchanger, roll-bars, skid bar, pressure transducer, return line filter and level and temperature switches, allow complete pump control over a wide range of industrial applications.

Z-Class electric pumps for your application

Available in one flow range for universal motor and 4 flow ranges for induction motor. Choose from single or two-stage models to provide the optimum cylinder and tool performance for almost any industrial application.

Pump Series	Motor Size (hp)	Flow @ 10,000 psi (in ³ /min)
ZU4	1.7	60
ZE3	1.0	40
ZE4	1.5	60
ZE5	3.0	120
ZE6	7.5	200

Back-lit LCD on select Z-Class pumps

- pump usage information, hour and cycle counts
- low-voltage warning and recording
- offers self-test and diagnostic capabilities
- information displayed in 6 languages
- pressure read-out (when used with the optional pressure transducer)
- adjustable trigger pressure setting (when used with the optional pressure transducer)



Back-lit LCD available on ZU and ZE-Series Electric Pumps ▶



ZU4 Series Pump Applications

- **Mobile:** when frequent pump transport is required and/or on remote locations
- **Universal motor:** 1-phase, runs well under poor voltage supply, using generator power supply or using long extension cord
- **Duty-cycle:** for intermittent applications
- **Cylinders and tools:** for medium to large size single and double-acting applications and high speed.



ZE Series Pump Applications

- **Stationary:** when pump remains in one location
- **Induction motor:** 1 and 3-phase for high-cycle usage
- **Duty-cycle:** for heavy-duty, extended cycle application
- **Cylinders and tools:** for medium to large size single- and double-acting applications and high speed

▼ Shown from left to right: ZU4304MB, ZU4420SB-H, ZU4304PB-K



Z Tough.
Dependable.
Innovative.
CLASS

▼ **COMMON PUMP MODELS**

For technical information and other options see next page.

- Features **Z-Class** high-efficiency pump design; higher oil flow and bypass pressure, cooler running and requires 18% less current draw than comparable pumps
- Powerful 1.7 hp universal electric motor provides high power-to-weight ratio and excellent low-voltage operating characteristics
- High-strength, molded composite shroud protects motor and electronics, while providing an ergonomic, non-conductive handle for easy transport
- Low-voltage pendant provides additional safety for the operator (remote control units)

Pro Series pump only

- LCD readout provides pressure and torque display and a number of diagnostic and readout capabilities never before offered on a portable electric pump
- AutoCycle feature provides continuous cycle operation of the torque wrench as long as the advance button is pressed (pump can be used with or without auto cycle feature)



◀ *Designed to be tough, the ZU4-Series with steel reservoirs will take the abuse of today's construction sites.*

BASIC PUMP TYPES	
Select the model that suits your application. For special requirements contact your Enerpac office.	
Manual Valve	<ul style="list-style-type: none"> • Ideal choice for most applications • Manual valve control, for single-acting or double-acting applications • Motor control on shroud
Manual Valve with Pendant	<ul style="list-style-type: none"> • For light production and lifting applications • Manual valve control for single-acting or double-acting cylinders • Low-voltage control pendant with 10-ft. cord for remote motor operation
Dump Valve	<ul style="list-style-type: none"> • Ideal for punching, crimping and cutting • For use when load-holding is not required • Low-voltage control pendant with 10-ft. cord controls valve and motor
Solenoid Valve	<ul style="list-style-type: none"> • Ideal for lifting applications and where remote control is required • Motor runs continuously on pumps with VE33 and VE43 valves. With VE32 valve, motor only runs during the advance function, while holding and retracting, the motor is off • Low-voltage control pendant with 10 ft. cord for remote motor and valve operation

ZU-Series, Electric Pumps



Z-Class – A Pump For Every Application

Patented Z-Class pump technology provides high

by-pass pressures for increased productivity – important in applications using long hose runs and high pressure-drop circuits, like heavy lifting or certain double-acting tools.

Enerpac ZU4 Hydraulic Pumps are built to power small to large-sized cylinders or hydraulic tools, or wherever high-speed, intermittent duty, remote hydraulic power is needed.

Classic Electric Pump

- The *Classic* has traditional electro-mechanical components (transformers, relays and switches) in place of solid-state electronics. The *Classic* delivers durable, safe

and efficient hydraulic power for demanding markets like construction, post-tensioning and foundation repair.

Standard Electric Pump

- For applications that do not require digital display features of the Premium Pump. Available in all manual or jog versions.

Pro Electric Pump

- Digital (LCD) display features a built-in hour meter and shows self-diagnostic, cycle-count and low voltage warning information.

Pressure can also be displayed when the pump is equipped with an optional pressure transducer.



ZU Series



Reservoir Capacity:

1.0-10.0 gal.

Flow at Rated Pressure:

60 in³/min.

Motor Size:

1.7 hp

Maximum Operating Pressure:

10,000 psi

Pump Type	Used with Cylinder	Valve Function	Valve Type ²⁾	Pump Control	Usable Oil Capacity (gal)	Model Number 115 VAC ³⁾ 1 Phase			Pro Product Weight with oil ⁴⁾ (lbs)	
						Classic	STD Electric	Pro Electric		
	●	●	●	VM22	Manual	1.0	ZU4704RB	ZU4704MB	ZU4704LB	59
	●	●	●	VM22	Manual	2.0	ZU4708RB	ZU4708MB	ZU4708LB	69
	●	●	●	VM33	Manual	2.0	ZU4308RB	ZU4308MB	ZU4308LB	70
	●	●	●	VM33	Manual	5.0	ZU4320RB	ZU4320MB	ZU4320LB	109
	●	●	●	VM43	Manual	2.0	ZU4408RB	ZU4408MB	ZU4408LB	70
	●	●	●	VM43	Manual	5.0	ZU4420RB	ZU4420MB	ZU4420LB	109
	●	●	●	VM22	Remote (Man.)	1.0	ZU4704PB	ZU4204JB	ZU4204KB	60
	●	●	●	VM22	Remote (Man.)	2.0	ZU4708PB	ZU4208JB	ZU4208KB	70
	●	●	●	VM22	Remote (Man.)	5.0	ZU4720PB	ZU4220JB	ZU4220KB	109
	●	●	●	VM33	Remote (Man.)	2.0	ZU4308PB	ZU4308JB	ZU4308KB	71
	●	●	●	VM43	Remote (Man.)	2.0	ZU4408PB	ZU4408JB	ZU4408KB	71
	●	●	●	VM43	Remote (Man.)	5.0	ZU4420PB	ZU4420JB	ZU4420KB	110
	●	●	●	VE32D	Remote	1.0	N/A	N/A	ZU4104DB	63
	●	●	●	VE32D	Remote	2.0	N/A	N/A	ZU4108DB	73
	●	●	●	VE32D	Remote	5.0	N/A	N/A	ZU4120DB	112
				–	–	–	–	–	–	–
				–	–	–	–	–	–	–
				–	–	–	–	–	–	–
	●	●	●	VE32	Remote	1.0	N/A	N/A	ZU4204SB	63
	●	●	●	VE32	Remote	2.0	N/A	N/A	ZU4208SB	73
	●	●	●	VE33	Remote	2.0	N/A	N/A	ZU4308SB	85
	●	●	●	VE43	Remote	2.0	N/A	N/A	ZU4408SB	85
	●	●	●	VE43	Remote	5.0	N/A	N/A	ZU4420SB	124
				–	–	–	–	–	–	–
				–	–	–	–	–	–	–
				–	–	–	–	–	–	–

¹⁾ CE conformity marking only applies to pumps with an "E" suffix. "E" voltage versions also meet all requirements of the European EMC-Directive.

²⁾ See valves section for technical information on valve types.

³⁾ See custom order matrix for other voltage options.

⁴⁾ Subtract 3 lbs. for STD Electric models.

ZU Series, Specifications and Dimensions

ZU4 Performance							
Motor Size (hp)	Output Flow Rate (in ³ /min)				Motor Electrical Specification (volts-ph-Hz)	Sound Level (dBA)	Relief Valve Adjustment Range (psi)
	100 psi	700 psi	5000 psi	10,000 psi			
1.7	700	535	76	60	115-1-50/60 230-1-50/60	85-90	2,000-10,000

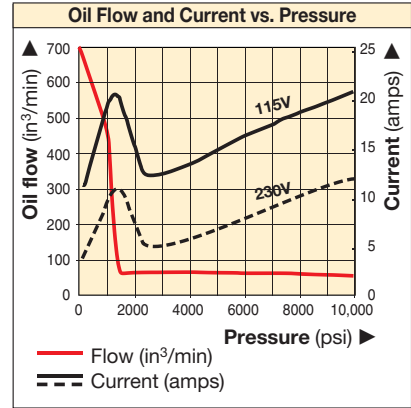

ZU-4 Series with 1 and 2 gallon reservoirs

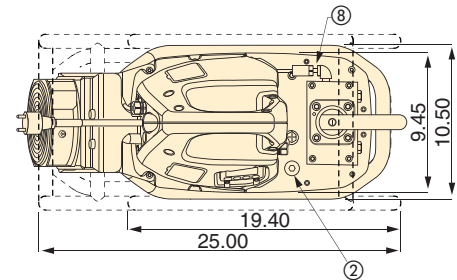
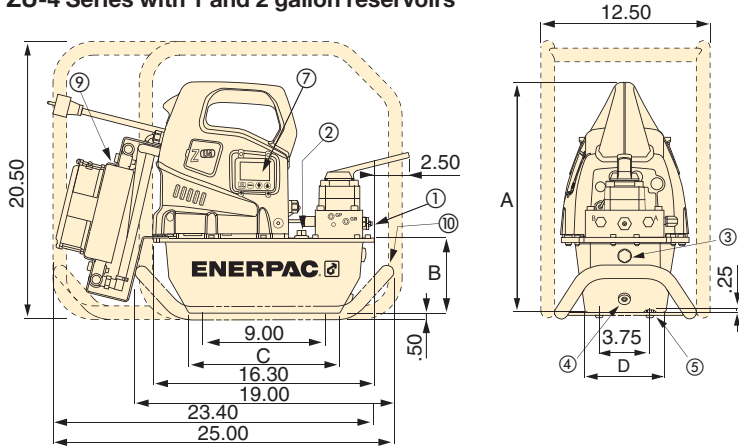

ZU-4 Series with 2.5, 5.0 and 10.0 gallon reservoirs (Left view shown without side handle)

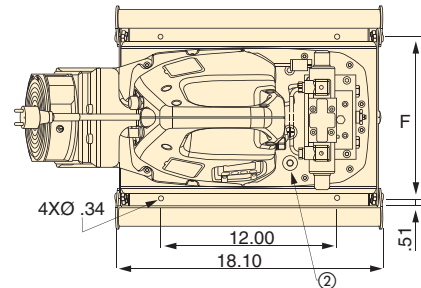
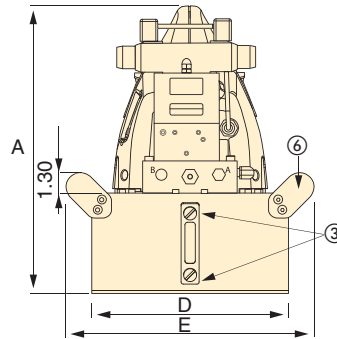
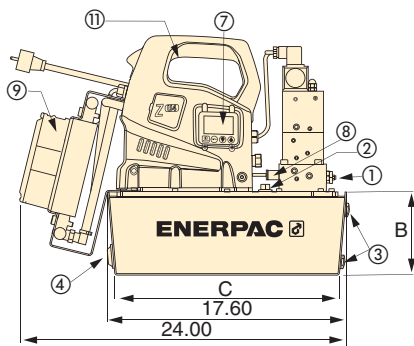

- ① User adjustable relief valve
- ② Oil fill port, SAE#10
- ③ Oil level sight gauge
- ④ Oil Drain, 1/2" NPTF
- ⑤ M8 x 1.25
- ⑥ Handles on all 2.5, 5.0, and 10.0 gallon reservoirs

Factory installed features and options

- ⑦ Back-lit LCD Electric
- ⑧ Pressure transducer
- ⑨ Heat exchanger
- ⑩ Skid bar
- ⑪ Handle guard installed on all 2.5, 5, and 10 gallon reservoirs
- ⑫ Reservoir handles included on all 2.5, 5 and 10 gallon pumps



◀ Increased output flow and extended brush life increase productivity for post-tensioning applications.

Usable Reservoir Capacity (gal)	Pump Dimensions (in)					
	A	B	C	D	E	F
1.0	16.7	5.6	11.0	6.0	-	-
2.0	16.7	5.6	11.0	8.1	-	-
2.5	17.3	6.2	16.5	12.0	15.1	11.0
5.0	18.3	7.1	16.5	16.6	19.7	15.6
10.0	21.7	10.6	15.7	19.9	22.7	18.9

ZU-Series, Ordering Matrix

CUSTOM BUILD YOUR ZU4 SERIES PUMP

If the ZU4 Series pump that would best fit your application cannot be found in the chart on page 79, you can easily build your custom ZU4 Series pump here.

▼ This is how a ZU-Series pump model number is built up:

Z	U	4	4	08	L	B	-	H	K	T	
1	2	3	4	5	6	7			8		
Product Type	Motor Type	Flow Group	Valve Type	Reservoir Size	Valve Operation	Voltage			Options and Accessories		

1 Product Type

Z = Pump Series

2 Motor Type

U = Universal electric motor

3 Flow Group

4 = 60 in³/min @ 10,000 psi

4 Valve Type (see page 110 for more details)

- 1 Dump (VE32D)
- 2 3 way/2 position manual or electric (VM32 or VE32)
- 3 3 way/3 position manual or electric (VM33 or VE33)
- 4 4 way/3 position manual or electric (VM43 or VE43)
- 6 3 way/3 position locking manual w/po check (VM33-L)
- 7 3 way/2 position manual (VM22)
- 8 4 way/3 position locking manual w/po check (VM43-L)
- 9 4 way/3 position manual w/power seating (VM43-LPS)

5 Reservoir Size (useable capacity)

- 04** = 1.0 gallon
- 08** = 2.0 gallon
- 10** = 2.5 gallon (includes side handles)
- 20** = 5.0 gallon (includes side handles)
- 40** = 10.0 gallon (includes side handles)

6 Valve Operation

- D** = Dump (solenoid valve w/pendant and LCD Electric)
- J** = Jog (manual valve w/pendant and Standard Electric (i.e. w/o LCD)
- K** = Jog (manual valve w/pendant and LCD Electric)
- L** = Manual valve w/LCD Electric (w/o pendant)
- P** = Manual valve w/pendant and classic electric (i.e. w/o LCD)
- R** = Manual valve w/Classic electric (i.e. w/o LCD) [w/o pendant]
- M** = Manual valve w/Standard Electric (i.e. w/o LCD) [w/o pendant]
- S** = Solenoid valve w/pendant and LCD Electric

7 Voltage

- B** = 115V, 1 ph, 50/60Hz
- E** = 208-240V, 1 ph, 50/60 Hz (w/European plug and CE EMC compliant)
- I** = 208-240V, 1 ph, 50/60 Hz (w/NEMA 6-15 plug)

8 Options and Accessories (see page 82 for possibilities)

- F** = Filter
- G** = 0-15,000 psi gauge (2½") ¹⁾
- H** = Heat exchanger
- K** = Skidbar (1 and 2 gallon reservoirs only)
- L** = Level/temp switch ²⁾³⁾
- N** = No reservoir handles (includes lifting eyes)
- R** = Roll cage
- T** = Pressure transducer ²⁾
- U** = Foot switch

¹⁾ Pressure gauge not available on pump models with pressure transducer

²⁾ These options require LCD electric

³⁾ Not available on 1 and 2 gallon reservoirs

ZU Series



Reservoir Capacity:
1.0-10.0 gal.

Flow at Rated Pressure:
60 in³/min.

Motor Size:
1.7 hp

Maximum Operating Pressure:
10,000 psi



Speed Chart

To determine how a "Z" pump will operate your cylinder, see the Pump/Cylinder Speed Chart in the "Yellow Pages".

Page: **251**



Ordering Example

Model Number:
ZU4408LB-HKT

ZU4408LB-HKT is a 60 in³/min at 10,000 psi pump with a 4-way, 3-position manual valve, a 2 gal. (8-liter) reservoir, operates on 115V, 1ph, 50/60 Hz and is specified with optional LCD electrical panel, heat exchanger, pressure transducer and skidbar.



Torque Wrench Pumps

System matched air and electric pumps provide control to operate Enerpac Torque Wrenches.

Page: **202**



Pressure Transducer*

- More durable than analog gauges (against mechanical and hydraulic shock)
- More accurate than analog gauges (0.5% full scale of pump)
- Calibration can be fine tuned for certification
- “Set pressure” feature turns off motor at user defined pressure (or shifts valve to neutral on models with VE33/VE43 valves)
- Display pressure in psi, bar, or MPa

* Requires LCD Electric

Accessory Kit Model Number	Adjustable Pressure Range (psi)	Switch-point repeatability	Dead-band (psi)
ZPT-U4 *	50-10,000	± 0,5%	50

* Add suffix T for factory installation.



Level/Temperature Switch

- Ensures feedback on pump oil level and temperature
- Drop-in design allows for easy installation to pump reservoir
- Plugs directly into pump electrical enclosure
- Built-in thermal sensing shuts off pump when unsafe operating temperature is reached
- Oil level switch shuts down pump before oil reaches an unsafe operating level

Model Number	Operating Temperature (° F)	Maximum Pressure (psi)	Weight (lbs)
ZLS-U4	40-230	150	.11

* Add suffix L for factory installation.



Hoses

Enerpac offers a complete line of high-quality hydraulic hoses. To ensure the integrity of your system, specify only Enerpac hydraulic hoses.

Page: 114



Gauges

Minimize the risk of overloading and ensure long, dependable service from your equipment. Refer to the System Components section for a full range of gauges.

Page: 113



Foot Switch

- Hands-free remote control on solenoid dump and 3-position valves
- With 10 foot cord

Accessory Kit No.	Can be used on ZU4 Pumps with
ZCF-2 *	Solenoid VE-Series valves

* Add suffix U for factory installation.



Roll Cage

- Protects pump
- Provides greater pump stability

Accessory Kit Number	Fits on Reservoir
ZRC-04 *	1 and 2 gallon ¹⁾
ZRC-04H *	1 and 2 gallon ²⁾
ZRB-10 *	2.5 gallon
ZRB-20 *	5 gallon
ZRB-40 *	10 gallon

* Add suffix R for factory installation.

¹⁾ Without heat exchanger ²⁾ With heat exchanger

Ordering Example:
Model No. ZU4208BB-QR



Skidbar*

- Provides easy two-hand lift
- Provides greater pump stability on soft or uneven surfaces
- Also available as an add-on kit (model number SBZ-4)

* 1 and 2 gallon reservoirs only

Accessory Kit No.	For ZU-Series Pumps with Reservoir	Wt. (lbs)
SBZ-4 *	1-2 gal. w/o heat exchanger	4.9
SBZ-4L *	1-2 gal. with heat exchanger	5.5

* Add suffix K for factory installation.

ZU-Series Factory Installed Options and Accessories



ZU4-Series Options

Accessory Kits can be installed by the customer.

See chart below for all possible options on ZU4-Series pumps:

- Classic Electric,
 - Standard (STD) Electric (no LCD)
 - Pro Electric (with LCD).
- Refer to page 81 for ordering matrix.

ZU4-Series Options	Factory Installed			Accessory Kits		
	Classic Electric	Standard Electric	Pro Electric	Classic Electric	Standard Electric	Pro Electric
Return Line Filter	F	F	F	ZPF	ZPF	ZPF
Skid Bar ¹⁾	K	K	K	SBZ	SBZ	SBZ
Roll Cage	R	R	R	ZRC	ZRC	ZRC
Heat Exchanger	H	H	H	ZHE	ZHE	ZHE
Pressure Gauge	G	G	G	G	G	G
Pressure Transducer	-	-	T	-	-	ZPT-U4
Level/Temperature Switch	-	-	L	-	-	ZLS-U4
Foot Switch	-	-	U	-	-	ZCF-2

¹⁾Skid Bar not in combination with Roll Cage.

ZU Series



Reservoir Capacity:

1.0-10.0 gal.

Flow at Rated Pressure:

60 in³/min.

Motor Size:

1.7 hp

Maximum Operating Pressure:

10,000 psi



Return Line Filter

- 25 micron nominal filter removes contaminants from return oil flow before allowing it back into tank
- Internal by-pass valve prevents damage if filter is dirty
- With maintenance indicator

Accessory Kit Model Number	Maximum Pressure (psi)	Maximum Oil Flow (GPM)	By-pass Setting (psi)
ZPF *	200	12.0	25

* Add suffix F for factory installation.



Heat Exchanger

- Removes heat from the bypass oil to provide cooler operation
- Stabilizes oil viscosity, increasing oil life and reduces wear of pump and other hydraulic components

Accessory Kit No. *	Can be used on
ZHE-U115	115V pumps
ZHE-U230	230V pumps

* Add suffix H for factory installation.



Heat Exchanger

- Extends system life
- Stabilizes oil temperature at a maximum of 130° F at 70° F ambient temperature.

Do not exceed maximum oil flow and pressure ratings. Heat exchanger is not suitable for water-glycol or high water based fluids.

Thermal Transfer *	Maximum pressure (psi)	Maximum oil flow (GPM)	Voltage (VDC)
Btu/h	900	7.0	12

* At GPM at 70 °F ambient temperature.

▼ Shown from left to right: ZE3304MB-K, ZE4110DB-FHR



Z-Class





The New Standard for Industrial Applications



Oil Level Indicators

All ZE pumps feature an oil level indicator—sight glasses on the 1 and 2 gallon reservoirs and oil level gauges on the 2.5, 5 and 10 gallon reservoirs.

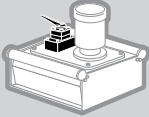
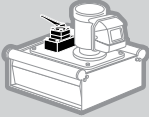
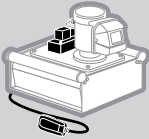
▼ SELECTION CHART *

BASIC PUMP CONFIGURATIONS Select your ZE pump model here for most applications. For special requirements, see the ZE Pump ordering matrix.		Pump Type	Used with Cylinder			Valve** Model Number	Useable Oil Capacity (gal)		
									
MANUAL VALVE CONTROL	Manual Valve without electric box or LCD • Ideal choice for most applications • Manual valve control, for both single-acting or double-acting applications • Manual motor control • On/off switch on 1-phase electric motor		●	—	●	—	●	VM32	2.0
			●	—	●	●	●	VM33	2.0
			●	—	●	●	●	VM33	5.0
			●	—	●	●	●	VM33	10.0
			—	●	●	●	●	VM43	2.0
			—	●	●	●	●	VM43	5.0
			—	●	●	●	●	VM43	10.0
	Manual Valve with electric box and LCD • Ideal choice for most applications • Manual valve control, for both single-acting or double-acting applications • Manual motor control		●	—	●	—	●	VM32	2.0
			●	—	●	—	●	VM32	2.5
			●	—	●	●	●	VM33	5.0
●			—	●	●	●	VM33	10.0	
—			●	●	●	●	VM43	5.0	
—			●	●	●	●	VM43	10.0	
REMOTE VALVE CONTROL	Solenoid Dump Valve with electric box and LCD • Ideal for punching, crimping and cutting • For use when load holding is not required • Push-button control pendant with 10 ft. cord controls the valve and motor		●	—	●	—	●	VE32D	1.0
			●	—	●	—	●	VE32D	2.0
			●	—	●	—	●	VE32D	2.5
			●	—	●	—	●	VE32D	5.0
			●	—	●	—	●	VE32D	10.0
	Solenoid 3-position Valve with Electric Box and LCD • Ideal for production and lifting applications • All valves are 3-position for Advance-Hold-Retract • Push-button control pendant with 10 ft. cord controls the valve and motor		●	—	●	●	●	VE33	2.0
			●	—	●	●	●	VE33	2.5
			●	—	●	●	●	VE33	5.0
			—	●	●	●	●	VE43	2.0
			—	●	●	●	●	VE43	2.5
			—	●	●	●	●	VE43	5.0
			—	●	●	●	●	VE43	10.0

* Models in this chart are 115 VAC, 1-phase at 50/60 Hz for ZE3-4 or 220 VAC, 3 phase at 50/60 Hz for ZE5-6. For other options, please refer to the ZE Pump ordering matrix. ** See Valve Section for technical information.

ZE-Series Electric Pumps

- Features **Z-Class** high-efficiency pump design; higher oil flow and by-pass pressure, cooler running and requires 18% less current draw than comparable pumps
- Totally enclosed, fan-cooled industrial electric motors supply extended life and stand up to harsh industrial environments
- Low-voltage pendant, on certain models, provides additional safety for the operator
- Multiple valve and reservoir configurations provide application specific models to match the most demanding industrial applications
- High-strength, molded electrical enclosure protects electronics, power supplies and LCD readout from harsh industrial environments
- LCD readout provides a number of diagnostic and readout capabilities never before offered on an industrial pump (included with electric valve models, optional on other models)
- IP54 Rating for superior dust and water protection

ZE Series



Reservoir Capacity:
1.0-10.0 gal.

Flow at Rated Pressure:
40-200 in³/min

Motor Size:
1.0-7.5 hp

Maximum Operating Pressure:
10,000 psi



User Adjustable Relief Valve

All VM and VE-Series have a user adjustable relief valve to allow the operator to easily set the optimum working pressure.



Locking Valves

For applications requiring positive load holding, VM-Series valves (except VM32) are available with a pilot-operated check valve. This provides hydraulic locking of the load until the valve is shifted into the retract position. To order this feature on your ZE-series pump see the valve type in the order matrix.

Page: 108



Single-Stage or Two-Stage

Choose single-stage pumps for applications that require constant flow regardless of pressure, such as testing or clamping. Two-stage pumps have an increased output flow at low pressure to allow fast movement towards the load, for reduced cycle times and increased productivity. To specify a single-stage pump, place the letter "S" at the end of the model number.

For example: **ZE5320LG-S**

ZE3 Series (1.0 hp) Output Flow Rate at 10,000 psi: 40 in ³ /min		ZE4 Series (1.5 hp) Output Flow Rate at 10,000 psi: 60 in ³ /min		ZE5 Series (3.0 hp) Output Flow Rate at 10,000 psi: 120 in ³ /min		ZE6 Series (7.5 hp) Output Flow Rate at 10,000 psi: 200 in ³ /min	
Model Number	Wt. (lbs)	Model Number	Wt. (lbs)	Model Number	Wt. (lbs)	Model Number	Wt. (lbs)
ZE3208MB	91	ZE4208MB	100	-	-	-	-
ZE3308MB	92	ZE4308MB	101	-	-	-	-
ZE3320MB	132	ZE4320MB	141	ZE5320MG	152	ZE6320MG	191
ZE3340MB	183	ZE4340MB	192	ZE5340MG	203	ZE6340MG	242
ZE3408MB	92	ZE4408MB	101	-	-	-	-
ZE3420MB	132	ZE4420MB	141	ZE5420MG	152	ZE6420MG	191
ZE3440MB	183	ZE4440MB	192	ZE5440MG	203	ZE6440MG	242
ZE3208LB	96	ZE4208LB	105	-	-	-	-
ZE3210LB	109	ZE4210LB	112	ZE5210LG	132	ZE6210LG	171
ZE3320LB	138	ZE4320LB	146	ZE5320LG	160	ZE6320LG	199
ZE3340LB	188	ZE4340LB	197	ZE5340LG	210	ZE6340LG	249
ZE3420LB	138	ZE4420LB	145	ZE5420LG	160	ZE6420LG	199
ZE3440LB	189	ZE4440LB	197	ZE5440LG	210	ZE6440LG	250
ZE3104DB	94	ZE4104DB	103	-	-	-	-
ZE3108DB	105	ZE4108DB	109	-	-	-	-
ZE3110DB	114	ZE4110DB	122	ZE5110DG	136	ZE6110DG	175
ZE3120DB	141	ZE4120DB	149	ZE5120DG	163	ZE6120DG	202
ZE3140DB	190	-	-	-	-	-	-
ZE3308SB	112	ZE4308SB	121	-	-	-	-
ZE3310SB	125	ZE4310SB	134	ZE5310SG	147	ZE6310SG	187
ZE3320SB	152	ZE4320SB	161	ZE5320SG	174	ZE6320SG	213
ZE3408SB	112	ZE4408SB	121	-	-	-	-
ZE3410SB	125	ZE4410SB	134	ZE5410SG	147	ZE6410SG	187
ZE3420SB	152	ZE4420SB	161	ZE5420SG	174	ZE6420SG	213
ZE3440SB	203	ZE4440SB	212	ZE5440SG	225	ZE6440SG	264

* All models in this chart are 115 VAC, 1-phase at 50/60 Hz. For other options please refer to the ZE Pump ordering matrix.

ZE-Series, Specifications and Dimensions

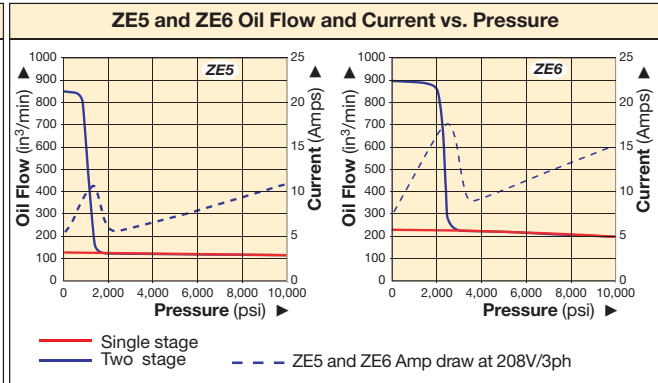
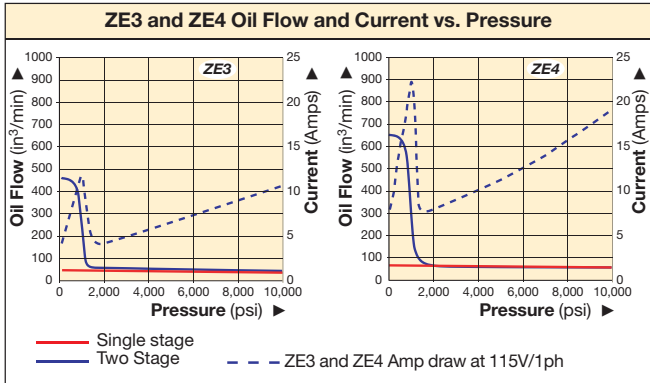

▼ PERFORMANCE CHART

Pump Series	Operation	Output Flow Rate (in ³ /min)				Available Reservoir Sizes (useable oil) (gal)	Motor Size		Relief Valve Adjustment Range (psi)	Sound Level (dBA)
		100 psi	700 psi	5,000 psi	10,000 psi		hp	RPM		
ZE3	Single-stage	43	43	42	40	1, 2, 2.5, 5, 10	1.0	1750	1000-10,000	75
	Two-stage	450	385	42	40					
ZE4	Single-stage	64	64	62	60	1, 2, 2.5, 5, 10	1.5	1750	1000-10,000	75
	Two-stage	650	600	62	60					
ZE5	Single-stage	128	126	123	120	2.5, 5, 10	3.0	1750	1000-10,000	75
	Two-stage	850	825	123	120					
ZE6	Single-stage	220	215	210	200	2.5, 5, 10	7.5	3450	1000-10,000	80
	Two-stage	900	890	210	200					

Output flow rate is listed at 60 Hz. Flow rate will be approximately 5/6 of these values at 50 Hz.

ZE-Series Pumps with 1 and 2 gallon reservoir

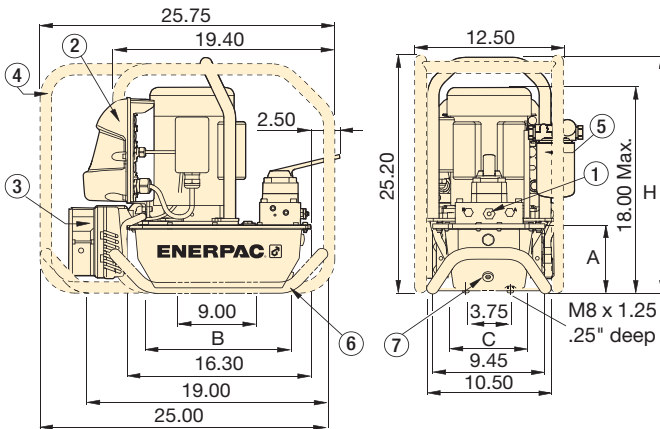

ZE-Series Pumps with 2.5, 5, 10 gallon reservoir

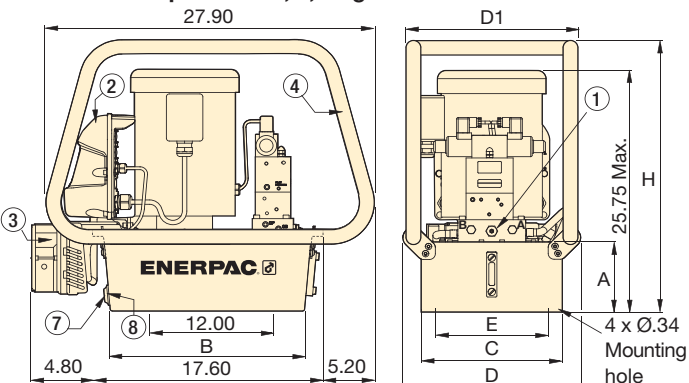

i Single-Stage or Two-Stage Pumps

Choose single-stage pumps for applications that require constant flow regardless of pressure, such as testing or clamping.

Two-stage pumps have an increased output flow at low pressure to allow fast movement towards the load, for reduced cycle times and increased productivity.

- ① User adjustable relief valve on all manual and solenoid valves:
 3/8" NPTF on A and B ports
 1/4" NPTF on auxiliary ports
- ② Electric Box (Optional w/manual valve)
- ③ Heat Exchanger (Optional)
- ④ Roll Bar (Optional)
- ⑤ Return Line Filter (Optional)
- ⑥ Skid Bar (Optional)
- ⑦ Oil Drain
- ⑧ Oil Level/Temperature Switch (Optional)

Reservoir Size (useable oil) (gal)	ZE-Series Pump Dimensions (in)					
	A	B	C	D	D1	H
1.0	5.6	11.0	6.0	-	-	20.2
2.0	5.6	11.0	8.1	-	-	20.2
2.5	6.2	16.5	12.0	15.1	14.6	11.0
5.0	7.1	16.5	16.6	19.7	19.2	15.6
10.0	10.6	15.7	19.9	22.7	22.5	18.9

ZE Series Electric Pump Ordering Matrix

CUSTOM BUILD YOUR ZE SERIES PUMP

If the ZE Series pump that would best fit your application cannot be found in the chart on page 85, you can easily build your custom ZE Series pump here.

▼ This is how a ZE Series Pump model is built up:

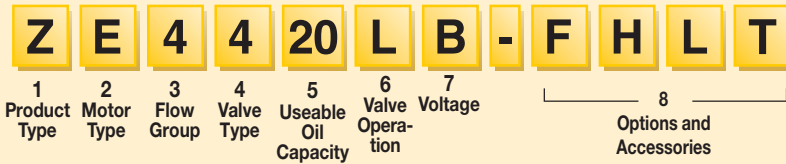

1 Product Type

Z = Pump Class

2 Prime movers

E = Induction Electric Motor

3 Flow Group

- 3** = 40 in³/min @ 10,000 psi
- 4** = 60 in³/min @ 10,000 psi
- 5** = 120 in³/min @ 10,000 psi¹⁾
- 6** = 200 in³/min @ 10,000 psi¹⁾

4 Valve Types

- 0** = No valve w/coverplate
- 1** = Dump (VE32D)
- 2** = 3 way/2 position manual (VM32)
- 3** = 3 way/3 position manual or electric (VM33 or VE33)
- 4** = 4 way/3 position manual or electric (VM43 or VE43)
- 6*** = 3 way/3 position locking manual w/po check (VM33L*)
- 7** = 3 way/2 position manual (VM22)
- 8** = 4 way/3 position locking manual w/po check (VM43L)

5 Useable Oil Capacity

- 04** = 1.0 gallon²⁾
- 08** = 2.0 gallon²⁾
- 10** = 2.5 gallon
- 20** = 5.0 gallon
- 40** = 10.0 gallon

6 Valve Operation

- D** = Dump valve (w/ pendant and LCD)
- L** = Manual valve (w/o pendant, w/ LCD)
- M** = Manual valve⁶⁾ (w/o pendant or LCD)
- N** = No valve⁶⁾ (no electrical box)
- S** = Solenoid valve (w/ pendant and LCD)
- W** = No valve (w/o pendant and LCD)

7 Voltages

Single Phase

- B** = 115V 1 ph 50-60Hz³⁾
- E** = 208-240V 1 ph 50-60 Hz European Plug
- I** = 208-240V 1 ph 50-60 Hz USA Plug

Three Phase⁶⁾

- M** = 190-200V 3ph 50-60Hz
- G** = 208-240V 3ph 50-60Hz
- W** = 380-415V 3ph 50-60Hz
- K** = 440V 3ph 50-60Hz
- J** = 460-480V 3ph 50-60Hz
- R** = 575V 3ph 60Hz

8 Options and Accessories (see page 88 for possibilities)

- F** = Filter
- G** = 0-15,000 psi gauge (2 1/2")⁷⁾
- H** = Heat exchanger⁴⁾
- K** = Skidbar (1 and 2 gal. reservoirs only)
- L** = Level/temp switch^{4) 5)}
- N** = No reservoir handles (includes lifting eyes)
- P** = Pressure switch⁴⁾
- R** = Roll cage
- S** = Single stage
- T** = Pressure transducer^{4) 7)}
- U** = Foot switch⁴⁾

- 1) ZE5 and ZE6 series pumps only available with 3-phase motors.
- 2) 1 and 2 gallon reservoirs only available on ZE3 and ZE4 series pumps.
- 3) 115 volt pumps are supplied with 15 amp plug for intermittent use. 20 amp circuit recommended for frequent full pressure use.
- 4) These options require LCD electrical package. Pressure switch option only available on manual valves without locking valve. The LCD electrical package can accept either a pressure switch or pressure transducer, but not both.
- 5) Not available with 1 and 2 gallon reservoirs.
- 6) Standard Electric models with 3-phase motors are shipped without cord, motor starter or overload protection.
- 7) Pressure gauge not available on pump models with pressure transducer. Pressure transducer provides digital pressure readout on LCD display.

* Not available on ZE5 or ZE6 Series Pumps

ZE Series



Reservoir Capacity:

1.0-10.0 gal.

Flow at Rated Pressure:

40-200 in³/min.

Motor Size:

1.0-7.5 hp

Maximum Operating Pressure:

10,000 psi



Ordering Example 1

Model Number: ZE4420MB

ZE4420MB is a 60 in³/min, 10,000 psi pump with a 4 way, 3-position manual valve, a 5 gallon reservoir, operates on a 115 VAC 1 ph 50/60 Hz motor and includes standard electrical package.

Ordering Example 2

Model Number: ZE6440SG-HNU

ZE6440SG-HNU is a 200 in³/min, 10,000 psi pump with a 4 way, 3-position electric valve, a 10 gallon reservoir, operates on a 230 VAC 3 ph 50/60 Hz motor. It includes LCD electrical package and foot switch on 10 ft cord, no reservoir handles and the optional heat exchanger.



Pendants

When ordering Enerpac VE-Series solenoid valve for use on "W" type valve operation (no Valve, with Electric Box [LCD], without pendant) the pendant must be ordered separately. Pendant connection to be plugged into electric box.



Electric Box ¹⁾

- Back-lit LCD
- Pump usage information, hour and cycle counts
- Low-voltage warning and recording
- Self-test and diagnostic capabilities
- Pressure read-out ²⁾
- Auto-mode pressure setting ²⁾
- Information can be displayed in six languages ³⁾

¹⁾ Included on pumps with solenoid valves. Can be factory installed on pumps with manual valve

²⁾ When used with optional pressure transducer

³⁾ English, French, German, Italian, Spanish and Portuguese



Level/Temperature Switch ⁴⁾

- Shuts down pump before oil level reaches an unsafe level, avoiding damage due to cavitation
- Shuts down pump when unsafe oil temperature is reached
- Ideal if pump is used in remote area without visual access to oil level

⁴⁾ 24 V, requires Electric Box. Available for 2.5, 5 and 10 gallon reservoirs

Accessory Kit Model Number	Fixed Temperature Signal (°F)	Operating Temperature (°F)	Max. Pressure (psi)
ZLS-U4 *	75	40 - 230	150

* Add suffix **L** for factory installation, see ordering matrix.



Return Line Filter

- 25 micron nominal filter removes contaminants from return oil flow before allowing it back into tank
- Internal by-pass valve prevents damage if filter is dirty
- With maintenance indicator
- Replaceable filter element PF25

Accessory Kit Model Number	Maximum Pressure (psi)	Maximum Oil Flow (GPM)	By-pass Setting (psi)
ZPF *	200	12.0	25

* Add suffix **F** for factory installation, see ordering matrix.



Roll Cage

- For easy portability and hoisting
- Protects pump and electric box
- Available for all reservoir sizes

Accessory Kit Number	Fits on Reservoir
ZRC-04 *	1 and 2 gallon ¹⁾
ZRC-04H *	1 and 2 gallon ²⁾
ZRB-10 *	2.5 gallon
ZRB-20 *	5 gallon
ZRB-40 *	10 gallon

* Add suffix **R** for factory installation, see ordering matrix.
¹⁾ Without heat exchanger ²⁾ With heat exchanger



Skid Bar

- Provides easy two-hand lift
- Provides greater pump stability on soft or uneven surfaces

Accessory Kit Number	For ZE-Series Pumps with Reservoir	Weight (lbs)
SBZ-4 *	1-2 gal. w/o heat exchanger	4.9
SBZ-4L *	1-2 gal. with heat exchanger	5.5

* 1 and 2 gallon reservoirs only. Add suffix **K** for factory installation, see ordering matrix.



Foot Switch ⁵⁾

- Hands-free remote control on solenoid dump and 3-position valves
- With 10 foot cord

⁵⁾ 15 V, requires Electric Box

Accessory Kit Number	Can be used on ZE-Series Pumps with
ZCF-2 *	Solenoid VE-Series valves

* Add suffix **U** for factory installation, see ordering matrix.

ZE-Series, Factory Installed Options & Accessories



Pressure Transducer ¹⁾

- Displays pressure on LCD in bar, MPa or psi
- More accurate than analog gauge
- Calibration can be fine-tuned for certification
- Easy-viewing variable rate display
- “Set pressure” feature turns off motor at user defined pressure (or shifts valve to neutral on models with VE33/ VE43 valves)

¹⁾ 24 V, requires Electric Box

Accessory Kit Model number	Adjustable Pressure Range (psi)	Switch-point Repeatability	Dead-band (psi)
ZPT-U4 *	50-10,000	± 0,5%	50

* Add suffix T for factory installation, see ordering matrix.



Pendants ³⁾

- For pump types with valve operation “W” (No Valve, with Electric Box, without pendant)

³⁾ When ordering Enerpac VE-Series solenoid valve, the pendant must be ordered separately. Pendant connection to be plugged into electric box

Pendant Model Number	To be used with Solenoid Valve:
ZCP-1	VE32D
ZCP-3	VE32, VE33, VE43



Pressure Switch ²⁾ ³⁾

- Controls pump, monitors system
- Adjustable pressure 500-10,000 psi
- Includes glycerine filled 15,000 psi pressure gauge G2536L
- Accuracy ± 1,5% of full scale

²⁾ 24 V, requires Electric Box. Not available in combination with pressure transducer.

³⁾ Not available on LCD electronics

Accessory Kit Model number	Switch-point Repeatability	Deadband (psi)	Oil Ports (NPT)
ZPS-E3 *	± 2%	115-550	3/8"

* Add suffix P for factory installation, see ordering matrix.



Heat Exchanger ⁴⁾

- Removes heat from bypass oil to provide cooler operation
- Stabilizes oil viscosity, increasing oil life and reduces wear of pump and other hydraulic components.

⁴⁾ 24 VDC, requires electric box

Accessory Kit Model number	Fits on Reservoir	Weight (lbs)
ZHE-E04 *	1 and 2 gallon	9.0
ZHE-E10 *	2.5, 5, and 10 gallon	9.0

* Add suffix H for factory installation, see ordering matrix.



Options

Accessory Kits can be installed by customer. See chart below for options on Standard Electric (without electric box) or LCD Electric (with electric box). Refer to page 87 for ordering matrix.

ZE-Series Options	Factory Installed		Accessory Kits	
	Std. Electr.	LCD Electr.	Std. Electr.	LCD Electr.
Return Line Filter	F	F	ZPF	ZPF
Skid Bar ¹⁾	K	K	SBZ	SBZ
Roll Cage	R	R	ZRB	ZRB
Single-stage	S	S	-	-
Heat Exchanger	-	H	-	ZHE
Pressure Gauge ²⁾	G	G	-	-
Pressure Switch ³⁾	-	P	ZPS-E3	-
Pressure Transducer ⁴⁾	-	T	-	ZPT-U4
Level/Temp Switch ⁵⁾	-	L	-	ZLS-U4
Foot Switch ⁶⁾	-	U	-	ZCF-2

¹⁾ Available for 1 and 2 gallon reservoirs.

²⁾ Not available on pumps with pressure transducer.

³⁾ Includes 14,500 psi gauge. Only available on manual valves without locking feature.

⁴⁾ Electric box can accept either pressure switch or pressure transducer, but not both.

⁵⁾ Available for 2.5, 5, 10, gallon reservoirs.

⁶⁾ For control of solenoid dump and 3-position valves.



ZPT-U4 Pressure Transducer

More durable against mechanical and hydraulic shock than analog gauges.

- Digital pressure read-out provides accuracy of 5% of full scale.
- Easy-viewing variable rate display automatically varies increments between 44, 203, 508 and 2103 psi as rate of pressure change increases.
- “Set pressure” feature turns off motor at user defined pressure (or shifts valve to neutral on VE33 and VE43 valves).



ZHE-Series Heat Exchangers

Heat exchanger stabilizes oil temperature at 130° F at 70° F ambient temperature. Thermal transfer at 5 GPM and 70° F ambient temperature: 900 Btu/hour.

Do not exceed maximum oil flow of 7.0 GPM and maximum pressure of 300 psi. Not suitable for water-glycol or high water based fluids.

▼ Shown: **PEM-8418**



- Panel-mounted pressure gauge and adjustable relief valve for system pressure control
- Two-speed pump design, with high by-pass pressure, for rapid cylinder advance
- Dual voltage motor (230/460 VAC, 3 phase, 60 Hz)
- Full length reservoir sight tube with integral thermometer for ease in monitoring oil level and temperature
- Low voltage controls to protect the pump operator



The Largest Pump for the Largest Jobs



Locking Valves

Pumps with VM-4 manual valves are available with VM-4L manual valves for positive load holding. Add suffix "L" to pump model number.

Page: 108



FS-34 Foot Control Switch

This 3-position switch allows hands-free control of the solenoid valve on the pump. Operates 24V and

115V valves that use the square electrical connector.



Hoses

Enerpac offers a complete line of high-quality hydraulic hoses. To ensure the integrity of your system,

specify only genuine Enerpac hydraulic hoses.

Page: 114

◀ With similar specifications, a gasoline powered EGM-8000 Series is shown here performing a synchronized lift.

8000-Series Electric Pumps



About the 8000 Series

The 8000 Series is the largest pump in the Enerpac line and the best choice to power most large size cylinders, multiple cylinder circuits, and applications where the need for high speed requires high flow rates.

The 8000 Series, with its large reservoir capacity, is best suited for large jobs and may be the only solution because of the required oil capacity.

For further application assistance see our "Yellow Pages", or consult your local Enerpac office.

Page: 103

PE Series



Reservoir Capacity:

25 gal.

Flow at Rated Pressure:

2.0 gal/min.

Motor Size:

12.5 hp

Maximum Operating Pressure:

10,000 psi

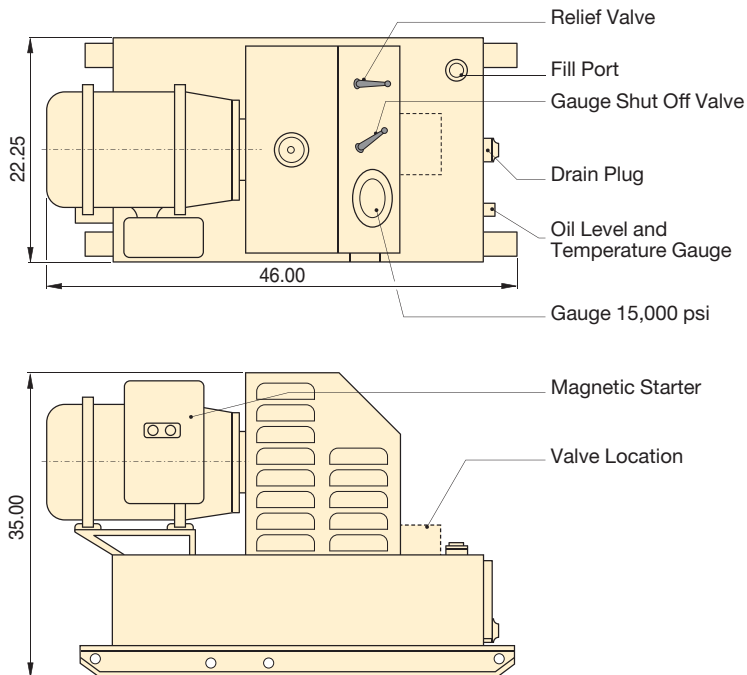

Dimensions shown in inches.



Speed Chart

To determine how an 8000 Series pump will operate your cylinder, see the Pump/Cylinder Speed Chart in the "Yellow Pages".

Page: 251

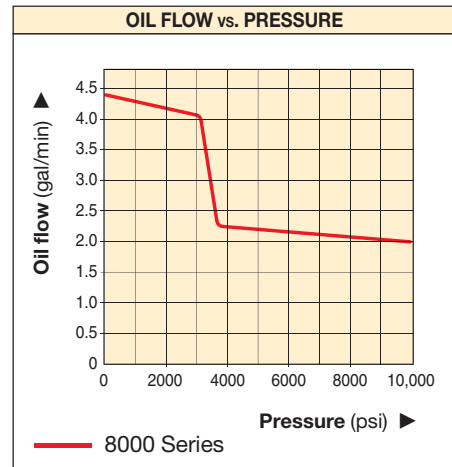

Used with Cylinder	Usable Oil Capacity (gal)	Model Number	Pressure Rating (psi)		Output Flow Rate (gal/min)		Valve Type	Valve Function	Current Draw (Amps)	Motor Voltage* (VAC)	Sound Level (dBA)	Weight (lbs)
			1st stage	2nd stage	1st stage	2nd stage						
Single-acting	18	PEM-8218	3,700	10,000	4.4	2.0	Manual (VM-2)	3-way, 2-pos.	33.0	230	78-84	720
	18	PEM-8218C	3,700	10,000	4.4	2.0			16.5	460	78-84	720
Double-acting	18	PEM-8418	3,700	10,000	4.4	2.0	Manual (VM-4)	4-way, 3-pos.	33.0	230	78-84	720
	18	PEM-8418C	3,700	10,000	4.4	2.0			16.5	460	78-84	720
	18	PER-8418	3,700	10,000	4.4	2.0	Solenoid (VE43)	4-way, 3-pos.	33.0	230	78-84	765
	18	PER-8418C	3,700	10,000	4.4	2.0			16.5	460	78-84	765

* Consult Enerpac for availability of other voltages.

▼ Shown: ZA4208MX, ZA4420MX



Z Tough. Dependable. Innovative. CLASSIC



ATEX Certified

See explanation of ATEX certification in the "Yellow Pages."



Page: 241



Speed Chart

To determine how a ZA Series pump will operate your cylinder, see the Pump/Cylinder Speed Chart in the "Yellow Pages".

Page: 251



Hoses

Enerpac offers a complete line of high-quality hydraulic hoses. To ensure the integrity of your system, specify only genuine Enerpac hydraulic hoses.

Page: 114

- Features Z-Class high efficiency pump design, higher oil flow and bypass pressure
- Two-speed operation and high by-pass pressure reduces cycle time for improved productivity
- Internal relief valves. One is factory set for overload protection while the second is user adjustable for pre-setting maximum system pressure
- Sight gauge on 1 and 2 gallon and level gauge on 2.5, 5 and 10 gallon reservoirs allow quick and easy oil level monitoring
- Optional heat exchanger warms exhaust air to prevent freezing and cools the oil

ZA4 Performance		
Dynamic Air Pressure Range	Air Consumption	Sound Level
(psi)	(scfm)	(dBA)
60-100	20-100	94-97

Used with Cylinder	Usable Oil Capacity (gal)	Valve Model Number ²⁾	Valve Function	Model Number	Output Flow Rate ¹⁾			
					(in ³ /min)			
					100 psi	700 psi	5,000 psi	10,000 psi
Single-acting	1.0	Manual VM32	Advance/Retract	ZA4204MX	850	675	110	80
	1.75			ZA4208MX	850	675	110	80
	5.0			ZA4220MX	850	675	110	80
Double-acting	1.0	Manual VM43	Advance/Hold/Retract	ZA4404MX	850	675	110	80
	1.75			ZA4408MX	850	675	110	80
	2.5			ZA4410MX	850	675	110	80
	5.0			ZA4420MX	850	675	110	80
	10.0			ZA4440MX	850	675	110	80

1) Actual flow will vary with air supply

2) See valve section for hydraulic symbols and details

ZA-Series Air Hydraulic Pump Ordering Matrix

CUSTOM BUILD YOUR ZA4 AIR PUMP

▼ This is how a ZA-Series Pump model number is built up:

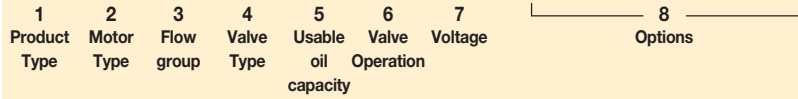

1 Product Type

Z = Pump class

2 Motor Type

A = Air motor

3 Flow Group

4 = 80 in³/min@10,000 psi

4 Valve Type

- 0 = No valve with coverplate
- 2 = 3-way, 2-position (VM32)
- 3 = 3-way, 3-position (VM33)
- 4 = 4-way, 3-position (VM43)
- 6 = 3-way, 3-position, locking (VM33L)
- 7 = 3-way, 2-position (VM22)
- 8 = 4-way, 3-position, locking (VM43L)

5 Usable Oil Capacity

- 04 = 1.0 gallon
- 08 = 1.75 gallon
- 10 = 2.5 gallon
- 20 = 5.0 gallon
- 40 = 10.0 gallon

6 Valve Operation

- M = Manual valve
- N = No valve

7 Voltage

- X = Not applicable

8 Options

(Specify in alphabetical order)

- F = Filter
- G = 0-15,000 psi gauge (2 1/2")
- H = Heat exchanger*
- K = Skidbar*
- N = No reservoir handles (includes lifting eyes; 2.5, 5, 10 gallon only)
- R = Roll bars

* (1 and 2 gallon reservoirs only)

Ordering Example

Model Number: ZA4208MX-FHK

ZA4208MX-FHK is an air operated pump with a 3-way, 2-position manual valve, a 2.0 gallon reservoir, filter, heat exchanger and skid bar.

ZA Series



Reservoir Capacity:

1.0-10.0 gal.

Flow at Rated Pressure:

80 in³/min.

Maximum Operating Pressure:

10,000 psi

OIL FLOW vs. PRESSURE

100 psi Dynamic Air Pressure at 70 scfm

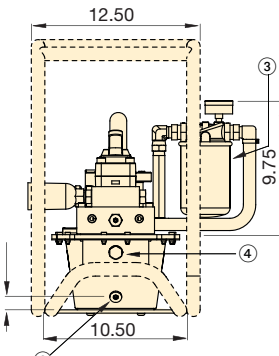
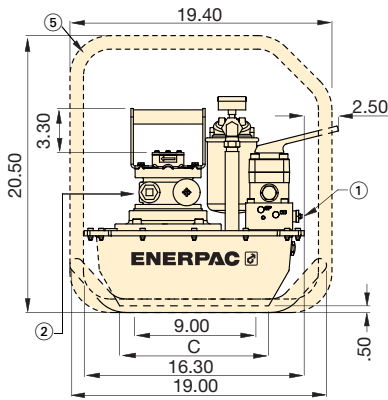
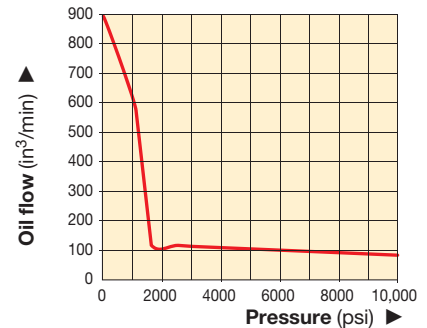

1 and 1.75 gallon reservoirs

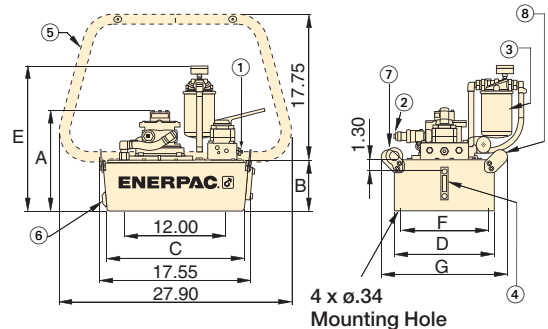

2.5, 5, 10 gallon reservoirs

Dimensions (in)							Weight (incl. oil) (lbs)
A	B	C	D	E	F	G	
11.6	5.6	11.0	6.0	15.4	-	-	65.5
11.6	5.6	11.0	8.1	15.4	-	-	75.7
13.0	7.1	16.5	16.6	16.0	15.6	18.4	112.7
11.6	5.6	11.0	6.0	15.4	-	-	66.7
11.6	5.6	11.0	8.1	15.4	-	-	76.9
12.0	6.1	16.5	12.0	16.0	11.0	15.1	87.1
13.0	7.1	16.5	16.6	16.9	15.6	18.4	113.9
16.5	10.6	15.7	19.9	20.4	18.9	23.0	164.6

- ① User adjustable relief valve on all manual valves
 - ② Air inlet 1/2" NPTF
 - ③ Return Line Filter (optional)
 - ④ Oil Sight Gauge
 - ⑤ Roll Cage (optional)
 - ⑥ Oil Drain
 - ⑦ Lifting eyes (4) (optional)
 - ⑧ Handles
- Skid Bar (Model No. SBZ-4) (optional)

▼ Shown: **XA11G**



- Higher oil flow for increased productivity
- Variable oil flow and fine metering for precise control
- Ergonomic design for less operator fatigue
- Closed hydraulic system prevents contamination and allows pump usage in any position
- Pedal lock function for retract position
- External adjustable pressure setting valve
- ATEX Certified.* Includes ground screw for explosion protection

* See explanation of ATEX Certification in "Yellow Pages."



▼ Easily operated by foot. No need to fully lift up foot - rest body weight on heel, resulting in a hands-free and stable working position.



XVARI[®] TECHNOLOGY

Productivity and Ergonomics



Optional Pressure Gauge

Integrated gauge with calibrated scale reading in psi, bar and MPa for actual pressure reading.



Optional 4-Way 3-Position Valve

For powering double-acting hydraulic cylinders and tools.



Optional 1/2 Gallon Reservoir

Double oil capacity for powering larger hydraulic cylinders and tools.



Pedal Safety Guard

Customer installed frame protects both pedals against accidental activation.

Order model number ¹⁾

XPG1



"Joy-stick" Lever Kit

Customer installed set of handles for manual operation of both pedals.

Order model number ¹⁾

XLK1



Hydraulic Swivel Connector

Customer installed swivel connector for optimal orientation of the hydraulic hose.

Order model number ¹⁾

XSC1

¹⁾ Accessories must be ordered separately.

XVARI® Technology, Air Driven Hydraulic Pumps



XVARI® TECHNOLOGY

Production Application

XA11 pump is used with a 13-ton hollow cylinder to compress and position diesel engine valve springs.

The operator benefits from the fine metering capacities of the XVARI® Technology to apply the mandatory precise stroke and force.

XA Series



Reservoir Capacity:
61-122 in³

Flow at Rated Pressure:
15 in³/min.

Air Consumption:
10-35 scfm

Maximum Operating Pressure:
10,000 psi

▼ XA-SERIES PERFORMANCE CHART

Maximum Pressure (psi)	Output Flow Rate (in ³ /min)		Pump Series	Valve Function	Dynamic Air Pressure (psi)
	No load	Load			
10,000	120	15	XA1	Advance/Hold/Retract	30-125

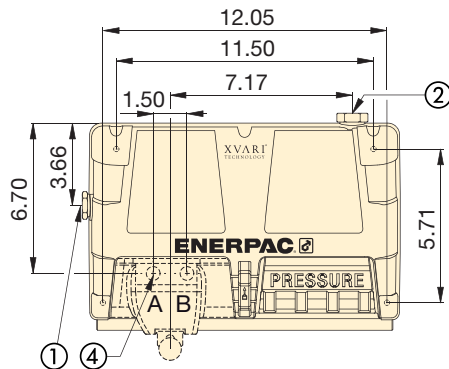

- ① 3/8"-18 NPTF Oil Outlet
- ② 1/4"-18NPTF Air Inlet
- ③ 4/3 Optional Control Valve
- ④ 3/8"-18 NPTF Oil Outlet

Dimensions shown in inches.

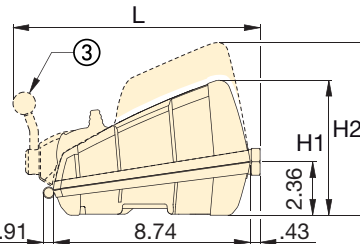
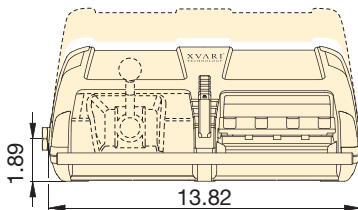

OIL FLOW vs. PRESSURE

at 100 psi dynamic air pressure

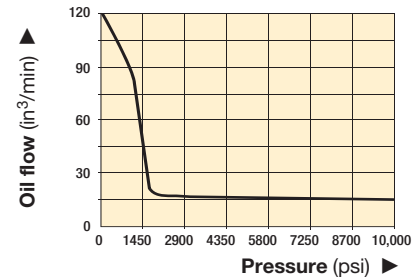

Regulator-Filter-Lubricator

Recommended for use with all XA-Series Air pumps. Provides clean, lubricated air and allows for air pressure adjustment.

Order model number ¹⁾

RFL102

▼ SELECTION CHART

For Use With Cylinder Tool	Usable Oil Capacity (in ³)	Model No. ¹⁾	Pressure Gauge	3-Way, 3-Position Valve	4-Way, 3-Position Valve	Dimensions (in)			Weight (lbs)
						H1	H2	L	
Single-acting	61	XA11 ²⁾	–	•	–	5.98	–	–	19.0
	122	XA12 ²⁾	–	•	–	–	6.69	–	22.4
Single-acting	61	XA11G	•	•	–	5.98	–	–	19.4
	122	XA12G	•	•	–	–	6.69	–	22.9
Double-acting	61	XA11V	–	–	•	5.98	–	10.98	22.3
	122	XA12V	–	–	•	–	6.69	10.98	25.7
Double-acting	61	XA11VG	•	–	•	5.98	–	10.98	22.7
	122	XA12VG	•	–	•	–	6.69	10.98	26.2

¹⁾ High-flow coupler CR400 and accessories must be ordered separately.

²⁾ Available as cylinder pump set, see page 54.

▼ Shown left to right: PAMG-1402N, PATG-1102N, PARG-1102N, PATG-1105N



- High efficiency cast aluminum air motor for increased life and reduced air consumption
- Fully serviceable air motor assembly
- Reinforced heavy-duty reservoir for applications in tough environments
- New generation air saver piston with rugged one-piece design reduces air consumption and operating costs
- Return-to-tank port for use in remote valve applications
- Quiet – only 76 dBA with low air consumption of 12 scfm
- Operating air pressure: 40-125 psi, enables pump to start at extremely low pressure
- Internal pressure relief valve provides overload protection

▼ Easily operated by hand or by foot.



Compact Air Over Hydraulic



RFL-102 Regulator-Filter-Lubricator

Recommended for use with all air pumps. Provides clean, lubricated air and allows for air pressure adjustment. Steel bowl guards are standard.

Order model number ¹⁾

RFL102



Large Reservoir Models

The Turbo II Air Pump is also available with a larger reservoir: **PATG-1105N**, **PAMG-1405N**, and **PARG-1105N**.



Hoses

Enerpac offers a complete line of high-quality hydraulic hoses. To ensure the integrity of your system, specify only genuine Enerpac hydraulic hoses.

Page: **114**

Used with Cylinder	Usable Oil Capacity (in ³)	Model Number
Single-acting	127	PATG-1102N*
	230	PATG-1105N
	127	PARG-1102N
	230	PARG-1105N
Double-acting	127	PAMG-1402N
	230	PAMG-1405N

* Available as set. See note on next page.

Turbo II Air Hydraulic Pumps

PATG PARG PAMG Series



Reservoir Capacity:
150-305 in³

Flow at Rated Pressure:
5-10 in³/min.

Maximum Operating Pressure:
10,000 psi

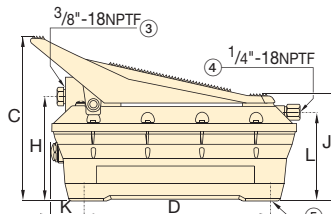
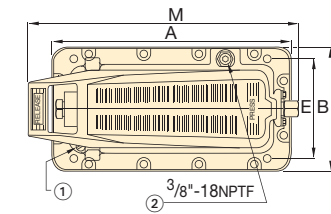

PATG-1102N and PATG-1105N

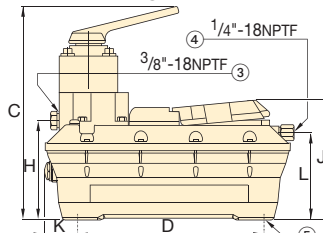
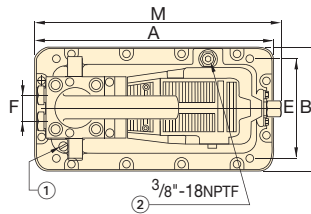

PAMG-1402N and PAMG-1405N

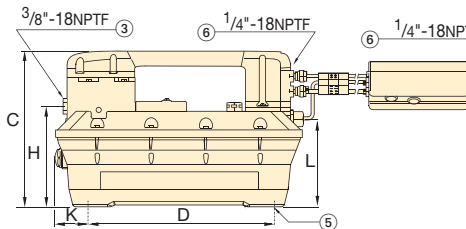
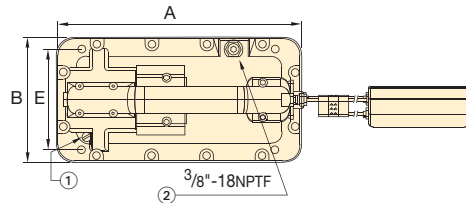

PARG-1102N and PARG-1105N

- ① Filtered "Permanent" Tank Vent
- ② Return-to-Tank/Auxiliary Vent/Fill Tank Port
- ③ Hydraulic Output
- ④ Swivel Air Input with Filter
- ⑤ 4 Mounting Holes for #10 thread forming screw. Max. depth into reservoir = .75"
- ⑥ Air Input Options

Pressure Rating (psi)	Output Flow Rate (in ³ /min)		Model Number	Valve Function	Air Pressure Range (psi)	Air Consumption (scfm)	Sound Level (dBA)	
	No load	Load						
10,000	60	10	PATG & PAMG	Advance/ Hold/ Retract	40-125	12	76	
10,000	51 ¹⁾	6 ¹⁾			PARG	40-125	12	76
10,000	48 ²⁾	5 ²⁾				40-125	8	76

¹⁾ Air supply connected at pendant. ²⁾ Air supply connected at pump shown on flow curve.



The PATG-models use a foot or hand operated treadle to control air and valve functions.

The PAMG-models use a treadle with a locking feature and a 4-way manual valve.

The PARG-models use a 15 ft. pendant hose for convenient one-man operation.

OIL FLOW vs. PRESSURE

Turbo II Air Pump (@ 100 psi)

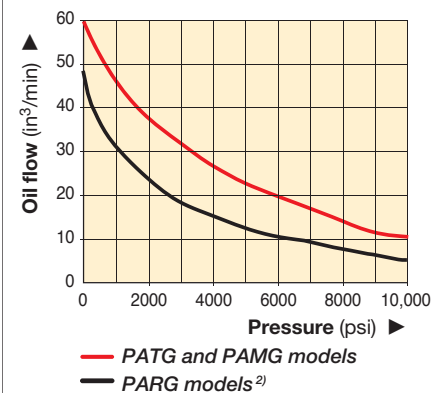

Dimensions											Weight (lbs)	Model Number
A	B	C	D	E	F	H	J	K	L	M		
12.33	6.49	8.29	9.04	4.00	-	5.15	5.75	1.65	4.43	13.62	18	PATG-1102N*
15.60	7.92	8.22	9.04	4.00	-	5.08	5.75	3.28	4.41	17.20	22	PATG-1105N
12.33	6.49	7.88	9.04	4.00	-	5.15	-	1.65	4.43	-	22	PARG-1102N
15.60	7.92	7.88	9.04	4.00	-	5.08	-	3.28	4.41	-	26	PARG-1105N
12.33	6.49	10.50	9.04	4.00	1.42	5.23	6.00	1.65	4.43	12.60	24	PAMG-1402N
15.60	7.92	10.50	9.04	4.00	1.42	5.19	6.00	3.28	4.41	15.94	28	PAMG-1405N

PA-Series, Air Hydraulic Pumps

▼ Shown from top to bottom: PA-1150, PA-133



PA Series

Reservoir Capacity:
36-80 in³

Flow at Rated Pressure:
8 in³/min.

Maximum Operating Pressure:
10,000 psi



PC-66 Reservoir Conversion Kit

Double the reservoir capacity of your existing PA-133 with this easy to install conversion kit.

- Rugged construction – built for long life and easy service
- Swivel coupling simplifies hydraulic connection and pump operation
- Three-position treadle provides cylinder advance, hold and retract operation
- PA-133 operates in all positions for increased versatility in use and mounting
- Base mounting slots provided on PA-133

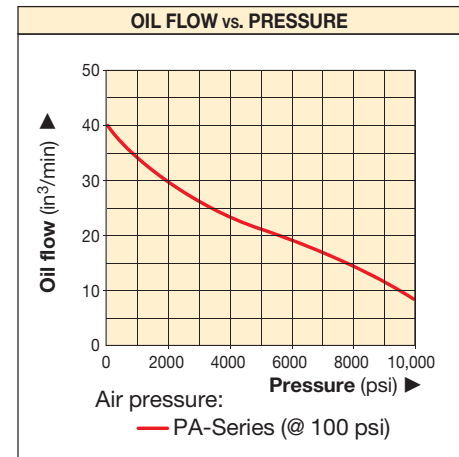

Dimensions shown in inches.

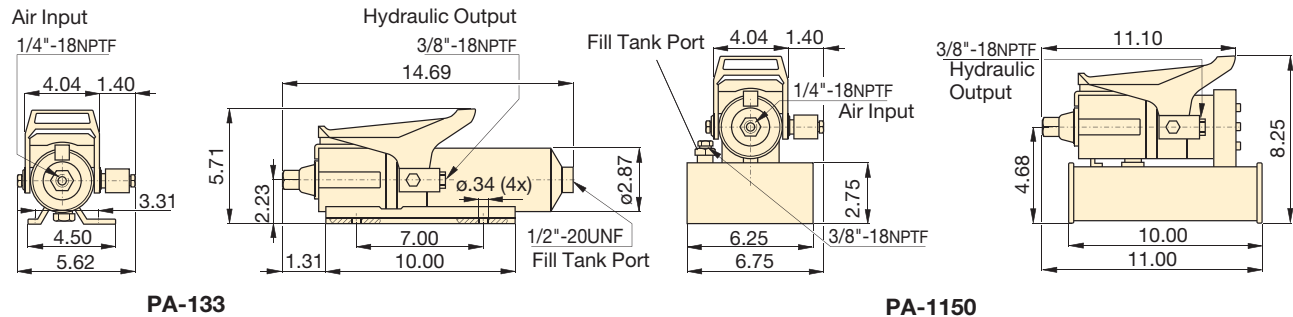

Used with Cylinder	Usable Oil Capacity (in ³)	Model Number	Pressure Rating (psi)	Output Flow Rate (in ³ /min)		Valve Function	Air Pressure Range* (psi)	Air Consumption (scfm)	Sound Level (dBA)	Weight (lbs)
				No load	Load					
Single-acting	36	PA-133	10,000	40	8	Advance/Hold/Retract	60-120	9	85	12
	80	PA-1150	10,000	40	8	Advance/Hold/Retract	60-120	9	85	18

* Recommended Regulator-Filter-Lubricator: RFL-102

PAM-Series, Air Hydraulic Pumps

▼ Shown: **PAM-1041**





PAM Series

Reservoir Capacity:
1.0-2.0 gal.

Flow at Rated Pressure:
9 in³/min.

Maximum Operating Pressure:
10,000 psi

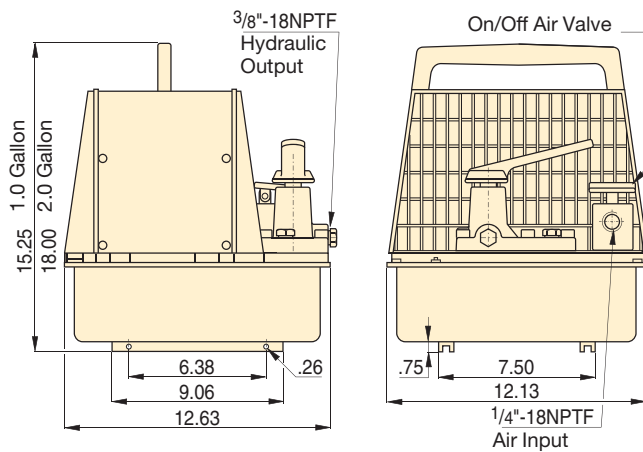
- Twin air motor configuration delivers high-flow performance in first stage, up to 200 psi, for rapid cylinder advance
- 1 and 2 gallon reservoirs for use with a wide range of cylinders
- Integral shroud protects air motors and provides easy portability





Locking Valves
Pumps with VM-4 manual valves are available with VM-4L manual locking valves instead. Add suffix "L" to pump model number. **Page: 108**

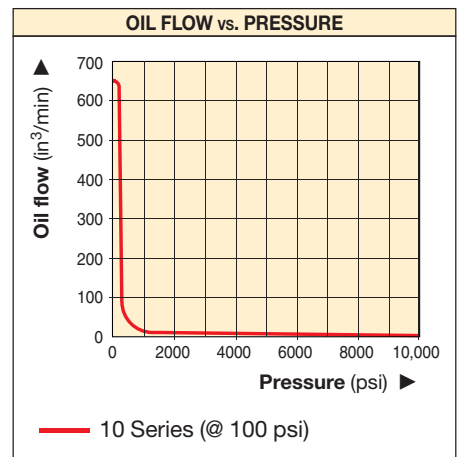

Remote Air Valve
For remote operation of PAM-10 series air pumps. Permits either hand or foot operation.

Model number ¹⁾ **VA-2**



Used with Cylinder	Usable Oil Capacity (gal)	Model Number (with Shroud)	Pressure Rating (psi)	Output Flow Rate (in ³ /min)		Valve Function	Valve Model	Air Pressure Range* (psi)	Air Consumption (scfm)	Sound Level (dBA)	Weight (lbs)
				1 st stage	2 nd stage						
Single-acting	0.7	PAM-1021	10,000	650	9	Adv/Hold/Ret	VM-2	60-120	18	87	50
	2.0	PAM-1022	10,000	650	9	Adv/Hold/Ret	VM-2	60-120	18	87	60
Double-acting	0.7	PAM-1041	10,000	650	9	Adv/Hold/Ret	VM-4	60-120	18	87	50
	2.0	PAM-1042	10,000	650	9	Adv/Hold/Ret	VM-4	60-120	18	87	60

* Recommended Regulator-Filter-Lubricator: RFL-102

ZG5/ZG6 Gasoline Hydraulic Pumps

▼ Shown from left to right: ZG6440MX-BCFH, ZG5420MX-B



Z Tough.
Dependable.
Innovative.
CLASS



User Adjustable Relief Valve

All VM-Series directional valves have a user adjustable relief valve to allow the operator to easily set the optimum working pressure.



High Pressure Hoses

Enerpac offers a complete line of high-quality hydraulic hoses. To ensure the integrity of your system, specify only genuine Enerpac hydraulic hoses.

Page: 114

- Features **Z-Class** high efficiency pump design, higher oil flow and bypass pressure
- Two-speed operation reduces cycle time for improved productivity
- Full sight oil level glass on all reservoirs allow quick and easy oil level monitoring
- Sturdy wheeled cart for ZG6 allows transport over uneven terrain and features collapsible handles for easy storage
- Dual forced air heat exchangers on ZG6 stabilizes hydraulic oil temperature
- ZG5 is available in two 4-cycle engine sizes: 7.1 ft.lbs Honda and 8.5 ft.lbs Briggs & Stratton
- ZG6 has Briggs & Stratton 17 ft.lbs engine with electric start, pressurized oil and 16-amp charge output for accessories



Other Options Available

The ZG5/ZG6 pumps are available in a wide range of configurations and options. Contact Enerpac for further information.

▼ SELECTION CHART

Used with Cylinder	Usable Oil Capacity (gal)	Valve Model Number	Valve Function	Model Number	Motor Manufacturer*	Motor Size (Ft.lbs)	Weight (lbs)
Single-Acting	2.5	VM33	Advance/ Hold/ Retract	ZG5310MX-R	Honda	7.1	113.6
	5.0			ZG5320MX-R			140.9
Double-Acting	2.5	VM43		ZG5410MX-R			113.6
	5.0			ZG5420MX-R			141.0
Single-Acting	2.5	VM33		ZG5310MX-BR	Briggs & Stratton	8.5	111.0
	5.0			ZG5320MX-BR			138.3
Double-Acting	2.5	VM43		ZG5410MX-BR			111.1
	5.0			ZG5420MX-BR			138.4
	10.0	VM43		ZG6440MX-BCFH		17.0	334.0

*To order Briggs & Stratton motor, place a "B" suffix in the model number.

Gasoline Hydraulic Pumps

ZG5

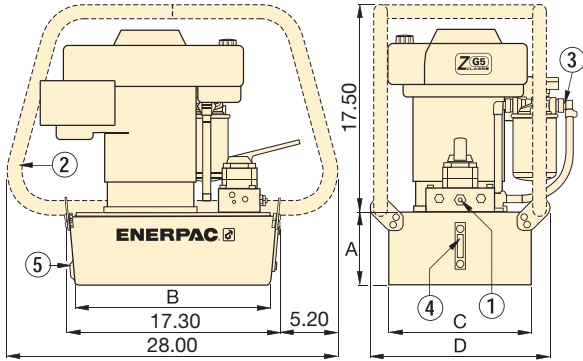

ZG6

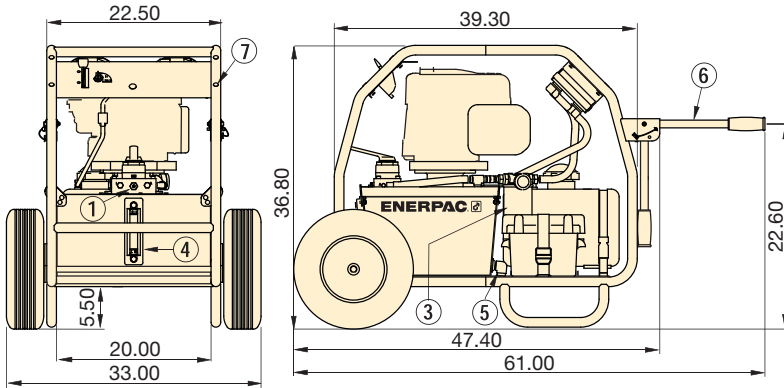

- ① User adjustable relief valve on all manual valves. 3/8" NPTF on A and B ports; 1/4" NPTF on auxiliary ports.
- ② Roll Bar (optional)
- ③ Return Line Filter (optional on ZG5, Standard on ZG6)
- ④ Oil Level Gauge
- ⑤ Oil Drain
- ⑥ Collapsible handles (ZG6 only)
- ⑦ Cart (standard on ZG6 only)

ZG5/ ZG6 Series



Reservoir Capacity:
2.5-10 gal.

Flow at Rated Pressure:
100-200 in³/min.

Engine Size:
7.1, 8.5 and 17.0 Ft.lbs

Maximum Operating Pressure:
10,000 psi

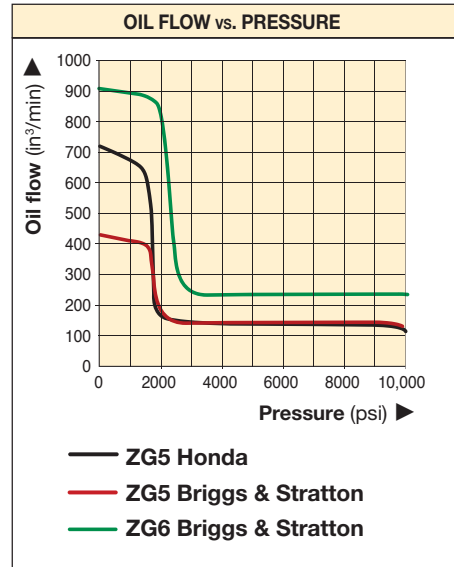

Motor Size		Output Flow Rate				Relief Valve Adjustment Range	Sound Level
(Ft.lbs)	RPM	(in ³ /min)					
		100 psi	700 psi	5,000 psi	10,000 psi	(psi)	(dBA)
7.1	2500	700	650	110	100	1000 - 10,000	88 - 93
8.5	3600	400	380	110	100		91 - 95
17.0	3600	900	885	225	200		91 - 95

ZG5 Dimensions (in)				
Reservoir Size	A	B	C	D
(gal)				
2.5	6.1	16.5	12.0	15.1
5.0	7.1	16.3	16.6	19.7
10.0	10.6	15.7	19.9	22.7

Atlas Series Gasoline Pumps

▼ Shown: PGM-2408R



PGM Series

Reservoir Capacity:
1-2 gallons

Flow at Rated Pressure:
40 in³/min.

Motor Size:
4.2 Ft.lbs

Maximum Operating Pressure:
10,000 psi



Gauges

Minimize the risk of overloading and ensure long, dependable service from your equipment. Refer to the

System Components section for a full range of gauges.

Page: **113**

- **Patented Genesis Technology**
 - coaxial piston design ensures high performance
 - first-stage piston pump for improved efficiency
- **High by-pass pressures improve productivity**
- **All Atlas pumps feature sturdy roll cage for use in tough environments**
- **Four-cycle Honda motor**



Hoses

Enerpac offers a complete line of high-quality hydraulic hoses. To ensure the integrity of your system,

specify only genuine Enerpac hydraulic hoses.

Page: **114**

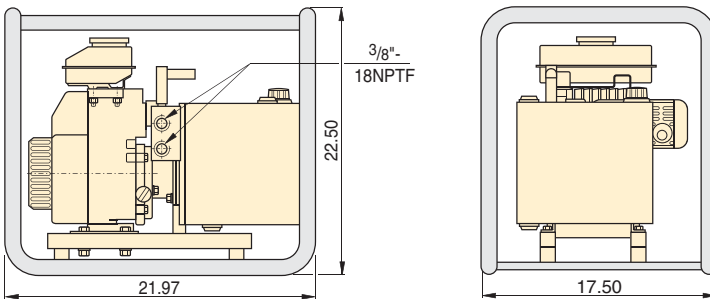

OIL FLOW vs. PRESSURE

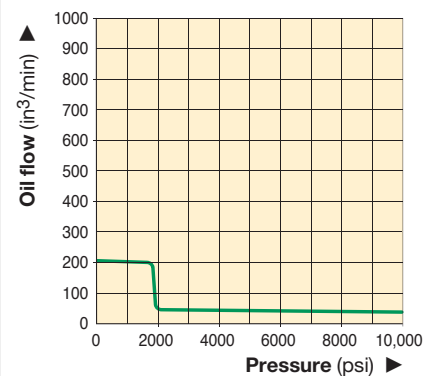

Used with Cylinder	Usable Oil Capacity (gal)	Model Number	Output Flow Rate** (in ³ /min)		Pressure Rating (psi)	Valve Type	Valve Function	Motor Manufacturer	Motor Size (Ft.lbs)	Weight (lbs)
			1 st stage	2 nd stage						
Single-acting	1.0	PGM-2304R*	200	40	10,000	3-way, 3-position	Advance/ Hold/Retract	Honda	4.2 at 3600 rpm	55
	2.0	PGM-2308R*	200	40	10,000	3-way, 3-position				72
Double-acting	1.0	PGM-2404R*	200	40	10,000	4-way, 3-position				55
	2.0	PGM-2408R*	200	40	10,000	4-way, 3-position				72

* Note: PGM-20 Series are available with a carrying handle instead of a Roll Cage. For ordering omit the 'R' from the model number.

** Nominal values—may vary based on motor speed.

8000-Series Gasoline Pumps

▼ Shown: EGM-8418



EGM Series

Reservoir Capacity:

25 gal.

Flow at Rated Pressure:

1.5 gal/min.

Motor Size:

18 hp

Maximum Operating Pressure:

10,000 psi



Locking Valves

Pumps with VM-4 manual valves are available with VM-4L manual valves for positive load holding. Add suffix "L" to pump model number.

Page: 108

- Industrial grade 18 hp twin-cylinder motor
- Panel mounted pressure gauge and adjustable relief valve for system pressure control
- Two-speed pump design with high by-pass pressure for rapid cylinder advance
- Built in oil temperature and oil level gauge
- External adjustable relief valve (1,200-10,000 psi) allows control of operating pressure without opening the pump
- Integral priming circuit guarantees quick starts after transport

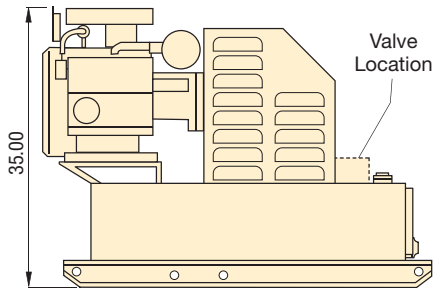
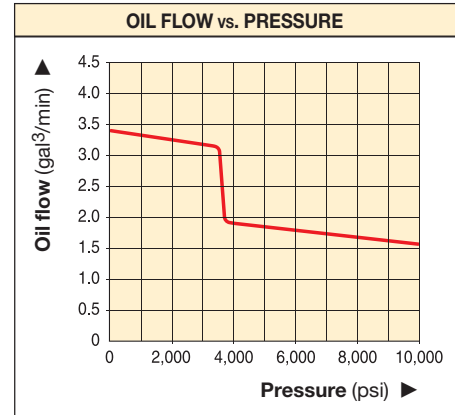

Side View

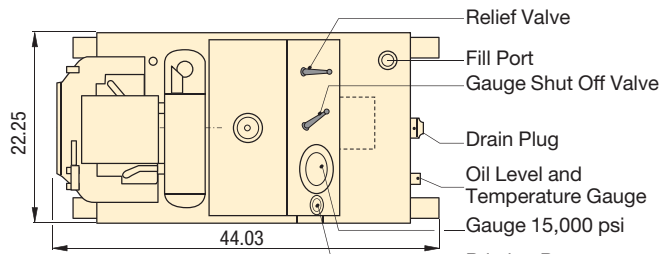

Top View

Used with Cylinder	Usable Oil Capacity (gal)	Model Number	Pressure Rating (psi)		Output Flow Rate (gal/min)		Valve Type	Valve Function	Sound Level (dBA)	Weight (lbs)
			1 st stage	2 nd stage	1 st stage	2 nd stage				
Single-acting	18	EGM-8218	3,700	10,000	3.4	1.5	3-way, 2-pos.	Adv./Retr.	94	890
Double-acting	18	EGM-8418	3,700	10,000	3.4	1.5	4-way, 3-pos.	Adv./Hold/Retr.	94	890

ENERPAC hydraulic valves are available in a wide variety of models and configurations.

Whatever your requirements... directional control, flow control, or pressure control... you can be sure that Enerpac has the correct valve to match your application exactly.

Designed and manufactured for safe operation up to 10,000 psi, the range of Enerpac valves allows for direct pump mounting, remote mounting, manual or solenoid actuation, and in-line installation, giving you flexible solutions to control your hydraulic system.



Pressure and Flow Control Valves

For more hydraulic system control with pressure relief valves, shut-off valves, check valves and sequence valves see our "System Components" section.

Page: 128







Valving Help

See Basic System Set-Up and Valve Information in our 'Yellow Pages'

Page: 252

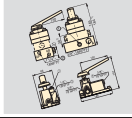

Directional Control Valves Section Overview

Valve Type	Series		Page
Pump-Mounted Directional Control Valves	VM, VE		106 ▶
Remote-Manual Directional Control Valves	VC		108 ▶
Valve Dimensions	VC, VM, VE		109 ▶
Modular/Solenoid Operated Directional Control Valves	VE		110 ▶

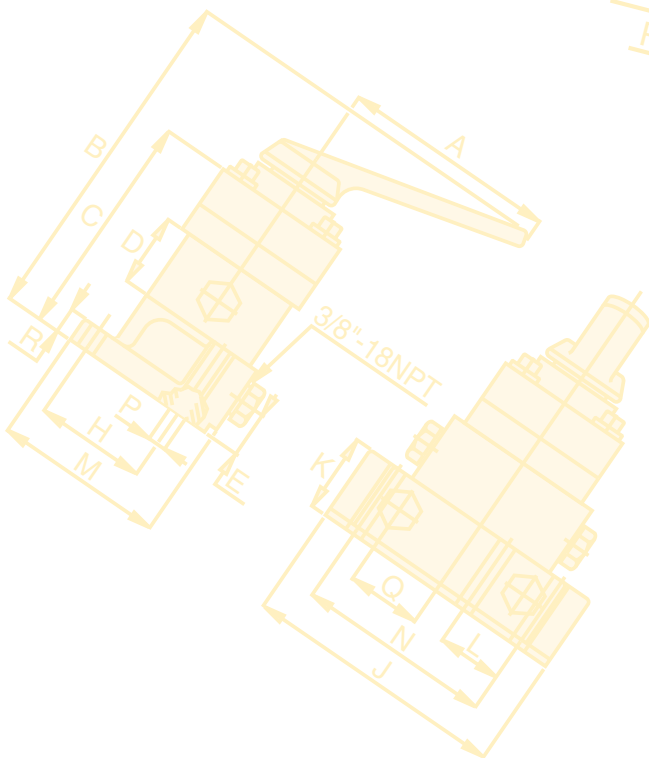
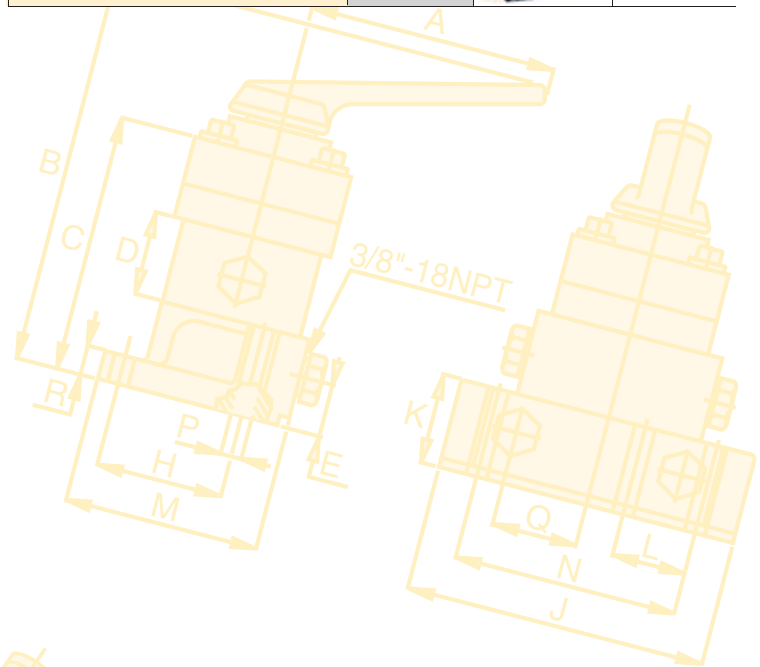
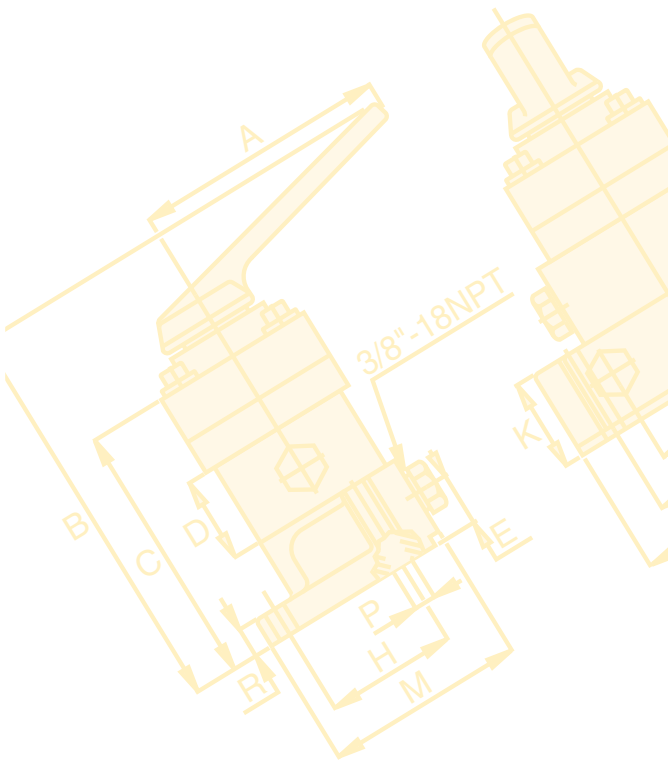

▼ Shown from left to right: VM32, VE33, VM33, VM43L, VE43-115



- Advance/Retract and Advance/Hold/Retract operation of single-acting and double-acting cylinders
- Manual or solenoid operation
- Pump mounting will retrofit on most Enerpac pumps
- Available “locking” option on VM Series valves for load-holding applications
- Standard “locking” feature on VE Series 3-position valves
- User adjustable relief valves allow the operator to easily set the working pressure

▼ ZE4420SB-FH Z-Class pump is mounted next to an Enerpac H-frame press, includes VE43 electric valve to control cylinder operation.



For Reliable Control of Single and Double-Acting Cylinders

Valve Operation	Used with Cylinder	Valve Type	
Manual	Single-acting	3-Way 2 Position	
Manual	Single-acting	3-Way 2 Position	
Manual	Single-acting	3-Way 3 Position, Tandem Center	
Manual	Double-acting	4-Way 3 Position, Tandem Center	
Manual	Single-acting	3-Way 3 Position, Tandem Center, Locking	
Manual	Double-acting	4-Way 3 Position, Tandem Center, Locking	
Solenoid 24 VDC	Single-acting	3-Way 2 Position	
Solenoid 24 VDC	Single-acting	3-Way 2 Position, Dump	
Solenoid 24 VDC	Single-acting	3-Way, 3 Position, Tandem Center	
Solenoid 115 VAC	Single-acting	3-Way, 3 Position, Tandem Center	
Solenoid 24 VDC	Double-acting	4-Way, 3 Position, Tandem Center	
Solenoid 115 VAC	Double-acting	4-Way, 3 Position, Tandem Center	

For remote valve applications, see page 108.

Pump Mounted Directional Control Valves



All valves feature several gauge ports for “system”, A port and B port pressure monitoring. User-adjustable relief valves are included on all models to allow the operator to easily set the optimum working pressure for each application. VM33 and VE43 valves include “System Check” feature, for more precise pressure holding and improved system control. The VM33 has improved porting which provides faster cylinder retraction while motor is running.

Model Number	Hydraulic Symbol	Schematic Flowpath			Weight (lbs)
		Advance	Neutral	Retract	
VM22					5.6
VM32					5.6
VM33					6.7
VM43					6.8
VM33L					10.7
VM43L					10.8
VE32					8.7
VE32D					8.7
VE33					20.3
VE33-115					20.3
VE43					20.3
VE43-115					20.3

See page 109 for product dimensions.

VM, VE Series



Flow Capacity:
4.5 gal/min.

Maximum Operating Pressure:
10,000 psi



High-Pressure Hoses

VE33-115 and VE43-115 electric valves are supplied with IC400 control station. These valves include an 8 ft. power cord, and can be used on any Enerpac pump. They require a separate 115 volt power supply to operate.



Locking Valves

For applications that require positive load holding, VM Series valves (except the VM22 and VM32 valve) are available with a pilot-operated check valve. This option provides hydraulic locking of the load until the valve is shifted into the retract position.

To order this feature, place an “L” at the end of the model number.



Pendants for VE-Series Solenoid Valves

When ordering Enerpac VE-Series solenoid valves, the pendant must be ordered separately for Z-Class pumps. Pendant connection to be plugged into electric box of pump.

To be used with solenoid valves:	Pendant
VE32D	ZCP-1
VE32, VE33, VE43	ZCP-3

▼ Shown from left to right: VC-20, VC-4L



Reliable Remote Control



Locking Valves

For applications that require positive load holding, VC and VM Series valves are available with a pilot-operated check valve. This option provides hydraulic locking of the load until the valve is shifted into the retract position.

- Advance/Hold/Retract operation for use with single-acting or double-acting cylinders

Valve Operation	Used with Cylinder	Valve Type	Model Number	Hydraulic Symbol	Schematic Flowpath			Weight (lbs)
					Advance	Hold	Retract	
Manual	Single Acting	3-Way, 3 Position, Tandem Center	VC-3					6.4
Manual	Single Acting	3-Way, 3 Position, Tandem Center, Locking	VC-3L					10.3
Manual	Single Acting	3-Way, 3 Position, Closed Center	VC-15					6.4
Manual	Single Acting	3-Way, 3 Position, Closed Center, Locking	VC-15L					10.3
Manual	Double Acting	4-Way, 3 Position, Tandem Center	VC-4					6.4
Manual	Double Acting	4-Way, 3 Position, Tandem Center, Locking	VC-4L					10.3
Manual	Double Acting	4-Way, 3 Position, Closed Center	VC-20					6.4
Manual	Double Acting	4-Way, 3 Position, Closed Center, Locking	VC-20L					10.3

Return line kit included with remote valves

Directional Control Valves Dimensions

Valve dimensions in inches.

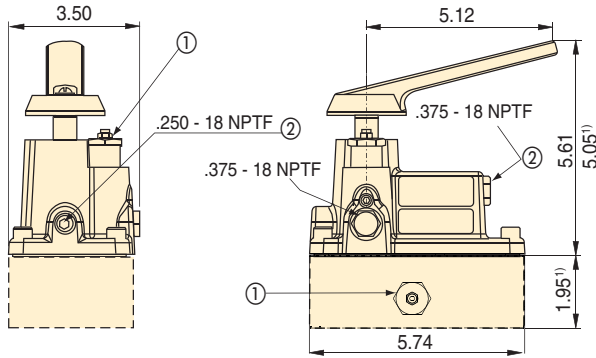

VM22, VM32

¹⁾ VM22 only

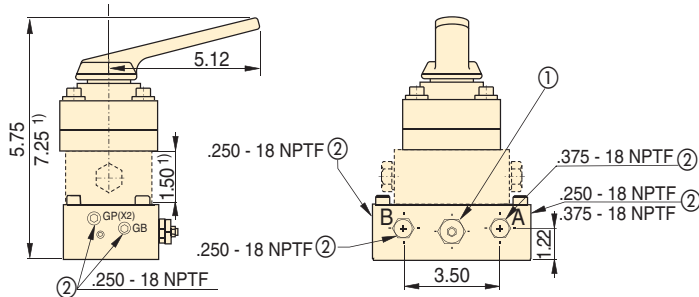

VM33, VM33L

VM43, VM43L

¹⁾ VM33L and VM43L only

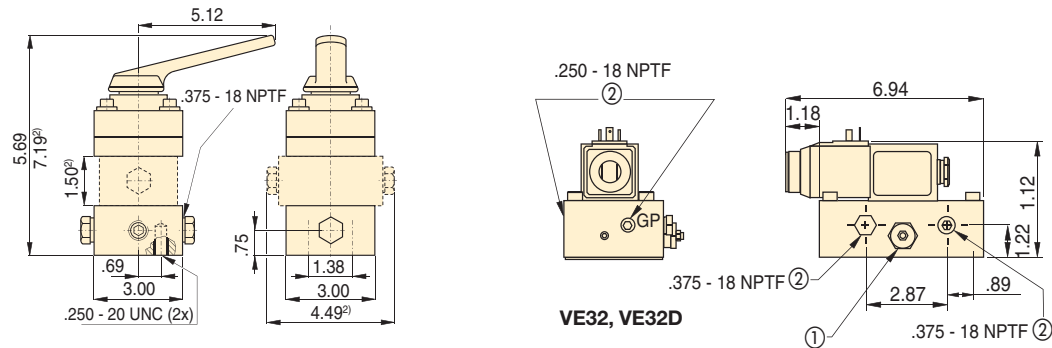

VE32, VE32D

VC3, VC3L, VC-15, VC15L, VC-4, VC4L, VC20, VC20L

²⁾ VC3L, VC15L, VC4L and VC20L only

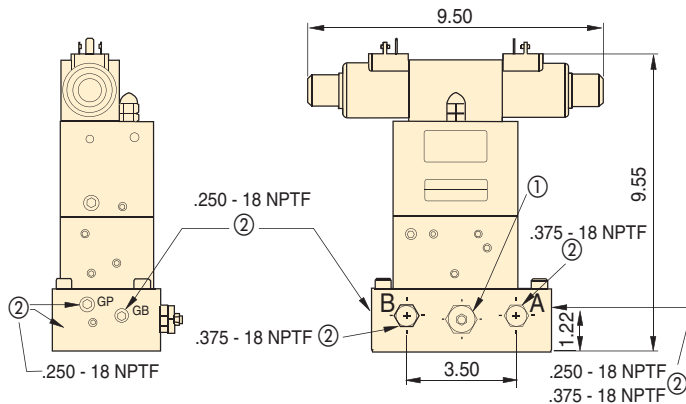

VE33, VE43

**VC,
VM,
VE
Series**



Flow Capacity:

4.5 gal/min.

Maximum Operating Pressure:

10,000 psi



User Adjustable Relief Valve

All VM- and VE-Series have a user adjustable relief valve to allow the operator to easily set the optimum working pressure.

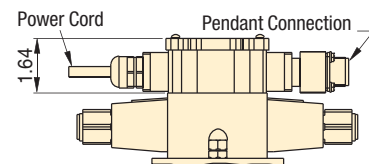

**VE33-115
VE43-115**

① User Adjustable Relief Valve

② Auxiliary Port

▼ Shown top to bottom: **VEC-15600D**, **VEK-15000B**, **VEC-15000B**



- Ideal for independent control of multiple cylinders or functions
- Relief valve and pilot-operated check accessory valves are stackable between manifold and valve body
- Remote and pump mounting

Valve Flow Path	Used with Cylinder	Valve Code	Hydraulic Symbol
4-Way, 3-Position (4/3) Open Center	Double-acting	A	
4-Way, 3-Position (4/3) Closed Center	Double-acting	B	
4-Way, 3-Position (4/3) Tandem Center	Double-acting	C	
4-Way, 3-Position (4/3) Float Center	Double-acting	D	
4-Way, 2-Position (4/2) Crossover Offset	Double-acting	E	
3-Way, 3-Position (3/3) Tandem Center	Single-acting	F	
3-Way, 3-Position (3/3) Closed Center	Single-acting	G	
2-Way, 2-Position (2/2) Normally Closed	System Un-loading	H*	
2-Way, 2-Position (2/2) Normally Open		K*	
4-Way, 2-Position (4/2) Float Offset	Double-acting	M	
3-Way, 2-Position (3/2) Normally Open	Single-acting	P	

* Requires use of tank port for dump or unloading.

Unmatched Combinations and Possibilities



3-Way Check Valve

Use a **VS-51** 3-way pilot operated check valve assembly to convert your 3-way modular valve into a load-holding valve.



4-Way Check Valve

Use a **VS-61** 4-way pilot operated check valve assembly to convert your 4-way modular valve into a load-holding valve.



System Pressure Control

To add system pressure control to your modular valve, order **VS-11 Relief Valve** assembly.



Bolt Kits for Accessory Valves With No Manifold

Order Bolt Kit **BK-2** when adding one of the accessory valves. Order Bolt Kit **BK-3**

when adding any combination of two accessory valves.

How to order one of the 1,300 possible model numbers?

With over 1,300 possible model numbers, Enerpac has the perfect valve for you. Use the "chart" to build your own valve for the specific application you require. This is the complete guide to all the Modular valves that are available.

Solenoid Operated Modular Valves

CUSTOM BUILD YOUR MODULAR VALVES

▼ This is how a Modular Valve Model Number is built up:

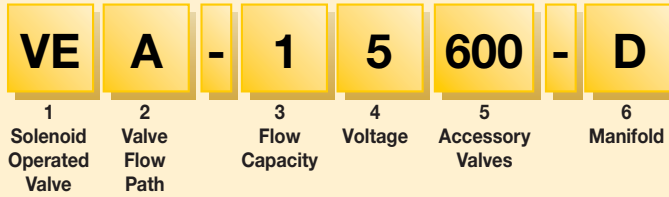

1 Product Type

VE = Solenoid Operated Valve

2 Valve Code

- A** = 4/3 Open Center
- B** = 4/3 Closed Center
- C** = 4/3 Tandem Center
- D** = 4/3 Float Center
- E** = 4/2 Crossover Offset
- F** = 3/3 Tandem Center
- G** = 3/3 Closed Center
- H** = 2/2 Normally Closed
- K** = 2/2 Normally Open
- M** = 4/2 Float Offset
- P** = 3/2 Normally Open

3 Flow Capacity

1 = 4 gallons per minute

4 Voltage

- 1** = 24 VDC
- 2** = 220/240 V, 1 ph, 50 Hz
- 5** = 115 V, 1 ph, 60 Hz
- 6** = 230 V, 1 ph, 60 Hz

5 Accessory Valves

- 000** = No accessory valves
- 100** = Relief Valve only
- 150** = Relief Valve and 3-way pilot operated check valve
Only for VEF/VEG
- 160** = Relief Valve and 4-way pilot operated check valve
Only for VEA/VEB/VEC/VED
- 500** = 3-way pilot operated check valve
Only for VEF/VEG
- 600** = 4-way pilot operated check valve
Only for VEA/VEB/VEC/VED

6 Manifold

- A** = No manifold**
- B** = Remote Mounted
- D** = Pump Mounted*

* Only for valve code: **VEA/VEC/VEF**

** Must order Bolt Kit separately.

Valve dimensions in inches.

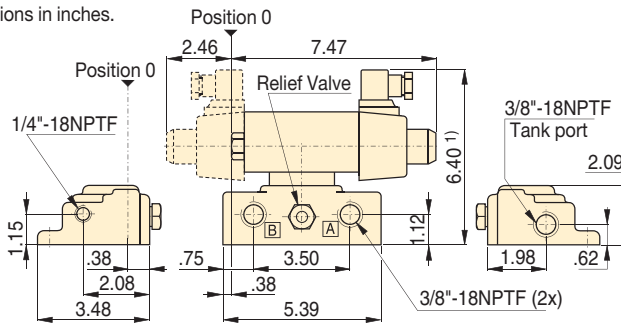

Modular Valve Pump Mounted

¹⁾ add 1.85 inch for each Accessory Valve

Maximum Operating Pressure (psi)	Amperage Draw			Seal Material	Valve Plug
	24 VDC	115 VAC 60 Hz	230 V 60 Hz		
0 - 10,000	N/A Inrush	3.6 A Inrush	1.8 A Inrush	Buna-N, Polyurethane	DIN 43650
	2.5 A Holding	1.0 A Holding	.5 A Holding		

VE Series



Flow Capacity:

4 gal/min.

Maximum Operating Pressure:

10,000 psi

Example: VEA-15600-D

VEA-15600-D is a Modular Valve with a 4-way, 3-position open center flowpath, 115 VAC, and an integral pilot-operated check valve, for mounting on an Enerpac pump.

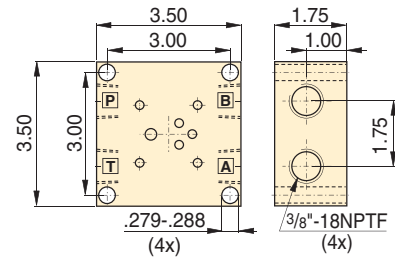

Modular Valve Remote Mount Manifold

Pressure Drop versus Oil Flow

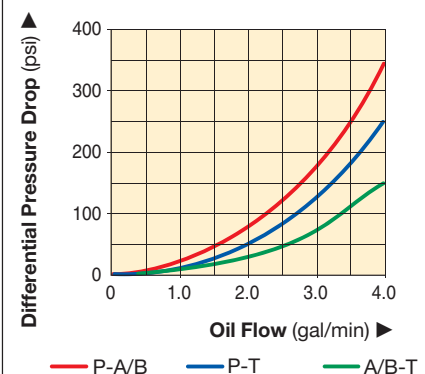

ENERPAC System Components –

All the additional components you need to complete your high pressure hydraulic system. Engineered to work with your Enerpac cylinders, pumps and tools.

All Enerpac components are designed and manufactured to the most exacting standards.

With this complete line of hydraulic hoses, couplers, fittings, manifolds, oil and gauges Enerpac has the accessories to compliment your system and ensure the efficient operation, long life, and safety of your hydraulic equipment.



Yellow Pages

For sample system set-ups and how to correctly specify your system components, please view the Enerpac **Yellow Pages**.

Page: 246















Maintain System Integrity

Use Enerpac System Components, designed to interface with Enerpac Cylinders, Pumps and Tools to ensure your system operates at peak performance.



System Components and Control Valves Section Overview

Component Type	Series		Page
Hoses	700 900		114 ▶
Couplers	A, C, F, Z		116 ▶
Hydraulic Oil	HF LX		118 ▶
Manifolds	A AM		118 ▶
Fittings	FZ		119 ▶
Hydraulic Force & Pressure Gauges	GF GP		120 ▶
Hydraulic Pressure Gauges	G, H		122 ▶
Test System Gauges	T		124 ▶
Digital Gauges	DGR		125 ▶
Gauge Assembly	GA		126 ▶
Gauge Accessories	GA, NV, V		127 ▶
Flow and Pressure Control Valves	V		128 ▶

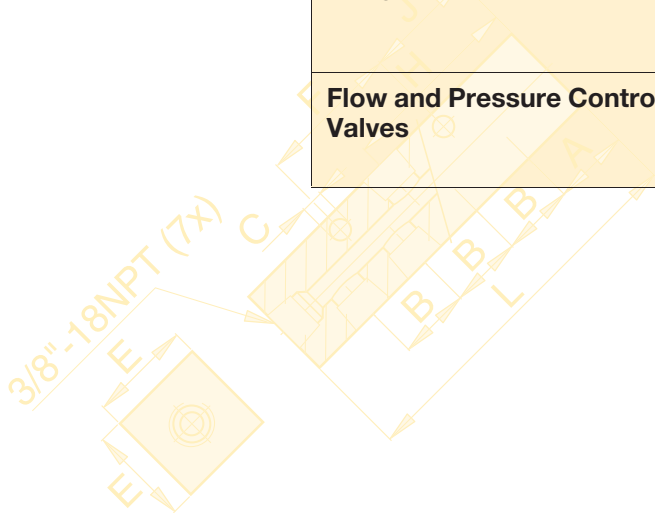
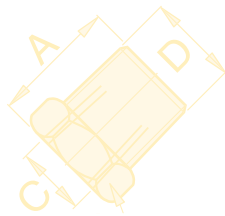
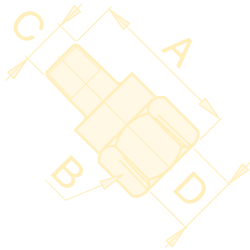
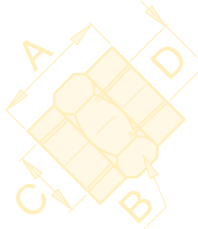

▼ Shown from top to bottom: HC-7206, HC-7210, HC-9206



Crimped-on rubber strain relief for improved life and durability on all models.

Thermo-plastic Hoses (700-Series)

- For demanding applications, featuring a 4:1 design factor
- Maximum working pressure of 10,000 psi
- Two layers of steel wire braids
- Outside jacket is polyurethane, to provide maximum abrasion resistance
- Exhibits low volumetric expansion under pressure to enhance overall system efficiency

Heavy-duty Rubber Hoses (900-Series)

- The most complete offering: 35 models up to 50 feet in length
- Rubber coated with two layers of steel wire braids
- Designed to comply with Material Handling Institute IJ-100 hose specification
- Flexible, with little “memory”, is the best choice for long hose runs



◀ *To prevent back pressure and to increase cylinder retraction speed, when using long hoses, the Enerpac HC-7300 range of hoses with increased internal diameter is the best choice.*

Emphasize Safety and Quality



To ensure the integrity of your system, specify only Enerpac hydraulic hoses.

WARNING !

- Do not exceed 10,000 psi maximum pressure.
- Do not handle hoses while under pressure.

More safety instructions in our “Yellow Pages”.

Page: 242

▼ Hose End Couplings

1/4" NPTF	
3/8" NPTF	
A-604	
A-630	
AH-604	
AH-630	
C-604	
CH-604	

High Pressure Hydraulic Hoses

**700
900
Series**



Inside Diameter:

.25 and .38 inch

Length:

2-50 feet

Maximum Operating Pressure:

10,000 psi

Internal Dia.	Hose End Assemblies and Couplers*		Hose Length	700-Series Thermo-plastic		900-Series Heavy-duty Rubber			
				Model Number	Wt. (lbs)	Model Number	Wt. (lbs)		
(in)	End one	End two	(ft)						
.25	1/4" NPTF	1/4" NPTF	6	-		H-9206Q	2.6		
		3/8" NPTF	6	-		H-9206S	2.6		
		A-630	6	HB-7206QB	2.4	HB-9206QB	3.1		
		AH-630	6	-		HB-9206Q	2.9		
		CH-604	6	HC-7206Q	2.3	HC-9206Q	3.0		
	3/8" NPTF			2	H-7202	1.2	H-9202	1.6	
				3	H-7203	1.5	H-9203	1.9	
				6	H-7206	2.0	H-9206	2.6	
				10	H-7210	3.0	H-9210	3.9	
				20	H-7220	6.2	H-9220	8.0	
				30	H-7230	10.0	H-9230	13.0	
				50	H-7250	15.4	H-9250	22.0	
		A-604		-		-		-	
			6	HA-7206B	2.5	HA-9206B	3.2		
			10	-		HA-9210B	4.5		
				-		-			
			AH-604	3	-		HA-9203	2.1	
				6	HA-7206	2.2	HA-9206	2.9	
				10	HA-7210	3.2	HA-9210	4.2	
			AH-630	6	HB-7206	2.2	HB-9206	2.9	
	C-604	3		HC-7203B	2.2	HC-9203B	2.9		
		6	HC-7206B	2.8	HC-9206B	3.7			
		10	HC-7210B	3.9	HC-9210B	5.0			
	CH-604	3	HC-7203	1.7	HC-9203	2.2			
		6	HC-7206	2.3	HC-9206	3.0			
		10	HC-7210	3.3	HC-9210	4.3			
		20	HC-7220	6.4	HC-9220	8.3			
	CH-604	CH-604	6	HC-7206C	2.4	HC-9206C	3.1		
			50	HC-7250C	15.4	HC-9250C	20.0		
	.38	3/8" NPTF		6	H-7306	3.5	H-9306	4.6	
10				H-7310	5.4	H-9310	7.0		
20				H-7320	10.0	H-9320	13.0		
30				H-7330	16.2	H-9330	21.0		
50				H-7350	15.2	H-9350	33.0		
CH-604			6	HC-7306	3.4	HC-9306	4.9		
			8	-		HC-9308	6.2		
			10	HC-7310	5.6	HC-9310	7.3		

* For technical information on couplers see next page.



Torque Wrenches Hoses

Use Enerpac 3.5:1 twin safety hoses with double-acting wrenches to ensure the integrity of your hydraulic system. See Selection Matrix.

Page: 206



Fittings

For additional fittings see the fitting page of the System Components section.

Page: 119



Hose Oil Capacity

When using long hose lengths, it is sometimes necessary to fill the pump reservoir after filling the hoses. To determine the hose oil capacity, use the following:

For .25" internal diameter hoses:
Capacity (in³) = .5892 x Length (ft)

For .38" internal diameter hoses:
Capacity (in³) = 1.3608 x Length (ft)

▼ Shown: FH-604, FR-400, A-630 disassembled, C-604, AH-604, AR-400



3/8" High Flow Couplers

- Standard equipment on most Enerpac cylinders
- Recommended for use on all Enerpac pumps and cylinders where space and porting permits
- Include "2-in-1" dust cap for use on male and female coupler halves

3/8" High Flow "Flush-face" Couplers

- Featuring "Push-to-connect" operation, to guarantee good connection every time
- Flush-face, zero-leak operation for minimal spillage
- HTMA* recognized for safety and performance

3/8" Regular Spee-D-Coupler®

- For medium duty applications; for use with hand pumps
- Includes female steel dust cap

1/4" Regular Coupler

- For use with small cylinders and hand pumps
- Includes female steel dust cap

* Hydraulic Tool Manufacturers Association

Quick Connection of Hydraulic Lines



Thread Sealer

To seal NPTF threads use one of the new anaerobic thread sealers or Teflon paste. When using Teflon tape, apply the tape one thread back from the end of a fitting to prevent it from entering the hydraulic system.



WARNING!

Couplers should be pressurized only when completely connected, and should not be coupled or uncoupled when pressurized.

More safety instructions in our "Yellow Pages".

Page: 242



S- and W-Series Torque Wrench Couplers

S- and W-Series Torque Wrenches require 1/4" spin-on couplers and THQ hoses.

Page: 183

▼ With the use of Enerpac High Flow Couplers, hoses are easily installed for multiple hydraulic line connections in this 34 points PLC-controlled lifting system.



Hydraulic Couplers



F-Series

Flush-faced couplers provide reduced pressure drop versus other types and are preferred in dirty, grimy construction and mining environments due to easy clean, non-dirt trapping faces.



Metal Dust Caps

Steel dust caps are available for the C-604 series couplers. Order model number: **CD-411M** for female half **CD-415M** for male half

A C F Series



Maximum Flow Capacity:
2,500 in³/min.

Thread:
1/4" and 3/8" NPTF

Maximum Operating Pressure:
10,000 psi

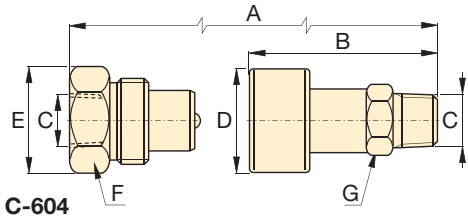

C-604

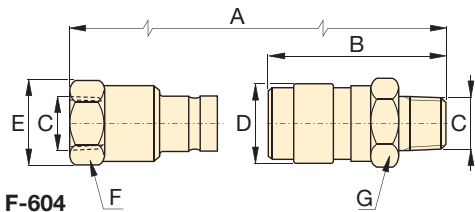

F-604

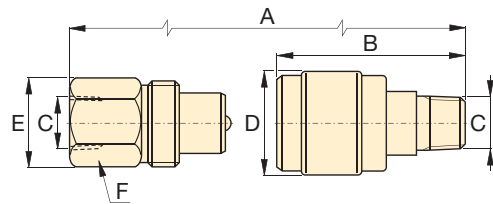

A-604, A-630



CT-604 Safety Tool

Use the Enerpac CT-604 to relieve hydraulic back pressure by safely bleeding the hydraulic coupler.

Minimize injuries from projectile parts and under-skin hydraulic fluid injections by eliminating unsafe coupler bleeding practices. The CT-604 is Enerpac-engineering safe for use at 10,000 psi (700 bar).

NOTE: C-Series only.

Maximum Flow Capacity (in ³ /min)	Coupler Type	Model Numbers			Dimensions (in)							Dust Cap(s)
		Complete Set	Female Half	Male Half	A*	B	C	D	E	F	G	
2,500	High Flow Coupler	C-604	CR-400	CH-604	3.26	2.87	3/8" NPTF	1.38	1.38	1.25	1.00	(2x) CD-411 Included
2,500	Flush-face coupler	F-604	FR-400	FH-604	4.36	2.85	3/8" NPTF	1.23	1.23	1.06	1.12	-
462	Regular Spee-D-Coupler®	A-604	AR-400	AH-604	3.09	2.53	3/8" NPTF	1.12	.94	.94	.73	Z-410 female only Included
462	Regular Coupler	A-630	AR-630	AH-630	2.61	1.72	1/4" NPTF	.87	.81	.75	.57	Z-640 female only Included

* Value A is total length when male and female halves are connected.

▼ Shown top to bottom: HF-101, HF-100, HF-102, LX-101, A65, and FZ1055



Enerpac System Components

Hydraulic Oil

Contents	Model Number	High viscosity index ensures maximum lubricity over a wide range of operation temperatures.
1 Quart	HF-100	
1 Gallon	HF-101	
5 Gallons*	HF-102	
55 Gallons	HF-104	
1 Gallon**	LX-101	

* Packed in two 2½ gallon cans.

** Hand pump oil.

HF Oil

- Specially formulated for power pumps
 - maximum volumetric efficiency
 - maximum heat transfer
 - prevents cavitation
 - anti-sludge, anti-rust, anti-foam additives
- Maximum film protective lubricity
 - anti-oxidation additives

LX Hand Pump Oil





- Specially formulated for hand pumps
 - anti-sludge, anti-rust additives
- Reduced handle effort over HF oil
 - good low temperature performance
- Not for use in power pumps

▼ Oil Specifications Chart

	LX Oil	HF Oil
ISO Grade	15	32
Viscosity Index	105 min	100 min
Viscosity at 210 °F	38 S.U.S.	44 S.U.S.
Viscosity at 100 °F	82 S.U.S.	164 S.U.S.
Viscosity at 0 °F	<1635 S.U.S.	<7236 S.U.S.
API Gravity	34.2	31.0/33.0
Flash, C.O.C. °F	375	400
Pour Point, °F	-45	-45
Paraffinic Base Color	Yellow	Blue

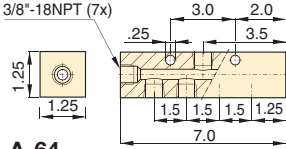
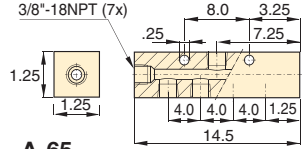
NOTE: SAE grades do not apply to hydraulic oil.

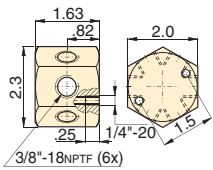
Manifolds

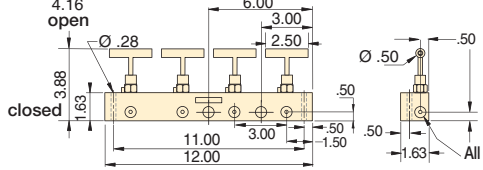
Description		Model No.	Dimensions (in)
7" Long Manifold with 7 female ports.		A-64	
14" Long Manifold that allows direct mounting of control valves to the manifold. 7 female ports.		A-65	
6-Port Hexagon Manifold Plugs furnished for all ports 3/8"-18 NPTF.		A-66	
Premounted Manifold Functions as split-flow valve to control 2 to 4 single-acting cylinders simultaneously. All ports 3/8"-18 NPTF.		AM-21 AM-41	











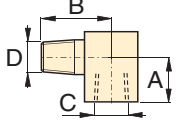

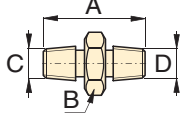
Hydraulic Oil, Manifolds and Fittings

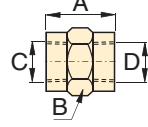
Recommended Tubing for Hand Plumbing Applications

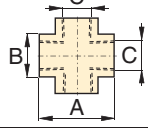
Enerpac does not supply high-pressure pipe or tubing but recommends the use of cold drawn steel tubing instead of regular pipe in the following dimensions:
 In place of 1/4" pipe use 3/8" tubing with a 0.065" minimum wall thickness.
 For 3/8" pipe use schedule 80 as a minimum or 1/2" with a 0.095" minimum wall thickness.
 For 1/2" pipe use schedule 80 as a minimum or 3/4" tubing with a 0.135" minimum wall thickness.
 All tubing wall thicknesses based on a 55,000 psi minimum tensile strength.

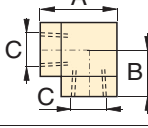
**A, AM
 FZ,
 HF, LX
 Series**

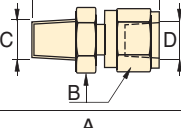

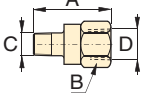
Description		Model Number	Dimensions (in)				Diagram	
			A	B	C	D		
Street Elbow From: 3/8"-NPTF Male To: 3/8"-NPTF Female			FZ-1616	.94	1.30	3/8"-18 NPTF	3/8"-18 NPTF	
Reducing Connector From: 3/8"-NPTF Female To: 1/4"-NPTF Female				FZ-1615	1.13	1.00	3/8"-18 NPTF	1/4"-18 NPTF
From: 1/2"-NPTF Female To: 3/8"-NPTF Female		FZ-1625	1.88		1.14	1/2"-18 NPTF	3/8"-18 NPTF	
Hex Nipple From: 1/4"-NPTF Male To: 1/4"-NPTF Male			FZ-1608	1.50	.63	1/4"-18 NPTF	1/4"-18 NPTF	
From: 3/8"-NPTF Male To: 3/8"-NPTF Male				FZ-1617	1.47	.75	3/8"-18 NPTF	
Coupling From: 3/8"-NPTF Female To: 3/8"-NPTF Female			FZ-1614 FZ-1605	1.13	1.00	3/8"-18 NPTF	3/8"-18 NPTF	
					1.13	.75	1/4"-18 NPTF	
Cross From: 3/8"-NPTF Female To: 3/8"-NPTF Female			FZ-1613	1.77	1.00	3/8"-18 NPTF	-	
Tee From: 3/8"-NPTF Female To: 3/8"-NPTF Female				FZ-1612	1.77	1.00	3/8"-18 NPTF	
Elbow From: 3/8"-NPTF Female To: 3/8"-NPTF Female			FZ-1610	1.38	.88	3/8"-18 NPTF	-	
Bushing From: 3/8"-NPTF Male To: 1/4"-NPTF Female				FZ-1630	.75	.75	1/4"-18 NPTF	
Swivel Fitting From: 3/8"-NPTF Male To: 3/8"-NPTF Female			FZ-1660	1.56	.88	3/8"-18 NPTF	3/8"-18 NPTF	
Adaptor Female								
Male								
3/8"-18 NPTF	1/4"-18 NPTF		FZ-1055	1.75	.94	1/4"-18 NPTF	3/8"-18 NPTF	
1/2"-14 NPTF	1/4"-18 NPTF		FZ-1633	1.69	1.13	1/4"-18 NPTF	1/2"-14 NPTF	
1/2"-14 NPTF	3/8"-18 NPTF	FZ-1634	1.69	1.13	3/8"-18 NPTF	1/2"-14 NPTF		

▼ Shown: GF-871P, GP-10S



- GF-Series gauges are calibrated with dual scale reading for pressure and force
- Excellent readability; 4 inch diameter gauge face
- Fast, easy installation
- GF-Series gauges are glycerine filled
- Stainless steel gauge cases for corrosion resistance
- GP-Series gauges are calibrated with dual scale reading for psi and bar

▼ A GP-10S gauge is used on this press to check the hydraulic pressure required to bend flat steel bar.



Visual References for System Pressure and Force



Auto-Damper Valve

For automatic control of gauge fluctuations, the V-10 Auto-Damper Valve controls the movement of the gauge needle by restricting oil flow in and out of the gauge. No adjustments needed.

Page: 129



Snubber Valve

Infinitely adjustable for metering oil out of a gauge. The V-91 Snubber Valve is also suitable as a shut-off valve to protect the gauge during high cycle applications.

Page: 129

Used With	
	All Cylinders
	All Cylinders
	All 5 ton RC Cylinders
	All 10 ton RC Cylinders
	All 25 ton RC Cylinders
	RC and RR 50 ton Cylinders
	12 ton RCH-Series
	RCH/RRH-20, 30 and 60 ton
	RCS-201, 302
	RCS-502, 1002
	25 ton Presses
	50 ton Presses
	25-50 ton Presses
	100 ton Presses
	150-200 ton Presses

Hydraulic Force and Pressure Gauges



Maximum Indicator Pointer

Indicator retains peak readings of pressure or force generated by the system.

Order model number: **H-4000G**.

Can easily be installed on GP-Series dry gauges.



Load Gauges

To measure external load supported by a cylinder or jack. For pressing parts together under pre-determined loads, weighing, testing, etc.

Pressure Gauges

To measure the input pressure into cylinders, jacks or high pressure systems. Also for all testing applications.

GP-Series gauges are dry gauges.
GF-Series gauges are glycerine filled.

GF GP Series



Pressure Range:

0-15,000 psi

Face Diameter:



4 inch

Accuracy, % of full scale:

± 1%

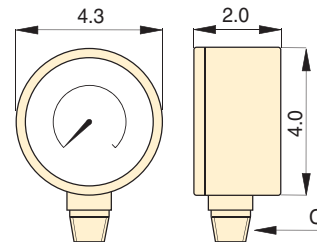
All Models



Gauge Type and Calibration					Units per Division	Model Number*	Thread C (in)	Gauge Adaptor		
										
psi	bar	psi	lbs	tons			GA-1	GA-2	GA-3	
0-10,000	0-700	–	–	–	100 psi, 10 bar	GP-10S	1/2 NPTF	●	●	
0-15,000	0-1000	–	–	–	200 psi, 10 bar	GP-15S	1/2 NPTF	●	●	
–	–	0-10,000	0-10,000	0-5	100 psi, 100 lbs, .1 ton	GF-5P	1/2 NPTF	●	●	
–	–	0-10,000	0-22,200	0-11	100 psi, 200 lbs, .2 ton	GF-10P	1/2 NPTF	●	●	
–	–	0-10,000	0-51,500	0-25.5	100 psi, 500 lbs, .5 ton	GF-20P	1/2 NPTF	●	●	
–	–	0-10,000	0-110,000	0-55	100 psi, 1000 lbs, 1 ton	GF-50P	1/2 NPTF	●	●	
–	–	0-10,000	0-27,000	0-13.5	100 psi, 200 lbs, .25 ton	GF-120P	1/2 NPTF	●	●	
–	–	0-10,000	–	0-23.5/36/65	100 psi, .5/.5/1 ton	GF-813P	1/4 NPTF			●
–	–	0-10,000	–	0-22/32	100 psi, .5/.5 ton	GF-230P	1/2 NPTF	●	●	
–	–	0-10,000	–	0-50/100	100 psi, 1/1 ton	GF-510P	1/2 NPTF	●	●	
–	–	0-10,000	0-51,500	0-25.5	100 psi, 500 lbs, .5 ton	GF-20P	1/2 NPTF	●	●	
–	–	0-10,000	0-11,000	0-55	100 psi, 1000 lbs, 1 ton	GF-50P	1/2 NPTF	●	●	
–	–	0-10,000	–	0-25.5/32.5/55	100 psi, .5/.5/.5 ton	GF-835P	1/4 NPTF			●
–	–	0-10,000	–	0-79/103	100 psi, 1/1 ton	GF-871P	1/4 NPTF			●
–	–	0-10,000	–	0-150/200	100 psi, 5/5 ton	GF-200P	1/4 NPTF			●

* Metric scale Force Gauges are available by changing the "P" suffix to "B".

▼ Shown: H-4049L, G-2534R, G-4089L, G-2535L, G-4040L



Visual References for System Pressure

Glycerine Filled (G-Series)

- Calibrated in dual scale reading in psi and bar
- All pressure sensing parts sealed and dampened by glycerine for long life
- Includes safety blow-out disk and pressure equalizing membrane
- Gauge snubbers or needle valves recommended for high cycle applications

High Cycle (H-Series)

- Calibrated in dual scale reading in psi and bar
- Ideal for use in many applications, specifically for high cycle and harsh environments
- Gauge snubbers or needle valves recommended to shut off gauge when not in use



Gauge Adaptor

For easy gauge installation into almost any system, Enerpac offers a complete line of gauge adaptors.

Page: 126



Snubber Valve

Infinitely adjustable for metering oil out of a gauge. The V-91 Snubber Valve is also suitable as a shut-off valve to protect the gauge during high-cycle applications.

Page: 129



◀ When lifting or pressing, always use a gauge. A gauge is your "window" to the system—it lets you see what's going on.

Hydraulic Pressure Gauges

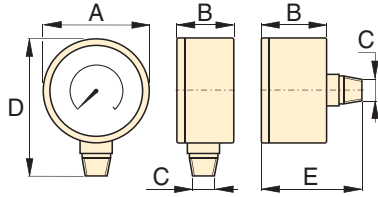

Dimensions (in)						
Face Diam.	Connection	A	B	C	D	E
2.5	Lower Mount	2.50	1.46	¼" NPTF	3.31	–
2.5	Center Rear	2.50	1.46	¼" NPTF	–	2.48
4.0	Lower Mount	4.0	1.15	¼" NPTF	4.80	–
4.0	Lower Mount	4.0	1.93	½" NPTF	5.38	–

Note: dimensions for reference only.

G H Series



Pressure Range:
0-15,000 psi

Face Diameter:
2.5-4 inches

Accuracy, % of full scale:
±1% and 1½%



Maximum Indicating Pointer

Indicator retains peak readings of pressure or force generated by the system.

Order model number: **H-4000G**.

Note: For use on H-Series gauges only.

▼ SELECTION CHART

Gauge Series	Pressure Range		Model Number				Major Graduation		Minor Graduation		Major Graduation		Minor Graduation	
			Face ø 2.5" ¼" NPTF Lower Mount	Face ø 2.5" ¼" NPTF Center Rear	Face ø 4" ¼" NPTF Lower Mount	Face ø 4" ½" NPTF Lower Mount								
			Accuracy ±1½%	Accuracy ±1½%	Accuracy ±1%	Accuracy ±1%	(psi)				(bar)			
	(psi)	(bar)					(2.5")	(4")	(2.5")	(4")	(2.5")	(4")	(2.5")	(4")
G-Series	0-100	0-7	G2509L	–	–	–	10	–	2	–	1	–	0,01	–
	0-160	0-11	G2510L	–	–	–	10	–	2	–	1	–	0,02	–
	0-200	0-14	G2511L	–	–	–	50	–	5	–	1	–	0,02	–
	0-300	0-20	G2512L	–	–	–	50	–	5	–	5	–	0,50	–
	0-600	0-40	G2513L	–	–	–	100	–	10	–	10	–	1	–
	0-1,000	0-70	G2514L	G2531R	–	–	100	–	20	–	10	–	1	–
	0-2,000	0-140	G2515L	–	–	–	500	–	50	–	10	–	2	–
	0-3,000	0-200	G2516L	–	–	–	500	–	50	–	50	–	5	–
	0-6,000	0-400	G2517L	G2534R	–	–	1000	–	100	–	100	–	10	–
	0-10,000	0-700	G2535L	G2537R	G4088L	G4039L	2000	1000	200	100	100	100	10	10
0-15,000	0-1000	G2536L	G2538R	G4089L	G4040L	3000	3000	200	200	100	100	20	20	
H-Series	0-10,000	0-700	–	–	H4049L	H4071L	–	1000	–	100	–	100	–	10

▼ Gauge shown: T-6003L



T Series

Pressure Range:
0-50,000 psi

Face Diameter:
6.4 inches

Accuracy, % of full scale:
± 1/2% and ± 1 1/2%



Cone Mount Gauge Adaptor

Contains fittings to connect .25" cone fitting gauge to .38" cone system.
Kit includes **43-301** tee, **43-704** gauge adaptor and **45-116** tubing.
Order model number: **83-011**.

Page: 67



Cone Mount Gauge Connector

For connecting gauges with .25" cone fitting directly to model number 11-100 or 11-400 pump. May be used with other .25" cone systems.
Order model number: **43-704**

Page: 67

- Calibrated for dual scale reading in psi and bar
- All gauges have spring-loaded backs with rubber blow-out plugs to protect case assembly in case of over-pressurization
- 40,000 and 50,000 psi models include flange mounting
- 1/2" NPTF versions are made of high strength alloy steel
- .25" cone models are made of 316 stainless steel, with 403 stainless steel on 40,000 and 50,000 psi models
- Integral maximum indicator pointer standard on all gauges

▼ An Enerpac P-2282 hand pump equipped with a T-6011L test system gauge is used for proof pressure testing of hydraulic valves.

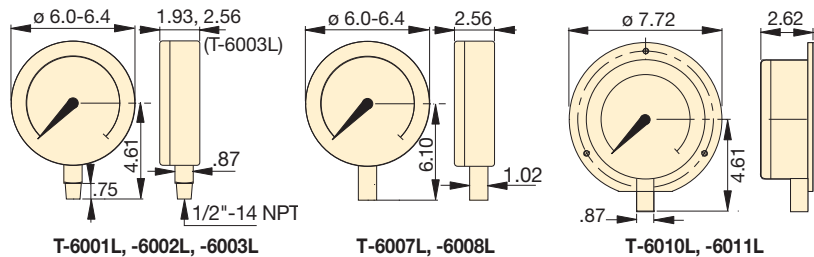

Pressure Range (psi)	Pressure Range (bar)	Model Number		Number Intervals (psi)	Graduation Intervals (psi)	Number Intervals (bar)	Graduation Intervals (bar)
		Alloy Steel 1/2" NPTF	Stainless Steel .25" Cone				
0-1,000*	0-70	T-6001L	-	100	10	10	1
0-5,000*	0-350	T-6002L	-	500	50	50	5
0-10,000*	0-700	T-6003L	T-6007L	1,000	100	100	10
0-20,000*	0-1400	-	T-6008L	1,000	100	200	20
0-40,000**	0-2800	-	T-6010L	5,000	200	500	20
0-50,000**	0-3500	-	T-6011L	5,000	500	500	50

* Accuracy: ± 1/2%

** Accuracy: ± 1 1/2%

Digital, Hydraulic Pressure Gauges

▼ Gauge shown: **DGR-2**



- Rated for system pressure up to 20,000 psi
- Displays in multiple units: psi, bar, mPA, kg/cm² (user selectable)
- Zero reset – ensures that gauge reads actual system pressure
- Batteries included, condition indicator on readout
- IP65 rated case design
- Shut off selectable – menu driven
- UL listed, CE and RoHS compliant

DGR Series

Pressure Range:

0-20,000 psi

Voltage:

3 VDC (battery)

Accuracy, % of full scale:

± 0.25%



Back-lit Readout

Back-lit readout allows easy reading in less than ideal lighting.



Gauge Adaptor

For easy gauge installation into almost any system, Enerpac offers a complete line of gauge adaptors.

Page: 127

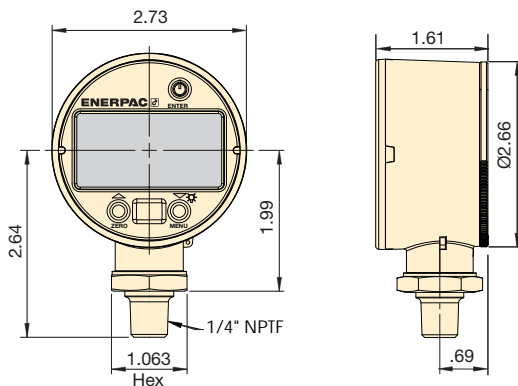

▼ Greater accuracy and easier to read: enhance your ability to monitor and control hydraulic system pressure up to 20,000 psi.



Pressure Rating (psi)		Model Number	Pressure Rating (bar)		Pressure Rating (MPa)		Pressure Rating (Kg/cm ²)		Weight (lbs)
Range	Resolution		Range	Resolution	Range	Resolution	Range	Resolution	
0-20,000	1	DGR-2	0-1380	0.1	0-140	0.01	0-1400	0.1	0.5

▼ GA45GC



Maximum Operating Pressure:
10,000 psi

Connection 1:
3/8" NPTF male

Connection 2:
CR-400 Coupler

45° Angled gauge adaptor improves safe working conditions

- 45° angled gauge improves visibility
- Slim and narrow design
- Easy to fit in a broad range of systems
- Maximize controlled load movement
- Glycerin dampened gauge with dual scale
- Enerpac High Flow female coupler

▼ *The Gauge Adaptor Assembly is the window to your system; allows easy reading of the pressure for safe operation.*

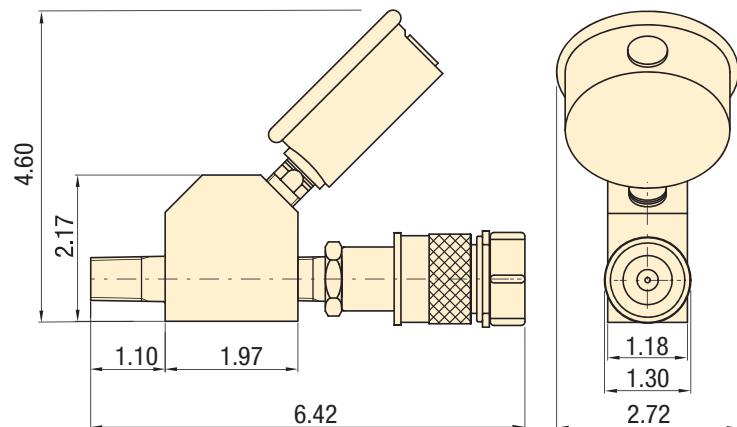

Model Number	Gauge Port	Male End	Female End	Gauge Range	
				(psi)	(bar)
GA45GC	G2535L	3/8" NPTF	CR-400	0-10,000	0-700

Gauge Accessories

▼ Shown left to right: GA-3, V-91, GA-1, GA-2, GA-4, NV-251, GA-918







GA, NV, V Series

Operating Pressure:
10,000 psi

▼ A gauge is easily installed into your hydraulic system using a gauge adaptor.



	Gauge Adaptors (GA-Series)									
	<ul style="list-style-type: none"> • For easy mounting of a pressure gauge into your system • Male end screws into pump or cylinder port, female end accepts hose or coupler, third port is for gauge connection • GA-918 provides for swivel connection • Simplifies gauge installation and reading 									
	Model Number	Gauge Port (NPTF)	Male End (NPTF)	Female End (NPTF)	Dimensions (in)					
					A	B	C	D	E	F
	GA-1	1/2" NPTF	3/8" NPTF	3/8"	2.81	1.24	1/2" NPTF	3/8" NPTF	3/8" NPTF	1.25
	GA-2	1/2" NPTF	3/8" NPTF		6.10	1.38	1/2" NPTF	3/8" NPTF	3/8" NPTF	1.25
	GA-3	1/4" NPTF	3/8" NPTF		5.25	1.38	1/4" NPTF	3/8" NPTF	3/8" NPTF	1.25
	GA-4	1/2" NPTF	1/4" NPTF		4.38	1.38	1/2" NPTF	1/4" NPTF	3/8" NPTF	1.25

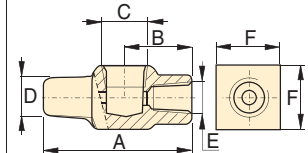

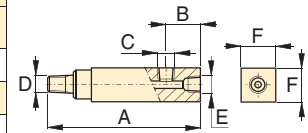

GA-1

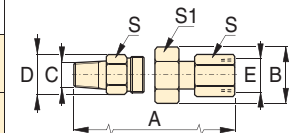

GA-2, GA-3, GA-4

	Swivel Adaptor (GA-918)							
	• Simplifies gauge installation and reading							
Model Number	Dimensions (in)							
	A	B	C	D	E	S	S1	
GA-918	4.62	1.72	1/2" NPTF	1.30	1/2" NPTF	1.13	1.50	



	Needle Valves (NV- and V-Series)									
	<ul style="list-style-type: none"> • Both NV-251 and V-91 provide positive shut-off • 316 stainless steel stem, 24 threads/in. 									
Model Number	Orifice	Thread Size	Dimensions (in)							
			A	B	C	D	E	F	G	
NV-251	.17	1/4" NPT	2.22	.75	.38	1.81	2.25	1.13	.72	
V-91	.19	1/2" NPT	3.50	1.44	.63	1.25	2.50	1.25	—	

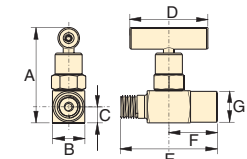

NV-251

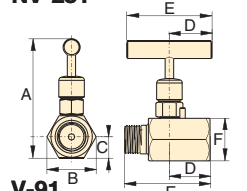

V-91

▼ Shown from left to right: V-152, V-66, V-82, V-161, V-42, V-17



Your Hydraulic Control Solution

▼ The V-152 Pressure Relief Valve limits the pressure or force developed in the hydraulic system.

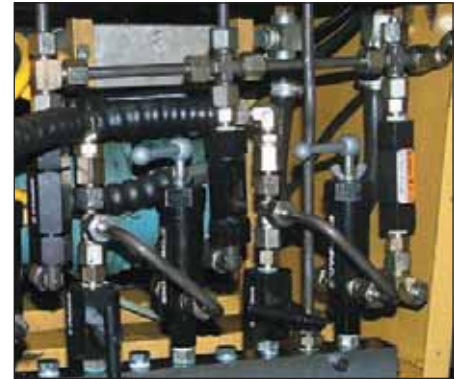

- All valves are rated for 10,000 psi operating pressure
- All valves feature NPTF porting to insure against leakage at rated pressure
- All valves are painted, coated, or plated for corrosion resistance



Valve Applications

To see these valves used in typical hydraulic circuits, please see our "Yellow Pages".

Page: 242

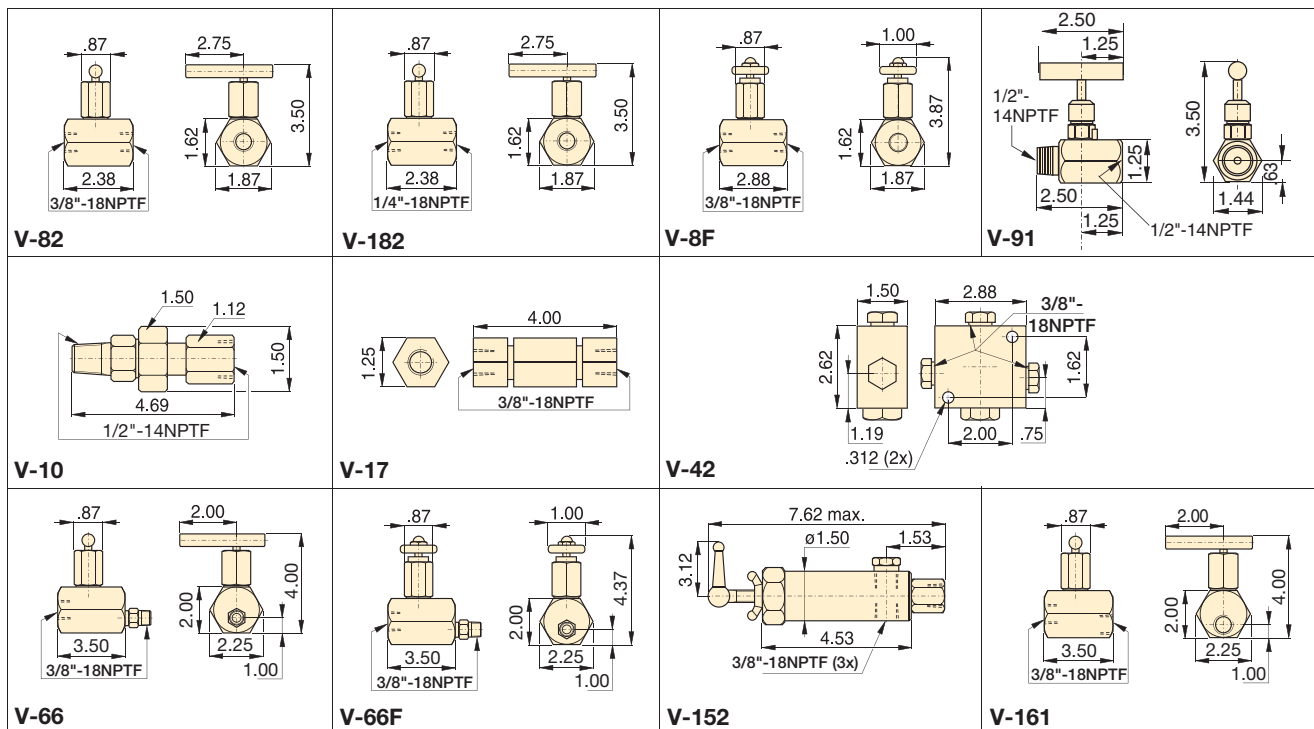

Valve Dimensions in inches.

Flow and Pressure Control Valves



Premounted Manifold

For two or four port manifold with integral flow control valves, see the manifold page of the System Components section.

Page: 118



Fittings

For additional fittings see the fitting page of the System Components section.













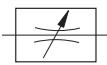

Page: 119

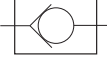
V Series

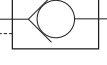

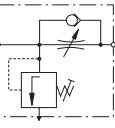
Maximum Operating Pressure:

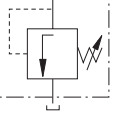
10,000 psi

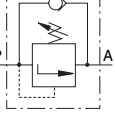
Valve Type and Model Number	Description	Hydraulic Symbol
Needle Valve V-82 V-182F V-8F	 <p>V-82: To control cylinder speed. Can also be used as shut-off valve for temporary load holding. V-182: Same as V-82, but with V-8F: Similar to V-82, but with very fine metering for precise flow control. Not recommended as shut-off valve.</p>	
Snubber Valve V-91	 <p>V-91: Adjustable for metering oil out of a gauge to prevent snapping of gauge pointer when load or pressure is suddenly released. Also suitable as shut-off valve to protect</p>	
Auto Damper® Valve V-10	 <p>V-10: To be used when gauge pressure must be monitored during high cycle applications. Creates a flow resistance when load is released suddenly.</p>	
Check Valve V-17	 <p>V-17: Ruggedly built to resist shock and operate with low pressure drop. Closes smoothly without pounding. $\frac{3}{8}$" NPTF female ports.</p>	
Pilot Operated Check Valve V-42	 <p>V-42: Can be mounted at the cylinder to hold the load in case of system pressure loss. Normally used with double-acting cylinders where pilot port receives pressure</p>	
Manually Operated Check Valve V-66* V-66F	 <p>V-66: Used for load holding applications with single and double acting cylinders. Valve is manually opened to allow oil to flow back to tank when cylinder retracts. V-66F: Similar to V-66, but with very fine metering capability for precise flow control. Not designed for load holding applications.</p>	
Pressure Relief Valve V-152*	 <p>V-152: Limits pressure developed by the pump in hydraulic circuit, thus limiting the force created by other components. Valve opens whenever preset pressure is reached.</p>	
Sequence Valve V-161	 <p>V-161: To control oil flow to a secondary circuit. Flow is blocked until system pressure rises to the V-161 setting. When this pressure level is reached, the V-161 opens to</p>	

* See page 52-53 for more information on extreme pressure and flow control valves.

ENERPAC Hydraulic Presses are available in a wide variety of standard capacities and configurations, or you can “build your own” with the easy-to-use matrix.

The press frames are a welded construction for maximum strength and durability, and when combined with the power of high pressure hydraulics, will provide years of safe and dependable service in your workshop.

Enerpac press capacities range from 10-ton to 200-ton and are available in Bench, C-Frame, Arbor, H-Frame and Roll-Frame models.



These Press features increase productivity and broaden the range of applications:

Standard on many Enerpac IP Presses, the exclusive Hydra-Lift™ offers effortless adjustment to the press daylight by use of a hydraulic lift.











Easy horizontal cylinder position is achieved with the unique “roller-head” cylinder mounting block, standard on most Enerpac IP Presses.



Optional “V-blocks” for positioning of complex parts are designed with high-strength steel for long life.



Press Section Overview

Capacity (tons)	Press Type and Functions	Series		Page
10-200	H-Frame Presses	IP		132 ▶
50-200	Roll Frame Presses	IPR		136 ▶
5-20	C-Clamp Presses	A		138 ▶
10-30	Arbor Presses	A		138 ▶
10	Bench Frame Press	A IP		138 ▶
10-200	Press Accessories Press Speed Chart			140 ▶
10-200	Custom Built Presses	IP		141 ▶
5 1-100	Tension Meter Load Cells	TM LH		142 ▶
	Press Application Ideas			143 ▶

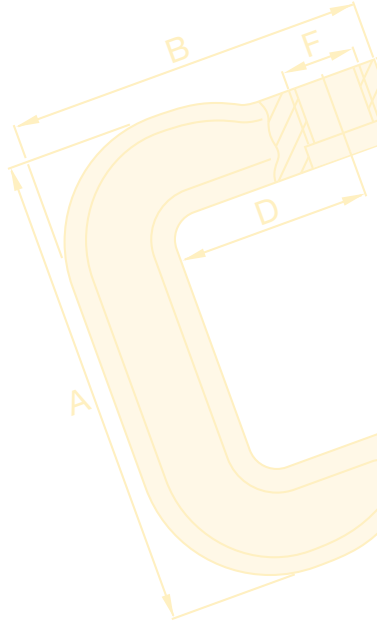

▼ Press shown: IPE-5060



- Quality welded frame for maximum strength and long life
- Exclusive “Hydra-Lift™” bed for effortless adjustment of the vertical daylight (10-ton models are manual)
- Roller head design is standard to allow movement and locking of the cylinder from side to side (10-ton, 25-ton and 30-ton are manual)
- All models in the Quick Selection Chart have been matched to a pump, cylinder, hoses and gauge, offering the complete package



◀ An Enerpac H-Frame press quickly removes the shaft from this assembly.

Setting the Industry Standard



Cylinder Mounting Block

Allows cylinder mounting into a press frame, while also allowing side to side adjustment of cylinder position.

Page: 140



Hydra-Lift™

Allows easy, effortless daylight adjustment. Standard on most H-Frame presses.

Page: 140



Pump Mounting Bracket

Heavy-duty steel brackets allow mounting of one of the Enerpac Power Sources to power your press.

Page: 140



Gauge Included

All standard press models include a gauge and gauge adaptor, matching the press capacity.

Page: 135



V-Blocks

These optional V-Blocks are designed for easy fixturing of round stock and other non-uniform materials. Featuring precise fit into the press bolster.

Page: 140

H-Frame Presses



Ordering Variations

Any variations to a listed part number must be ordered as two separate items. For example, if you need a different voltage electric pump, please order from the modular matrix on page 141 and the electric pump from the modular matrix on page 87 (electric) or page 93 (air).

Any questions should be directed to our Technical Service Department.

Page: 140



Cylinder Types



= Single-acting, Spring Return



= Double-acting, Hydraulic Return

IP Series



Capacity:

10-200 tons

Maximum Daylight and Width:

54.50 & 48.00 inches

Maximum Operating Pressure:

10,000 psi

▼ QUICK SELECTION CHART

For more technical information see next page.

Press Capacity (tons)	Maximum Vertical Daylight (in)	Maximum Bed Width (in)	Power Source					Press Model Number	Cylinder			Speed (sec/in)*	
			Type			Valve			Stroke (in)	Rapid Advance	Pressing		
			Man.	Elec.	Air	Man.	Elec.						
10	40.00	18.63		●		●		IPE-1215	●		10	0.90	6.70
	40.00	18.63			●	●		IPA-1220	●		10	2.20	13.40
	40.00	18.63	●			●		IPH-1240	●		10	{4}	{15}
	40.00	18.63	●			●		IPH-1234		●	10	{2}	{15}
	40.00	18.63			●	●		IPA-1244		●	10	2.20	13.40
25	54.50	29.00		●		●		IPE-2505	●		6	1.50	15.40
	54.50	29.00		●			●	IPE-2510	●		14	.70	7.70
	54.50	29.00			●	●		IPA-2520	●		14	5.20	30.90
	54.50	29.00	●			●		IPH-2531	●		14	{5}	{34}
30	54.50	29.00			●	●		IPA-3071		●	14	.60	43.00
	54.50	29.00		●			●	IPE-3060		●	14	.90	9.80
	54.50	29.00	●			●		IPH-3080		●	14	{7}	{34}
50	48.56	28.75		●			●	IPE-5010	●		13	1.02	11.04
	48.56	28.75			●	●		IPA-5021	●		6	1.00	74.00
	48.56	28.75	●			●		IPH-5030	●		6	{2}	{38}
	48.56	28.75	●			●		IPH-5031	●		6	{11}	{73}
	48.56	28.75		●		●		IPE-5005	●		6	2.90	28.90
	48.56	28.75			●	●		IPA-5073		●	13	1.00	22.20
	48.56	28.75		●			●	IPE-5060		●	13	1.00	11.00
48.56	28.75	●			●		IPH-5080		●	13	{2}	{38}	
100	42.50	35.00			●	●		IPA-10023	●		10	1.90	41.20
	42.50	35.00		●			●	IPE-10010	●		10	1.90	20.60
	42.50	35.00	●			●		IPH-10030	●		10	{3}	{70}
	42.50	35.00		●			●	IPE-10060		●	13	1.90	20.60
	42.50	35.00	●			●		IPH-10080		●	6	{3}	{70}
150	48.50	48.00		●		●		IPE-15065		●	13	2.20	15.40
200	48.50	48.00		●		●		IPE-20065		●	13	3.10	22.10

* {--} Speed in strokes per inch plunger travel

The moveable
“cylinder mounting
block” allows the
user to quickly
adapt the press
to a specific job.▶



◀ For full features see page 132.

Press Capacity (tons)	Press Model Number	Pump Model Number	Page:	Cylinder Model Number	Page:	H-Frame Press Dimensions (in)					
						A (max)	A (min)	B	C	D	E
10	IPE-1215	PEM-1201B	73	RC-1010	6	40.00	2.44	–	46.75	5.00	18.63
	IPA-1220	XA-12	94	RC-1010	6	40.00	2.44	–	46.75	5.00	18.63
	IPH-1240	P-392	58	RC-1010	6	40.00	2.44	–	46.75	5.00	18.63
	IPH-1234	P-84	60	RR-1010	32	40.00	2.44	–	46.75	5.00	18.63
	IPA-1244	XA-12V	94	RR-1010	32	40.00	2.44	–	46.75	5.00	18.63
25	IPE-2505	PUJ-1200B	70	RC-256	6	54.50	7.00	–	57.00	11.88	29.00
	IPE-2510	ZE3310SB-N	84	RC-2514	6	54.50	7.00	–	57.00	11.88	29.00
	IPA-2520	XA-12	95	RC-2514	6	54.50	7.00	–	57.00	11.88	29.00
	IPH-2531	P-80	60	RC-2514	6	54.50	7.00	–	57.00	11.88	29.00
30	IPA-3071	PAM-1042	99	RR-3014	32	54.50	7.00	–	57.00	11.88	29.00
	IPE-3060	ZE3410SB-N	85	RR-3014	32	54.50	7.00	–	57.00	11.88	29.00
	IPH-3080	P-84	60	RR-3014	32	54.50	7.00	–	57.00	11.88	29.00
50	IPE-5010	ZE4320SB-N	85	RC-5013	6	48.56	7.06	18.76	54.00	10.38	28.75
	IPA-5021	PAM-1022	99	RC-506	6	48.56	7.06	18.76	54.00	10.38	28.75
	IPH-5030	P-462	60	RC-506	6	48.56	7.06	18.76	54.00	10.38	28.75
	IPH-5031	P-80	60	RC-506	6	48.56	7.06	18.76	54.00	10.38	28.75
	IPE-5005	PUJ-1200B	70	RC-506	6	48.56	7.06	18.76	54.00	10.38	28.75
	IPA-5073	ZA4408MX	92	RR-5013	32	48.56	7.06	18.76	54.00	10.38	28.75
	IPE-5060	ZE4420SB-N	85	RR-5013	32	48.56	7.06	18.76	54.00	10.38	28.75
	IPH-5080	P-464	60	RR-5013	32	48.56	7.06	18.76	54.00	10.38	28.75
100	IPA-10023	ZA4208MX	92	RC-10010	6	42.50	7.00	20.00	51.00	11.69	35.00
	IPE-10010	ZE4320SB-N	85	RC-10010	6	42.50	7.00	20.00	51.00	11.69	35.00
	IPH-10030	P-462	60	RC-10010	6	42.50	7.00	20.00	51.00	11.69	35.00
	IPE-10060	ZE4420SB-N	85	RR-10013	32	42.50	7.00	20.00	51.00	11.69	35.00
	IPH-10080	P-464	60	RR-1006	32	42.50	7.00	20.00	51.00	11.69	35.00
150	IPE-15065	ZE5420SG-N	85	RR-15013	32	48.50	12.50	28.00	54.50	10.00	48.00
200	IPE-20065	ZE5420SG-N	85	RR-20013	32	48.50	12.50	28.00	54.50	10.00	48.00

H-Frame Presses

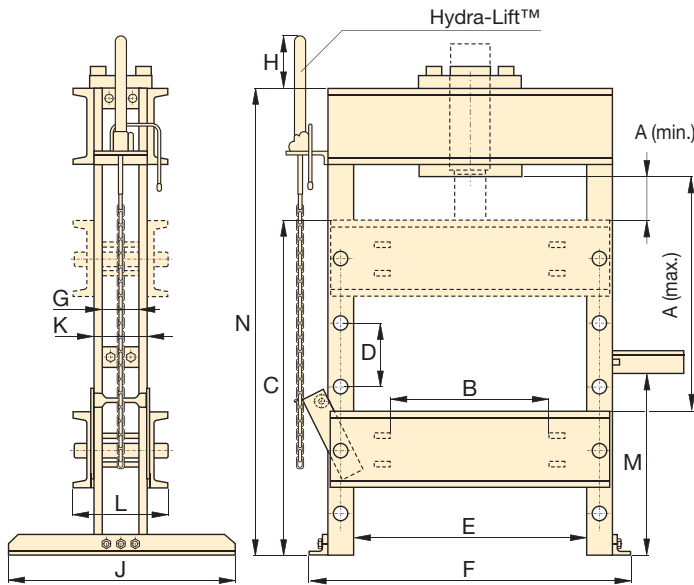

IP Series



Capacity:
10-200 tons

Maximum Daylight and Width:
54.50 & 48.00 inches

Maximum Operating Pressure:
10,000 psi



H-Frame Press Gauges

All standard press models include a gauge and gauge adaptor, matching the press capacity:

Press Capacity (tons)	Gauge Model Number	Adaptor Model Number
10	GF-10P	GA-2
25	GF-20P	GA-2
30	GF-835P	GA-3
50	GF-50P	GA-2
100	GF-871P	GA-3
150	GF-200P	GA-3
200	GF-200P	GA-3

For more information on gauges, please refer to the System Components section.

Page: 113

H-Frame Press Dimensions (in)									Weight (lbs)	Press Model Number
F	G	H	J	K	L	M	N			
24.88	-	-	29.75	4.25	7.44	35.00	52.00	298	IPE-1215	
24.88	-	-	29.75	4.25	7.44	35.00	52.00	160	IPA-1220	
24.88	-	-	29.75	4.25	7.44	35.00	52.00	158	IPH-1240	
24.88	-	-	29.75	4.25	7.44	35.00	52.00	189	IPH-1234	
24.88	-	-	29.75	4.25	7.44	35.00	52.00	163	IPA-1244	
40.50	4.00	13.25	30.00	5.25	10.69	26.50	76.00	605	IPE-2505	
40.50	4.00	13.25	30.00	5.25	10.69	26.50	76.00	697	IPE-2510	
40.50	4.00	13.25	30.00	5.25	10.69	26.50	76.00	610	IPA-2520	
40.50	4.00	13.25	30.00	5.25	10.69	26.50	76.00	620	IPH-2531	
40.50	4.00	13.25	30.00	5.25	10.69	26.50	76.00	684	IPA-3071	
40.50	4.00	13.25	30.00	5.25	10.69	26.50	76.00	722	IPE-3060	
40.50	4.00	13.25	30.00	5.25	10.69	26.50	76.00	664	IPH-3080	
42.75	5.00	8.75	36.00	7.25	14.38	30.75	76.00	1,040	IPE-5010	
42.75	5.00	8.75	36.00	7.25	14.38	30.75	76.00	968	IPA-5021	
42.75	5.00	8.75	36.00	7.25	14.38	30.75	76.00	968	IPH-5030	
42.75	5.00	8.75	36.00	7.25	14.38	30.75	76.00	926	IPH-5031	
42.75	5.00	8.75	36.00	7.25	14.38	30.75	76.00	930	IPE-5005	
42.75	5.00	8.75	36.00	7.25	14.38	30.75	76.00	1,057	IPA-5073	
42.75	5.00	8.75	36.00	7.25	14.38	30.75	76.00	1,051	IPE-5060	
42.75	5.00	8.75	36.00	7.25	14.38	30.75	76.00	1,003	IPH-5080	
51.00	6.75	8.75	36.00	8.75	17.25	33.13	76.00	1,650	IPA-10023	
51.00	6.75	8.75	36.00	8.75	17.25	33.13	76.00	1,722	IPE-10010	
51.00	6.75	8.75	36.00	8.75	17.25	33.13	76.00	1,656	IPH-10030	
51.00	6.75	8.75	36.00	8.75	17.25	33.13	76.00	1,743	IPE-10060	
51.00	6.75	8.75	36.00	8.75	17.25	33.13	76.00	1,665	IPH-10080	
67.17	9.12	3.09	44.00	13.12	21.85	47.75	90.00	3,906	IPE-15065	
67.17	9.12	3.09	44.00	13.12	21.85	47.75	90.00	3,906	IPE-20065	



Ordering Variations

Any variations to a listed part number must be ordered as two separate items. For example, if you need a different voltage electric pump, please order from the modular matrix on page 141 and the electric pump from the modular matrix on page 87 (electric) or page 93 (air).

Any questions should be directed to our Technical Service Department.

Page: 140

▼ Shown: IPR-10075



- Quality welded frame for maximum strength and long life
- Frame rolls easily on four steel roller bearings
- Hydraulic clamp cylinders lock frame into position
- Exclusive “Hydra-Lift™” bolster for effortless adjustment of the vertical daylight
- Standard roller head design allows movement of the cylinder from side to side
- All models in the Quick Selection Chart have been matched to a pump, cylinder, hoses and gauge, offering the complete package
- Roll Frame design features a stationary bed with the ability to support heavy loads

The One and Only



Cylinder Mounting Block

Allows cylinder mounting into a press frame, while also allowing side to side adjustment of cylinder position.

Page: 140



Pump Mounting Bracket

Heavy duty steel brackets to allow conversion to one of the Enerpac Power Sources to power your press.

Page: 140



Hydra-Lift™

Allows easy, effortless daylight adjustment.

Page: 140



Optional V-Blocks

These V-Blocks, 200 ton only, are designed for easy fixturing of round stock and other non-uniform materials. Featuring precise fit into the press bolster.

Page: 140

Press Capacity (tons)	Vertical Daylight A (in)		Horizontal Daylight E (in)	Pump Model Number	Press Model Number	Cylinder, Double-Acting Hydraulic Return				Speed (sec/in)	
	minimum	maximum					Stroke (in)	Model Number	Page:	Rapid Advance	Pressing
50	6.00	37.12	28.75	ZE4420SB-N	85 IPR-5075	●	13.13	RR-5013	33	1.0	11.1
100	6.28	41.28	35.00	ZE5420SG-N	85 IPR-10075	●	13.13	RR-10013	33	1.5	10.3
200	11.00	51.00	48.00	ZE5420SG-N	85 IPR-20075	●	13.00	RR-20013	33	3.1	22.1

Roll Frame Presses

▼ An IPR-20075 Roll Frame Press is used to remove a large shaft from this pillow-block assembly. The Roll Frame design allows this heavy part to be safely loaded with an overhead crane.



IPR Series



Capacity:

50-200 tons

Maximum Daylight and Width:

51.00 & 48.00 inches

Maximum Operating Pressure:

10,000 psi



Roll Frame Press Gauges

All standard press models include a gauge and gauge adaptor, matching the press capacity:

Press Capacity (tons)	Gauge Model Number	Adaptor Model Number
50	GF-50P	GA-2
100	GF-871P	GA-3
200	GF-200P	GA-3

For more information on gauges, please refer to the System Components section.

Page: 113

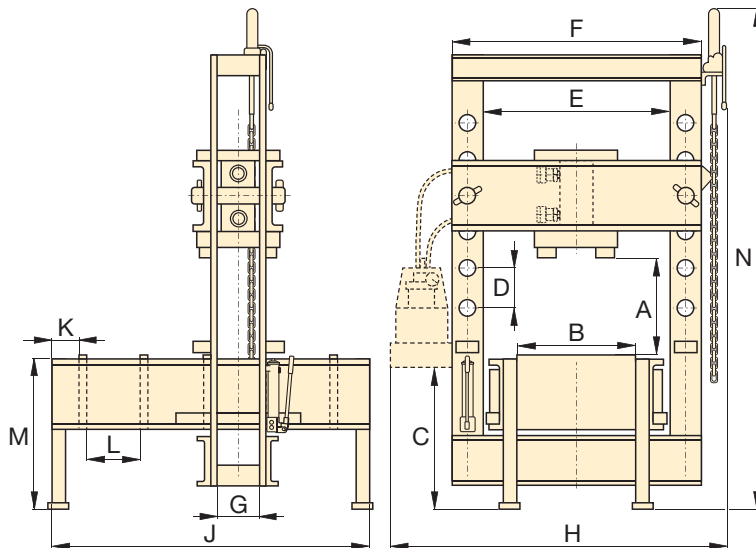

Ordering Variations

Any variations to a listed part number must be ordered as two separate items. For example, if you need a different voltage electric pump, please order from the modular matrix on page 141 and the electric pump from the modular matrix on page 87 (electric) or page 93 (air).

Any questions should be directed to our Technical Service Department.

Page: 141

Roll Frame Press Dimensions (in)											Weight (lbs)	Press Model Number
B	C	D	F	G	H	J	K	L	M	N		
20.71	38.25	10.38	36.75	5.00	55.92	64.00	8.00	10.63	30.00	112.96	1,961	IPR-5075
26.50	38.00	8.75	45.00	5.75	63.19	66.00	8.00	10.63	32.00	118.94	3,849	IPR-10075
38.75	36.75	10.00	64.00	9.12	84.63	86.50	8.00	15.00	36.00	125.96	7,869	IPR-20075

▼ Shown from left to right: A-220, A-330 and A-258



The Standard In Workshop Tools



Push Pin A-183

For applications requiring precision pressing, such as shaft removal and insertion. This attachment fits 10 ton cylinders and requires the use of a threaded adaptor saddle (A-13).



Smooth Saddle A-185

For pressing applications of delicate parts, such as aluminum castings, this saddle decreases surface marks during the pressing application. Requires 10 ton cylinder and threaded adaptor saddle (A-13).

C-Clamp Press

- 5, 10 and 20 ton capacity
- Operational in all positions

Arbor Press

- Foot mounting holes for horizontal or vertical positioning
- Machined work surfaces for easier fixturing
- Slotted back to simplify loading and unloading of longer parts

Bench Frame Press

- Cylinder mounting adaptor allows lateral positioning along rails
- Mounting holes for easy mounting to fixed surface

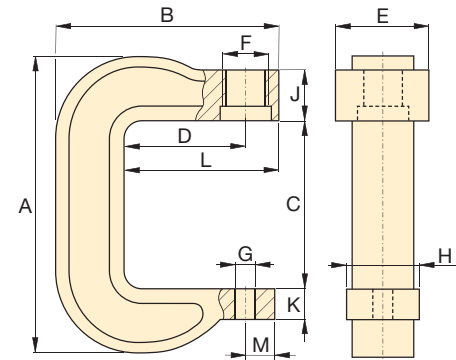

C-Clamp Press A-205, A-210, A-220



◀ A-310 Arbor Press used for compacting powder at 10 tons.

Press Type	Press Capacity (tons)	Maximum Vertical Daylight (in)	Maximum Bed Width (in)	Cylinder Series Number*	Press Model Number	Weight (lbs)
Arbor	10	8.94	5.31	RC-10-x	A-310*	62
	30	10.25	7.00	RC-30-x	A-330*	220
C-Clamp	5	6.50	2.00	RC-5-x	A-205*	14
	10	9.00	3.25	RC-10-x	A-210*	37
	20	11.88	3.75	**	A-220**	83
Bench	10	15.38	15.00	-	A-258*	103
	10	15.38	15.00	RC-1010	IPA-1022***	140
	10	15.38	15.00	RC-1010	IPH-1040***	135

* Requires RC cylinder listed, see page 7 for specifications.

** Requires RC-25 ton cylinder, limited to 20 tons.

*** Complete set includes cylinder and pump.

C-Clamp, Arbor and Bench Frame Presses

▼ A perfect example of the force and versatility of the Enerpac A-220 C-Clamp press.



**A
IP
Series**



Capacity:
5-30 ton

Maximum Daylight and Width:
15.38 and 15.00 inches

Mounting Capabilities:
Fixed or Portable

Maximum Operating Pressure:
10,000 psi

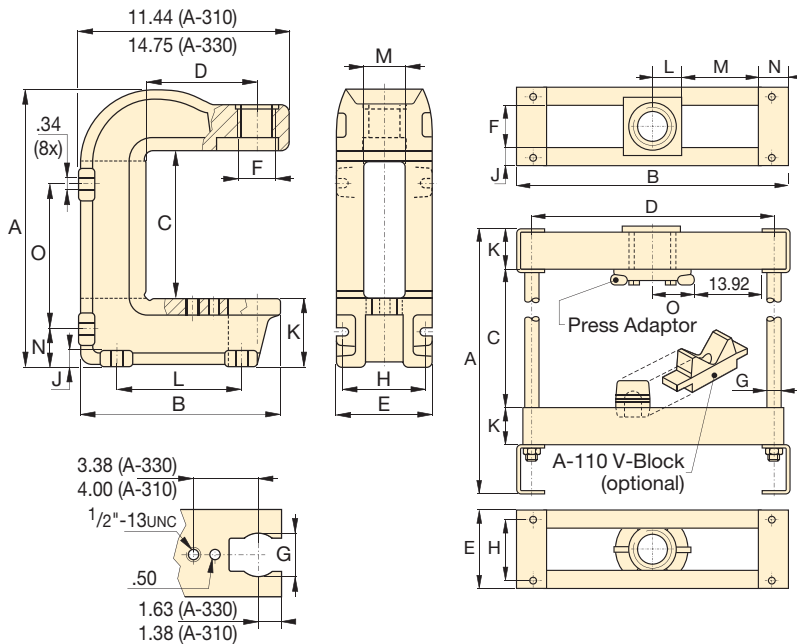

Arbor Press A-310, A-330

Bench Press Frame A-258



For high-cycle production applications, C-Clamp and Arbor presses should be limited in their capacity. Consult Enerpac Technical Services for specific application details.



Enerpac cylinders and power sources for C-Clamp and Arbor presses must be ordered separately.

Press Dimensions (in)															Press Model Number
A	B	C	D	E	F	G	H	J	K	L	M	N	O		
16.31	11.06	8.94	6.00	5.31	2¼-14 UN	2.50	4.81	.75	3.81	6.88	2.56	2.13	8.63	A-310	
21.94	13.88	10.25	6.00	7.00	3⅞-12 UN	2.50	5.50	1.00	6.50	8.00	2.63	3.88	10.88	A-330	
11.44	8.00	6.50	3.75	2.88	1½-16 UN	1.02	2.00	2.50	1.06	4.75	1.00	-	-	A-205	
16.00	11.13	9.00	6.00	3.25	2¼-14 UN	1.02	2.25	2.50	1.69	7.63	1.13	-	-	A-210	
21.25	13.63	11.88	6.00	4.76	3⅞-12 UN	1.02	2.75	2.75	1.88	8.38	1.13	-	-	A-220	
25.63	18.75	16.50	16.00	5.75	3.25	1.00	4.50	1.25	2.75	1.88	5.30	2.20	2.63	A-258	
25.63	18.75	16.50	16.00	5.75	3.25	1.00	4.50	1.25	2.75	1.88	5.30	2.20	2.63	IPA-1022	
25.63	18.75	16.50	16.00	5.75	3.25	1.00	4.50	1.25	2.75	1.88	5.30	2.20	2.63	IPH-1040	

Press Accessories and Press Speed Chart

Description	Frame Capacity	Model Number		Features
Cylinder Mounting Block	10 ton Bench 10 ton H-Frame 25 and 30 ton H-Frame 50 ton H-Frame 100 ton H-Frame 200 ton H-Frame	AD-175 IPK-1012 IPK-3012 PK-501 PK-1002 PK-2002		<ul style="list-style-type: none"> AD-175 converts the Bench press to use an RD-9 ton cylinder All mounting blocks allow horizontal movement of cylinder
V- Blocks	10 ton Bench Press 10 ton H-Frame 25 and 30 ton H-Frame 50 ton H-Frame 100 ton H-Frame 150 & 200 ton H-Frame 200 ton Roll Frame	A-110 A-136 A-130 A-150 A-175 A-200 A-200R		<ul style="list-style-type: none"> Machined from high strength steel for long life A-110 includes one V-block All other model numbers include two V-blocks
Hydra-Lift™	25-100 ton H-Frame 150-200 ton H-Frame 50 and 100 ton Roll Frame 200 ton Roll Frame	IPL-100 IPL-101 IPLR-100 IPLR-200		<ul style="list-style-type: none"> Allows easy, effortless daylight adjustments Includes accessory chain
Pump Mounting Bracket	Hand operated and small Air Pumps; P-80, P-84, P-142, P-392, PA-133, , XA, Turbo II pumps Electric, large Hand Pumps, and ZA4 Air Pumps; ZE Series, P-462, P-464, 10/90 Series Air Pumps	PMB-1 PMB-2		<ul style="list-style-type: none"> Both mounting brackets are pre-drilled to accept a number of different pump models

Cylinder Speed

This chart will help you calculate the time required for an Enerpac cylinder to extend when powered by a 10,000 psi Enerpac hydraulic pump. The Cylinder Speed Chart can also be used to determine the pump type and model best suited for an application when you know the plunger speed required.

Cylinder and Pump Selection Chart

Cylinder Capacity (tons)	Cylinder Load	Hand Operated Pumps				Electric Pumps					Air Pumps			
		Strokes per inch of plunger travel				Seconds per inch of plunger travel					@100 psi air			
		Single Speed	Two-Speed			½ HP Port.	½ HP Subm.	ZE3 Series	ZE4 Series	ZE5 Series	XA	PA-133	PAM 10 Series	ZA4
			P-391	P-392	P-80 P-84									
10	No load	15	4	2	1	.7	.9	.3	.2	.2	1.10	2.70	.21	.16
	Load	15	15	15	8	6.7	6.7	3.4	2.2	1.1	9.00	16.80	14.90	4.50
25	No load	34	8	5	1	1.5	2.1	.7	.5	.4	2.60	6.20	.48	.36
	Load	34	34	34	18	15.5	15.5	7.7	5.2	2.6	20.60	38.60	34.30	10.30
30	No load	43	10	7	1	1.9	2.6	.9	.6	.5	3.20	7.50	.60	.46
	Load	43	43	43	23	19.5	19.5	9.80	6.5	3.3	26.00	48.70	43.30	13.00
50	No load	73	16	11	2	3.3	4.4	1.50	1.0	.8	5.50	13.30	1.00	.80
	Load	73	73	73	38	33.2	33.2	16.6	11.0	5.5	44.20	82.92	73.70	22.10
100	No load	137	30	21	3	6.2	8.3	2.8	1.9	1.5	10.30	24.80	1.90	1.50
	Load	137	137	137	71	61.9	61.9	31.0	20.7	10.3	82.50	154.70	137.50	41.30

Note: Values are approximate. Cylinder speed may vary in actual application.

CUSTOM BUILD YOUR OWN PRESS

If the press that would best fit your application cannot be found in the charts, you can easily build your custom press here. All presses must be ordered with cylinders. The pump is ordered separately.

▼ This is how a press model number is built up



1 Product Type

IP= Industrial Press

2 Frame Type

H = H-Frame
R = Roll Frame ¹⁾

3 Press Capacity

010 = 10 ton
025 = 25 ton
030 = 30 ton
050 = 50 ton
100 = 100 ton
150 = 150 ton
200 = 200 ton

4 Cylinder Type

S = Single-Acting (RC-Series)
D = Double-Acting (RR-Series)

5 Cylinder Stroke (in)

- 10 ton S/A: 06, 08, 10, 12, 14
10 ton D/A: 10, 12
- 25 ton S/A: 06, 08, 10, 12, 14
- 30 ton S/A: 08
30 ton D/A: 08, 14
- 50 ton S/A: 06, 13
50 ton D/A: 06, 13, 20
- 100 ton S/A: 06, 10
100 ton D/A: 06, 13, 18
- 150 ton D/A: 06, 13, 32
- 200 ton D/A: 13, 18, 24

6 Pump Mounting Kit ²⁾

0 = No mounting kit
1 = Hand operated and small air pumps: P-80, P-84, P-141, P-142, P-202, P-391, P-392, PA-133 and all Turbo II Air pumps
2 = Electric, large hand operated and modular air pumps: PUJ-12, PEM-12, ZE3-6 Series P-462, P-464 PAM-10 and -90 Series

¹⁾ Roll Frame Press: 50-, 100- and 200-ton press capacity only. (Assembly required)
²⁾ Includes hoses for press, except for option 0.

Ordering Example

Model number: IPH-050S06-2

IPH-050S06-2 is a 50-ton H-Frame press with a single-acting, 6 inch stroke cylinder (RC-506). It has a pump mounting kit (for an electric Pump or a Modular Air Pump).

See the cylinder and pump selection chart on previous page for selecting the proper pump.

IP Series



Capacity:
10-200 tons

Maximum Daylight and Width:
54.50 & 48.00 inches

Maximum Operating Pressure:
10,000 psi



“No Load” indicates the plunger speed as it extends toward the load (1st stage).

“Load” indicates the plunger speed as the load is applied at a system pressure of 10,000 psi (2nd stage).

Formula $V = A \div Q$

$$V \text{ (sec/in)} = A \text{ (in}^2\text{)} \div Q \text{ (in}^3\text{/min)}$$

V = Cylinder plunger speed in seconds per inch

A = Cylinder effective area in square inches (in²)

Q = Pump oil flow in cubic inches (in³)

Cylinder Plunger Speed (sec/in)	=	Cylinder Effective Area (in ²)	÷	Pump Flow Rate (in ³ /min)	×	$\frac{60 \text{ sec}}{1}$
---------------------------------	---	--	---	---------------------------------------	---	----------------------------

▼ Shown: LH-102 and TM-5 (in middle)



TM, LH Series

Capacity:

2,000 to 200,000 lbs.

Accuracy, % of full scale:

± 2%



TM and LH models are 100% tested to verify accuracy within a ± 2% range.

If your application requires a calibrated tool, it must be submitted for certification testing.

Certification is NOT available from Enerpac.

Tension Meter TM-5

- Accuracy, ± 2% of full scale
- Zinc and bronze plated to resist rust and corrosion
- Dual-range readout in kilograms and pounds
- Cushioned metal case provides safe storage and transport
- Maximum indicating pointer reading for pre-selected forces or to maintain maximum force readings

Load Cells LH Series

- Accuracy, ± 2% of full scale
- Swivel loading pad reduces eccentric loading for improved accuracy
- Maximum indicating pointer reading for pre-selected forces or to maintain maximum force readings
- Dual-range readout in kilograms and pounds

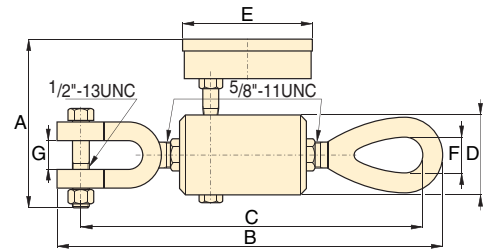

TM-5

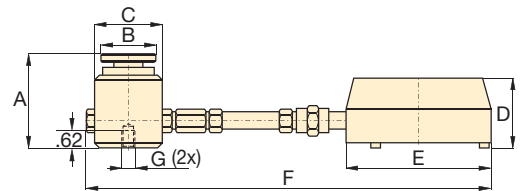

LH-Series

Type	Gauge Capacity		Model Number	Minimum Reading		Gauge Increments		Dimensions (in)						
	(lbs)	(kg)		(lbs)	(kg)	(lbs)	(kg)	A	B	C	D	E	F	G
Direct Mounted	10,000	4500	TM-5	1,000	500	100	100	4.75	9.75	9.29	2.00	4.00	.88	.75
Direct Load Cell Mounted	2,000	900	LH-10	200	100	20	20	3.06	1.75	2.25	2.38	4.00	10.00	1/4"-20, 1.75" BC
	10,000	4500	LH-50	1,000	500	100	100	3.06	1.75	2.25	2.38	4.00	10.00	1/4"-20, 1.75" BC
Remote Mounted with 2 ft. Hose	2,000	900	LH-102	200	100	20	20	3.06	1.75	2.25	2.38	5.81	33.31	1/4"-20, 1.75" BC
	10,000	4500	LH-502	1,000	500	100	100	3.06	1.75	2.25	2.38	5.81	33.10	1/4"-20, 1.75" BC
	20,000	9000	LH-1002	2,000	1000	200	200	3.06	1.75	2.25	2.38	5.81	33.10	1/4"-20, 1.75" BC
Remote Mounted with 6 ft. Hose	50,000	21000	LH-2506	5,000	2500	500	500	4.00	2.75	3.38	2.38	5.81	82.44	3/8"-24, 2.5" BC
	100,000	45000	LH-5006	5,000	2500	1,000	1000	5.22	4.00	5.00	2.38	5.81	84.06	3/8"-24, 3.5" BC
	200,000	90000	LH-10006	20,000	10000	2,500	1000	6.22	5.00	6.25	2.38	5.81	85.31	3/8"-24, 4.0" BC

ENERPAC hydraulics power many custom press applications. By providing reliable and safe high-pressure solutions, Enerpac can solve your custom press application.

Fully Automated PLC-Controlled 1800 Ton High-Accuracy Press

The pressing and heating cycle, during the production of magnetic acceleration coils, required high force and high-accuracy to ensure absolute quality.

Enerpac was consulted to assist in the design of a high accuracy production press. Control of the press force is monitored along with the temperature of the coils during forming by a PLC Control System.



600 Ton High-Accuracy Collar Press

For production of accelerator coils, sheet metal needs to be formed into a specific shape and size. The end product of this forming is a cylindrical collar, which has a very solid structure, specific shape, and a tight tolerance for circularity and concentricity.

The Enerpac team was consulted to accomplish this task using proven high-pressure technology. The 600-ton press consisted of two separate hydraulic systems. The first system featured eight 25-ton cylinders, to position the sheets, while the second system featured eight 75-ton cylinders, to press the sheets into the correct shape.

The results were a hydraulic press system that increased productivity and lowered operating costs.

1000 Ton Cold Forming Press

A manufacturer of diesel engines needed to work-harden aluminum for crankshaft bearing inserts. Working with a customer-hired Systems Integrator, Enerpac provided a 1000-ton cylinder and hydraulic power supply, to the specifications required by the Integrator, to fit into his custom frame and operate with his control system. The Enerpac solution included a 50-series electric pump and 4-way electric solenoid valve.

The final products allowed the end user to quickly, accurately, and safely manufacture crankshaft bearings with an efficient production cycle.



ENERPAC offers a complete line of pullers with the widest range of sizes, capacities and styles.

Whether your application requires mechanical, hydraulic or the patented Posi Lock® system, Enerpac can satisfy your requirements.

Made of high strength steel alloys, you can depend on Enerpac pullers to provide years of trouble-free operation, even in the harshest environments.



Hydraulic Pullers

These hydraulic pullers eliminate time-consuming and unsafe hammering, heating or prying. Damage to parts is minimized through the use of controlled hydraulic power.



Posi Lock® Pullers

The puller that meets the safety challenge. A control cage holds the pulling jaws securely in working position. This patented feature reduces the possibility of the puller jaws slipping off the work surface thereby increasing

productivity and tool life while reducing dangerous situations for the user. The Posi Lock® feature is available in mechanical or hydraulic versions.



WARNING

Do not exceed 50% of the rated puller capacity when using a double crosshead (2 griparms) or when using puller legs in combination with bearing puller attachment.



CAUTION!

Not all puller components and configurations are rated at the set capacity. Please contact Enerpac for specific details.



Always wear Safety Goggles and Gloves while using pullers.

Puller Section Overview

When selecting a puller it is important to consider three basic specifications:

1. Capacity:

The amount of force the puller is capable of producing.

Typically, the capacity required for a job can be determined by using the shaft diameter of the part being pulled.

For manual pullers, the center bolt diameter of the puller should be at least half the diameter of the shaft being pulled from.

For hydraulic pullers, the capacity in tons should be 7 to 10 times the shaft diameter. Use the following chart:











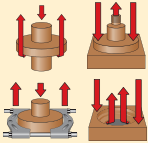

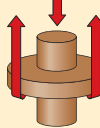

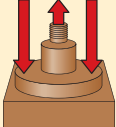

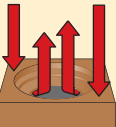
Shaft Diameter	Puller Capacity
0" to 1"	10 ton
1" to 2"	20 ton
2" to 3.5"	30 ton
3.5" to 5.5"	50 ton

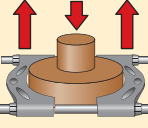
2. Reach:

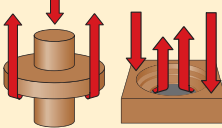
The distance between the bottom of the base and the jaw flats. The puller's reach must equal or exceed the same distance of the part being pulled.

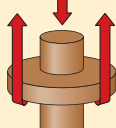
3. Spread:

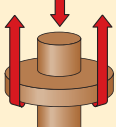
The distance between the jaws. The puller's spread needs to be greater than the width of the part being pulled.

Puller Function	Capacity (tons)	Puller Type	Series		Page
	8-50	Master Puller Sets Max. Reach: 27.56 in. Max. Spread: 43.30 in.	BHP		146 ▶
	8-50	Grip Puller Sets Max. Reach: 27.56 in. Max. Spread: 43.30 in.	BHP		147 ▶
	8-50	Cross-Bearing Puller Sets Max. Reach: 34.00 in. Max. Spread: 22.46 in.	BHP		148 ▶
	8-50	Bearing Cup Pullers Max. Reach: 5.71 in. Max. Spread 14.17 in.	BHP		149 ▶
	8-50	Bearing Pullers Max. Spread: 9.65 in. Max. Width 11.50 in.	BHP		149 ▶
	2-40	Posi Lock® Mechanical Pullers Max. Reach: 14.00 in. Max. Spread: 25.00 in.	EP, EPP, EPPMI, EPX		150 ▶
	10-50	Posi Lock® Hydraulic Pullers Max. Reach: 14.00 in. Max. Spread: 25.00 in.	EPH, EPHR, EPHS		154 ▶
	100	Posi Lock® Hydraulic Pullers Max. Reach: 48.0 in. Max. Spread: 70.0 in.	EPH EPHT		157 ▶

BHP-Series, Master Puller Sets

▼ Shown: Master Puller Set BHP-3751G



BHP Series

Capacity:

8, 20, 30 and 50 tons



CAUTION!

Not all puller components and configurations are rated at the set capacity. Please contact Enerpac for specific details.

- Supplied with a full hydraulic set including pump, hose, cylinder, gauge and gauge adaptor in a storage case
- High quality, forged steel components provide superior reliability and service
- Sets include speed crank and adjusting screw for fast contact to work before hydraulics are applied
- All Master Puller Sets include a Grip Puller, a Cross Bearing Puller, a Bearing Cup Puller and a Bearing Puller which can be ordered separately. See items 10, 20, 30 and 40

▼ Maintenance engineers throughout the industry greatly appreciate Enerpac Master Puller sets.



▼ SELECTION CHART

Master Puller Set Capacity	8 ton	20 ton	30 ton	50 ton	Page Number
Model Number ▶	BHP-1752*	BHP-2751G	BHP-3751G	BHP-5751G	
Included Hydraulics: set weight ▶	82 lbs	198 lbs	380 lbs	657 lbs	
Hand Pump	P-142	P-392	P-392	P-80	59 ▶
Cylinder	RWH-121	RCH-202	RCH-302	RCH-603	26 ▶
Saddle	–	HP-2015	HP-3015	HP-5016	27 ▶
Hose	HB-7206QB	HC-7206	HC-7206	HC-7206	114 ▶
Gauge	GF-120P	GF-813P	GF-813P	GF-813P	121 ▶
Gauge Adaptor	GA-4	GA-3	GA-3	GA-3	127 ▶
Included Pullers:					
10 Grip Puller	BHP-1762	BHP-252	BHP-352	BHP-552	147 ▶
20 Cross Bearing Puller	BHP-1772	BHP-262	BHP-362	BHP-562	148 ▶
30 Bearing Cup Puller	BHP-180	BHP-280	BHP-380	BHP-580	149 ▶
40 Bearing Puller	BHP-181	BHP-282	BHP-382	BHP-582	149 ▶
Storage Case	CM-6	CW-166	CW-550	CW-750	

* Includes FZ-1630 Adaptor.

Grip Puller Sets

▼ Shown: Grip Puller Set BHP-351G



- Precise hydraulic control allows fast, efficient and safe pulling
- High quality, forged steel components provide superior reliability and service
- Available with and without full hydraulic set
- Wooden case supplied standard

▼ SELECTION CHART

Grip Puller Set Capacity		8 ton	20 ton	30 ton	50 ton
Model Number	Included ▶	BHP-152***	BHP-251G	BHP-351G	BHP-551G
Hydraulics:	set weight ▶	48 lbs	123 lbs	200 lbs	353 lbs
Hand Pump		P-142	P-392	P-392	P-80
Cylinder		RWH-121	RCH-202	RCH-302	RCH-603
Saddle		-	HP-2015	HP-3015	HP-5016
Hose		HB-7206QB	HC-7206	HC-7206	HC-7206
Gauge		GF-120P	GF-813P	GF-813P	GF-813P
Gauge Adaptor		GA-4	GA-3	GA-3	GA-3
10 Grip Puller	Model Number ▶	BHP-1762*	BHP-252*	BHP-352*	BHP-552*
Maximum Spread**	2-jaw	9.84	15.75	23.38	35.43
	3-jaw	9.84	19.68	31.50	43.30
Maximum Reach**	2-jaw	9.92	11.81	15.25	27.56
	3-jaw	9.92	11.81	15.25	27.56
Jaw**	Thickness	.59	.79	.98	1.18
Width		.94	1.10	1.50	1.57
Adjusting Screw**	Thread	¾"-16 UNF	1"-8 UNC	1¼"-7 UNC	1½"-5.5 NS
Length		15.75	20.00	24.00	30.00
Wooden Case		CW-166	CW-166	CW-350	CW-750

* Grip Puller model number without hydraulics.

** Dimensions in inches.

*** Includes FZ-1630 Adaptor.

BHP Series

Capacity:

8, 20, 30 and 50 tons

Maximum Reach:

9.92-27.56 inches

Maximum Spread:

9.84-43.30 inches

Maximum Operating Pressure:

10,000 psi



CAUTION!

Not all puller components and configurations are rated at the set capacity. Please contact Enerpac for specific details.

Ordering Example

Model Number BHP-251G:

Includes Grip Puller BHP-252 and a full hydraulic set. (Hand pump, cylinder, saddle, hose, gauge and gauge adaptor.)

Model Number BHP-252:

Includes Grip Puller mechanical parts **only**, for use with your existing hydraulics.

Cross Bearing Puller Sets

▼ Shown: Cross Bearing Puller Set BHP-361G



BHP Series

Capacity:

8, 20, 30 and 50 tons

Maximum Reach:

14.0-34.00 inches

Maximum Spread:

10.50-22.46 inches

Maximum Operating Pressure:

10,000 psi



CAUTION!

Not all puller components and configurations are rated at the set capacity. Please contact Enerpac for specific details.

- Precise hydraulic control allows fast, efficient and safe pulling
- High quality, forged steel components provide superior reliability and service
- The Cross Bearing Puller without hydraulics, Bearing Cup Puller and Bearing Puller may be ordered separately. See items 20, 30 and 40.

▼ SELECTION CHART

Cross Bearing Puller Set Capacity		8 ton	20 ton	30 ton	50 ton
Model Number ►		BHP-162**	BHP-261G	BHP-361G	BHP-561G
Included Hydraulics: set weight ►		57 lbs	137 lbs	267 lbs	408 lbs
Hand Pump		P-142	P-392	P-392	P-80
Cylinder		RWH-121	RCH-202	RCH-302	RCH-603
Saddle		-	HP-2015	HP-3015	HP-5016
Hose		HB-7206QB	HC-7206	HC-7206	HC-7206
Gauge		GF-120P	GF-813P	GF-813P	GF-813P
Gauge Adaptor		GA-4	GA-3	GA-3	GA-3
20	Cross Bearing Puller Model Number ►	BHP-1772	BHP-262	BHP-362	BHP-562
	Spread* Maximum	10.5	13.83	17.9	22.46
	Minimum	4.2	5.5	7.08	8.66
	Reach* Maximum	14.0	22.5	28	34
	Adjusting Screw* Diameter	3/4"-16 UNF	1"-8 UNC	1 1/4"-7 UNC	1 5/8"-5.50 NS
	Length	15.75	20	24	30
	Leg* Length	4.13	9.43	8	24
	Length	14.2	16.52	18	34
	Length	-	22.5	28	-
	Length	-	4.5	-	-
	Upper Leg Ends* Thread	3/4"-16x1.0	3/4"-16x1.0	1"-14x1.38	1 1/4"-12x1.50
	Lower Leg Ends* Thread	5/8"-18x1.0	5/8"-18x1.0	1"-14x1.06	1 1/4"-12x1.50
30	Bearing Cup Puller Model Number ►	BHP-180	BHP-280	BHP-380	BHP-580
40	Bearing Puller Model Number ►	BHP-181	BHP-282	BHP-382	BHP-582
	Wooden Case Model Number ►	CW-166	CW-166	CW-550	CW-750

* Dimensions in inches.

** Includes FZ-1630 Adaptor.

Bearing Cup and Bearing Pullers

▼ Shown: **BHP-380**



Bearing Cup Puller

- Made of high strength steel alloy
- Easily adapted to Cross Bearing Pullers for fast and efficient removal of the most difficult parts
- Adjustable to fit a variety of bearings and seals

BHP Series

Puller Set Capacity:

8, 20, 30 and 50 tons

Maximum Reach:

4.33-5.71 inches

Maximum Spread:

4.33-14.17 inches

Maximum Operating Pressure:

10,000 psi

▼ SELECTION CHART

Puller Set Capacity**		8 ton	20 ton	30 ton	50 ton
30 Bearing Cup Puller					
Model Number ▶		BHP-180	BHP-280	BHP-380	BHP-580
Spread*	Max.	4.33	8.66	14.17	14.17
	Min.	1.06	.98	1.97	1.97
Reach*	Max.	4.33	5.51	5.71	5.71
	Center Screw Thread	3/4"-16 UNF	1"-8 UNC	1 1/4"-7 UNC	1 5/8"-5.50 NS

* Dimensions in inches.

** Puller capacity, not attachment capacity. See Warning box!



WARNING!

Do not exceed 50% of the rated puller capacity when using a double crosshead (2 griparms) or when using puller legs in combination with bearing puller attachment.

▼ Shown: **BHP-382**



Bearing Puller

- Made of high strength steel alloy
- Wedge-shaped edges allow removal of the most hard-to-grip components
- Easily adapted to Cross Bearing Pullers for fast and efficient removal of the most difficult parts

◀ Bearing Cup Puller shown with Crosshead Puller attachment.

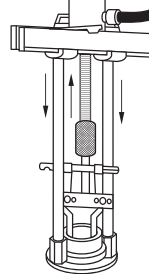

Bearing Puller shown with Crosshead Puller attachment. ▶

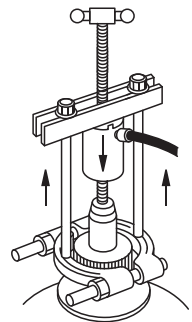

▼ SELECTION CHART

Puller Set Capacity**		8 ton	20 ton	30 ton	50 ton
40 Bearing Puller					
Model Number ▶		BHP-181	BHP-282	BHP-382	BHP-582
Spread*	Max.	4.09	5.12	9.65	9.65
	Min.	.98	.39	.67	.67
Width*		4.96	5.91	11.50	11.50
Thread		5/8"-18 UNF	5/8"-18 UNF	1"-14 UNF	1 1/4"-12 UNF

* Dimensions in inches.

** Puller capacity, not attachment capacity. See Warning!



Bearing Puller

Bearing Puller has wedge shaped edges for placing puller behind hard to reach bearings, gears, etc., where clearance prevents direct application of grip puller arms.

The Bearing Puller can be used with the Cross Bearing Puller or the Grip Puller.

▼ Shown from left to right: EP-206, EP-108



- Patented “Safety Cage” jaw retention system
- Roll threaded shafts for less effort when applying high torque
- Slim tapered jaws for improved gripping in tight spots
- Available in 2 and 3 jaw design and inside and outside pulling configuration
- More efficient pulling, as one man can do the job where manual pullers often require two operators

For Safer and Faster Pulling



Long Jaws

Long Jaws are used to increase the reach and spread of manual pullers. They maintain the same pulling capacity as the standard jaws, but reduce clamping force to 25%.

Page: 153



Shaft Attachments

Shaft protectors and extenders are live centers that fit over the standard puller shaft for tip protection and additional reach.

Page: 153



Application Tip

In determining the correct manual puller capacity for your application, use the following rule:

The center bolt diameter of the puller should be at least 1/2 the diameter of the shaft being pulled on.

Example:

A part being pulled from a shaft with a diameter of 1.5" would require a puller with a center bolt diameter of at least .75".



◀ Positioning an EP-104, 3-jaw puller on the accessory drive of a diesel engine.

Posi Lock® Mechanical Grip Pullers

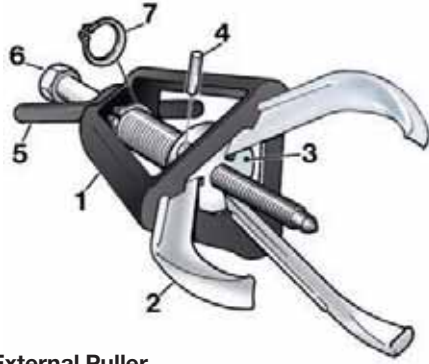

External Puller

- 1 Patented "Safety Cage" guides jaws, holding them securely onto the part.
- 2 Durable forged jaws provide positive grip.
- 3 Jaw head provides pivot and reaction point for jaws.
- 4 Pin, for easy jaw removal and replacement.
- 5 T-handle provides control of the puller jaws.
- 6 Drive bolt with rolled threads for increased force with reduced input torque.
- 7 Snap-ring retains cage to drive bolt and provides quick removal for easy service.

EP EPPMI Series



Capacity:
2-40 tons

Maximum Reach:
4.00-14.00 inches

Maximum Spread:
0.50-25.00 inches

▼ QUICK SELECTION CHART EXTERNAL PULLERS

For full technical information see next page.

Number of Jaws	Maximum Reach (in)	Spread Range (in)	Capacity (tons)	Model Number	Center Bolt Diameter (in)	Weight (lbs)
2	4.00	.5-5	2	EP-204	.56	3
3	4.00	.5-5	5	EP-104	.56	4
2	6.00	.5-7.0	6	EP-206	.66	7
3	6.00	.5-7.0	10	EP-106	.66	8
2	8.00	.75-12	12	EP-208	.79	12
3	8.00	.75-12	17	EP-108	.79	14
2	9.67	1.0-15	14	EP-210	.79	13
3	9.67	1.0-15	20	EP-110	.79	16
2	12.00	2.5-18	25	EP-213	1.17	38
3	12.00	2.5-18	30	EP-113	1.17	44
2	14.00	3.0-25	35	EP-216	1.23	57
3	14.00	3.0-25	40	EP-116	1.23	68



Always wear Safety Goggles and Gloves while using pullers.



Application Tip

Because of the unique Safety Cage design, Posi Lock® pullers will grip on surfaces where normal pullers would slip off; e.g. tapered bearings.

Internal Puller

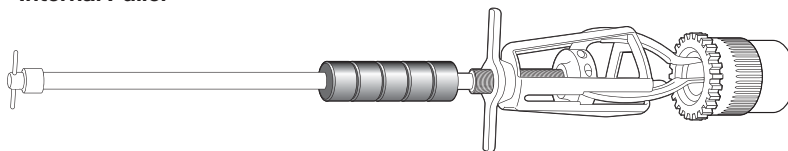

▼ QUICK SELECTION CHART INTERNAL PULLERS

For full technical information see next page.

Number of Jaws	Maximum Reach (in)	Spread Range (in)	Jaw Style	Model Number	Jaw Length (in)	Weight (lbs)
3	5.87	.56-4.00	Standard	EPPMI-6	6.62	8.6
	7.70	1.0-5.25	Long		8.62	8.6

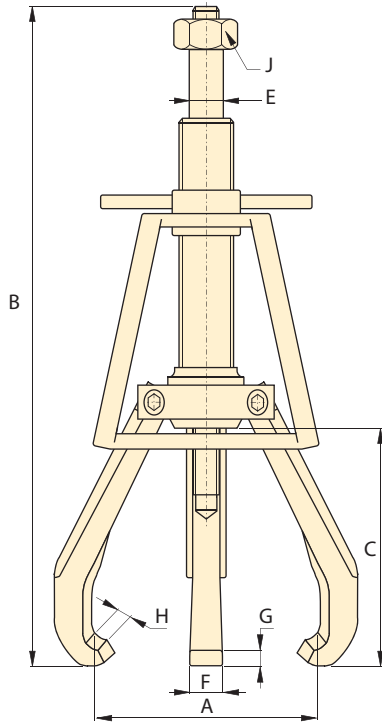

**2- and 3-Jaw External Puller
EP-Series**

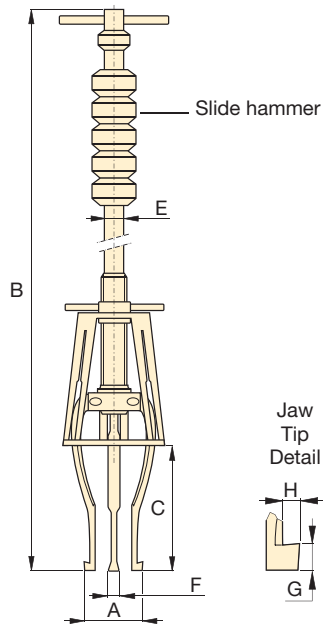

Internal Puller EPPMI-Series



▲ EP-204 2-jaw puller positioned to pull a water pump drive pulley.

▼ SELECTION CHART EXTERNAL PULLERS

Number of Jaws	Maximum Reach (in)	Spread Range (in)	Capacity (tons)	Model Number	Center Bolt Diameter (in)	Maximum Torque (ft.lb)
2	4.00	.5-5.0	2	EP-204	.56	20
3	4.00	.5-5.0	5	EP-104	.56	40
2	6.00	.5-7.0	6	EP-206	.66	75
3	6.00	.5-7.0	10	EP-106	.66	130
2	8.00	.75-12.0	12	EP-208	.79	150
3	8.00	.75-12.0	17	EP-108	.79	220
2	9.67	1.0-15.0	14	EP-210	.79	175
3	9.67	1.0-15.0	20	EP-110	.79	275
2	12.00	2.5-18.0	25	EP-213	1.17	475
3	12.00	2.5-18.0	30	EP-113	1.17	600
2	14.00	3.0-25.0	35	EP-216	1.23	800
3	14.00	3.0-25.0	40	EP-116	1.23	850

▼ SELECTION CHART INTERNAL PULLERS

Number of Jaws	Maximum Reach (in)	Spread Range (in)	Jaw Style	Model Number	Jaw Length (in)	Slide-hammer Weight (lbs)
3	5.87	.56-4.00	Standard	EPPMI-6	6.62	2.5
	7.70	1.00-5.25	Long		8.62	2.5

Posi Lock® Mechanical Grip Pullers



Shaft Protectors and Extenders

Shaft Protectors and Extenders are live centers that fit over the puller end for tip protection and added reach.



Long Jaws

Long jaws are used for added reach and spread. They have the same capacity as standard jaws, but reduce the clamping force to 25%.

EP EPPMI Series



Capacity:

2-40 tons

Maximum Reach:

4.00-14.00 inches

Maximum Spread:

0.50-25.00 inches

Length (in)	Diameter (in)	Increases Center Bolt Length (in)	Order: Model Number
1.00	0.75	0.38	EPP-4
1.97	0.75	1.50	EPX-4
1.22	0.87	0.50	EPP-6
1.97	0.87	1.50	EPX-6
1.22	1.00	0.50	EPP-10
1.97	1.00	1.50	EPX-10
2.00	1.38	0.83	EPP-1316

Spread (in)	Reach (in)	Order: Model Number
1.5-15	9.67	EP-11054
1.5-22	15.78	EP-11054L
1.5-30	20	EP-11354L
1.0-5.26	8.62	EP-10554L*

Note: See the chart below to reference matching pullers for these accessories.

* EPPMI-6 only

Dimensions									Model Number	▼ Optional Accessories		
Spread Range A	Overall Length B	Maximum Reach C	Center Bolt Diameter E	Jaw Width F	Tip Clearance G	Tip Depth H	Hex Socket Size J	Shaft Protectors		Extenders	Long Jaws	
.5-5.0	9.68-12.75	4.00	.56	.54	.16	.18	7/8	EP-204	EPP-4	EPX-4	-	
.5-5.0	9.68-12.75	4.00	.56	.54	.16	.18	7/8	EP-104	EPP-4	EPX-4	-	
.5-7.0	12.75-18.75	6.00	.66	.75	.32	.24	1 1/16	EP-206	EPP-6	EPX-6	-	
.5-7.0	12.75-18.75	6.00	.66	.75	.32	.24	1 1/16	EP-106	EPP-6	EPX-6	-	
.75-12.0	16.25-24.25	8.00	.79	.77	.25	.36	1 1/4	EP-208	EPP-10	EPX-10	EP-11054	
.75-12.0	16.25-24.25	8.00	.79	.77	.25	.36	1 1/4	EP-108	EPP-10	EPX-10	EP-11054	
1.0-15.0	19.25-29.00	9.67	.79	.77	.25	.36	1 1/4	EP-210	EPP-10	EPX-10	EP-11054L	
1.0-15.0	19.25-29.00	9.67	.79	.77	.25	.36	1 1/4	EP-110	EPP-10	EPX-10	EP-11054L	
2.5-18.0	26.00-38.00	12.00	1.17	1.25	.50	.38	1 11/16	EP-213	EPP-1316	-	EP-11354L	
2.5-18.0	26.00-38.00	12.00	1.17	1.25	.50	.38	1 11/16	EP-113	EPP-1316	-	EP-11354L	
3.0-25.0	31.50-45.50	14.00	1.23	1.44	.53	.46	1 13/16	EP-216	EPP-1316	-	-	
3.0-25.0	31.50-45.50	14.00	1.23	1.44	.53	.46	1 13/16	EP-116	EPP-1316	-	-	

Note: Overall length (B) is dependent on position of center bolt.

Dimensions (in)							Model Number
Spread min. - max. A	Overall Length B	Maximum Reach C	Slide Rod Diameter E	Jaw Width F	Tip Clearance G	Tip Depth H	
.56-4.00	29.00	5.87	.52	.33	.12	.06	EPPMI-6
1.00-5.25	31.00	7.70	.52	.33	.30	.18	

▼ Shown: **EPHR-110**



- Patented “Safety Cage” jaw retention system
- High force hydraulic system for effortless pulling of large components
- Slim tapered jaws for better gripping in tight spots
- Available in 2 and 3 jaw design
- More efficient pulling, as one man can do the job where normal pullers often require two operators

High-Tech Pulling



Transport and Store

Conveniently store and transport hydraulic pullers and accessories. Order the **EPT-2550** Storage Cart and make your job easier to do!



Long Jaws

Used to increase the reach and spread of pullers. They maintain the same pulling capacity as the standard jaws, but reduce clamping force to 25%.

Page: 156



Application Tip

Because of the unique safety cage design, Posi Lock® pullers will grip on surfaces where normal pullers would slip off; e.g. tapered bearings.



◀ An EPHR-116, 50-ton hydraulic Posi Lock® puller easily removes the main drive gear from this metal forming brake press.

Basic Pullers only, cylinder not included.

Number of Jaws	Max. Spread (in)	Capacity (ton)	Model Number*
2	12.00	10	EPH-208
3	12.00		EPH-108
2	15.00	15	EPH-210
3	15.00		EPH-110
2	18.00	25	EPH-213
3	18.00		EPH-113
2	25.00	50	EPH-216
3	25.00		EPH-116

*Cylinder is not included.

Posi Lock® Hydraulic Grip Pullers

▼ SETS SELECTION CHART

Style	Capacity (ton)	Basic Puller	Cylinder	Stroke (in)	Pump Set	Set Model Number	Weight (lbs)
2 Jaw Puller	10	EPH-208	RC-106	6	-	EPHR208	24
	10	EPH-208	RC-106	6	EP-1	EPHS208	60
	15	EPH-210	RC-1510	10	-	EPHR210	49
	15	EPH-210	RC-1510	10	EP-1	EPHS210	85
	25	EPH-213	RC-2514	14.25	-	EPHR213	98
	25	EPH-213	RC-2514	14.25	EP-1	EPHS213	118
3 Jaw Puller	10	EPH-108	RC-106	6	-	EPHR108	26
	10	EPH-108	RC-106	6	EP-1	EPHS108	62
	15	EPH-110	RC-1510	10	-	EPHR110	52
	15	EPH-110	RC-1510	10	EP-1	EPHS110	88
	25	EPH-113	RC-2514	14.25	-	EPHR113	106
	25	EPH-113	RC-2514	14.25	EP-1	EPHS113	126
	50	EPH-116	RC-5013	13.25	-	EPHR116	202
	50	EPH-116	RC-5013	13.25	EP-2	EPHS116	222

EPH Series



Capacity:

10-50 tons

Maximum Reach:

8.0-14.0 inches

Maximum Spread:

0.75-25.0 inches

Maximum Operating Pressure:

10,000 psi

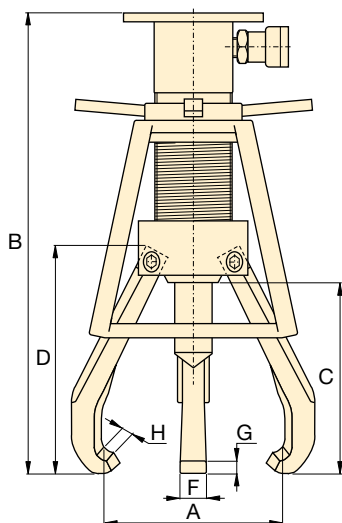



Pump Sets

All Posi Lock Hydraulic Puller Sets that include 115 VAC pumps will feature the following components:

	EP-1 Pump Set
Pump	PUJ-1200B
Hose	HC-9210
Gauge	G-2535L

Components for 230 VAC pumps are available on request.

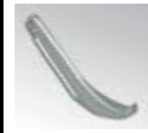

▼ *Optional Accessory

Dimensions (in)							Weight (lbs)	Model Number	 Ram Point Sets	 Lift Plates	 *Long Jaws
Spread Range	Overall Length	Reach (max.)	Jaw Length	Jaw Width	Tip Clearance	Tip Depth					
A	B	C	D	F	G	H					
.75-12.0	19.61	8.00	9.34	.88	.29	.27	14	EPH-208	EPH-155	EPH-11052	EP-11054
.75-12.0	19.61	8.00	9.34	.88	.29	.27	16	EPH-108	EPH-155	EPH-11052	EP-11054
1.0-15.0	26.19	10.00	10.64	1.00	.441	.36	22	EPH-210	EPH-155	EPH-11052	EPH-11054L
1.0-15.0	26.19	10.00	10.64	1.00	.441	.36	25	EPH-110	EPH-155	EPH-11052	EPH-11054L
2.5-18.0	33.31	12.00	13.72	1.25	.508	.38	47	EPH-213	EPH-257	EPH-11352	EP-11354L
2.5-18.0	33.31	12.00	13.72	1.25	.508	.38	55	EPH-113	EPH-257	EPH-11352	EP-11354L
3.0-25.0	36.19	14.00	16.29	1.44	.598	.46	90	EPH-216	EPH-508	-	-
3.0-25.0	36.19	14.00	16.29	1.44	.598	.46	100	EPH-116	EPH-508	-	-

For full details on puller accessories see page 156.

* Long Jaws are available as optional accessories.

▼ RAM POINT SETS SELECTION CHART

Fits Model Number	EPH-208 EPH-210	EPH-108 EPH-110	EPH-213 EPH-113	EPH-216 EPH-116
				
Set Number	EPH-155		EPH-257	
Set Includes	Dia. x Length (in)		Dia. x Length (in)	
Flat Ram Point	1 x 1		1.5 x 2.25	
	1 x 3		2 x 2.25	
	-		2 x 4	
Tapered Ram Point	1 x 1.5		1.5 x 2.5	
	1 x 3.5		2 x 2.5	
	-		2 x 4.5	
Ram Point Adaptor	-		-	
			2.75 x 2.25	



Always wear Safety Goggles and Gloves while using pullers.

▼ LIFT PLATE SELECTION CHART

Fits Puller Set Model Number	Model Number *	Thickness (in)	Diameter (in)
EPH-208	EPH-11052	.25	6
EPH-108	EPH-11052	.25	6
EPH-210	EPH-11052	.25	6
EPH-110	EPH-11052	.25	6
EPH-213	EPH-11352	.38	8
EPH-113	EPH-11352	.38	8
EPH-216	EPH-11652	.38	10
EPH-116	EPH-11652	.38	10



* Mounting screws included. Lifting plates are standard included with EPH-Series Pullers.



▲ EPHR-116 used to remove electric motor pulleys. Puller is positioned using the Lift Plate.

▼ LONG JAW SELECTION CHART

Model Number	Fits Puller Set Model Number	No. of Jaws Required	Spread Dimensions (in)	Reach (in)	Weight (each) (lbs)
EP-11054	EPH-208	2	2.25 - 15.0	9.7	2.5
	EPH-108	3			
EPH-11054L	EPH-210	2	1.5 - 22.0	15.8	5.5
	EPH-110	3			
EPH-11354L	EPH-213	2	1.5 - 30.0	20.0	10.5
	EPH-113	3			



◀ **EPH-11054L**
Long Jaws are used for added reach and spread. They have the same load capacity as standard jaws with 25% of the clamping force.

Posi Lock® 100 Ton Hydraulic Grip Pullers

▼ EPH-1003



EPH Series

Capacity:

100 tons

Maximum Reach:

48 inches

Maximum Spread:

70 inches

Maximum Operating Pressure:

10,000 psi



Pushing Adaptors

All Posi Lock 100 Ton Hydraulic Pullers include (3) pushing adaptors.

Diameter (in)	Overall Length (in)	Model Number
3.5	29	EPHT-1162
3.5	19	EPHT-1163
3.5	9	EPHT-1164

- Roller cart with power lift
- Adjustable jaw tips
- Puller easily detaches from cart
- Self-contained unit
- Puller height range 26.5" to 66.5"



◀ The EPH-1002 quickly and easily removes this drive coupler from its shaft.

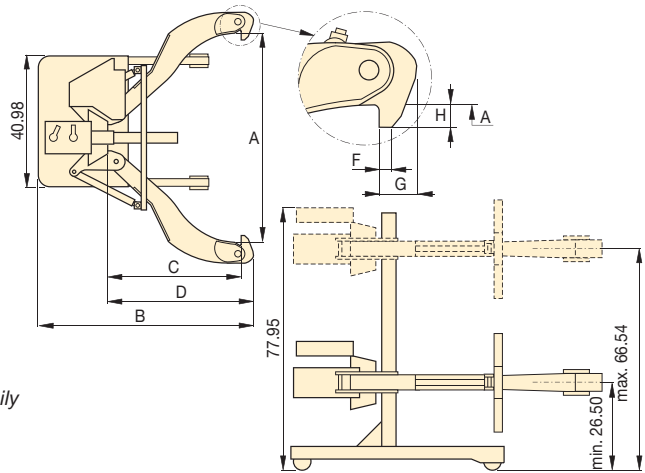

Number of Jaws	Max. Spread (in)	Capacity (tons)	Model Number	Dimensions (in)							Weight (lbs)
				Spread Range (A)	Overall Length (B)	Reach (max.) (C)	Jaw Length (D)	Jaw Width (F)	Tip Clearance (G)	Tip Depth (H)	
2	70.00	100	EPH-1002	7.5-70.0	77.00	48.00	53.00	1.25	3.5	3.5	1700
3	70.00		EPH-1003	7.5-70.0	77.00	48.00	53.00	1.25	3.5	3.5	1950

ENERPAC offers an extensive range of dedicated tools for a variety of specific and flexible applications. Whatever your requirement... cutting, punching, spreading or bending... you can be sure that Enerpac has the correct tool to do your job safely and efficiently.

Featuring maintenance sets, machine lifts and load skates, as well as hole punches, pipe benders and cable cutters, Enerpac has the tools to ensure that even your most demanding applications can be undertaken with the highest degree of safety and accuracy.

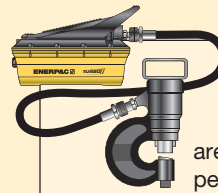

Pump and Tool Sets

Selected hydraulic tools in this section are available in sets, for a perfect tool-pump match.



Hydraulic System Set-up

Check out our "Yellow Pages" section for help on system set-ups and valving configurations.

Page: 246







Bolting Tools

More Enerpac Tools can be found in the Bolting Tools section of this catalog.

Page: 179



Tool Section Overview

Capacity (tons)	Tool Type and Functions	Series		Page
2.5-12.5	Maintenance Sets	MS		160 ▶
35-50	Punches	SP		164 ▶
16	Lifting Wedge	LW		168 ▶
20	Hydraulic Machine Lifts	SOH		169 ▶
1-80	Load Skates	ELP ER ES		170 ▶
.67-16 (ft ³)	Storage Cases	CM		172 ▶
.75-1.00	Hydraulic Wedgie Spread Cylinders	A, WR		173 ▶
3-20	Hydraulic Cutterheads	WHC WHR		174 ▶
3-20	Self-Contained Hydraulic Cutters	WMC		175 ▶
Nominal Bore 1/2" - 4 inches	Pipe Benders	STB		176 ▶

▼ Shown: **MS2-10**



- All sets include Enerpac pump, hose, cylinder and gauge
- Lock-on or threaded connectors
- Complete set for almost every maintenance application

The Universal Hydraulic Tool Box



Maintenance Sets

Enerpac Maintenance sets are a complete assortment of accessories matched to hydraulic powered tools. Using these sets allows you to quickly configure a unique tool to meet your most difficult jobs.

Built around the Enerpac lightweight hand pump, hose and cylinder, these sets enable you to push, pull, lift, press, straighten, spread and clamp with forces up to 12.5 tons.



More Information



For detailed information on all included attachments, see the following pages.

Page: 162



◀ Clamping a workpiece is just one of the many applications for the Enerpac maintenance sets.

▼ QUICK SELECTION CHART

Capacity using attachments* (tons)	Set Model Number						Number of Attachment Components	Weight (lbs)
2.5	MS2-4	P-142	HC-7206	RC-55	GP-10S	GA-4	34	59
2.5	MSFP-5**	P-142	HC-7206	RC-55	G2535L	GA-3	24	44
5	MSFP-10	P-392	HC-7206	RC-106	G2535L	GA-3	22	105
5	MS2-10	P-392	HC-7206	RC-106	GP-10S	GA-2	35	140
12.5	MS2-20	P-392	HC-7206	RC-256	GP-10S	GA-2	13	210
5-12.5	MS2-1020	P-392	HC-7206	RC-102, -106, -256	GP-10S	GA-2	53	350

* If no attachments are being used, capacity is double these values. Maximum operating pressure is then 10,000 psi.

** This set also includes the FZ-1055 Adaptor.

MS-Series, Maintenance Sets



CAUTION!

When cylinders are used with maintenance set attachments or components, the maximum system pressure must be limited to half the rated pressure (5,000 psi).



WARNING!

Only use attachments provided with set. Non-Enerpac attachments and longer extension tubes will reduce column strength, potentially creating unsafe conditions.

MS Series



Capacity (using attachments):

2.5-12.5 tons

Max. Operating Pressure (using attachments):

5,000 psi

▼ APPLICATION EXAMPLES



MS-Series, Maintenance Sets



CAUTION! When cylinders are used with maintenance set attachments or components, the maximum system pressure must be limited to half the rated pressure (5,000 psi).

Note: All dimensions in inches.

Set Model No.	MS2-4	MSFP-5	MSFP-10	MS2-10	MS2-20	MS2-1020
Base/Collar/ Plunger Attachments	Capacity Using Attachments					
	2.5 tons	2.5 tons	5.0 tons	5.0 tons	12.5 tons	5-12.5 tons
Cylinder Series	RC-5	RC-5	RC-10	RC-10	RC-25	RC-10, RC-25
1	A-23	A-23	A-13	A-13	A-28	A-13 / A-28
2	A-25	A-25	A-21	A-21	A-27	A-21 / A-27
3	A-1034	A-1034	A-20	A-20	A-595	A-20 / A-595
4	MZ-4010	MZ-4010	A-14	A-14	A-243	A-14 / A-243
5	A-545	A-545	A-10	A-10	—	A-10(2x)
6	—	—	—	A-8	—	A-8
7	A-530	A-530	A-6	A-6	—	A-6
8	MZ-4011	—	—	A-192	—	A-192
9	—	—	—	A-305	—	A-305
10	A-531	A-531	A-18	A-18	—	A-18
11	—	—	—	A-185	—	A-185
12	A-532	A-532	A-15	A-15	—	A-15
13	—	—	—	—	A-607	A-607
14	A-629	A-629	A-129	A-129	—	A-129
15	A-539	A-539	A-128	A-128	—	A-128
Chains and Attach- ments for Pulling	2.5 tons	2.5 tons	5.0 tons	5.0 tons	12.5 tons	5-12.5 tons
Cylinder Series	RC-5	RC-5	RC-10	RC-10	RC-25	RC-10, RC-25
16	A-558	—	—	A-132	A-238	A-132, -238
17	—	—	—	A-5 (2x)	—	A-5(2x)
18	A-557(2x)	—	—	A-141(2x)	A-218(2x)	A-141(2x) / A-218(2x)
19	A-544	—	—	A-19(2x)	A-242(2x)	A-19(2x) and A-242(2x)
20	WR-5	WR-5	WR-5	A-92	—	A-92
21	MZ-4013(4x)	MZ-4013(4x)	A-16(4x)	A-16(4x)	—	A-16(4x)
22	MZ-4007(3x)	MZ-4007(3x)	MZ-1050(3x)	MZ-1050(2x)	—	MZ-1050(3x)
23	MZ-4008(2x)	—	—	MZ-1051	—	MZ-1051(2x)
24	MZ-4009	MZ-4009	MZ-1052	MZ-1052	—	MZ-1052
25	—	—	—	A-285	—	A-285
26	A-650	—	—	—	—	—
Length: 3"	MZ-4002	MZ-4002	—	—	—	—
	5"	MZ-4003	MZ-4003	MZ-1002	MZ-1002	—
	10"	MZ-4004	MZ-4004	MZ-1003	MZ-1003	A-239
						and A-239
	18"	MZ-4005(2x)	MZ-4005	MZ-1004	MZ-1004	A-240
						and A-240
	23"	MZ-4006(1x)	MZ-4006	—	—	—
	30"	—	—	MZ-1005	MZ-1005	A-241
						and A-241
Case	CM-6	CM-6	CW-166	CW-166	CW-166	CW-350
Weight	59 lbs.	44 lbs.	105 lbs.	140 lbs.	210 lbs.	350 lbs.

Base/Collar/Plunger Attachments

1 Threaded Adaptor

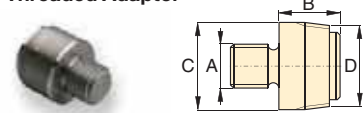

Tons	Model No.	A	B	C	D
2.5	A-23	3/4"-16 UN	1.13	1.05	3/4"-14 NPT
5.0	A-13	1"-8 UN	1.25	2.19	1 1/4"-11 1/2 NPT
12.5	A-28	1 1/2"-16 UN	1.87	2.75	2"-11 1/2 NPT

2 Base Attachment



Tons	Model No.	A	B	C	D
2.5	A-25	3/4"-14 NPT	2.00	.50	1.75
5.0	A-21	1 1/4"-11 1/2 NPT	2.25	.50	2.56
12.5	A-27	2"-11 1/2 NPT	2.50	.50	3.88

3 Collar Toe

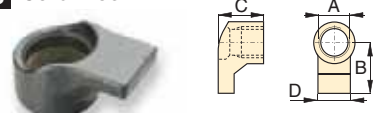

Tons	Model No.	A	B	C	D
2.5	A-1034	1 1/2"-16	2.13	1.97	1.25
5.0	A-20	2 1/4"-14	3.16	2.25	2.25
12.5	A-595	3 3/8"-12	4.06	2.03	3.18

4 Flat Base



Tons	Model No.	A	B	C	D
2.5	MZ-4010	3/4"-14 NPT	4.50	1.25	2.50
5.0	A-14	1 1/4"-11 1/2 NPT	6.50	1.38	3.50
12.5	A-243*	2"-11 1/2 NPT	6.50	2.31	6.50

* A-243 is a round base model

5 Threaded Connector

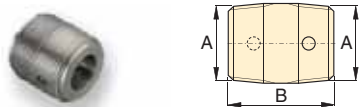

Tons	Model No.	A	B
2.5	A-545	3/4"-14 NPT	1.38
5.0	A-10	1 1/4"-11 1/2 NPT	1.63

6 Lock-on Clamp To



Tons	Model No.	A	B	C	D
5.0	A-8	1.69	4.13	2.00	2.25

MS-Series, Maintenance Sets

7 Threaded Plunger Toe

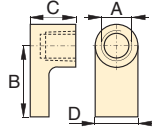

Tons	Model No.	A	B	C	D
2.5	A-530	3/4"-14 NPT	2.25	1.00	1.33
5.0	A-6	1 1/4"-11 1/2 NPT	3.12	1.25	2.25

8 Collar Clamp Head

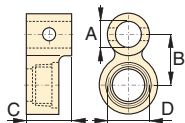

Tons	Model No.	A	B	C	D
2.5	MZ-4011	3/4"-14 NPT	1.95	3.00	1 1/2-16 UN
5.0	A-192	1.69	2.50	2.00	2 1/4-14 UN

9 Spreader Toe

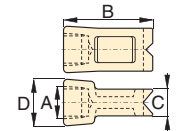

Tons	Model No.	A	B	C	D
5.0	A-305	1 1/4"-11 1/2 NPT	4.50	1.00	2.00

10 Serrated Saddle

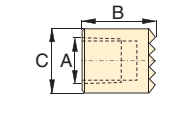

Tons	Model No.	A	B	C
2.5	A-531	3/4"-14 NPT	1.25	1.09
5.0	A-18	1 1/4"-11 1/2 NPT	2.00	1.50

11 Smooth Saddle

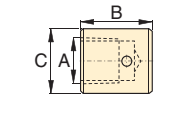

Tons	Model No.	A	B	C
5.0	A-185	1 1/4"-11 1/2 NPT	1.50	2.00

12 90° V-Base

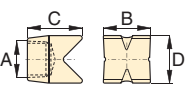

Tons	Model No.	A	B	C	D
2.5	A-532	3/4"-14 NPT	1.50	1.88	1.00
5.0	A-15	1 1/4"-11 1/2 NPT	2.13	2.25	2.13

13 Plunger Base

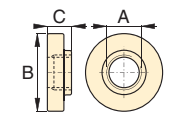

Tons	Model No.	A	B	C
12.5	A-607	2"-11 1/2 NPT	6.56	1.53

14 Wedge Head

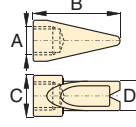

Tons	Model No.	A	B	C	D
2.5	A-629	3/4"-14 NPT	2.75	1.31	1.13
5.0	A-129	1 1/4"-11 1/2 NPT	4.00	2.00	1.75

15 Rubber Flex-Head

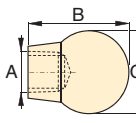

Tons	Model No.	A	B	C
2.5	A-539	3/4"-14 NPT	1.75	2.75
5.0	A-128	1 1/4"-11 1/2 NPT	3.40	3.40

Chains and Attachments for Pulling

16 Single Chain Plate

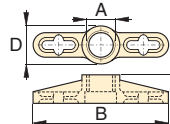

Tons	Model No.	A	B	C	D
2.5	A-558	1 1/2"-16 UN	7.75	1.56	1.75
5.0	A-132	2 1/4"-14 UN	12.12	2.50	3.12
12.5	A-238	3 5/16"-12 UN	17.75	4.03	4.93

17 Double Chain Plate

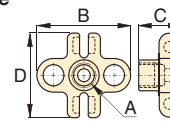

Tons	Model No.	A	B	C	D
5.0	A-5	1 1/4"-11 1/2 NPT	6.18	2.00	4.96

18 Chain with Hook



Tons	Model No.	Chain Length
2.5	A-557	5 feet
5.0	A-141	6 feet
12.5	A-218	8 feet

Tubes, Connectors and Adaptors

19 Pipe Coupling

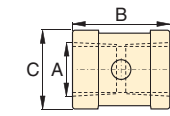

Tons	Model No.	A	B	C
2.5	A-544	3/4"-14 NPT	1.69	1.31
5.0	A-19	1 1/4"-11 1/2 NPT	1.94	2.15
12.5	A-242	2"-11 1/2 NPT	3.50	3.25

20 Spreader

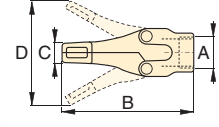

Tons	Model No.	A	B	C	D
1.0	WR-5	—	8.78	.50	3.70
1.0	A-92	2 1/4"-14 UN	9.63	1.38	6.25

21 Lock Pin

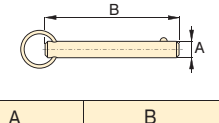
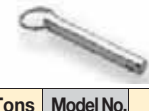

Tons	Model No.	A	B
2.5	MZ-4013	.25	2.38
5.0	A-16	.44	3.25

22 Lock-on Connector

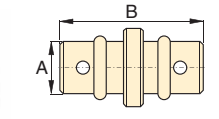

Tons	Model No.	A	B
2.5	MZ-4007	.75	3.12
5.0	MZ-1050	1.31	5.00

23 Male Lock-on Adaptor

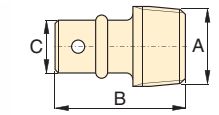

Tons	Model No.	A	B	C
2.5	MZ-4008	3/4"-14 NPT	2.38	.75
5.0	MZ-1051	1 1/4"-11 1/2 NPT	3.56	1.31

24 Female Lock-on Adaptor

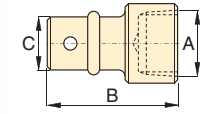

Tons	Model No.	A	B	C
2.5	MZ-4009	3/4"-14 NPT	2.56	.75
5.0	MZ-1052	1 1/4"-11 1/2 NPT	3.81	1.31

25 Adjustable Extension

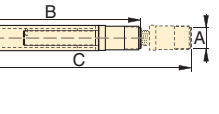

Tons	Model No.	A	B	C	D
5.0	A-285	1 1/4"-11 1/2 NPT	13.20	17.37	1.30

26 Slip-Lock Extension

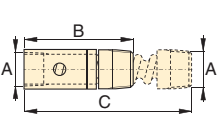

Tons	Model No.	A	B	C
2.5	A-650	3/4"-14 NPT	7.88	14.37

▼ Shown: SP-35S



- .50" thick mild steel maximum capacity
- Round, oblong and square punches and dies are available to solve your punching applications
- Long life Enerpac single-acting, spring return design
- Durable steel case keeps tools and dies together and provides for easy carrying and storage
- CR-400 female coupler included

Much Faster than Drilling...



Tool Kit SPK-10

Included with all 35 ton punches, this tool kit is used to remove and install the punch into the head.

Can be ordered as a replacement under model number **SPK-10**.



Ordering Information

The 35-ton hydraulic punch may be ordered by itself or as a set, including an electric, air or hand pump.

Please refer to the Quick Selection Chart information on next page.

A punch and die may also be ordered as a matched set.

▼ STANDARD PUNCH AND DIE SETS SELECTION CHART

Hole Shape	Imperial*		Metric*	
	Hole Size (in)	Bolt Size (in)	Hole Size (mm)	Bolt Size (mm)
●	.31	1/4	7,9	–
●	.38	5/16	9,5	M8
●	.44	3/8	11,1	M10
●	.53	7/16	13,5	M12
●	.56	1/2	14,3	–
●	.69	5/8	17,5	M16
●	.78	–	19,8	M18
●	.81	3/4	20,6	–
■	.31	1/4	7,9	–
■	.38	5/16	9,5	M8
■	.44	3/8	11,1	M10
■	.50	7/16	12,7	M12
●	.31 x .75	1/4	7,9 x 19	–
●	.38 x .75	5/16	9,5 x 19	M8
●	.44 x .75	3/8	11,1 x 19	M10
●	.50 x .75	7/16	12,7 x 19	M12



◀ This PUD-1100B is shown with the 35 ton punch and optional gauge.

* Material thickness should **not** exceed hole diameter.

Single-Acting, Spring Return Hydraulic Punch

▼ QUICK SELECTION CHART

* 	Included				Model Number	Weight (lbs)
	Punch and Die Set	Pump	Pump Type	Hose		
SP-35	-	-	-	-	SP-35	35
SP-35	Standard**	-	-	-	SP-35S	40
SP-35	Standard**	PUD-1100B	E	HC-7206	SP-35SP	70
SP-35	Metric***	-	-	-	MSP-351	40
SP-35	Standard**	P-392	H	HC-7206	STP-35H	55
SP-35	Standard**	PATG-1102N	A	HC-7206	STP-35A	63

* Punch oil capacity: 4.58 in³

Includes the following punch and die sets:

** SPD-438, SPD-688, SPD-563 and SPD-813

*** SPD-375, SPD-531, SPD-438 and SPD-688

◆ E = Electric

H = Hand

A = Air operated

SP Series



Capacity:

35 tons

Hole Sizes:

0.31-0.81 inch

Maximum Operating Pressure:

10,000 psi

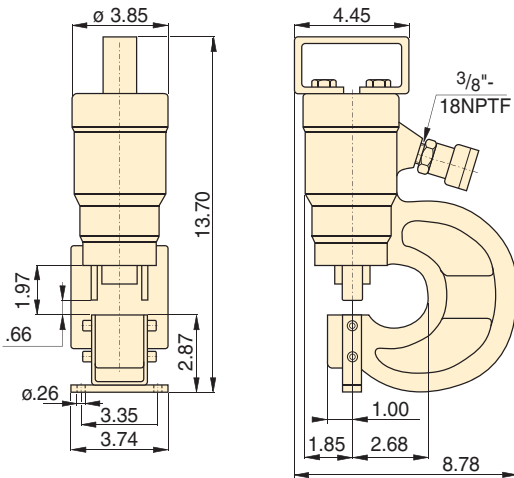

CAUTION!

Chart below is for reference only! Maximum allowable material thickness to be punched varies with set wear.



CAUTION!

Material thickness should not exceed hole diameter.

Standard Punch & Die Set 	Maximum Allowable Material Thickness To Be Punched										
	(in)										
Model No.	1)	2)	3)	4)	5)	6)	7)	8)	9)	10)	11)
SPD-313	.31	.31	.25	.25	.25	.25	.13	.19	.25	.25	.25
SPD-375	.38	.38	.31	.31	.31	.31	.19	.25	.31	.31	.31
SPD-438	.44	.44	.38	.38	.38	.31	.19	.31	.31	.31	.31
SPD-531	.50	.50	.44	.44	.44	.38	.25	.31	.38	.38	.38
SPD-563	.50	.50	.50	.44	.50	.44	.25	.38	.44	.44	.44
SPD-688	.50	.50	.50	.44	.50	.40	.25	.31	.40	.40	.40
SPD-781	.50	.50	.50	.44	.50	.38	.25	.31	.38	.39	.38
SPD-813	.50	.50	.50	.44	.50	.31	.19	.31	.31	.31	.31
SPD-458	.31	.31	.25	.25	.25	.25	.13	.19	.25	.25	.25
SPD-549	.38	.38	.31	.31	.31	.31	.19	.25	.31	.31	.31
SPD-639	.44	.44	.38	.38	.38	.31	.19	.31	.31	.31	.31
SPD-728	.50	.50	.44	.44	.44	.38	.25	.31	.38	.38	.34
SPD-106	.31	.31	.25	.25	.25	.25	.13	.19	.25	.25	.25
SPD-125	.38	.38	.31	.31	.31	.31	.19	.25	.31	.31	.31
SPD-188	.44	.44	.38	.38	.38	.31	.19	.31	.31	.31	.31
SPD-250	.50	.50	.44	.44	.44	.38	.25	.31	.38	.38	.38

Steel Qualities (see table):

- 1) Mild A-7
- 2) Boiler Plate
- 3) Structural A-36
- 4) Struct Corten (ASTM A242)
- 5) Cold Rolled C-1018
- 6) Hot Rolled C-1050
- 7) Hot Rolled C-1095
- 8) Hot Rolled C-1095 Annealed
- 9) Stainless Annealed
- 10) Stainless 304 Hot Rolled
- 11) Stainless 316 Cold Rolled

▼ Shown: SP-50100



- Available as a complete set including electric pump and hoses
- Double-acting cylinder design for fast cycle times
- Punch and die changeover tools included
- Lifting handle for easy carrying
- Adjustable power stripper prevents movement of the metal during stripping
- CR-400 female couplers included

Cuts the Time Spent Forming Holes



Depth Stop

For simplified repetitive punching applications an adjustable Depth Stop is available.

Order model number:
SP-110.



Foot Mounting Kit

A foot mounting kit for easy mounting of the 50 ton punch to workbench or fixture is available.

Please order: **SP-120.**



Ordering Information

The 50-ton Hydraulic Punch may be ordered by itself or as a set with an electric pump. A punch and die may be ordered as a matched set. Please refer to the selection chart information.



◀ Save time using this 50-ton Enerpac Punch.

▼ Shown below is the 50 ton punch with SP-120 and SP-110 assembled.



50 Ton Hydraulic Punch

▼ QUICK SELECTION CHART PUNCH SETS

Model Number Punch*	Included			Set Model Number	Weight (lbs)
	Punch & Die Sets	Pump	Hose (2x)		
SP-50	All**	-	-	SP-50100	255
SP-50	All**	ZE4410SB-N	HC-7206	SP-5000	384

* Punch Oil Capacity:
Advance: 17 in³
Retract: 14 in³

** All standard sets from chart below.

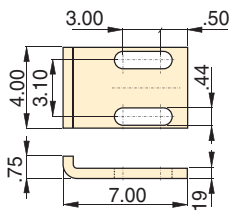

SP-110

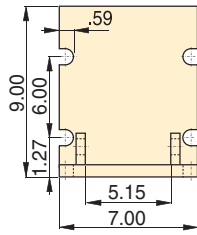

SP-120

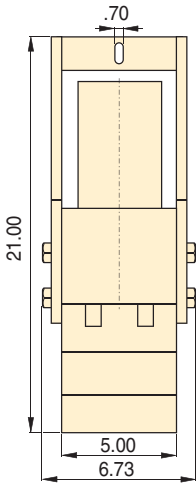
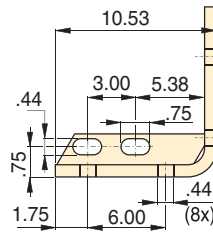

SP-50

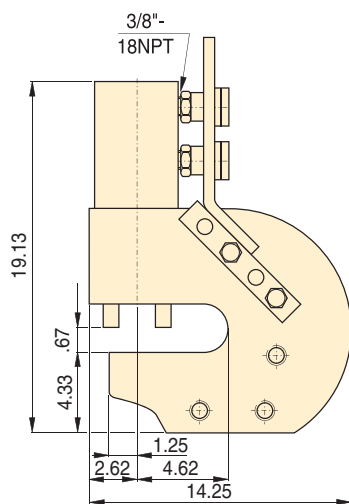

SP Series



Capacity:
50 tons

Hole Sizes:
0.53-1.03 inches

Maximum Operating Pressure:
10,000 psi



CAUTION!

Material thickness should not exceed hole diameter.



CAUTION!

Chart below is for reference only! Maximum allowable material thickness to be punched varies with set wear.

Steel Qualities (see table below):

- 1) Mild A-7
- 2) Boiler Plate
- 3) Structural A-36
- 4) Struct Corten (ASTM A242)
- 5) Cold Rolled C-1018
- 6) Hot Rolled C-1050
- 7) Hot Rolled C-1095
- 8) Hot Rolled C-1095 Annealed
- 9) Stainless Annealed
- 10) Stainless 304 Hot Rolled
- 11) Stainless 316 Cold Rolled

▼ STANDARD PUNCH AND DIE SELECTION CHART

Hole Shape	Hole Size (in)	Bolt Size (in)	Standard Punch and Die Set Model Numbers	Maximum Allowable Material Thickness To Be Punched (in)										
				1)	2)	3)	4)	5)	6)	7)	8)	9)	10)	11)
●	.53	1/2	SP-150	.53	.53	.53	.53	.53	.49	.32	.40	.49	.49	.49
●	.66	5/8	SP-170	.56	.56	.56	.50	.56	.51	.32	.40	.51	.51	.51
●	.78	3/4	SP-190	.56	.56	.56	.50	.56	.49	.32	.40	.49	.50	.49
●	.91	7/8	SP-121	.56	.56	.56	.50	.56	.35	.22	.35	.35	.35	.35
●	1.03	1	SP-123	.56	.56	.56	.44	.56	.31	.19	.31	.31	.31	.31

Vertical Lifting Wedge

▼ Shown: LW-16 with SB-2 and optional LWB-1



LW Series

Minimum Clearance:

.39 inches

Maximum Lift Height:

2.02*-2.72* inches

Maximum Force:

16 tons

Maximum Operating Pressure:

10,000 psi



ER-Series Load Skates

In combination with the Enerpac Lifting Wedge we recommend Load Skates for moving heavy loads.

Page: 170



Split-Flow Manifolds

Split Flow Valves to control two or four lifting wedges simultaneously.

AM-21 with 3 ports 3/8" NPTF.
AM-41 with 5 ports 3/8" NPTF.

Page: 118

- Requires .39 inch access gap
- Lifting force 16 ton at 10,000 psi hydraulic pressure
- Automatic mechanical retraction (single acting)
- Securely raises or lowers 16 tons with no slippage
- Lifting wedge LW-16 includes safety block SB-2
- Use in tandem to lift 32 tons, or 64 tons
- .83 inch of vertical lift from each step (maximum lift to 2.72 inches with optional LWB-1 stepped block)

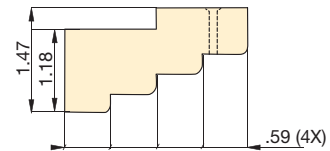

▲ Optional LWB-1 Stepped Block

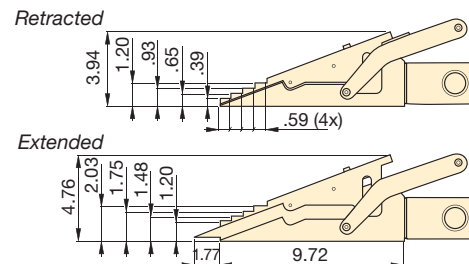

LW-16

▼ For lifting heavy equipment with minimum floor clearance the LW-16 is the ideal tool.



Max. Lifting Force (ton)	Model No.	Minimum Clearance Gap (in)	Max. Lift per Stage (in)	Max. Lifting Height (in)	Max. Lifting Height Using Stepped Block (in)	Oil Capacity (in ³)	Weight (lbs)
16	LW-16	.39	.83	2.02	2.72	4.75	15.4

*Use optional stepped block LWB-1 to increase wedge lifting height 1.18 inches.

Hydraulic Machine Lifts

▼ Shown from left to right: SOH-10-6, SOH-23-6



SOH Series

Lifting Capacity:
8.5-20 tons

Stroke:
5.39-6.18 inches

Toe Clearance:
0.79-1.18 inches

Maximum Operating Pressure:
10,000 psi

- For lifting heavy equipment with minimum available access
- Remote operation of hydraulic pump enhances safety
- Low-height lifting toe
- Precision guided to reduce friction and isolate cylinder from side-loads
- Two extendable support feet provide extra stability
- Includes RC-Series cylinder with CR-400 coupler

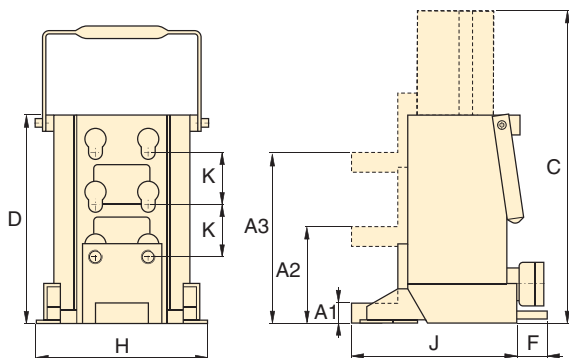

RSM Flat-Jac®

Low height, single acting spring-return cylinders are ideal for space restricted applications.

Page: 22



Best Match Manual Pump

To power your Enerpac Lifting Wedge, The Enerpac P-392 Hand Pump or P-392FP Foot Pump is an ideal choice.

Page: 57

Capacity (ton)	Toe Clearance with Cylinder Retracted (in)			Stroke (in)	Model Number	Oil Capacity (in ³)	Dimensions (in)						Weight (lbs)
	Minimum A1	Central A2	Maximum A3				Total Ext. Height C	Total Body Height D	F	H	J	K	
8.5	.79	3.74	6.69	5.39	SOH-10-6	13.7	17.00	11.61	–	7.48	8.46	2.95	59.2
20	1.18	4.33	7.48	6.18	SOH-23-6	32.0	18.58	12.40	2.56	10.24	9.84	3.15	99.2

▼ Shown: Set ERS-20

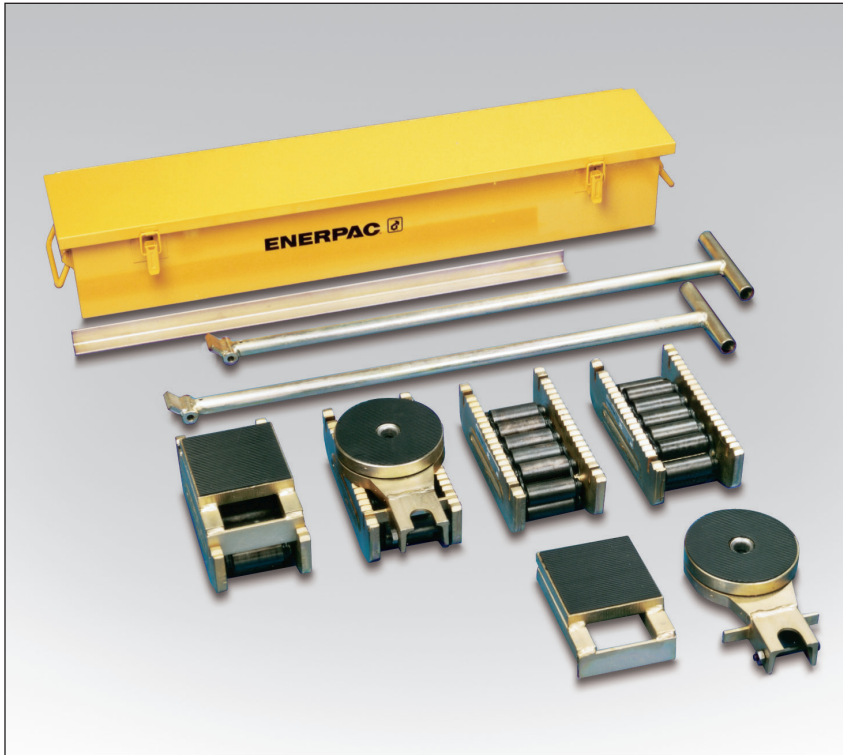

Move Heavy Loads Easily and Safely



Sets (see table) include all components necessary to handle a variety of applications. Two **ELB-1** link-up bars, two **ERH-1** handles (34.4" long) and one **EMB-1** metal box are included. Optional long handle **ERH-2** (46.4") also available.



Lifting Wedge and Machine Lifts

To place the Load Skates, the load must first be lifted. This can be done easily and safely using Enerpac Lifting Wedge or Machine Lifts.

- Rugged and sturdy construction for long life
- Low profile construction for increased stability
- Low rolling-resistance allows for easy load movement
- Attachable load leveling plates and swivel turntables for turning corners

Page: 168

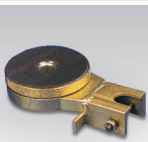
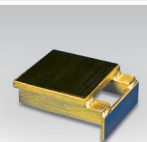

▼ Load Skates may be ordered separately or as a matched set.

Set Capacity*	Set Model Number	Load Skates (4)	Turntable Swivels (2)	Leveling Plates (2)	Weight Including handles and metal box
(tons)					(lbs)
20	ERS-20	ER-10	ES-10	ELP-10	110
30	ERS-30	ER-15	ES-15	ELP-15	123
60	ERS-60	ER-30	ES-30	ELP-30	167

* Sets are designed to enable two skates to take full load for extra safety on uneven floor surfaces

◀ Heavy transport using Load Skates. The machine is first lifted, using SOH-Series Enerpac Machine Lifts.

Heavy-Duty Caterroller™ Load Skates

**ELP,
ER,
ES
Series**



Maximum Carrying Capacity:
80 tons

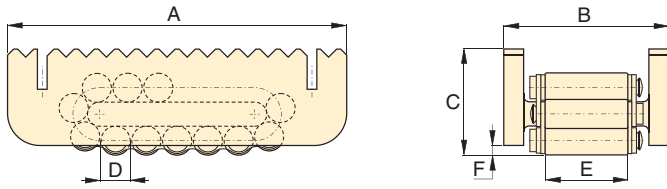

ER-1, ER-10, ER-15, ER-30

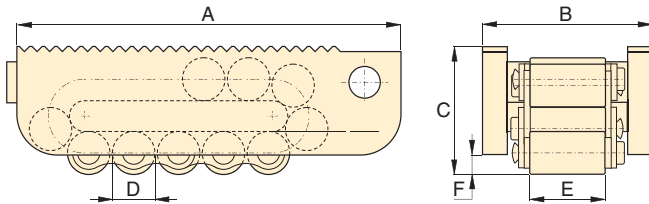

ER-60, ER-80

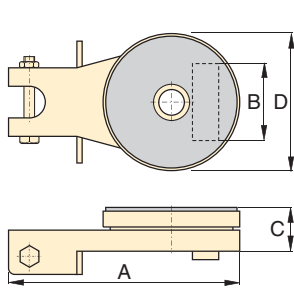

**Turntable Swivel
ES-1, ES-10, ES-15, ES-30**

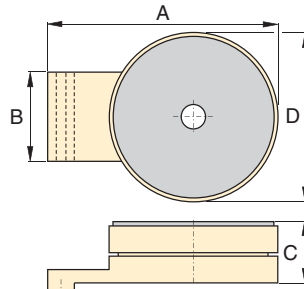

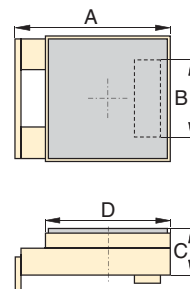

**Turntable Swivel
ES-60, ES-80**

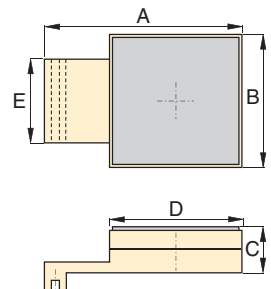

**Leveling Plate
ELP-10
ELP-15
ELP-30**

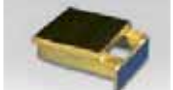

**Leveling Plate
ELP-60
ELP-80**

	Capacity (ton)	Model Number	Dimensions (inch)						Contact Rolls per Skate	Rollers per Skate	Weight (lbs)
			A	B	C	D	E	F			
Load Skates 	1	ER-1	6.30	3.94	2.56	.71	2.00	.16	4	11	8.4
	10	ER-10	8.27	3.94	2.63	.71	2.00	.24	5	15	11.5
	15	ER-15	8.69	4.45	2.95	.94	2.38	.39	4	13	16.0
	30	ER-30	10.63	5.13	3.63	1.18	2.69	.39	4	13	28.6
	60	ER-60	15.00	6.63	4.94	1.65	3.00	.63	4	13	70.4
	80	ER-80	20.88	7.19	5.75	1.97	3.38	.75	6	17	134.2
Turntable Swivel 	1	ES-1	8.15	3.42	1.02	3.54	-	-	-	-	2.4
	10	ES-10	8.66	2.87	1.65	5.12	-	-	-	-	8.1
	15	ES-15	8.66	3.38	1.65	5.12	-	-	-	-	8.1
	30	ES-30	9.87	3.78	1.89	5.91	-	-	-	-	11.7
	60	ES-60	10.83	4.50	2.40	7.48	-	-	-	-	30.1
	80	ES-80	14.19	5.06	2.40	8.66	-	-	-	-	41.6
Leveling Plate 	10	ELP-10	5.87	2.87	1.65	4.72	-	-	-	-	8.1
	15	ELP-15	5.87	3.38	1.65	4.72	-	-	-	-	8.1
	30	ELP-30	7.00	3.78	1.89	5.31	-	-	-	-	11.6
	60	ELP-60	10.63	4.50	2.40	7.09	4.49	-	-	-	30.4
	80	ELP-80	13.78	5.06	2.40	7.87	5.04	-	-	-	41.4

▼ Shown: **CM-16**



- Protect your equipment from dust, water, grease and dirt
- Reduce losses on the jobsite, maintenance area or shop
- Durable steel, painted with rust-resistant primer and finished in durable enamel
- Heavy-duty hinges and lifting handles
- Lockable

CM Series

Case Size:
.67-16 Cubic Ft.

Protect your Equipment



Maintenance Sets

Enerpac Maintenance sets are a complete assortment of accessories matched to hydraulic powered tools. Using these sets allows you to quickly configure a unique tool to meet your most difficult jobs.

Built around the Enerpac lightweight hand pump, hose and cylinder, these sets enable you to push, pull, lift, press, straighten, spread and clamp with forces up to 12.5 tons.



Hydraulic Pullers

These hydraulic pullers eliminate time-consuming and unsafe hammering, heating or prying.

Damage to parts is minimized through the use of controlled hydraulic power.

Page: **154**

▼ When not storing the lifting system, this heavy-duty storage case doubles as a work station.



Case Size	Model Number	Dimensions L x W x H	Thickness	Weight
(ft ³)		(in)	(in)	(lb)
.67	CM-6	23.5 x 7 x 7	.035	15.4
1.13	CM-1	25 x 11.5 x 6.6	.035	17.6
4.50	CM-4	31 x 18 x 14	.059	35.3
7.50	CM-7	47.5 x 15 x 18	.074	125.7
16.00	CM-16	48 x 24 x 24	.059	121.3

Hydraulic Wedgie and Spread Cylinders

▼ Shown clockwise from top: **WR-15, WR-5, A-92**



- **Single-acting, spring return**
- **WR-15:** For long stroke spreading applications
- **WR-5:** For use in very confined work areas
- **A-92:** Spreader attachment screws onto RC-Series 10 ton cylinders (except RC-101)

A, WR Series

Capacity:
0.75-1.00 ton

Tip Clearance:
0.50-1.38 inches

Maximum Spread Range:
3.70-11.50 inches

Maximum Operating Pressure:
10,000 psi



RC-Series DUO Cylinders
10 ton RC-Series DUO cylinders (except RC-101) fit into A-92 Spreader Attachment.

Page: **6**



Best Match Hand Pump
To power your WR5 and WR15 the **P-392** hand pump is an ideal choice.

Page: **58**

WR-5

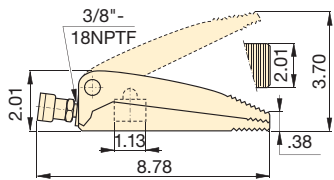

A-92

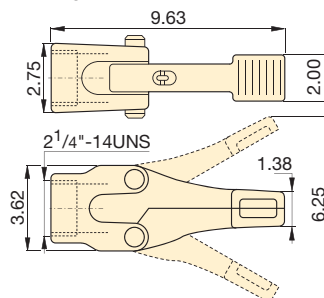

WR-15

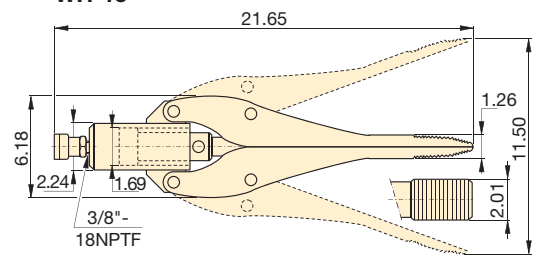

Spreader Capacity	Tip Clearance	Model Number	Maximum Spread	Cylinder Effective Area	Oil Capacity	Wt.
(ton)	(in)		(in)	(in ²)	(in ³)	(lbs)
1.00	.50	WR-5	3.70	1.00	.61	5.0
.75	1.26	WR-15	11.50	2.25	3.91	25.0
1.00	1.38	A-92	6.25	—	—	8.0

▼ A WR-5 wedgie cylinder is used to position a concrete block on a construction site.



▼ Shown from left to right: **WHC-3380, WHC-750**



- Single acting, spring return on all models, except WHR-1250
- Guillotine action for efficient operation
- Lifting handles on larger models
- Carrying bag included for easy carrying and tool protection
- Ideal for use with most Enerpac pumps featuring 3-way valve or dump valve and 10,000 psi pressure rating (except WHR-1250, which requires 4-way valve)
- CR-400 coupler and dust cap included on all models

WHC, WHR Series

Capacity:
3-20 tons

Cutting Capacity:
0.50-4 inches

Maximum Operating Pressure:
10,000 psi

Cutterhead Sets
Hydraulic Cutterheads are available as sets (pump, tool and hose).

Cutter Model Number	Pump Model Number	Set Model Number *
WHC-750	P-392	STC-750H
WHC-750	P-392FP	STC-750FP
WHC-750	PATG-1102N	STC-750A
WHC-1250	P-392	STC-1250H
WHC-1250	P-392FP	STC-1250FP
WHC-1250	PATG-1102N	STC-1250A

*H = Hand Pump, A = Air Operated Pump
FP = Foot Pump

▼ Steel rope is easily cut with the smooth guillotine action of an Enerpac cutterhead.



▼ Selection Chart Maximum Cutting Capacities (diameter in inches)

Cutter Head Operation	Capacity (ton)	Model Number	Oil Capacity (in ³)	Length (in)	Steel Wire Rope, Hemp-core or IWRC 6x7 6x12 6x19	Round Bar				Wire Strand			Cable		Wt. (lbs)	Replacement Blades	
						Copper Wire or Bar	Aluminum Wire or Bar	Soft Steel Bolts	Reinforcing Bar	Bare Copper Wire Strands	Bare Aluminum Wire Strands	ACSR	Guy Steel Wire Strands	Telephone Cable CPP			Underground Cable (Power)
Single-acting	4	WHC-750*	1.2	5.0	.63	.75	.75	.75	.50***	.75	.75	.75	.63	☆	☆	7	WCB-750
	20	WHC-1250*	8.2	11.00	1.25	1.13	1.25	1.13	1.00	1.25	1.25	1.25	.88	☆	☆	25	WCB-1250
	13	WHC-2000	7.3	15.00	1.00	1.25	1.25	.88	☆	2.00	2.00	2.00	.75	☆	2.00	23	WCB-2000
	3	WHC-3380	4.0	19.00	☆	☆	☆	☆	☆	1.63	1.69	☆	☆	3.38	3.38	20	WCB-3380
	8	WHC-4000	8.4	24.00	☆	☆	☆	☆	☆	☆	☆	☆	☆	4.00	4.00	32	WCB-4000
D/A**	20	WHR-1250	7.5	16.50	1.25	1.25	1.25	1.13	1.00	1.25	1.25	1.25	.88	☆	☆	26	WCB-1250

* Available in sets. ** D/A = Double-acting *** Low Alloy

☆ Will not cut designated material

Self-Contained Hydraulic Cutters

▼ Shown from left to right: WMC-2000, WMC-750



- Rotating heads for operator convenience
- Guillotine action (except WMC-1000) for efficient operation
- Carrying bag included for easy carrying and tool protection
- Velcro straps to secure handles on larger models for easy transportation
- Spring return on all models
- Lightweight, self-contained tool, can be used anywhere

WMC Series

Capacity:
3-20 tons

Maximum Material Diameter:
0.38-3.38 inches

Maximum Operating Pressure:
10,000 psi



Replacement Blades

To order 60-62HRC hardened replacement blades use one of the model numbers shown below.

For Cutter Model Number	Order Blade Model Number
WMC-580	WCB-750
WMC-750	WCB-750
WMC-1000	WCB-1000
WMC-1250	WCB-1250
WMC-1580	WCB-1580
WMC-2000	WCB-2000
WMC-3380	WCB-3380



Caution!

A "☆" in the charts on these pages means that this hydraulic cutter is not designed to cut this size or type of material. Any attempt to do so may result in personal injury and damage to the unit and will void the warranty.

▼ Selection Chart Maximum Cutting Capacities (diameter in inches)

Capacity (ton)	Model Number	Length (in)	Steel Wire Rope, Hemp-core or IWRC 6x7 6x12 6x19	Round Bar				Wire Strand					Cable		Weight (lbs)
				Copper Wire or Bar	Aluminum Wire or Bar	Soft Steel Bolts	Reinforcing Bar	Bare Copper Wire Strands	Bare Aluminum Wire Strands	ACSR Wire Strands	Guy Steel Wire Strands	Guy Steel Wire Strands	Telephone Cable CPP	Underground Cable (Power)	
4	WMC-580	15.00	.63	.63	.63	.63	.38	.63	.63	.63	.56	.56	☆	.63	8
4	WMC-750	15.00	.63	.69	.69	.69	.50***	.75	.75	.75	.56	.56	☆	.68	8
20	WMC-1000*	26.75	☆	.75	.75	.75	.75	☆	☆	☆	☆	☆	☆	☆	25
20	WMC-1250	26.75	1.25	1.13	1.25	1.25	.88	1.25	1.25	1.25	.88	1.00	☆	☆	23
6	WMC-1580	22.00	.75	.75	.75	.75	☆	1.50	1.63	1.63	.63	.63	☆	1.63	15
13	WMC-2000	24.75	1.00	1.25	1.25	.88	☆	2.00	2.00	2.00	.75	.75	☆	2.00	24
3	WMC-3380	26.00	☆	☆	☆	☆	☆	1.83	1.69	☆	☆	☆	3.37	3.38	22

* Cuts .50" alloy chain grade 70 (type G7 transport or tie-down) or grade 80 (for overhead lifting applications)

☆ Will not cut designated material

*** Low Alloy

▼ Shown: **STB-101H**



Quick, Safe and Wrinkle-free Bending



'One Shot' and 'Sweep'

One shot shoes give up to a 90° bend without resetting. Sweep shoes are used where increased radii are required for multiple parallel pipe installations.

- Makes smooth, wrinkle-free bends
- Sets include cylinder, hose and manual, air or electric pump
- Sets are also available without hydraulics
- Bending shoes and bending frame are lightweight, heat-treated aluminum
- All sets include sturdy steel storage case
- All sets include BZ-12091 angle indicator for accurate bending
- BZ-12377 Shoe Lock Pin included in every set
- Eject-O-Matic™ benders (STB-202 models) use a double-acting cylinder to eject pipe from the bending shoe

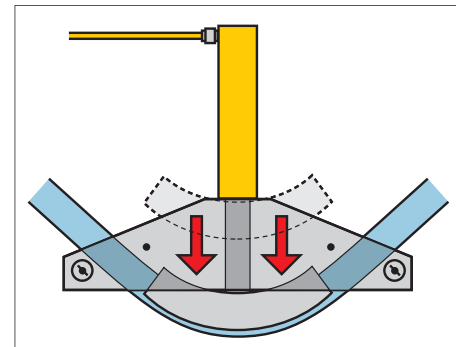

▲ Typical one shot bending operation.

▼ SELECTION CHART

Pipe Range		Set Model Number	Hand Pump*	Air Pump*	Electric Pump*	Cylinder*	Hose*	Steel Case*	Saddle	Weight (includes steel case)
One Shot	Sweep									
½ - 2	-	STB-101X	-	-	-	-	-	CM-4	A-12	88
		STB-101N	-	-	-	RC-1010	HC-7206	CM-4	A-12	105
		STB-101H	P-392	-	-	RC-1010	HC-7206	CM-4	A-12	114
		STB-101A	-	PATG-1102N	-	RC-1010	HC-7206	CM-4	A-12	119
		STB-101B	-	-	PUJ-1200B ²⁾	RC-1010	HC-7206	CM-4	A-12	127
1 - 2	2½ - 4	STB-221X	-	-	-	-	-	CM-7	A-29	229
		STB-221N	-	-	-	RC-2510	HC-7206	CM-7	A-29	263
		STB-221H	P-80	-	-	RC-2510	HC-7206	CM-7	A-29	286
1¼ - 4	-	STB-202X ¹⁾	-	-	-	-	-	CM-7	A-29	316
		STB-202N ¹⁾	-	-	-	RR-3014	HC-7206 (2x)	CM-7	A-29	383
		STB-202B ¹⁾	-	-	ZU4408SB ²⁾	RR-3014	HC-7206 (2x)	CM-7	A-29	467

* See corresponding sections of this catalog for more detailed specifications.

¹⁾ Eject-O-Matic™ ²⁾ For 230 volt applications change the last digit of Set Model Number from "B" to "E".

Pipe Bender Sets

Nominal pipe size (outside dia.) (in)	Wall Thickness (in)	Schedule Pipe *	Pipe Bend Inside Radius (in)	STB-101	STB-221	STB-202	One Shot Bending Shoe Model Number	Sweep Bending Shoe Model Number
				½ - 2 One Shot	1-2 One Shot 2½ - 4 Sweep	1¼ - 4 One Shot		
½ (.840)	.109	40	2 7/8	Yes	-	-	BZ-12011	-
	.147	80		Yes	-	-		
	.187	160		WS	-	-		
	.294	DEH		WS	-	-		
¾ (1.050)	.113	40	4	Yes	-	-	BZ-12021	-
	.154	80		Yes	-	-		
	.218	160		WS	-	-		
	.308	DEH		WS	-	-		
1 (1.315)	.133	40	5 1/8	Yes	Yes	-	BZ-12031	-
	.179	80		Yes	Yes	-		
	.250	160		WS	WS	-		
	.358	DEH		-	WS	-		
1¼ (1.660)	.140	40	6 7/8	Yes	Yes	Yes	BZ-12041	-
	.191	80		Yes	Yes	Yes		
	.250	160		WS	WS	Yes		
	.342	DEH		-	WS	WS		
1½ (1.900)	.145	40	7 5/8	Yes	Yes	Yes	BZ-12051	-
	.200	80		Yes	Yes	Yes		
	.281	160		WS	WS	Yes		
	.400	DEH		-	WS	WS		
2 (2.375)	.154	40	8 5/8	Yes	Yes	Yes	BZ-12061	-
	.218	80		-	Yes	Yes		
	.343	160		-	WS	Yes		
2½ (2.875)	.203	40	9 1/2	-	Yes	Yes	BZ-12341	BZ-12382
	.276	80		-	WS	Yes		
	.375	160		-	WS	Yes		
3 (3.500)	.216	40	11 ¼	-	Yes	Yes	BZ-12351	BZ-12383
	.300	80		-	WS	Yes		
3½ (4.000)	.226	40	15 ½	-	Yes	Yes	BZ-12391	BZ-12384
	.318	80		-	WS	Yes		
4 (4.500)	.237	40	17 ¾	-	Yes	Yes	BZ-12392	BZ-12385
	.337	80		-	-	Yes		

*Schedule Pipe: 40 = Standard; 80 = Extra Heavy; 160 = Double Extra Heavy;

DEH = Double Extra Heavy (slightly thicker than 160);

WS = Can be bent by using wider spacing for swivel shoes.

STB Series



Nominal Pipe Size:

0.5-4 inches

Maximum Bend Angle:

90°

Maximum Operating Pressure:

10,000 psi



All bender sets are designed to bend mild steel pipe. For other material please consult Enerpac.

Frame Assembly	Pivot Pin (2x incl)	Pivot Shoes (2x incl)	One Shot or Sweep ³⁾ Bending Shoes included									Set Model Number	
BZ-12371	BZ-12375	BZ-12071	BZ-12011	BZ-12021	BZ-12031	BZ-12041	BZ-12051	BZ-12061	-	-	STB-101X		
												STB-101N	
													STB-101H
													STB-101A
													STB-101B
BZ-12372	BZ-12376	BZ-13401	BZ-12031	BZ-12041	BZ-12051	BZ-12061	BZ-12382 ³⁾	BZ-12383 ³⁾	BZ-12384 ³⁾	BZ-12385 ³⁾	STB-221X		
											STB-221N		
												STB-221H	
BZ-12374	BZ-12376	BZ-13401	-	BZ-12041	BZ-12051	BZ-12061	BZ-12341	BZ-12351	BZ-12391	BZ-12392	STB-202X ¹⁾		
											STB-202N ¹⁾		
												STB-202B ¹⁾	

³⁾ Shoes are Sweep, all other shoes are One Shot.

ENERPAC'S *Bolting Solutions* caters to the complete bolting work-flow, ensuring joint integrity in a variety of applications throughout industry:

Joint Assembly

From simple pipe alignment to complex joint positioning of large structural assemblies, our comprehensive line of joint assembly products range from hydraulic to mechanical alignment tools.

Controlled Tightening

Enerpac offers a variety of controlled tightening options to best meet the requirements of your application. From mechanical torque multipliers to hydraulically driven square drive wrenches, and low profile torque wrenches, we offer the products you need for accurate and simultaneous tightening of multiple bolts.

Joint Separation

Enerpac also provides hydraulic nut splitters and a variety of mechanical and hydraulic spreading tools for joint separation during inspection, maintenance and decommissioning operations.

High-quality bolting solutions from the brand you can trust. See how Enerpac can make your bolting work-flow more accurate, safer and efficient.



Bolting Integrity Software

Visit www.enerpac.com to access our free on-line bolting software application and obtain information on tool selection, bolt load calculations and tool pressure settings. A combined application data sheet and joint completion report is also available.





















Torque Tightening

See our "Yellow Pages" for information on torque tightening.

Page: **253**



Bolting Tools and Pumps Section Overview

	Capacity	Tool Type and Functions	Series		Page
Controlled Tightening and Loosening	750-8000 Ft.lbs	Manual Torque Multipliers	E		180 ▶
	1400-25,150 Ft.lbs	Square Drive Hydraulic Torque Wrenches-Steel	S		182 ▶
	3/4 - 6-1/8 in.	Heavy-duty Impact Sockets Square Drive	BSH		186 ▶
	2000-35,000 Ft.lbs	Low Profile Hydraulic Torque Wrenches-Steel	W		188 ▶
	4250 Ft-lbs	Roller Cassette Torque Wrench	WCR		198 ▶
		Selection Matrix Torque Wrenches - Pumps - Hoses			202 ▶
	Flow 20 in ³ /min.	Portable Electric Torque Wrench Pumps	PMU		203 ▶
	Flow 60-120 in ³ /min.	Electric Torque Wrench Pumps	ZU4		204 ▶
	Flow 60-120 in ³ /min.	Electric Torque Wrench Pumps	TQ		208 ▶
	Flow 60-120 in ³ /min.	Electric Torque Wrench Pumps	ZE		210 ▶
	Flow 20 in ³ /min.	Compact Air Driven Torque Wrench Pumps	PTA		212 ▶
	Flow 60 in ³ /min.	Air Driven Torque Wrench Pumps	ZA4		214 ▶
	Flow 8-20 in ³ /min.	Electric Tensioning Pump	ZUTP		218 ▶
Joint Assembly / Joint Separation	Flow 4 in ³ /min.	High Pressure Air Pump	ATP		220 ▶
	1/2 - 27/8 A/F 23/4 - 53/8 A/F	Hydraulic Nut Cutters Hydraulic Nut Splitters	NC NS		221 ▶
	5-10 tons	Pin-type Hydraulic Flange Spreaders	FS		224 ▶
	8-14 tons	Step-type Industrial Spreader	FSM/ FSH		225 ▶
	0.3-5.0 tons	Flange Alignment Tools	ATM		226 ▶
	1-12 in. flange	Mechanical Flange Face Tool	FF		227 ▶

▼ Shown from left to right: E291, E393, E494



Accurate, Efficient Torque Multiplication

When accurate make-up or break-out of stubborn fasteners requires high torque

- High-efficiency planetary gear sets achieve high output torque from low input torque
- Most models operator protected by anti-backlash device
- Multiplier output accuracy $\pm 5\%$ of input torque
- Reversible, tighten or loosen bolts
- Reaction bar or reaction plate type
- Angle-of-turn protractor standard on E300 series models
- Reaction plate models offer increased versatility with reaction point locations
- E300 and E400 series replaceable shear drives provide overload protection of internal power train (one replacement shear drive is included)



Typical Torque Multiplier Applications

- Locomotives
- Power plants
- Pulp and paper mills
- Refineries
- Chemical plants
- Mining and construction
- Off-road equipment
- Shipyards
- Cranes

▼ SELECTION CHART

Torque Multiplier Type	Output Torque Capacity		Model Number
	(Ft.lbs)	(Nm)	
Reaction Bar Multiplier	750	1015	E290PLUS
	1000	1355	E291
	1200	1625	E391
	2200	2980	E392
	3200	4340	E393
Reaction Plate Multiplier	2200	2980	E492
	3200	4340	E493
	5000	6780	E494
	8000	10845	E495



◀ Enerpac Reaction Bar Torque Multiplier E393 used to manually torque bolts up to 3,200 ft-lbs.

Manual Torque Multipliers



Manual Torque Multipliers

Enerpac manual torque multipliers provide efficient torque multiplication in wide clearance applications and when external power sources are not available. Manual torque multipliers are used in most industrial, construction, and equipment maintenance applications. Hydraulic torque wrenches are better suited for tight tolerance, flange and repetitious bolting applications.

Use Reaction Bar Models:

- where space is limited
- where multiple reaction points are available
- when portability is desirable

Use Reaction Plate Models:

- above 3200 Ft.-lbs. output torque
- on flanges and applications where neighboring bolt or nut is available to react against
- when extreme reaction forces are generated

E Series



Maximum Output Torque:
750-8000 Ft.lbs

Torque Ratio:
3:1-52:1

Multiplier Output Ratio Accuracy:
± 5 %

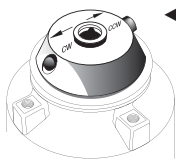

Selector Pawl
Models with anti-backlash protection have directional selector pawls. Set the pawl for clockwise or counter-clockwise rotation.

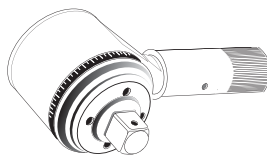

Angle-of-Turn Protractor
E391, E392 and E393 models include an angle-of-turn protractor (scale) to tighten fasteners using a "torque turn" method. Allows accurate measuring a specific number of degrees of rotation.



Shearable Square Drive
Designed to provide overload protection on E300- and E400-series multiplier power train by shearing when excess input torque is applied. Internal shear pin prevents tool from falling off bolt.

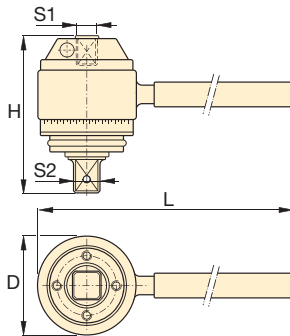

Reaction Bar Type ¹⁾

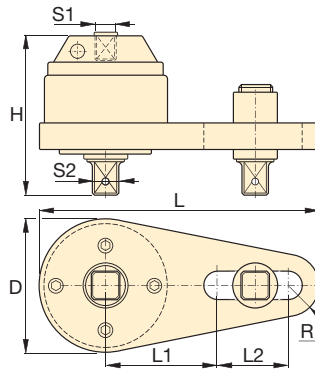

Reaction Plate Type ¹⁾



CAUTION!

Never use impact type air tools for power driving torque multipliers. Torque multiplier drive train damage will occur.



Hydraulic Torque Wrenches

Enerpac offers a complete range of square drive and hexagon cassette torque wrenches.

Page: 183



BSH-Series Sockets

Heavy-Duty Impact Sockets for power driven torquing equipment.

Page: 186

Input Torque		Torque Ratio	Input Female Square Drive	Output Male Square Drive		Over-load Protection	Anti-Back-lash	Dimensions (in)						Wt. (lbs)	Model Number
(Ft.lbs)	(Nm)			S1 (in)	S2 (in)			Replaceable Shear Drive Model No.	D	H	L	L1	L2		
250	338	3 : 1	1/2	3/4	–	No	No	2.8	3.3	8.6	–	–	–	4.0	E290PLUS
333	451	3 : 1	1/2	3/4	–	No	No	2.8	3.3	17.4	–	–	–	5.5	E291
200	271	6 : 1	1/2	3/4	E391SDK	Yes	No	3.9	4.0	19.6	–	–	–	13.8	E391
162	219	13.6 : 1	1/2	1	E392SDK	Yes	Yes	4.1	5.7	19.6	–	–	–	18.3	E392
173	234	18.5 : 1	1/2	1	E393SDK	Yes	Yes	4.1	6.5	19.6	–	–	–	15.2	E393
162	219	13.6 : 1	1/2	1	E392SDK	Yes	Yes	4.9	5.5	14.0	5.5	4.9	1.3	17.2	E492
173	234	18.5 : 1	1/2	1	E393SDK	Yes	Yes	4.9	6.4	14.0	5.5	4.9	1.3	23.4	E493
189	256	26.5 : 1	1/2	1 1/2	E494SDK	Yes	Yes	5.6	8.7	14.9	7.0	3.5	1.7	34.0	E494
154	208	52 : 1	1/2	1 1/2	E495SDK	Yes	Yes	5.8	10.7	15.2	7.0	3.5	1.9	50.3	E495

¹⁾ E200 and E400-series do not have an Angle-of-Turn Protractor (scale). User must verify manual torque wrench accuracy prior to use to ensure accurate final output torque.

▼ From left to right: S3000, S6000, S1500



Rigid Steel Design

The *Professional* Square Drive Solution



S-Series, Square Drive Wrenches

This product range has been designed using state-of-the-art CAD techniques to bring you the most advanced and safe torque wrench on the market.

To ensure that the tools you buy meet our own exacting requirements, during the design process every prototype was put through finite element stress analysis, photo-elastic modeling, rigorous cyclic testing and strain gauging.



Simplicity

- Includes handle to improve tool handling and safety
- 360° click-on, multi-position reaction arm
- Push button square drive release for quickly reversing the square drive for tightening or loosening
- Fine tooth ratchet prevents tool “lock-on”
- Single 360° hydraulic swivel manifold, complete with screw lock couplings, increases wrench and hose maneuverability

Design

- Compact, high-strength uni-body construction for a small operating radius
- Robust design with minimal parts enables easy on-site maintenance without special tools
- Lightweight, ergonomic design for easy handling and an easy fit, even in applications where access is limited
- Optimised strength-to-weight ratio
- Fast operation due to the large nut rotation per wrench cycle (35 degree rotation angle) and rapid return stroke

Reliability

- All wrenches are nickel-plated for excellent corrosion protection and improved durability in harsh environments

Accuracy

- Constant torque output provides high accuracy across the full stroke
- Accuracy of +/-3% can be achieved because the Uni-Body construction reduces internal deflections



TSP - Pro Series Swivel

Featuring Tilt & Swivel technology the TSP provides 360° X-axis rotation and 160° Y-axis rotation.

How to Order*

Order as an accessory which can be fitted to existing S-Series wrenches.

Factory fitted to new S-Series wrenches: Suffix the wrench model number with "-P", e.g.: **S1500-P**.

*Includes male and female couplers.

Page: **188**



Torque Wrench Hoses

Use Enerpac THQ-700 Series torque wrench hoses with S-Series torque wrenches to ensure the integrity of your hydraulic system.

19.5 feet long, 2 hoses	THQ-706T
39 feet long, 2 hoses	THQ-712T

Double-Acting Square Drive Hydraulic Torque Wrenches

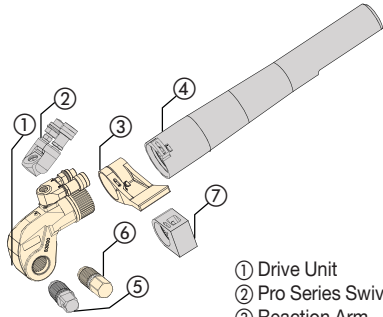

- ① Drive Unit
- ② Pro Series Swivel
- ③ Reaction Arm
- ④ Extended Reaction Arm
- ⑤ Square Drive
- ⑥ Allen Drive
- ⑦ Short Reaction Arm



Select the Right Torque

Choose your Enerpac Torque Wrench using the **untightening rule of thumb**:
Loosening torque equals about 250% of tightening torque.

S Series



Maximum Torque at 10,000 psi:
25,150 Ft.lbs

Square Drive Range:
3/4-2 1/2 inch

Nose Radius:
.99-2.50 inch

Maximum Operating Pressure:
10,000

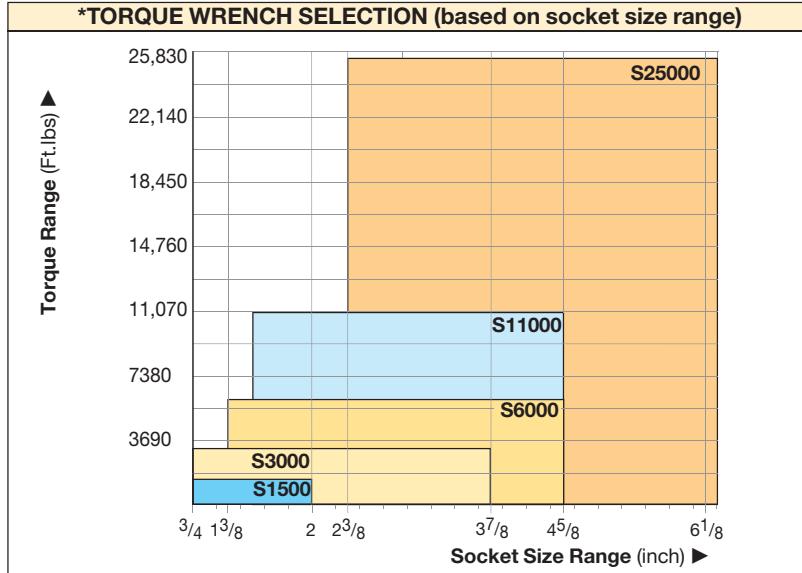

*Additional socket sizes available upon request.

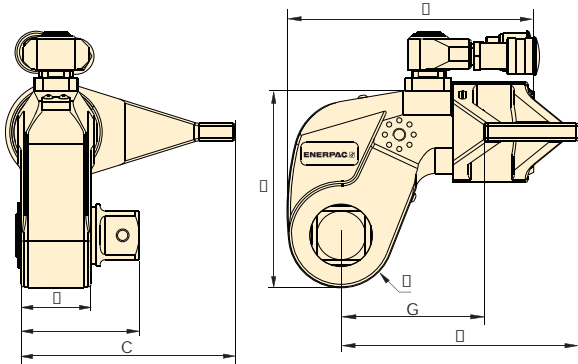

The rigid steel design of S-Series torque wrenches guarantee durability, reliability and safety. These wrenches can be powered by the portable ZU4T-Series pumps. ▶



Torque Wrench and Pump Selection Matrix

For optimum speed and performance see the torque wrench and pump matrix.

Page: 202



Maximum Torque at 10,000 psi		Square Drive		Torque Wrench Model No.	Dimensions (in)								Weight (lbs)
		Size (in)	Model No. (included with wrench)		A	B	C	D	E	F	G	H	
(Ft.lbs)	(Nm)												
1400	1898	3/4"	SD15-012	S1500	1.55	2.54	4.24	3.72	5.34	0.98	2.82	4.65	5.95
3200	4339	1"	SD30-100	S3000	1.91	3.14	5.28	4.92	6.79	1.30	3.56	6.26	11.02
6010	8148	1 1/2"	SD60-108	S6000	2.15	3.64	6.59	6.09	7.59	1.62	4.43	7.32	18.74
11,000	14,914	1 1/2"	SD110-108	S11000	2.81	4.48	7.71	7.35	8.98	1.95	5.22	8.89	33.07
25,150	34,099	2 1/2"	SD250-208	S25000	3.48	5.63	9.62	9.50	11.31	2.52	7.16	11.46	68.34

See "Yellow Pages" section for torque conversions.

To order a S-series wrench fitted with the TSP swivel, suffix the model number with "-P". e.g., S1500-P.

SDA-Series, Allen Drives

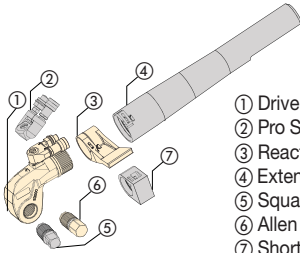

- ① Drive Unit
- ② Pro Series Swivel
- ③ Reaction Arm
- ④ Extended Reaction Arm
- ⑤ Square Drive
- ⑥ Allen Drive
- ⑦ Short Reaction Arm

Maximum Torque at 10,000 psi:

25,150 Ft.lbs.

Hexagon Size Allen Drive:

1/2-2 1/4 in. (14-85 mm)

For
S
Series



▼ SELECTION CHART

TORQUE WRENCH	OPTIONAL ALLEN DRIVES, IMPERIAL				OPTIONAL ALLEN DRIVES, METRIC				SHORT REACTION ARM FOR ALLEN DRIVES		
	Hexagon Size (in)	Maximum Torque (Ft.Lbs)	Model Number	Dim. B1 (in)	Hexagon Size (mm)	Maximum Torque (Ft.lbs)	Model Number	Dim. B1 (in)	Model Number	Dimensions (in) C1 H1	
S1500 (1400 Ft-lbs)	1/2	355	SDA15-008	2.6	14	475	SDA15-14	2.60	SRA15	2.66	2.56
	5/8	690	SDA15-010	2.6	17	850	SDA15-17	2.68			
	3/4	1195	SDA15-012	2.8	19	1185	SDA15-19	2.76			
	7/8	1400	SDA15-014	2.9	22	1400	SDA15-22	2.87			
	1	1400	SDA15-100	3.0	24	1400	SDA15-24	2.91			
S3000 (3200 Ft-lbs)	5/8	690	SDA30-010	3.0	17	850	SDA30-17	3.03	SRA30	3.15	2.91
	3/4	1195	SDA30-012	3.1	19	1185	SDA30-19	3.11			
	7/8	1895	SDA30-014	3.3	22	1835	SDA30-22	3.23			
	1	2825	SDA30-100	3.4	24	2385	SDA30-24	3.31			
	1 1/8	3200	SDA30-102	3.5	27	3200	SDA30-27	3.35			
	1 1/4	3200	SDA30-104	3.5	30	3200	SDA30-30	3.43			
	-	-	-	-	32	3200	SDA30-32	3.46			
S6000 (6010 Ft-lbs)	5/8	690	SDA60-010	3.3	17	850	SDA60-17	3.39	SRA60	3.60	3.50
	3/4	1195	SDA60-012	3.5	19	1185	SDA60-19	3.46			
	7/8	1895	SDA60-014	3.6	22	1835	SDA60-22	3.58			
	1	2825	SDA60-100	3.7	24	2385	SDA60-24	3.66			
	1 1/8	4025	SDA60-102	3.8	27	3395	SDA60-27	3.70			
	1 1/4	5520	SDA60-104	3.9	30	4655	SDA60-30	3.78			
S11000 (11,000 Ft-lbs)	1 1/4	5520	SDA110-104	4.5	30	4655	SDA110-30	4.41	SRA110	5.02	4.17
	1 3/8	7345	SDA110-106	4.6	32	5650	SDA110-32	4.49			
	1 1/2	9535	SDA110-108	4.6	36	8040	SDA110-36	4.61			
	1 5/8	11,000	SDA110-110	4.8	41	11,000	SDA110-41	4.76			
	1 3/4	11,000	SDA110-112	4.9	46	11,000	SDA110-46	5.00			
S25000 (25,150 Ft-lbs)	1 1/2	9535	SDA250-108	5.5	36	8040	SDA250-36	5.51	SRA250	6.24	5.31
	1 5/8	12,120	SDA250-110	5.7	41	11,880	SDA250-41	5.67			
	1 3/4	15,135	SDA250-112	5.8	46	16,775	SDA250-46	5.83			
	1 7/8	18,620	SDA250-114	5.9	50	21,545	SDA250-50	5.94			
	2	22,595	SDA250-200	5.9	55	25,150	SDA250-55	6.06			
	2 1/4	25,150	SDA250-204	6.0	60	25,150	SDA250-60	6.22			
	-	-	-	-	65	25,150	SDA250-65	6.34			
	-	-	-	-	70	25,150	SDA250-70	6.46			
	-	-	-	-	75	25,150	SDA250-75	6.61			
	-	-	-	-	85	25,150	SDA250-85	6.89			

Accessories for S-Series Torque Wrenches

TSP-Series, Pro Series Swivels

- Featuring Tilt and Swivel technology
- 360° X-axis and 160° Y-axis rotation
- Increases tool fit in restricted access areas
- Simplifies hose placement
- Includes male and female couplers

**TSP
RTE
SRS
Series**

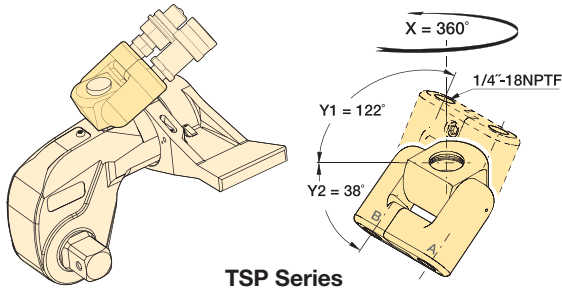

Torque Wrench Model Number	Model Number	Maximum Pressure (psi)	Wt. (lbs)
S1500, S3000	TSP100A	10,000	0.4
S6000, S11000, S25000	TSP200A	10,000	0.4

To order an S-series wrench fitted with the TSP swivel, add suffix "P" to the model number. Example: **S1500-P**.

RTE-Series, Reaction Tube Extensions

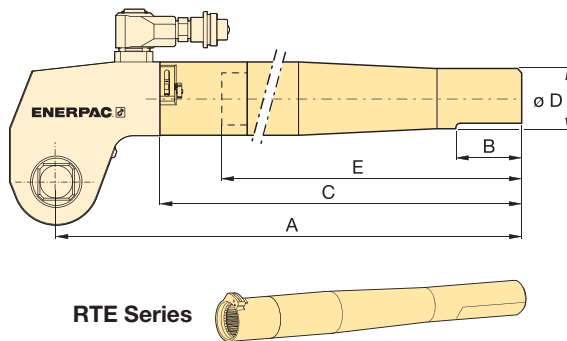

- Full torque rated
- Increases tool fit in restricted access areas

Torque Wrench Model Number	Model Number	Dimensions (in)					Wt. (lbs)*
		A	B	C	D	E	
S1500	RTE15	27.80	5.98	25.04	2.28	23.62	10.1
S3000	RTE30	28.86	5.98	25.47	2.24	23.62	12.1
S6000	RTE60	29.41	5.98	25.94	2.56	23.62	17.0
S11000	RTE110	30.28	5.98	26.57	2.99	23.62	24.7
S25000	RTE250	32.01	5.98	26.97	3.94	23.62	38.1

* Weights indicated are for the accessories only and do not include the wrench.

SRS-Series, Extended Reaction Arms

- Lightweight interchangeable design

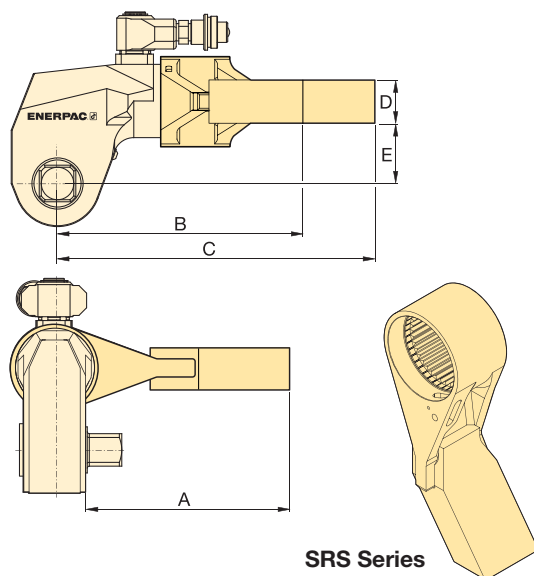

Wrench Model	Max. Torque (Ft-lbs)	Model Number	Dimensions (in)					Wt. (lbs)*
			A	B	C	D	E	
S1500	1328	SRS151	3.81	3.43	5.04	0.94	1.34	1.8
	1210	SRS152	4.80	3.86	5.47	0.94	1.34	2.2
	1131	SRS153	5.79	4.29	5.90	0.94	1.34	2.6
S3000	2890	SRS301	4.37	4.09	6.69	1.34	1.89	3.5
	2738	SRS302	5.39	4.69	7.28	1.34	1.89	4.4
	2636	SRS303	6.38	5.24	7.87	1.34	1.89	5.5
S6000	5784	SRS601	5.83	5.28	7.80	1.54	2.44	5.1
	5498	SRS602	6.81	5.87	8.39	1.54	2.44	6.0
	5292	SRS603	7.80	6.42	8.98	1.54	2.44	7.5
S11000	10805	SRS1101	5.94	6.22	233	1.81	2.99	9.7
	10294	SRS1102	6.93	6.81	9.17	1.81	2.99	11.2
	9877	SRS1103	7.91	7.36	10.31	1.81	2.99	12.8
S25000	24736	SRS2501	7.20	8.86	12.36	1.97	3.94	16.8
	23638	SRS2502	8.19	9.45	12.95	1.97	3.94	18.1
	22680	SRS2503	9.17	10.00	13.54	1.97	3.94	22.0

* Weights indicated are for the accessories only and do not include the wrench.

BSH-Series Sockets

- Heavy-duty impact sockets
- Supplied with "Pin and Ring"

Hexagon Sizes:
3/4 - 6 1/8 inch
19 - 155 mm



IMPERIAL SOCKETS													
3/4" Square Drive		1" Square Drive				1 1/2" Square Drive				2 1/2" Square Drive			
Model Number	A/F (in)	Model Number	A/F (in)	Model Number	A/F (in)	Model Number	A/F (in)	Model Number	A/F (in)	Model Number	A/F (in)	Model Number	A/F (in)
BSH7519	3/4"	BSH1019	3/4"	BSH10231	2 5/16"	BSH15144	1 7/16"	BSH15281	2 13/16"	BSH25244	2 7/16"	BSH25419	4 13/16"
BSH75088	7/8"	BSH10088	7/8"	BSH10238	2 3/8"	BSH1538	1 1/2"	BSH15288	2 7/8"	BSH25250	2 1/2"	BSH25425	4 1/4"
BSH75094	15/16"	BSH10094	15/16"	BSH10244	2 7/16"	BSH15156	1 9/16"	BSH1575	2 15/16"	BSH2565	2 9/16"	BSH25110	4 5/16"
BSH7527	1 1/16"	BSH1027	1 1/16"	BSH10250	2 1/2"	BSH15163	1 5/8"	BSH15300	3"	BSH25263	2 5/8"	BSH25438	4 3/8"
BSH7530	1 3/16"	BSH1030	1 3/16"	BSH1065	2 9/16"	BSH1543	1 11/16"	BSH15306	3 1/16"	BSH25269	2 11/16"	BSH25450	4 1/2"
BSH75125	1 1/4"	BSH10125	1 1/4"	BSH10263	2 5/8"	BSH15175	1 3/4"	BSH15313	3 1/8"	BSH2570	2 3/4"	BSH25463	4 5/8"
BSH75131	1 5/16"	BSH10131	1 5/16"	BSH10269	2 11/16"	BSH1546	1 13/16"	BSH15319	3 3/16"	BSH25281	2 13/16"	BSH25475	4 3/4"
BSH7535	1 3/8"	BSH1035	1 3/8"	BSH1070	2 3/4"	BSH15188	1 7/8"	BSH15325	3 1/4"	BSH25288	2 7/8"	BSH25488	4 7/8"
BSH75144	1 7/16"	BSH10144	1 7/16"	BSH10281	2 13/16"	BSH15194	1 15/16"	BSH15338	3 3/8"	BSH2575	2 15/16"	BSH25500	5"
BSH7538	1 1/2"	BSH1038	1 1/2"	BSH10288	2 7/8"	BSH15200	2"	BSH15350	3 1/2"	BSH25300	3"	BSH25513	5 1/8"
BSH75156	1 9/16"	BSH10156	1 9/16"	BSH1075	2 15/16"	BSH15206	2 1/16"	BSH15363	3 5/8"	BSH25306	3 1/16"	BSH25519	5 3/16"
BSH75163	1 5/8"	BSH10163	1 5/8"	BSH10300	3"	BSH15213	2 1/8"	BSH1595	3 3/4"	BSH25313	3 1/8"	BSH25525	5 1/4"
BSH7543	1 11/16"	BSH1043	1 11/16"	BSH10306	3 1/16"	BSH15219	2 3/16"	BSH15388	3 7/8"	BSH25319	3 3/16"	BSH25538	5 3/8"
BSH75175	1 3/4"	BSH10175	1 3/4"	BSH10313	3 1/8"	BSH15225	2 1/4"	BSH15100	3 15/16"	BSH25325	3 1/4"	BSH25140	5 1/2"
BSH7546	1 13/16"	BSH1046	1 13/16"	BSH10319	3 3/16"	BSH15231	2 5/16"	BSH15400	4"	BSH25338	3 3/8"	BSH25575	5 3/4"
BSH75188	1 7/8"	BSH10188	1 7/8"	BSH10325	3 1/4"	BSH15238	2 3/8"	BSH15105	4 1/8"	BSH25350	3 1/2"	BSH25150	5 7/8"
BSH75194	1 15/16"	BSH10194	1 15/16"	BSH10338	3 3/8"	BSH15244	2 7/16"	BSH15419	4 3/16"	BSH25363	3 5/8"	BSH25600	6"
BSH75200	2"	BSH10200	2"	BSH10350	3 1/2"	BSH15250	2 1/2"	BSH15425	4 1/4"	BSH2595	3 3/4"	BSH25613	6 1/8"
		BSH10206	2 1/16"	BSH10363	3 5/8"	BSH1565	2 9/16"	BSH15110	4 5/16"	BSH25388	3 7/8"		
		BSH10213	2 1/8"	BSH1095	3 3/4"	BSH15263	2 5/8"	BSH15438	4 3/8"	BSH25100	3 15/16"		
		BSH10219	2 3/16"	BSH10388	3 7/8"	BSH15269	2 11/16"	BSH15450	4 1/2"	BSH25400	4"		
		BSH10225	2 1/4"			BSH1570	2 3/4"	BSH15463	4 5/8"	BSH25105	4 1/8"		

METRIC SOCKETS							
3/4" Square Drive		1" Square Drive		1 1/2" Square Drive		2 1/2" Square Drive	
Model Number	A/F (mm)	Model Number	A/F (mm)	Model Number	A/F (mm)	Model Number	A/F (mm)
BSH7519	19	BSH1019	19	BSH1536	36	BSH2565	65
BSH7524	24	BSH1024	24	BSH15163	41	BSH2570	70
BSH7527	27	BSH1027	27	BSH1546	46	BSH2575	75
BSH7530	30	BSH1030	30	BSH1550	50	BSH2580	80
BSH7532	32	BSH1032	32	BSH1555	55	BSH2585	85
BSH7536	36	BSH1036	36	BSH1560	60	BSH2590	90
BSH75163	41	BSH10163	41	BSH1565	65	BSH2595	95
BSH7546	46	BSH1046	46	BSH1570	70	BSH25100	100
BSH7550	50	BSH1050	50	BSH1575	75	BSH25105	105
		BSH1055	55	BSH1580	80	BSH25110	110
		BSH1060	60	BSH1585	85	BSH25115	115
		BSH1065	65	BSH1590	90	BSH25120	120
		BSH1070	70	BSH1595	95	BSH25125	125
		BSH1075	75	BSH15100	100	BSH25135	135
		BSH1080	80	BSH15105	105	BSH25140	140
		BSH1085	85	BSH15110	110	BSH25145	145
		BSH1090	90	BSH15115	115	BSH25150	150
		BSH1095	95			BSH25155	155
		BSH10100	100				

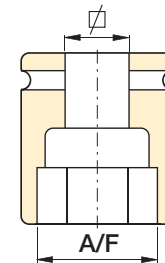

Pin and Ring

All sockets are supplied with a "Pin and Ring" to hold the socket in place on the square drive of the tool.



Select the Right Torque

Choose your Enerpac Torque Wrench using the untightening rule of thumb: Loosening torque equals about 250% of tightening torque.

ENERPAC professional series steel torque wrenches provide reliable controlled tightening solutions across many industries.

S3000 Square Drive Torque Wrench on Wind Turbine Assembly and Maintenance

S3000 used to connect wind turbine segments during assembly and maintenance. A robust but compact solution is required for bolt tightening on wind tower sections. Large numbers of fasteners require precise application of torque to ensure joint integrity is achieved and maintained.

The Enerpac S-Series wrench offers simple and reliable operation while providing accurate and repeatable results.



W4000 Low Profile Torque Wrench on an ANSI Pipe Flange

Throughout the Oil and Gas, Petrochemical and Processing Industries, pipeline joints, valves, pumps and machinery present challenges for controlled bolting.

The restricted access on this pipeline elbow was easily overcome with an Enerpac W-Series Torque Wrench. The W Wrenches offer reliability and control, ensuring even and consistent torque is applied to all bolts.

S6000 on a High Volume Pump Unit

High vibration requires long studs to be accurately tightened to the calculated preload.

During maintenance, quick turnaround times are essential; S Series wrenches provide a large angle of nut rotation per stroke, offering speed and accuracy in a compact ergonomic tool.



▼ Shown: Drive units with interchangeable cassettes



Rigid Steel Design

The *Professional* Low Profile Solution



W-Series, Low Profile Torque Wrenches

This product range has been designed using state-of-the-art CAD techniques to bring you the most advanced and safe torque wrench on the market. Safety, quality, toughness and reliability are built in.

During the design process every prototype was put through finite element stress analysis, photo-elastic modelling, rigorous cyclic testing and strain gauging.



Simplicity

- Includes handle to improve tool handling and safety
- No tools are needed for changing the hexagon cassettes
- Innovative, pinless wrench construction incorporates quick release cylinder and automatic crank engagement
- Single 360° hydraulic swivel manifold complete with screw lock couplings increases wrench and hose maneuverability

Design

- Cylinders and low profile cassettes have been engineered to give ultra slim, compact low clearance tooling with a small nose radius
- Robust design with minimal parts enables easy on-site maintenance without special tools
- Nut sizes covered range from 1 1/8 - 6 1/8 inch (30 - 155 mm)
- Optimized strength-to-weight ratio
- Fast operation due to the large nut rotation per wrench cycle (30 degree rotation angle) and rapid return stroke

Reliability

- All wrenches are nickel-plated for excellent corrosion protection and improved durability in harsh environments
- All wrenches are fitted with bronze bushings to ensure the ratchet will never seize in the sideplates, thus eliminating costly repairs

Accuracy

- Constant torque output provides accuracy ± 3% across the full stroke
- In-line reaction foot ensures accuracy by reducing internal deflections



TSP - Pro Series Swivel

Featuring Tilt and Swivel technology the TSP provides 360° X-axis rotation and 160° Y-axis rotation.

How to Order*

Order as an accessory which can be fitted to existing W-Series wrenches.

Factory fitted to new W-Series wrenches: Suffix the wrench model number with "-P" e.g.: **W2000-P**.

Page: 200



Torque Wrench Hoses

Use Enerpac THQ-700 Series hoses with W-Series torque wrenches to ensure the integrity of your hydraulic system.

19.5 feet long, 2 hoses	THQ-706T
39 feet long, 2 hoses	THQ-712T

Double-Acting Hydraulic Hexagon Torque Wrenches

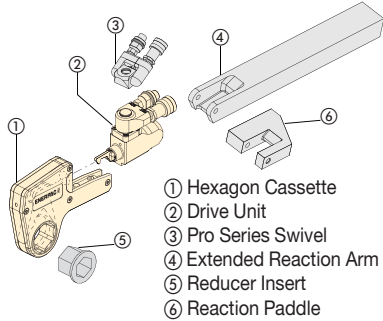

- ① Hexagon Cassette
- ② Drive Unit
- ③ Pro Series Swivel
- ④ Extended Reaction Arm
- ⑤ Reducer Insert
- ⑥ Reaction Paddle



Hexagon Cassettes and Reducer Inserts

Maximum versatility with the full range of interchangeable hexagon cassettes and hexagon reducing inserts is available in metric and inch sizes.

Page: 194

W Series



Maximum Torque at 10,000 psi:
35,000 Ft.lbs

Hexagon Range:
1 1/8 - 6 1/8 inch

Nose Radius:
1.22-4.52 inch

Maximum Operating Pressure:
10,000 psi

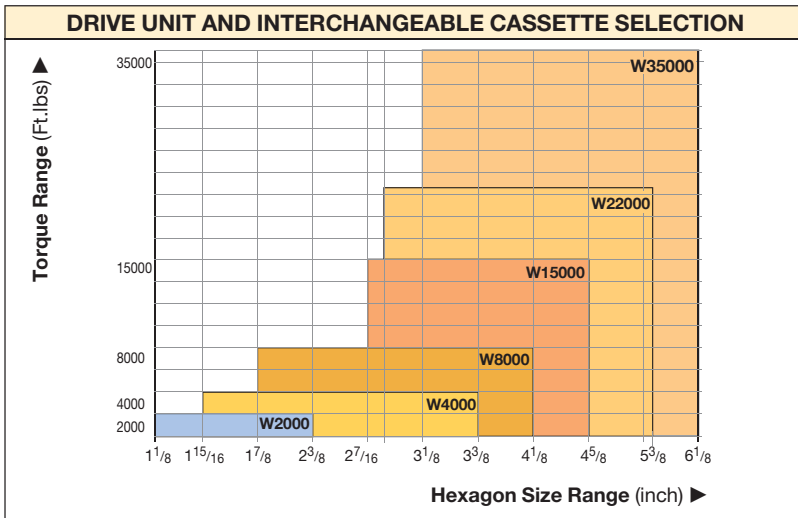

Torque Wrench Pump Selection Matrix

For optimum speed and performance see the torque wrench and pump matrix.

Page: 202

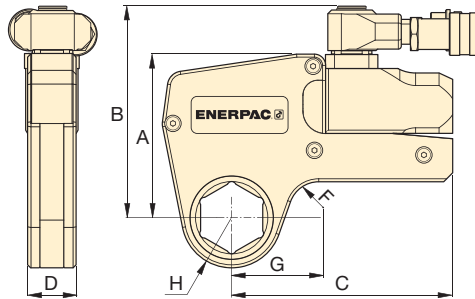

▼ These rigid steel wrenches with low profile interchangeable hexagon cassettes guarantee durability and maximum versatility in bolting applications.



SELECTION CHART

Hexagon Range *		Maximum Torque at 10,000 psi		Drive Unit Model Number **	Minimum Torque		Dimensions (in)					Weight (lbs)
(in)	(mm)	(Ft.lbs)	(Nm)		(Ft.lbs)	(Nm)	A	B	C	D	F	
1 1/8 - 2 3/8	30 - 60	2000	2712	W2000	200	271	4.29	5.55	5.83	1.26	.79	3.04
1 5/16 - 3 3/8	36 - 85	4000	5424	W4000	400	542	5.35	6.57	7.01	1.61	.79	4.44
1 7/8 - 4 1/8	50 - 105	8000	10.847	W8000	800	1084	6.77	8.07	8.19	2.07	.98	6.59
2 7/16 - 4 5/8	65 - 115	15,000	20.337	W15000	1500	2033	8.15	9.45	9.96	2.48	.79	10.72
2 15/16 - 5 3/8	75 - 135	22,500	30.506	W22000	2250	3050	8.94	10.46	11.69	3.03	1.38	16.98
3 1/8 - 6 1/8	80-155	35,000	47.454	W35000	3500	4745	10.54	11.94	13.60	3.57	1.98	25.14

* With in-line reaction foot.

** To order a W-series wrench fitted with the TSP swivel, suffix the model number with "-P". e.g., W2000-P.

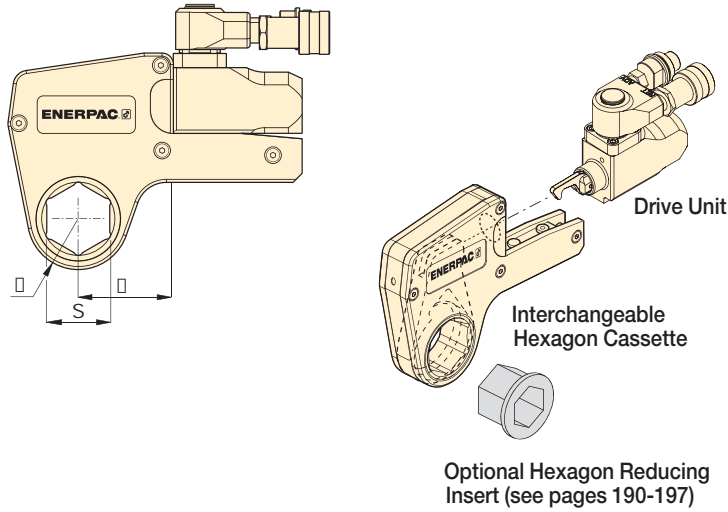

W Series



Maximum Torque at 10,000 psi:
2000 Ft.lbs





Hexagon Range:
1 1/8-2 3/8 inch

Maximum Operating Pressure:
10,000 psi



Metric Sizes
For metric sizes of hexagon cassettes and reducer inserts see:
Page: 196

▼ SELECTION CHART

Drive Unit Model Number	Hexagon Size	Nose Radius	Dim.	Model Number	Weight						
						Hexagon Reducer (in)	Model Number	Hexagon Reducer (in)	Model Number	Hexagon Reducer (in)	Model Number
	S (in)	H (in)	G (in)		(lbs)						
	1 1/8	1.22	2.11	W2102	4.19	-	-	-	-	-	-
	1 3/16	1.22	2.11	W2103	4.19	-	-	-	-	-	-
	1 1/4	1.22	2.11	W2104	4.19	-	-	-	-	-	-
	1 5/16	1.22	2.11	W2105	4.48	-	-	-	-	-	-
	1 3/8	1.22	2.11	W2106	4.43	-	-	-	-	-	-
	1 7/16	1.22	2.11	W2107	4.37	1 7/16 - 1 1/8	W2107R102	-	-	-	-
	1 1/2	1.32	2.29	W2108	4.51	-	-	-	-	-	-
	1 9/16	1.32	2.29	W2109	4.44	-	-	-	-	-	-
	1 5/8	1.32	2.29	W2110	4.38	1 5/8 - 1 1/4	W2110R104	1 5/8 - 1 3/16	W2110R103	-	-
	1 11/16	1.44	2.38	W2111	4.63	-	-	-	-	-	-
	1 3/4	1.44	2.38	W2112	4.57	-	-	-	-	-	-
	1 13/16	1.44	2.38	W2113	4.46	1 13/16 - 1 7/16	W2113R107	1 13/16 - 1 1/4	W2113R104	-	-
	1 7/8	1.54	2.48	W2114	4.69	-	-	-	-	-	-
	1 15/16	1.54	2.48	W2115	4.64	-	-	-	-	-	-
	2	1.54	2.48	W2200	4.54	2 - 1 5/8	W2200R110	2 - 1 7/16	W2200R107	-	-
	2 1/16	1.65	2.70	W2201	4.83	-	-	-	-	-	-
	2 1/8	1.65	2.70	W2202	4.74	-	-	-	-	-	-
	2 3/16	1.65	2.70	W2203	4.64	2 3/16 - 1 13/16	W2203R113	2 3/16 - 1 5/8	W2203R110	2 3/16 - 1 7/16	W2203R107
2 1/4	1.75	2.55	W2204	4.94	-	-	-	-	-	-	
2 5/16	1.75	2.55	W2205	4.84	-	-	-	-	-	-	
2 3/8	1.75	2.55	W2206	4.72	2 3/8 - 2	W2206R200	2 3/8 - 1 7/8	W2206R114	2 3/8 - 1 13/16	W2206R113	
-	-	-	-	-	-	2 3/8 - 1 1/2	W2206R108	2 3/8 - 1 7/16	W2206R107	2 3/8 - 1 5/8	W2206R110

W4000X Series Imperial Cassettes & Reducer Inserts

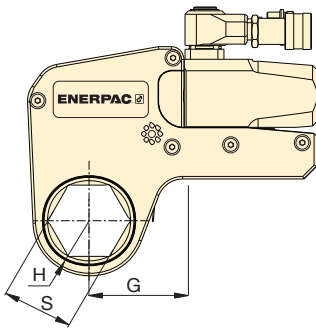

Maximum Torque at 10,000 psi:

4175 Ft.lbs

Hexagon Range:

1⁵/₁₆-3³/₈ inch

Maximum Operating Pressure:

10,000 psi

W
Series
(X-Edition)



▼ SELECTION CHART

Drive Unit Model Number	Hexagon Size	Nose Radius	Dim. G (in)	Model Number	Weight (lbs)	Hexagon Reducer		Hexagon Reducer		Hexagon Reducer	
						Hexagon Reducer (in)	Model Number	Hexagon Reducer (in)	Model Number	Hexagon Reducer (in)	Model Number
W4000X	1 ⁵ / ₁₆	1.46	2.40	W4105X	8.15	-	-	-	-	-	-
	1 ³ / ₈	1.46	2.40	W4106X	8.15	-	-	-	-	-	-
	1 ⁷ / ₁₆	1.46	2.40	W4107X	8.15	-	-	-	-	-	-
	1 ¹ / ₂	1.46	2.40	W4108X	8.31	-	-	-	-	-	-
	1 ⁹ / ₁₆	1.46	2.40	W4109X	8.22	-	-	-	-	-	-
	1 ⁵ / ₈	1.46	2.40	W4110X	8.15	-	-	-	-	-	-
	1 ¹¹ / ₁₆	1.56	2.52	W4111X	8.43	-	-	-	-	-	-
	1 ³ / ₄	1.56	2.52	W4112X	8.35	-	-	-	-	-	-
	1 ¹³ / ₁₆	1.56	2.52	W4113X	8.25	-	-	-	-	-	-
	1 ⁷ / ₈	1.63	2.63	W4114X	8.45	-	-	-	-	-	-
	1 ¹⁵ / ₁₆	1.63	2.63	W4115X	8.39	-	-	-	-	-	-
	2	1.63	2.63	W4200X	8.28	2 - 1 ⁷ / ₁₆	W4200R107	-	-	-	-
	2 ¹ / ₁₆	1.73	2.89	W4201X	8.65	-	-	-	-	-	-
	2 ¹ / ₈	1.73	2.89	W4202X	8.53	-	-	-	-	-	-
	2 ³ / ₁₆	1.73	2.89	W4203X	8.42	2 ³ / ₁₆ - 1 ⁵ / ₈	W4203R110	2 ³ / ₁₆ - 1 ⁷ / ₁₆	W4203R107	2 ³ / ₁₆ - 1 ¹ / ₄	W4203R104
	2 ¹ / ₄	1.83	2.78	W4204X	8.73	-	-	-	-	-	-
	2 ⁵ / ₁₆	1.83	2.78	W4205X	8.61	-	-	-	-	-	-
	2 ³ / ₈	1.83	2.78	W4206X	8.47	2 ³ / ₈ - 2	W4206R200	2 ³ / ₈ - 1 ¹³ / ₁₆	W4206R113	2 ³ / ₈ - 1 ⁷ / ₁₆	W4206R107
	-	-	-	-	-	2 ³ / ₈ - 1 ³ / ₈	W4206R106	-	-	-	-
	2 ⁷ / ₁₆	1.95	3.00	W4207X	8.96	2 ⁷ / ₁₆ - 2	W4207R200	-	-	-	-
	2 ¹ / ₂	1.95	3.00	W4208X	8.86	2 ¹ / ₂ - 2	W4208R200	2 ¹ / ₂ - 1 ¹³ / ₁₆	W4208R113	2 ¹ / ₂ - 2 ¹ / ₁₆	W4208R201
	2 ⁹ / ₁₆	1.95	3.00	W4209X	8.67	2 ⁹ / ₁₆ - 2 ³ / ₁₆	W4209R203	2 ⁹ / ₁₆ - 2 ¹ / ₈	W4209R202	-	-
	-	-	-	-	-	2 ⁹ / ₁₆ - 2	W4209R200	2 ⁹ / ₁₆ - 1 ¹³ / ₁₆	W4209R113	-	-
	2 ⁵ / ₈	2.07	3.08	W4210X	9.14	-	-	-	-	-	-
	2 ¹¹ / ₁₆	2.07	3.08	W4211X	9.03	-	-	-	-	-	-
	2 ³ / ₄	2.07	3.08	W4212X	8.84	2 ³ / ₄ - 2 ³ / ₈	W4212R206	2 ³ / ₄ - 2 ³ / ₁₆	W4212R203	2 ³ / ₄ - 2 ¹ / ₈	W4212R202
	2 ¹³ / ₁₆	2.18	3.21	W4213X	9.32	-	-	-	-	-	-
	2 ⁷ / ₈	2.18	3.21	W4214X	9.17	-	-	-	-	-	-
	2 ¹⁵ / ₁₆	2.18	3.21	W4215X	8.96	2 ¹⁵ / ₁₆ - 2 ⁹ / ₁₆	W4215R209	2 ¹⁵ / ₁₆ - 2 ³ / ₈	W4215R206	2 ¹⁵ / ₁₆ - 2 ³ / ₁₆	W4215R203
	-	-	-	-	-	2 ¹⁵ / ₁₆ - 2	W4215R200	-	-	-	-
	3	2.30	3.29	W4300X	9.51	3 - 2 ³ / ₁₆	W4300R203	-	-	-	-
	3 ¹ / ₁₆	2.30	3.29	W4301X	9.42	-	-	-	-	-	-
3 ¹ / ₈	2.30	3.29	W4302X	9.16	-	-	3 ¹ / ₈ - 2 ³ / ₄	W4302R212	3 ¹ / ₈ - 2 ⁹ / ₁₆	W4302R209	
-	-	-	-	-	3 ¹ / ₈ - 2 ³ / ₈	W4302R206	3 ¹ / ₈ - 2 ⁵ / ₁₆	W4302R205	3 ¹ / ₈ - 2 ¹ / ₄	W4302R204	
-	-	-	-	-	3 ¹ / ₈ - 2 ³ / ₁₆	W4302R203	3 ¹ / ₈ - 2 ¹ / ₈	W4302R202	3 ¹ / ₈ - 2	W4302R200	
3 ³ / ₁₆	2.44	3.37	W4303X	9.92	-	-	-	-	-	-	
3 ¹ / ₄	2.44	3.37	W4304X	9.92	-	-	-	-	-	-	
3 ⁵ / ₁₆	2.44	3.37	W4305X	9.92	-	-	-	-	-	-	
3 ³ / ₈	2.44	3.37	W4306X	9.92	-	-	-	-	-	-	

W8000 Series Imperial Cassettes & Reducer Inserts

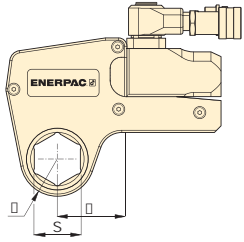

Maximum Torque at 10,000 psi:

8000 Ft.lbs

Hexagon Range:

1⁷/₈ - 4¹/₈ inch



Maximum Operating Pressure:

10,000 psi

**W
Series**



▼ SELECTION CHART

Drive Unit Model Number	Hexagon Size	Nose Radius	Dim.	Model Number	Weight						
						Hexagon Reducer (in)	Model Number	Hexagon Reducer (in)	Model Number	Hexagon Reducer (in)	Model Number
W8000	1⁷/₈	1.77	3.08	W8114	17.97	-	-	-	-	-	-
	1¹⁵/₁₆	1.77	3.08	W8115	17.89	-	-	-	-	-	-
	2	1.77	3.08	W8200	17.75	-	-	-	-	-	-
	2¹/₁₆	1.89	3.15	W8201	17.52	-	-	-	-	-	-
	2¹/₈	1.89	3.15	W8202	17.36	-	-	-	-	-	-
	2³/₁₆	1.89	3.15	W8203	17.22	-	-	-	-	-	-
	2¹/₄	2.01	3.25	W8204	17.92	-	-	-	-	-	-
	2⁵/₁₆	2.01	3.25	W8205	17.76	-	-	-	-	-	-
	2³/₈	2.01	3.25	W8206	17.59	-	-	-	-	-	-
	2⁷/₁₆	2.07	3.38	W8207	17.65	-	-	-	-	-	-
	2¹/₂	2.07	3.38	W8208	17.52	-	-	-	-	-	-
	2⁹/₁₆	2.07	3.38	W8209	17.29	2 ⁹ / ₁₆ - 2	W8209R200	-	-	-	-
	2⁵/₈	2.20	3.34	W8210	17.50	-	-	-	-	-	-
	2¹¹/₁₆	2.20	3.34	W8211	17.36	-	-	-	-	-	-
	2³/₄	2.20	3.34	W8212	17.12	2 ³ / ₄ - 2 ³ / ₁₆	W8212R203	-	-	-	-
	2¹³/₁₆	2.28	3.35	W8213	17.57	-	-	-	-	-	-
	2⁷/₈	2.28	3.35	W8214	17.38	-	-	-	-	-	-
	2¹⁵/₁₆	2.28	3.35	W8215	17.11	2 ¹⁵ / ₁₆ - 2 ³ / ₈	W8215R206	2 ¹⁵ / ₁₆ - 2 ³ / ₁₆	W8215R203	-	-
	3	2.38	3.52	W8300	17.77	-	-	-	-	-	-
	3¹/₁₆	2.38	3.52	W8301	17.65	-	-	-	-	-	-
	3¹/₈	2.38	3.52	W8302	17.33	3 ¹ / ₈ - 2 ⁹ / ₁₆	W8302R209	3 ¹ / ₈ - 2 ³ / ₈	W8302R206	3 ¹ / ₈ - 2 ³ / ₁₆	W8302R203
	-	-	-	-	-	-	3 ¹ / ₈ - 2	W8302R200	-	-	-
	3³/₁₆	2.60	3.63	W8303	18.99	-	-	-	-	-	-
	3¹/₄	2.60	3.63	W8304	18.72	-	-	-	-	-	-
	3⁵/₁₆	2.60	3.63	W8305	18.54	-	-	-	-	-	-
	3³/₈	2.60	3.63	W8306	18.36	-	-	-	-	-	-
	3⁷/₁₆	2.60	3.63	W83071	18.11	-	-	-	-	-	-
	3¹/₂	2.60	3.63	W8308	17.81	3 ¹ / ₂ - 3	W8308R300	3 ¹ / ₂ - 2 ¹⁵ / ₁₆	W8308R215	3 ¹ / ₂ - 2 ³ / ₄	W8308R212
	3⁹/₁₆	2.91	4.05	W8309	20.36	-	-	-	-	-	-
	3⁵/₈	2.91	4.05	W8310	20.18	-	-	-	-	-	-
	3¹¹/₁₆	2.91	4.05	W8311	19.93	-	-	-	-	-	-
	3³/₄	2.91	4.05	W8312	19.71	3 ³ / ₄ - 3 ¹ / ₈	W8312R302	3 ³ / ₄ - 2 ¹⁵ / ₁₆	W8312R215	3 ³ / ₄ - 2 ³ / ₄	W8312R212
3¹³/₁₆	2.91	4.05	W8313	19.46	-	-	-	-	-	-	
3⁷/₈	2.91	4.05	W8314	19.10	3 ⁷ / ₈ - 3 ¹ / ₈	W8314R302	3 ⁷ / ₈ - 2 ¹⁵ / ₁₆	W8314R215	-	-	
3¹⁵/₁₆	3.13	4.33	W8315	20.31	-	-	-	-	-	-	
4	3.13	4.33	W8400	20.04	-	-	-	-	-	-	
4¹/₁₆	3.13	4.33	W84011	19.80	-	-	-	-	-	-	
4¹/₈	3.13	4.33	W8402	19.39	-	-	-	-	-	-	

W15000 Series Imperial Cassettes & Reducer Inserts

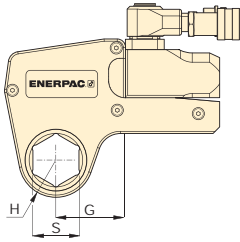

Maximum Torque at 10,000 psi:

15,000 Ft.lbs

Hexagon Range:

2⁷/₁₆-4⁵/₈ inch

Maximum Operating Pressure:

10,000 psi

W Series



▼ SELECTION CHART

Drive Unit Model Number	Hexagon Size	Nose Radius		Dim.	Model Number	Weight (lbs)	Image 1		Image 2		Image 3	
		S (in)	H (in)				G (in)	Image	Image	Image	Image	Image
W15000	2 ⁷ / ₁₆	2.32	3.49	W15207	30.72	-	-	-	-	-	-	-
	2 ¹ / ₂	2.32	3.49	W15208	30.72	-	-	-	-	-	-	-
	2 ⁹ / ₁₆	2.32	3.49	W15209	30.72	-	-	-	-	-	-	-
	2 ⁵ / ₈	2.32	3.49	W15210	30.72	-	-	-	-	-	-	-
	2 ¹¹ / ₁₆	2.32	3.49	W15211	30.72	-	-	-	-	-	-	-
	2 ³ / ₄	2.32	3.49	W15212	30.72	-	-	-	-	-	-	-
	2 ¹³ / ₁₆	2.44	3.56	W15213	30.62	-	-	-	-	-	-	-
	2 ⁷ / ₈	2.44	3.56	W15214	30.39	-	-	-	-	-	-	-
	2 ¹⁵ / ₁₆	2.44	3.56	W15215	30.08	-	-	-	-	-	-	-
	3	2.54	3.66	W15300	30.86	3 - 2 ¹ / ₈	W15300R202	-	-	-	-	-
	3 ¹ / ₁₆	2.54	3.66	W15301	30.71	-	-	-	-	-	-	-
	3 ¹ / ₈	2.54	3.66	W15302	30.34	3 ¹ / ₈ - 2 ⁹ / ₁₆	W15302R209	-	-	-	-	-
	3 ³ / ₁₆	2.74	3.80	W15303	32.38	-	-	-	-	-	-	-
	3 ¹ / ₄	2.74	3.80	W15304	32.07	-	-	-	-	-	-	-
	3 ⁵ / ₁₆	2.74	3.80	W15305	31.85	-	-	-	-	-	-	-
	3 ³ / ₈	2.74	3.80	W15306	31.63	-	-	-	-	-	-	-
	3 ⁷ / ₁₆	2.74	3.80	W15307I	31.32	-	-	-	-	-	-	-
	3 ¹ / ₂	2.74	3.80	W15308	30.98	3 ¹ / ₂ - 2 ¹⁵ / ₁₆	W15308R215	3 ¹ / ₂ - 2 ³ / ₄	W15308R212	-	-	-
	3 ⁹ / ₁₆	2.95	4.01	W15309	31.70	-	-	-	-	-	-	-
	3 ⁵ / ₈	2.95	4.01	W15310	31.70	-	-	-	-	-	-	-
	3 ¹¹ / ₁₆	2.95	4.01	W15311	31.70	-	-	-	-	-	-	-
	3 ³ / ₄	2.95	4.01	W15312	31.70	3 ³ / ₄ - 3 ¹ / ₈	W15312R302	3 ³ / ₄ - 2 ¹⁵ / ₁₆	W15312R215	-	-	-
	3 ¹³ / ₁₆	2.95	4.01	W15313	31.70	-	-	-	-	-	-	-
	3 ⁷ / ₈	2.95	4.01	W15314	31.70	3 ⁷ / ₈ - 3 ¹ / ₈	W15314R302	3 ⁷ / ₈ - 2 ¹⁵ / ₁₆	W15314R215	-	-	-
	3 ¹⁵ / ₁₆	3.17	4.06	W15315	34.02	-	-	-	-	-	-	-
	4	3.17	4.06	W15400	33.70	-	-	-	-	-	-	-
	4 ¹ / ₁₆	3.17	4.06	W15401I	33.41	-	-	-	-	-	-	-
	4 ¹ / ₈	3.17	4.06	W15402	33.09	4 ¹ / ₈ - 3 ¹ / ₂	W15402R308	4 ¹ / ₈ - 3 ⁵ / ₁₆	W15402R305	4 ¹ / ₈ - 3 ¹ / ₄	W15402R304	-
	4 ³ / ₁₆	3.17	4.06	W15403I	32.81	-	-	-	-	-	-	-
	4 ¹ / ₄	3.17	4.06	W15404	32.29	4 ¹ / ₄ - 3 ¹ / ₂	W15404R308	4 ¹ / ₄ - 3 ¹ / ₈	W15404R302	-	-	-
	4 ⁵ / ₁₆	3.44	4.52	W15405	35.61	-	-	-	-	-	-	-
	4 ³ / ₈	3.44	4.52	W15406	35.32	-	-	-	-	-	-	-
4 ⁷ / ₁₆	3.44	4.52	W15407	34.99	-	-	-	-	-	-	-	
4 ¹ / ₂	3.44	4.52	W15408I	34.63	-	-	-	-	-	-	-	
4 ⁹ / ₁₆	3.44	4.52	W15409I	34.28	-	-	-	-	-	-	-	
4 ⁵ / ₈	3.44	4.52	W15410I	33.72	4 ⁵ / ₈ - 3 ¹⁵ / ₁₆	W15410R315	4 ⁵ / ₈ - 3 ⁷ / ₈	W15410R314	4 ⁵ / ₈ - 3 ³ / ₄	W15410R312	-	
-	-	-	-	-	-	4 ⁵ / ₈ - 3 ¹ / ₂	W15410R308	-	-	-	-	

W22000 Series Imperial Cassettes & Reducer Inserts

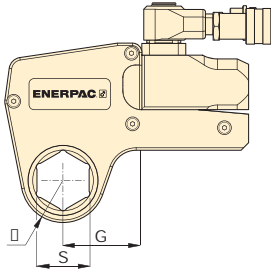

Maximum Torque at 10,000 psi:

22,500 Ft.lbs

Hexagon Range:

2¹⁵/₁₆ - 5³/₈ inch





Maximum Operating Pressure:

10,000 psi

W
Series



▼ SELECTION CHART

Drive Unit Model Number	Hexagon Size	Nose Radius	Dim.	Model Number	Weight						
						Hexagon Reducer (in)	Model Number	Hexagon Reducer (in)	Model Number	Hexagon Reducer (in)	Model Number
W22000	S	H	G		(lbs)						
	2 ¹⁵ / ₁₆	2.64	4.02	W22215	48.72	-	-	-	-	-	-
	3	2.64	4.02	W22300	48.40	-	-	-	-	-	-
	3 ¹ / ₁₆	2.64	4.02	W22301	48.22	-	-	-	-	-	-
	3 ¹ / ₈	2.64	4.02	W22302	47.78	3 ¹ / ₈ - 2 ³ / ₈	W22302R206	3 ¹ / ₈ - 2 ³ / ₁₆	W22302R203	-	-
	3 ³ / ₁₆	2.85	4.23	W22303	50.58	-	-	-	-	-	-
	3 ¹ / ₄	2.85	4.23	W22304	50.19	-	-	-	-	-	-
	3 ⁵ / ₁₆	2.85	4.23	W22305	49.92	-	-	-	-	-	-
	3 ³ / ₈	2.85	4.23	W22306	49.66	-	-	-	-	-	-
	3 ⁷ / ₁₆	2.85	4.23	W22307	50.29	-	-	-	-	-	-
	3 ¹ / ₂	2.85	4.23	W22308	48.87	3 ¹ / ₂ - 2 ³ / ₄	W22308R212	3 ¹ / ₂ - 2 ³ / ₁₆	W22308R209	3 ¹ / ₂ - 2 ³ / ₈	W22308R206
	3 ⁹ / ₁₆	3.07	4.45	W22309	51.58	-	-	-	-	-	-
	3 ⁵ / ₈	3.07	4.45	W22310	51.30	-	-	-	-	-	-
	3 ¹¹ / ₁₆	3.07	4.45	W22311	50.93	-	-	-	-	-	-
	3 ³ / ₄	3.07	4.45	W22312	50.62	3 ³ / ₄ - 2 ¹⁵ / ₁₆	W22312R215	-	-	-	-
	3 ¹³ / ₁₆	3.07	4.45	W22313	50.24	-	-	-	-	-	-
	3 ⁷ / ₈	3.07	4.45	W22314	49.77	3 ⁷ / ₈ - 3 ¹ / ₈	W22314R302	3 ⁷ / ₈ - 2 ¹⁵ / ₁₆	W22314R215	3 ⁷ / ₈ - 2 ³ / ₄	W22314R212
	3 ¹⁵ / ₁₆	3.35	4.72	W22315	53.57	-	-	-	-	-	-
	4	3.35	4.72	W22400	53.19	-	-	-	-	-	-
	4 ¹ / ₁₆	3.35	4.72	W22401	52.82	-	-	-	-	-	-
	4 ¹ / ₈	3.35	4.72	W22402	52.43	-	-	-	-	-	-
	4 ³ / ₁₆	3.35	4.72	W22403	52.09	-	-	-	-	-	-
	4 ¹ / ₄	3.35	4.72	W22404	51.48	4 ¹ / ₄ - 3 ¹ / ₂	W22404R308	4 ¹ / ₄ - 3 ¹ / ₈	W22404R302	4 ¹ / ₄ - 2 ¹⁵ / ₁₆	W22404R215
	4 ⁵ / ₁₆	3.54	4.92	W22405	54.26	-	-	-	-	-	-
	4 ³ / ₈	3.54	4.92	W22406	53.91	-	-	-	-	-	-
	4 ⁷ / ₁₆	3.54	4.92	W22407	53.50	-	-	-	-	-	-
	4 ¹ / ₂	3.54	4.92	W22408	53.06	-	-	-	-	-	-
	4 ⁹ / ₁₆	3.54	4.92	W22409	52.64	-	-	-	-	-	-
	4 ⁵ / ₈	3.54	4.92	W22410	51.99	4 ⁵ / ₈ - 3 ⁷ / ₈	W22410R314	4 ⁵ / ₈ - 3 ³ / ₄	W22410R312	4 ⁵ / ₈ - 3 ¹ / ₂	W22410R308
	4 ³ / ₄	3.74	5.12	W22412	54.54	-	-	-	-	-	-
	4 ⁷ / ₈	3.74	5.12	W22414	53.60	-	-	-	-	-	-
	5	3.74	5.12	W22500	52.37	5 - 4 ¹ / ₄	W22500R404	5 - 4 ¹ / ₈	W22500R402	5 - 3 ⁷ / ₈	W22500R314
5 ¹ / ₈	3.94	5.31	W22502	55.10	-	-	-	-	-	-	
5 ³ / ₁₆	3.94	5.31	W22503	54.71	-	-	-	-	-	-	
5 ¹ / ₄	3.94	5.31	W22504	54.05	-	-	-	-	-	-	
5 ³ / ₈	3.94	5.31	W22506	52.77	5 ³ / ₈ - 4 ⁵ / ₈	W22506R410	5 ³ / ₈ - 4 ¹ / ₄	W22506R404	5 ³ / ₈ - 4 ¹ / ₈	W22506R402	
-	-	-	W22506	52.77	5 ³ / ₈ - 3 ⁷ / ₈	W22506R314	-	-	-	-	

W35000 Series Imperial Cassettes & Reducer Inserts

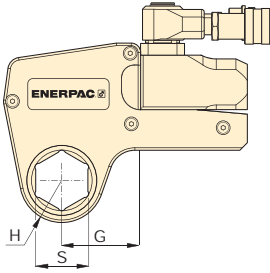

W Series



Maximum Torque at 10,000 psi:

35,000 Ft.lbs

Hexagon Range:

3¹/₈-6¹/₈ inches

Maximum Operating Pressure:

10,000 psi

▼ SELECTION CHART

Drive Unit Model Number	Hexagon Size	Nose Radius	Dim.	Model Number	Weight	Image	
						Hexagon Reducer (in)	Model Number
	S (in)	H (in)	G (in)		(lbs)		
W35000	3 ¹ / ₈	3.02	4.99	W35302	72.30	3 ¹ / ₈ - 2	W35302R200
	3 ³ / ₁₆	3.02	4.99	W35303	72.10	-	-
	3 ¹ / ₄	3.02	4.99	W35304	71.70	-	-
	3 ⁵ / ₁₆	3.02	4.99	W35305	71.40	-	-
	3 ³ / ₈	3.02	4.99	W35306	71.00	-	-
	3 ⁷ / ₁₆	3.02	4.99	W35307	70.50	-	-
	3 ¹ / ₂	3.02	4.99	W35308	70.10	3 ¹ / ₂ - 2 ⁵ / ₁₆	W35308R205
	3 ⁹ / ₁₆	3.23	5.22	W35309	71.40	-	-
	3 ⁵ / ₈	3.23	5.22	W35310	73.40	-	-
	3 ¹¹ / ₁₆	3.23	5.22	W35311	73.00	-	-
	3 ³ / ₄	3.23	5.22	W35312	72.50	-	-
	3 ¹³ / ₁₆	3.23	5.22	W35313	72.10	-	-
	3 ⁷ / ₈	3.23	5.22	W35314	71.40	3 ⁷ / ₈ - 2 ¹¹ / ₁₆	W35314R211
	3 ¹⁵ / ₁₆	3.45	5.39	W35315	70.80	3 ¹⁵ / ₁₆ - 2 ¹³ / ₁₆	W35315R213
	4	3.45	5.39	W35400	74.70	-	-
	4 ¹ / ₁₆	3.45	5.39	W35401	74.30	-	-
	4 ¹ / ₈	3.45	5.39	W35402	73.90	-	-
	4 ³ / ₁₆	3.45	5.39	W35403	73.40	-	-
	4 ¹ / ₄	3.45	5.39	W35404	72.80	4 ¹ / ₄ - 3 ¹ / ₁₆	W35404R301
	4 ⁵ / ₁₆	3.69	5.63	W35405	76.90	-	-
	4 ³ / ₈	3.69	5.63	W35406	76.50	-	-
	4 ⁷ / ₁₆	3.69	5.63	W35407	76.10	-	-
	4 ¹ / ₂	3.69	5.63	W35408	75.60	-	-
	4 ⁹ / ₁₆	3.69	5.63	W35409	75.20	-	-
	4 ⁵ / ₈	3.69	5.63	W35410	74.50	4 ⁵ / ₈ - 3 ⁵ / ₈	W35410R310
	4 ³ / ₄	3.91	5.85	W35412	78.50	4 ³ / ₄ - 3 ³ / ₄	W35412R312
	4 ⁷ / ₈	3.91	5.85	W35414	76.90	-	-
	5	3.91	5.85	W35500	75.60	5 - 4	W35500R400
	5 ¹ / ₈	4.09	6.02	W35502	78.90	5 ¹ / ₈ - 4 ¹ / ₈	W35502R402
	5 ³ / ₁₆	4.09	6.02	W35503	78.50	-	-
	5 ¹ / ₄	4.09	6.02	W35504	77.60	-	-
	5 ⁵ / ₈	4.09	6.02	W35506	76.30	5 ⁵ / ₈ - 4 ⁵ / ₁₆	W35506R405
5 ¹ / ₂	4.31	6.24	W35508	79.80	-	-	
5 ⁹ / ₁₆	4.31	6.24	W35509	79.40	-	-	
5 ⁵ / ₈	4.31	6.24	W35510	78.50	-	-	
5 ³ / ₄	4.31	6.24	W35512	76.90	5 ³ / ₄ - 4 ³ / ₄	W35512R412	
5 ⁷ / ₈	4.52	6.46	W35514	80.90	5 ⁷ / ₈ - 4 ⁷ / ₈	W35514R414	
6	4.52	6.46	W35600	79.60	-	-	
6 ¹ / ₈	4.52	6.46	W35602	77.80	6 ¹ / ₈ - 5 ¹ / ₈	W35602R502	

W Series Metric Cassettes and Reducer Inserts

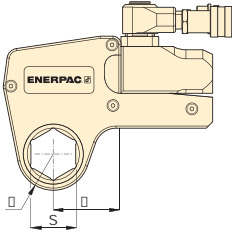







Hexagon Range:
30-105 mm

Maximum Operating Pressure:
10,000 psi (690 bar)

W
Series



▼ SELECTION CHART

Drive Unit Model Number	Hexagon Size	Nose Radius	Dim.	Model Number	Weight							
						Hexagon Reducer (mm)	Model Number	Hexagon Reducer (mm)	Model Number	Hexagon Reducer (mm)	Model Number	
 W2000	S (mm)	H (in)	G (in)		(lbs)							
	30	1.22	2.11	W2103	4.19	-	-	-	-	-	-	
	32	1.22	2.11	W2104	4.19	-	-	-	-	-	-	
	36	1.22	2.11	W2107	4.19	-	-	-	-	-	-	
	38	1.32	2.29	W2108	4.51	-	-	-	-	-	-	
	41	1.32	2.29	W2110	4.38	41 - 32	W2110R104	41 - 30	W2110R103	41 - 24	W2110R024M	
	46	1.44	2.38	W2113	4.69	46 - 36	W2113R107	46 - 32	W2113R104	-	-	
	50	1.54	2.48	W2200	4.54	50 - 41	W2200R110	50 - 36	W2200R107	-	-	
	55	1.65	2.70	W2203	4.64	55 - 46	W2203R113	55 - 41	W2203R110	55 - 36	W2203R107	
	60	1.75	2.55	W2206	4.72	60 - 50	W2206R200	60 - 46	W2206R113	60 - 41	W2206R110	
-	-	-	-	-	-	60 - 36	W2206R107	-	-	-		
 W4000	36	1.46	2.40	W4107	7.72	-	-	-	-	-	-	
	41	1.46	2.40	W4110	7.72	-	-	-	-	-	-	
	46	1.56	2.52	W4113	7.94	-	-	-	-	-	-	
	50	1.63	2.63	W4200	8.28	50 - 36	W4200R107	-	-	-	-	
	55	1.73	2.89	W4203	8.42	55 - 41	W4203R110	55 - 36	W4203R107	55 - 32	W4203R104	
	60	1.83	2.78	W4206	8.47	60 - 50	W4206R200	60 - 46	W4206R113	60 - 36	W4206R107	
	65	1.95	3.00	W4209	8.67	65 - 55	W4209R203	65 - 50	W4209R200	65 - 46	W4209R113	
	70	2.07	3.08	W4212	8.84	70 - 60	W4212R206	70 - 55	W4212R203	-	-	
	75	2.18	3.21	W4215	8.96	75 - 65	W4215R209	75 - 60	W4215R206	-	-	
	-	-	-	-	-	-	75 - 55	W4215R203	75 - 50	W4215R200	-	-
	80	2.30	3.29	W4302	9.16	80 - 75	W4302R215	80 - 70	W4302R212	80 - 65	W4302R209	
	-	-	-	-	-	-	80 - 55	W4302R203	80 - 50	W4302R200	-	-
 W8000	50	1.77	3.08	W8200	17.75	-	-	-	-	-	-	
	55	1.89	3.15	W8203	17.22	-	-	-	-	-	-	
	60	2.01	3.25	W8206	17.59	-	-	-	-	-	-	
	65	2.07	3.38	W8209	17.29	65 - 50	W8209R200	-	-	-	-	
	70	2.07	3.34	W8212	17.12	70 - 55	W8212R203	-	-	-	-	
	75	2.28	3.35	W8215	17.11	75 - 60	W8215R206	75 - 55	W8215R203	-	-	
	80	2.38	3.52	W8302	17.33	80 - 65	W8302R209	80 - 60	W8302R206	80 - 55	W8302R203	
	-	-	-	-	-	-	80 - 50	W8302R200	-	-	-	
	85	2.60	3.63	W8085M	18.42	85 - 70	W8085R070M	85 - 65	W8085R065M	85 - 60	W8085R060M	
	-	-	-	-	-	-	85 - 55	W8085R055M	-	-	-	
	90	2.91	4.05	W8090M	20.46	90 - 75	W8090R075M	-	-	-	-	
	95	2.91	4.05	W8312	19.71	95 - 80	W8312R302	95 - 75	W8312R215	-	-	
	100	3.13	4.33	W8315	20.31	-	-	-	-	-	-	
105	3.13	4.33	W8402	19.39	-	-	-	-	-	-		

W Series Metric Cassettes and Reducer Inserts

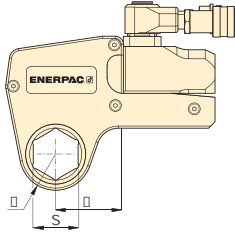

Hexagon Range:
65-155 mm

Maximum Operating Pressure:
10,000 psi (690 bar)

W
Series



▼ SELECTION CHART

Drive Unit Model Number	Hexagon Size	Nose Radius	Dim.	Model Number	Weight	Hexagon Reducer		Hexagon Reducer	
						Hexagon Reducer (mm)	Model Number	Hexagon Reducer (mm)	Model Number
W15000	65	2.32	3.49	W15209	30.72	-	-	-	-
	70	2.32	3.49	W15212	30.72	-	-	-	-
	75	2.44	3.56	W15215	30.08	-	-	-	-
	80	2.54	3.66	W15302	30.34	80-65	W15302R209	-	-
	85	2.74	3.80	W15085M	31.70	85-70	W15085R070M	-	-
	90	2.95	4.01	W15090M	33.32	90-75	W15090R075M	-	-
	95	2.95	4.01	W15312	31.70	95-80	W15312R302	95 - 75	W15312R215
	100	3.17	4.06	W15315	34.02	-	-	-	-
	105	3.17	4.06	W15402	33.09	105-90	W15402R090M	-	-
	110	3.44	4.52	W15405	35.61	110-95	W15110R095M	-	-
	115	3.44	4.52	W15115M	34.48	115-100	W15115R100M	-	-
W22000	75	2.64	4.02	W22215	48.72	-	-	-	-
	80	2.64	4.02	W22302	47.78	80-60	W22302R206	80 - 55	W22302R203
	85	2.85	4.23	W22085M	49.74	85-65	W22085MR209	85 - 60	W22085MR206
	90	3.07	4.45	W22090M	51.72	90-70	W22090M212	90 - 60	W22090MR206
	95	3.07	4.45	W22312	50.62	95-75	W22312R215	-	-
	100	3.35	4.72	W22315	53.57	-	-	-	-
	105	3.35	4.72	W22402	52.09	-	-	-	-
	110	3.54	4.92	W22404	51.48	-	-	-	-
	115	3.54	4.92	W22115M	52.88	-	-	-	-
	120	3.74	5.12	W22412	54.54	-	-	-	-
	123	3.74	5.12	W22123M	53.80	-	-	-	-
	130	3.94	5.31	W22502	55.10	-	-	-	-
	135	3.94	5.31	W22506	52.77	135 - 105	W22506R402	-	-
W35000	80	3.02	5.08	W35302	72.30	80-50	W35302R200	-	-
	85	3.02	5.08	W35085M	33.10	-	-	-	-
	90	3.23	5.33	W35090M	34.30	90-60	W35090R206	-	-
	95	3.23	5.30	W35312	72.50	-	-	-	-
	100	3.45	5.48	W35315	70.80	-	-	-	-
	105	3.45	5.48	W35402	73.90	-	-	-	-
	110	3.69	5.75	W35405	76.90	110-85	W35405R085M	-	-
	115	3.69	5.75	W35115M	77.10	-	-	-	-
	120	3.91	6.01	W35412	78.50	120-95	W35412R312	-	-
	123	3.91	6.01	W35123M	78.90	-	-	-	-
	130	4.09	6.30	W35502	78.90	130-105	W35502R402	-	-
	135	4.09	6.30	W35506	76.30	135-110	W35506R405	-	-
	140	4.31	6.43	W35508	79.80	140-115	W35508R115M	-	-
	145	4.31	6.43	W35512	76.90	145-120	W35512R412	-	-
	150	4.52	6.67	W35514	80.90	-	-	-	-
	151	4.52	6.67	W35151M	82.10	-	-	-	-
	155	4.52	6.67	W35602	77.80	155-130	W35602R502	-	-

▼ WCR4000 Roller Cassette with Spanner and W4000 Drive Unit



Provides a safe, and reliable controlled bolting solution for applications with limited access

- Spanners available to fit most commonly used API flanges
- Small nose radius – resolves bolt to pipe restrictions
- Slim spanner design – reduces bolt height restrictions
- Wide range of spanners ranging from 1⁷/₁₆ - 3¹/₈ inches (36 - 80 mm)
- Includes handle to improve tool handling and safety
- Rigid solid steel body for maximum endurance and minimum downtime



SAFE LINK Design

SAFE-LINK spanner design includes a mechanical fuse inside the cassette, providing a safer bolting

experience for the operator and bystanders.



Closed Bi-Hex Spanner

Slim ring style profile with bi-hexagonal design provides the ultimate mixture of versatility and durability.

▼ *The small nose radius of the closed spanner resolves bolt to pipe restrictions where standard hexagon cassettes do not fit.*

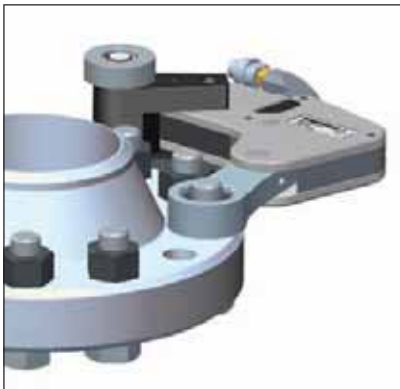

▼ *The slim spanner design allows tool to fit between bolts, where access is restricted and standard hexagon cassettes do not fit.*

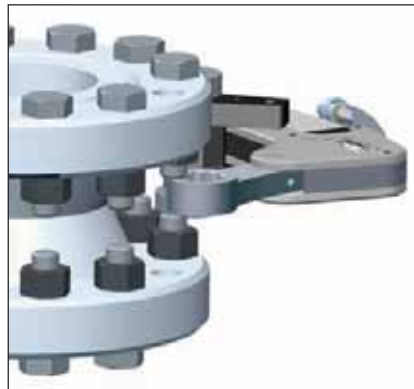

▼ *The roller-cassette reacts off the periphery of the flange, as the spanner drives the nut forward, allowing the WCR4000 to provide more torque in a limited space.**



*NOTE: The WCR Cassette is non-ratcheting.

Hydraulic Roller Cassette Torque Wrench



WCR4000-Series Applications

The WCR4000 helps resolve narrow clearance restrictions in bolting of API and BOP flanges.

The Enerpac WCR4000 Roller Cassette has been developed for applications where there are severe clearance restrictions, particularly in height above the nut or between the bolt center and the inside of the joint.

Powered by the standard W4000 drive unit which is compatible with standard W-Series hexagon cassettes.

The WCR-wrench must be repositioned after each wrench cycle by removing the tool from the nut and operating the pump in the retract direction. The tool does not retract.

Rigid Steel Design

The most advanced and safe torque wrenches on the market. To ensure that the tools you buy meet our own exacting requirements, during the design process every prototype was put through finite element stress analysis, photo-elastic modeling, rigorous cyclic testing and strain gauging.

Solid steel tool body for maximum endurance and minimum downtime.

WCR Series



Bi-Hexagonal Spanner Size:

1⁷/₁₆-3¹/₈ inch

Spanner Nose Radius:

1.22-2.18 inch

Maximum Torque:

4250 Ft-lbs

Maximum Operating Pressure:

10,000 psi

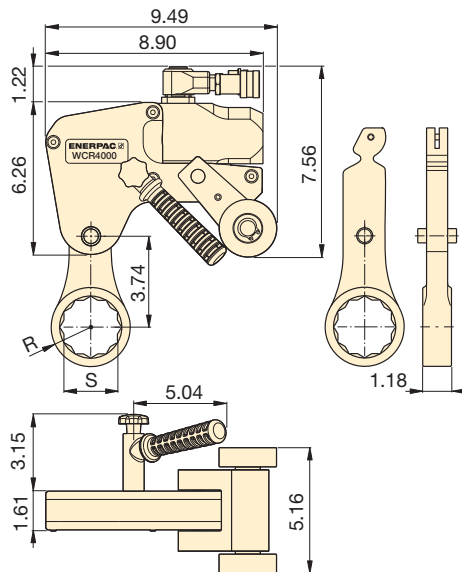

Torque Wrench Pumps

Visit enerpac.com for system matched air and electric torque wrench pumps providing control to operate hydraulic torque wrenches.



Torque Wrench Hoses

Use Enerpac THQ-700 Series hoses with W-Series torque wrenches to ensure the integrity of your hydraulic system.

19.5 feet long, 2 hoses

THQ-706T

39 feet long, 2 hoses

THQ-712T

Closed Spanner Hexagon Size	S		Closed Spanner Model Number	Maximum Torque (ft-lbs)	Spanner Radius R (in)	Weight * (lb)	Roller Cassette Assembly Model No.	Drive Unit Model No.
	(in)	(mm)						
1 ⁷ / ₁₆	36	914	W4107CS	4250	1.22	4.2	WCR4000	W4000
1 ¹ / ₂	38	965	W4108CS	4250	1.29	4.4		
1 ⁵ / ₈	41	1041	W4110CS	4250	1.29	4.2		
1 ³ / ₁₆	46	1168	W4113CS	4250	1.40	4.3		
1 ⁷ / ₈	48	1219	W4114CS	4250	1.51	4.7		
2	50	1270	W4200CS	4250	1.51	4.2		
2 ³ / ₁₆	55	1397	W4203CS	4250	1.62	4.3		
2 ³ / ₈	60	1524	W4206CS	4250	1.77	4.6		
2 ⁹ / ₁₆	65	1651	W4209CS	4250	1.84	4.6		
2 ³ / ₄	70	1778	W4212CS	4250	1.95	4.7		
2 ¹⁵ / ₁₆	75	1905	W4215CS	4250	2.05	4.6		
3 ¹ / ₈	80	2032	W4302CS	4250	2.18	4.9		

*For total weight add 13.89 lbs for WCR4000, 4.40 lbs. for W4000 and weight of the spanner.

▼ Powered by the standard W4000 drive unit which is compatible with standard W-Series hexagon cassettes.

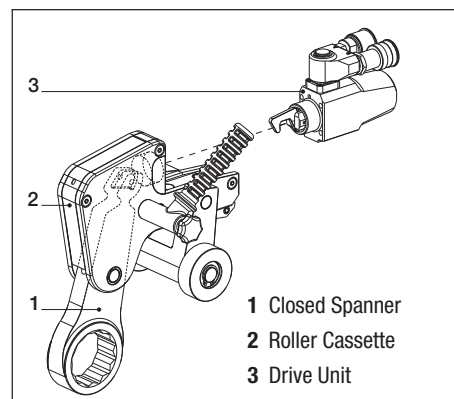

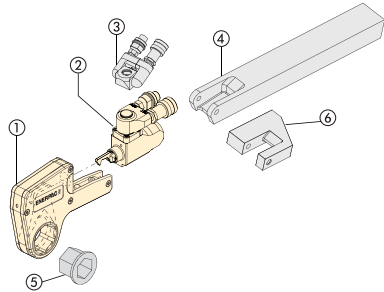

- ① Hexagon Cassette
- ② Drive Unit
- ③ Pro Series Swivel
- ④ Extended Reaction Arm
- ⑤ Reducer Insert
- ⑥ Reaction Paddle

TSP WTE WRP Series



TSP-Series, Pro Series Swivels

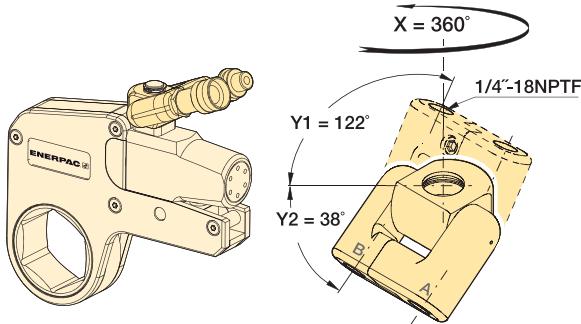

TSP-Series

- Featuring Tilt and Swivel technology
- 360° X-axis and 160° Y-axis rotation
- Increases tool fit in restricted access areas
- Simplifies hose placement
- Includes male and female couplers

Torque Wrench Model Number	Model Number	Maximum Pressure (psi)	Wt. (lbs)
W2000, W4000	TSP100A	10,000	.44
W8000, W15000, W22000, W35000	TSP200A	10,000	.44

To order a W-series wrench fitted with the TSP swivel, add suffix "P" to the model number. Example: **W2000-P**.

WTE-Series, Extended Reaction Arm

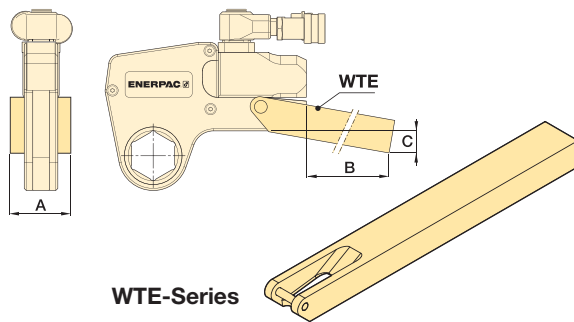

WTE-Series

- Full torque rated
- Increases tool fit in restricted access areas

Torque Wrench Model Number	Model Number	Dimensions (in)			Wt.* (lbs)
		A	B	C	
W2000	WTE20	2.20	15.67	2.99	5.73
W4000	WTE40	2.60	17.17	2.91	10.14
W8000	WTE80	3.35	17.68	2.60	16.75
W15000	WTE150	4.02	19.61	2.84	26.46
W35000	WTE350	5.00	16.48	5.23	39.17

* Weights indicated are for the accessories only and do not include the wrench.

WRP-Series, Low Profile Reaction Paddles

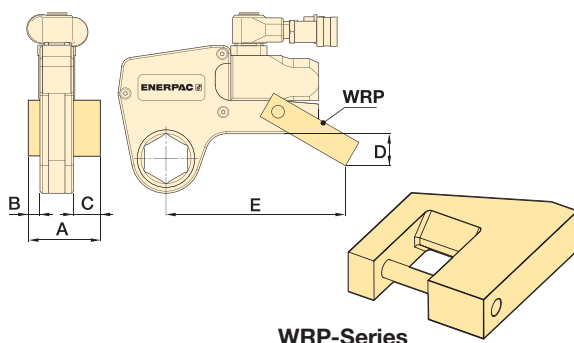

WRP-Series

- Lightweight interchangeable design
- Allows for offset reaction when in-line reaction is not available

Torque Wrench Model No.	Model Number	Dimensions (in)					Wt.* (lbs)
		A	B	C	D	E	
W2000	WRP20	3.31	0.62	1.38	1.77	5.83	.88
W4000	WRP40	4.29	0.83	1.85	2.32	7.48	1.76
W8000	WRP80	5.39	1.02	2.24	2.71	8.78	4.41
W15000	WRP150	6.50	1.26	2.71	3.43	10.12	8.60
W35000	WRP350	8.84	1.65	3.57	7.15	14.44	23.35

* Weights indicated are for the accessories only and do not include the wrench.

ENERPAC S-Series and W-Series Torque Wrenches provide high accuracy across the full stroke for safety critical applications.

W4000 Low Profile Torque Wrench used in a set of four to simultaneously tighten a flange

Sometimes some creativity is needed to tighten a joint that must be brought together by tightening multiple bolts at the same time. By combining four Enerpac W-Series wrenches with a 4-port manifold on an Enerpac ZE-Series pump this specialty task can be done safely and quickly. This simple adaptation provides even and accurate torque across the flange four times faster than using only one W4000 at a time.



S1500 Square Drive Wrench with twice the flexibility

When looking to tighten the bolts on a large specialized piece of machining equipment the need for a unique tool was requested by the customer. A double-headed Reaction Arm and double-sided Square Drive was the answer to the situation.

Although in most instances the Enerpac product in the catalog can solve a customer's requirements there are occasions where something custom is required. Enerpac has the capabilities to provide those solutions.

W8000 Low Profile Torque Wrench tightening the bolts on turbine.





















Using the strength and accuracy of a steel wrench to tighten highly stressed bolts on a turbine is the safe way to handle a critical application.

All of Enerpac's W-Series and S-Series Wrenches are made of high-strength steel which gives you additional stiffness that other alloys cannot provide. This added stiffness translates into a stronger and more durable tool.



Optimum Torque Wrench and Pump Combinations

For optimum speed and performance Enerpac recommends the following system set-up with wrench-pump-hose combinations.

		ELECTRIC PUMPS				AIR DRIVEN PUMPS	
		PMU-Series	ZU4-Series	TQ-700-Series	ZE4/5-Series	PTA-Series	ZA4-Series
							
		<i>Page:</i> 203	<i>Page:</i> 204	<i>Page:</i> 208	<i>Page:</i> 210	<i>Page:</i> 212	<i>Page:</i> 214
Speed:							
Oil Capacity:	.5 - 1 Gal.	1 - 1.75 Gal.	1 Gal.	1-10 Gal.	1 Gal.	1 - 1.75 Gal.	
Duty Cycle:	Standard duty	Standard duty	Medium duty	Heavy duty	Standard duty	Heavy duty	
Weight:							
Field/Factory Work:	Field	Field	Field/Factory	Factory	Field	Field	
S-Series	 182	S1500	Optimal	Optimal	Optimal	Optimal	Optimal
		S3000		Optimal			
		S6000		-		Acceptable	
		S11000					
		S25000					
W-Series	 188	W2000	Optimal	Optimal	Optimal	Optimal	Optimal
		W4000		Optimal			
		W8000					
		W15000					
		W22000					
		W35000				Acceptable	



ZU4-Series Electric Torque Wrench Pump

Utilizing a universal motor, the ZU4-Series has excellent low voltage characteristics. It works well with long extension cords or generator driven electrical power supplies. A field proven, efficient design ensures this pump is dependable and will draw less current – lowering your operating cost. The pumps are available in Pro and Classic formats. ZU4 Pro pumps have an LCD feature to display torque or pressure, selectable torque wrench, and self-diagnostics – premium features not available on any other pump. ZU4 Classic pumps feature an analogue gauge and a basic electrical package to deliver durable, safe and efficient hydraulic power.

ZE-Series Electric Torque Wrench Pump

The ZE-Series features premium options, such as the LCD to display torque or pressure values, and self-diagnostics. These pumps utilize an induction motor, making the ZE-Series the coolest and quietest pumps in their class.

ZA-Series Air Torque Wrench Pump

Utilizing the highly efficient design of the Z-Class pumping element, this air driven pump is best suited to power medium to large size torque wrenches



TQ-700 Series

Designed for both portability and production, the **TQ-700** features optimized flow technology to deliver superior bolting speed.

Page: 208



Call Enerpac!

For other combinations, consult your Enerpac bolting expert or your authorized Enerpac distributor.

Portable Electric Torque Wrench Pumps

▼ Shown: PMU-10427



PMU Series

Reservoir Capacity:

0.5-1 gal.

Flow at 10,000 psi:

20 in³/min.

Motor Size:

0.5 hp

Maximum Operating Pressure:

10,000 and 11,600 psi



Pump Ratings

-Q suffix pumps are for 10,000 psi torque wrenches, and include spin-on couplers.

-E suffix pumps are for use with 11,600 psi rated torque wrenches, and include polarized lock-ring safety couplers.

- Powerful two-speed pump is lightweight and easy to carry
- Standard heat exchanger package keeps pump cool under extreme use
- Glycerin filled gauge with scales reading in psi and bar
- Transparent overlays in Ft.lbs and Nm for all Enerpac torque wrenches provide a quick torque reference
- Universal motor for a high power-to-weight ratio; generates full pressure on as little as 50% of the rated line voltage
- Adjustable pressure relief valve for accurate torque adjustments and precise repeatability



Twin Torque Wrench Hoses

Use Enerpac THQ-700 series twin hoses with 10,000 psi pumps, or use THC-700 series twin hoses with 11,600 psi pumps.

10,000 psi	
19.5 feet long, 2 hoses	THQ-706T
39 feet long, 2 hoses	THQ-712T
11,600 psi	
19.5 feet long, 2 hoses	THC-7062
39 feet long, 2 hoses	THC-7122

▼ SELECTION CHART

For Use With Torque Wrenches		Maximum Pressure Rating (psi)		Oil Flow Rate (in ³ /min)		Model Number	Useable Oil Capacity (gal)	Electric Motor	Dimensions L x W x H (in)	Weight (lbs)
		1 st stage	2 nd stage	1 st stage	2 nd stage					
S1500 S3000	W2000	700	10,000	200	20	PMU-10427-Q	.50	115V- 1 ph -50/60Hz	17 x 11 x 15	53
		700	10,000	200	20	PMU-10447-Q	1.0	115V- 1 ph -50/60Hz	17 x 13 x 15	60
	W4000	700	10,000	200	20	PMU-10422-Q	.50	230V- 1 ph -50/60Hz	17 x 11 x 15	53
		700	10,000	200	20	PMU-10442-Q	1.0	230V- 1 ph -50/60Hz	17 x 13 x 15	60
SQD-25-I SQD-50-I	HXD-30	700	11,600	200	20	PMU-10427	.50	115V- 1 ph -50/60Hz	17 x 11 x 15	53
		700	11,600	200	20	PMU-10447	1.0	115V- 1 ph -50/60Hz	17 x 13 x 15	60
	HXD-60	700	11,600	200	20	PMU-10422	.50	230V- 1 ph -50/60Hz	17 x 11 x 15	53
		700	11,600	200	20	PMU-10442	1.0	230V- 1 ph -50/60Hz	17 x 13 x 15	60

ZU4 Electric Torque Wrench Pumps

ENERPAC 
POWERFUL SOLUTIONS. GLOBAL FORCE.

▼ Shown: ZU4204TB-Q and ZU4204BB-Q



- Features **Z-Class** high-efficiency pump design; higher oil flow and bypass pressure, cooler running and requires 18% less current draw than comparable pumps
- Powerful 1.7 hp universal electric motor provides high power-to-weight ratio and excellent low-voltage operating characteristics
- High-strength, molded composite shroud protects motor and electrical components, while providing an ergonomic, non-conductive handle for easy transport
- Low-voltage pendant provides additional safety for the operator
- Valve technology reduces oil operating temperatures and withstands contaminants to increase pump reliability

Pro-Series

- LCD readout provides pressure and torque display and a number of diagnostic and readout capabilities never before offered on a portable electric pump
- Auto cycle feature provides continuous cycle operation of the torque wrench as long as the advance button is pressed. (Pump can be used with or without auto cycle feature)

Z Tough.
Dependable.
Innovative.
CLASS



FIRMWARE for Pro-Series

- Display torque in Ft.lbs. or Nm
- Display pressure in bar, MPa or psi
- Torque wrench model is selectable
- “Auto cycle” setting easily programmable



Classic Electrical

Basic electrical package includes mechanical contactor, ON/OFF toggle switch, pendant with electro-mechanical pushbuttons, 24V transformer timer and operator accessible circuit breaker.



Back-lit LCD, for Pro-Series

- Pump usage information, hour and cycle counts
- Low-voltage warning and recording
- Self-test and diagnostic capabilities
- Information can be displayed in English, French, German, Italian, Spanish and Portuguese
- Pressure transducer is more accurate and durable than analog gauges

▼ Any brand of hydraulic torque wrench can be powered by the portable ZU4-Series torque wrench pump.



ZU4 Torque Wrench Pumps



Z-Class – A Pump For Every Application

Patented Z-Class pump technology provides

high by-pass pressures for increased productivity—important in applications using long hose runs and high pressure-drop circuits, like heavy lifting or certain double-acting tools.

Enerpac ZU4 Hydraulic Pumps are built to power small to large torque wrenches. Choosing the right ZU4 torque wrench pump for your application is easy.

Classic Electric Torque Wrench Pump

- The Classic has an analog gauge and traditional electro-mechanical components (transformers, relays and switches) in place of solid-state electronics. The Classic delivers durable, safe and efficient hydraulic power.

Pro Series Electric Torque Wrench Pump

- Digital (LCD) display features a built-in hour meter, pressure and torque display, and shows self-diagnostic, cycle-count and low voltage warning information. These premium features are not available on any other pump—anywhere!

AutoCycle feature provides continuous cycle operation of the torque wrench as long as the advance button is pressed. (Pump can be used with or without AutoCycle feature).

ZU4 Series



Reservoir Capacity:

1 and 1.75 gal.

Flow at 10,000 psi:

60 in³/min.

Motor Size:

1.7 hp

Maximum Operating Pressure:

10,000 and 11,600 psi



Torque Wrench Pump Selection Matrix

For optimum speed and performance see the torque wrench pump and hose selection matrix.

Page: 202

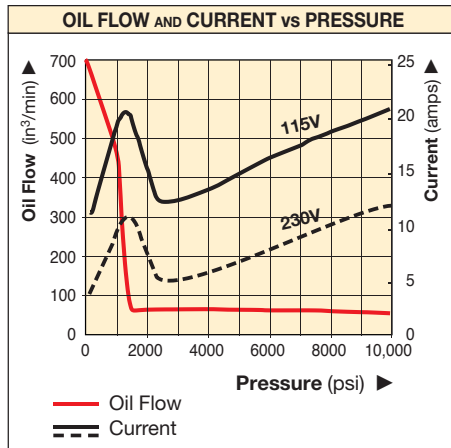

Pump Ratings

-Q suffix pumps are for 10,000 psi torque wrenches, and include spin-on couplers.

-E suffix pumps are for use with 11,600 psi rated torque wrenches, and include polarized lock-ring safety couplers.

Page: 206

COMMON PUMP MODELS

	For Use With Torque Wrenches	Model Number ^{1) 4)}	Motor Electrical Specification	Usable Oil Capacity (gal)	Weight with Oil (lbs)
Pro Series	All wrenches	ZU4204TB-Q	115 V-1 ph	1.0	70
		ZU4208TB-Q	115 V-1 ph	1.75	76
		ZU4204TE-Q ²⁾	208-240 V-1 ph	1.0	70
		ZU4208TE-Q ²⁾	208-240 V-1 ph	1.75	76
		ZU4204TI-Q ³⁾	208-240 V-1 ph	1.0	70
		ZU4208TI-Q ³⁾	208-240 V-1 ph	1.75	76
Classic	All wrenches	ZU4204BB-QH	115 V-1 ph	1.0	82
		ZU4204BB-Q	115 V-1 ph	1.0	73
		ZU4208BE-QH ²⁾	208-240 V-1 ph	1.75	83
		ZU4204BE-Q ²⁾	208-240 V-1 ph	1.0	74
		ZU4208BI-QH	208-240 V-1 ph	1.75	88
		ZU4208BI-Q	208-240 V-1 ph	1.75	79



Gauge and Overlay Kit

Gauge and overlay kits are also available separately. **GT-4015-Q** includes overlays for all S- and W-Series torque wrenches.

- All models meet CE safety requirements and all TÜV requirements
- European plug and CE EMC directive compliant
- With NEMA 6-15 plug
- Select -E suffixed pumps for Enerpac SQD and HXD 11,600 psi torque wrenches

ZU4 Ordering Matrix and Specifications

▼ This is how a ZU4 Series pump model number is built up:

Z U 4 2 08 T E - Q H M

1	2	3	4	5	6	7	8	8	8
Product Type	Motor Type	Flow Group	Valve Type	Reservoir Size	Valve Operation	Voltage	Must be E or Q	Options	Options

1 Product Type

Z = Pump series

2 Motor Type

U = Universal electric motor

3 Flow Group

4 = 60 in³/min @ 10,000 psi

4 Valve Type

2 = Torque wrench valve

5 Reservoir Size (useable capacity)

04 = 1.0 gallon
08 = 1.75 gallons

6 Valve Operation

T = Solenoid valve with pendant, LCD Electric and pressure transducer
B = Solenoid valve with pendant, classic electrical

7 Voltage

B = 115V, 1 ph, 50/60 Hz
E = 208-240V, 1 ph, 50/60 Hz (with European plug CE RF compliant)
I = 208-240V, 1 ph, 50/60 Hz (with NEMA 6-15 plug)

8 Factory installed features and options

E = 11,600 coupler for use with HXD-, SQD-Series or other wrenches
Q = 10,000 coupler for use with S- and W-Series or other wrenches
H = Heat exchanger
K = Skidbar
M = 4-wrench manifold
R = Roll cage

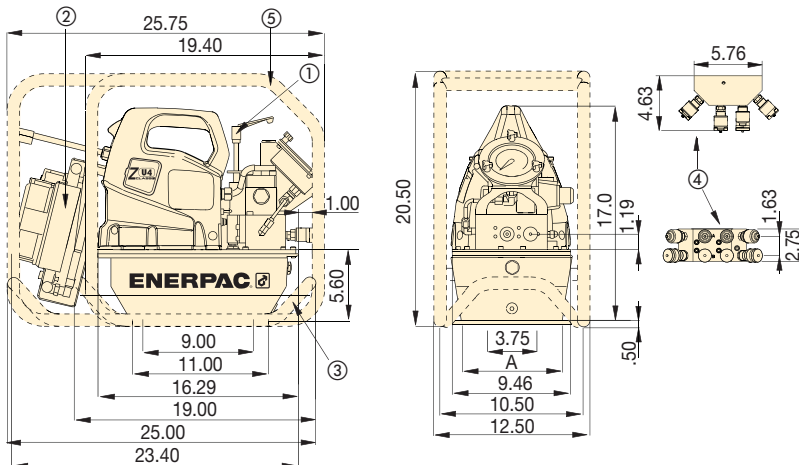

ZU4-Series Torque Wrench Pumps

Reservoir Size (useable gallons)	A (in)
1	6.0
1.75	8.1

Dimensions shown in inches

- ① User adjustable relief valve
- ② Heat exchanger (optional)
- ③ Skidbar (optional)
- ④ 4-wrench manifold (optional)
- ⑤ Roll cage (optional)

ZU4 Performance							
Motor Size (hp)	Output Flow Rate (in ³ /min)				*Motor Electrical Specification	Sound Level (dBA)	Relief Valve Adjustment Range (psi)
	100 psi	700 psi	5,000 psi	10,000 psi			
1.7	700	535	76	60	115 VAC, 1-ph 208-240 VAC, 1-ph	85-90	1,800-10,000**

* 50/60 HZ

** Pump type (-Q) shown, (-E) range is 1,800 - 11,600 psi.



How to order your ZU4-Series torque wrench pump

Ordering Example 1

Model No. ZU4208TB-QMHK
10,000 psi pump for use with Enerpac S- and W-Series and other 10,000 psi torque wrenches, 115V motor, 1.75 gallon reservoir, 4-wrench manifold, heat exchanger and skidbar.

Refer to the torque wrench pump selection matrix for optimum wrench, pump and hose combinations.



Twin Torque Wrench Hoses

Use Enerpac THQ-700 series twin hoses with 10,000 psi pumps, or use THC-700 series twin hoses with 11,600 psi pumps.

10,000 psi	
19.5 feet long, 2 hoses	THQ-706T
39 feet long, 2 hoses	THQ-712T
11,600 psi	
19.5 feet long, 2 hoses	THC-7062
39 feet long, 2 hoses	THC-7122

▼ Most hydraulic torque wrenches can be powered by the Enerpac ZU4-Series torque wrench pump.



ZU4 Torque Wrench Pump Options



Heat Exchanger

- Removes heat from the bypass oil to provide cooler operation
- Stabilizes oil viscosity, increasing oil life and reduces wear of pump and other hydraulic components

Accessory Kit No. *	Can be used with:
ZHE-U115	115V pumps
ZHE-U230	230V pumps

* Add suffix **H** to pump model number for factory installation. Heat Exchanger adds 9.1 lbs. to pump weight.

Ordering Example:

Model No. ZU4208TB-H



Skidbar

- Provides greater pump stability on soft or uneven surfaces
- Provides easy two-handed lift

Accessory Kit No. *	Can be used on ZU4-Series torque wrench pumps
SBZ-4	1 and 1.75 gallon ¹⁾
SBZ-4L	1 and 1.75 gallon ²⁾

* Add suffix **K** to pump model number for factory installation.

¹⁾ Without heat exchanger 4.9 lbs.

²⁾ With heat exchanger 7.0 lbs.

Ordering Example:

Model No. ZU4208TB-QK



Roll Cage

- Protects pump
- Provides greater pump stability

Accessory Kit No. *	Can be used on ZU4-Series torque wrench pumps
ZRC-04	1 and 1.75 gallon reservoir ¹⁾
ZRC-04H	1 and 1.75 gallon reservoir ²⁾

* Add suffix **R** for factory installation.

¹⁾ Without heat exchanger

²⁾ With heat exchanger

Ordering Example:

Model No. ZU4208BB-QR

ZU4 Series



Reservoir Capacity:

1 and 1.75 gal.

Flow at 10,000 psi:

60 in³/min.

Motor Size:

1.7 hp

Maximum Operating Pressure:

10,000 and 11,600 psi



4-Wrench Manifold

- For simultaneous operation of multiple torque wrenches
- Can be factory installed or ordered separately

Accessory Kit No. *	Can be used on ZU4-Series torque wrench pumps
ZTM-E	for 11,600 psi torque wrenches
ZTM-Q	for 10,000 psi torque wrenches

* Add suffix **M** to pump model number for factory installation.

Ordering Example:

Model No. ZU4208TB-QM

▼ Shown: TQ-700E



Lightweight Torque Wrench Pump

- Optimized flow technology delivers up to 50% faster bolting than competing pumps
- Compact and lightweight design fits through tight openings and provides easy handling
- Built-in protection for controls and gauge for job-site durability
- IP55 rating for superior dust and water protection
- Advanced IEC Motor provides for quiet, continuous operation, high voltage tolerance, and low maintenance
- Simple pressure setting and convenient pendant control for hassle-free operation



Optimized for S-Series and W-Series Hydraulic Torque Wrenches

Enerpac offers a complete range of square drive and hexagon cassette torque wrenches.



Pendant Control

The TQ-700 comes equipped with a 20-foot pendant cord which allows the user to pre-saturate the pump from a distance increasing productivity and speed of setup.



Four Port Manifold

The TQ-700 Classic offers an optional four wrench manifold as an accessory (TQM) factory installed. (Add suffix "M" at the end of the model number. For example: TQ700EM) .



Twin Torque Wrench Hoses

Use Enerpac THQ-700 series twin hoses with 10,000 psi pumps.

10,000 psi	
20 feet long, 2 hoses	THQ-706T
40 feet long, 2 hoses	THQ-712T



◀ The TQ-700E and the W-Series wrenches are a productive combination in wind applications.

Electric Torque Pump



TQ-700 Series Pump Applications

The TQ-700 Series pump is ideal for powering hydraulic wrenches for the Power Generation and Wind Markets.

The TQ-700 has been engineered with **Optimized Flow Technology** to deliver up to 50% faster bolt tightening than competing pumps.

Bolting speed is more complex than how much flow per minute the pump produces. The key is optimizing the flow rate across the entire bolting cycle. With more oil flowing at the right time and at the right volume, you achieve

the optimized flow for a hydraulic bolting system. The result of this optimized flow is more bolts tightened faster and a more productive work team.

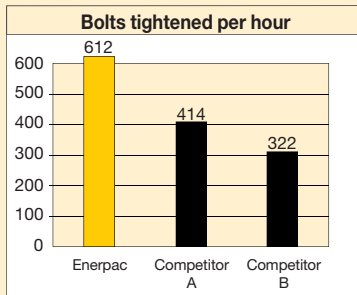

Internal laboratory testing based on standard torquing procedure on a pipe flange with 14, 1 1/8" bolts.

Dimensions shown in inches.

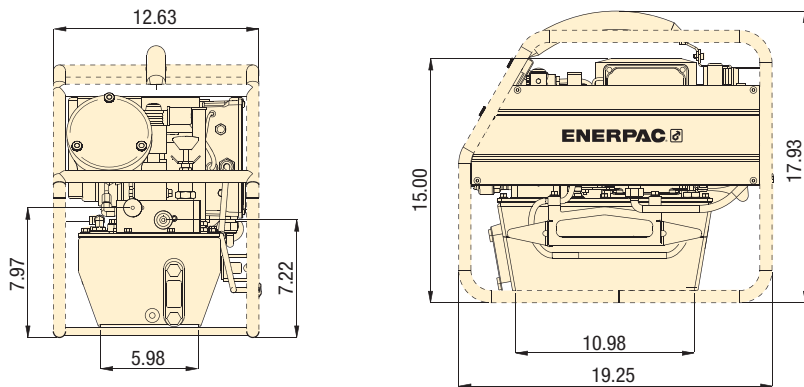

Performance	For Use with Torque Wrenches		Pressure Rating (psi)	Model Number	Motor Electrical Specification	Usable Oil Capacity (gal)	Weight (no oil) (lbs)
Optimal	S1500	W2000	10,000	TQ-700B	115V-1 ph, 60 Hz	1	68
	S3000	W4000					
	S6000	W8000					
Acceptable	S11000	W15000	10,000	TQ-700E	230V-1 ph, 50 Hz	1	66
	S25000	W22000					
		W35000					

TQ Series



Reservoir Capacity:
1 gallon

Maximum Operating Pressure:
10,000 psi



FS-Series Spreaders

FS-Series Flange Spreaders provide quick and easy joint separation using hydraulic or mechanical force.

Page: 224



Nut Splitters / Nut Cutters

Remove rusted or corroded nuts easily with Enerpac Nut Cutters. Hexagon nut capacities up to 5.12 inches.

Page: 221



IP55 Rating for Superior Dust and Water Protection

The IP Code (or Ingress Protection Rating) classifies and rates the degrees of protection provided against the intrusion of solid objects and water in mechanical casings and electrical enclosures.

An IP55 rating means the TQ-700 offers complete protection against contact with mechanical and electrical components, and that dust will not enter in a sufficient quantity to interfere with the operation of the equipment.

The IP55 rating also means water jets sprayed against the TQ-700 from any direction will not have any harmful effects.

▼ Shown: ZE4204TB-QHR



Z Tough.
Dependable.
Innovative.
CLASS



FIRMWARE 7.0

- Display torque in Ft.lb. or Nm
- Display pressure in bar, MPa or psi
- Torque wrench model is selectable
- “Auto cycle” setting easily programmable

- Features *Z-Class* high-efficiency pump design; higher oil flow and bypass pressure, cooler running and requires 18% less current draw than comparable pumps
- Totally enclosed, fan-cooled industrial electric motors supply extended life and stand up to harsh industrial environments
- Low-voltage pendant provides additional safety for the operator
- High-strength, molded electrical enclosure protects electronics, power supplies and LCD readout from harsh environments
- LCD readout provides pressure and torque display and a number of diagnostic and readout capabilities never before offered on a portable electric pump
- Auto cycle feature provides continuous cycle operation of the torque wrench as long as the advance button is pressed (Pump can be used with or without auto cycle feature)
- Valve technology reduces oil operating temperatures and withstands contaminants to increase pump reliability



Back-lit LCD

- Pump usage information, hour and cycle counts
- Low-voltage warning and recording
- Self-test and diagnostic capabilities
- Information can be displayed in English, French, German, Italian, Spanish and Portuguese
- Pressure transducer is more accurate and durable than analog gauges

▼ The ZE4 torque wrench pumps are perfectly matched for this W2000 wrench.



ZE Series Electric Torque Wrench Pumps

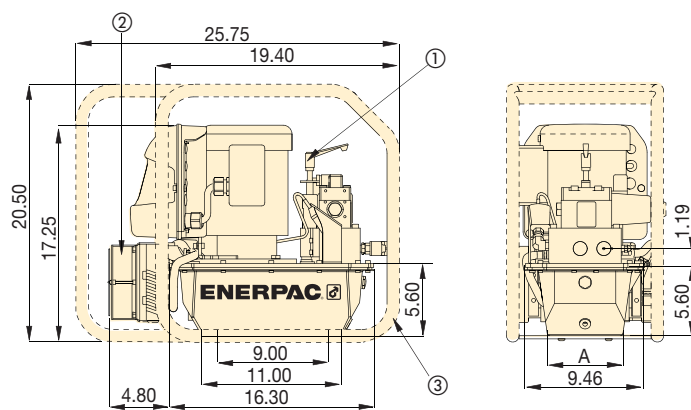
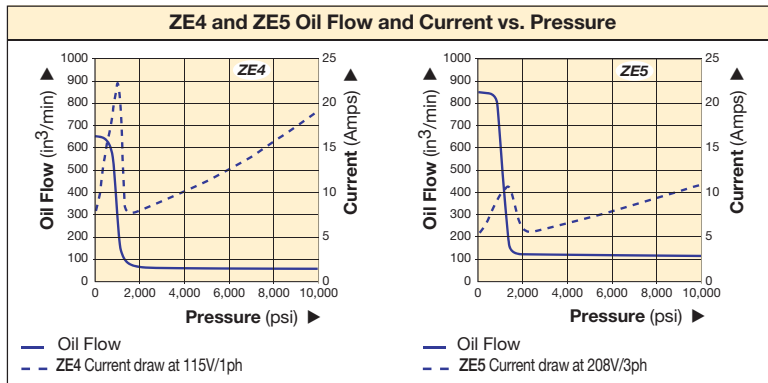

Reservoir Size (useable gallons)	A (in)
1	6.0
1.75	8.1

Dimensions shown in inches.

- ① User adjustable relief valve
- ② Heat Exchanger (optional)
- ③ Roll cage (optional)

ZE Series



Reservoir Capacity:

1.0 gal.

Flow at 10,000 psi:

60-120 in³/min.

Motor Size:

1.5-3.0 hp

Maximum Operating Pressure:

10,000 psi



All Z-Class electric pumps are TÜV and CE compliant.



Accessory Options

A full list of optional accessories can be found in the ZU4 section.

Page: 207

▼ COMMON PUMP MODELS

For Use With Torque Wrenches	Max. Operating Pressure (psi)	Model Number	Motor Electrical Specification	Usable Oil Capacity ¹⁾ (gal)	Weight with Oil (lbs)
All S- and W-Series Wrenches	10,000	ZE4204TB-QHR	115 V-1 ph	1	129
	10,000	ZE4204TE-QHR	230 V-1 ph	1	129
	10,000	ZE4204TG-QHR	230 V-3 ph	1	131
	10,000	ZE5204TW-QHR	400 V-3 ph	1	131

¹⁾ Larger reservoirs (2, 2.5, 5, 10 gallon) are available. Contact Enerpac.

▼ PERFORMANCE CHART

Pump Series	Output Flow Rate (in ³ /min)				Motor Size		Relief Valve Adjustment Range (psi)	Sound Level (dBA)
	100 psi	700 psi	5,000 psi	10,000 psi	hp	RPM		
ZE4	650	600	62	60	1.5	1750	1000 - 11,600	75
ZE5	850	825	123	120	3.0	1750	1000 - 11,600	75

Flow rate will be approximately 5/6 of these values at 50 Hz.

▼ Shown: PTA-1404



Two-Stage Power in a Portable Design

- Compact and portable
- Handle located directly over pump's center of gravity for greater ease in carrying
- High bypass (1800 psi) for faster torque cycles
- High power-to-weight ratio suits all Enerpac torque wrenches
- Glycerine filled pressure gauge with scales reading in psi/bar
- Transparent overlays in Ft.lbs and Nm for all Enerpac torque wrenches provide a quick torque reference
- Internal safety relief valve, factory preset
- 15 ft. air pendant assembly enables easy maneuvering at the job site



Pump Ratings

-Q suffix pumps are for 10,000 psi torque wrenches, and include spin-on couplers.

-E suffix pumps are for use with 11,600 psi rated torque wrenches, and include polarized lock-ring safety couplers.



Twin Torque Wrench Hoses

Use Enerpac THQ-700 series twin hoses with 10,000 psi pumps, or use THC-700 series twin hoses with 11,600 psi pumps.

10,000 psi	
19.5 feet long, 2 hoses	THQ-706T
39 feet long, 2 hoses	THQ-712T
11,600 psi	
19.5 feet long, 2 hoses	THC-7062
39 feet long, 2 hoses	THC-7122



Gauge Overlay Kit

Gauge overlay kits are also available separately.

GT-4015-Q includes overlays for all S- and

W-Series torque wrenches.

Compact Pneumatic Torque Wrench Pump

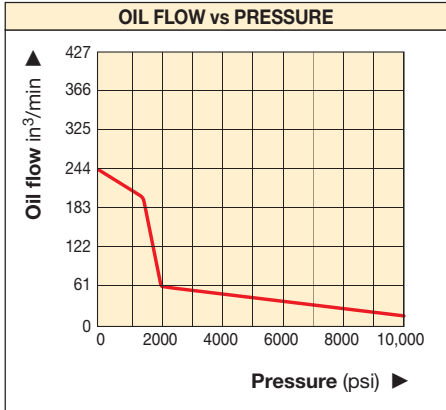

Dimensions shown in inches.

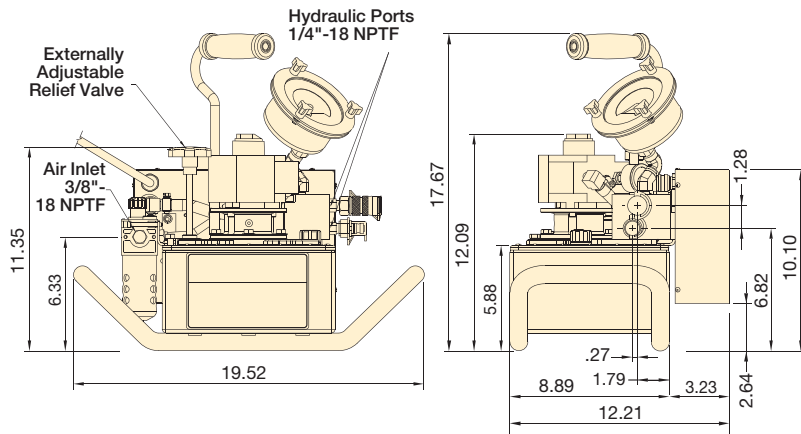
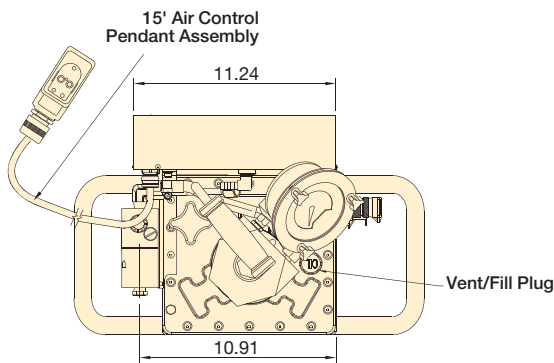

PTA Series



Reservoir Capacity:
1 gal.

Flow at 10,000 psi:
20 in³/min.

Maximum Operating Pressure:
10,000 and 11,600 psi



Torque Wrench Pump Selection Matrix

For optimum speed and performance see the torque wrench pump and hose selection matrix.

Page: 204

▼ SELECTION CHART

For Use With Torque Wrenches		Pressure Rating (psi)	Model Number	Reservoir Capacity (gal)	Useable Oil Capacity (gal)	Pump Flow Rates (in ³)		Air Consumption @ 100 psi (scfm)	Air Pressure Range (psi)	Weight with Oil (lbs)
						1 st stage	2 nd stage			
S1500 S3000	W2000 W4000	10,000	PTA-1404-Q	1.0	0.5	240	20	40	49-101	54
SQD-25-I SQD-50-I	HXD-30 HXD-60	11,600	PTA-1404	1.0	0.5	240	20	40	49-101	54

ZA4 Air Driven Torque Wrench Pumps

▼ Shown: ZA4204TX-QR



- Features **Z-Class** high-efficiency pump design; higher oil flow and bypass pressure
- Two-speed operation and high by-pass pressure reduces cycle time for improved productivity
- Heat exchanger warms exhaust air to prevent freezing and cools the oil
- Ergonomic pendant allows remote operation up to 20 feet
- Glycerin filled pressure gauge with transparent overlays in Ft.lbs and Nm for Enerpac torque wrenches provide a quick torque reference
- Regulator-Filter-Lubricator with removable bowls and auto drain is standard
- Valve technology reduces oil operating temperatures and withstands contaminants to increase pump reliability

Z Tough.
Dependable.
Innovative.
CLASS



Pump Ratings

-Q suffix pumps are for 10,000 psi torque wrenches, and include spin-on couplers.

-E suffix pumps are for use with 11,600 psi rated torque wrenches, and include polarized lock-ring safety couplers.



Twin Torque Wrench Hoses

Use Enerpac THQ-700 series twin hoses with 10,000 psi pumps, or use THC-700 series twin hoses with 11,600 psi pumps.

10,000 psi	
19.5 feet long, 2 hoses	THQ-706T
39 feet long, 2 hoses	THQ-712T
11,600 psi	
19.5 feet long, 2 hoses	THC-7062
39 feet long, 2 hoses	THC-7122



◀ Most hydraulic torque wrenches can be powered by the Enerpac ZA4-Series torque wrench pump.

ZA4 Specifications



ZA4-Series Pump Applications

The ZA4-Series pump is best suited to power medium to large size torque wrenches.

Patent-pending *Z-Class* technology provides high by-pass pressures for increased productivity. Its high

power-to-weight ratio and compact design make it ideal for applications which require easy transport of the pump.

For further application assistance contact your local Enerpac office.

ZA4 Series



Reservoir Capacity:
1 and 1.75 gal.

Flow at 10,000 psi:
60 in³/min.

Maximum Operating Pressure:
10,000 and 11,600 psi

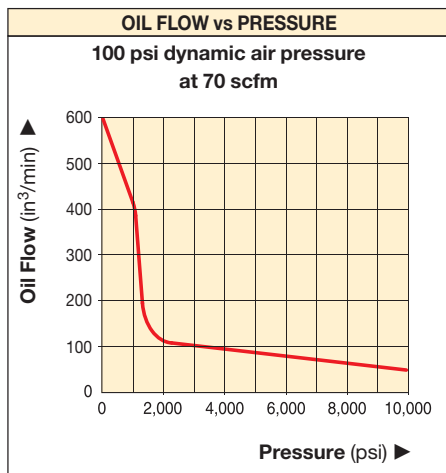

ATEX Certified

The ZA-series pumps are tested and certified according to the Equipment Directive 94 / 9 / EC "ATEX Directive". The explosion protection is for equipment group II, equipment category 2 (hazardous area zone 1), in gas and/or dust atmospheres. The ZA-series pumps are marked with: Ex II 2 GD ck T4.



▼ COMMON PUMP MODELS

For Use With Torque Wrenches	Maximum Operating Pressure (psi)	Model Number 1)	Usable Oil Capacity (gal)	Weight with Oil (lbs)
For all S- and W- Series	10,000	ZA4204TX-Q	1.0	94
	10,000	ZA4208TX-Q	1.75	100
	10,000	ZA4204TX-QR	1.0	101
For all SQD- and HXD-Series	11,600	ZA4204TX-E	1.0	94
	11,600	ZA4208TX-E	1.75	100
	11,600	ZA4204TX-ER	1.0	101

1) All models meet CE safety requirements and all TÜV requirements.

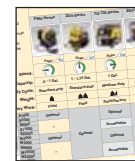

Torque Wrench Pump Selection Matrix

For optimum speed and performance see the torque wrench, pump and hose selection matrix.

Page: 202



Accessory Options

Available by placing the following additional suffix at the end of the model number:

- K** = Skidbar
- M** = 4-wrench manifold
- R** = Roll cage

Page: 217

ZA4T Ordering Matrix and Specifications

▼ This is how a ZA4-Series pump model number is built up:

Z A 4 2 08 T X - Q M R

1 Product Type 2 Motor Type 3 Flow Group 4 Valve Type 5 Reservoir Size 6 Valve Operation 7 Voltage 8 Must be E or Q 8 Options 8 Options

1 Product Type

Z = Pump Series

2 Motor Type

A = Air motor

3 Flow Group

4 = 60 in³/min @ 10,000 psi

4 Valve Type

2 = Torque Wrench Valve

5 Reservoir Size (useable capacity)

04 = 1.0 gallon
08 = 1.75 gallons

6 Valve Operation

T = Air operated valve with pendant

7 Voltage

X = Not applicable

8 Factory installed features and options

E = 11,600 psi coupler for use with HXD- and SQD-Series wrenches
Q = 10,000 psi coupler for use with S- and W-Series or other wrenches
K = Skidbar
M = 4-wrench manifold
R = Roll cage



How to order your ZA4-Series torque wrench pump

Ordering Example 1

Model No. ZA4208TX-QMR

10,000 psi pump for use with Enerpac S- and W-Series and other 10,000 psi torque wrenches, 1.75 gallon reservoir, 4-wrench manifold, and roll cage.

Refer to the torque wrench pump selection matrix for optimum wrench, pump and hose combinations.

Dimensions shown in inches.

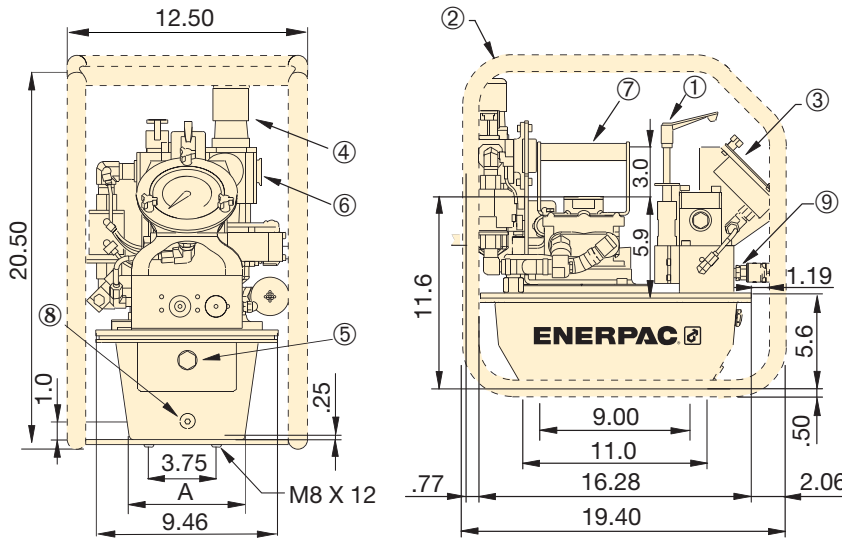

ZA4-Series Torque Wrench Pumps

Reservoir Size (useable gallons)	A (in)
1	6.0
1.75	8.1

- ① User adjustable relief valve
- ② Roll bar cage (optional)
- ③ Gauge with overlays
- ④ Filter/lubricator/regulator
- ⑤ Oil level sight gauge
- ⑥ Air input 1/2" NPTF
- ⑦ Standard handle
- ⑧ Oil drain
- ⑨ 1/4"-18 NPTF Oil Outlet

Output Flow Rate					Dynamic Air Pressure Range	Air Consumption	Sound Level at 100 psi Dynamic	Relief Valve Adjustment Range
(in ³ /min)								
100 psi	700 psi	5,000 psi	10,000 psi	11,600 psi	(psi)	(scfm)	(dBA)	(psi)
600	500	80	60	55	60-100	20-100	80-95	1,400-10,000*

* Pump type (-Q) shown.

ZA4 Torque Wrench Pump Options



Skidbar

- Provides greater pump stability on soft or uneven surfaces
- Provides two-handed lift

Accessory Kit No. *	Can be used on ZA4-Series torque wrench pumps
SBZ-4	1 and 1.75 gallon reservoir

* Add suffix **K** for factory installation. Skidbar weight 4.9 lbs.

Ordering Example:

Model No. ZA4208TX-QK



4-Wrench Manifold

- For simultaneous operation of multiple torque wrenches
- Can be factory installed or ordered separately

Accessory Kit No. *	Can be used on ZA4-Series torque wrench pumps
ZTM-E	for 11,600 psi torque wrenches
ZTM-Q	for 10,000 psi torque wrenches

* Add suffix **M** for factory installation.

Ordering Example:

Model No. ZA4208TX-QM

ZA4 Series



Reservoir Capacity:

1 and 1.75 gal.

Flow at 10,000 psi:

60 in³/min.

Maximum Operating Pressure:

10,000 and 11,600 psi



Gauge and Overlay Kit

Gauge and overlay kits are also available separately.

GT-4015 includes overlays for all SQD and HXD torque wrenches. **GT-4015-Q**

includes overlays for all S- and W-Series torque wrenches.



Roll Cage

- Protects pump
- Provides greater pump stability

Accessory Kit No. *	Can be used on ZA4-Series torque wrench pumps
ZRC-04	1 and 1.75 gallon reservoir

* Add suffix **R** for factory installation. Roll bar cage weight 7.5 lbs.

Ordering Example:

Model No. ZA4208TX-QR



Twin Torque Wrench Hoses

Use Enerpac THQ-700 series twin hoses with 10,000 psi pumps, or use THC-700 series twin hoses with 11,600 psi pumps.

10,000 psi	
19.5 feet long, 2 hoses	THQ-706T
39 feet long, 2 hoses	THQ-712T
11,600 psi	
19.5 feet long, 2 hoses	THC-7062
39 feet long, 2 hoses	THC-7122

▼ Shown: ZUTP-1500B



- High efficiency Universal Motor draws lower amps for superior performance in remote locations with low power quality
- Two-stage pump design provides high flow at low pressure for fast system fills and controlled flow at high pressure for safe and accurate operation
- Compact and lightweight design fits through tight openings and provides easy handling
- Panel mounted 6" pressure gauge, with polycarbonate cover, is set into the protective metal shroud for improved visibility and safety
- Panel mounted user adjustable valve for safe and precise pressure control
- Safety relief valve limits output pressure

Reliability, Power and Precision



Applications

The Enerpac ZUTP-Series electric pump is ideally suited for use with hydraulic bolt tensioning tools and hydraulic nuts.



Bolting Integrity Software

Visit www.enerpac.com to access our free on-line bolting software application and obtain information on tool selection, bolt load calculations and tool pressure settings. A combined application data sheet and joint completion report is also available.



Bolting Theory

See our "Yellow Pages" for information on torque tightening and tensioning.

Page: 220



◀ The ZUTP-1500 pump is rugged, lightweight, compact for tight openings, and delivers hassle-free operation of bolt tensioning in remote locations with up to two times the speed of competitive pumps.

ZUTP-Series, Electric Tensioning Pump



ZUTP Series Manual Valve

The ZUTP1500 series with manual valve provides higher flow rates than air-driven tensioner pumps for a fast and economic solution ideal for bolt tensioning applications not requiring single-person operation.

ZUTP Series



Reservoir Capacity:

1 gallon

Flow at Rated Pressure:

8.0 in³/min.

Maximum Operating Pressure:

21,750 psi

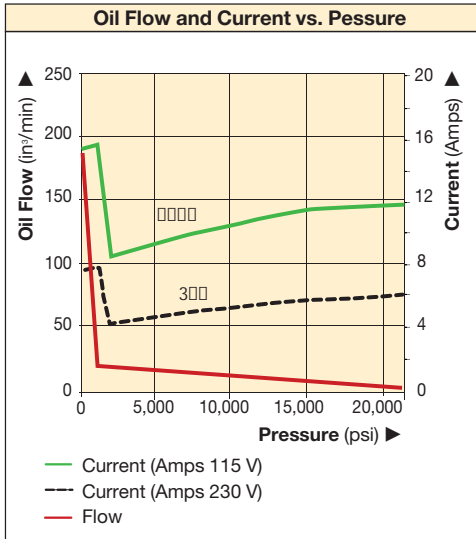

This pump operates at ultra-high pressure, use only the specified fittings and hoses designed for these pressures.

Page: 220

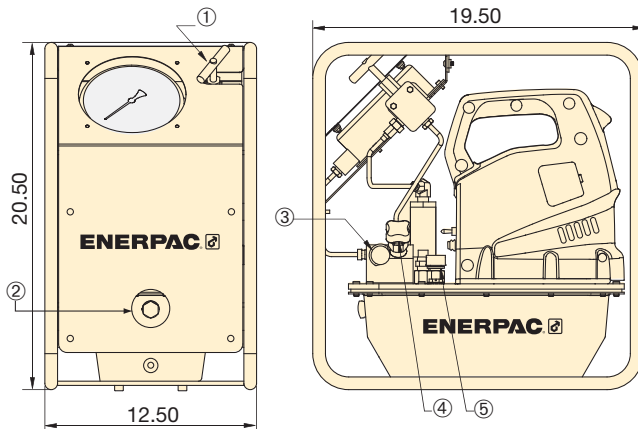

- ① Release Valve
- ② Sight Glass
- ③ 1/4" BSPM Outlet Port
- ④ User Adjustable Pressure Control Valve
- ⑤ Breather

21,750 PSI HIGH PRESSURE PUMP

Pump Type	Useable Oil Capacity (gal)	Valve Type	Model Number ¹⁾	Output Flow Rate at 0 psi (in ³ /min)	Output Flow Rate at 21,750 psi (in ³ /min)	Motor Electrical Specification	Sound Level (dBA)	Weight with oil (lbs)
High pressure	1.0	Manual	ZUTP-1500B	180	8	115 VAC, 1-ph	89	65
			ZUTP-1500E ²⁾			230 VAC, 1-ph		
			ZUTP-1500I ³⁾			230 VAC, 1-ph		

¹⁾ All models meet CE safety requirements and all TÜV requirements.

²⁾ European plug and CE EMC directive compliant.

³⁾ With NEMA 6-15 plug.

⁴⁾ Add suffix "H" for factory installation of Heat Exchanger.

ATP-Series Air Pump

▼ Shown: ATP-1500



ATP Series

Reservoir Capacity:
1.0 gallon

Flow at Rated Pressure:
4 in³/min.

Maximum Operating Pressure:
21,750 psi



These products operate at ultra-high pressure, use only the specified fittings and hoses designed for these pressures.

- General purpose, high pressure air driven pump unit for products requiring up to 21,750 psi hydraulic pressure
- Compact, lightweight, rugged steel frame for protection and easy handling
- Pre-lubricated pump element, does not require an airline lubricator
- Easily adjustable output pressure control
- Integrated and protected easy to read glycerin filled gauge
- Safety relief valve limits output pressure
- ATEX Certified.*

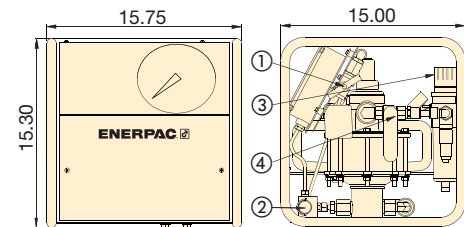
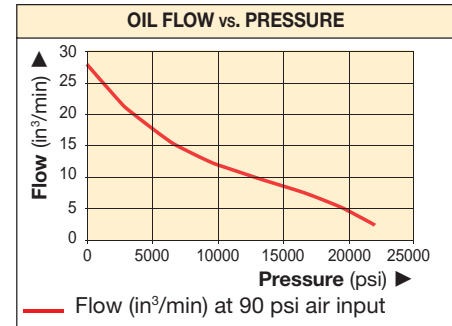

- ① HPT Shut-off Valve
- ② 1/4" BSPP HPT Out Port
- ③ Filter/Regulator
- ④ Air On/Off Valve

Ex II 2 GD ck T4 See explanation of ATEX Certification in "Yellow Pages."
IBExU

▼ HOSES

Model Number	End 1	End 2	Length (ft)
HT-1503	1/4 BSPM 120° Cone	1/4 BSPM 120° Cone	3.28
HT-1510	1/4 BSPM 120° Cone	1/4 BSPM 120° Cone	9.84
HT-1503HR*	BH150	BR150	3.28
HT-1510HR*	BH150	BR150	9.84

* Includes dust caps

▼ FITTINGS

Description	Complete Set	Female Half	Male Half
Quick Disconnect Coupler*	B150	BR150	BH150
Quick Disconnect Coupler and Adaptor Kit*	BW150AW	—	—
Quick Disconnect Blanking Coupler Set*	B150B	—	—

* Includes dust caps

Pump Type	Useable Oil Capacity (gal)	Model Number	Pressure Rating (psi)	Output Flow Rate at 0 psi (in ³ /min)	Output Flow Rate at 21,750 psi (in ³ /min)	Air Pressure Range (psi)	Air Consumption (scfm)	Sound Level (dBA)	Weight (lbs)
High pressure	1.0	ATP-1500	21,750	26	4	80-90	70	70	65

Hydraulic Nut Cutters

▼ Shown from left to right: **NC-3241, NC-1319, NC-1924**



NC Series



Capacity:
5-90 tons

Hexagon Nut Range:
0.5-2.88 inches

Maximum Operating Pressure:
10,000 psi



Enerpac Nut Cutters

Nut Cutters include a spare chisel, a spare set screw and the wrench used to secure the chisel. A CR-400 coupler is standard.

- Compact and ergonomic design, easy to use
- Unique angled head allows flush access
- Single-acting, spring return cylinder
- Heavy-duty chisels can be reground
- Applications include servicing trucks, piping industry, tank cleaning, petrochemical, steel construction and mining

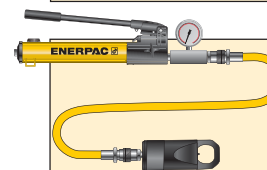

Nut Cutter Sets

Hydraulic Nut Cutters are available as sets (pump, tool, gauge, adaptor and hose).

Set Model Number	Splitter Model Number	Pump Model Number
STN-1924H	NC-1924	P-392
STN-2432H	NC-2432	P-392
STN-3241H	NC-3241	P-392



◀ Easily removing rusty nuts during railroad construction is just one of many application examples for the Enerpac Nut Cutters.

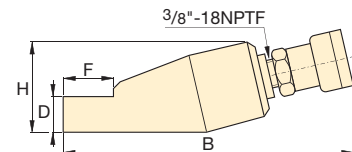
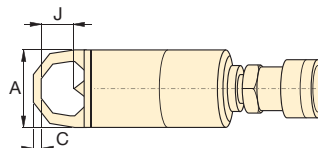

Hexagon Nut Range (in)	Bolt Range (in)	Capacity (ton)	Oil Capacity (in ³)	Model Number	Dimensions (in)							Weight (lbs)	Replacement Chisel Model Number
					A	B	C	D	F	H	J		
.50-.75	.31-.50	5	.92	NC-1319	1.57	7.87	.24	.75	1.10	1.89	.83	1.8	NCB-1319
.75-.94	.50-.63	10	1.22	NC-1924*	2.17	8.94	.32	.98	1.50	2.80	1.00	4.4	NCB-1924
.94-1.13	.63-.88	15	3.66	NC-2432*	2.60	10.24	.39	1.22	1.93	2.99	1.30	6.6	NCB-2432
1.13-1.56	.88-1.13	20	4.88	NC-3241*	2.95	11.26	.59	1.38	2.60	3.50	1.69	9.7	NCB-3241
1.56-2.00	1.13-1.38	35	9.46	NC-4150	3.78	12.80	.83	1.77	2.87	4.29	2.13	18.0	NCB-4150
2.00-2.25	1.38-1.50	50	14.64	NC-5060	4.17	14.41	1.06	2.13	3.63	4.96	2.38	26.0	NCB-5060
2.38-2.88	1.50-1.88	90	30.00	NC-6075	6.14	14.43	1.06	2.95	4.33	7.09	3.07	75.1	NCB-6075

Ordering Notes: Maximum allowable hardness to split is HRc-44. Not to be used on square nuts. Larger sizes available upon request.

* Available as Tool-Pump set, see note on this page.

▼ Shown: NS-7080, NS-70105



- Specially designed to suit standard ANSI B16.5 / BS1560 flanges
- Single-acting, spring return cylinder
- Tri-blade technology provides three cutting surfaces on a single blade
- Interchangeable heads provide maximum nut range flexibility
- Preset scale allows controlled blade extension, which avoids damage to bolt threads
- Grip tape and handle included for more secure maneuverability
- Nickel-plated cylinder body for excellent corrosion protection and improved durability in harsh environments
- Internal Pressure Relief Valve for overload protection



◀ Heavily corroded and weathered nuts are quickly split and removed using an NS-Series Nut Splitter.

Power and Precision

High Performance Nut Splitter



Blade Cutting Depth Scale

Adjustable cutting depth scale for controlled blade extension, which avoids damage to bolt threads.

The scale indicates the bolt range in metric and imperial values on each cutting head.



Hydraulic Nut Cutters

The NC-Series models are available featuring an angle-head design for 0.50"-2.88" hexagon nuts.

Page: 221



FS-Series Spreaders

FS-Series Flange Spreaders provide quick and easy joint separation using hydraulic or mechanical force.

Page: 224



ATM Flange Alignment Tools

The ATM series provides safe high-precision flange alignment tools that fit most commonly used ANSI, API, BS, and DIN flanges.

Page: 226

Hydraulic Nut Splitters



Nut Splitter Sets

To provide maximum flexibility, NS-Series Nut Splitters can also be ordered in sets (NS-xxxSy).

Select Nut Splitter size and pump style from the chart below.

To order additional Cutting Heads (NSH-xxxxxx), Cylinders (NSC-xxx) or Replacement Blades (NSB-xxx), see Selection Chart below.

SET SELECTION:

- 1 Select your Nut Splitter
- 2 Select your pump type

NS Series



Capacity:

103.2-192.5 tons

Hexagon Nut Range:

2.75-5.38 inches

Maximum Operating Pressure:

10,000 psi

Set Model Number	Nut Splitter Model Number	Pump Options			Accessories Included			
		Hand Pump Model No.	Air Pump Model No.	Electric Pump Model No.	Gauge Adaptor Model No.	Gauge Model No.	Hose Model No.	Storage Case Model No.
NS-70105SH	NS-70105	P392	-	-	GA-2	GP-10S	HC-7206	CM-4
NS-70105SA	NS-70105	-	XA-11G	-	-	integrated*	HC-7206	CM-4
NS-70105SE	NS-70105	-	-	PUD-1100B	GA-2	GP-10S	HC-7206	CM-7
NS-110130SH	NS-110130	P802	-	-	GA-2	GP-10S	HC-7206	CM-4
NS-110130SA	NS-110130	-	XA-11G	-	-	integrated*	HC-7206	CM-4
NS-110130SE	NS-110130	-	-	PUD-1100B	GA-2	GP-10S	HC-7206	CM-7

*XA-11G air pump features an integrated pressure gauge.

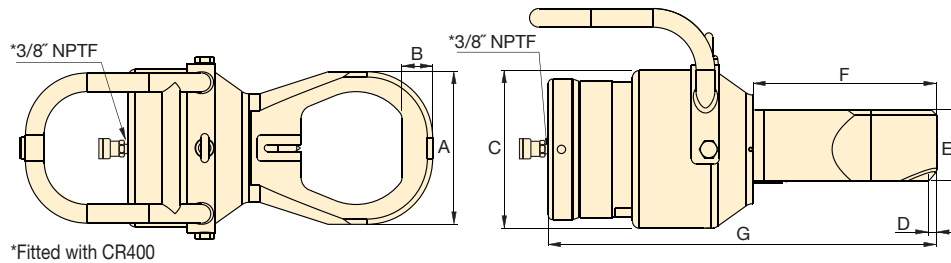

SELECTION CHART

Hexagon Nut Range** (in)	Bolt Range (in)	Cap. (ton)	Oil Cap. (in ³)	Model Number*	Dimensions (in)							Weight (lbs)	NS Cylinder	NS Cutting Head	Replacement Blade
					A	B	C	D	E	F	G				
2.75-3.13	1.75-2.00	103.2	23.0	NS-7080	5.2	1.1	7.1	0.3	3.2	7.3	16.2	81.4	NSC-70	NSH-7080	NSB-70
2.75-3.50	1.75-2.25	103.2	23.0	NS-7085	5.7	1.2	7.1	0.3	3.2	7.7	16.6	82.7	NSC-70	NSH-7085	NSB-70
2.75-3.88	1.75-2.50	103.2	23.0	NS-7095	6.3	1.3	7.1	0.3	3.2	7.9	17	84.9	NSC-70	NSH-7095	NSB-70
2.75-4.25	1.75-2.75	103.2	23.0	NS-70105	6.9	1.4	7.1	0.4	3.2	8.2	17.5	87.1	NSC-70	NSH-70105	NSB-70
4.25-4.63	2.75-3.00	192.5	50.0	NS-110115	7.4	1.4	9.2	0.1	4.4	9.2	18.6	151.6	NSC-110	NSH-110115	NSB-110
4.25-5.38	2.75-3.50	192.5	50.0	NS-110130	8.6	1.6	9.2	0.1	4.4	9.5	19.4	158.3	NSC-110	NSH-110130	NSB-110

* NS-Series Nut Splitters ship in two cases: One containing the NSC Cylinder and one containing the NSH Cutting Head. Assembly required.

** Maximum allowable hardness to split is HRC-44.

Pin Type Hydraulic Flange Spreaders

▼ Shown: FS-56



- Lightweight, ergonomic design for ease of use
- Adjustable jaw widths from 2.75" to 8.50" for a wide range of applications
- Single-acting, spring return RC Series cylinders for fast trouble-free operation

FS Series



Capacity:
5-10 tons

Maximum Operating Pressure:
10,000 psi

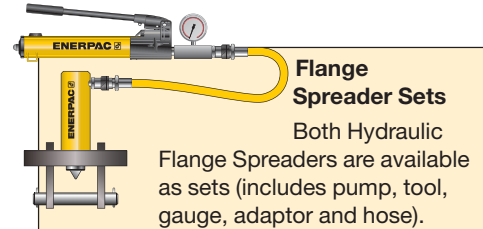

Flange Spreader Sets

Both Hydraulic Flange Spreaders are available as sets (includes pump, gauge, adaptor and hose).

Set Model Number	Spreader Model Number	Pump Model Number
STF-56H	FS-56	P-392
STF-109H	FS-109	P-392
STF-109A	FS-109	PATG-1102N



Wedge Spreaders

Friction-free, smooth and parallel wedge movement with unique interlock wedge design. Eliminates flange damage and risk of spreading arm failure.

Page: 225

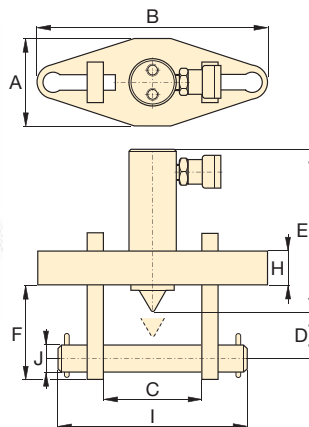
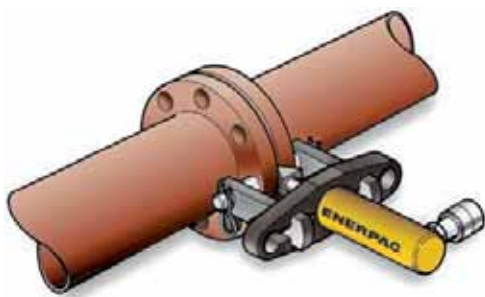

Flange Spreader Matching Chart

ASA Rating (psi)	Pipe Size (in)	
	FS-56	FS-109
150	5-20	22-42
300	2.50-14	16-28
400	2.50-12	14-24
500	2.50-10	12-20
900	.50-6	8-16
1500	.50-3.50	4-8
2500	.50-2.50	3-4

Maximum Flange Thickness (in)	Stud Size (in)	Standard Wedge (in)	Cap. (ton)	Stroke (in)	Oil Cap. (in ³)	Model Number	Dimensions (in)										Weight (lbs)
							A	B	C		D	E	F	H	I	J	
									Min.	Max.							
2 x 2.25	.75-1.13	.13-1.13	5	1.50	1.50	FS-56	3.00	8.25	2.75	6.10	1.28	7.71	3.45	1.00	8.10	.75	26
2 x 3.63	1.25-1.63	.13-1.13	10	2.13	4.80	FS-109	4.25	11.00	4.10	8.50	1.98	6.00	4.50	1.50	10.75	1.25	40

Hydraulic and Mechanical Industrial Spreaders

▼ Shown: FSH-14 and FSM-8 with safety blocks SB1



FSM/FSH Series

Tip Clearance / Maximum Spread*:
0.24/3.16 inches

Maximum Spread Force:
8-14 tons

Maximum Operating Pressure:
10,000 psi (FSH-14)



Stepped Blocks FSB-1

Use this pair of stepped blocks to increase wedge opening up to 3.16 in. (81 mm). Fits both FSH-14 and FSM-8.

- **Integrated wedge concept:** friction-free, smooth, parallel wedge movement eliminates flange damage and spreading arm failure
- **Unique interlocking wedge design:** no first step bending and risk of slipping out of joint
- **Requires very small access gap of only .24 in. (6 mm)**
- **Stepped spreader arm design:** each step can spread under full load
- **Few moving parts means durability and low maintenance**
- **Safety block SB-1 and ratchet spanner SW-22 included with FSM-8**
- **Safety block and Enerpac RC-102 cylinder included with FSH-14**

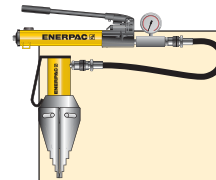

Flange Spreader Sets

Hydraulic FSH-14 is available as a set (pump, tool, gauge, adaptor and hose).

Set Model Number	Set Includes:	
STF-14H	FSH-14	GA-2
	P-392	GP-10S
	HC-7206	-

▼ Two FSH-14 spreaders used simultaneously with Enerpac handpump, hoses and AM-21 split-flow manifold.

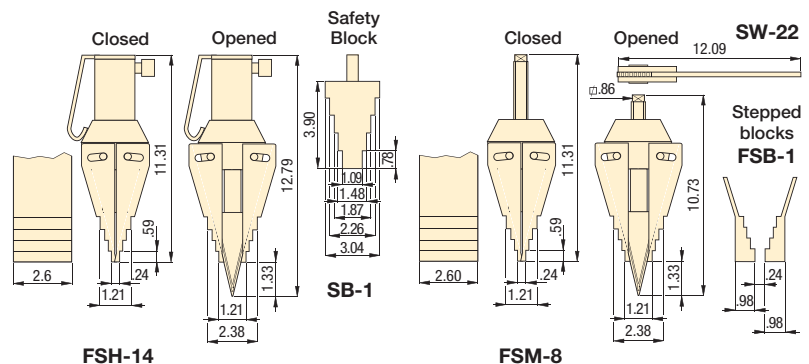

Max. Spreading Force (ton)	Model Number	Tip Clearance (in)	Max. Spread* (in)	Type	Oil Capacity (in ³)	Weight (lbs)
8	FSM-8	.24	3.16	Mechanical	-	14.3
14	FSH-14	.24	3.16	Hydraulic	4.76	15.7

* Using stepped blocks FSB-1.

ATM-Series, Flange Alignment Tools

▼ From left to right: ATM-4, ATM-9, ATM-2



- Enerpac ATM-Series tools rectify twist and rotational misalignment quickly, safely, and without the need for an external power source
- Appropriate for use on most ANSI, API, BS and DIN flanges
- No slings, hooks or lifting gear required
- Can be installed and used in any position (horizontally or vertically)
- Portable, lightweight design enables easy transport and use, even in remote locations

ATM Series

Minimum Bolt Size:

.63-1.24 inches

Flange Wall Thickness:

.55-9.00 inches

Maximum Lifting Force:

1-10 tons



Adjustable Reach

The highly adjustable reach of the wing and drop leg on the **ATM-4** and **ATM-9** allows precise alignment.



ATM-9 Hydraulics

Includes cylinder, P-142 two-speed hand pump and 6-ft long hose (HC-7206C).

All dimensions shown in inches.

ATM-2

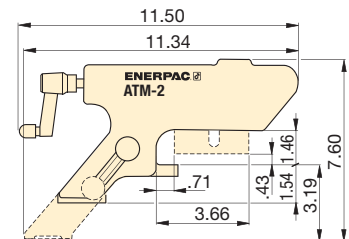

ATM-4

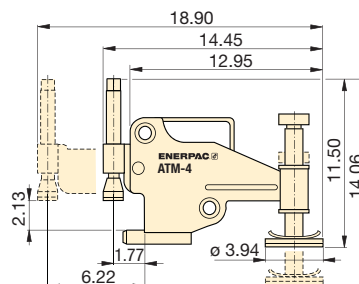

ATM-9

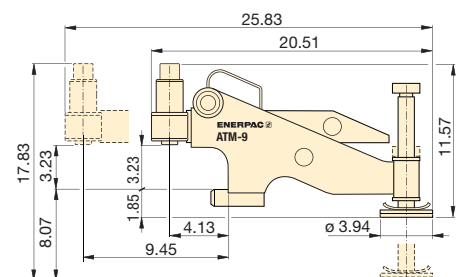

▼ The compact ATM-2 is actuated by simply hand turning the crank.



Maximum Lifting Force (ton)* (kN)*	Model Number	Minimum Bolt Size**		Flange Wall Thickness (max)		Weight (lbs)	
		(in)	(mm)	(in)	(mm)		
1	10	ATM-2	.63	16	.55 - 3.29	14 - 82	3.5
4	40	ATM-4	.95	24	1.18 - 5.23	30 - 133	19
10	90	ATM-9**	1.24	31,5	3.66 - 9.00	93 - 228	32

* At 10,000 psi maximum operating pressure.

** ATM-9 includes an Enerpac hand pump and hydraulic hose (gauge and adaptor sold separately). ATM-9 weight includes tool only.

FF-Series, Mechanical Flange Face Tool

▼ Shown: FF-120



- Refacing made easy — hand-operated machine tool can be set up anywhere without the need for air, electric or hydraulic power support
- Lightweight and portable — easily transported to remote locations for increased productivity
- Adjustable cutting range for flange diameters between 1-12 inches [25,4-304,8 mm]
- Interchangeable collets for ID mounting range from 1-6 inches allowing the user to work on many different flanges with minimal time between set-ups
- Interchangeable lead screws suitable for refacing damaged raised-face (RF), flat-face (FF) or lens-ring joint flanges
- Tool body with expanding collets centers itself providing real concentric operation

Dimensions shown in inches.

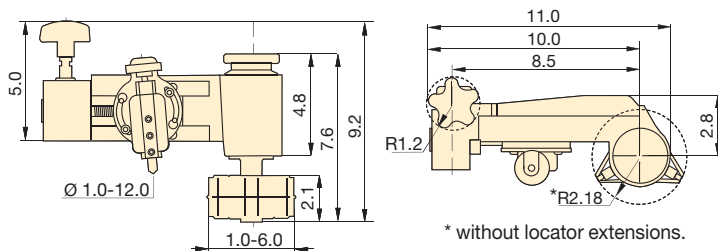

▼ TOOL SELECTION CHART

Pipe Flange Cutting Diameter Range		Internal Pipe Mounting Diameter Range		Average Roughness (Ra)		Model Number	Wt. (lbs)
(in)	(mm)	(in)	(mm)	(μ in)	(μ m)		
1.0 - 12.0	25,4 - 304,8	1.0 - 6.0	25,4 - 152,4	125-250	3,18-6,35	FF-120	15
				60-100*	1,52-2,54*		

* When using fine thread feed screw, FF120FSF.

FF Series

Pipe Flange Cutting Diameter Range:

1-12 in (25,4-304,8 mm)

Internal Pipe Mounting Diameter Range:

1-6 in (25,4-152,4 mm)

Average Roughness:

125-250 μ in (3,18-6,35) μ m



Joint Separation Tools

FS and FSH-Series parallel wedge spreaders provide quick and easy joint separation using hydraulic or mechanical force.

224



Joint Assembly Tools

Rectify twist and rotational alignment without additional stress in pipe lines using the **ATM-Series** flange alignment tools.

Page: 226



Fine Thread Feed Screw

Accessory Kit **FF120FSF** is included as standard and provides a fine thread feed screw, 1/2"-20 UNF, and delivers a Ra of:

60-100 μ in (1,52-2,54 μ m)

▼ The Enerpac FF120 Quick Face has same precision and quality of finish as powered machines.



With more than 50 years supporting industrial markets, Enerpac has gained the unique and in-depth expertise that is respected by industrial professionals around the world. Across every continent, Enerpac's network of application engineers, authorized distributors and technical service centers can reach any location, and deliver innovative solutions, technical assistance and quality products.

Enerpac's complete line of standard and customized products and a unique systems approach offers the benefits of safety and efficiency to applications where high forces are required. Whether constructing a signature bridge across a deep valley, lifting a national landmark for seismic retrofit or simultaneously testing hundreds of foundation pilings to support a new building, Enerpac will supply the high-force solutions to get the job done.







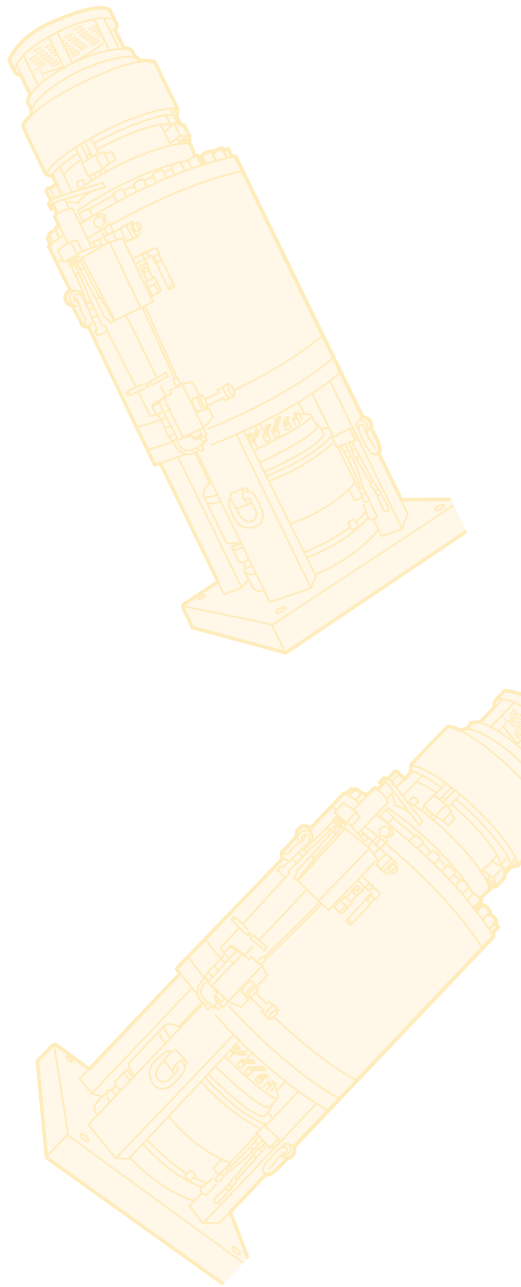

Courtesy of Caltrans



Integrated Solutions Section Overview



Capacity (tons)	Capabilities	Series		Page
67-1200	Hydraulic Gantries	SL SBL MBL		230 ▶
17-1405	Strand Jacks	HSL		231 ▶
140-280	Skidding Systems	HSK HSLH		232 ▶
67	Self-propelled Modular Trailer	SPMT		233 ▶
N/A	Synchronous Lifting Systems	EVO		234 ▶
	Custom Solutions			235 ▶
.025-250	Uni-Lift Actuators	M, B		236 ▶



Contact Enerpac!

Contact the Enerpac office nearest to you for advice and technical assistance in the layout of your ideal solution or visit us on the web: www.enerpac.com.

You can also ask Enerpac for assistance by e-mail at integratedsolutions@enerpac.com.

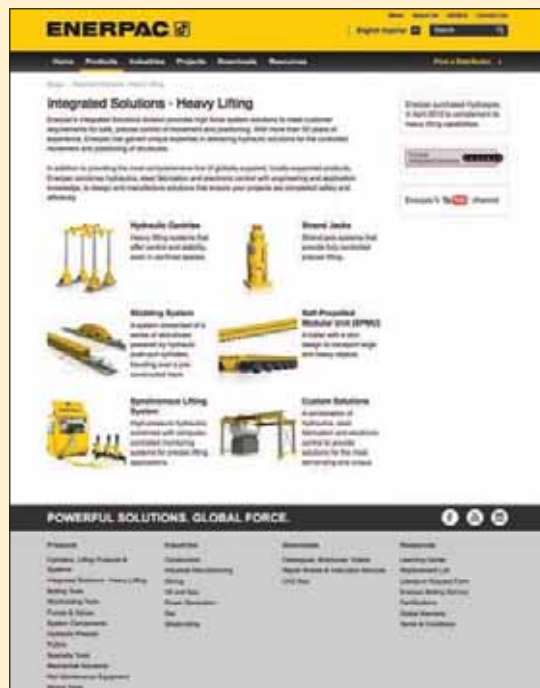

▼ Shown: **SBL1100 Hydraulic Gantry**



- **Self-contained hydraulics and electronics**
- **Intelli-Lift wireless control system**
- **Self-propelled wheels or tank rollers**
- **Foldable boom on SBL1100, MBL500 and MBL600**
- **Full range of supplementary equipment: header beams, lifting lugs, side shift, skid tracks**
- **All gantries are ASME B30.1 compliant**

SL/SBL/MBL Series

Capacity:
67-1200 tons

Lift Height:
11-47 feet



Hydraulic Gantries are a safe, efficient way to lift and position heavy loads in applications where traditional cranes will not fit and permanent overhead structures for job cranes are not an option.

Hydraulic Gantries are placed on skid tracks to provide a means for moving and placing heavy loads, many times with only one pick.

Enerpac offers three series of Hydraulic Gantry systems:

- the cost-effective SL-Series offers entry level control and capacity
- the heavy-duty SBL-Series offers capacities up to 1,200 tons and 3-stage lifting capability through the boom structure
- the MBL-Series incorporates all features of the SBL-Series and offers full lifting capacity over the full stroke. The MBL Gantries have been designed with increased footprint stability and can therefore lift using 2 legs as well as 4.

All Enerpac gantries are delivered with specific properties and control systems to ensure optimum stability and safety.



◀ Shown: **SBL1100**

▼ Shown: HSL50006 Ton Strand Jack



- Full control of lifting and lowering through SCC control system
- Two sizes strand diameter: 0.62" (15.7mm) and 0.71" (18 mm)
- Complete line of electric and diesel power pumps
- Nickel plated telescopic pipes preventing bird caging
- Standard supplied with lifting anchor
- Automated locking – unlocking operation
- Special corrosion treated high endurance multi-use wedges
- Full range of accessories: strand dispenser, strand guide, re-coiler

HSL Series

Capacity:
17-1405 tons



A strand jack can be considered a linear winch. In a strand jack, a bundle of steel cables or strands are guided through a hydraulic cylinder. Above and below the cylinder are anchor systems with wedges that grip the strand bundle simultaneously, this is how the strand jack is able to carry a load. Lifting and lowering a load is achieved by hydraulically controlling the main jack and both mini jacks alternately.

Enerpac utilizes Smart Cylinder Control (SCC), ensuring full control of the lifting and lowering operation.

Today strand jacks are widely recognized as the most sophisticated heavy lifting solution. Strand jacks are used all over the world to erect bridges, load out offshore structures, and lift/lower heavy loads where the use of conventional cranes is neither economical nor practical.



◀ Shown: HSL85007.

▼ Shown: **HSK1250 Skidding System**



- PTFE skid pads with dimpled surface for low friction and long lifetime
- Easy to replace skid pads, no tools necessary
- Unique gripper anchor system complete with lever for easy selection of skidding direction
- Double acting hydraulic cylinders with sufficient capacity in both push and pull direction. No need to turn the skid shoe for reverse skidding direction
- Large load support surface on the skid beam
- Bottom of skid shoes equipped with stainless steel sliding plates



◀ Shown: **HSK1250**

HSK/HSKLH Series

Capacity:

140-280 tons

Stroke:

24 inches



The HSK skidding system is comprised of a series of skid-shoes powered by hydraulic push-pull cylinders, travelling over a pre-constructed track.

A series of special PTFE coated blocks are placed on the skid-tracks. The PTFE surface is matched with a sliding plate under the Enerpac skid shoes, designed to achieve minimum friction coefficients. The skid shoes are connected by hoses to a hydraulic electric or diesel driven power pack.

In addition to our standard skidding systems we have the capabilities to create customized skidding systems to meet your specific requirements.

Enerpac Skidding Systems are available in three versions:

- **HSK1250** with a capacity of 140 tons per skid unit
- **HSK2500** with a capacity of 280 tons per skid unit
- **HSKLH2000** with a capacity of 225 tons per skid unit and a lower collapsed height

The HSK1250 and HSK2500 skidding systems are available in two varieties: using a "skid shoe jack" or a "skid shoe beam". The skid shoe jack includes an integrated lifting cylinder. A skid shoe beam is designed for skidding purposes only.

To calculate the minimum required capacity per shoe, the entire load has to be able to rest safely on 2 of the 4 shoes. To skid a load of 500 tons, the required skidding system is **HSK2500**.

Self-Propelled Modular Trailer

▼ Shown: **SPMT600**



- **Multiple configurations possible**
- **Minimized height and slim design**
- **Intellidrive wireless control system**
- **One power pack per 3 trailers maximum**

SPMT Series

Capacity:

67 tons

Transport Speed:

2 mph (unloaded)



The Enerpac Self Propelled Modular Trailer features a minimized height and slim design, which make it very easy to operate in confined spaces. Each trailer has 3 axles. Each wheel unit has a steering as well as a lifting cylinder at its disposal. Wheel propulsion is accomplished by hydraulic propulsion. The power pack has a 55 hp tier 4 driven engine.

The SPMT is controlled by Intelli-drive, a wireless control system that allows the entire system to be operated by one person.

One of the unique features of the system is that it is able to be containerized. Two trailers and a power pack can be shipped inside a 20 ft. container.



◀ Shown: **SPMT600**

▼ **EVO-8** (shown with optional cylinders and wire stroke sensors)



- **Modular lifting system to control 4, 8 or 12 lifting points**
- **Can be networked to link up to 4 systems together (requires separate master control box)**
- **Intuitive user interface provides easy set-up and control with multiple lifting options**
- **Accuracy of 0.040" between leading and lagging cylinders**
- **Data storage and recording capabilities**
- **For use with standard single- or double-acting cylinders**
- **Built in warning and stop alarms for optimum safety**
- **Variable frequency electric motor for optimal flow control**
- **Two flow groups available to operate a wide range of cylinders**
- **EVO-B is a modular design allowing for use of existing Enerpac pumps**

EVO Series

Number of Lift Points:
4-12 points

Accuracy Over Full Stroke:
Up to 0.040"



Ease of Operation

- A single operator controls the entire operation
- User friendly interface: visual screens, icons, symbols and color coding



Enerpac's family of EVO synchronous lifting systems provides precision control and levels of force suitable for most lifting/lowering applications.

We can also provide custom systems tailored to unique project requirements.

The standard EVO system can support up to 12 lifting points, or be networked up to 48 points, and includes features such as center of gravity and tilting/weighing capabilities. It is a comprehensive self-contained design that features simple to use software that is extremely efficient at completing basic to complex applications.

The modular EVO-B system is a modular design that allows for utilization of existing Enerpac pumps. EVO-B offers an economical solution to basic applications requiring a maximum of 8 lifting points.



◀ Shown: EVO

Custom Solutions

When your application requires something other than our standard product offering, look to Enerpac's Integrated Solutions Team. Our group of Engineers, Designers and Specialist, will work with you to understand your specific application and provide a turn-key solution that will exceed your expectations.

STEEL FABRICATION



Enerpac has a dedicated facility for steel fabrication and welding. We design and manufacture custom structures used in demanding heavy-lifting applications.

ENGINEERING



Enerpac has a multi-disciplined engineering team capable of design and development of all aspects of an Integrated Solutions system. Leveraging design and application experience with the latest in computer software, rapid prototyping and analysis methods ensures delivery of the highest quality systems.

FIELD SUPPORT



Enerpac Integrated Solutions is available to provide on-site support including training and troubleshooting of systems. We also stock repair parts and consumable items at several locations to ensure fast delivery and minimal downtime.

ELECTRONICS



Enerpac designs all control systems in-house. This capability keeps control technology close to the design engineers who are developing the rest of the system. In doing so, we can tailor the control system to match unique project requirements.

HYDRAULIC POWER SUPPLIES



Enerpac designs, assembles and tests small to large hydraulic power units in-house. Power units range from 1/4 hp to 320 hp and are tested with the system they are intended to operate.

MACHINING



Enerpac utilizes the latest in CNC machining technologies and manufactures all large and special hydraulic cylinders in-house. We can machine diameters up to 50 inches with lengths to 240 inches.

MAINTENANCE and REPAIR



Due to the unique nature of Enerpac's Integrated Solutions systems, we offer complete maintenance and repair services. Our M&R group is available to assist customers who do not have access to local service facilities qualified to work on these systems.

SYNCHRONOUS HOISTING



A unique crane product for below-the-hook positioning of heavy loads that require precision placement. May reduce the number of cranes needed and reduce the costs for multiple picks.

STRAND JACK GANTRY



The strand jack gantry is a steel structure to facilitate erection and skidding back, forth and sideways of heavy loads. The Enerpac strand jack gantry allows you to operate in confined spaces.

This is powered by a hydraulic power unit that is situated on ground level. The capacity, height and width of the construction can be modified in cooperation with our engineering team.

The system consists of 3 major components:

- Steel Construction
- Strand Jacks for Vertical Lifting
- Skidding System for Horizontal Skidding

BRIDGE LAUNCHING



Providing a solution for the most complex and demanding bridge construction applications, Enerpac has over 20 years providing unique customer bridge launching systems.

SELF-ERECTING TOWER



The Enerpac Self Erecting Tower (ESET) is a self-erecting-tower-lift system that enables you to build a free standing gantry from ground level. The Self Erecting Tower can be supplied in various capacities and heights and is built with standard modular components, enabling a flexible solution to future project demands.

The Self Erecting Tower enables moving the load in all directions: lifting, lowering, skidding back and forth, and has side shift capabilities. Lifting and skidding are achieved using standard Enerpac strand jacks that can also be used for other applications.

The Self Erecting Tower is a versatile lift-system that can be used in a wide variety of operations, for example the installation of reactor vessels in a petrochemical plants or erecting a shipyard crane. When compared with large capacity cranes, the Self Erecting Tower significantly reduces transportation and set up costs.

▼ Shown: Mechanical Actuators



Precision Positioning and Control in a Mechanical Package

- Machine screw versions up to 250 tons for low-cycle, high-load applications and positive load holding
- Ball-Screw versions up to 100 tons for high-cycle, high-speed applications
- Electro-Mechanical Drive System can be interlinked and easily synchronized
- Precision rolled load screws Class 3 fit for additional strength
- Preloaded tapered roller bearings tolerate high thrust loads and minimize side loading
- Precision worm gear sets provide minimum backlash while reducing wear
- Wide variety of base mounting and screw end configurations



Maximize Your System Control

Custom control boxes designed to meet your specific application requirements.



System Accessories

Enerpac offers a large array of motors, drive components, and boots to meet any demanding project.



◀ *Uni-Lift® Actuators were the ideal choice to position and adjust the complex scaffolding for aircraft maintenance. Precision movement and flexibility was an asset in getting the job done efficiently and safely.*

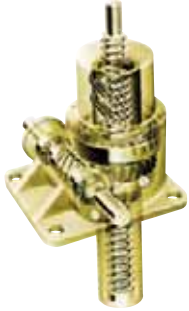

Ball Screw Cutaway



Machine Screw Cutaway

Design Features:

- Available with translating, rotating and keyed load screw designs
- High-strength rolled load screws provides maximum durability
- Rugged aluminum alloy and ductile iron housings for demanding or rigorous environment
- Corrosion resistant zinc plating is standard on most units
- The widest range options gear ratios are available to meet all application requirements
- Speeds up to 175 inches per minute

Actuator Accessories:

- High-quality bellow boots for added loadscrew protection
- Easy mounting of optional screw ends are available in plain, top plate and clevis design
- Wide selection of motors and C-face adaptors
- Limit switches and encoders for complete system control
- Couplers and shafting available for individual system requirements
- A large choice of mitre gear boxes and reducers provide maximum system design flexibility
- Custom built control boxes to meet your specific need

Typical Mechanical Actuator Set-Up

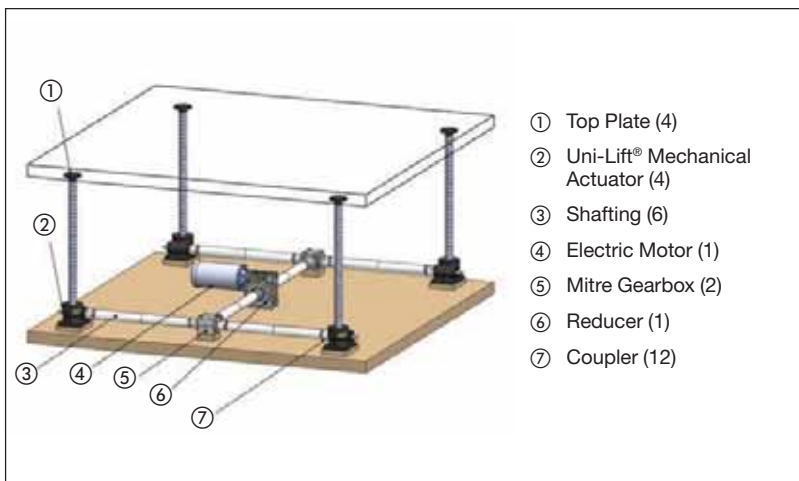

B, M Series



Capacity:

.25-250 tons

Maximum Stroke:

15-230 inches

Types:

Machine & Ball Screw



Over-travel Stop Nuts provide a mechanical stop and are used to prevent the ejection of the power screw from the actuator.



Contact Enerpac!

Contact the Enerpac office nearest to you for advice and technical assistance in the layout of your ideal Lift System. You can also ask Enerpac for assistance by e-mail at integratedsolutions@enerpac.com.



CAD Modeling Software

Our experienced sales team and application engineers will deliver the precise support you need to meet the most demanding and unique requirements. State-of-the art CAD modeling software offers the needed flexibility to design custom built "special" screw jacks to suit all customer needs.

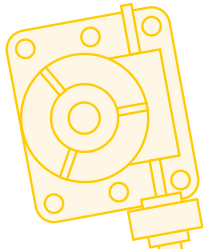

Engineers utilized two (2) Uni-Lift® 100-ton actuators with 15' of travel to raise and lower the ramp on each ferry dock along the Mississippi River, USA. The Department of Transportation engineers needed a way of lifting and lowering ramps during high and low tide conditions, while holding up to the harsh environmental conditions of the gulf coast.



When engineers needed a quick and compact way of opening the large doors of these large plating tanks, they contacted Uni-Lift® for help. This application utilizes two 5-ton double-clevis actuators, with a motor and a limit switch box mounted on each actuator. The operator just pushes a button to open the doors, and pushes another button to close them. This method greatly enhances operator safety and helps prevent cross contamination between tanks.

Uni-Lift® screw jacks are used extensively in a variety of material handling applications. Whether used in positioning conveyer belts, placing tension on overhead beams or moving heavy-duty equipment, Uni-Lift® actuators are the ideal solution for many jackings, tensionings, and positioning applications. Whether you have one lifting point or multiple lifting points, Uni-Lift® actuators are the perfect solution for many different OEM motion control applications.





Configuring Your UNI-LIFT Actuator On-Line

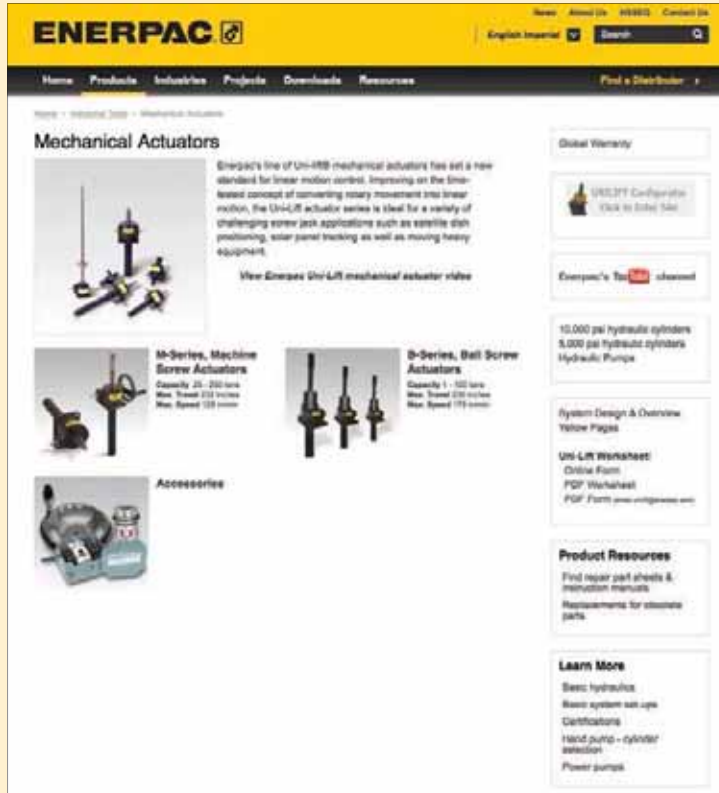

www.enerpac.com/unilift for latest Enerpac Uni-Lift® information

Visit the Enerpac Web Site and use the UNI-LIFT® Configurator to properly select the type, ratio, and size of the machine or ball screw actuator for your application.

- Provides instant results that are downloadable in 2D and 3D CAD
- Configuration snapshot is generated from your selection input
- Supports imperial and metric units
- Informative help topics guide you through the entire process

▼ Sample 3D File



▼ Sample Configuration Report

Configuration Report
Uni-Lift
For contact information visit www.enerpac.com

Project: E501 Example Date:
Prepared By: Uni-Lift Order Number Matrix:

Uni-Lift #	Model	Size	Mtg Style	Scr Cfg	ESL (in)	Ratio	End Cfg	Boot	Stop Nut	Mtr	Ada	Limit SW
1	M	4	U	T	20.0	L	TP					
2	M	4	U	T	20.0	L	TP					
3	M	4	U	T	20.0	L	TP					
4	M	4	U	T	20.0	L	TP					

Input Data

# of Uni-Lifts:	4
The Load is	Guided
The Load is in	Compression
Load Screw Travel:	20.0 Inches
Balanced:	Yes
Max Load on One Lift:	7,500 Pounds
Total Static Load:	30,000 Pounds
Total Running Load:	30,000 Pounds
Factor of Safety Required:	2.0
Slenderness Ratio Required:	400
Ambient Temperature:	80 Fahrenheit
Required Cycles/Hour:	3 Cycles
Motor Speed:	1,725 RPM
Reducer Ratio:	7.50:1
Gear Ratio:	5.3:1
Turns Per Inch (TPI):	16

Results

	English		Metric
Input Speed:	230 RPM		230 RPM
Linear Velocity:	14.38 In/Min		365.1 mm/Min
One-Way Travel Time:	1.39 Minutes		1.39 Minutes
Max Cycles/Hour:	12.23 Cycles		12.23 Cycles
Horse Power:	3.80 HP		2.84 KW
Motor Starting Torque:	241 In-Lbs		27.17 N-m
Motor Running Torque:	139 In-Lbs		15.69 N-m
Unit Run Torque:	188 In-Lbs		21.25 N-m
Slenderness Ratio Calc:	39		39
Factor of Safety Calc:	2.1		2.1
Key Torque:	1,312 In-Lbs		148.21 N-m

Uni-Lift
For contact information visit www.enerpac.com
[Contact Us](#)

Yellow Pages Overview



Enerpac "Yellow Pages" stand for Hydraulic Information!

If selecting hydraulic equipment is not your daily routine then you will appreciate these pages. The "Yellow Pages" are designed to help you work with hydraulics. They will help you to better understand the basics of hydraulics, of system set-ups and of the most commonly used hydraulic techniques. The better your choice of equipment, the better you will appreciate hydraulics. Take the time to go through these "Yellow Pages" and you will benefit even more from Enerpac High Pressure Hydraulics.

Section		Page
Safety Instructions		242-243 ▶
Product Selection & Worksheet		244-245 ▶
Basic System Set-ups		246-247 ▶
Basic Hydraulics		248-249 ▶
Conversion Tables and Speed Charts		250-251 ▶
Valve Information		252 ▶
Torque Tightening		253-254 ▶



ENERPAC WARRANTY STATEMENT

www.enerpac.com

Visit our website for the complete Enerpac Global Warranty or call your Enerpac representative or Enerpac Authorized Service Center.

Enerpac is certified for several quality standards. These standards require compliance with standards for management, administration, product development and manufacturing.



Enerpac works hard to maintain the ISO 9001 quality rating, in its ongoing pursuit of excellence.

CE Marking & Conformity

Enerpac provides Declarations of Conformity, Declarations of Incorporation, and CE marking for products that conform to the European Community Directives.



Where specified, Enerpac electric power units meet the design, assembly and test requirements of The Standards Council of Canada (CAN C22.2 No. 68-92), and UL73 for the United States. Units were tested and certified for both USA and Canada by TUV, a nationally recognized testing laboratory.

EMC Directive 2004/108/EC

Where specified, Enerpac electric power pumps meet the requirements for Electromagnetic Compatibility per EMC Directive 2004/108/EC.



DEKRA & IBEx
ATP-1500, ZA and XA-Series air-motor driven pumps, and S- and W-Series Torque Wrenches are tested and certified according to the Directive 94 / 9 / EC "ATEX Directive". The explosion protection is for equipment group II, equipment category 2 (hazardous area zone 1), in gas and/or dust atmospheres. ATP-1500, ZA and XA-Series pumps are marked with: Ex II 2 GD ck T4.

ASME B30.1-2004

Our cylinders fully comply with the criteria set forth by the American Society of Mechanical Engineers (except RD, BRD, CLL, CLS and CLP-Series).

DIN 20024

Enerpac thermoplastic hoses are related to the criteria set forth in Deutsche Industrie Norm 20024.

Product Design Criteria

All hydraulic components are designed and tested to be safe for use at maximum 10,000 psi unless otherwise specifically noted.



Safety Instructions



- Lift slowly and check often
- Avoid standing in the line of force
- Anticipate possible problems and take steps to avoid them

When used correctly, hydraulic power is one of the safest methods of applying force to your work. To that end we offer some DO's and DON'Ts, simple common sense points which apply to practically all Enerpac hydraulic products.

The illustrations and application photos of Enerpac products throughout this catalog are used to portray how some of our customers

have used hydraulics in industry. In designing similar systems, care must be taken to select the proper components that provide safe operation and fit your needs. Check to see if all safety measures have been taken to avoid the risk of injury and property damage from your application or system. Enerpac cannot be held responsible for damage or injury caused by unsafe use, maintenance or application of its products.

Please contact the Enerpac office or a representative for guidance when you are in doubt as to the proper safety precautions to be taken in designing and setting up your particular system.

In addition to these tips, every Enerpac product comes with specific safety information and instructions. Please read them carefully.

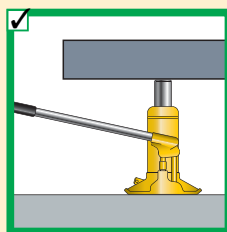
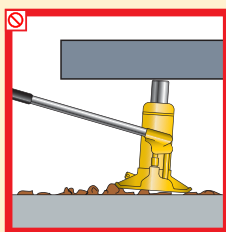

Provide a level and solid support for the entire jack base area.

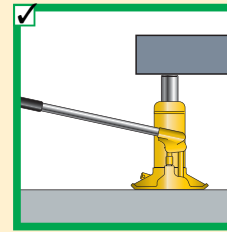
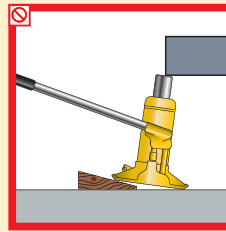

The entire jack saddle must be in contact with the load. Movement of the load must be in the same direction as jack plunger.



Never place any part of your body under the load. Ensure the load is on a solid support before venturing under.

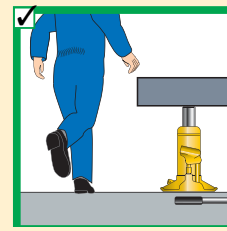
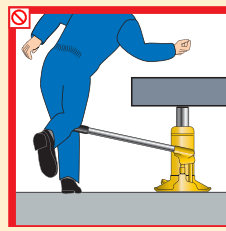

Remove the jack handle when it is not being used.

Cylinders

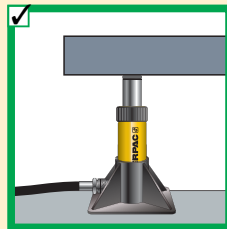
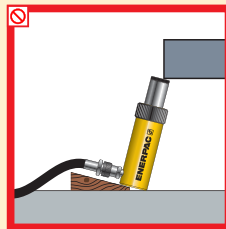

Provide a solid support for the entire cylinder base area. Use cylinder base attachment for more stability.

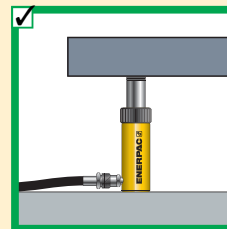
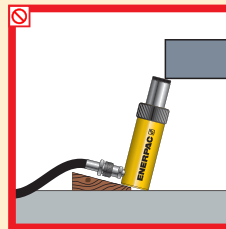

The entire cylinder saddle must be in contact with the load. Movement of the cylinder must be parallel with the movement of the load.

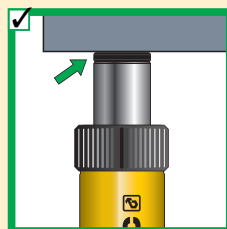
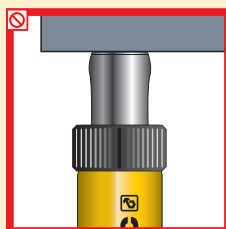

Do not use cylinder without saddle. This will cause plunger to "mushroom". Saddles distribute load evenly on the plunger.



As with jacks, never place any part of your body under the load. Load must be on cribbing before venturing under.



Always protect cylinder threads for use with attachments.

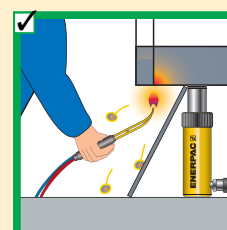
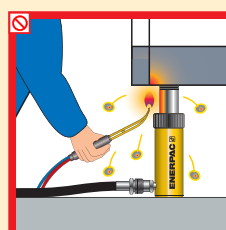

Keep hydraulic equipment away from open fire and temperatures above 150 °F (65 °C).



General

80% Manufacturer's rating of load and stroke are maximum safe limits. **80%**
Good practice encourages using only 80% of these ratings!

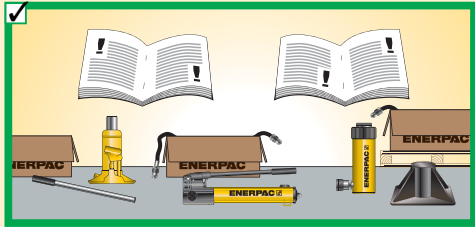

Always read instructions and safety warnings that come with your Enerpac hydraulic equipment.

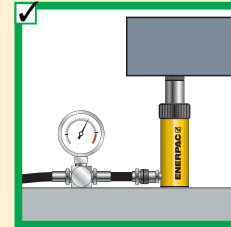
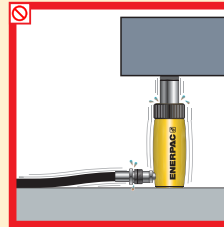

Don't override the factory setting of relief valves. Always use a gauge to check system pressure.

Pumps

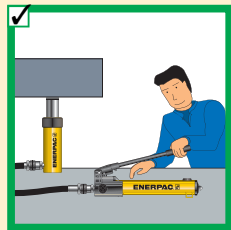

Don't use handle extenders. Hand pumps should be easy to operate when used correctly.

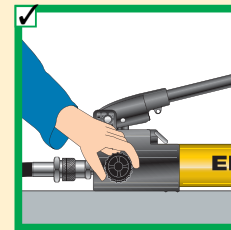
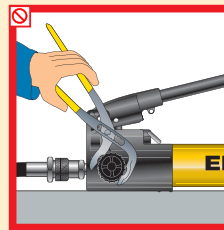

Close release valve finger tight. Using force will ruin the valve.

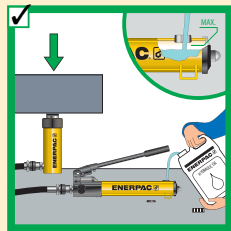
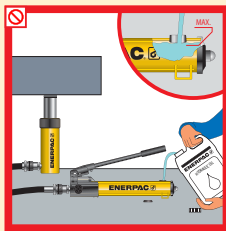

Fill pump only to recommended level. Fill only when connected cylinder is fully retracted.

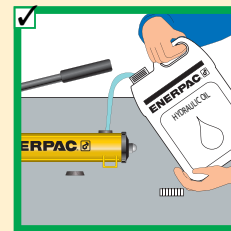
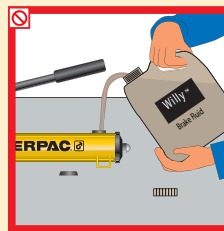

Always use genuine enerpac hydraulic oil.

Hoses and couplers

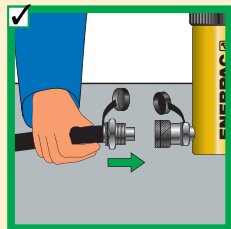
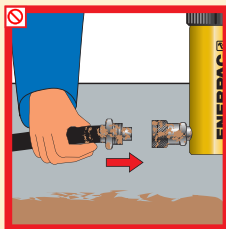

Clean both coupler parts before connecting. Use dust caps when coupler parts are not connected.

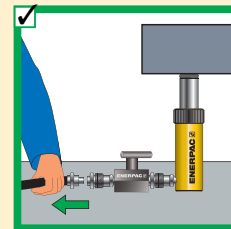
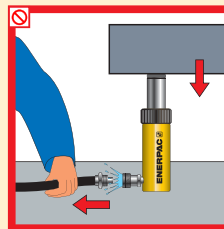

Detach cylinder only when fully retracted or use shut-off valves or safety valves to lock-in cylinder pressure.

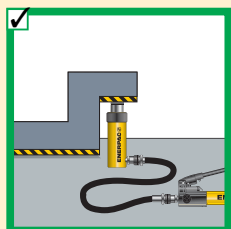
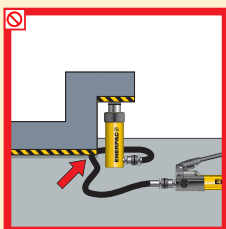

Keep hoses away from the area beneath loads.

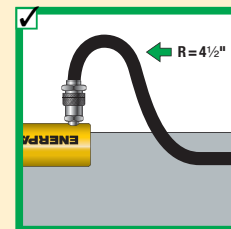
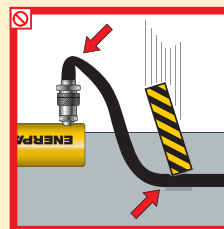

Don't kink hoses. Bending radius should be at least 4 1/2 inch. Don't drive over or drop heavy objects on hoses.

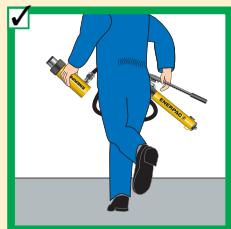



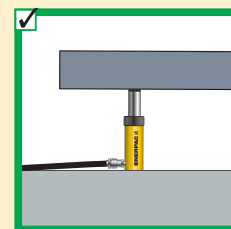
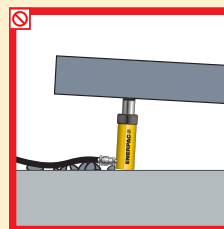

Don't lift hydraulic equipment by the hoses.



Never allow the cylinder to be lifted off of the ground through the couplers.



▼ HAND PUMP AND SINGLE-ACTING CYLINDER MATCHING CHART

Capacity (tons) ▶ ▼ Stroke (inches)	5	10	15	25	30	50	60	75	100	150
< 1.00										
1.00										
2.00										
3.00										
4.00										
5.00										
6.00										
7.00										
8.00										
9.00										
10.00										
12.00										
13.00										
14.00										
		P-392			P-80		P-462			
		Page: 58			Page: 60		Page: 60			

Note: Selection based on oil capacity requirements of cylinders.

▼ POWER PUMP SELECTION CHART

Flow*	Low (20 in ³ /min)		Medium (60 to 200 in ³ /min)		High (463 in ³ /min)
Reservoir Oil Capacity	0.5-1 gal.	1.5 gal.	1.0-10 gal.	1.0-10 gal.	25 gal.
Duty Cycle**	Intermittent	Extended	Intermittent	Extended	Extended
Portable/Stationary***	Portable	Stationary	Portable	Stationary	Stationary
Recommended Series	Economy	Submerged	ZU4	ZE3-6	8000 Series
					
	Page: 70	Page: 72	Page: 78	Page: 84	Page: 90

* Flow

- Determined by motor size
- Directly affects electrical power requirements
- Determines cylinder or tool speed

** Duty Cycle

- Extended applications require more than one hour of uninterrupted pump use
- Intermittent use – from 20 minutes to one hour, depending on reservoir capacity (contact Enerpac for details)

*** Portability

- | | |
|-------------------------------|----------------------------------|
| <u>Portable</u> | <u>Stationary</u> |
| • Ergonomic handles | • Mounting options |
| • Flexible power requirements | • Normally requires stable power |

Product Selection Worksheet



▼ Complete the following information to select the right products:

Cylinder Selection	Question:	Tips/help	Data	Model Number
	Total force required in tons:	Total load	<input type="text"/>	
	Number of cylinders required:	Number of lifting points	<input type="text"/>	
	Force per cylinder in tons:	Should be 80% of total cylinder cap.	<input type="text"/>	
	Stroke required:	Plunger travel	<input type="text"/>	
	Single or double acting (D/A):	D/A used when pull force is required, or retract speed is critical	<input type="text"/>	
	Type of plunger required:	Hollow or solid	<input type="text"/>	
	Collapsed height required:	Height with plunger fully retracted	<input type="text"/>	
	Optional saddle required:	Tilt, Grooved, Flat	<input type="text"/>	
	Cylinder base:	Improves stability	<input type="text"/>	
	Cylinder attachments: (RC-series)	Expanded functions	<input type="text"/>	
	Selected cylinder model:		▶	<input type="text"/>
	Including coupler model:		<input type="text"/>	

Pump Selection	Available power source:				
	<input type="checkbox"/> Manual <input type="checkbox"/> Battery <input type="checkbox"/> Electric <input type="checkbox"/> Compressed Air <input type="checkbox"/> Gasoline				
The three most commonly selected pumps are hand pumps, electric pumps and air-driven pumps. Gas powered pumps, however can be selected in the same way.	<u>Hand pump</u>	Not for high-cycle applications	<input type="text"/>		
	Single- or double-acting operation	Use 4-way valve for D/A applications	<input type="text"/>		
	Selected hand pump:		▶	<input type="text"/>	
	<u>Electric or compressed air pump</u>	Weight and power requirements	<input type="text"/>		
	Need for portability:	Intermittent or extended	<input type="text"/>		
	Duty cycle:	Intermittent = 1.2 x cylinder oil capacity	<input type="text"/>		
	Required usable oil capacity:	high cycle = 2 x cylinder oil capacity	<input type="text"/>		
	Available voltage:	Single phase or Three phase	<input type="text"/>		
	Lifting speed (Important/not important):	Use speed chart on page 251	<input type="text"/>		
	Type of control:	Manual/remote pendant	<input type="text"/>		
Type of actuation/function:	Advance/hold/retract	<input type="text"/>			
Accessories:	Roll bar, Oil Filter kit, ...	<input type="text"/>			
Selected pump:		▶	<input type="text"/>		
To suit hose:	Oil connection	<input type="text"/>			

System Components	Number of hoses and length required:		
Selected hoses:		▶	<input type="text"/>
Manifold or tee:		▶	<input type="text"/>
Extra hose per manifold (2):		▶	<input type="text"/>
Gauge (psi, lbs or tons scale):	Glycerine for high cycle	▶	<input type="text"/>
Gauge adaptor:		▶	<input type="text"/>
Fittings:		▶	<input type="text"/>
Pressure relief safety valve:		▶	<input type="text"/>
Load-holding valve(s):		▶	<input type="text"/>
Hydraulic oil:		▶	<input type="text"/>



- 1 Cylinder**
Applies hydraulic force.
Page 5
- 2 Cylinder Base Plate**
For applications such as lifting where additional cylinder stability is required.
Page 10
- 3 Pump**
Provides hydraulic flow.
Page 56
- 4 Hose**
Transports hydraulic fluid.
Page 114-115
- 5 Male Coupler**
For quick connection of the hose to system components.
Page 116-117
- 6 Female Coupler**
For quick connection of the hose end to the system components.
Page 116-117
- 7 Gauge**
To monitor pressure of the hydraulic circuit.
Page 120-123
- 8 Gauge Adaptor**
For quick and easy gauge installation.
Page 126
- 9 Swivel Connector**
Allows proper alignment of valves and/or gauges. Used when units being connected cannot be rotated.
Page 127
- 10 Auto-damper Valve V-10**
Used to protect gauge from damage due to sudden pulses in the system. Needs no adjustment and allows correct positioning of gauge, prior to tightening.
Page 129

Single-acting push application, such as in a press.
The hand pump offers controlled cylinder advance, but may require many hand pump strokes in longer stroke applications when the cylinder capacity is 25 ton or above.

Examples of pump, hose and cylinder sets can be found on page 55.

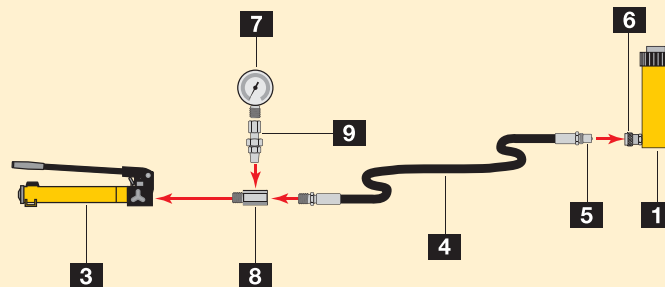

Single-acting cylinder with longer stroke used for lifting applications.

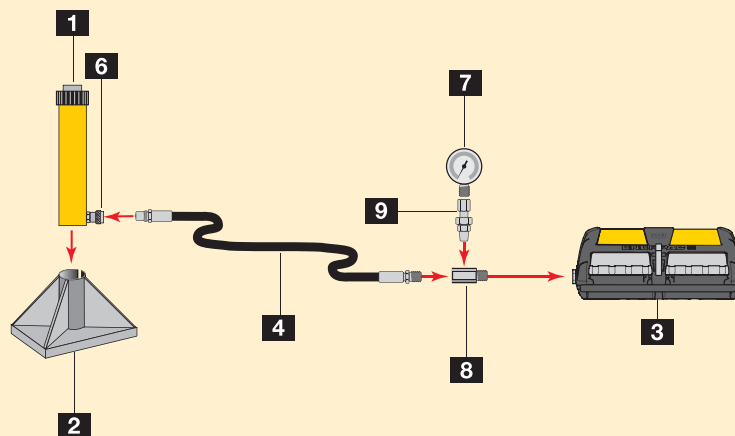

Double-acting cylinder set-up used for lifting applications where a slow controlled descent of the load must be maintained.

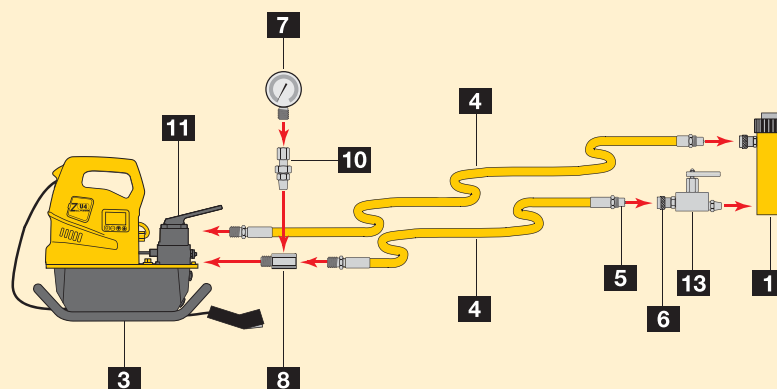



Double-acting cylinder set-up used in a push/pull application.

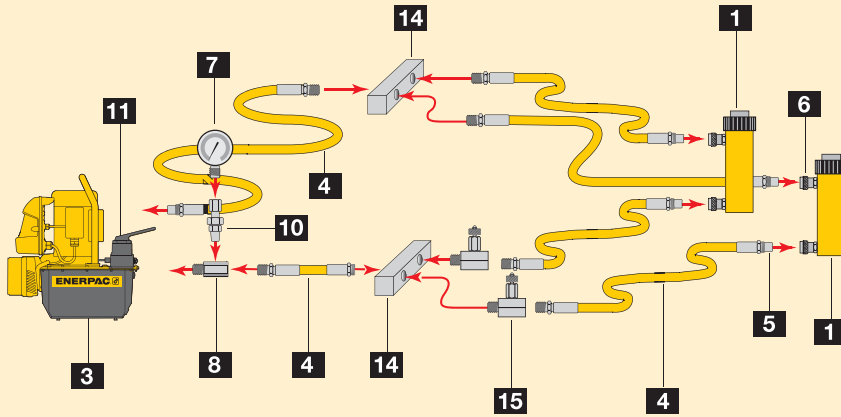

11 4-Way Directional Control Valve
Controls the direction of hydraulic fluid in a double-acting system.
Page 106

12 3-Way Directional Control Valve
Controls the direction of hydraulic fluid in a single-acting system.
Page 106

13 Safety Holding Valve
Controls load descent in lifting applications.
Page 129

14 Manifold
Allows distribution of hydraulic fluid from one power source to several cylinders
Page 118

15 Needle Valve
Regulates the flow of hydraulic fluid to or from the cylinders.
Page 129

Two point lifting set-up using single-acting cylinders.

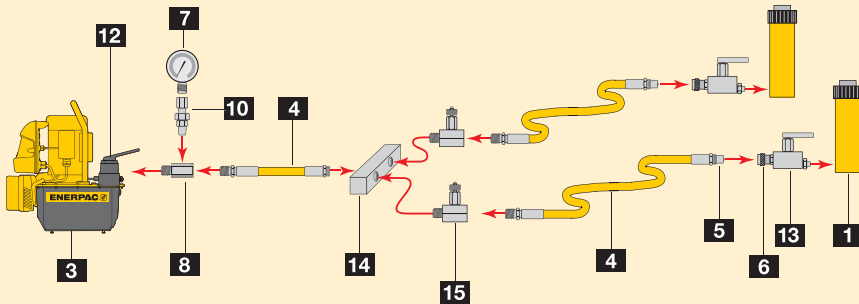



www.enerpac.com
Visit our web site to learn more about hydraulics and system set-ups.

Four point lifting set-up, using single-acting cylinders, flow control valves and safety valves.

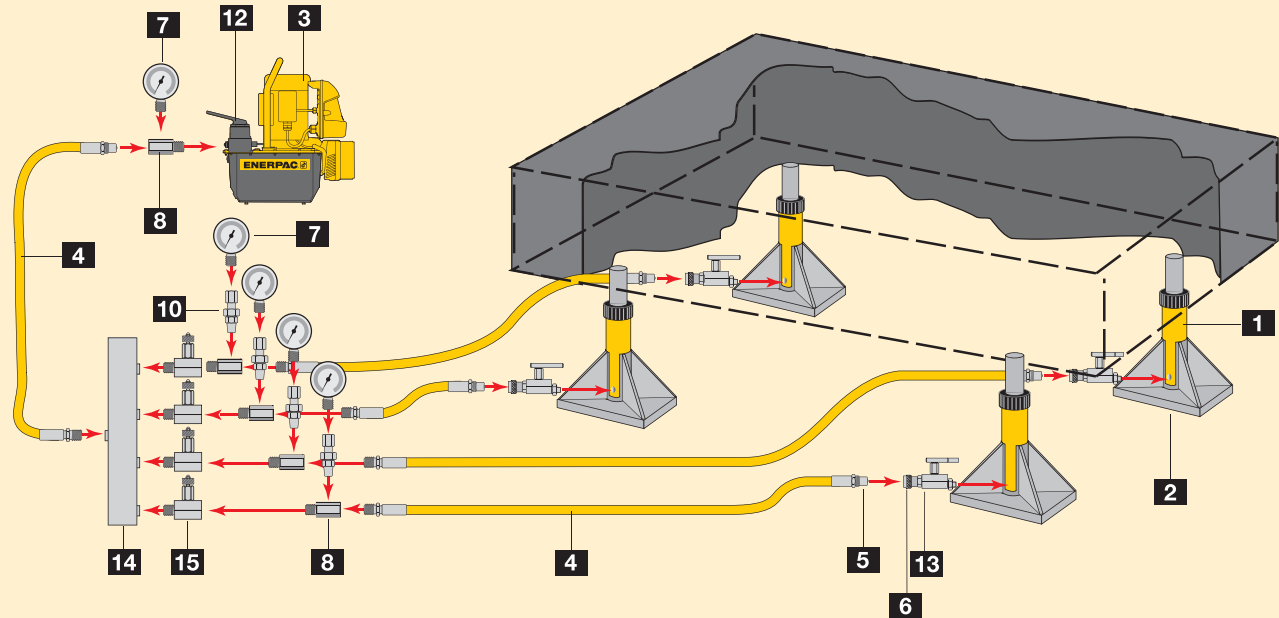



Flow

A hydraulic pump produces flow

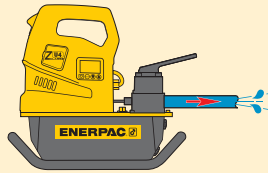

Pressure

Pressure occurs when there is resistance to flow

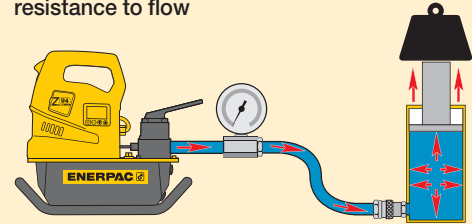

Pascal's Law

Pressure applied at any point upon a confined liquid is transmitted undiminished in all directions (Fig.1).

This means that when more than one hydraulic cylinder is being used, each cylinder will lift at its own rate, depending on the force required to move the load at that point (Fig. 2).

Cylinders with the lightest load will move first, and cylinders with the heaviest load will move last (Load A), as long as the cylinders have the same capacity.

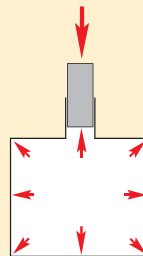

Figure 1

To have all cylinders operate uniformly so that the load is being lifted at the same rate at each point, either control valves (see Valve section) or Synchronous Lift System components (see Cylinder section) must be added to the system (Load B).

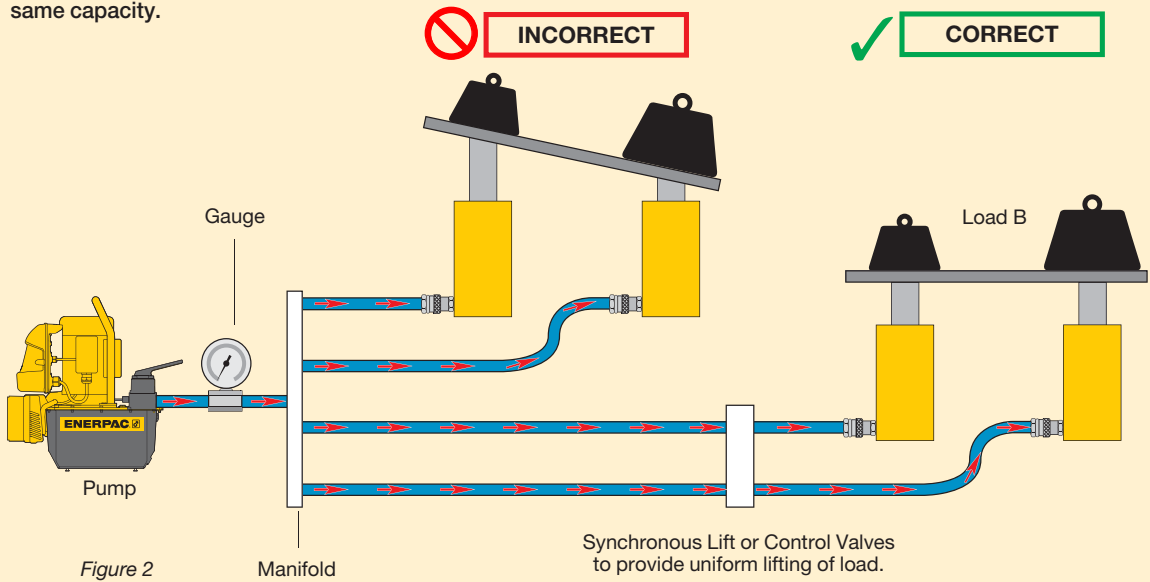

Figure 2



CAUTION!

When lifting or pressing, always use a gauge.

A gauge is your "window" to the system. It lets you see what's going on. You will find the gauges in the System Components section.



Learn more about hydraulics

Visit www.enerpac.com to learn more about hydraulics and system set-ups.



Force

The amount of force a hydraulic cylinder can generate is equal to the hydraulic pressure times the “effective area” of the cylinder (see cylinder selection charts).

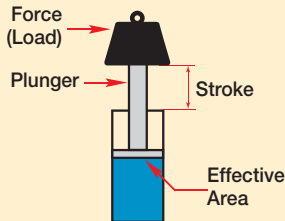

Force	=	Hydraulic Working Pressure	x	Cylinder Effective Area
-------	---	----------------------------	---	-------------------------

F	=	P	x	A
---	---	---	---	---

Use this formula to determine either force, pressure or effective area if two of the variables are known.

Example 1

An RC-106 cylinder with 2.24 in² effective area operating at 8,000 psi will generate what force?

$$\text{Force} = 8,000 \text{ psi} \times 2.24 \text{ in}^2 = 17,920 \text{ lbs.}$$

Example 2

An RC-106 cylinder lifting 14,000 lbs will require what pressure?

$$\text{Pressure} = 14,000 \text{ lbs} \div 2.24 \text{ in}^2 = 6,250 \text{ psi.}$$

Example 3

An RC-256 cylinder with 5.15 in² effective area is required to produce a force of 41,000 lbs. What pressure is required?

$$\text{Pressure} = 41,000 \text{ lbs.} \div 5.15 \text{ in}^2 = 7961 \text{ psi.}$$

Example 4

Four RC-308 cylinders each with 6.49 in² effective area are required to produce a force of 180,000 lbs. What pressure is required?

$$\text{Pressure} = 180,000 \text{ lbs} \div (4 \times 6.49 \text{ in}^2) = 6933 \text{ psi.}$$

Remember, since four cylinders are used together, the area for one cylinder must be multiplied by the number of cylinders used.

Example 5

A CLL-2506 cylinder with 56.79 in² effective area is going to be used with a power source that is capable of 7,500 psi. What is the theoretical force available from that cylinder?

$$\text{Force} = 7,500 \text{ psi} \times 56.79 \text{ in}^2 = 425,925 \text{ lbs.}$$

Cylinder Oil Capacity

The volume of oil required for a cylinder (cylinder oil capacity) is equal to the effective area of the cylinder times the stroke*.

Cylinder Oil Capacity	=	Cylinder Effective Area	x	Cylinder Stroke
-----------------------	---	-------------------------	---	-----------------

Example 1

An RC-158 cylinder with 3.14 in² effective area and an 8 in. stroke will require what volume of oil?

$$\text{Oil Capacity} = 3.14 \text{ in}^2 \times 8 \text{ in} = 25.12 \text{ in}^3$$

Example 2

An RC-5013 cylinder has an effective area of 11.05 in² and a stroke of 13.25 in. How much oil will be required?

$$\text{Oil Capacity} = 11.05 \text{ in}^2 \times 13.25 \text{ in} = 146.41 \text{ in}^3$$

Example 3

An RC-10010 cylinder has an effective area of 20.63 in² and a stroke of 10.25 in. How much oil will it require?

$$\text{Oil Capacity} = 20.63 \text{ in}^2 \times 10.25 \text{ in} = 211.46 \text{ in}^3$$

Example 4

Four RC-308 cylinders are being used, each with an effective area of 6.49 in² and stroke of 8.25 in. How much oil will be required?

$$\text{Oil Capacity} = 6.49 \text{ in}^2 \times 8.25 \text{ in} = 53.54 \text{ in}^3 \text{ for one cylinder}$$

Multiply by four to obtain the required capacity: 214.17 in³

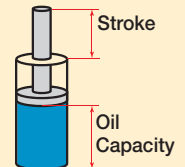

* Note: these are theoretical examples and do not take into account the compressibility of oil under high pressure.



Enerpac oil will compress 2.28% at 5,000 psi and 4.1% at 10,000 psi.



Conversion Tables

Key to cylinder dimensions

Dimensions shown in the Selection Charts of the cylinder section are identified on the relevant drawings by the capital letter references listed here: A for collapsed height through Z for depth of internal base thread.

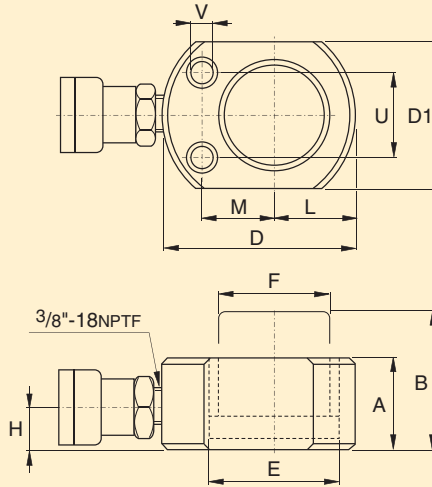
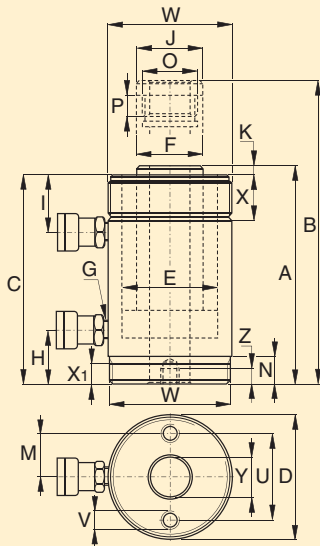

- A = Collapsed height
- B = Extended height
- C = Cylinder body length
- D = Cylinder outside diameter
- D1 = Cylinder width
- E = Cylinder inside diameter (bore)
- F = Plunger rod diameter
- G = Oil inlet thread
- H = Cylinder bottom to advance port
- I = Cylinder top to retract port
- J = Saddle outside diameter
- K = Cylinder rod protrusion at collapsed height
- L = Plunger center to side of base
- M = Mounting holes to plunger center
- N = Length of smaller cylinder part
- O = Plunger hole or thread of saddle
- P = Plunger thread length
- Q = Plunger outside thread (pull cylinders only)
- U = Bolt circle diameter of mounting holes
- V = Thread of cylinder mounting holes
- W = Collar thread
- X = Collar thread length
- Y = Center hole diameter (hollow cylinders only)
- Z = Depth of internal base thread

Key to measurements

All capacities and measurements in the catalog are expressed in uniform values.

The conversion chart provides helpful information for their translation into equivalent systems.

You can also visit our website at www.enerpac.com to download Conpaq, a FREE conversion calculator.

Pressure:

- 1 psi = .069 bar
- 1 bar = 14.50 psi
- 1 kPa = .145 psi

Volume:

- 1 in³ = 16.387 cm³
- 1 cm³ = .061 in³
- 1 liter = 61.02 in³
- 1 liter = .264 gal
- 1 US gal = 3,785 cm³
- = 3.785 l
- = 231 in³

Weight:

- 1 pound (lb) = .4536 kg
- 1 kg = 2.205 lbs
- 1 metric ton = 2,205 lbs
- 1 ton (short) = 2,000 lbs
- 1 ton (short) = 907.18 kg

Temperature:

- To convert °F to °C:
 $T_c = (T_f - 32) \div 1.8$
- To convert °C to °F:
 $T_f = (T_c \times 1.8) + 32$

Other measurements:

- 1 in = 25.4 mm
- 1 mm = .039 in
- 1 in² = 6.452 cm²
- 1 cm² = .155 in²
- 1 hp = .735 kW
- 1 kW = 1.359 hp
- 1 Nm = .73756 Ft.lbs
- 1 Ft.lbs = 1.355818 Nm

Imperial to metric

Inches	Decimal	mm
1/16	.06	1.59
1/8	.13	3.18
3/16	.19	4.76
1/4	.25	6.35
5/16	.31	7.94
3/8	.38	9.53
7/16	.44	11.11
1/2	.50	12.70
9/16	.56	14.29
5/8	.63	15.88
11/16	.69	17.46
3/4	.75	19.05
13/16	.81	20.64
7/8	.88	22.23
15/16	.94	23.81
1	1.00	25.40

Cylinder Speed Charts



Cylinder Speed

This chart will help you calculate the time required for an Enerpac cylinder to lift a load when powered by a 10,000 psi Enerpac hydraulic pump.

The Cylinder Speed Chart can also be used to determine the pump type and model best suited for an application when you know the plunger speed required.

To determine:

Cylinder plunger speed

An RC-308 cylinder (30 ton) is powered by a ZE-5 pump. While lifting the load, the cylinder plunger will require 3.2 seconds to travel 1 inch.

25 ton		30 ton		50 ton		75 ton		100 ton		Pump Type
No Load	Load	No Load	Load	No Load	Load	No Load	Load	No Load	Load	
15	15.9	1.9	1.1	3.3	3.2	4.8	4.7	6.2	6.1	0.5 hp Economy
44	5.2	5.8	8.5	9.5	11.1	1.4	15.9	1.8	20.7	ZU4 Series
2.1	15.5	2.6	19.5	4.4	33.2	6.4	47.7	8.3	61.9	0.5 hp Submerged
89	7.7	8.7	9.7	1.5	16.6	2.1	23.9	2.8	30.9	ZE3 Series
48	5.2	6.0	6.5	7.0	11.1	3.5	15.9	1.9	20.6	ZE4 Series
36	2.6	4.6	3.2	4.4	1.1	9.9	1.5	10.8	11.8	ZE5 Series
34	1.5	4.3	1.9	.74	3.3	1.1	4.8	1.4	6.20	ZE6 Series
30	87	39	84	85	1.4	34	2.1	1.2	2.7	8000-Series
25	20.6	3.2	26.0	5.5	44.2	8.0	63.6	10.3	82.5	XA Series
5.2	30.9	6.5	39.0	11.0	66.3	15.9	95.5	20.6	123.9	Turbo II Pump
6.2	38.6	7.8	48.7	13.3	82.9	19.1	119.3	24.8	154.7	PA-133
48	34.3	6.0	43.3	1.0	73.7	1.5	106.8	1.9	137.5	PAM 10-Series
36	3.9	4.6	4.9	2.6	3.3	1.1	11.9	1.5	15.5	Z4 Series
15	1.7	1.9	2.7	3.3	16.6	4.8	23.9	6.2	30.9	PGM2 Atlas
0.44	3.1	0.58	3.9	0.95	6.6	1.4	9.5	1.8	12.4	ZG5 Series, Briggs
0.77	3.1	0.97	3.9	1.7	6.6	2.4	9.5	3.1	12.4	ZG5 Series, Honda
0.34	1.5	0.43	1.9	0.74	3.3	1.1	4.8	1.4	6.2	ZG6 Series

While extending towards the load, the cylinder plunger travels at .46 sec/in.

To determine:

Best matching pump

Your 30 ton cylinder needs to move a load at a speed of 6.50 sec/in. Simply go down from the top of the chart, to the value of 6.50 sec/in. Then follow the chart to the right to find that

the ZE4 pump or ZU4 is most suitable for your application.

15 t		25 t		30 t		50 t		75 t		100 t		Tipo de bomba
Con carga	Sin carga	Con carga	Sin carga	Con carga	Sin carga	Con carga	Sin carga	Con carga	Sin carga	Con carga	Sin carga	
84	9.4	13	15.9	1.9	1.1	3.3	3.2	4.8	4.7	6.2	6.1	0.5 hp Económica
2.1	15.5	2.6	19.5	4.4	33.2	6.4	47.7	8.3	61.9	8.3	61.9	0.5 hp Submergida
89	7.7	8.7	9.7	1.5	16.6	2.1	23.9	2.8	30.9	2.8	30.9	ZE3 Series
48	5.2	6.0	6.5	7.0	11.1	3.5	15.9	1.9	20.6	1.9	20.6	ZE4 Series
36	2.6	4.6	3.2	4.4	1.1	9.9	1.5	10.8	11.8	11.8	11.8	ZE5 Series
34	1.5	4.3	1.9	.74	3.3	1.1	4.8	1.4	6.20	6.20	6.20	ZE6 Series
30	87	39	84	85	1.4	34	2.1	1.2	2.7	2.7	2.7	8000-Series
25	20.6	3.2	26.0	5.5	44.2	8.0	63.6	10.3	82.5	10.3	82.5	XA Series
5.2	30.9	6.5	39.0	11.0	66.3	15.9	95.5	20.6	123.9	20.6	123.9	Turbo II Pump
6.2	38.6	7.8	48.7	13.3	82.9	19.1	119.3	24.8	154.7	24.8	154.7	PA-133
48	34.3	6.0	43.3	1.0	73.7	1.5	106.8	1.9	137.5	1.9	137.5	PAM 10-Series
36	3.9	4.6	4.9	2.6	3.3	1.1	11.9	1.5	15.5	1.5	15.5	Z4 Series
15	1.7	1.9	2.7	3.3	16.6	4.8	23.9	6.2	30.9	6.2	30.9	PGM2 Atlas
0.44	3.1	0.58	3.9	0.95	6.6	1.4	9.5	1.8	12.4	1.8	12.4	ZG5 Series, Briggs
0.77	3.1	0.97	3.9	1.7	6.6	2.4	9.5	3.1	12.4	3.1	12.4	ZG5 Series, Honda
0.34	1.5	0.43	1.9	0.74	3.3	1.1	4.8	1.4	6.2	1.4	6.2	ZG6 Series

Number of Pump Handle Strokes per Inch of Cylinder Plunger Travel

Cyl. Capacity ▶	5 ton		10 ton		15 ton		25 ton		30 ton		50 ton		75 ton		100 ton		Pump Type	Page	
	No Load	Load	No Load	Load	No Load	Load	No Load	Load	No Load	Load	No Load	Load	No Load	Load	No Load	Load			
▼ Power Source																			
	Manual	7	7	15	15	21	21	34	34	43	43	73	73	105	105	137	137	P-391	62
		2	7	4	15	5	21	8	34	10	43	16	73	24	105	30	137	P-392	62
		1	7	2	15	3	21	5	34	7	43	11	73	16	105	21	137	P-80/84/801	64
		1	7	1	15	1	21	2	34	3	43	5	73	7	105	9	137	P-802/842	62
1		3	1	8	1	11	1	18	1	23	2	38	2	55	3	71	P-462/464	64	

Seconds per Inch of Cylinder Plunger Travel

Cyl. Capacity ▶	5 ton		10 ton		15 ton		25 ton		30 ton		50 ton		75 ton		100 ton		Pump Type	Page		
	No Load	Load	No Load	Load	No Load	Load	No Load	Load	No Load	Load	No Load	Load	No Load	Load	No Load	Load				
▼ Power Source																				
	Electric (speed based on 60 Hz)	.05	4.0	1.1	9.0	1.6	12.6	2.6	20.6	3.2	26.0	5.5	44.2	8.0	63.6	10.3	82.5	XC Series*	68	
		.30	3.0	.67	6.7	.94	9.4	1.5	15.5	1.9	19.5	3.3	33.2	4.8	47.7	6.2	61.9	0.5 hp Economy	74	
		.08	1.0	.19	2.2	.27	3.1	.44	5.2	5.6	6.5	.95	11.1	1.4	15.9	1.8	20.7	ZU4 Series	82	
		* XC based on 28V battery	.40	3.0	.90	6.7	1.3	9.4	2.1	15.5	2.6	19.5	4.4	33.2	6.4	47.7	8.3	61.9	0.5 hp Submerged	76
			.13	1.5	.30	3.4	.42	4.7	.69	7.7	.87	9.7	1.5	16.6	2.1	23.9	2.8	30.9	ZE3 Series	88
			.09	1.0	.21	2.2	.29	3.1	.48	5.2	.60	6.5	1.0	11.1	1.5	15.9	1.9	20.6	ZE4 Series	88
.07			.50	.16	1.12	.22	1.6	.36	2.6	.46	3.2	.78	5.5	1.1	8.0	1.5	10.3	ZE5 Series	88	
.07	.30	.15	.67	.21	.94	.34	1.5	.43	1.9	.74	3.3	1.1	4.8	1.4	6.20	ZE6 Series	88			
Air (speed based on 60 Hz)	.06	.13	.13	.29	.19	.41	.30	.67	.38	.84	.65	1.4	.94	2.1	1.2	2.7	8000-Series	94		
	.05	4.0	1.1	9.0	1.6	12.6	2.6	20.6	3.2	26.0	5.5	44.2	8.0	63.6	10.3	82.5	XA Series	96		
	1.0	5.9	2.2	13.4	3.1	18.8	5.2	30.9	6.5	39.0	11.0	66.3	15.9	95.5	20.6	123.9	Turbo II Pump	98		
	1.2	7.4	2.7	16.8	3.8	23.6	6.2	38.6	7.8	48.7	13.3	82.9	19.1	119.3	24.8	154.7	PA-133	100		
	.09	6.6	.21	14.9	.29	20.9	.48	34.3	.60	43.3	1.0	73.7	1.5	106.0	1.9	137.5	PAM 10-Series	101		
Gasoline	.07	.74	.16	1.7	.22	2.4	.36	3.9	.46	4.9	.78	8.3	1.1	11.9	1.5	15.5	Z4 Series	102		
	0.3	1.5	0.7	3.4	0.9	4.7	1.5	7.7	1.9	9.7	3.3	16.6	4.8	23.9	6.2	30.9	PGM2 Atlas	105		
	0.08	0.59	0.19	1.3	0.27	1.9	0.44	3.1	0.56	3.9	0.95	6.6	1.4	9.5	1.8	12.4	ZG5 Series, Briggs	106		
	0.15	0.59	0.34	1.3	0.47	1.9	0.77	3.1	0.97	3.9	1.7	6.6	2.4	9.5	3.1	12.4	ZG5 Series, Honda	106		
	0.07	0.30	0.15	0.67	0.21	0.94	0.34	1.5	0.43	1.9	0.74	3.3	1.1	4.8	1.4	6.2	ZG6 Series	106		

No Load indicates the plunger speed as the plunger extends toward the load (1st stage).
Load indicates the plunger speed as the load is lifted at a system pressure of 10,000 psi (2nd stage).

Formula V = A ÷ Q

V (sec/in) = **A** (in²) ÷ **Q** (in³/min)

V = Cylinder plunger speed in seconds per inch

A = Cylinder effective area in square inches

Q = Pump oil flow in cubic inches

Example

At what speed (V) will the RC-308 (30 ton) cylinder move when powered by a ZE3 electric driven pump?

ZE3 pump:
Oil flow Q, (no load) is 450 in³/min

RC-308 cylinder:
Effective area A is 6.50 in²

V = 6.50 in² ÷ 450 in³/min x 60 = .87 sec/in

$$\text{Cylinder Plunger Speed (sec/in)} = \frac{\text{Cylinder Effective Area}}{\text{Pump Flow Rate}} \times \frac{60 \text{ sec}}{1}$$



Valve Information

Ways

The (oil) ports on a valve.

A 3-way valve has 3 ports:

pressure (P), tank (T), and cylinder (A).

A 4-way valve has 4 ports:

pressure (P), tank (T), advance (A) and retract (B).

Single-acting cylinders require at least a 3-way valve, and can, under certain instances, be operated with a 4-way valve.

Double-acting cylinders require a 4-way valve, providing control of the flow to each cylinder port.

Positions

The number of control points a valve can provide. A 2-position valve has the ability to control only the advance or retraction of the cylinder. To be able to control the cylinder with a hold position, the valve requires a 3rd position.

Center Configuration

The center position of a valve is the position at which there is no movement required of the hydraulic component, whether a tool or cylinder.

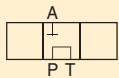

The most common is the **Tandem Center**. This configuration provides for little to no movement of the cylinder and the unloading of the pump. This provides for minimum heat build-up.

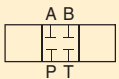

The next most common is the **Closed Center** configuration, which is used mostly for independent control of multi-cylinder applications. This configuration again provides for little to no movement of the cylinder, but also dead-heads the pump, isolating it from the circuit. Use of this type of valve may require some means of unloading the pump to prevent heat build-up.

There are many more types of valves, such as Open Center and Float Center. These valves are used mostly in complex hydraulic circuits and require other special considerations.

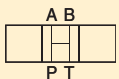

Open Center

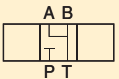

Float Center

Directional Control Valves

3-Way Valves

are used with single-acting cylinders

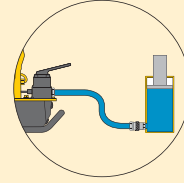

4-Way Valves

are used with double-acting cylinders

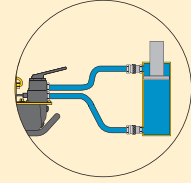

Valves may be either pump mounted or remote mounted.

Pump Mounted

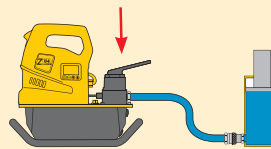

Remote Mounted

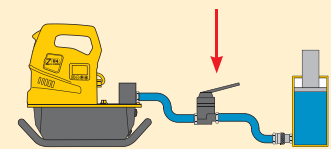

Valves may be either manually or solenoid operated.

Manually Operated

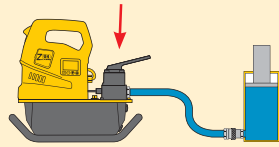

Solenoid Operated

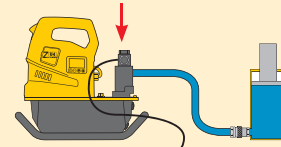

Advance Hold Retract

Single-acting cylinder

Controlled by a 3-way, 3-position valve.

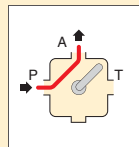

Advance

The oil flows from the pump pressure port P to the cylinder port A: the cylinder plunger will extend.

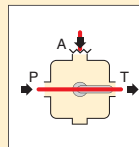

Hold

The oil flows from the pump pressure port P to the tank T. The cylinder port A is closed: the cylinder plunger will maintain its position.

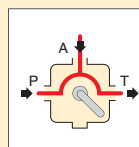

Retract

The oil flows from the pump port P and cylinder port A to the tank T: the cylinder plunger will retract.

Double-acting cylinder

Controlled by a 4-way, 3-position valve.

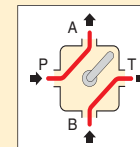

Advance

The oil flows from the pump pressure port P to the cylinder port A, and from cylinder port B to tank T: the cylinder plunger will extend.

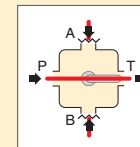

Hold

The oil flows from the pump pressure port P to the tank T. The cylinder ports A and B are closed: the cylinder plunger will maintain position.

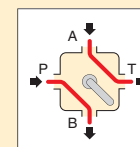

Retract

The oil flows from the pump pressure port P to cylinder port B, and from cylinder port A to tank T: the cylinder plunger will retract.



Tightening Methods

Principally there are two modes of tightening: "Uncontrolled" and "Controlled".

Uncontrolled tightening

Uses equipment and/or procedures that cannot be measured. Preload is applied to a bolt and nut assembly using a hammer and spanner or other types of impact tools.

Controlled tightening

Employs calibrated and measurable equipment, follows prescribed procedures and is carried out by trained personnel.



For further information on Torque Tightening or other controlled tightening methods, please visit www.enerpac.com.

Advantages of Controlled Tightening

Known, controllable and accurate bolt loads

Employs tooling with controllable outputs and adopts calculation to determine the required tool settings.

Safe operation following prescribed procedures

Eliminates the dangerous activities of manual uncontrolled tightening and requires that the operators be skilled and follow procedures.

Reliable and repeatable results

Using calibrated, tested equipment, following procedures and employing skilled operators achieves known results consistently.

Uniformity of bolt loading

Especially important on gasketed joints as an even and consistent compression is required for the gasket to be effective.

Reduces operational time resulting in increased productivity

Reduces tightening time and operator fatigue by replacing manual effort with the use of controlled tooling.

The right results first time

Many of the uncertainties surrounding in-service joint failures are removed by ensuring the correct assembly and tightening of the joint are carried out the first time.

What is Torque?

It is a measure of how much force acting on an object which causes that object to rotate.

What is Torque Tightening?

The application of preload to a fastener by the turning of the fastener's nut.

Torque Tightening and Preload

The amount of preload created when torqueing is largely dependant on the effects of friction.

Principally there are three different "torque components":

- torque to stretch the bolt
- torque to overcome the friction in bolt and nut threads
- torque to overcome friction at the nut spot face (bearing contact surface).

Torque Tightening

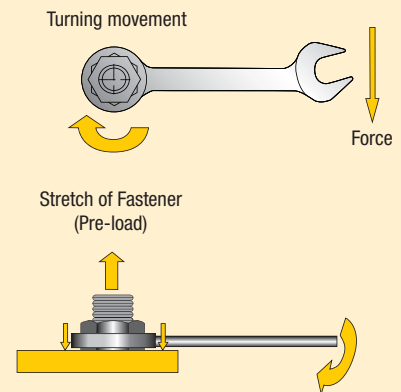

Visit www.enerpac.com to access our free on-line bolting software application and obtain information on tool selection, bolt load calculations and tool pressure settings.

A combined application data sheet and joint completion report is also available.



Torque Tightening

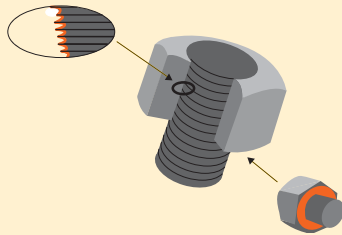

Friction points should always be lubricated when using the torque tightening method.



Preload (residual load) = Applied Torque *minus* Frictional Losses

Lubrication Reduces Friction

Lubrication reduces the friction during tightening, decreases bolt failure during installation and increases bolt service life. Variation in friction coefficients affect the amount of preload achieved at a specified torque. Higher friction results in less conversion of torque to preload. The value for the friction coefficient provided by the lubricant manufacturer must be known to accurately establish the required torque value.

Lubricant or anti-seizure compounds should be applied to both the nut bearing surface and the male threads.

Frictional Losses

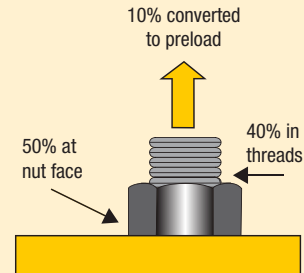

Frictional Losses (dry steel bolt)



Select the Right Wrench

Choose your Enerpac torque wrench using the untightening rule of thumb:

- When loosening a nut or bolt more torque is usually required than when tightening.
- For general conditions it can take up to 2½ times the input torque to breakout.
- Do not apply more than 75% of the maximum torque output of the tool when loosening nuts or bolts.

Conditions of bolted joints

- Humidity corrosion (rust) requires up to twice the torque required for tightening.
- Sea water and chemical corrosion requires up to 2½ times the torque required for tightening.
- Heat corrosion requires up to 3 times the torque required for tightening.



Breakout Torque

When loosening bolts a torque value higher than the tightening torque is normally required. This is mainly due to corrosion and deformations in the bolt and nut threads.

Breakout torque cannot be accurately calculated, however, depending on conditions it can take up to 2½ times the input torque to breakout.

The use of penetrating oils or anti-seize products is always recommended when performing breakout operations.

Torque Procedure

When torquing it is common to tighten only one bolt at a time, this can result in Point Loading and Load Scatter. To avoid this, torque is applied in stages following a prescribed pattern:

Torque Sequence

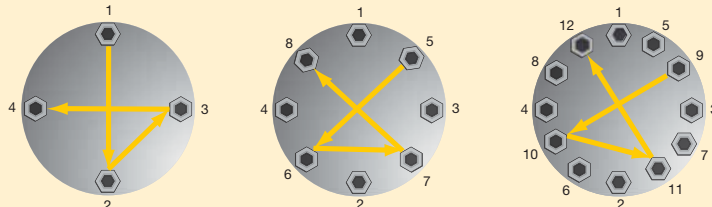

- Step 1** Spanner tight ensuring that 2 - 3 threads extend above nut
- Step 2** Tighten each bolt to one-third of the final required torque following the pattern as shown above.
- Step 3** Increase the torque to two-thirds following the pattern shown above.

- Step 4** Increase the torque to full torque following the pattern shown above.
- Step 5** Perform one final pass on each bolt working clockwise from bolt 1, at the full final torque.



ENERPAC manufactures high-force hydraulics (cylinders, pumps, valves, presses, pullers, tools, accessories and system components) for industry and construction and provides hydraulic workholding and OEM solutions to industries worldwide.

With an 80-year history of quality and innovation, the broadest line in the business, and more than 4,000 distributors and factory-trained service centers around the world, Enerpac leads the industry by setting new standards in design, strength, durability and local support. Strict quality programs, zero tolerance for defects, and ISO-9001 certification are your assurance of safe, trouble-free operation.

Enerpac is ready to tackle your toughest challenge and provide the hydraulic advantage you need to increase productivity, labor efficiency and speed of operation.



www.enerpac.com for latest Enerpac information

Visit the Enerpac Web Site and find out about:

- Learn more about hydraulics
- Promotions
- New products
- Electronic Catalogs
- Trade shows
- Manuals (instruction and repair sheets)
- Nearest Distributors & Service Centers
- Enerpac products in action
- Integrated Solutions

Ordering Products and Catalogs

To find the name of the closest Enerpac distributor or service center, to request literature or technical application assistance, contact Enerpac at one of the addresses on the next page or pose your question through E-mail: info@enerpac.com

Enerpac catalogs/brochures to meet your needs:

To obtain your copy just give us a call, or visit our Internet site **www.enerpac.com**

E412, Bolting Solutions Catalog: Caters to the complete bolting workflow, ensuring joint integrity in a variety of applications throughout industry, including: joint assembly, controlled tightening and joint separation.

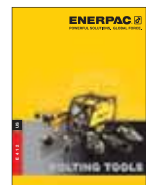

E215, Workholding Catalog: Offers innovative products and solutions to provide powerful clamping and positioning force to every type of manufacturing process. Enerpac Workholding solutions increase product quality and production output.



Integrated Solutions Capability Brochure

Enerpac's "Integrated Solutions" (IS) provides solutions to meet customer requirements for safe, precise control of movement and positioning of heavy loads. Enerpac IS combines hydraulics, steel fabrication and electronic control with engineering and application knowledge, to design and manufacture solutions that ensure customer projects are completed safely and efficiently. (#655)

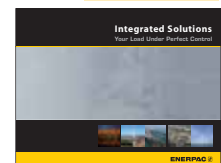

While every care has been taken in the preparation of this catalog and all data contained within is deemed accurate at the time of printing, Enerpac does reserve the right to make changes to the specifications of any product, or discontinue any product, contained within this catalog without prior notice.

All illustrations, performance specifications, weights and dimensions reflect the nominal values and slight variations may occur due to manufacturing tolerances. Please consult Enerpac if final dimensions are critical. All information in this catalog can be changed due to product improvements without prior notice.

© Copyright 2014, Enerpac.

All rights reserved. Any copying or other use of material in this catalog (text, illustrations, drawings, photos) without express written consent is prohibited.



Australia and New Zealand

Actuant Australia Ltd.
Block V Unit 3
Regents Park Estate
391 Park Road
Regents Park NSW 2143
(P.O. Box 261) Australia
T +61 297 438 988
F +61 297 438 648
sales-au@enerpac.com

Brazil

Power Packer do Brasil Ltda.
Rua dos Inocentes, 587
04764-050 - Sao Paulo (SP)
T +55 11 5687 2211
F +55 11 5686 5583
Toll Free: 0800 891 5770
vendasbrasil@enerpac.com

China

Actuant (China) Industries Co. Ltd.
No.6 Nanjing Road,
Taicang Economic Dep Zone
Jiangsu, China
T +86 0512 5328 7500
F +86 0512 5335 9690
Toll Free: +86 400 885 0369
sales-cn@enerpac.com

France, Switzerland, North Africa and French speaking African countries

ENERPAC
Une division d'ACTUANT
France S.A.S.
ZA de Courtaboeuf
32, avenue de la Baltique
91140 VILLEBON /YVETTE
France
T +33 1 60 13 68 68
F +33 1 69 20 37 50
sales-fr@enerpac.com

Germany and Austria

ENERPAC GmbH
P.O. Box 300113
D-40401 Düsseldorf
Willstätterstrasse 13
D-40549 Düsseldorf, Germany
T +49 211 471 490
F +49 211 471 49 28
sales-de@enerpac.com

India

ENERPAC Hydraulics Pvt. Ltd.
No. 1A, Peenya Industrial Area
IInd Phase, Bangalore, 560 058, India
T +91 80 40 792 777
F +91 80 40 792 792
sales-in@enerpac.com

Italy

ENERPAC S.p.A.
Via Canova 4
20094 Corsico (Milano)
T +39 02 4861 111
F +39 02 4860 1288
sales-it@enerpac.com

Japan

Applied Power Japan LTD KK
Besshocho 85-7
Kita-ku, Saitama-shi 331-0821, Japan
T +81 48 662 4911
F +81 48 662 4955
sales-jp@enerpac.com

Middle East, Egypt and Libya

ENERPAC Middle East FZE
Office 423, LOB 15
P.O. Box 18004, Jebel Ali, Dubai
United Arab Emirates
T +971 (0)4 8872686
F +971 (0)4 8872687
sales-ua@enerpac.com

Russia

Rep. office Enerpac
Russian Federation
Admirala Makarova Street 8
125212 Moscow, Russia
T +7 495 98090 91
F +7 495 98090 92
sales-ru@enerpac.com

Singapore

Actuant Asia Pte Ltd.
83 Joo Koon Circle
Singapore 629109
T +65 68 63 0611
F +65 64 84 5669
Toll Free: +1800 363 7722
sales-sg@enerpac.com

South Korea

Actuant Korea Ltd.
3Ba 717, Shihwa Industrial Complex
Jungwang-Dong, Shihung-Shi,
Kyunggi-Do
Republic of Korea 429-450
T +82 31 434 4506
F +82 31 434 4507
sales-kr@enerpac.com

Spain and Portugal

ENERPAC SPAIN, S.L.
Avda. Los Frailes, 40 - Nave C & D
Pol. Ind. Los Frailes
28814 Daganzo de Arriba
(Madrid) Spain
T +34 91 884 86 06
F +34 91 884 86 11
sales-es@enerpac.com

Sweden, Denmark, Norway,

Finland and Iceland
Enerpac Scandinavia AB
Fabriksgatan 7
412 50 Gothenburg
Sweden
T +46 (0) 31 799 0281
F +46 (0) 31 799 0010
scandinavianinquiries@enerpac.com

The Netherlands, Belgium, Luxembourg, Central and Eastern Europe, Baltic States, Greece, Turkey and CIS countries

ENERPAC B.V.
Galvanistraat 115
6716 AE Ede
P.O. Box 8097
6710 AB Ede
The Netherlands
T +31 318 535 911
F +31 318 535 848
sales-nl@enerpac.com

Enerpac Integrated Solutions B.V.

Opaalstraat 44
7554 TS Hengelo
P.O. Box 421
7550 AK Hengelo
The Netherlands
T +31 74 242 20 45
F +31 74 243 03 38
integratedsolutions@enerpac.com

South Africa and other English speaking African countries

Enerpac Africa Pty Ltd
No5 Bauhinia Avenue
Cambridge Office Park
Block E
Highveld techno Park
Centurion 0157
South Africa
T: +0027 (0) 12 940 0656
sales-za@enerpac.com

United Kingdom and Ireland

ENERPAC Ltd.,
Bentley Road South
Darlaston, West Midlands
WS10 8LQ
England
T +44 (0)121 50 50 787
F +44 (0)121 50 50 799
sales-uk@enerpac.com

USA, Latin America and Caribbean

ENERPAC
P.O. Box 3241
Milwaukee, WI 53201 USA
T +1 262 293 1600
F +1 262 293 7036
User inquiries:
+1 800 433 2766
Distributor inquiries/orders:
T +1 800 558 0530
F +1 800 628 0490
Technical inquiries:
techservices@enerpac.com
sales-us@enerpac.com

03/2014

Model Number Index

Section Index

Page(s)	Page(s)	Page(s)	Page(s)
A	EMB	N	SPK
A 116-118, 138-139, . 138-139, 140, 173	EP 170	NC 221	SPMU 233
A5-A10 162	EPH 154-157	NCB 221	SRS 185
A12 10	EPP 150-153	NS 222-223	STB 176-177
A13-A28 162	EPT 154	NV 127	STC 174
A29-A53 10	EPX 153	P	STF 225
A64-A66 118	ER 170-171	P ... 52-53, 58-67	STN 221
A92 162, 173	ES 170-171	P392AL 59	STP 165
A102 10, 33	EVO 234	P392FP 64	SW 225
A128-A192 162-163	F	PA 98	T
A185 163	FF 116-117	PAM 99	T 124
A200R 140	F 227	PAMG 96-97	THC 206, 212, 214
A205-A220 ... 138	FH 116-117	PATG 96-97	THQ. 206, 212, 214
A218 162	FR 116-117	PARG 96-97	TM 142
A242-A305 ... 162	FS 224	PC 60	TQ 208-209
A252 10, 33	FSB 225	PE .. 72-75, 90-91	TSP 185, 200
A258 138	FSH 225	PEM 90-91	V
A310, A330 ... 138	FSM 225	PER 90-91	V ... 52-53, 127, 128-129
A530-A595 162-163	FZ 119	PGM 102	VA2 99
A604 116-117	G	PK 140	VC 108-109
A607 163	GA 122-123	PMB 140	VE 106-111
A630 116-117	G 126-127	PMU 203	VM 106-109
A650 163	GBJ 49	PR 50-51	W
AD 31, 140	GF 120-121	PTA 212-213	W 188-196
AH 116-117	GP 120-121	PU 70-71	WCB 174-175
AM 118	H	R	WCR 198-199
AR 116-117	HA 115, 122-123	RA 11	WHC 174
ATM 226	H 115, 122-123	RAC 12-13	WHR 174
ATP 220	HA 115	RACH 16-17	WMC 175
AW 20	HB 115	RACL 14-15	WR 163, 173
B	HC 115	RAR 18-19	WRP 200
B 237-238	HF 118	RB 10	WTE 200
BHP 146-149	HP 27, 29	RC .. 6-10, 52-53	X
BRC 24-25	HSK 232	RCH 26-27	XA 94-95
BRP 24-25	HSL 231	RCS 22-23	XC 68-69
BSH 186	I	RD 30-31	Z
BZ 177	IP 132-135, ... 138-139, 140-141	REB 10	Z 117
C	IPL 140	REP 10	Z 92-93
C 116-117	IPR 136-137	RFL 95	ZA 204, 214-217
CAT . 10, 23, 33, 47	J	RR 32-35	ZC 82, 88-89
CATG 13, 15	JBI 10	RRH 28-29	ZE 77, 84-89
..... 19, 39, 43	JH 48	RSM 22-23	ZE 210-211
CD 117	JHA 48	RTE 185	ZG 100-101
CH 117	L	RWH 146-147	ZH 83, 89, 207
CLL 44-47	LH 142	S	ZL 83, 88
CLP 20-21	LW 168	S 182-185	ZP .. 82-83, 88-89
CLRG 40-43	LX 118	SB ... 82, 88, 207, 217, 225	ZR 82-83, 88, 207, 217
CLSG 36-39	M	SBL 230	ZU 78-83
CM 172	M 237-238	SC 54-55	ZU4T ... 204-207
CR 116-117	MP 65	SCH 54-55	ZUTP ... 218-219
CT 117	MS 160-163	SCL 54-55	ZTM 207, 217
CW 146	MSP 164-165	SCP 54-55	
D	MTW 180	SCR 54-55	
DGR 125	MZ 162-163	SDA 184	
E		SL 230	
E 180-181		SLCG 234	
EGM 103		SOH 169	
ELP 170-171		SP 164-167	
		SPD 164-165	



Cylinders and Lifting Products
Page 4-55



Pumps & Directional Control Valves
Page 56-111



System Components & Control Valves
Page 112-129



Presses
Page 130-143



Pullers
Page 144-157



Tools
Page 158-177



Bolting Tools
Page 178-227



Integrated Solutions
Page 228-240





Cylinders, Lifting Products & Systems

Pages 4–55



Pumps & Directional Control Valves

Pages 56–111



System Components & Control Valves

Pages 112–129



Presses

Pages 130–143



Pullers

Pages 144–157



Tools

Pages 158–177



Bolting Tools

Pages 178–227



Integrated Solutions

Pages 228–240

Australia and New Zealand

Actuant Australia Ltd.
Tel: +61 297 438 988 – Fax: +61 297 438 648

Brazil

Power Packer do Brasil Ltda.
Tel: +55 11 5687 2211 – Fax: +55 11 5686 5583
Toll Free: 0800 891 5770

China

Actuant (China) Industries Co., Ltd.
Toll Free: +86 400 885 0369
Tel: +86 0512 5328 7500 – Fax: +86 0512 5335 9690

France, Switzerland, North Africa and French speaking African countries

ENERPAC
Tel: +33 1 60 13 68 68 – Fax: +33 1 69 20 37 50

Germany and Austria

ENERPAC GmbH
Tel: +49 211 471 490 – Fax: +49 211 471 49 28

India

ENERPAC Hydraulics Pvt. Ltd.
Tel: +91 80 40 792 777 – Fax: +91 80 40 792 792

Italy

ENERPAC S.p.A.
Tel: +39 02 4861 111 – Fax: +39 02 4860 1288

Japan

Applied Power Japan LTD KK
Tel: +81 48 662 4911 – Fax: +81 48 662 4955

Middle East, Egypt and Libya

ENERPAC Middle East FZE
Tel: +971 (0)4 8872686 – Fax: +971 (0)4 8872687

Russia

Rep. office Enerpac
Tel: +7 495 98090 91 – Fax: +7 495 98090 92

Singapore

Actuant Asia Pte Ltd.
Tel: +65 68 63 0611 – Fax: +65 64 84 5669
Toll Free: +1800 363 7722

South Korea

Actuant Korea Ltd.
Tel: +82 31 434 4506 – Fax: +82 31 434 4507

Spain and Portugal

ENERPAC SPAIN, S.L.
Tel: +34 91 884 86 06 – Fax: +34 91 884 86 11

Sweden, Denmark, Norway, Finland and Iceland

Enerpac Scandinavia AB
Tel: +46 (0) 31 799 0281 – Fax: +46 (0) 31 799 0010

The Netherlands, Belgium, Luxembourg, Central and Eastern Europe, Baltic States, Greece, Turkey and CIS countries

ENERPAC B.V.
Tel: +31 318 535 911 – Fax: +31 318 535 848

Enerpac Integrated Solutions B.V.

Tel: +31 74 242 20 45 – Fax: +31 74 243 03 38

South Africa and other English speaking African countries

ENERPAC Africa (PTY) Ltd.
Tel: +0027 (0) 12 940 0656

United Kingdom and Ireland

ENERPAC Ltd.
Tel: +44 (0)121 50 50 787 – Fax: +44 (0)121 50 50 799

USA, Latin America and Caribbean

ENERPAC
Tel: +1 262 293 1600 – Fax: +1 262 293 7036

User inquiries: +1 800 433 2766
Distributor inquiries/orders:
Tel: +1 800 558 0530 – Fax: +1 800 628 0490

For complete list of addresses: page 256

e-mail: info@enerpac.com
internet: www.enerpac.com

Enerpac © 2014
100_R_US



ENERPAC

POWERFUL SOLUTIONS. GLOBAL FORCE.