

Project:	Type:	Prepared By:	Date:
-----------------	--------------	---------------------	--------------



Features and Benefits

- Energy-efficient replacement for incandescent and halogen lamps
- Durable plastic construction reduces risk of breakage
- Rated for use in enclosed and open fixtures in dry or damp locations
- Frosted lens delivers smooth, diffuse light
- Longer lifespan compared to legacy equivalents minimizes replacement and maintenance costs

Technical Specifications		
<p>Performance</p> <p>Product Type: A-Line 80CRI Non Dimmable</p> <p>Description: Replace conventional general purpose bulbs in open or enclosed fixtures in dry or damp environments.</p> <p>Wattage Equivalency: 100W Incandescent</p> <p>Input Wattage: 16W</p> <p>Lumens: 1,600lm</p> <p>Efficacy: 100lm/W</p> <p>L70 Lifespan: 15,000-Hour LED lifespan based on IES LM-70 results</p>	<p>Electrical</p> <p>Power Factor: ≥0.7</p> <p>Dimmable: No</p> <p>Input Voltage: 120V</p> <p>Operating Frequency: 60 Hz</p> <p>Input Current @ 120V (mA): 130mA</p> <p>Operating Temperature: -13°F to 113°F (-25°C to 45°C)</p> <p>LED Characteristics</p> <p>Beam Angle: 230°</p> <p>Color Temperature: 5000K</p>	<p>Color Accuracy (CRI): ≥80 CRI</p> <p>R9 Value: High color performance with R9 no greater than 0</p> <p>Color Consistency: <6-step MacAdam Ellipse binning to achieve consistent fixture-to-fixture color</p> <p>Installation</p> <p>Base Type: E26 Edison</p> <p>Construction</p> <p>Finish: White</p> <p>Bulb Shape: A21</p> <p>Endcap Material: Metal</p> <p>Enclosure Material: Plastic</p>

Technical Specifications (continued)

Lens Finish:

Frosted

Compliance

Listings:

UL Listed

Environment:

Suitable for use in dry and damp environments

Fixture Rating:

Suitable for use in enclosed fixtures

Energy Star Approved:

This product is ENERGY STAR® Version 2.2 Certified

T20 Compliant:

Not compliant

California Title 24 JA8 Compliant:

Not Compliant

California Energy Commission (CEC) Status:

Not Lawful for Sales in California

RoHS:

Mercury and UV free. RoHS-compliant components.

FCC:

Complies with Part 15B of the FCC Rules

Other

Warranty:

RAB warrants that our LED products will be free from defects in materials and workmanship for a period of three (3) years from the date of delivery to the end user, including coverage of light output, color stability, driver performance and fixture finish. RAB's warranty is subject to all terms and conditions found at rablighting.com/warranty.

\

Case and Pallet Dimensions

	QTY	LENGTH (in)	WIDTH (in)	HEIGHT (in)
CASE	12	12.8	9.7	6
PALLET	1260	43.9	40.3	50

Dimension

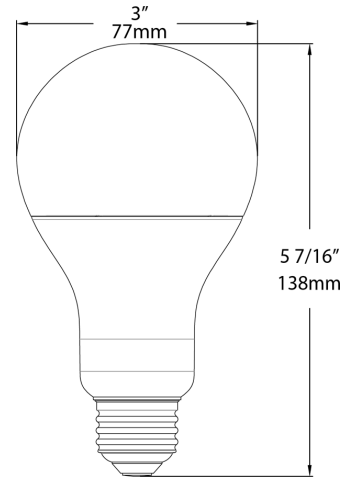

Light Distribution

