

BALDOR • RELIANCE

Customer information packet

CPX36646T

60HP, 1780RPM, 3PH, 60HZ, 364T

Class - CLI GP C,D; CLII GP E,F,G

Division - Division I

Specifications

Enclosure	TEFC
Frame	364T
Frame Material	Iron
Frequency	60.00 Hz
Haz Area Class and Group	CLI GP C,D; CLII GP E,F,G
Haz Area Division	Division I
Motor Letter Type	Three Phase
Output @ Frequency	60.000 HP @ 60 HZ
Phase	3
Synchronous Speed @ Frequency	1800 RPM @ 60 HZ
Voltage @ Frequency	230.0 V @ 60 HZ 460.0 V @ 60 HZ
Agency Approvals	CCSAUSEEV CSA UL
Ambient Temperature	40 °C
Auxillary Box	No Auxillary Box
Base Indicator	Rigid
Bearing Grease Type	Polyrex EM (-20F +300F)
Constant Torque Speed Range	10-60
Current @ Voltage	67.800 A @ 460.0 V 136.000 A @ 230.0 V
Design Code	B
Drip Cover	No Drip Cover
Duty Rating	CONT
Efficiency @ 100% Load	95.0 %
Enclosure Modification	Severe Duty Features
Feedback Device	NO FEEDBACK
Haz Area Temp Code	T3C
Heater Indicator	No Heater
High Voltage Full Load Amps	67.8 a
Insulation Class	F

Part detail

Revision	F
Type	AC
Mech. spec.	
Base	
Status	PRD/A
Elec. spec.	A36WG1727
Layout	616512-505
Eff. date	05-06-2024
CD Diagram	416820-002
Poles	04
Leads	3#4,6#6
Proprietary	False
Created date	02-07-2019

Inverter Code	Not Inverter
IP Rating	IP55
KVA Code	G
Lifting Lugs	Standard Lifting Lugs
Max Speed	3600 rpm
Motor Lead Quantity/Wire Size	3 @ 4 AWG
Motor Standards	NEMA
Motor Type	A36062M
Mounting Arrangement	F1
Number of Poles	4
Overall Length	33.48 IN
Power Factor	87
Product Family	General Industrial
Pulley End Bearing Type	Ball
Pulley Face Code	Standard
Service Factor	1.15
Shaft Diameter	2.374 IN
Shaft Ground Indicator	No Shaft Grounding
Shaft Rotation	Reversible
Shaft Slinger Indicator	Shaft Slinger
Speed	1780 rpm
Speed Code	Single Speed
Starting Method	Direct on line
Thermal Device - Bearing	None
Thermal Device - Winding	Normally Closed Thermostat

Nameplate

NP2496L	
MOBIL POLYREX EM	

000613006PC

CLASS I GROUP C D X **NO.****CLASS II GROUP** E F G**OPERATING TEMP CODE** T3C

000901002AAA

SUIT @ 55C AMB AT 1.00 SF AT

SINEWAVE

NP3140L

SPEC NO.	A36-7437-1727	CAT.NO.	CPX36646T	FRAME	364T
HP	60	VOLTS	230/460	PHASE	3
RPM	1780	AMPS	136/67.8	HZ	60
DRIVE END BEARING	65BC03J30X	DUTY	CONT	INSUL.CLASS	F
OPP D.E. BEARING	65BC03J30X	ENCL	TEFC	CODE	G
SF	1.15	WK2	14.5	MAG CUR	21.8
CT HZ	10-60	VT HZ	0-60	CHP HZ	60-90
	IP66			RPM MAX	3600
SER.NO.		MOTOR WEIGHT		NEMA-NOM-EFF	95

DUTY MASTER ALTERNATING CURRENT MOTORS

616512-505

SQUIRREL-CAGE INDUCTION

ENCLOSURE: TOTALLY ENCLOSED

FRAME 365T

COOLING: FAN-COOLED

MOUNTING: FOOT, F-1 SIDE

INCLUDES 364T FRAME MOUNTING HOLES
CLASS 1 GROUP C&D / CLASS 2 GROUP E,F & G
WITH TACONITE SEAL BOTH ENDS

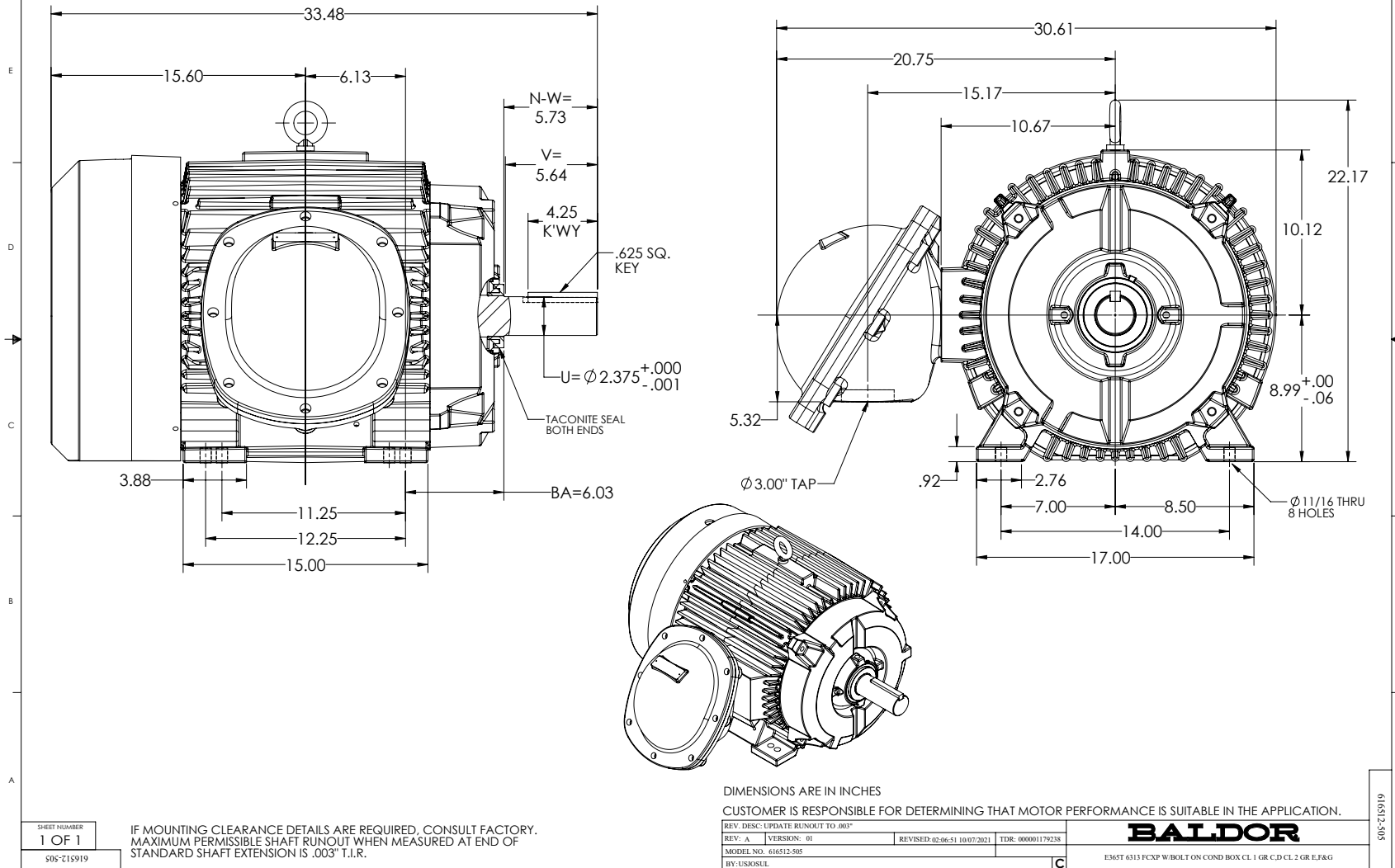

CONNECTION DIAGRAM ACCESSORIES

MOTOR WINDING THERMOSTATS	
CONTACTS _____ @ _____ °C	
FIGURE NUMBER _____	
CONTACT RATING	
VOLTS	CONTINUOUS AMPERES
110-120	3.0
220-240	1.5
440-480	0.75
550-600	0.60
	INRUSH AMPERES
	30
	15
	7.5
	6.0

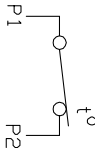
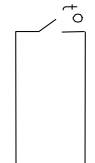
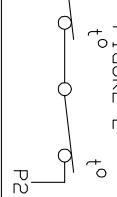
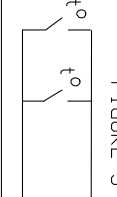
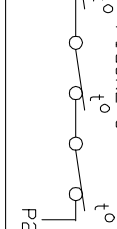
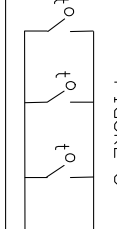
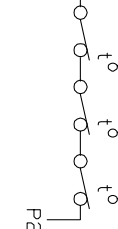
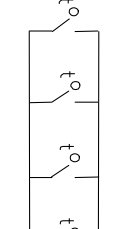
NORMALLY CLOSED	THERMOSTATS	NORMALLY OPEN
 <p>FIGURE 1</p>		 <p>FIGURE 4</p>
 <p>FIGURE 2</p>		 <p>FIGURE 5</p>
 <p>FIGURE 3</p>		 <p>FIGURE 6</p>
 <p>FIGURE 7</p>		 <p>FIGURE 8</p>

CUSTOMER _____ CUSTOMER ORDER NO. _____ S.O. NO. _____

418174-006

418174-006

REV. DESC: LOADED TO BUS		
REV. LTR: A	VERSION: 01	TDR: 000000570390
FILE: \RAG\00013\849	REVISED: 10:16:21 12/07/2010	BY: RAGDRF
MTL: -		

BALDOR

A-C MOTOR CONNECTION ACCESSORIES

SH 1 of 1

416820-002

A-C MOTOR
 CONNECTION DIAGRAM
 STANDARD 9 LEAD DELTA-CONNECTED

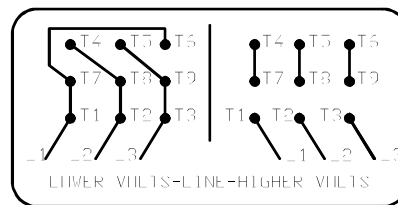
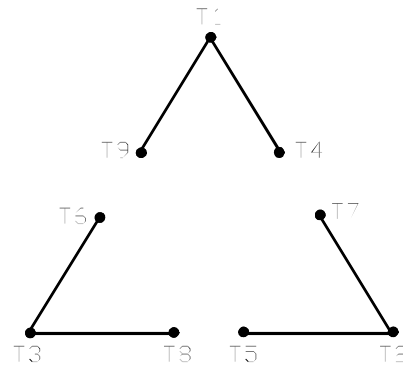

(N.P. 1575-B)

416820-002

REV. DESC: FONT CHANGE FOR PDF SEARCHABLE		
REV. LTR: A	VERSION: 01	TDR: 000001009382
FILE: \MGA\00000\661	REVISED: 02:46:19 02/13/2020	BY: MGHMTT
MTL: -		© □

BALDOR - RELIANCE®

CONN DIAG - STANDARD 9 LEAD, DELTA-CONNECTED

SH 1 of 1