

PART#: RSC121210NKSS
(DATA SUBJECT TO CHANGE WITHOUT NOTICE)

THIS DRAWING IS PROPERTY OF HUBBELL INC. WIEGMANN
 ALL INFORMATION IS PROPRIETARY AND NOT TO BE DUPLICATED

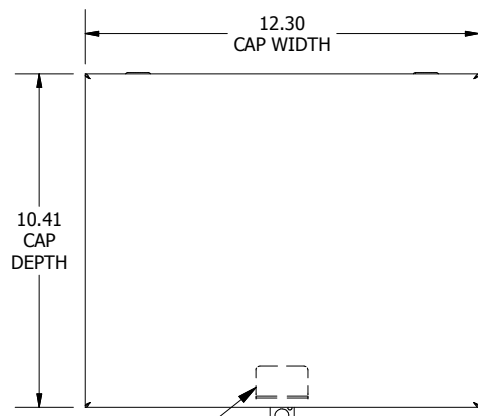

TOP VIEW

LID BRACKET
 WELDED TO CAP

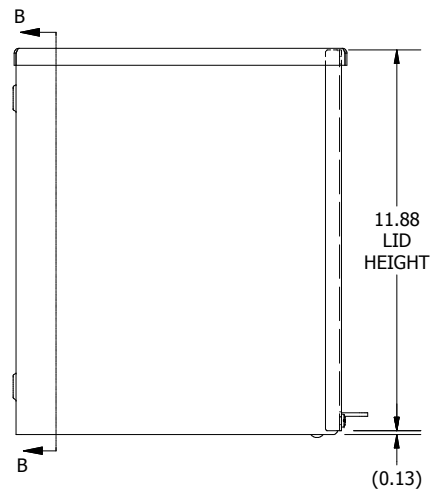

LEFT SIDE VIEW

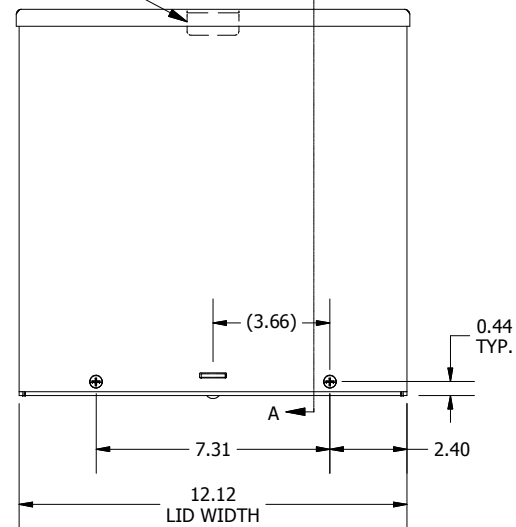

FRONT VIEW

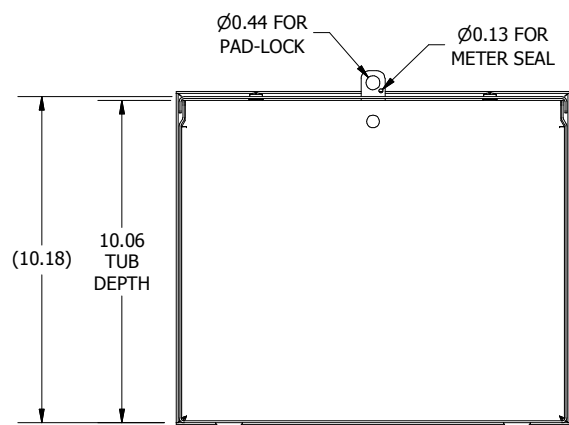

BOTTOM VIEW

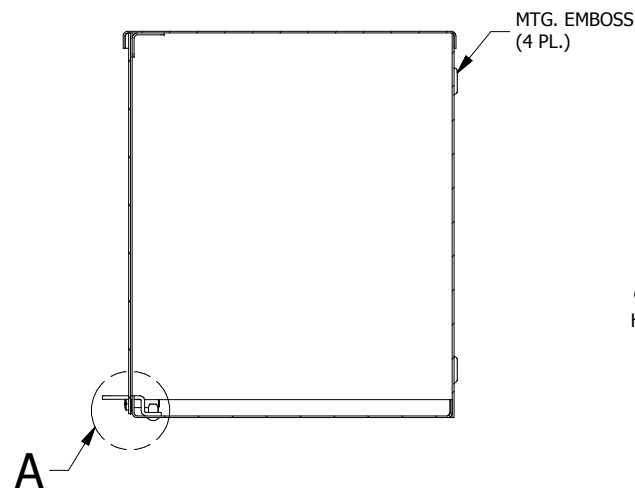

SECTION A-A
 (INSIDE LEFT OF ENCL.)

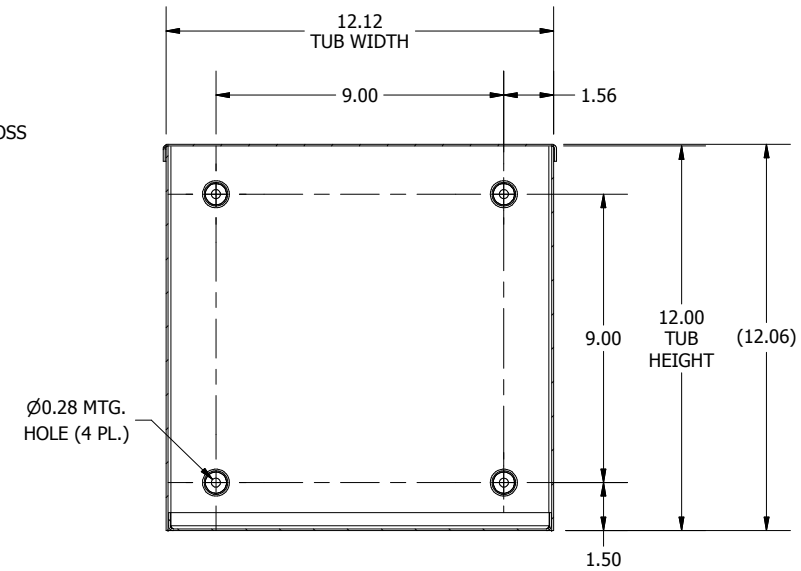

SECTION B-B
 (INSIDE BACK OF ENCL.)

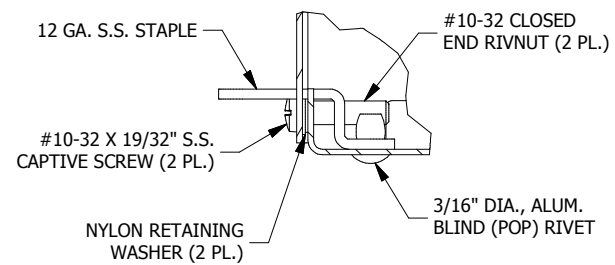

DETAIL A
 (STAPLE & SCREW DETAIL)

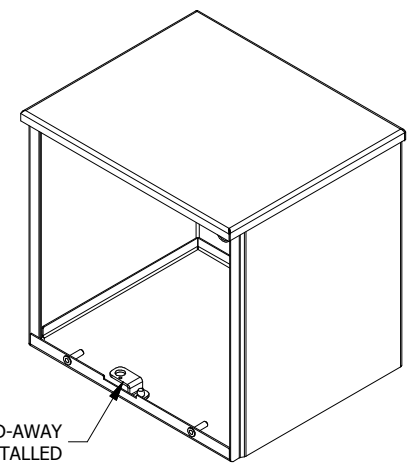
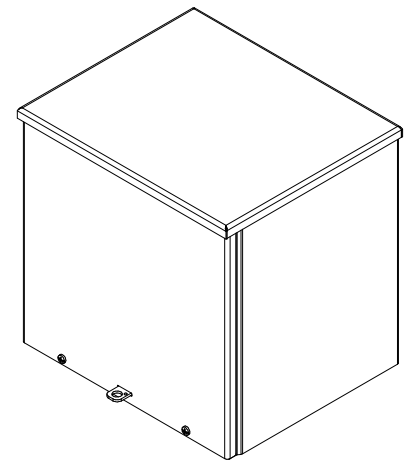

12 GA. S.S., FOLD-AWAY
 STAPLE INSTALLED