

Table of Contents

Air Chief Profile Chart.....	3
Industrial Interchange Couplings	4-5
Automotive Interchange Coupling	6
ARO Speed Couplings	7
Lincoln Series Couplings	8
Universal Couplings.....	9
Blow Guns	10-11
Filters, Regulators, Lubricators.....	12
Gauges.....	13-15
Ferrules & Equipment.....	16
Tubing & Cutters	17
Compression & Push-In Fittings.....	18
Air Hoses.....	19
Mini In-Line FRL's	20
Pinch-On Clamps	21
Ball Valves.....	22-27
Safety Check Valve	28
King Safety Cables.....	29
Air Accessories.....	30
Technical Information.....	31-35



Safety

Dixon's couplings and retention devices are designed to work safely for their intended use. The selection of the proper hose, coupling and retention device, and the proper application of the coupling to the hose are of utmost importance.

Users must consider the size, temperature, application, media, pressure and hose and coupling manufacturer's recommendations when selecting the proper hose assembly components. Dixon recommends that all hose assemblies be tested in accordance with the Association for Rubber Products Manufacturer's (ARPM) recommendations and be inspected regularly (before each use) to ensure that they are not damaged or have become loose. Visit ARPMINC.com for more information.

Where safety devices are integral to the coupling, they must be working and utilized. The use of supplementary safety devices such as safety clips or safety cables are recommended.

If any problem is detected, couplings must be removed from service immediately.

Dixon is available to consult, train and recommend the proper selection and application of all fittings we sell. We strongly recommend that distributors and end users make use of Dixon's Testing and Recommendation Services. Call 877.963.4966 or click dixonvalve.com to learn more.

The Importance of Whip Hose



The constant vibration created by air tools, like air drills and pavement breakers, is destructive to air hose couplings, especially the quick-acting type. To provide protection against coupling breakage and related hazards, Dixon recommends the use of a whip hose. To construct a whip hose, connect one end of a short (3' to 10') air hose to the air tool using a 3500 type steel nipple. Connect the other end of the hose to the air supply using the standard quick-acting coupling. The heat-treated 3500 nipple will withstand vibration far better than the standard coupling and provide a safer connection. The whip hose should remain permanently connected to the tool.

Actual Size

Profile Chart

For easy identification of the four major styles of air quick disconnect plugs

Use:

- This chart may be used to identify the style of air chief fittings.

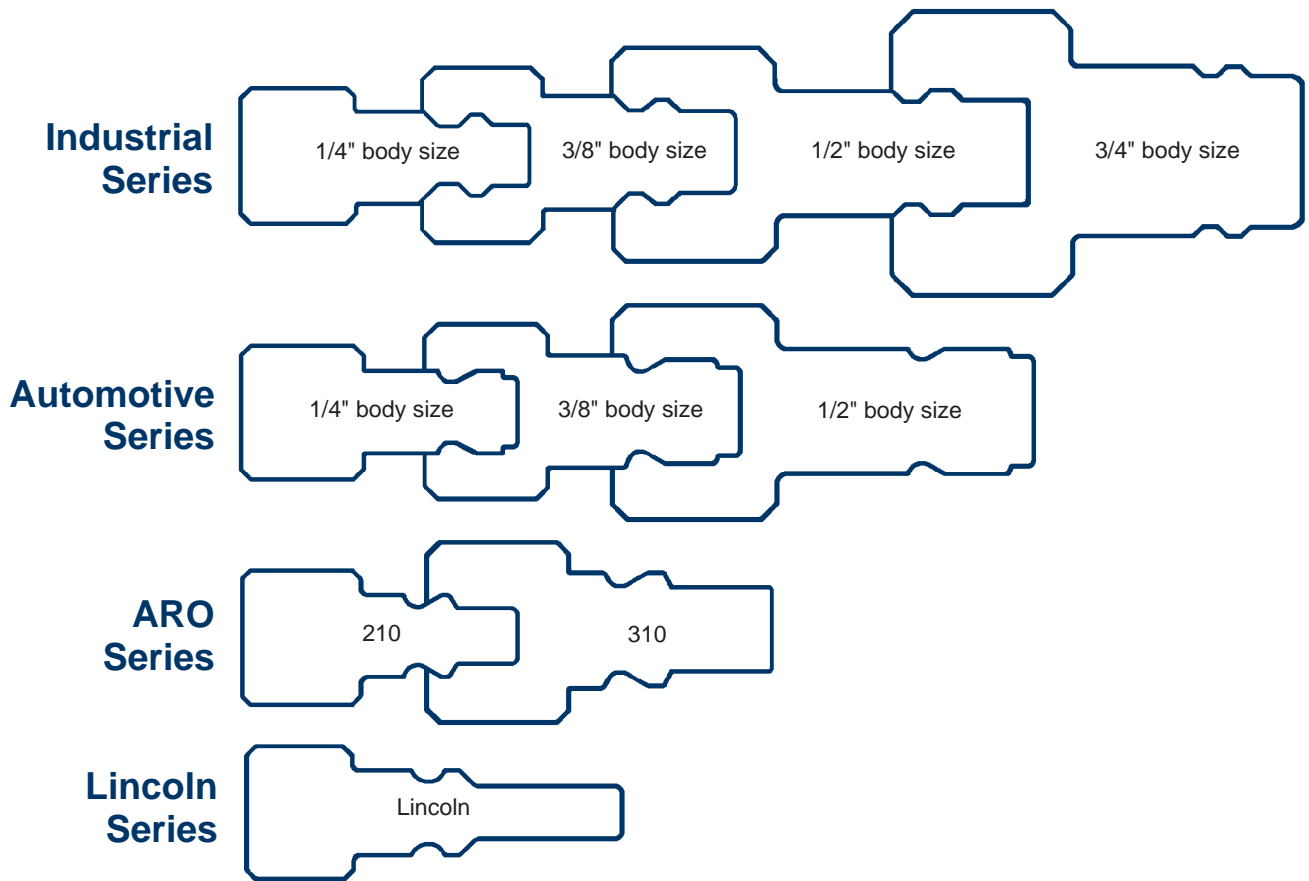

Notes:

- 1/2" industrial series may also interchange with 1/2" automotive series

Air Chief

Industrial Interchange Couplings

Air Chief industrial quick-connect plugs and couplers are able to interchange with many other styles

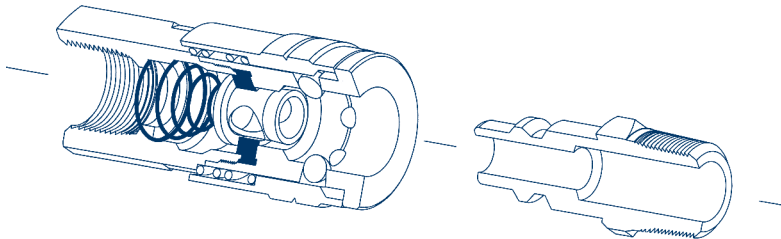

Service:

- rated to **300 PSI**
- temperature range: **-40° to 250°F**

Features:

- *For air service only.*
- couplers shut-off when disconnected



Materials:

- steel
- brass
- 303 stainless steel

Connecting:

- semi-automatic couplers
A sleeve guard design reduces the risk of unintentional disconnection.
- automatic couplers
Allows one hand operation.

Disconnecting:

- pull

Interchange:

- interchangeable with MIL-C-4109F/A-A-59439

Configurations:

- female pipe thread
- male pipe thread
- standard hose barb
- push-on hose barb

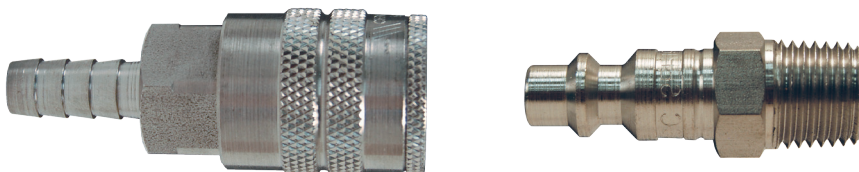

Angled Swivel Plug

Applications:

- Angled swivel plugs are lightweight and streamlined. They can be used in the automotive and electronics industries, workstations, commercial and residential construction, and robotic joints. Helps alleviate carpal tunnel syndrome and back stress resulting in fewer lost time injuries.

Service:

- rated to **145 PSI**
- temperature range: **20°F to 140°F**

Features:

- *For air service only.*
- 360° circular rotation and 45° angled rotation
- male NPT

Materials:

- body is nickel-plated steel
- dust cover is polyurethane



Legris Industrial Interchange Automatic Safety Couplers

Applications:

- This innovative safety coupler has an unique two-turn release that quickly vents downstream air pressure before disconnecting, preventing serious injuries associated with hose whip. It is made with a tough composite material which will stand up to the most abusive applications, yet is lightweight.

Features:

- 1/4" body size ensures an excellent flow and total security due to disconnection in two steps
- Automatic connection: simply push the plug into the coupler until it clicks; no rotation of the coupler is necessary to make the connection.
- Perfectly suited for numerous installations including:
 - pneumatic tools
 - blow guns
 - pneumatic automotive equipment
- composite, non-marring body
- compatible with industrial interchange plugs
- male NPT and female NPT
- rated to **230 PSI**
- temperature range: **-4°F to 140°F**

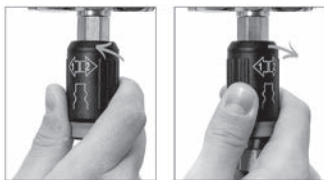

1. vents plug

2. disconnects



Air Chief

Automotive Interchange Couplings

Air Chief automotive quick-connect plugs and couplers are completely compatible with the "Truflate" coupling system.

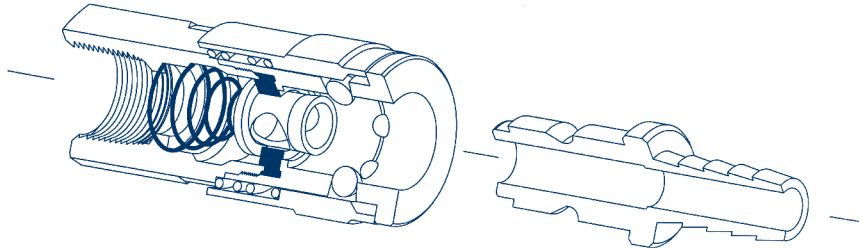

Service:

- rated to **300 PSI**
- temperature range: **-40° to 250°F**

Features:

- couplers shut-off when disconnected

Materials:

- steel
- brass

Connecting:

- semi-automatic couplers
A sleeve guard design reduces the risk of unintentional disconnection.

Disconnecting:

- pull

Interchange:

- interchangeable with Amflo, Dill, Milton and Truflate
- There are some models which do not interchange.
If you plan to interchange these couplings, make sure you have plug ends with the proper configuration.

Configurations:

- female pipe thread
- male pipe thread
- standard hose barb
- push-on hose barb



Air Chief

ARO Speed Couplings

Air Chief ARO Speed quick-connect plugs and couplers are completely compatible with the ARO 210/310 series coupling system.

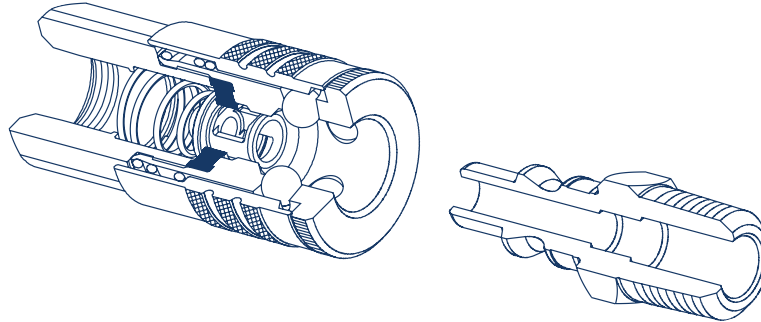
Service:

- rated to **300 PSI**
- temperature range: **-40° to 250°F**

Features:

- couplers shut-off when disconnected

Materials:

- steel
- brass

Connecting:

- semi-automatic couplers
- *A sleeve guard design reduces the risk of unintentional disconnection.*

Disconnecting:

- pull

Interchange:

- interchangeable with ARO210 and 310 designs

Configurations:

- female pipe thread
- male pipe thread
- standard hose barb
- push-on hose barb



Air Chief

Lincoln Series Couplings

Air Chief Lincoln series quick-connect plugs and couplers are completely compatible with the Lincoln "Flex-O-Matic" (also known as the "Long Nose") coupling system.

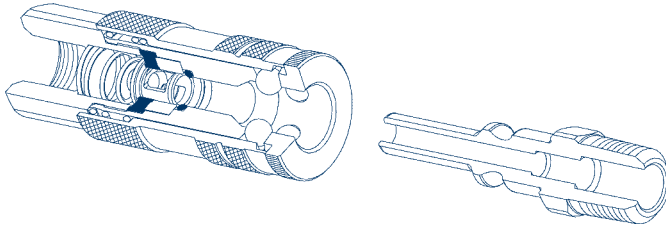

Service:

- rated to **300 PSI**
- temperature range: **-40° to 250°F**

Features:

- couplers shut-off when disconnected

Materials:

- steel
- brass

Connecting:

- semi-automatic couplers
A sleeve guard design reduces the risk of unintentional disconnection.

Disconnecting:

- pull

Interchange:

- interchangeable with Lincoln's long stem series

Configurations:

- female pipe thread
- male pipe thread

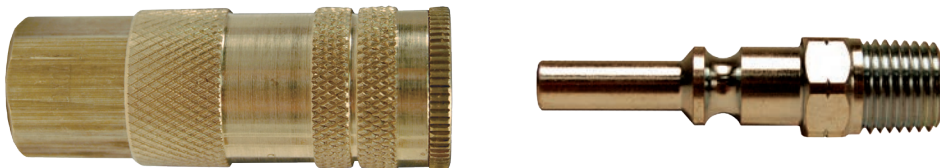

Air Chief

Universal Couplings

Air Chief Universal quick-connect fittings are designed for use in compressed air service.

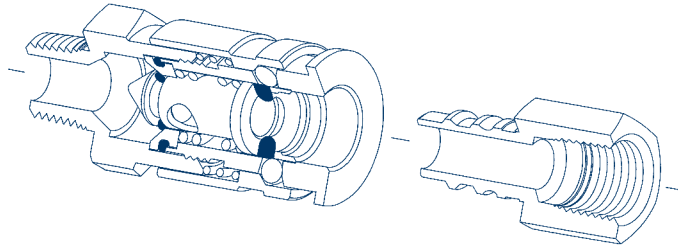
Service:

- rated to **300 PSI**
- temperature range: **-40° to 250°F**

Features:

- shut-off when disconnected
- euro-style valving ensures maximum flow performance

Material:

- brass

Connecting:

- automatic couplers
- *A sleeve guard design reduces the risk of unintentional disconnection.*

Disconnecting:

- pull

Interchange:

- interchangeable with MIL-C-4109F, ARO210, Truflate, Lincoln, Italian standard and CEJN 320

Configurations:

- female pipe thread
- male pipe thread
- standard hose bard

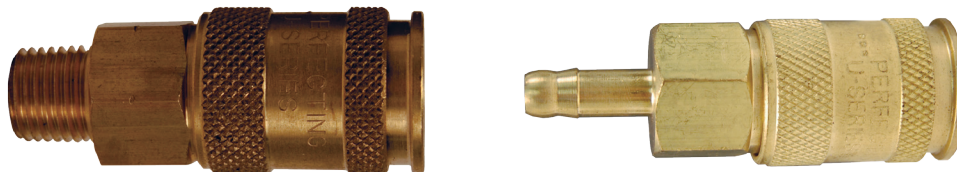

Dixon

Blow Guns

Blow guns offer the user a safe method of directing pressurized air for a specific need.



Safety blow guns have a safety tip which prevents buildup of tip pressure in the event the outlet is obstructed or "dead ended". They comply with the requirements for OSHA 1910.242 (B) and 1910.95 when used on air lines of 150 PSI or less.

Features:

- design comfortably fits contour of the hand minimizing user fatigue
- ergonomic large lever with black vinyl grip allows for easy air flow activation
- ¼" female NPT inlet

Air Chief Safety



The air chief safety blow gun is designed to conform to OSHA Standard 1910.242 (B) permitting a maximum of 30 PSI outlet pressure when dead ended based on a maximum of 150 PSI inlet pressure as well as OSHA Standard 1910.95 regulating occupational noise level exposure. *Safety glasses or shield must be worn when using any blow gun.*



Features:

- recessed internal slotted screw allows easy access to valve assembly for repairs or replacement
- chrome plated zinc die cast body, nickel plated steel lever, vinyl thumb grip, stainless steel spring, brass valve, Buna-N seals and nickel plated brass tip combine for superior corrosion resistance

Part #

D204-30

Premium Safety



The premium safety blow gun is designed to conform to OSHA Standard 1910.242 (B) permitting a maximum of 30 PSI outlet pressure when dead ended based on a maximum of 150 PSI inlet pressure as well as OSHA Standard 1910.95 regulating occupational noise level exposure. *Safety glasses or shield must be worn when using any blow gun.*



Feature:

- zinc die cast body with a black powder coat finish, nickel plated steel lever, vinyl thumb grip, stainless steel spring, brass valve, Buna-N seals and nickel plated brass tip

Part #

D204-30P

Safety Air Booster



The multiple holes in the safety booster tip of the safety air booster gun create a venturi effect that increases air flow (working capacity) while still remaining compliant with OSHA Standard 1910.242 (B). *Safety glasses or shield must be worn when using any blow gun.*



Feature:

- chrome plated zinc die cast body, nickel plated steel lever, vinyl thumb grip, stainless steel spring, brass valve, Buna-N seals and nickel plated brass tip provide superior corrosion resistance

Part #

D204-30SB

Non-Safety Brass Tipped

! Non-Safety blow guns **do not** have a safety by-pass to prevent buildup of tip pressure in the event of tip blockage. They may be used for cleaning purposes only if the air supply (inlet pressure) has been reduced to 30 PSI or less. The ventless, nickel-plated tip provides the most economical means of achieving a concentrated stream of air for many blow-off applications. All other components and design features are the same as our Air Chief safety blow gun (D204-30). *Must be used on air lines having a maximum regulated pressure of 30 PSI in order to comply with OSHA Standard 1910.242 (B). Safety glasses or shield must be worn when using any blow gun.*

Feature:

- chrome plated zinc die cast body, nickel plated steel lever, vinyl thumb grip, stainless steel spring, brass valve, Buna-N seals and ventless, nickel plated brass tip provide superior corrosion resistance



Part #

D605

Non-Safety Rubber Tipped

! Non-Safety blow guns **do not** have a safety by-pass to prevent buildup of tip pressure in the event of tip blockage. They may be used for cleaning purposes only if the air supply (inlet pressure) has been reduced to 30 PSI or less. The rubber tip will not scratch or mar delicate surfaces. The conical, rubber tip can also be used to create a seal between the blow gun and fluid lines (or any other opening). Base of the tip is nickel-plated brass for additional corrosion resistance. *Must be used on air lines having a maximum regulated pressure of 30 PSI in order to comply with OSHA Standard 1910.242 (B). Safety glasses or shield must be worn when using any blow gun.*

Feature:

- chrome plated zinc die cast body, nickel plated steel lever, vinyl thumb grip, stainless steel spring, brass valve, Buna-N seals and rubber tip with a nickel plated brass base provide superior corrosion resistance



Part #

D201

Features:

- conforms to US Department of Labor, OSHA Standard 1910.242 (B) allowing a maximum of 30 PSI outlet pressure at the nozzle when dead-ended
- conforms to US Department of Labor, OSHA Standard 1910.95 regulating noise level exposure
- conforms to Title 41, Walsh-Healy Rules and Regulations P50-204.8, Safety and Health Standards
- contoured pistol-grip for safe, comfortable handling, even with greasy hands
- convenient hang-up hook
- ¼" female NPT inlet
- *Safety glasses or shield must be worn when using any blow gun.*



Pistol Grip Safety



Part #

PG700

Features:

- conforms to US Dept. of Labor, OSHA Standard 1910.242 (B) allowing a maximum of 30 PSI outlet pressure at the nozzle when dead-ended
- conforms to US Dept. of Labor, OSHA Standard 1910.95 regulating noise level exposure
- conforms to Title 41, Walsh-Healy Rules and Regulations P50-204.8 Safety and Health Standards
- slender 4" extended nozzle allows access to hard to reach places and holes as small as .200"
- variable output trigger enables user to control air flow
- hook design near trigger provides finger protection as well as easy storage
- lightweight to help minimize user fatigue.
- side holes allow air to escape if nozzle tip is dead-ended, thus preventing back pressure buildup
- pressure rating: **150 PSI**
- ¼" female NPT inlet
- safety glasses or shield must be worn when using any blow gun

Extended Nozzle Pistol Grip Safety



Part #

ENBG1

Features:

- lightweight and ergonomic
- pistol grip / hanging hook handle
- made from high quality aluminum casting
- requires high volume coupler and plug for optimum performance
- maximum pressure rating: **150PSI**
- available with conical tip (**HTBG-CT**)
- available with safety tip (**HTBG**)

Heavy Duty - High Volume



with quiet conical tip



with safety tip

Reelcraft®

Hose Reels

Hose reels are an economical solution for safely storing hose assemblies.

Material:

- all steel construction

Application uses:

- air and water hose storage

5000 Series



Features:

- reel inlet 3/8" NPTF
- all steel construction
- full shaft and swivel
- furnished standard with PVC hose
- maximum temperature is **150°F**
- Compressed air hose should not be converted to oxygen service; they are often contaminated with an oil coating, which can react explosively when oxygen is introduced.
- part# (**5•••LP**)



7000 Series



Features:

- all steel construction
- LP Low Pressure reels:
 - maximum temperature **150°F**
 - reel inlet 1/2" NPTF
 - PVC hose is standard
 - part# (**7800LP**)
- MP Medium Pressure reels:
 - maximum temperature **210°F**
 - reel inlet 1/2" NPTF
 - SAE 100 R1T 1-wire braid hose available
 - part# (**7800MP**)
- HP High Pressure reels:
 - maximum temperature **210°F**
 - reel inlet 1/4" NPTF
 - SAE 100 R2T 2-wire braid hose available
 - part# (**7600HP**)

80000 Series



Features:

- reel inlet 3/4" NPTF
- five-in-one heat treated aluminum casting incorporates main shaft, ratchet, spring arbor and inlet/outlet plumbing in one-piece casting
- furnished standard with PVC hose
- maximum temperature is **150°F with hose**
- maximum temperature is **210°F without hose**
- part# (**8••••LP**)

30000 Series



Features:

- reel frame, spool and drum are fabricated from heavy gauge steel
- all bolted construction - no welds
- manual driven standard
- motor drive available
- 1/2" inlet
- part# (**C3•112•**)

FRL's

Filters, Regulators, Lubricators

Featuring Wilkerson, Series 1, and Watts

Filters

Features:

- automatic or manual drain
- metal bowl or transparent with guard
- 5-40 micron elements available
- oil removal (coalescing) filters available



Watts



Series 1



Wilkerson

Regulators

Features:

- with or without gauge
- standard design or T-handle
- special designs - high pressure, water, high flow



Watts



Series 1



Wilkerson

Filters / Regulators

Features:

- in-line or modular installation
- piggy-back design for installation in tight area
- common inlet/outlet for both filter and regulator
- saves on piping costs



Watts



Series 1



Wilkerson

Lubricators

Features:

- transparent or metal bowl
- 1 oz. reservoir (minis) up to 2 gal. reservoir



Watts



Series 1



Wilkerson

Combination Units

Features:

- in-line or modular installation
- wall mounting brackets included
- NPT pipe adapters included



Watts



Series 1



Wilkerson

Dixon

Gauges

Featuring Ashcroft and Wika

Standard Dry Gauges



Features:

- ASME B40.1, Grade B (\pm 3-2-3% accuracy)
- PowerFlex™ movement with polyester segment, designed to resist the effects of shock, vibration and pulsation.
- ABS plastic case
- c-shaped bronze safety bourdon tube (600 PSI and lower)
- helical wound bronze safety bourdon tube (1000 PSI and higher)
- polycarbonate crystal
- black aluminum pointer
- temperature range: **-40°F to 150°F**
- available in center back mount:
 - 1½" face (**GC6****)
 - 2" face (**GC2****)
- available in lower mount:
 - 2" face (**GL1****)
 - 2½" face (**GL3****)
 - 3½" face (**GS***-4, GS****-4**)

FlutterGuard™ Dry Gauges



Features:

- FlutterGuard™ virtually eliminates pointer flutter, making the gauge easier to read and reducing excessive movement wear. Liquid-free casing results in lighter weight and eliminates the chance of gauge leakage.
- ASME B40.1, Grade B (\pm 3-2-3% accuracy)
- ABS plastic case
- C-shaped bronze safety bourdon tube (600 PSI gauges and lower)
- helical wound bronze safety bourdon tube (1000 PSI gauges and higher)
- polycarbonate crystal
- black aluminum pointer
- PowerFlex™ movement with polyester segment, designed to resist the effects of shock, vibration and pulsation.
- ambient temperature range of **-40°F to 150°F**
- available in lower mount 2½" face (**GL3**FG**)

All Stainless Steel Dry Gauges



Applications:

- Stainless steel gauges provide the corrosion resistance and durability of a permanently sealed gauge. Designed for severe service applications.

Features:

2½" face

- 2-1-2% accuracy
- 304 stainless steel case with stainless crimp ring
- polycarbonate window
- ¼" lower mount stainless connector
- 316 stainless bourdon tube and socket
- temperature range: **-40°F to 140°F**

3½" face

- 3-2-3% accuracy
- 316 series stainless solid back case
- polycarbonate window
- ¼" lower mount stainless connector
- 316 stainless bourdon tube and socket, polyester segment
- temperature range: **-40°F to 140°F**
- available in lower mount:
 - 2½" face (**GSS**, GSS***, GSS******)
 - 3½" face (**GSS***-4, GSS****-4, GSS*****-4**)

All Stainless Steel Liquid Filled Gauges

Applications:

- Stainless steel gauges provides the corrosion resistance and durability of a permanently sealed gauge. Designed for severe service applications.

Features:

- 2-1-2% accuracy
- 2½" 304 series stainless case with stainless crimp ring
- polycarbonate window
- ¼" lower mount stainless connector
- 304 stainless case with stainless crimp ring
- glycerin filled
- temperature range: **-4°F to 140°F**
- available in a 2½" face:
 - center back mount (**GLSSC•••**)
 - lower mount (**GLSS••, GLSS•••**)



Brass Liquid Filled Gauges

Features:

- 2-1-2% accuracy on 2½"; 1% accuracy on 4"
- acrylic window with membrane assembly
- copper alloy bourdon tube
- brass movement with highly polished bearing surfaces
- glycerin filled
- 2½" face gauges: solid cast brass case with polished brass slip-fit ring
- 4" face gauges: cast brass, silver painted case with chrome plated brass ring
- temperature range: **-4°F to 140°F**
- available in center back mount:
 - 2½" face (**GLBRC••, GLBRC•••**)
- available in lower mount:
 - 2½" face (**GLBR••, GLBR•••**)
 - 4" face (**GLBR••-4, GLBR•••-4, GLBR••••-4**)



Dixon

Ferrules & Equipment

Ferrules, and the easy to use application equipment, provide an economical solution for safely coupling "small bore" hose assemblies.

Ferrules



Features:

- for air or fluid service
- for use with medium or lightweight hose
- available in brass:
(**BF***, BFM***, BFM***B, BFL***, BFW***, BFMW*****)
- available in stainless steel:
(**SFL***, SFM***, SFW*****)

Crimping Equipment



Features:

- Hose crimper provides "big tool" crimping advantages at a fraction of the cost.
- rugged, portable and easy to use
- part# (**855, 855A**)
- larger model available: (**860**)
- replacement dies available



Features:

- crimps all brass ferrules shown on previous page
- does not include dies
- Dies for ferrule machines are available in standard sets for all ferrules as tabulated (4 segments to a set), supplied with plain or ribbed crimping surface.
- height: 27" with handle upright
- base: 8" x 3"
- body: 7³/₈"
- weight: 25 lbs.
- part# (**5111A**)



Features:

- provides efficient mass production assembly of hose, ferrules, and fittings
- The foot pedal permits the use of both hands, reduces fatigue and speeds production.
- complete with air cylinder, ferrule machine (less dies), fitted hose lengths and necessary control valves
- ready for work bench installation
- weight: 91 lbs.
- part# (**1765A**)

Dixon

Tubing & Cutters

Dixon offers economically priced air/water tubing, and the tools to cut it properly.

Tubing

Applications:

- Clear PVC Tubing is designed to be used with standard shank fittings in low pressure liquid and pneumatic applications.
- Clear PVC Braided Tubing is designed to be used in low pressure liquid and pneumatic applications.

Features:

- domestic clear PVC for non-critical hospital use such as suction and draining, produced from FDA materials, but not FDA approved
- domestic clear PVC braided is high grade tensile strength polyester yarn reinforcement
- imported clear PVC braided for various machine tools and the transportation of chemicals
- non-braided PVC tubing (**CL****, ICL******)
- braided PVC tubing (**BR****, IBR******)
- Polyurethane (***)
- Polyethylene (***)
- Nylon 11 (***)



PVC

Cutters

Features:

- used for PVC tubing and hose
- replacements blades available
- different styles and sizes available
- up to 3/4" (**TC97**)
- up to 1" (**HC90**)
- up to 2"; P.E. up to 1 1/2"; PVC up to 1 1/4" (**LHC95**)



HC90

TC97

LHC95

Features:

- used for copper tubing
- different styles and sizes available
- hi-duty (**TC-1000**) for 1/8" to 1-1/8" OD
- ratcheting (**TC-1050RH**) for 1/8" to 5/8" OD
- general (**174-F**) for 3/8" to 1-1/8" OD



174-F

TC-1000

TC-1050RH

Dixon

Compression & Push-In Fittings

Offer a dependable solution for your tubing connection needs.

Compression Fittings



Advantages:

- No flaring, soldering or other preparation of tubing necessary to assemble.

Specifications:

- Listed with Underwriter's Laboratories for flammable liquid. *Compression fittings meet functional requirements of SAE J-512 and ASA.*

Materials:

- brass (fittings), Delrin® (sleeves)

Applications:

- Use with copper, aluminum and Parflex thermoplastic tubing.
- Manufactured for low and medium pressure tubing connection work where excessive vibration or tube movement is not involved.
- *Not recommended for steel tubing.*
- *Not recommended for application using gaseous media.*

Configurations:

- sleeves
- nuts
- unions
- tees
- elbows
- connectors
- straight through
- plugs

Push-In Fittings



Service:

- working temperature and pressure varies between applications and type of fitting

Materials:

- brass
- stainless steel
- nickel-plated brass
- nylon/nickel-plated brass

Applications:

- suitable for many industries such as: chemical, food, packaging and medical

Configurations:

- unions
- tees
- elbows
- connectors

Dixon

Air Hoses

Offer a reliable solution for your air supply needs.

Service:

- working pressure at 70°F: **210 PSI**
- temperature range: **-40°F to 155°F**

Materials:

- nylon-reinforced polyurethane

Features:

- lighter in weight than ordinary rubber hose
- A sturdy, nylon-reinforced braid between the inner and outer tube allows for a higher working pressure.
- durometer: Shore A85

Advantages:

- durable
- lightweight
- excellent flexibility
- oil resistant

Polyurethane Air Hose



Coil-Chief Self-Storing Air Hose

Service:

- working pressure at 70°F: **200 PSI**

Materials:

- yellow nylon
- brass swivel on one end with spring guard
- brass rigid fittings on one end with spring guard
- repair kits available



Polyurethane Self-Storing Air Hose

Service:

- working pressure at 70°F: **125 PSI**

Materials:

- blue polyurethane
- swivels on both ends

Advantages:

- extremely flexible - resists kinking
- impervious to abrasions, heat and oil
- superior elasticity and coil memory
- repair kits available



Dixon

Mini In-Line FRL's

Lubricators

Service:

- maximum operating conditions: **200 PSIG** and **175°F**
- flow rating is 22 SCFM at 100 PSIG

Advantages:

- can be refilled under line pressure
- oil capacity is ¼ fluid ounce

Filters

Service:

- maximum operating conditions: **200 PSIG** and **175°F**
- flow rating is 17 SCFM inlet pressure at 100 PSIG

Advantages:

- either port may be used as an inlet port
- filter element rated at 5 microns

Applications:

- Designed specifically for the protection of small air tools, such as impact wrenches, nut runners, grinders and screwdrivers. The all-anodized, lightweight aluminum housing is compact can be used directly before the air tool.

Service:

- maximum operating pressure: **500 PSI**
- operating temperatures: **35°F** to **200°F**
- air flow is 140 SCFM

Advantages:

- standard element is 40 micron, which ensures minimum pressure drop
- elements can be replaced quickly

Regulators

Applications:

- Relieving piston design allows reduction of downstream pressure when the system is dead-ended.

Service:

- 5 to 125 PSIG outlet pressure adjustment range
- reliable pressure regulation at air flows up to 13 SCFM

Advantages:

- compact design and lightweight construction
- wrench flats for easy installation

Dixon

Pinch-On Clamps

Pinch-on Clamps offer an easy, efficient, and safe manner to secure hose ends in "small bore" assemblies.

Clamps

Single Ear:

- fast, simple, and secure installation
- lightweight
- zinc-plated steel (•••)
- 304 stainless steel (•••R)

Double Ear:

- increased diameter range over the single ear design
- fast, simple, and secure installation
- zinc-plated steel (••••)
- 304 stainless steel (••••R)

Stepless® Ear:

- fast, simple, and secure installation
- lightweight
- for low durometer and thin-walled hose
- provides a 360° seal
- 304 stainless steel (••••)



single ear



double ear



stepless ear

Kits

Service Kit:

contains:

- 9 sizes of clamps
- 1 standard jaw pincer
- part# (**SK1098**)

Construction Kit:

contains:

- 2 sizes of clamps
- 1 size of menders
- 1 long handle pincher
- part# (**18500116**)



construction kit

Tools

Features:

- straight jaw - long handle (**9901**)
- standard (**1098**)
- heavy duty - with side jaws (**1099**)



standard

Dixon

Ball Valves

Ball Valves are installed in-line to control the flow of liquids or gases from one point to another.

Domestic Brass Ball Valves



Application:

- for control of air, water, oil and gas in hose or pipe lines. For other services, please contact Dixon

Features:

- pressure rating: **600 PSI** WOG; **150 PSI** saturated steam
- brass valve bodies, balls and stems
- blow-out proof stems
- glass-filled reinforced PTFE seats and stuffing box ring; stem seals and washers
- plated steel handles and nuts with vinyl sleeves replacements available, consult Dixon for pricing
- full and standard port valves are repairable
- meets WW-V 35C, Type II Composition
- ¼" - ½" available in full port design (**BBV..**)
- ¾" - 2" available in standard port design (**BBV...**)

Locking Handle Brass Ball Valves



Application:

- for control of air, water, oil and gas in hose or pipe lines

Features:

- for other services, please contact Dixon
- pressure rating: **600 PSI** WOG; **150 PSI** saturated steam
- blow-out proof RPTFE stem
- chrome-plated brass ball
- Stainless steel sliding lock mechanism secures handle in open or closed position; can be padlocked opened or closed.
- plated steel handles and nuts with vinyl sleeves
- full and standard port valves are repairable
- ¼" - ½" available in full port design (**BBLV..**)
- ¾" - 2" available in standard port design (**BBLV...**)

Imported Brass Ball Valves



Applications:

- for control of air, water, oil and gas in hose or pipe lines, for other services, please contact Dixon

Features:

- pressure rating: **600 PSI** WOG; **150 PSI** Working Steam Pressure
- forged brass body
- blow-out proof stems
- PTFE seat, seal and thrust washer
- chrome-plated brass ball and plated steel handle
- maximum temperature: **366°F**
- Underwriters Listed
- NSF61 approved
- ¼" - 2" Underwriters, Factory Mutual, American Gas Association and Canadian Gas Association approved.
- 2½" - 4" Underwriters, and Canadian Gas Association approved.
- ¼" - 4" available in full port design (**FBV.., FBV...**)

Global Brass Ball Valves

Applications:

- for water and air only



Features:

- pressure ratings:
 - 1/4" - 3/8" rated to **365 PSI**
 - 1/2" - 2" rated to **600 PSI**
- forged brass body
- maximum temperature: **248°F** (120°C)
- 1/2" - 2" available in full port design (*FBVG.., FBVG...*)



Full port design



Applications:

- for control of air, water, oil and gas in hose or pipe lines, for other services, please contact Dixon

Features:

- pressure rating: **600 PSI** WOG; **150 PSI** Working Steam Pressure
- forged brass body
- blow-out proof stems
- PTFE seat, seal and thrust washer
- chrome-plated brass ball and plated steel handle
- maximum temperature: **366°F**
- Underwriters Listed
- NSF61 approved
- 1/2" - 2" available in full port design (*FBV.., FBV...*)



Imported Brass Ball Valves

Features:

- pressure rating: **450 PSI**
- nickel plated brass body
- PTFE seats and Buna-N stem seal
- blow-out proof stem
- maximum temperature **330°F**
- American Gas Association and Canadian Gas Association approved
- 1/8" & 1/2" available in standard port design (*MBV..*)
- 1/4" & 3/8" available in full port design (*MBV..*)

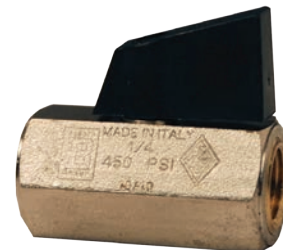

Mini Ball Valves

Applications:

- for air service only
- vent downstream air in accordance with OSHA regulation 1910.147 for pneumatic systems

Features:

- pressure rating: **600 PSI**
- brass valve
- chromium plated ball
- RTFE seats and stuffing box ring
- blow-out proof stem design
- adjustable packing gland
- 1/4" - 1/2" available in full port design (*BBV..LV*)
- 3/4" - 2" available in standard port design (*BBV...LV*)

sliding lock mechanism

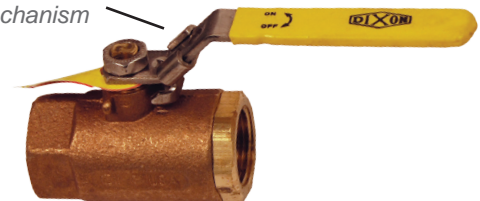

Safety Vented Ball Valves

Bronze "Deadman" Spring Return Handle Ball Valves



Features:

- pressure rating: **600 PSI** WOG; **150 PSI** saturated steam
- vacuum service to 29 inches Hg
- stainless steel lever
- chromium plated ball
- RTFE seats and stuffing box ring
- blow-out proof stem design
- adjustable packing gland
- spring return closes valve when not held open
- operating torque approximately three times standard valve torque
- ½" available in full port design (**BBV50SR**)
- ¾" - 2" available in standard port design (**BBV...SR**)

Bronze Ball Valves with NPT Tap for Drain



Application:

- recommended for water and air service

Features:

- pressure rating: **125 PSI** WOG
- vent downstream air in accordance with OSHA regulations for pneumatic systems
- chromium plated ball
- RTFE seats and stuffing box ring
- blow-out proof stem
- adjustable packing gland
- auto-drain / auto-vent
- ¼" NPT tapped port provides additional options such as an air venting elbow or noise muffler
- ¼" - 1" available in full port design (**BBV...VT**)

Domestic Full Port Ball Valves



Features:

- machined solid chrome-plated ball
- multi-fill PTFE seats and seals
- adjustable packing
- blow-out proof stem design
- bronze castings
- vacuum service to 29 inches Hg
- pressure rating: **600 PSI** WOG; **150 PSI** saturated steam
- ¼" - 2" available in full port design (**BBV...FP**, **BBV...FP**)

3-Way Diverting Ball Valves



Features:

- pressure rating: **400 PSI** WOG; **100 PSI** saturated steam
- brass body
- blow-out proof stem
- chrome plated brass ball
- PTFE seats, seals, and thrust washer
- adjustable stem packing
- maximum temperature: **344°F**
- ½" - 2" available in standard port design (**BBV...DTW**)

3-Way Diversion Ball Valves

Brass Valves

Features:

- can be used with gasoline and diesel fuel
- pressure rating: **400 PSI** WOG
- bronze body
- blow-out proof stem
- chromium-plated ball
- RPTFE seats and stuffing box ring
- stainless steel handle and nut with vinyl sleeve
- adjustable packing gland
- ½" available in full port design (**BBV50TW**)
- ¾" - 1" available in standard port design (**BBV..TW**)

Stainless Steel Valves

Features:

- rated to **800 PSI** WOG
- stainless steel body and ball
- blow-out proof stem
- RPTFE seats and stuffing box ring
- stainless steel handle and nut with vinyl sleeve
- adjustable packing gland
- meets NACE MR-01-75
- ½" available in full port design (**SSV50TW**)
- ¾" - 1" available in standard port design (**SSV..TW**)



Carbon Steel Ball Valves

Application:

- for control of air, water, oil and gas in hose or pipe lines, for other services, please contact Dixon

Features:

- pressure rating: **150 PSI** saturated steam
 ¼" - 1" rated to **2000 PSI**
 1¼" - 2" rated to **1500 PSI**
- carbon steel body
- chromium plated ball
- RPTFE seat and seal
- blow-out proof stem
- adjustable packing gland
- 1/4" - 3/8" available in full port design (**IBV..**)
- 1/2" - 2" available in standard port design (**IBV...**)



250 Lb. Steam Ball Valves

Application:

- recommended for use with fluids with widely varying temperatures and/or thermal expansion rates

Features:

- pressure rating: **600 PSI; 250 PSI** saturated steam
- vacuum service to 29 inches Hg
- bronze body
- 316 stainless steel ball and stem
- blow-out proof stem design
- multi-fill RPTFE seats
- multi-fill stuffing box ring
- high temperature MTFE stem packing
- adjustable packing gland
- maximum temperature: **406°F**
- ½" available in full port design (**BBV50ST**)
- ¾" - 2" available in standard port design (**BBV..ST**)



High Pressure Full-Bore Hydraulic Ball Valves



Features:

- blow-out proof stem
- rugged construction
- Viton® seals
- Delrin® seats
 - ¼" - 2" available, (*HPBV...*)
- stainless steel:
 - ¼" - 1" available, (*HPBV...SS*)

Dual Y Valves



Application:

- dual action valve, ideal for compressor applications

Features:

- non-vented pressure rating: **600 PSI** WOG
- vented pressure rating: **125 PSI** Cold Working Pressure
- non-vented (*BBV...DW*) and vented (*BBV...DWV*)

Pneumatically Actuated Valves



3 piece stainless

3 way L-port

Features:

- 3-piece and 2-piece designs
- 3-way L and T ports available
- available in brass and stainless steel
- dual-acting and spring return designs
- female NPT

Electrically Actuated Ball Valves



brass

Features:

- stainless steel available with 3-piece ball valve design (*BV2IG-.....EA*)
- brass available with 2-piece ball valve design (*BV2BV-.....EA*)
- 115VAC actuator
- full port design
- female NPT

Stainless Steel Ball Valves

Full port design

Application:

- for use with water, oil and gas

Features:

- pressure rating: ¼" - 2" rated to **1000 PSI** WOG (CWP)
2½" - 3" rated to **800 PSI** WOG (CWP)
100 PSI saturated steam
- 316 stainless steel body, ball and stem
- PTFE seat, joint gasket and thrust washer
- plastic cover on handle
- blow-out proof stem design
- temperature range: **-20°F** to **450°F**
- ¼" - 3" available in full port design (**SSBV..**, **SSBV...**)



Reduced port design

Features:

- for use in water, oil and gas
- ¼" - 1" rated to **2000 PSI** (CWP);
1¼" - 2" rated to **1500 PSI** (CWP)
- body conforms to ASTM A-351 Grade CF8M
- ball is 316 stainless steel
- PTFE, glass filled seat
- blow-out proof stem design
- ¼" - 2" available in reduced port design
(**SSBV..RP**, **SSBV...RP**)



Locking Handle Stainless Steel Ball Valves

Full port design

Application:

- for use with water, oil and gas

Features:

- pressure rating: ¼" - 2" rated to **1000 PSI** WOG (CWP)
2½" - 3" rated to **800 PSI** WOG (CWP)
100 PSI saturated steam
- 316 stainless steel body, ball and stem
- PTFE seat, joint gasket and thrust washer
- plastic cover on handle
- blow-out proof stem design
- temperature range: **-20°F** to **450°F**
- lockable
- ¼" - 2" available in full port design (**SSLBV..**, **SSLBV...**)



Reduced port design

Application:

- for use with water, oil and gas

Features:

- pressure rating: **800 PSI** WOG; **100 PSI** saturated steam
- 316 stainless steel body, ball and stem
- PTFE seat, joint gasket and thrust washer
- plastic cover on handle
- blow-out proof stem design
- temperature range: **-20°F** to **450°F**
- lockable
- ¼" - 2" available in reduced port design
(**SSLBV..SP**, **SSLBV...SP**)

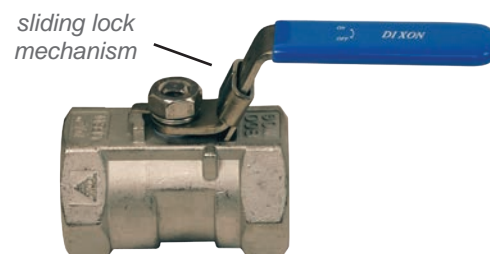

Safety

Safety Check Valve

Prevents dangerous hose whip on portable air compressors

Features:

- also known as Air Fuse
- high flow
- controls excess air flow (scfm) in only one direction however, permits flow in either direction
- Not for use in applications where 100% of the available air is required, i.e. sand blast, pile driving rigs, expansion joint blow down pipes, etc.
- maximum working pressure: **250 PSI**
- maximum temperature: **250°F**
- functions efficiently at high discharge temperatures
- automatically senses change in air flow and shuts off the flow in the event of a surge in excess of valve flow rating thus preventing hose whip
- automatically resets after hose repair is made
- Conforms to OSHA regulation 1926.302 (b) (7) requiring a safety device at the source of the air supply and at branch air lines.
- applications include temporary plant/factory air, construction sites, shipyards or utilities
- solid brass with stainless steel springs

Use:

- Safety Check Valves operate by using the pressure differential across the valve to operate the valve and spring assembly. The pressure differential is directly related to the flow of air through the valve.
- When the pressure differential is within the operating limits -- below the cutoff flow -- of the unit, the force on the valve exerted by the spring is greater than that caused by the pressure differential (see open position graphic below). The valve remains open and normal operation continues.
- When the pressure differential is above the cutoff limit, the force on the valve exerted by the pressure differential is greater than the force exerted by the spring, and the valve closes (see the closed position graphic below).
- After the repair is made, normal operation is automatically enabled when pressure across the valve equalizes through the bleeder hole.
- The valve spring size can be specified by determining the air flow during normal operation and by estimating the air flow if a failure or rupture occurs.

Questions to ask when selecting a safety shut-off valve:

1. What is the hose I.D. size you are using?
2. What is the operating pressure of the compressor, in PSI?
3. What is the SCFM of your compressor? (printed on the side of most air compressors)
4. How much air flow, in SCFM, does the tool(s) require?
5. What is the maximum air flow possible, in SCFM, through your air hose, at the end of the length of the hose? Contact Dixon for recommendations if the hose length is over 100'.

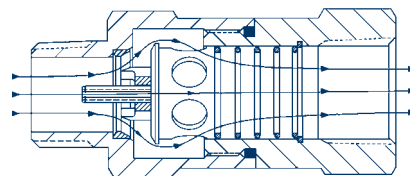

Check Valve In Open Position

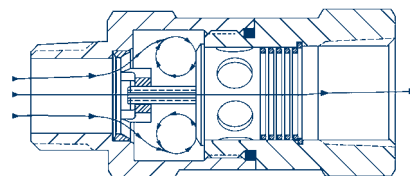

Check Valve In Closed Position

King Safety Cable

A positive safeguard for air hose connections, King Safety Cable helps you meet today's safety standards

Features:

- hose-to-hose or hose-to-rigid outlet styles available
- low cost answer to eliminating injuries caused by broken air hose connections
- highly resistant to rust and corrosion
- easy installation and removal - no tools needed
- custom lengths available

When a pressurized air hose becomes accidentally uncoupled, or a hose failure occurs, the quick exhaust of air causes the hose assembly to whip violently, creating a potentially dangerous situation.

King Safety Cables prevent hose whip in the event of the accidental separation of a coupling or clamp device. The steel cables span the hose fittings to provide standby safety for the hose. Spring-loaded loops in the cable ends are easily opened to pass over the couplings and provide a firm grip on the hose.

The cables can be used in hose to hose installations, as well as hose to rigid outlet, or tool.

On hose to hose applications the **King Safety Cable** should be installed on the hose portion of the assembly in a fully extended position. When used on hose to rigid outlet, or tool, the spring loaded end should be over the hose, while the choker end is installed on the outlet, or tool. **King Safety Cable** should always be installed in a fully extended position.

Features:

- hose-to-hose or hose-to-rigid outlet
- King Cable is the low cost answer to eliminate injuries caused by broken air hose connections.
- highly resistant to rust and corrosion
- no tools needed - Easy to install and remove



Style WSR, for hose-to-tool service



Style W, for hose-to-hose service



Style WSR1E, with stainless steel marine eye



Style WB1C, with safety clip and lanyard

Accessories

Air Accessories

Additional Air Related Products

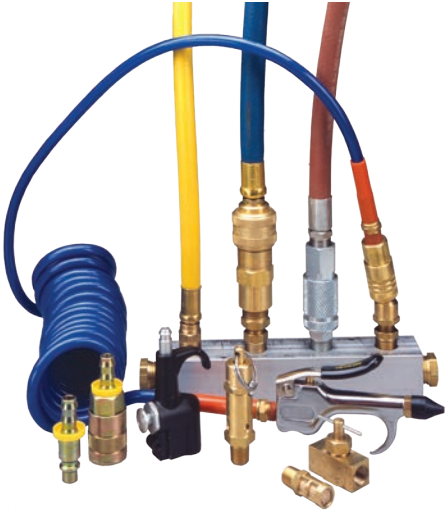

Mufflers

Features:

- effectively reduces noise levels
- section F in the DPL (Dixon Price List)



Safety Pop-Off Valves

Features:

- National Board Certified Safety Valves
- section F in the DPL (Dixon Price List)

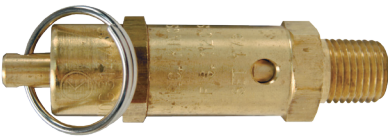

Tire Inflator Gauges

Features:

- available with tapered or straight chuck
- section F in the DPL (Dixon Price List)

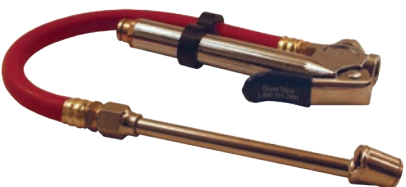

Ball Swivels

Features:

- provides increased flexibility
- section F in the DPL (Dixon Price List)

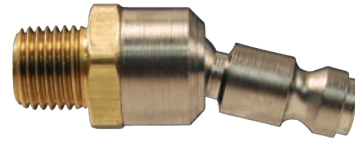

Manifolds

Features:

- distributes air supply to other lines
- section F in the DPL (Dixon Price List)



Flow Control Valves

Features:

- provides precision flow control
- section F in the DPL (Dixon Price List)



Flow Indicators

Features:

- verifies flow and monitors color and clarity in fluid lines
- section R in the DPL (Dixon Price List)



S.T.A.M.P.E.D.

Questions to Ask

- S** Size
- T** Temperature
- A** Application
- M** Media
- P** Pressure
- E** Ends
- D** Dixon

Pressure Conversions

100 PSI = 6.9 Bars	5 Bars = 72.5 PSI
250 PSI = 17.25 Bars	10 Bars = 145 PSI
600 PSI = 41.4 Bars	25 Bars = 362.5 PSI

Measurement Information

Measures of Pressure

1 Pound Per Square Inch = 144 Pounds Per Square Foot = 0.068 Atmosphere = 2.042 Inches of Mercury at 62°F = 27.7 Inches of Water at 62°F = 2.31 Feet of Water at 62°F.

1 Atmosphere = 30 Inches of Mercury at 62°F = 14.7 Pounds Per Square Inch = 2116.3 Pounds Per Square Foot = 33.95 Feet of Water at 62°F.

1 Foot of Water at 62°F = 62.355 Pounds Per Square Foot = 0.433 Pounds Per Square Inch.

1 Inch of Mercury at 62°F = 1.132 Feet of Water = 13.58 Inches of Water = 0.491 Pounds Per Square Inch.

Column of Water 12 Inches High, 1 Inch in Diameter = .341 Pounds

Length Conversion Constants

Millimeters x .039370 = Inches	Inches x 25.4001 = Millimeters
Meters x 39.370 = Inches	Inches x .0254 = Meters
Meters x 3.2808 = Feet	Feet x .30480 = Meters
Meters x 1.09361 = Yards	Yards x .91440 = Meters
Kilometers x 3,280.8 = Feet	Feet x .0003048 = Kilometers
Kilometers x .62137 = Statute Mile	Statute Miles x 1.60935 = Kilometers
Kilometers x .53959 = Nautical Miles	Nautical Miles x 1.85325 = Kilometers

Weight Conversion Constants

Grams x .03527 = Ounces (Avd.)	Ounces (Avd.) x 28.35 = Grams
Grams x .033818 = Fluid Ounces (Water)	Fluid Ounces (Water) x 29.57 = Grams
Kilograms x 35.27 = Ounces (Avd.)	Ounces (Avd.) x .02835 = Kilograms
Kilograms x 2.20462 = Pounds (Avd.)	Pounds (Avd.) x .45359 = Kilograms

Force Chart Force (In Pounds)

Hose I.D.	25 PSI	50 PSI	75 PSI	100 PSI	150 PSI	200 PSI	250 PSI	300 PSI	500 PSI	1000 PSI
1/4"	1	2	4	5	7	10	12	15	25	49
3/8"	3	6	8	11	17	22	28	33	55	110
1/2"	5	10	15	20	29	39	49	59	98	196
3/4"	11	22	33	44	66	88	110	133	221	442
1"	20	39	59	79	118	157	196	236	393	785
1-1/4"	31	61	92	123	184	245	307	368	614	1227
1-1/2"	44	88	133	177	265	353	442	530	884	1767
2"	79	157	236	314	471	628	785	942	1571	3142
2-1/2"	123	245	368	491	736	982	1227	1473	2454	4909
3"	177	353	530	707	1060	1414	1767	2121	3534	7069
4"	314	628	942	1257	1885	2513	3142	3770	6283	12566
5"	491	982	1473	1964	2945	3927	4909	5891	9818	19635
6"	707	1414	2121	2827	4241	5655	7069	8482	14137	28274
8"	1257	2513	3770	5027	7540	10053	12566	15080	25133	50266
10"	1964	3927	5891	7854	11781	15708	19635	23562	39270	78540
12"	2827	5655	8482	11310	16965	22620	28274	33929	56549	113098

Note: For hose I.D.'s from 1-1/4" to 12" the force in pounds is greater than the PSI.

- Force is the dynamic power which is exported longitudinally through a hose, towards the ends. To arrive at the number of pounds of force exerted, you merely multiply the area of the I.D. times the working pressure being used.
- Area of a circle: πr^2 (PI [3.1416] times radius squared)
- Force = Area x Pressure

Suggested Pipe Size for Compressed Air Flow at 100 PSI Length of Run, Feet

SCFM Air Flow	25	50	75	100	150	200	300	500	1000	Compressor HP
4	½	½	½	½	½	½	½	¾	¾	1
12	½	½	½	¾	¾	½	¾	1	1	3
20	¾	¾	¾	¾	1	¾	1	1¼	1¼	5
30	¾	¾	1	1	1	1	1¼	1¼	1¼	7½
40	¾	1	1	1	1¼	1	1¼	1½	1½	10
60	1	1	1¼	1¼	1¼	1¼	1½	1½	2	15
80	1	1¼	1¼	1¼	1½	1¼	1½	2	2	20
100	1¼	1¼	1½	1½	1½	1½	2	2	2½	25
120	1¼	1½	1½	1½	2	1½	2	2½	2½	30
160	1¼	1½	1½	2	2	1½	2½	2½	3	40
200	1½	2	2	2	2	2	2½	3	3	50
240	1½	2	2	2	2½	2	2½	3	3	60
300	2	2	2	2½	2½	2	3	3	3½	75
400	2	2½	2½	2½	3	2½	3	3½	4	100
500	2	2½	2½	3	3	2½	3½	3½	4	125

On a compressed air distribution system, pressure losses greater than 3% are considered excessive, and a well-designed system having a steady rate of air flow is usually designed for not more than a 1% loss or 1 PSI for a 100 PSI system. The pipe size depends not only on the volume of air flow but how far it must be carried. To hold the distribution loss to 1 PSI, pipes of larger diameter must be used on longer runs to carry the same flow that can be handled by smaller pipes on shorter runs.

Figures in the body of the chart above are pipe sizes recommended on a 100 PSI system to carry air with less than 1 PSI loss. When measuring lengths of runs, add 5 feet of length for each pipe fitting. If carrying 120 PSI pressure these sizes will carry slightly *more* air than shown, or pressure loss will be slightly less than 1 PSI. If carrying 80 PSI pressure these pipes will carry slightly *less* air at 1 PSI pressure loss than shown in the chart.

The left column of the chart shows the volume of air to be carried. It is difficult to estimate the air flow volume to be carried in each leg of the distribution system. This varies with the application. On some applications, like in a large plant with many legs in the distribution system serving dozens of air-operated machines, the air usage may be at a fairly steady rate. Other applications, usually on small systems, may have to carry a high surge of air if several machines happen to be operated at the same time. Then there may be a period with almost no flow.

To make a realistic estimate of air flow volume, the far right column of the chart showing compressor HP may be used. On steady pumping, a compressor will produce a minimum of 4 SCFM air flow for each 1 HP of capacity. This is a conservative figure, as most compressors will produce 5 or 6 SCFM.

For example, a 25 HP compressor will produce at least 100 SCFM of air. This is shown in the far left column on the same line as 25 HP.

excerpted from *Industrial Fluid Power*, Volume 1, third edition, 1984

Air Hose Friction

Hose Size (inches)	CFM thru 50' Hose	Gauge Pressure - Pounds/sq inch			
		50	70	90	110
PSI Loss Over 50' Hose Length					
1/2"	20	1.8	1.0	.8	.6
	30	5.0	3.4	2.4	2.0
	40	10.1	7.0	5.4	4.3
	50	18.1	12.4	9.5	7.6
	60	+	20.0	14.8	12.0
	70	+	28.4	22.0	17.6
	80	+	+	30.5	24.6
	90	+	+	41.0	33.3
	10	+	+	+	44.5
	110	+	+	+	+
3/4"	20	.04	.2	.2	.1
	30	.08	.5	.4	.3
	40	1.5	.9	.7	.5
	50	2.4	1.5	1.1	.9
	60	3.5	2.3	1.6	1.3
	70	4.4	3.2	2.3	1.8
	80	6.5	4.2	3.1	2.4
	90	8.5	5.5	4.0	3.1
	100	11.4	7.0	5.0	3.9
	110	14.2	8.8	6.2	4.9
	120	+	11.0	7.5	5.9
	130	+	+	9.0	7.1
	1"	20	.1	0	0
30		.2	.1	.1	.1
40		.3	.2	.2	.2
50		.5	.4	.3	.2
60		.8	.5	.4	.3
70		1.1	.7	.6	.4
80		1.5	1.0	.7	.6
90		2.0	1.3	.9	.7
100		2.6	1.6	1.2	.9
110		3.5	2.0	1.4	1.1
120		4.8	2.5	1.7	1.3
130		7.0	3.1	2.0	1.5

PSI = pressure in pounds/square inch
 CFM = air flow in cubic feet/minute

+ pressure loss is too great and therefore the combination of Hose Size, CFM, and Gauge Pressure is not recommended. Gauge Pressures the indicated air pressure in pounds/square inch, at the source (ie the air compressor receiver tank)

Maximum Recommended Air Flow (SCFM) Through ANSI Standard Weight Schedule 40 Pipe

The flow values in the table below are based on a pressure drop of 10% of the applied pressure per 100 feet of pipe for 1/8", 1/4", 3/8", and 1/2" pipe sizes; and a pressure drop of 5% of the applied pressure per 100 feet of pipe for 3/4", 1", 1-1/4", 2", 2-1/2", 3" pipe sizes. The table gives recommended flows for pipe sizes at listed pressures and should be used to determine appropriate piping for air systems.

Applied Pressure PSI	Nominal Standard Pipe Size										
	1/8"	1/4"	3/8"	1/2"	3/4"	1"	1-1/4"	1-1/2"	2"	2-1/2"	3"
5	0.5	1.2	2.7	4.9	6.6	13	27	40	80	135	240
10	0.8	1.7	3.9	7.7	11.0	21	44	64	125	200	370
20	1.3	3.0	6.6	13.0	18.5	35	75	110	215	350	600
40	2.5	5.5	12.0	23.0	34.0	62	135	200	385	640	1100
60	3.5	8.0	18.0	34.0	50.0	93	195	290	560	900	1600
80	4.7	10.5	23.0	44.0	65.0	120	255	380	720	1200	2100
100	5.8	13.0	29.0	54.0	80.0	150	315	470	900	1450	2600
150	8.6	20.0	41.0	80.0	115.0	220	460	680	1350	2200	3900
200	11.5	26.0	58.0	108.0	155.0	290	620	910	1750	2800	5000
250	14.5	33.0	73.0	135.0	200.0	370	770	1150	2200	3500	6100

Water Discharge Table

This table is intended for general reference and general applicability only, and should not be relied upon as the sole or precise source of information available with respect to the subject covered. The user should also refer to and follow manufacturer's specific instructions and recommendations with regard to such information, where they exist.

Flow of water through 100 foot lengths of hose, Straight-Smooth Bore - U.S. Gallons per minute

PSI at Hose Inlet	Nominal Hose I.D. Diameters - Inches							
	1"	1-1/4"	1-1/2"	2"	2-1/2"	3"	4"	6"
20	26	47	76	161	290	468	997	2895
30	32	58	94	200	360	582	1240	3603
40	38	68	110	234	421	680	1449	4209
50	43	77	124	264	475	767	1635	4748
60	47	85	137	291	524	846	1804	5239
75	53	95	154	329	591	955	2035	5910
100	62	112	180	384	690	1115	2377	6904
125	70	126	203	433	779	1258	2681	7788
150	77	139	224	478	859	1388	2958	8593
200	90	162	262	558	1004	1621	3455	10038

Figures are to be used as a guide since the hose inside diameter tolerance, the type of fittings used, and orifice restriction all influence the actual discharge. Thus, variations plus or minus from the table may be obtained in actual service.

Conversion Table - Feet of Water to Inches of Mercury

Feet of Water	1	2	4	6	8	10	12	14	16	20	22	24	26	28	30	32	34
Inches of Mercury	0.9	1.8	3.5	5.3	7.1	8.8	10.6	12.4	14.1	17.7	19.4	21.2	23.0	24.8	26.5	28.3	30.0

- Listed below is a brief overview of several procedures relating to couplings mentioned in this brochure.
- Proper selection and installation of couplings is critical.
- Each procedure can be viewed in full on the web at www.dixonvalve.com.
- Dixon will supply a complete copy of the Procedures Manual upon request.

Procedure 1002

Brass Reusable Fitting Selection

- male and female fittings
- hose splicers

Procedure 1003

King Safety Cable Selection

1. determine cable style
2. determine hose ID
3. determine assembly working PSI
4. reference the current DPL for available cables

Procedure 1100

General Preparation Instructions

1. cut the hose
2. square the ends
3. clean the ends
4. determine number of clamps
5. mark hose for clamp placement
6. static grounding
7. helical wire
8. seal the hose ends
9. coupling lubricant

Procedure 1103

Crimping Machine Set-up

- 5111A
- 1765A

Procedure 2203

Pinch-On Clamp Installation

- single ear clamps
- double ear clamps

Procedure 2300

King Safety Cable Installation

- hose to tool
- hose to fixed connector
- hose to hose

Procedure 2304

Brass Stem and Ferrule Installation

- using the 5111A crimping machine
- using the 1765A crimping machine

Procedure 2305

Brass Reusable Fitting Installation

- male and female fittings
- hose splicers

Procedure 3005

General Assembly Inspection

- couplings
- hoses

Dixon, founded in 1916, is a premier manufacturer and supplier of hose couplings, valves, dry-disconnects, swivels, and other fluid transfer and control products. The company's global reach includes a wide range of products for numerous industries including petroleum exploration, refining, transportation, chemical processing, food & beverage, steel, fire protection, construction, mining and manufacturing. Dixon's strategic objective is to create solutions that make products safer, leak-free, longer lasting, and always available.

dixonvalve.com • *Customer Service:* 877.963.4966



The Right Connection®

Dixon Valve

800 High Street, Chestertown, MD 21620

ph: 877.963.4966

fx: 800.283.4966



Dixon Customer Service



Facebook Page



YouTube Videos